

6054 Back C - Forestman Camp

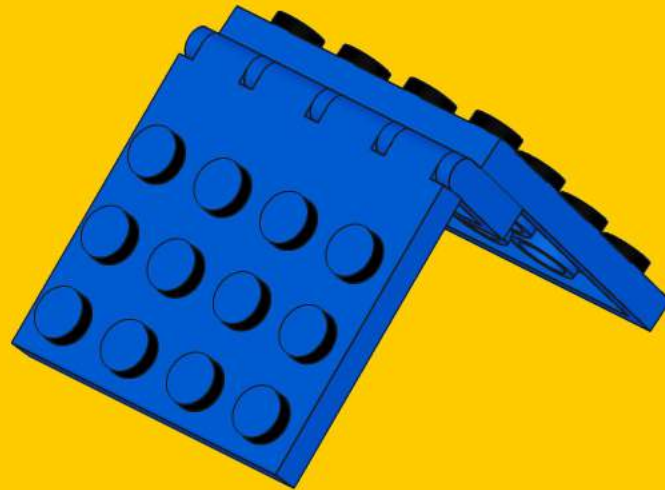

1

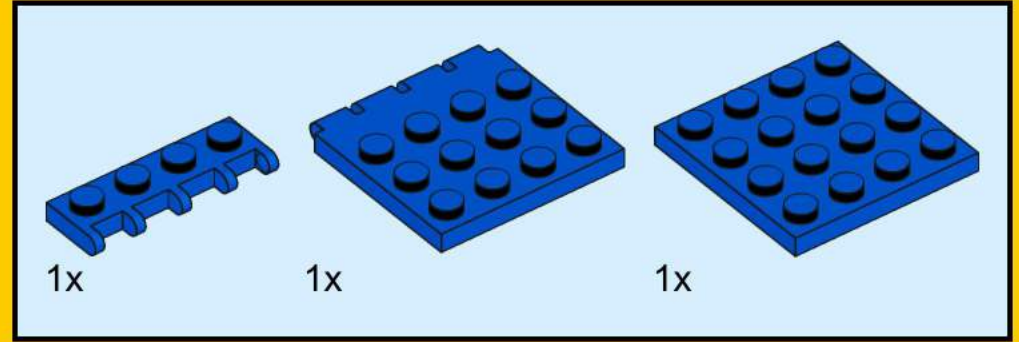
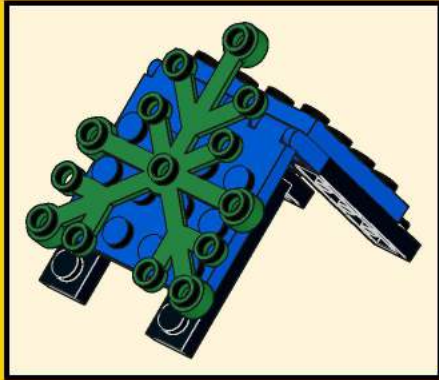

2

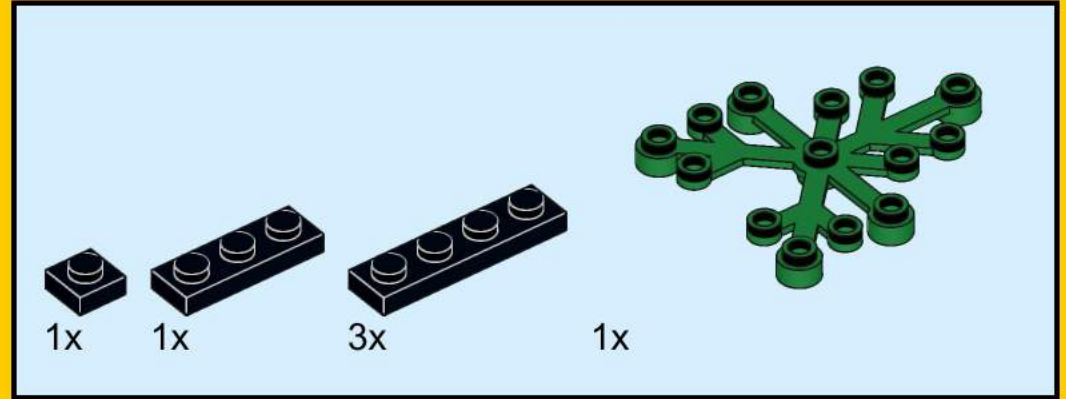

3

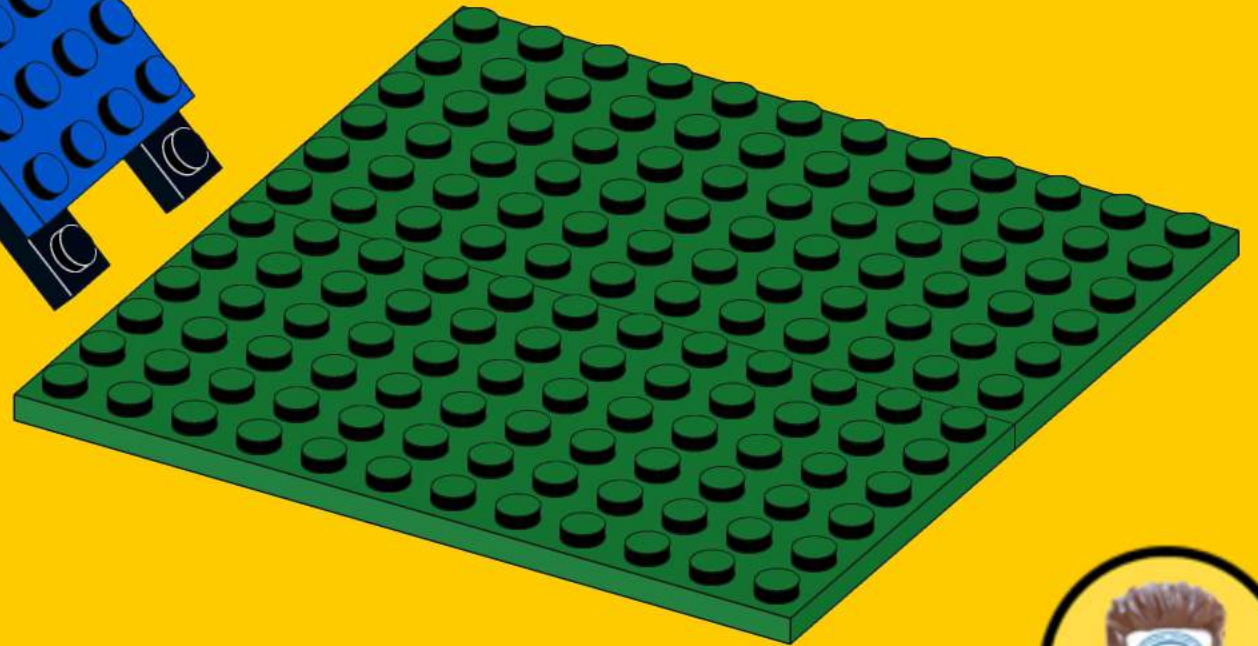
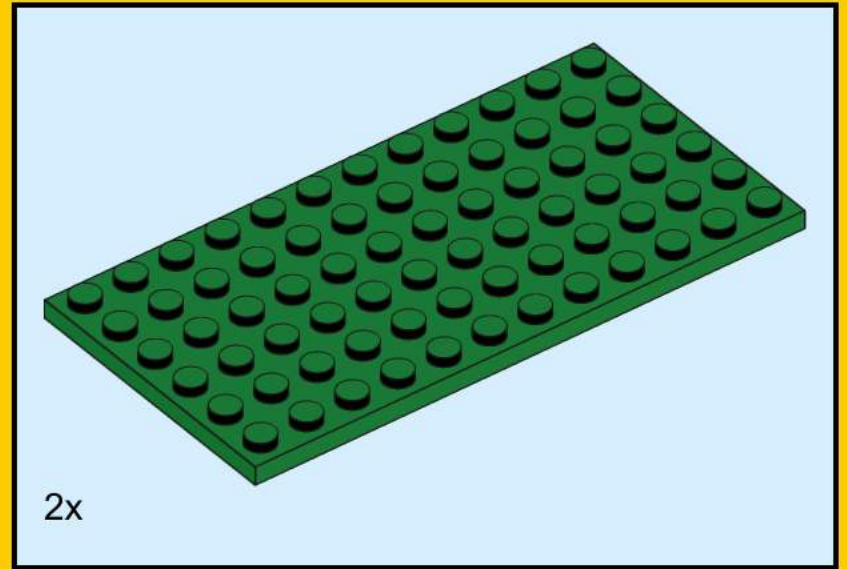
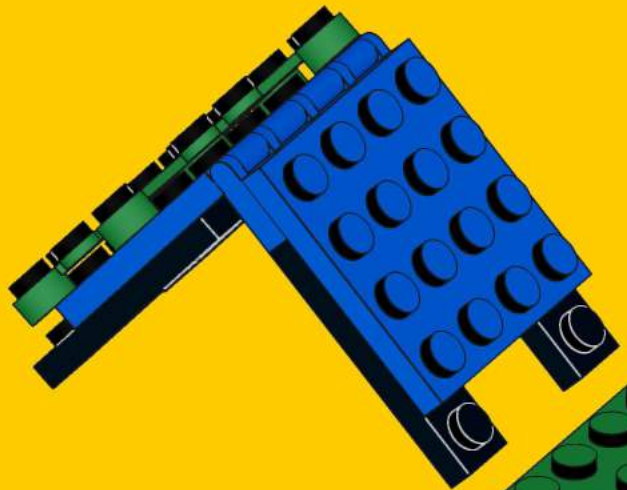

4

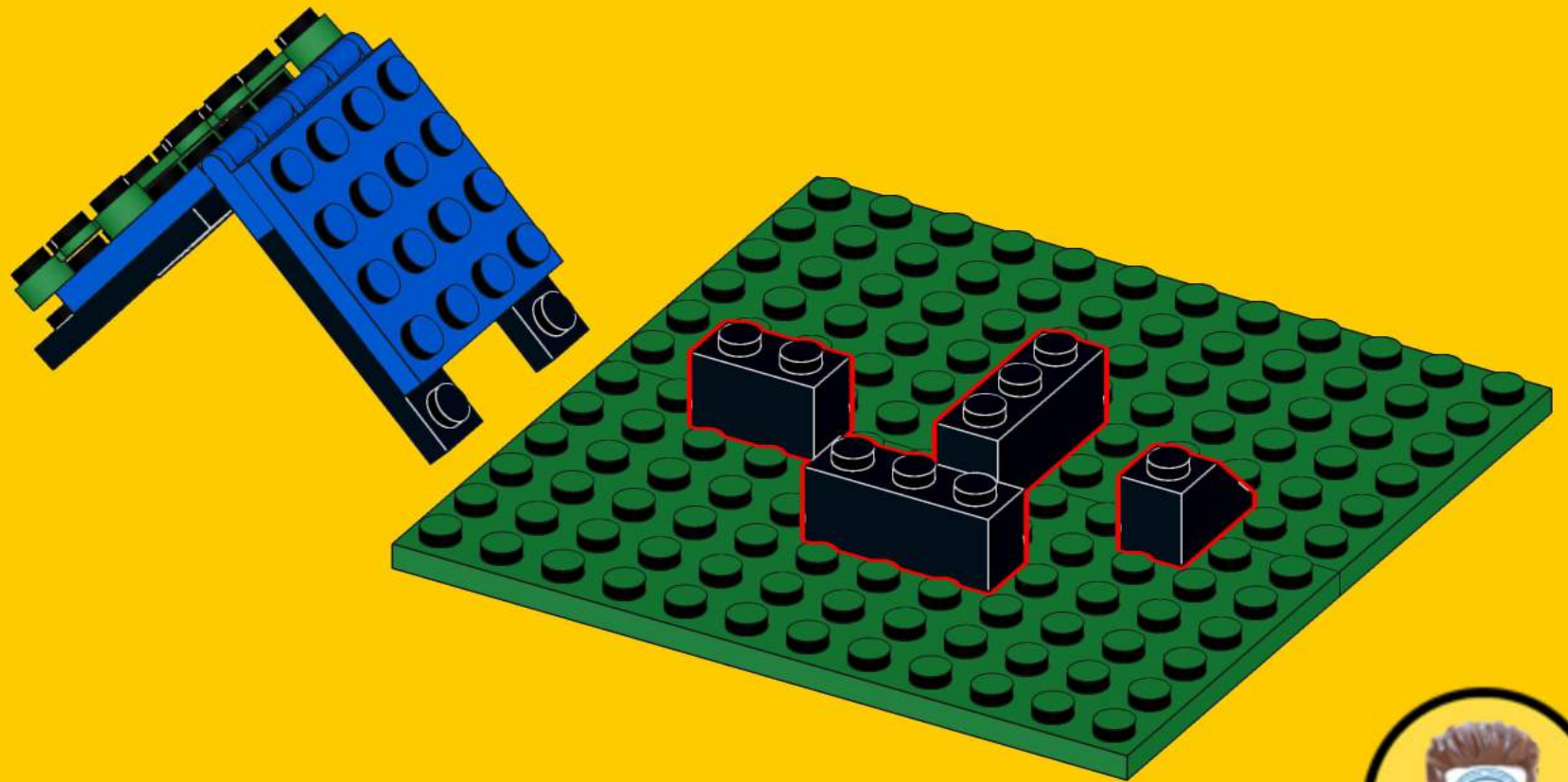
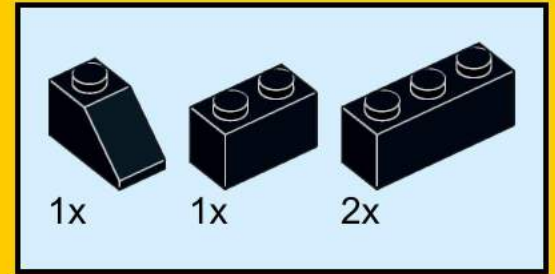

5

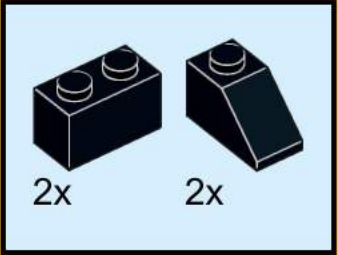
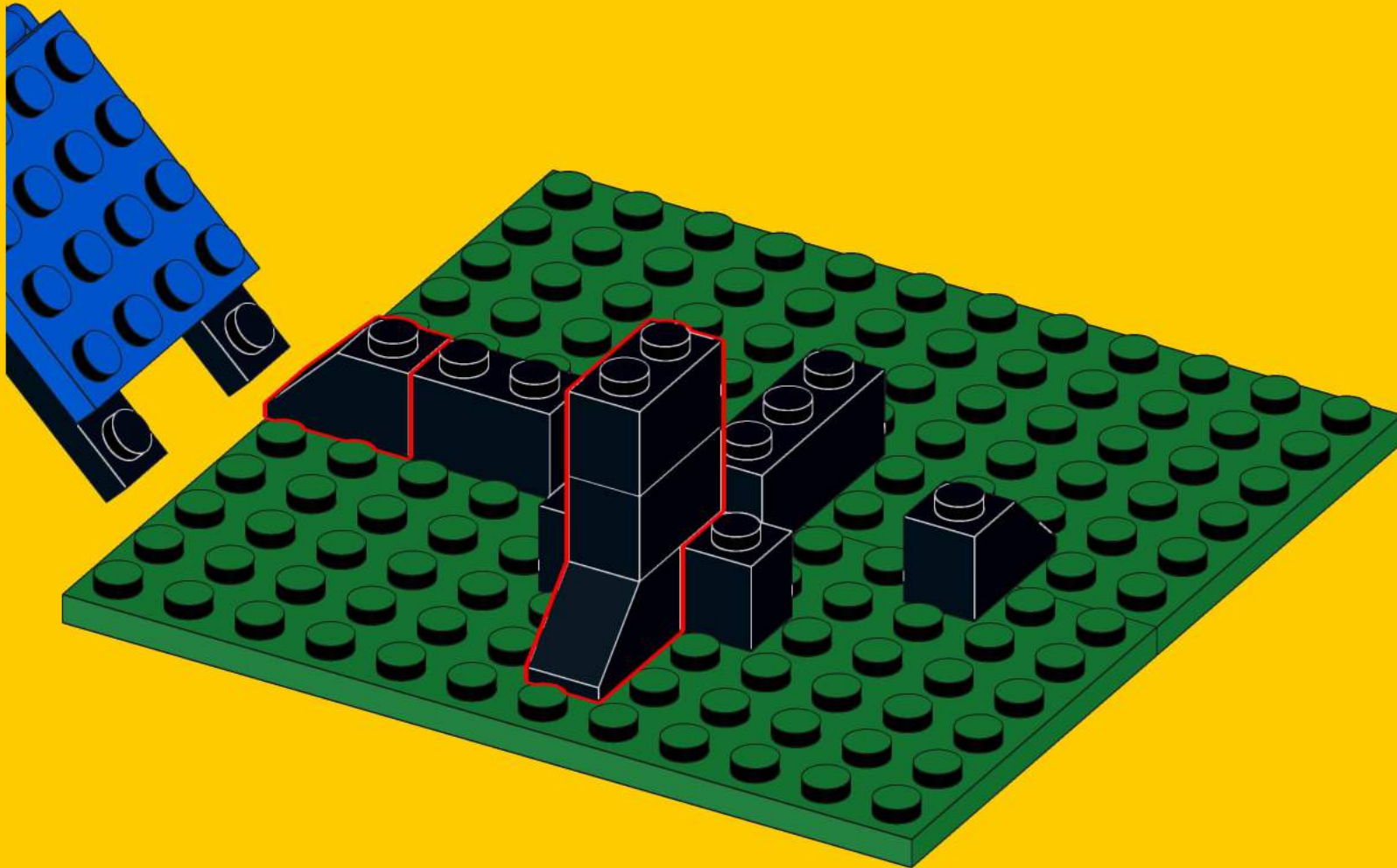

6

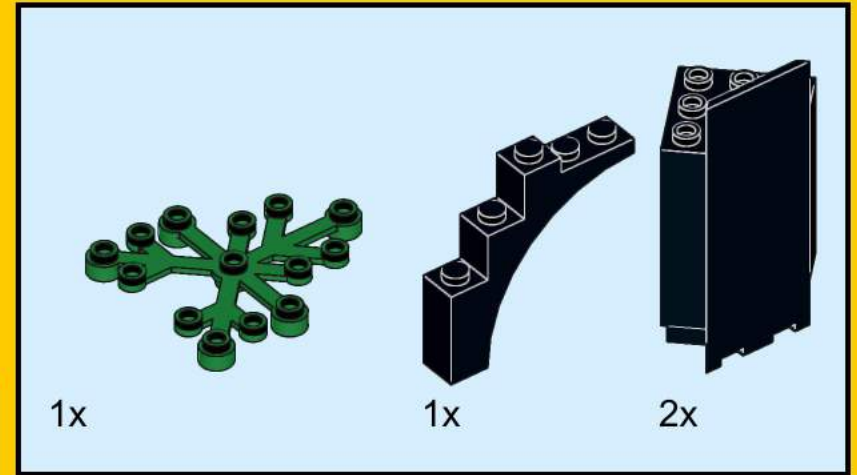
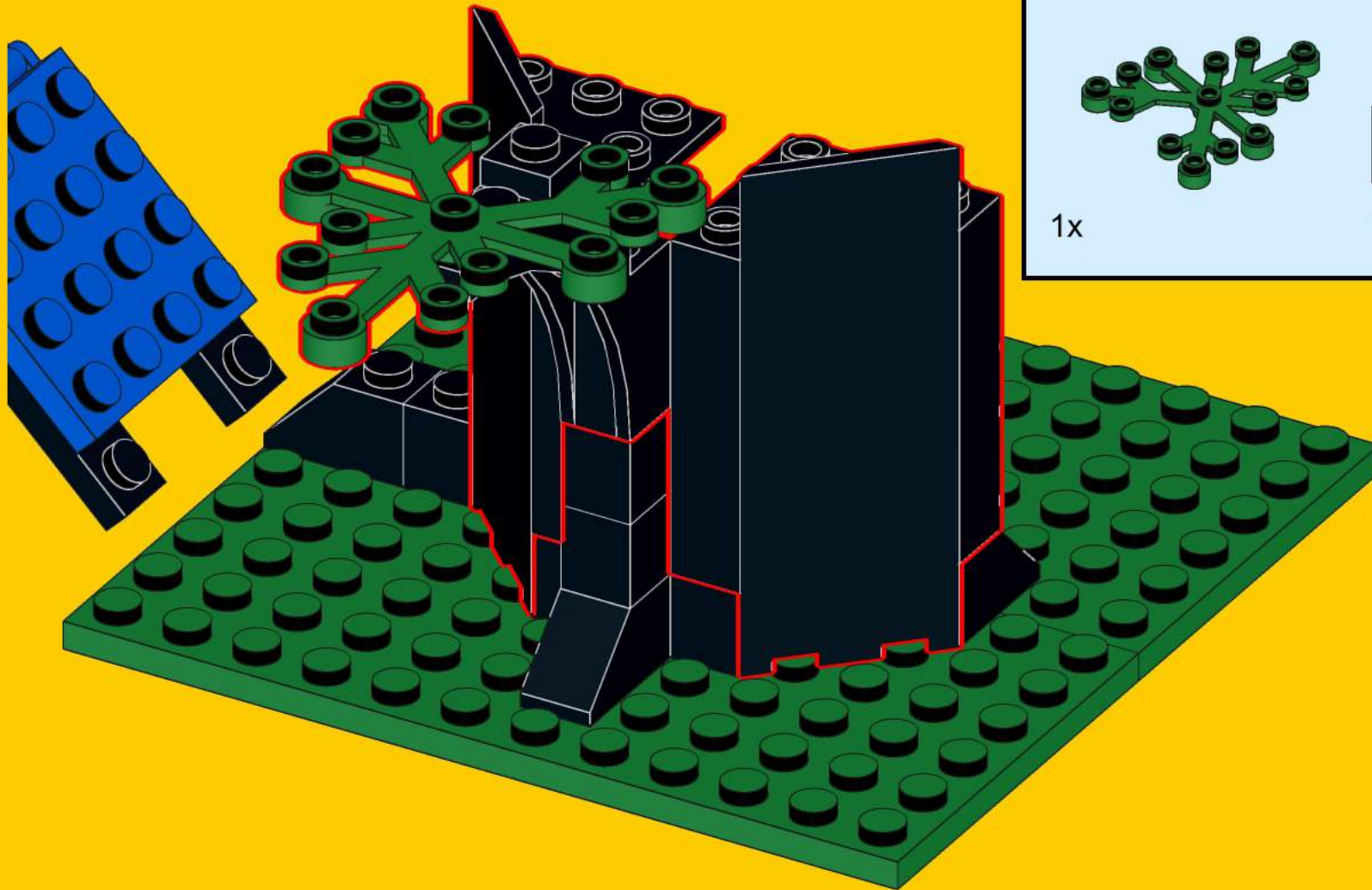

7

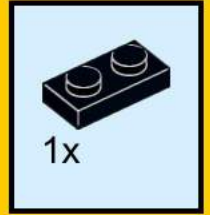

8

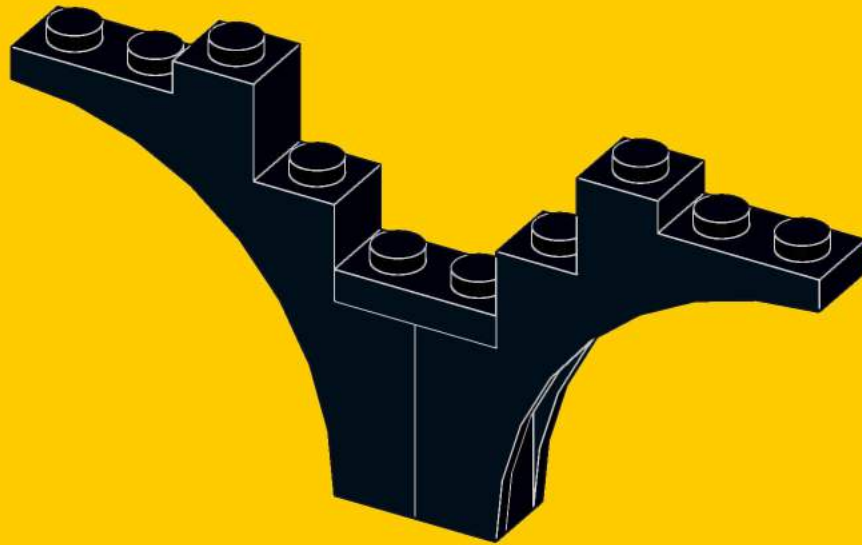
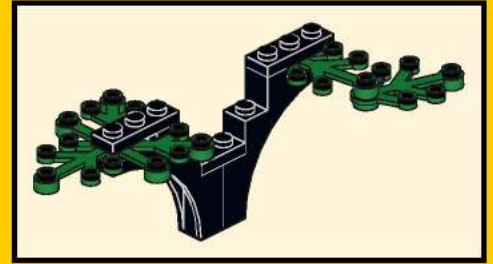
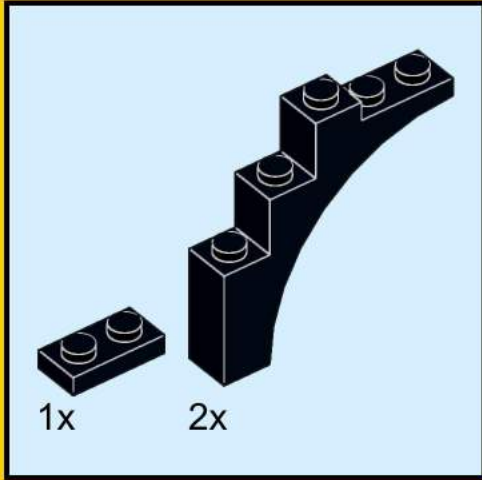

9

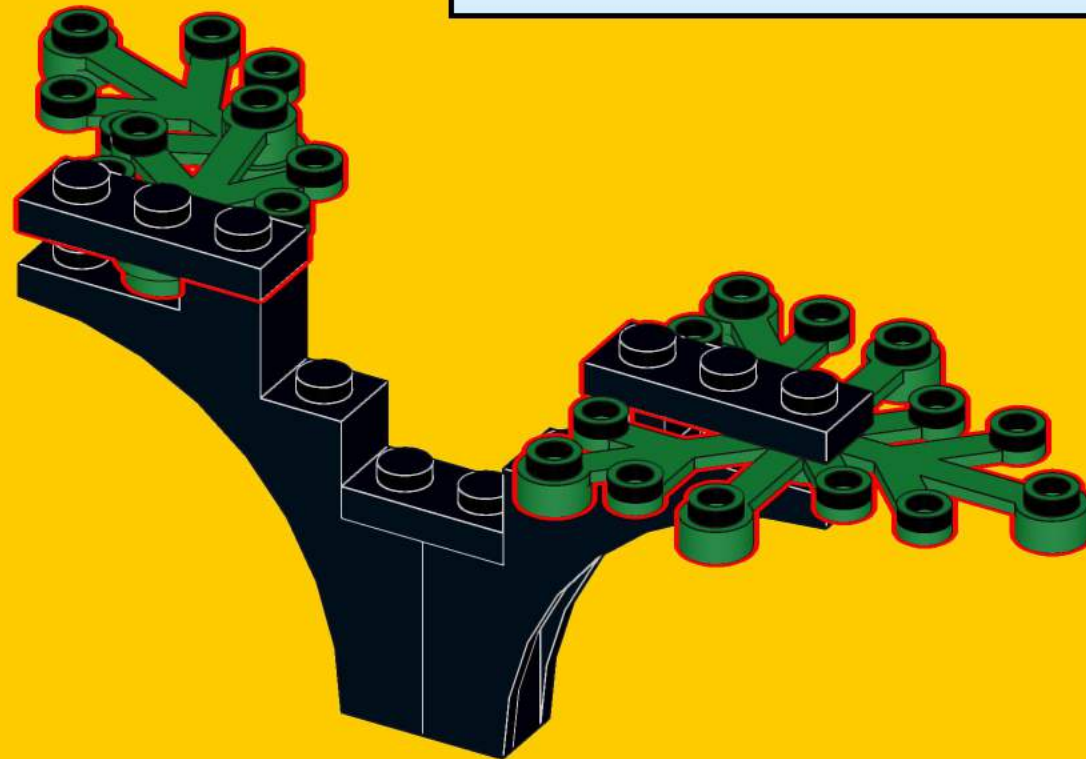
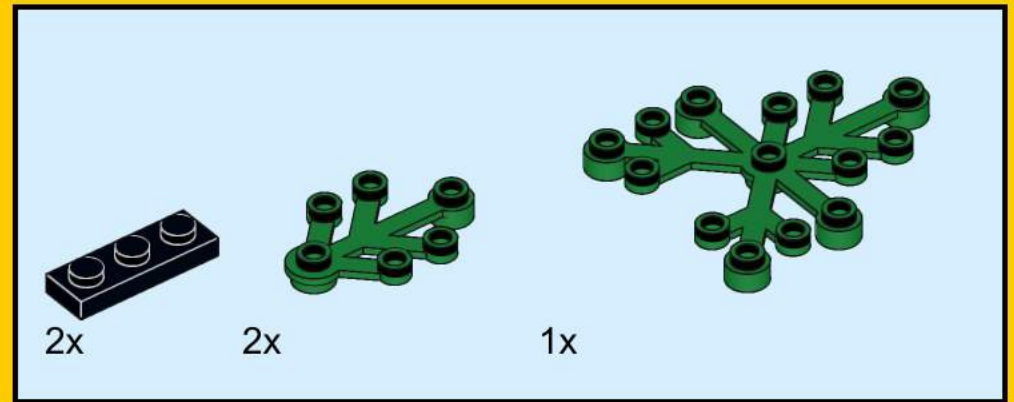

10

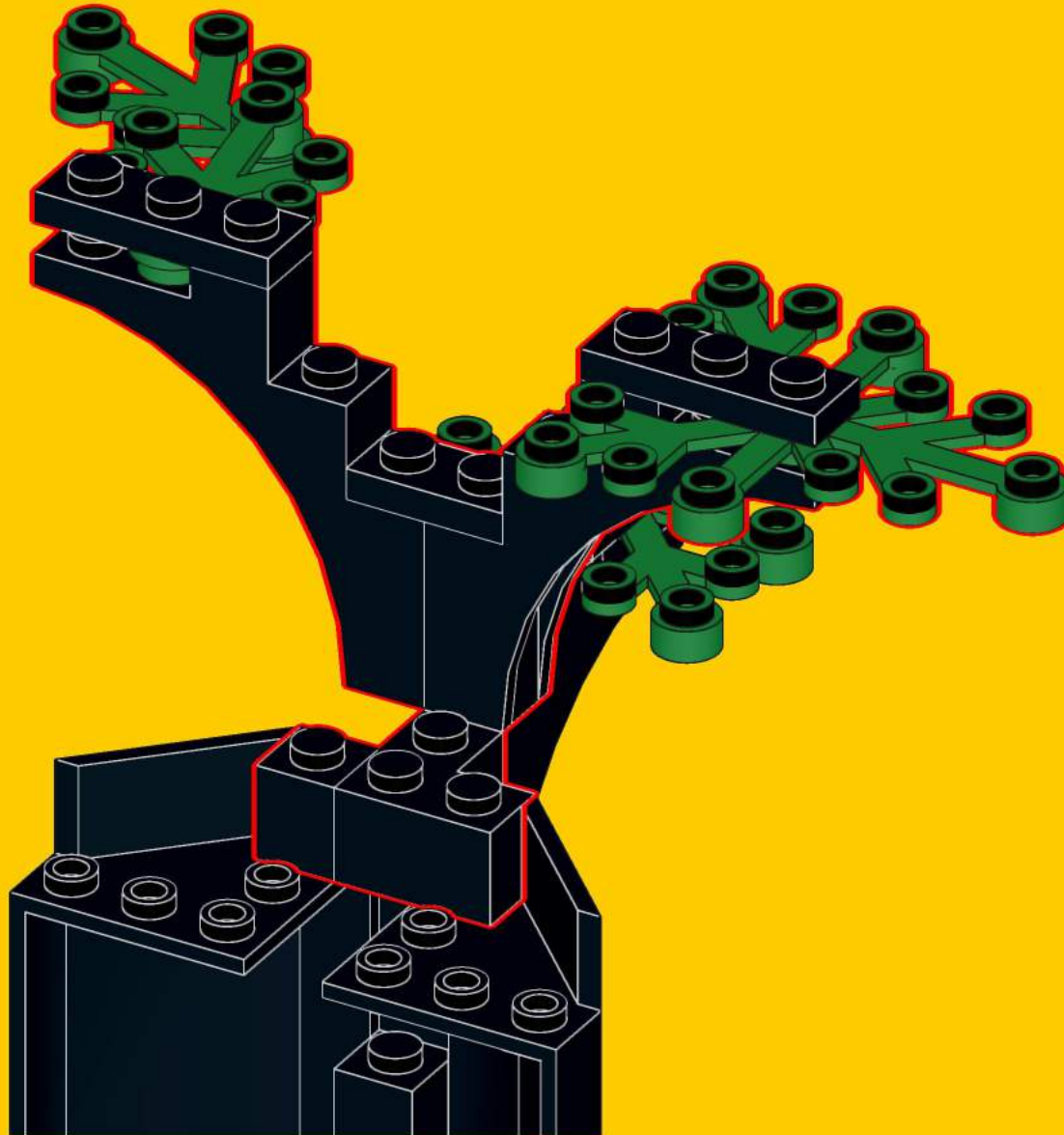
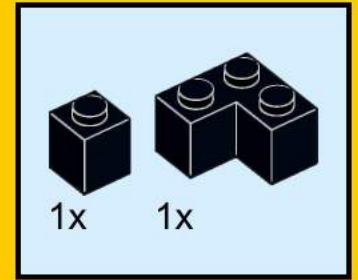

11

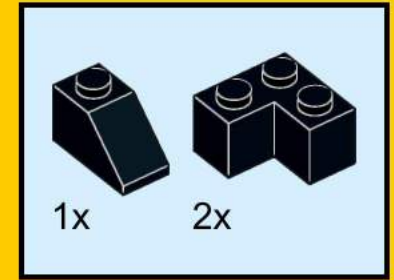
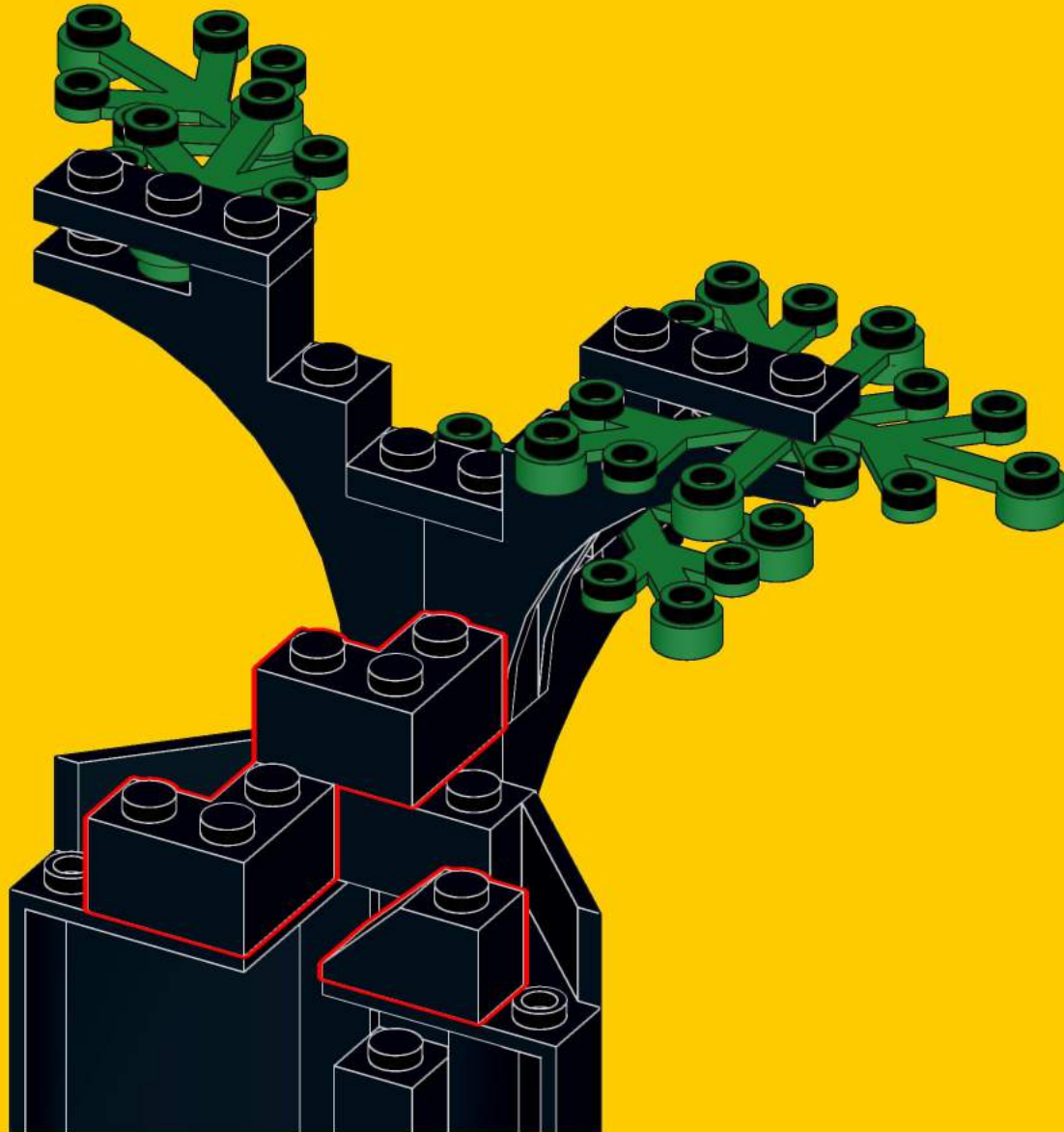

12

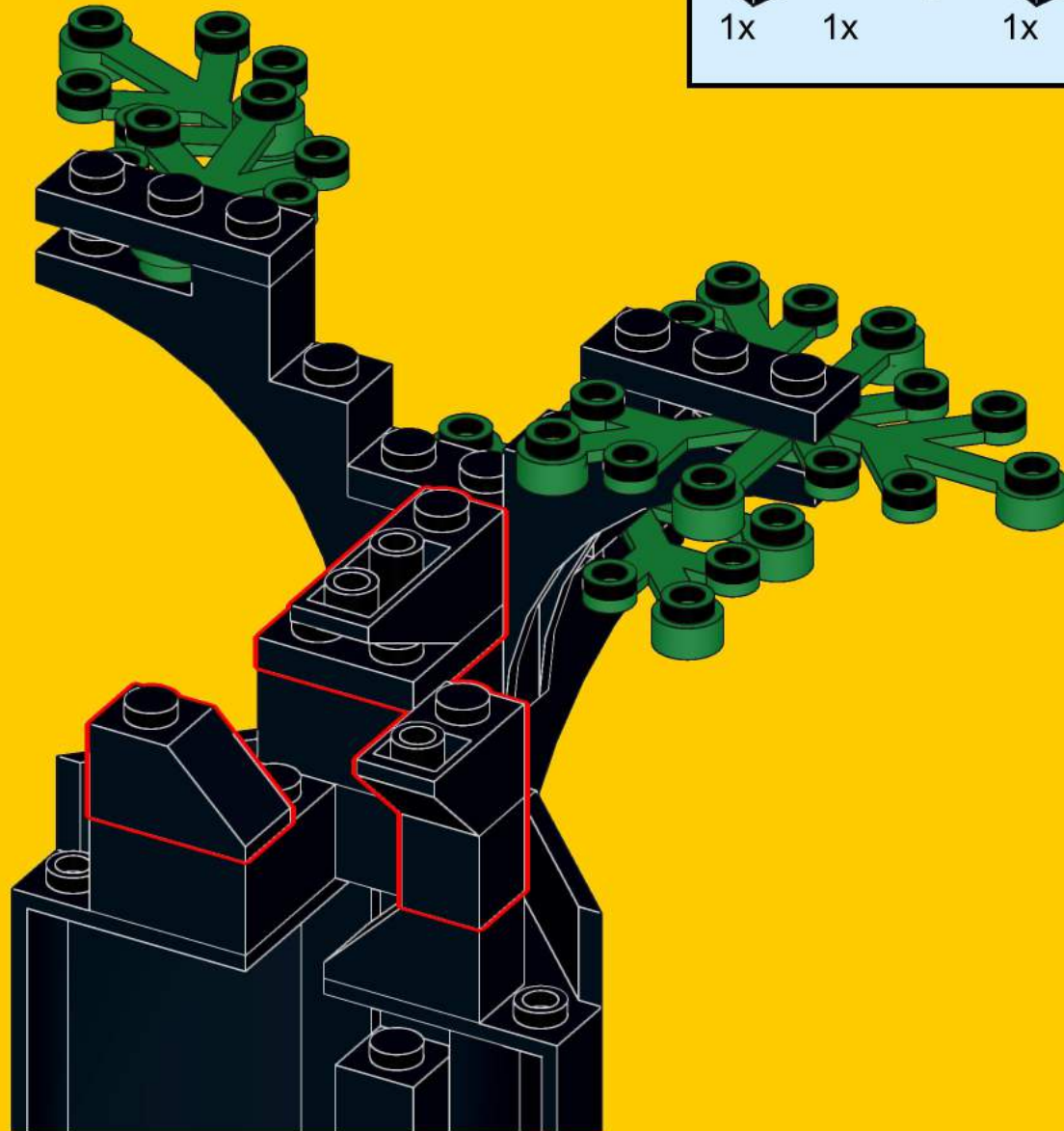
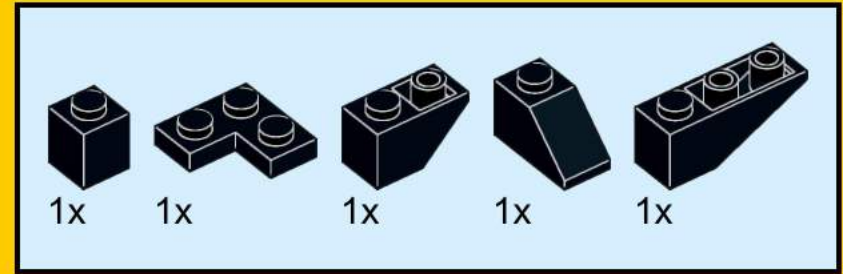

13

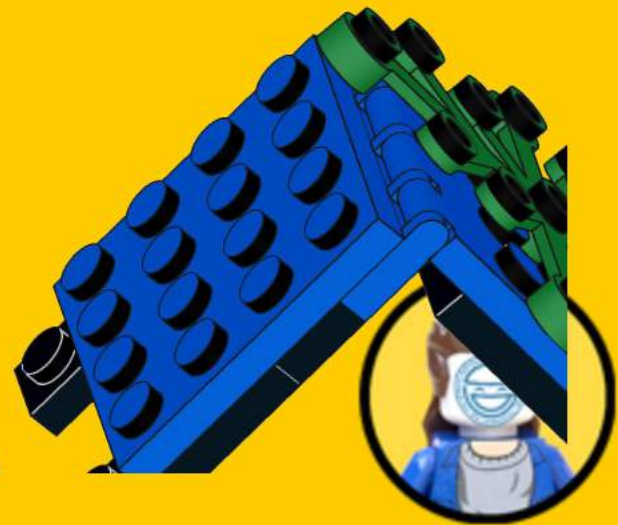
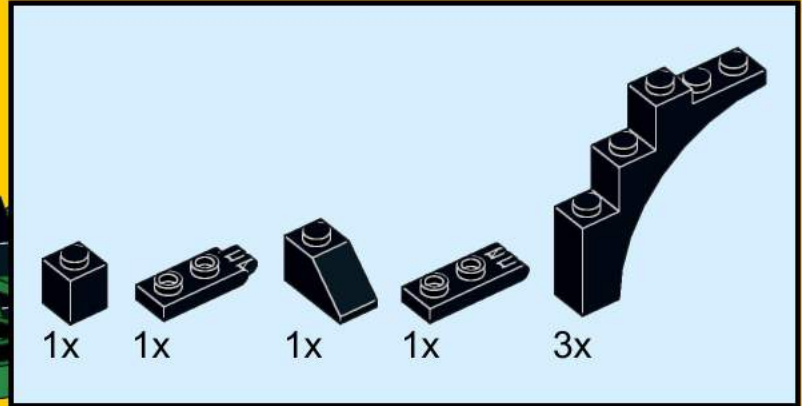
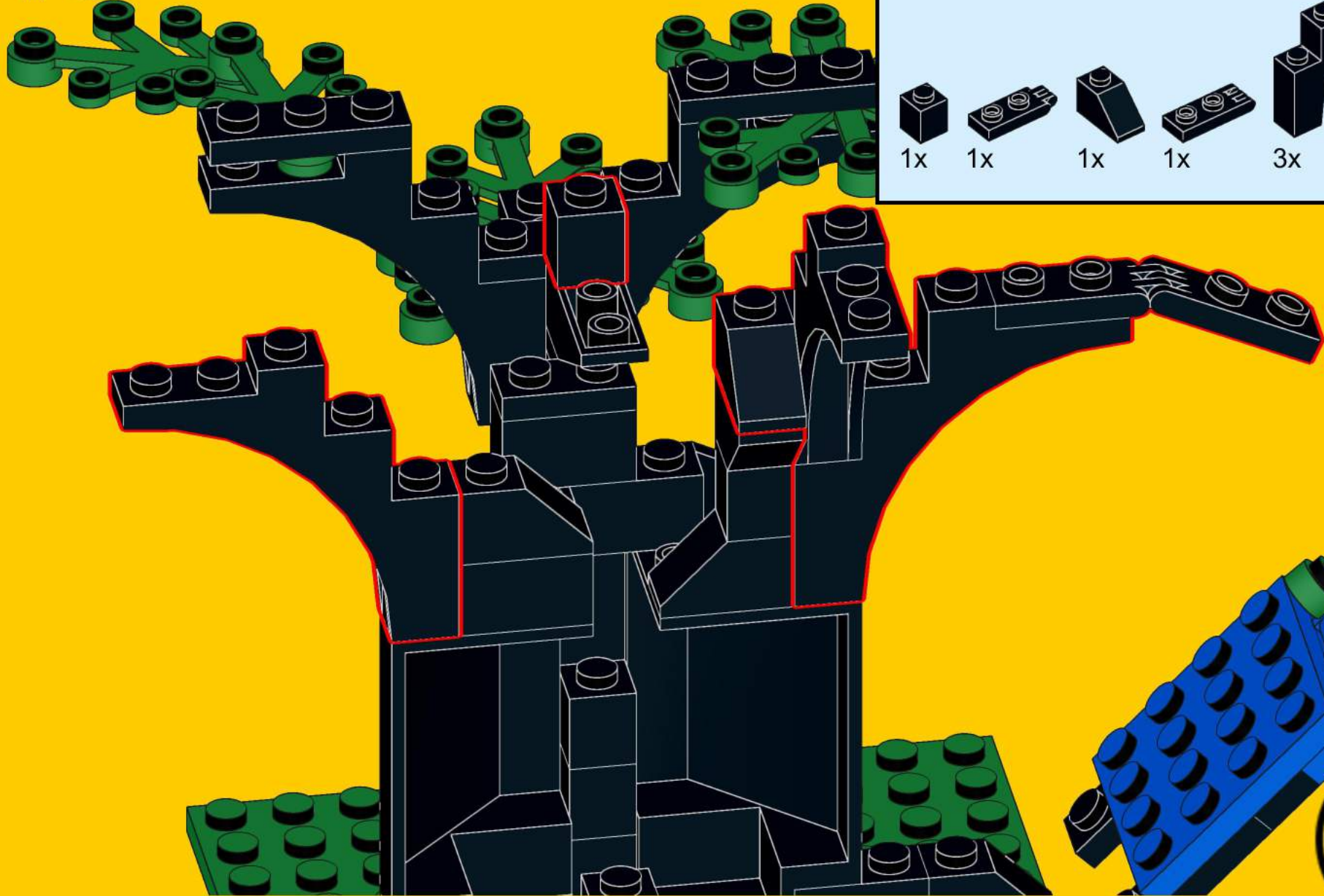

14

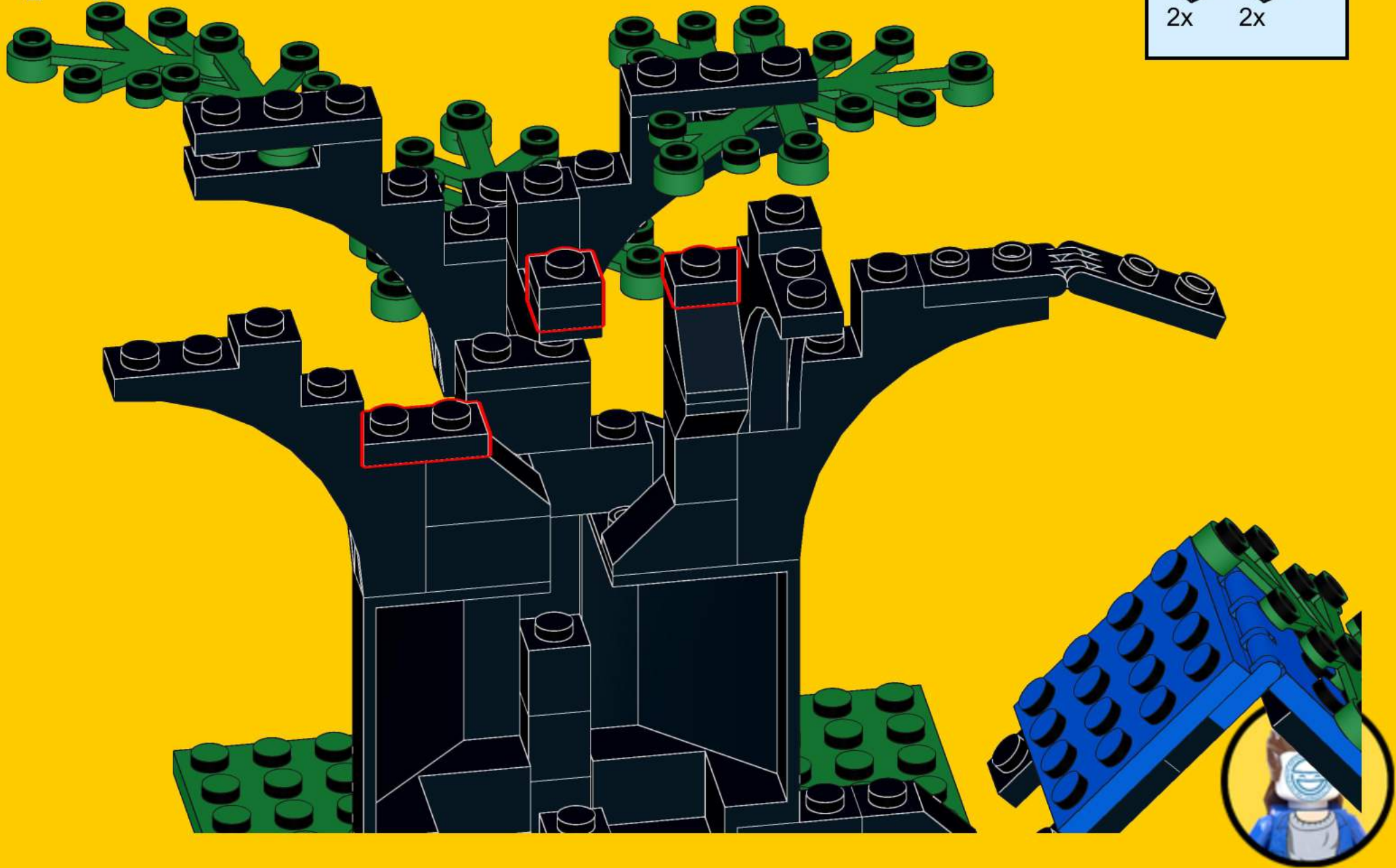
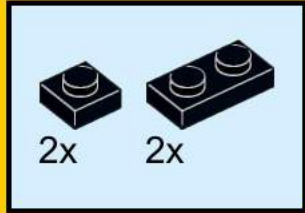

15

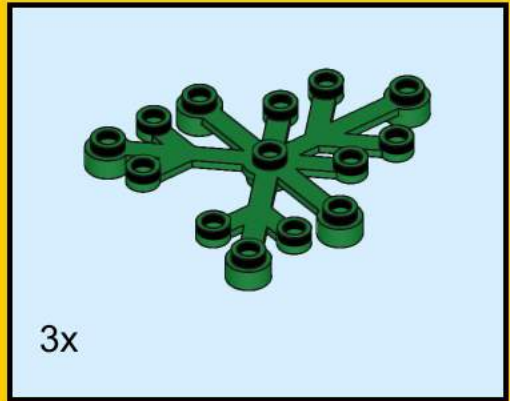

16

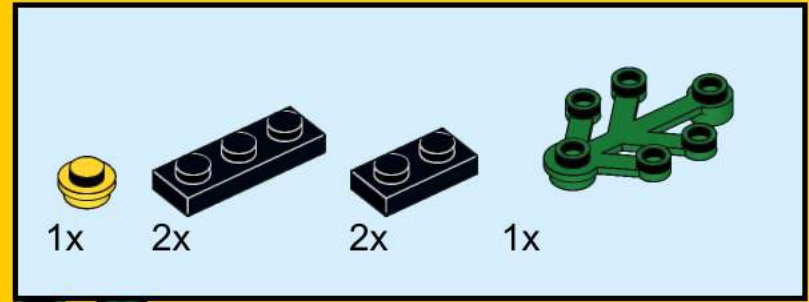

17

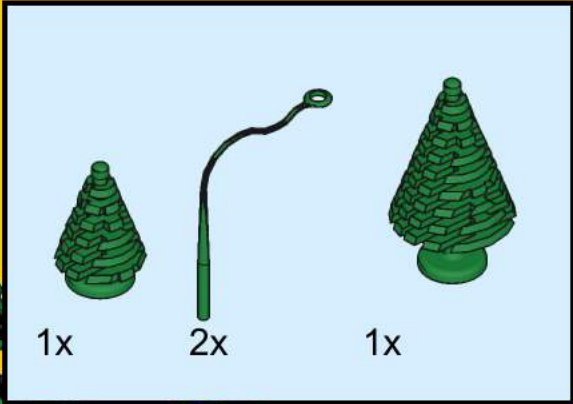
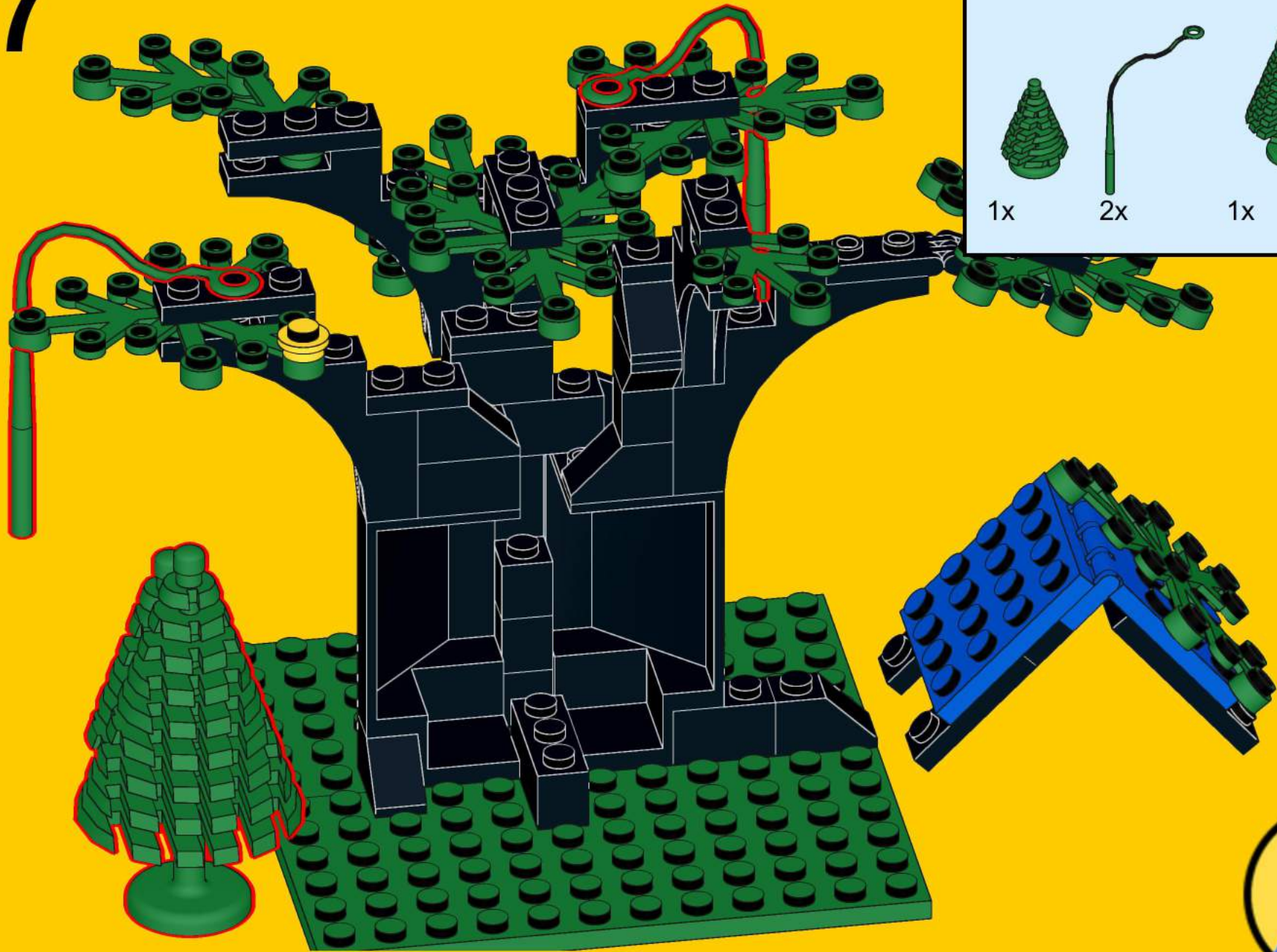

18



19



20

