

# 6085 Back C - Black Knight's River Crossing



**NOTE:**

**Back of the Box Image has an additional plate layer under the bridge.  
I removed it willingly to have the bridge be usable by letting ships pass once open.**



1

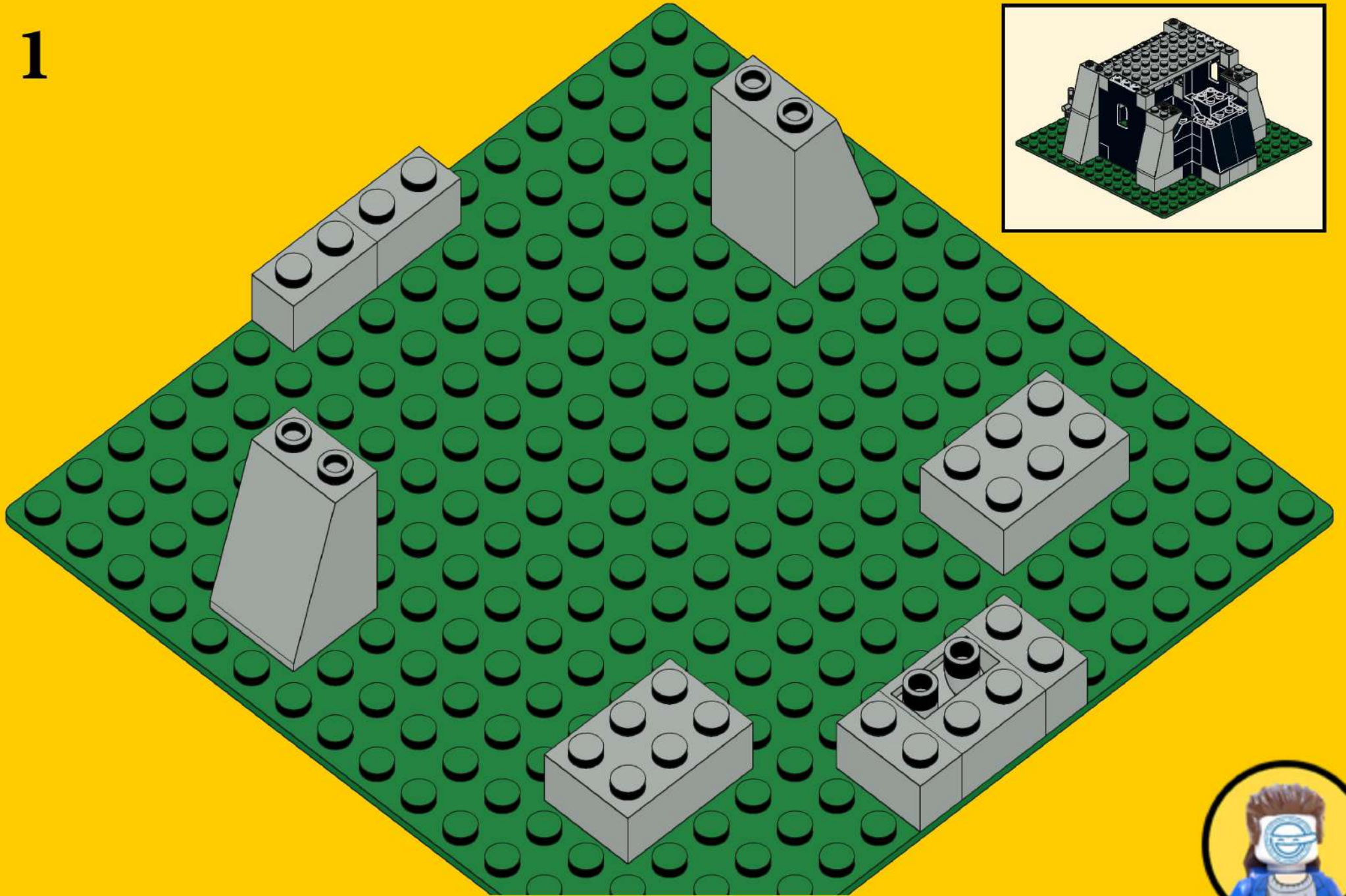

2

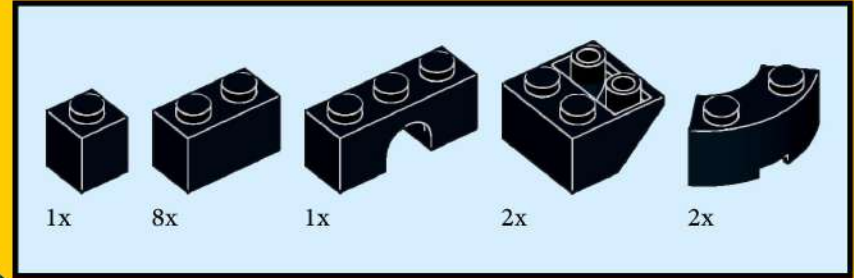
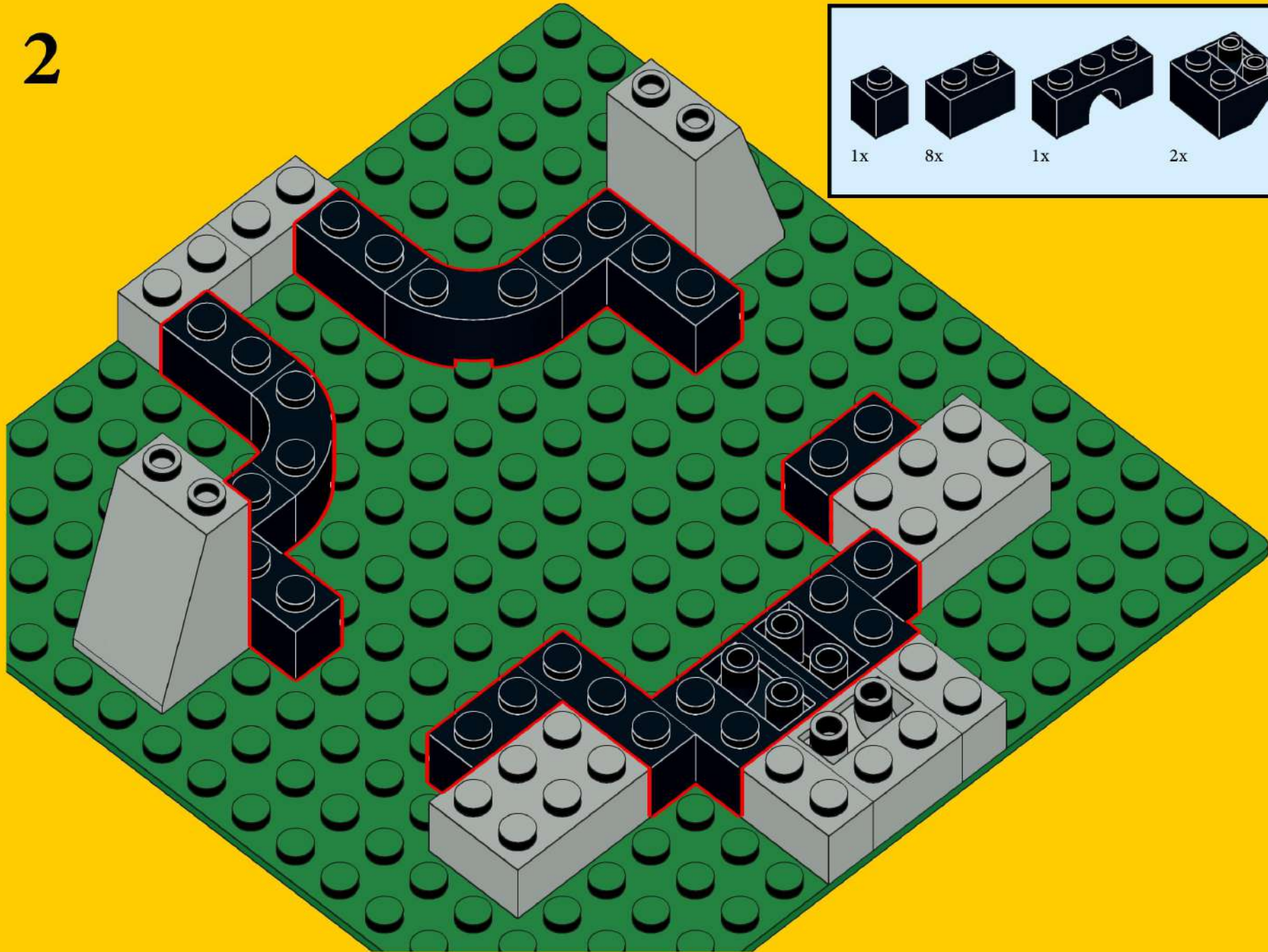

3

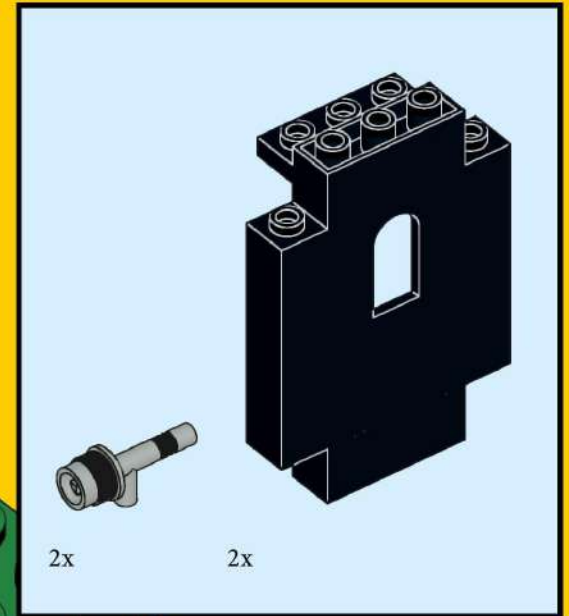
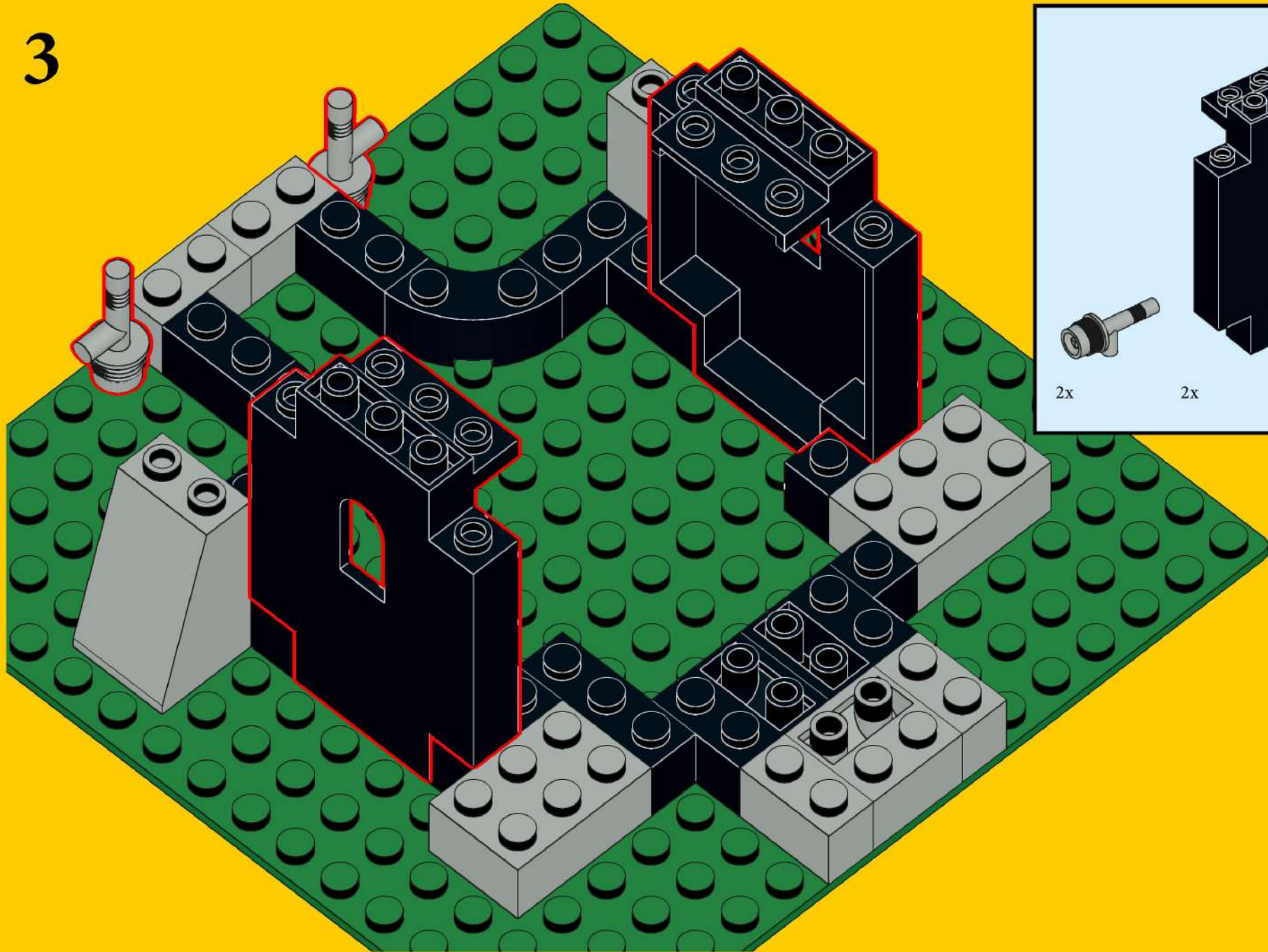

4

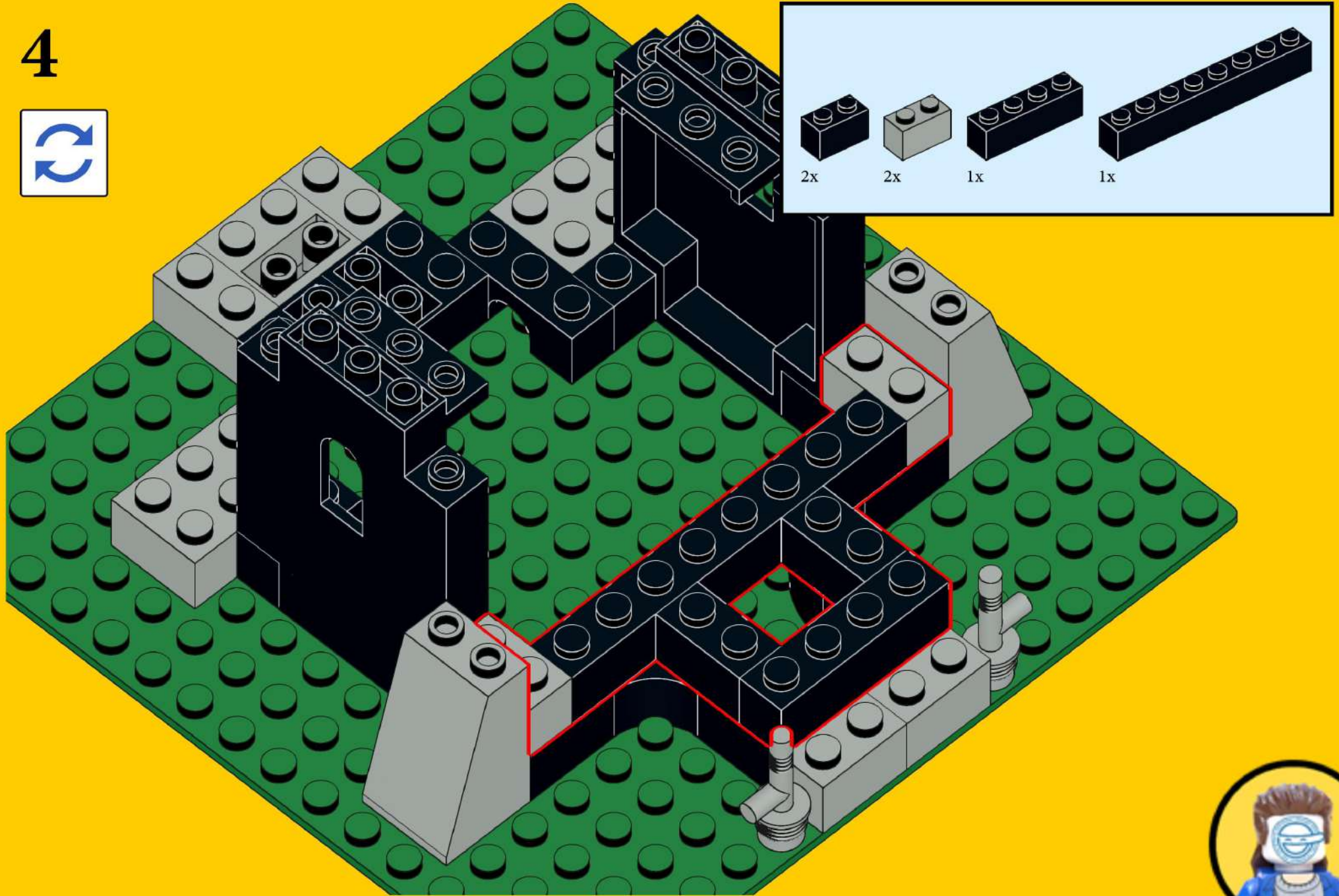

5

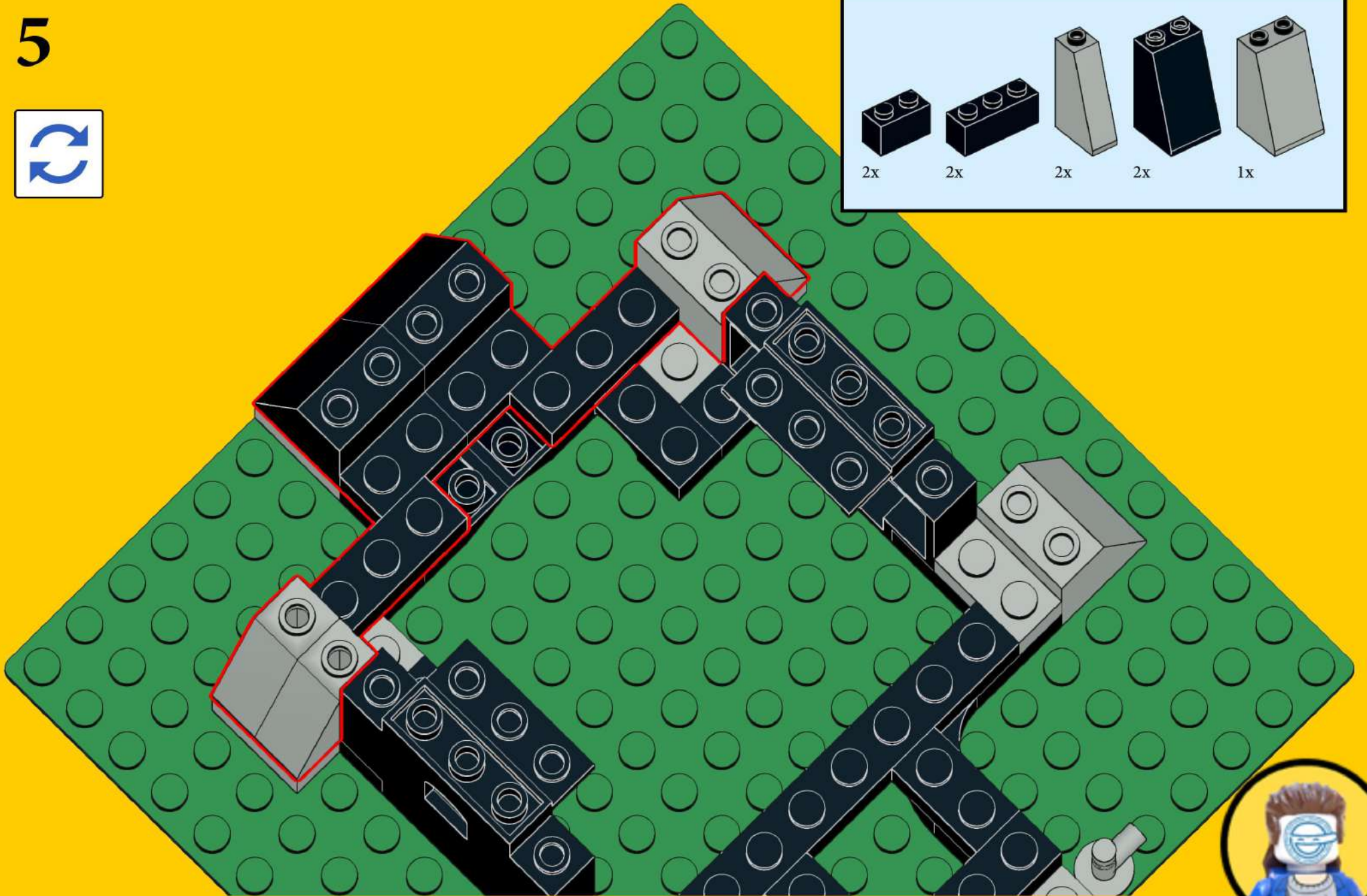
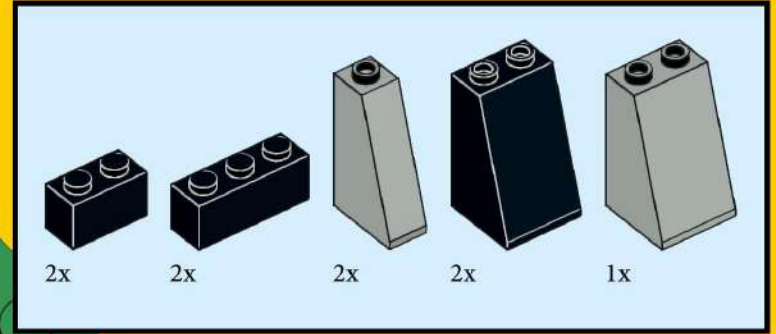

6

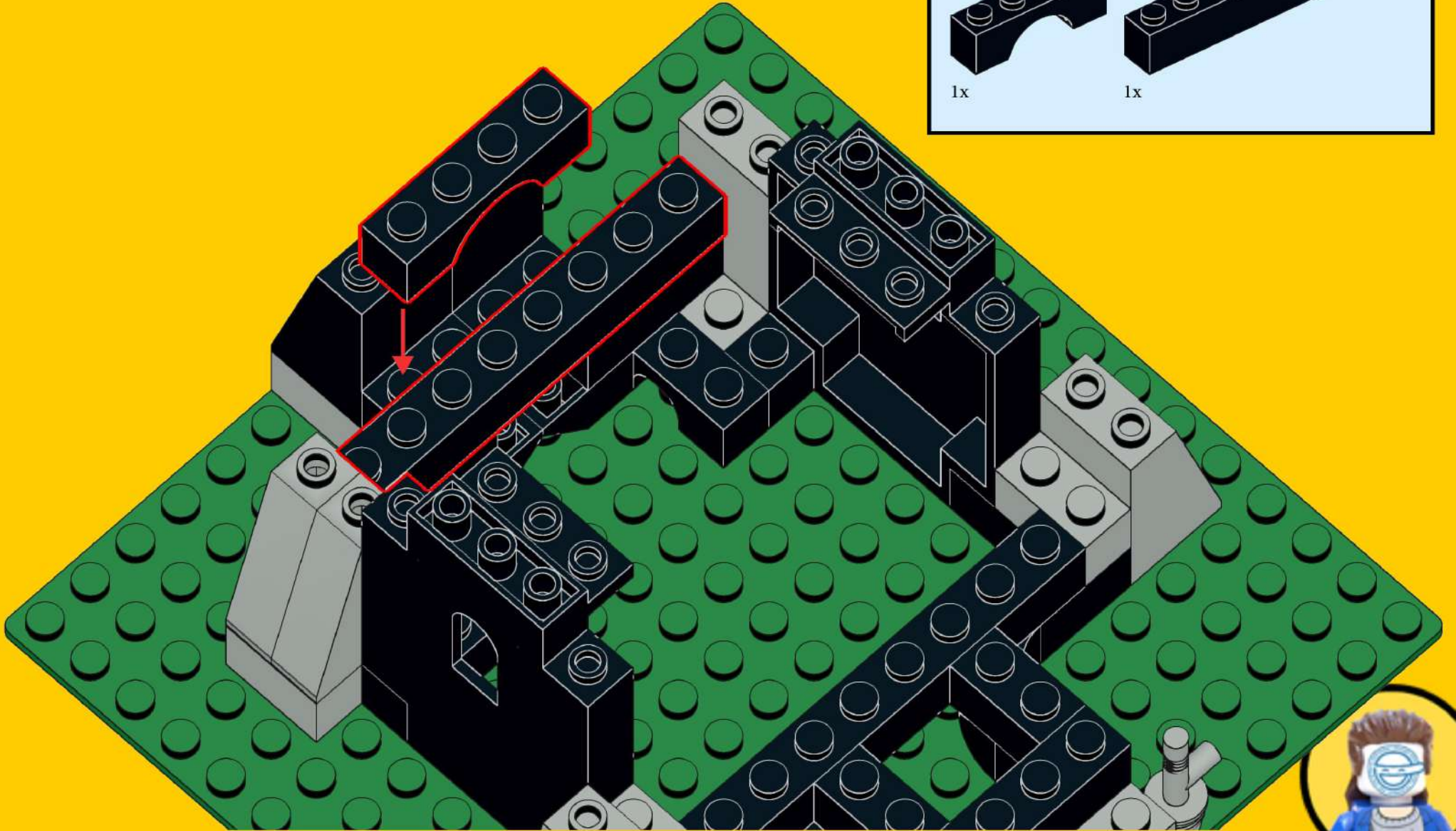
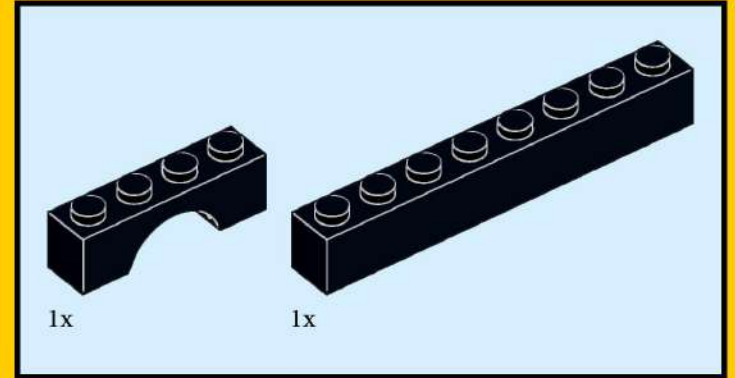



7

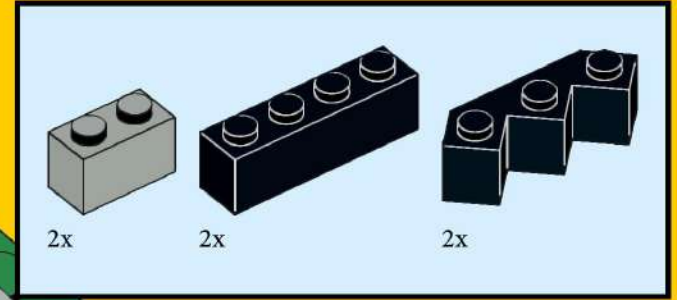
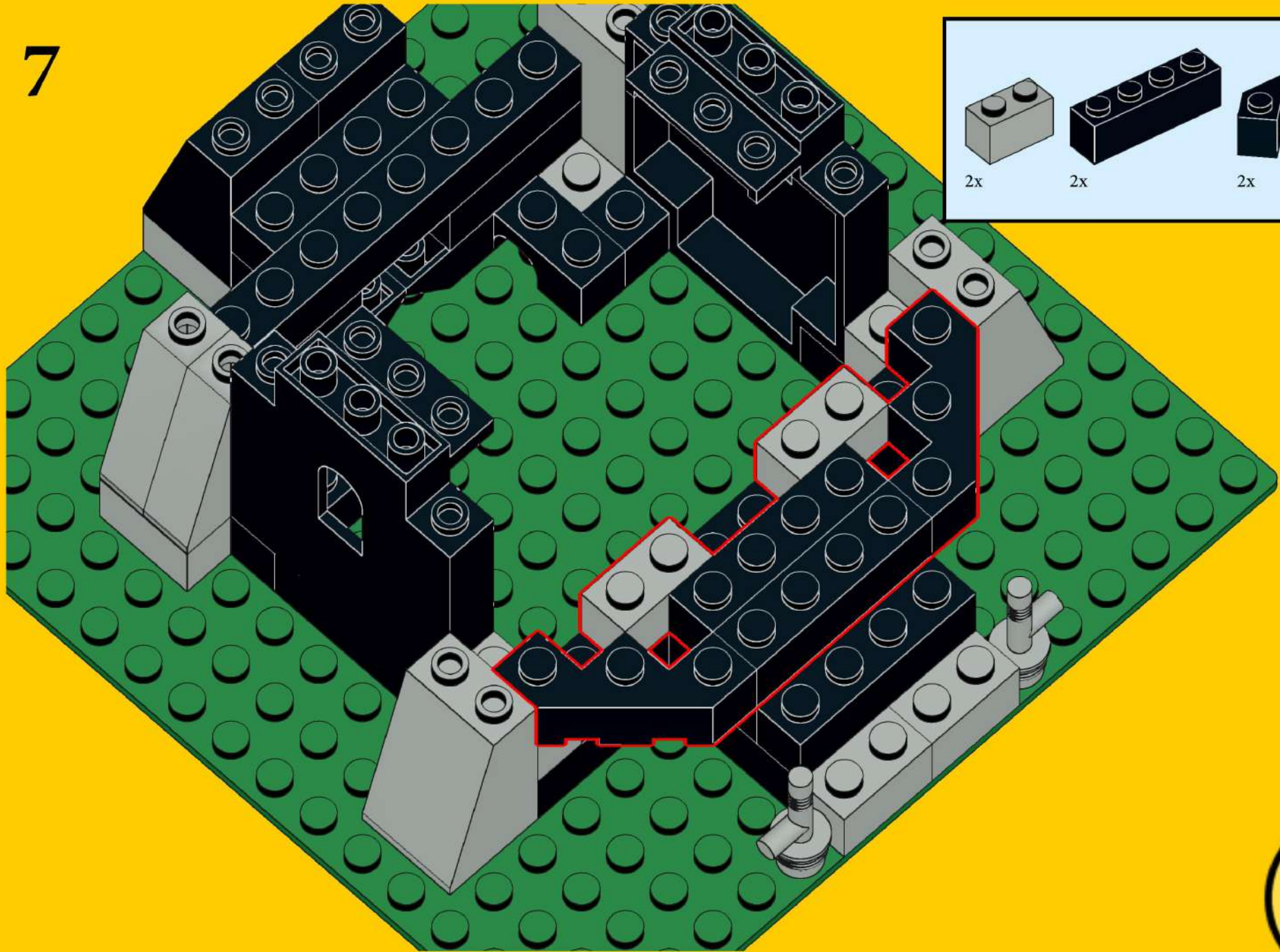

8

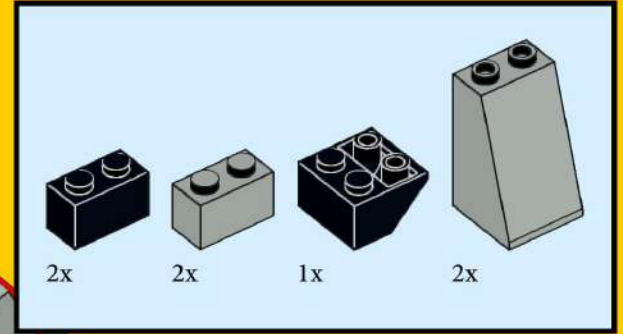
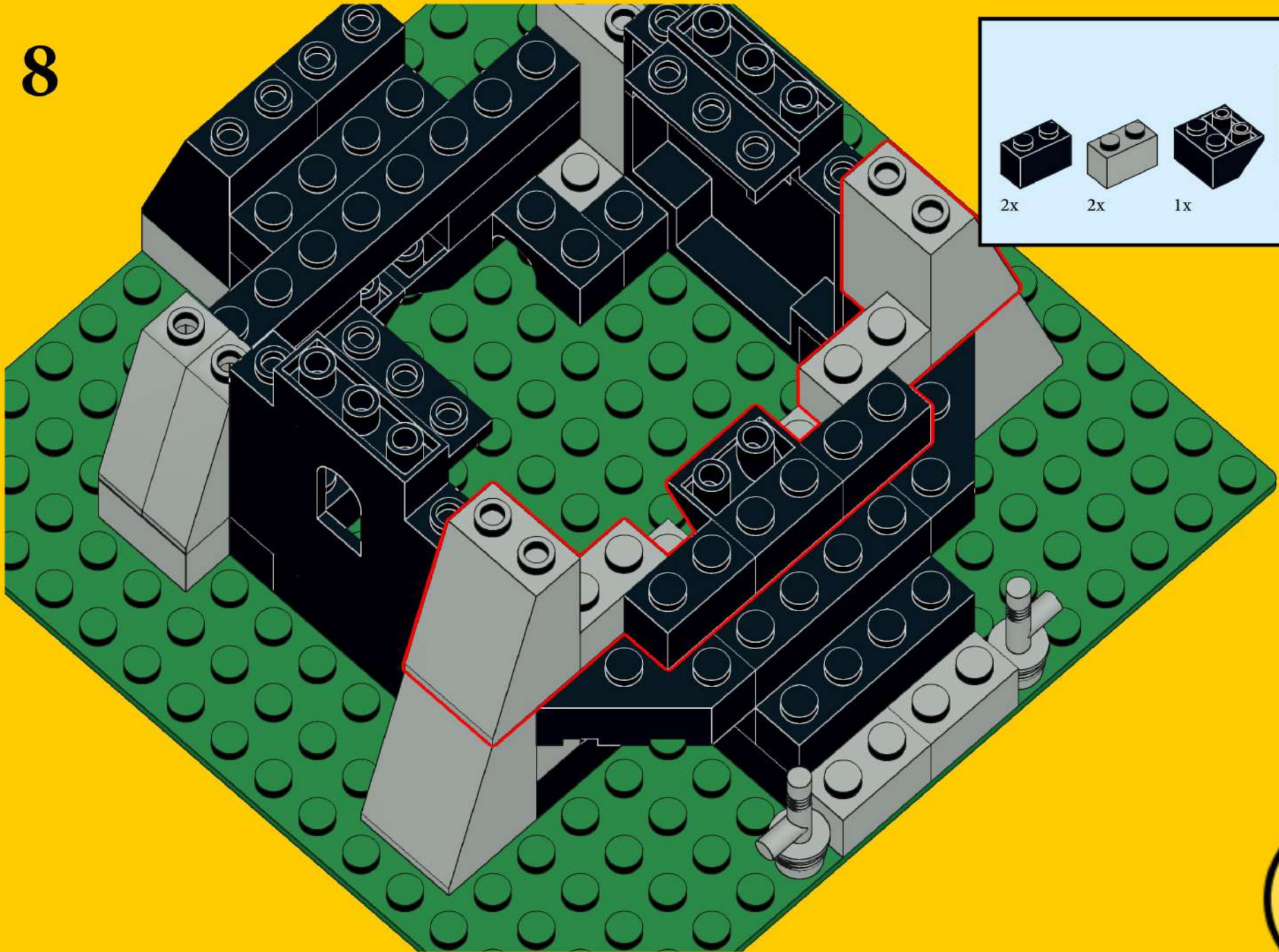

9

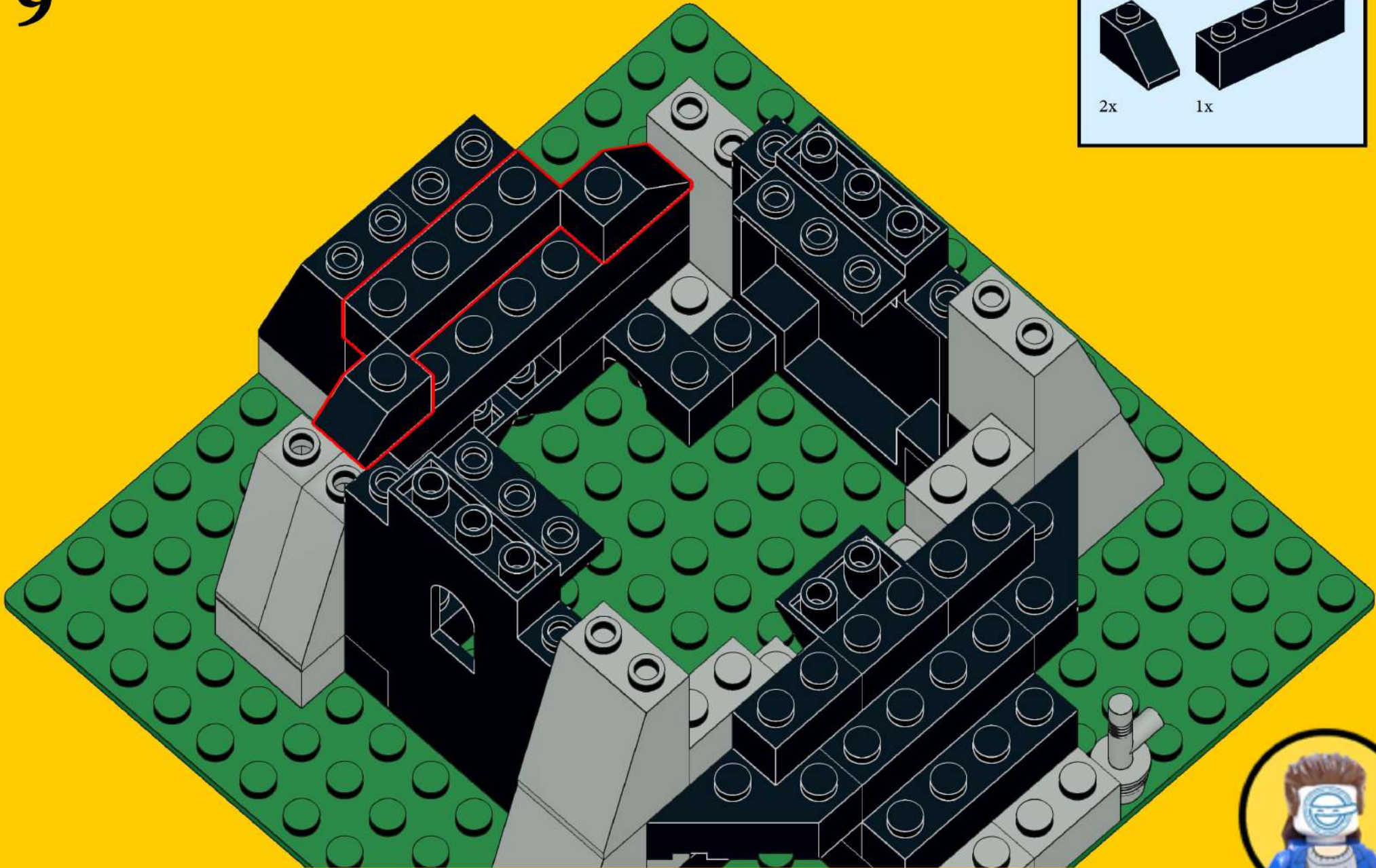
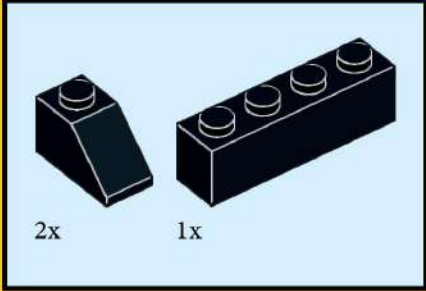

10

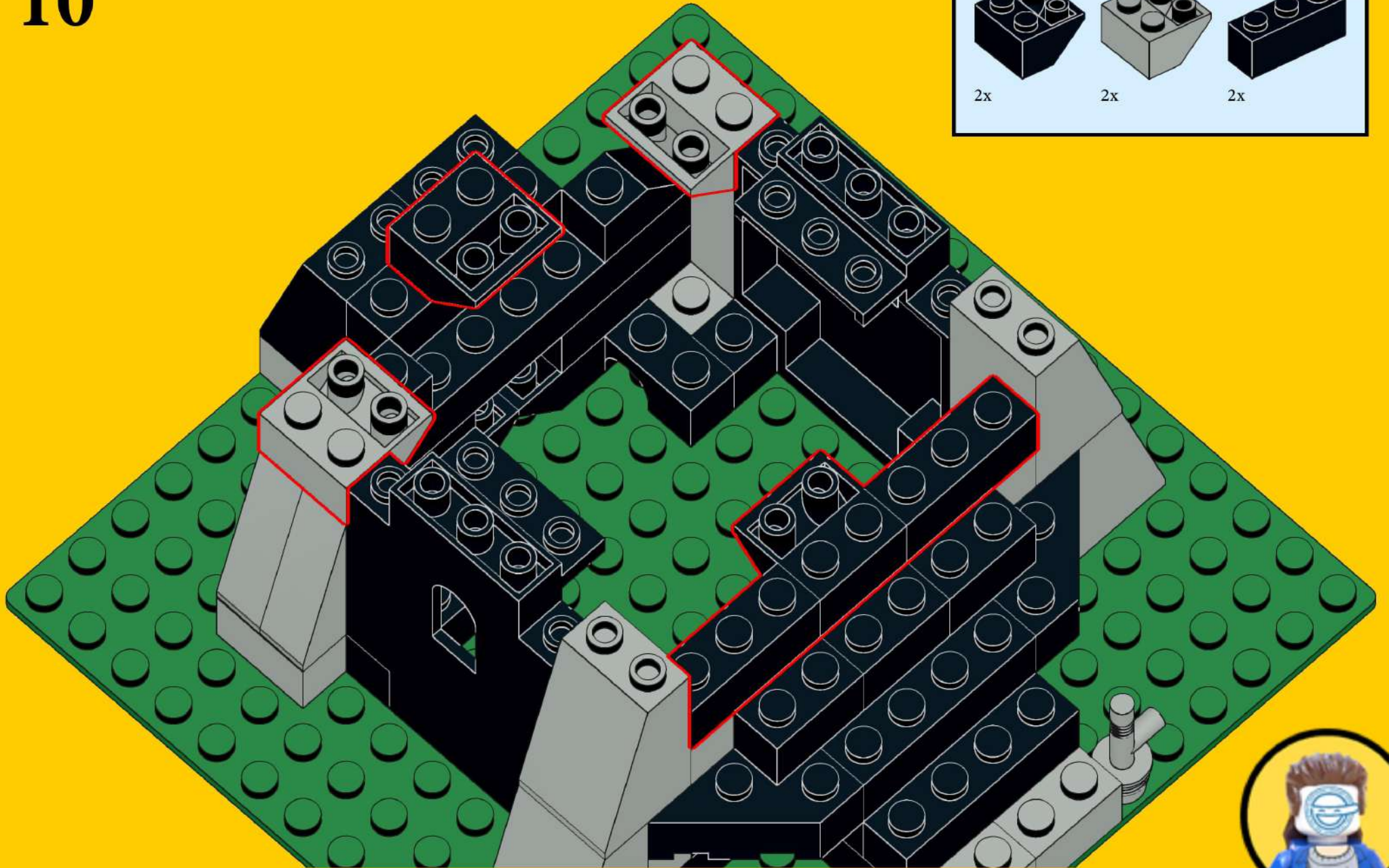
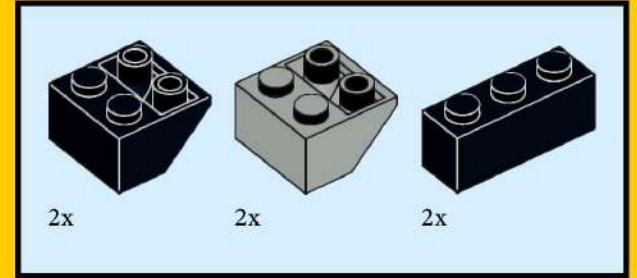

11

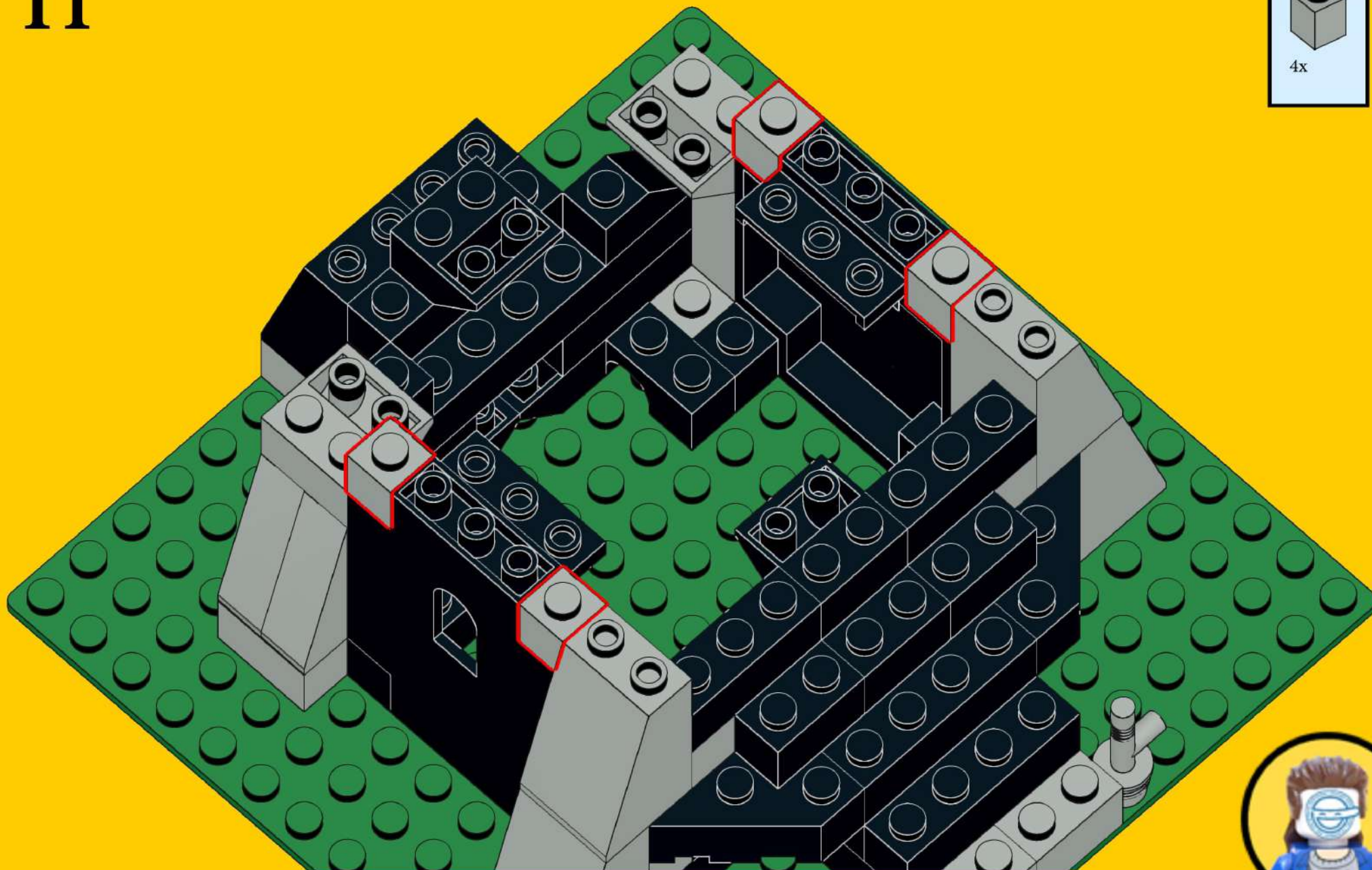
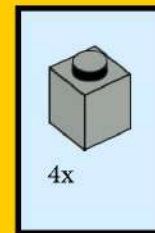

12

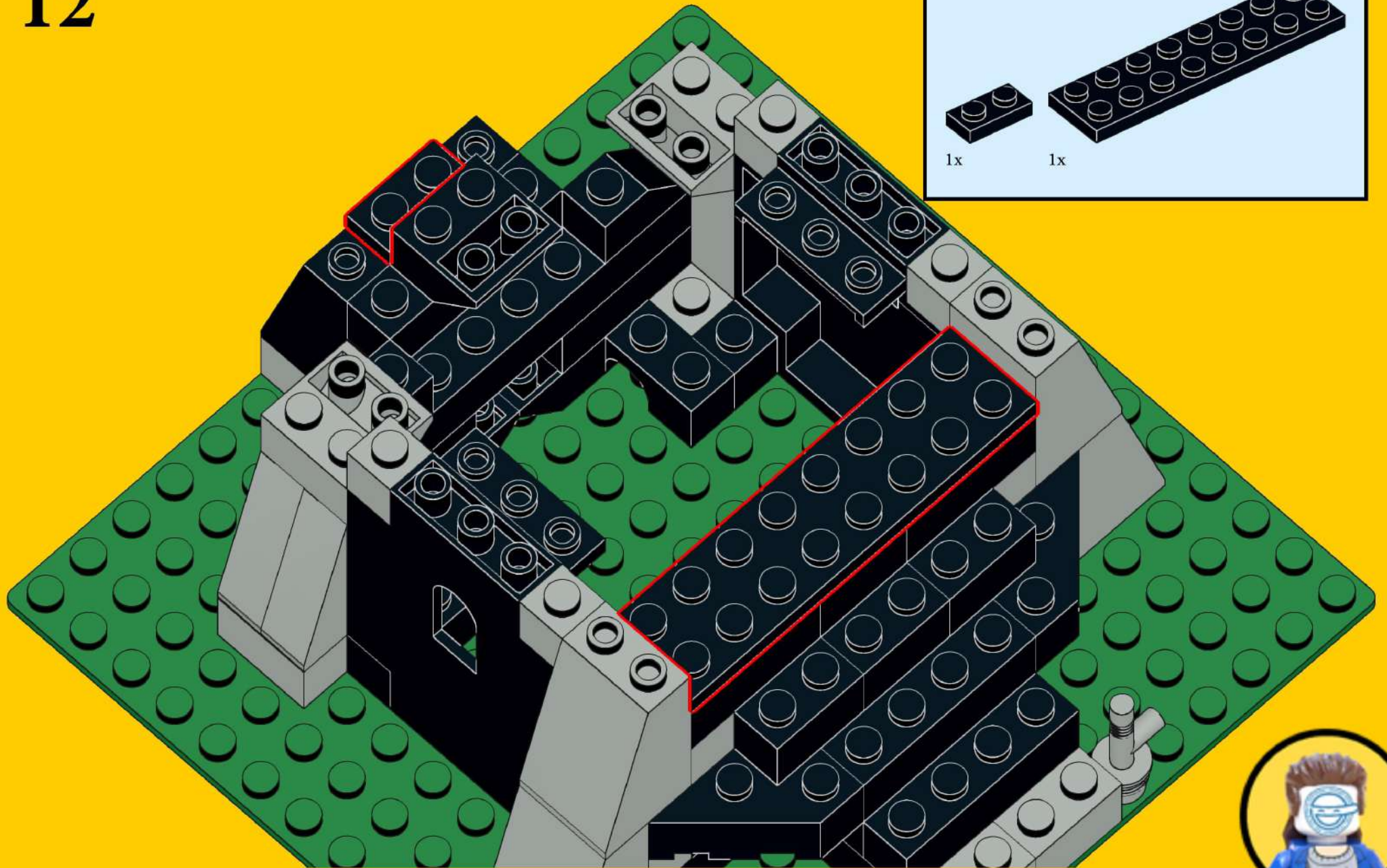

13

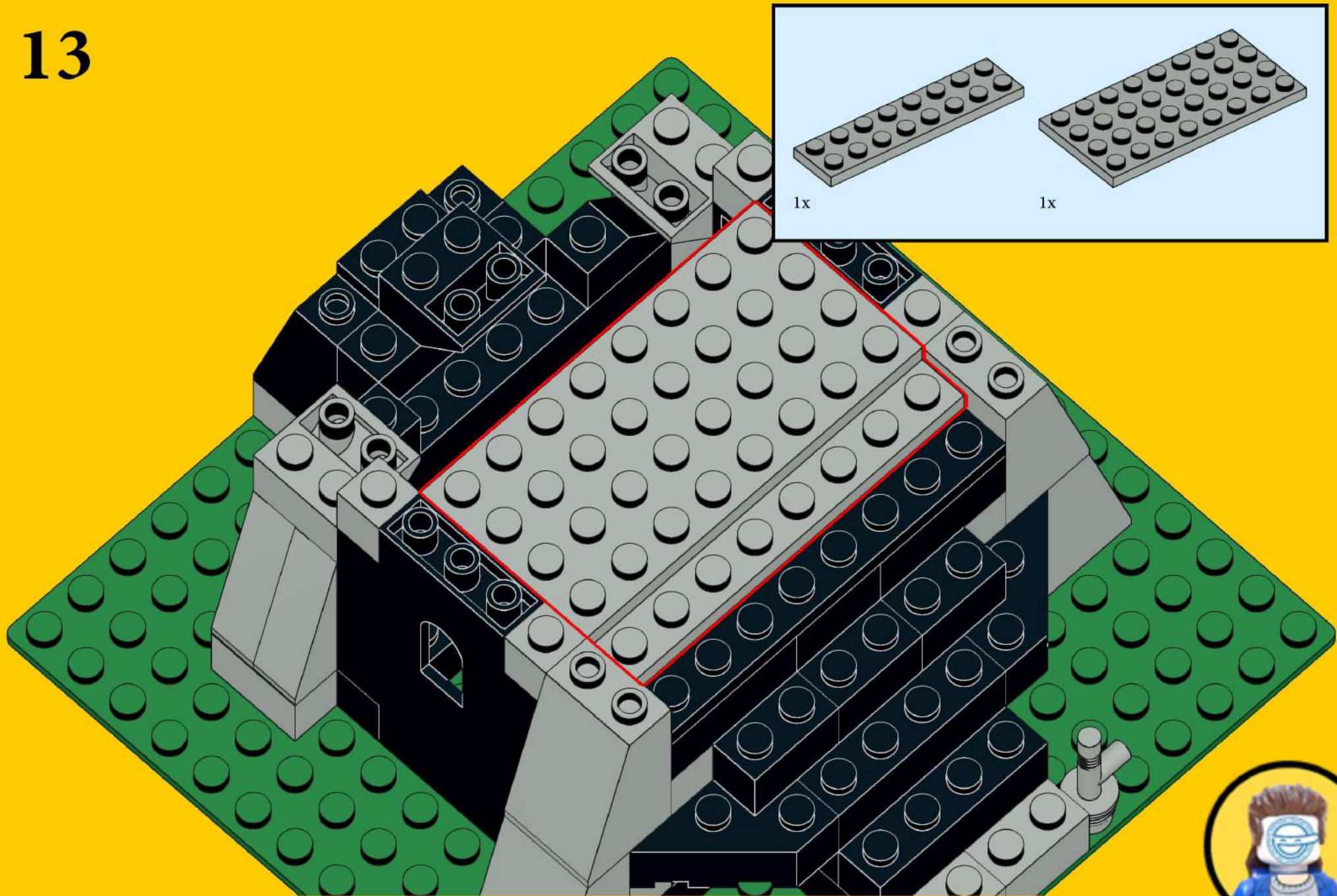

14

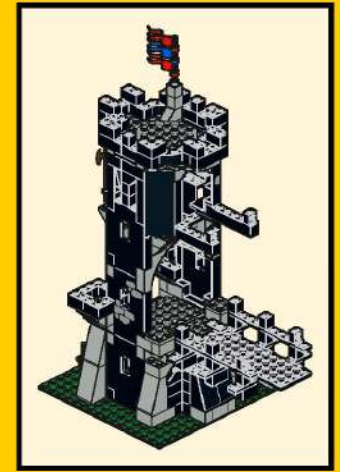
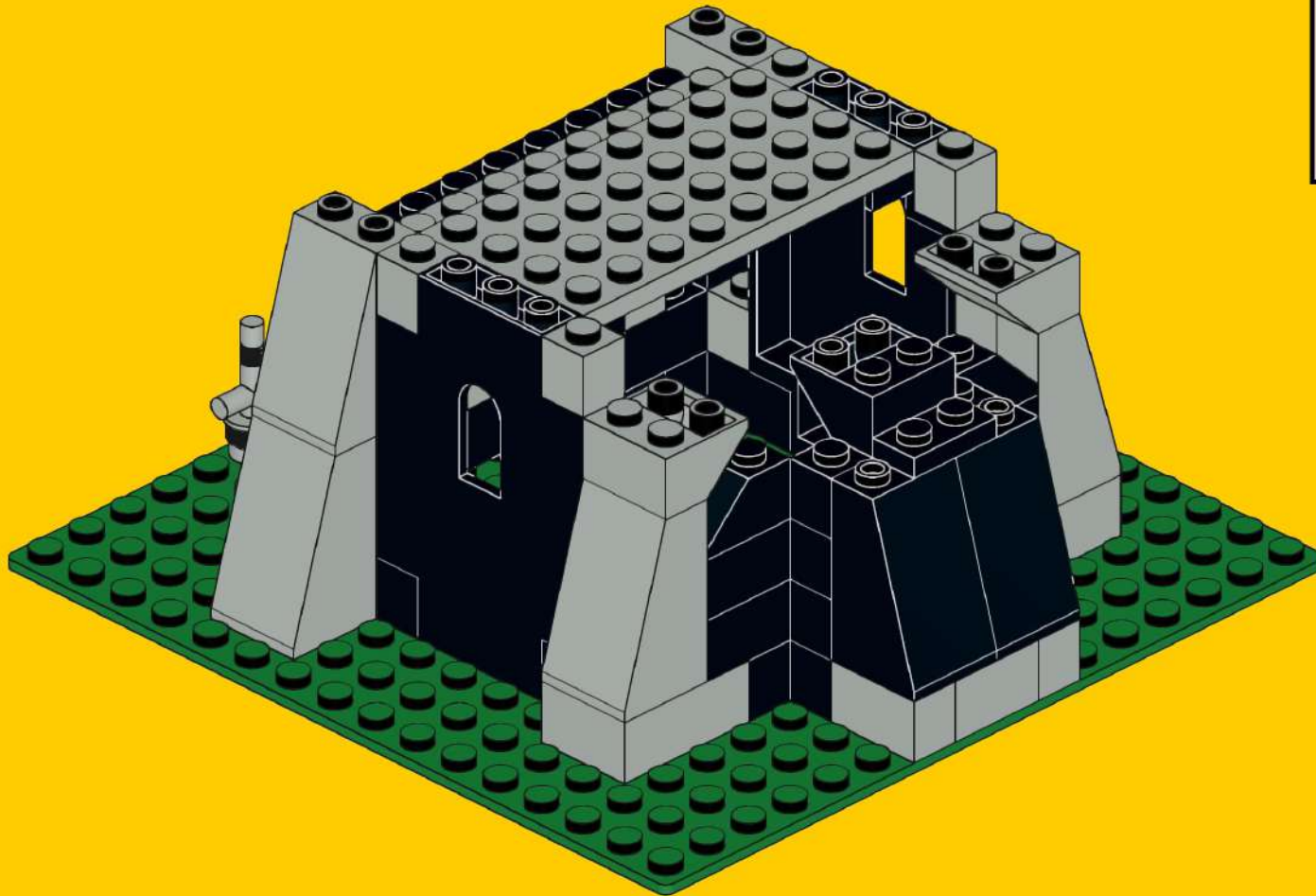



15

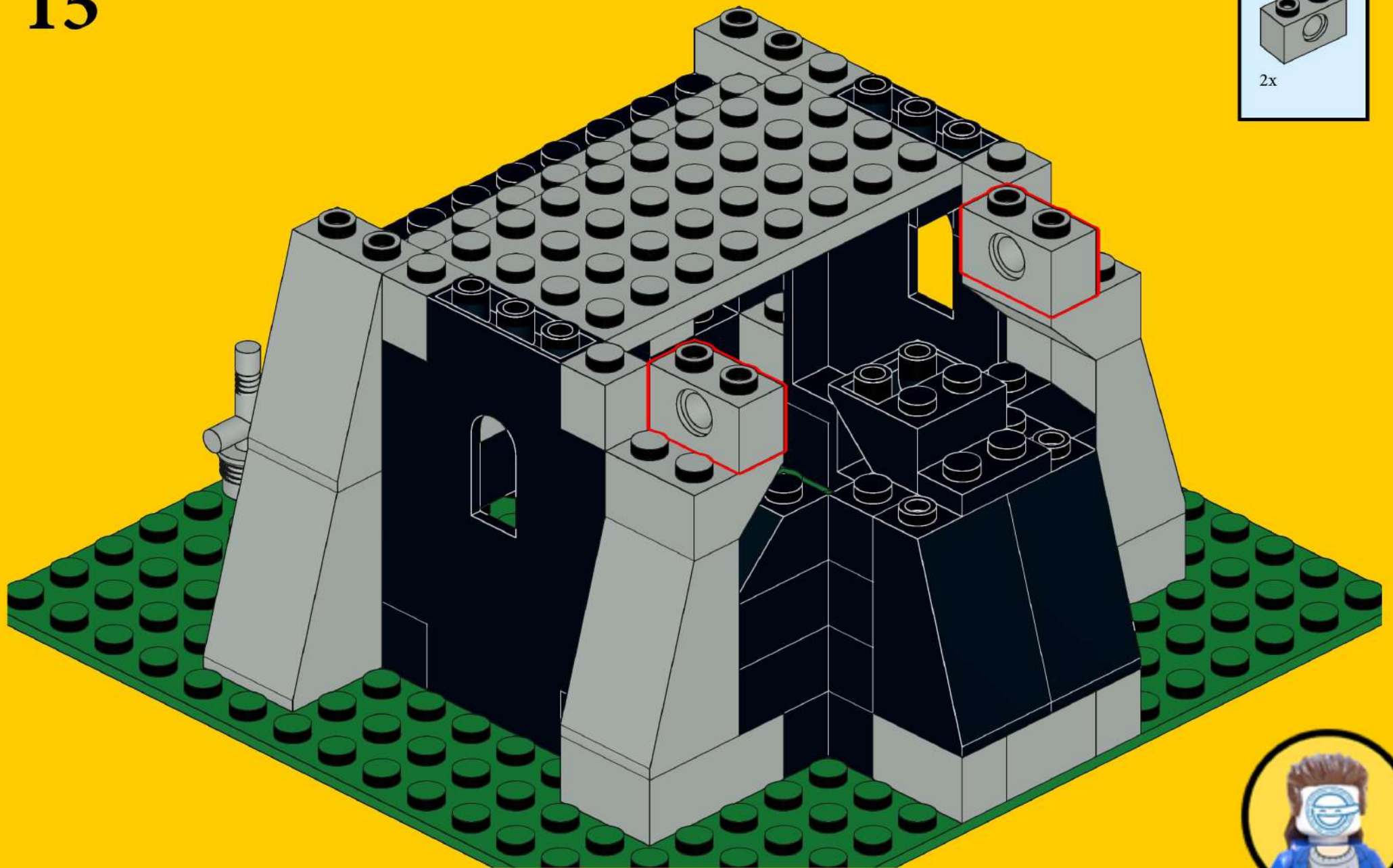
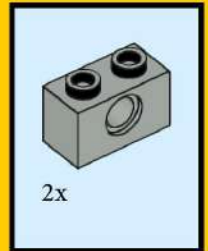

16

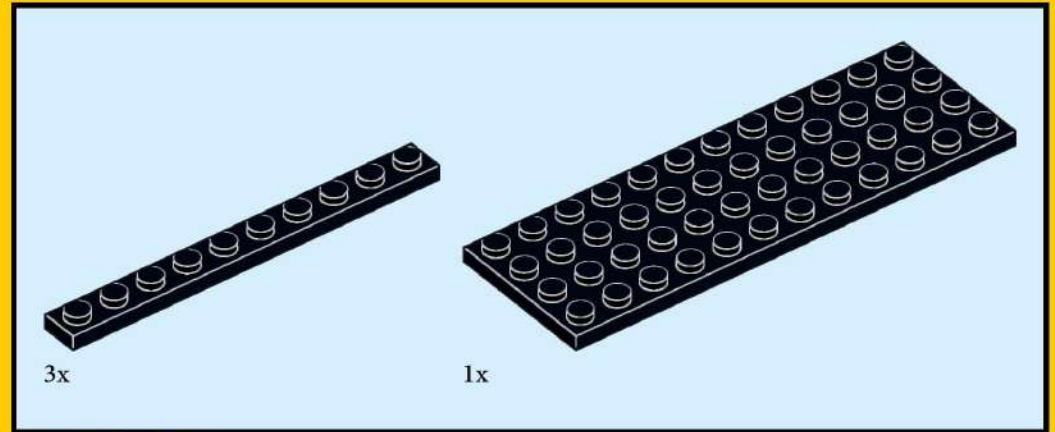
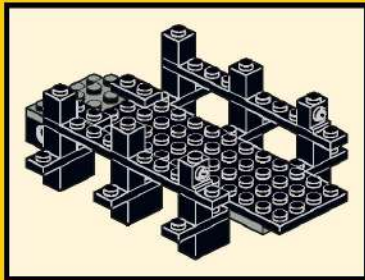

17

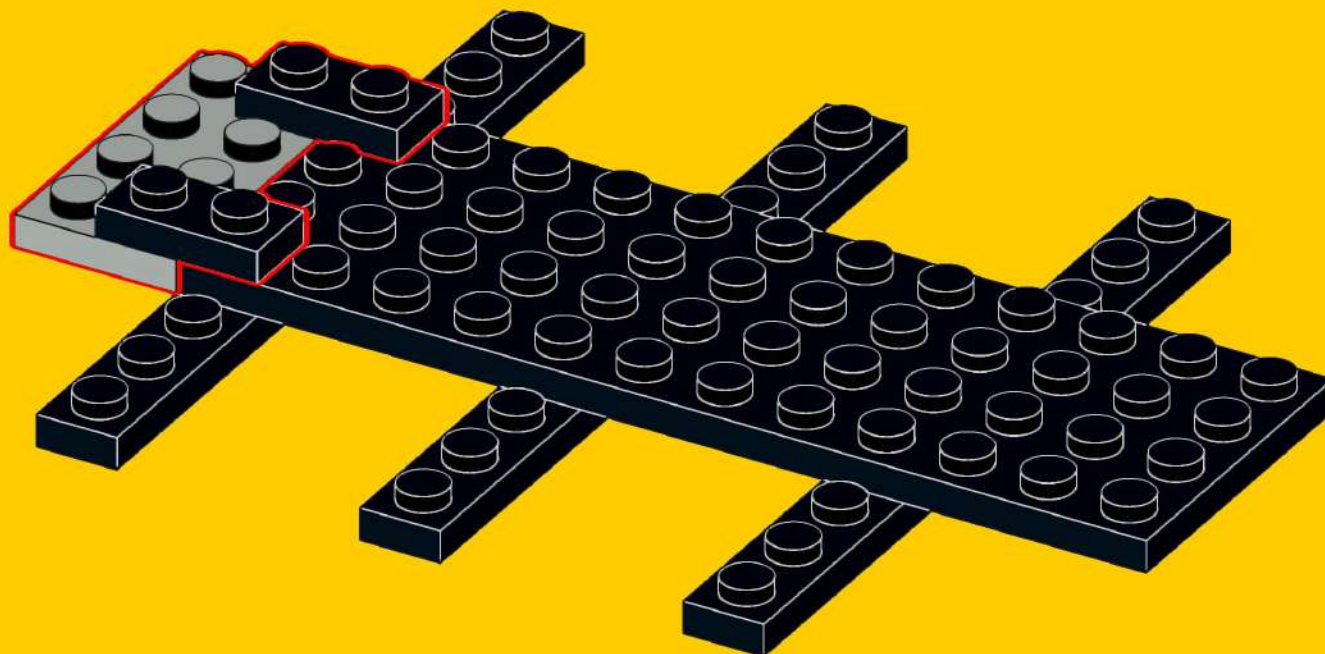
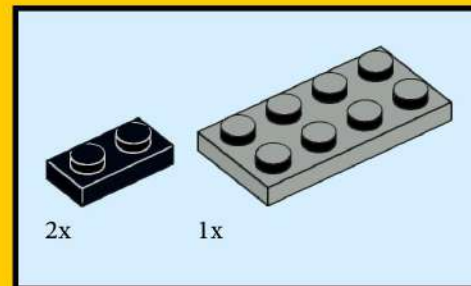

18

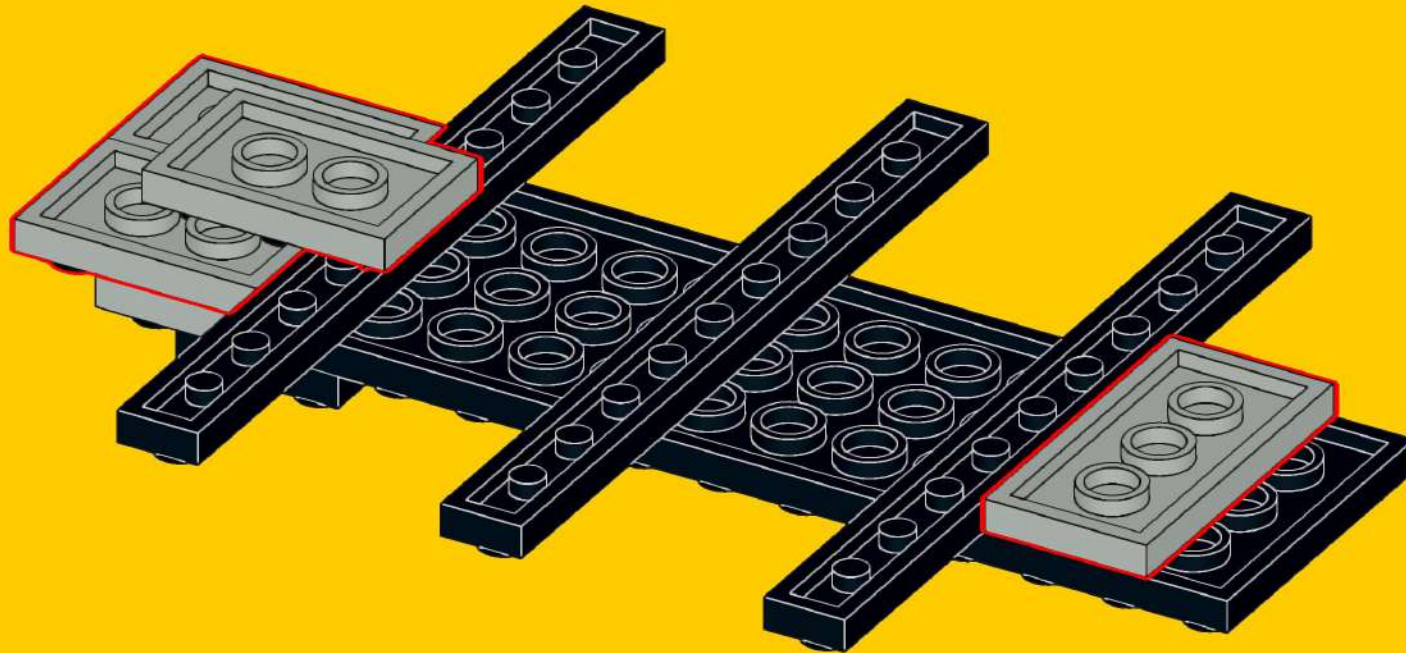
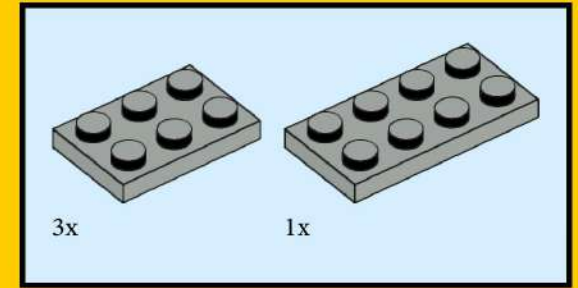

# 19

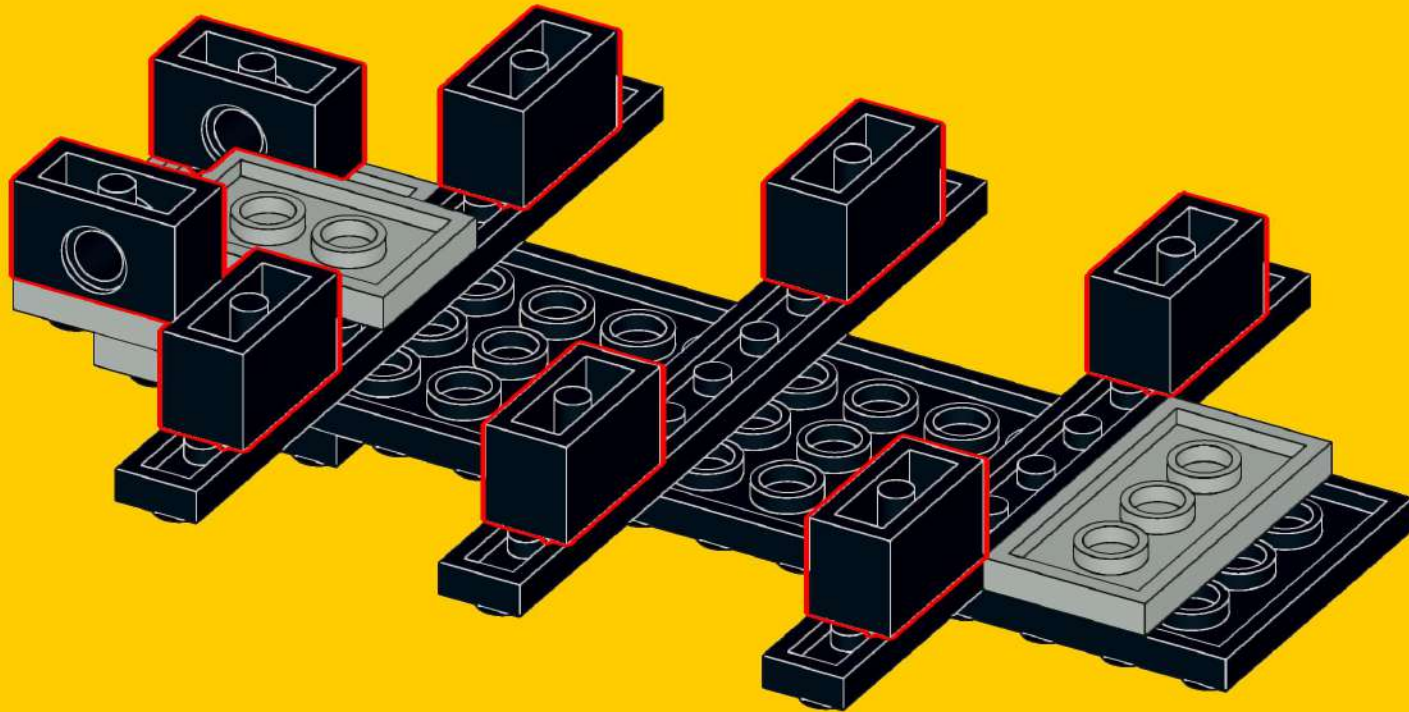
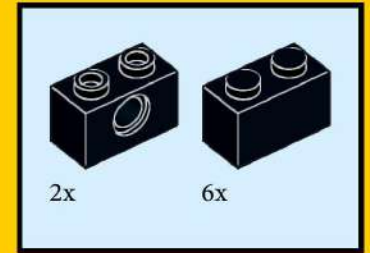

20

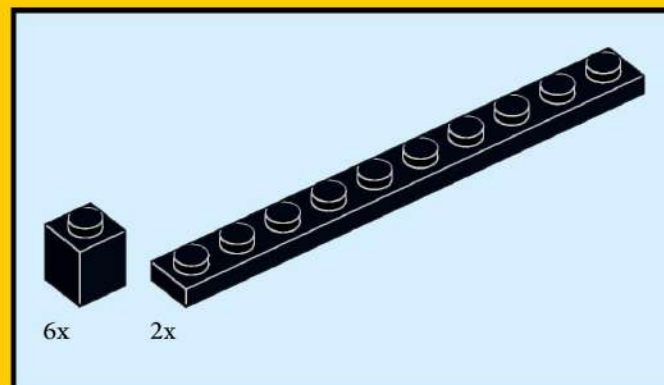

21

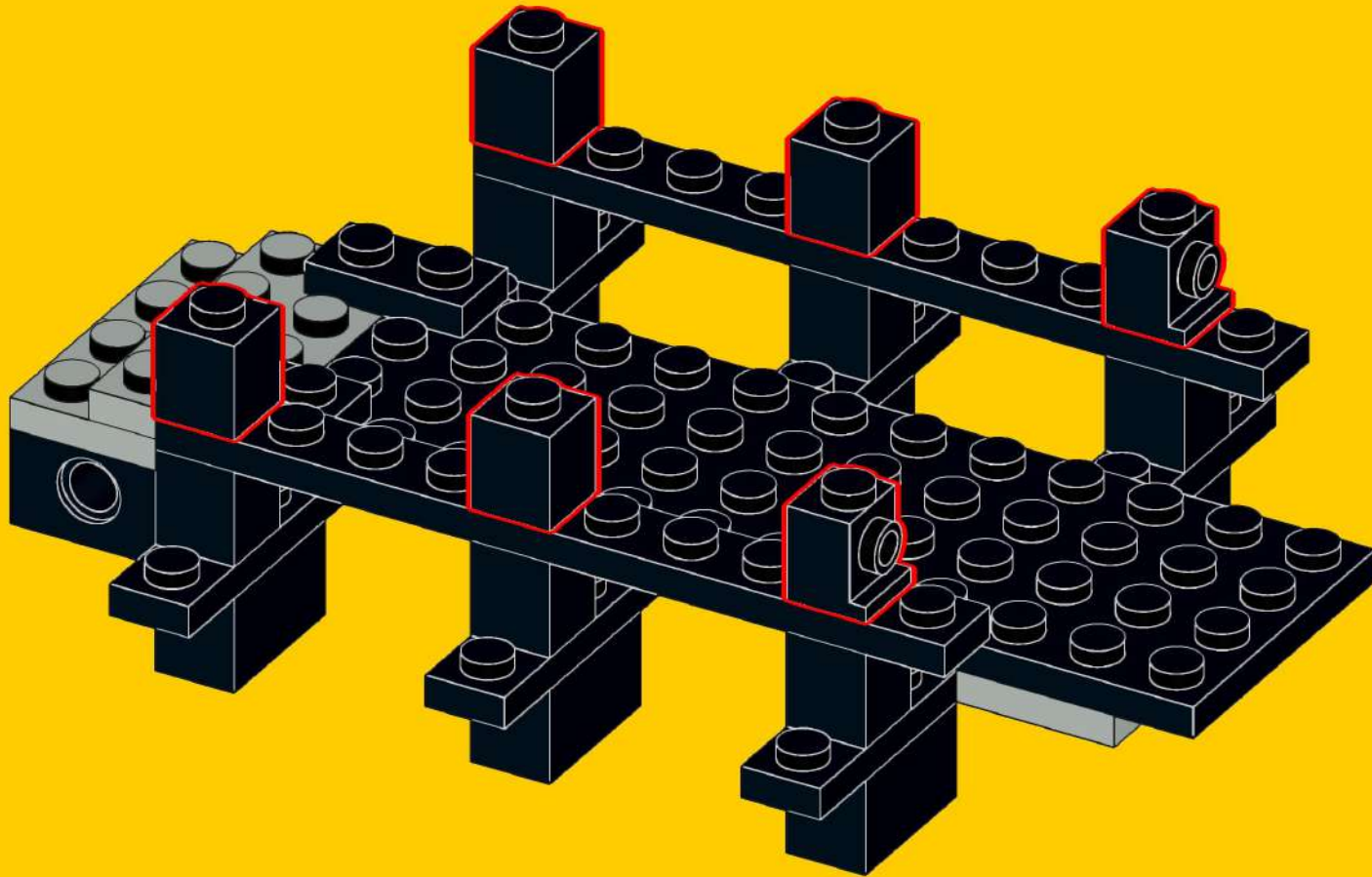
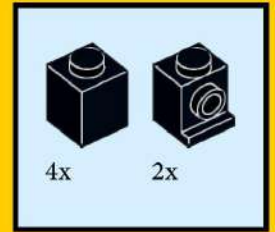

22

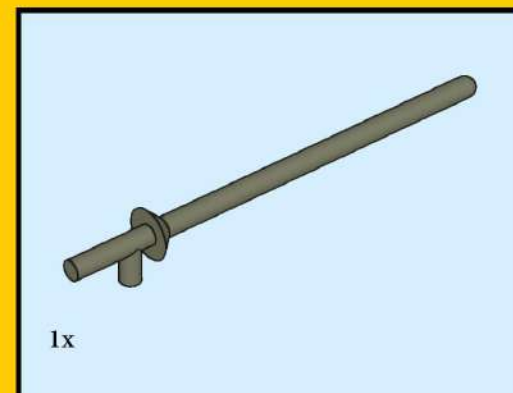
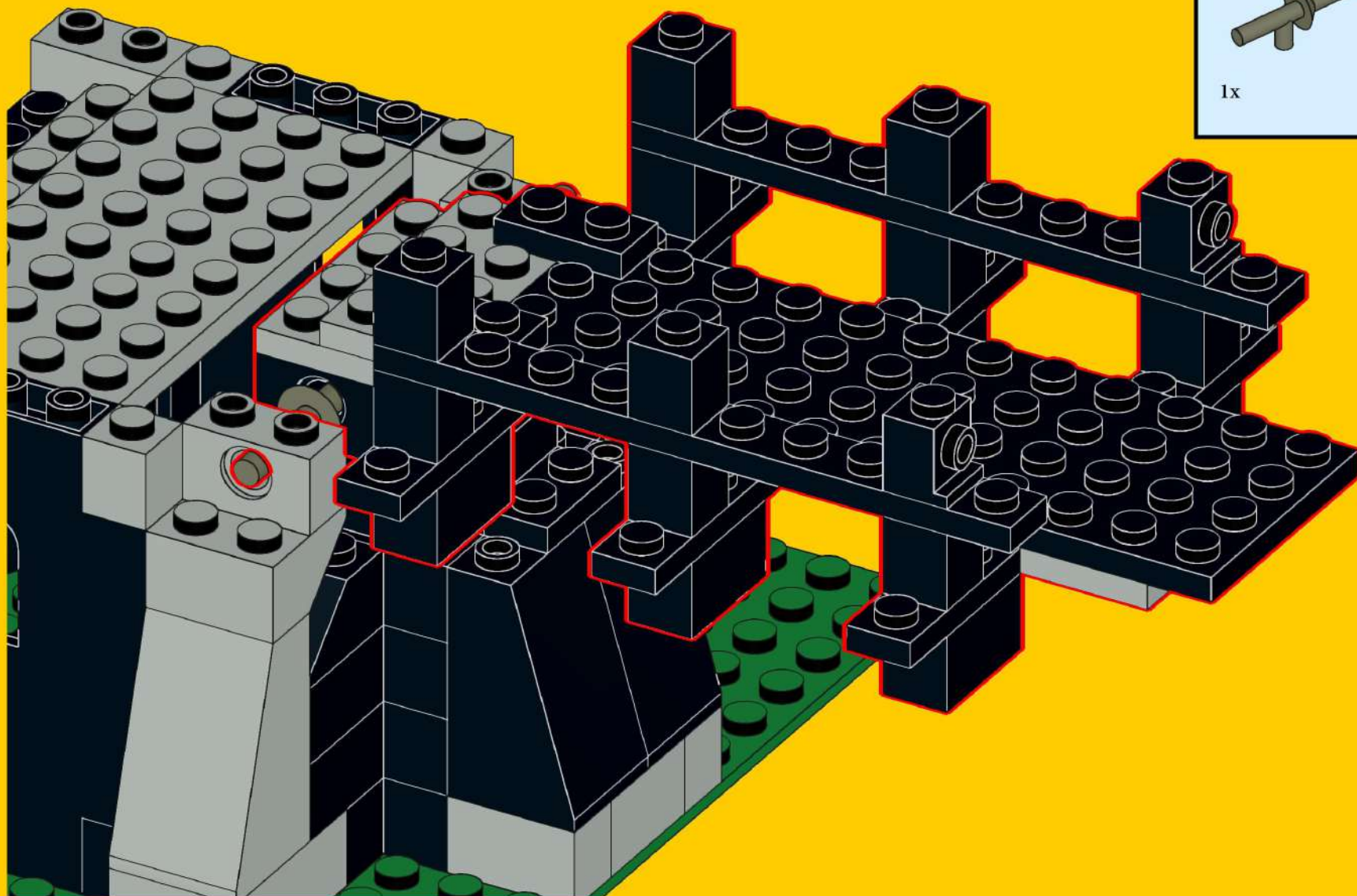



23

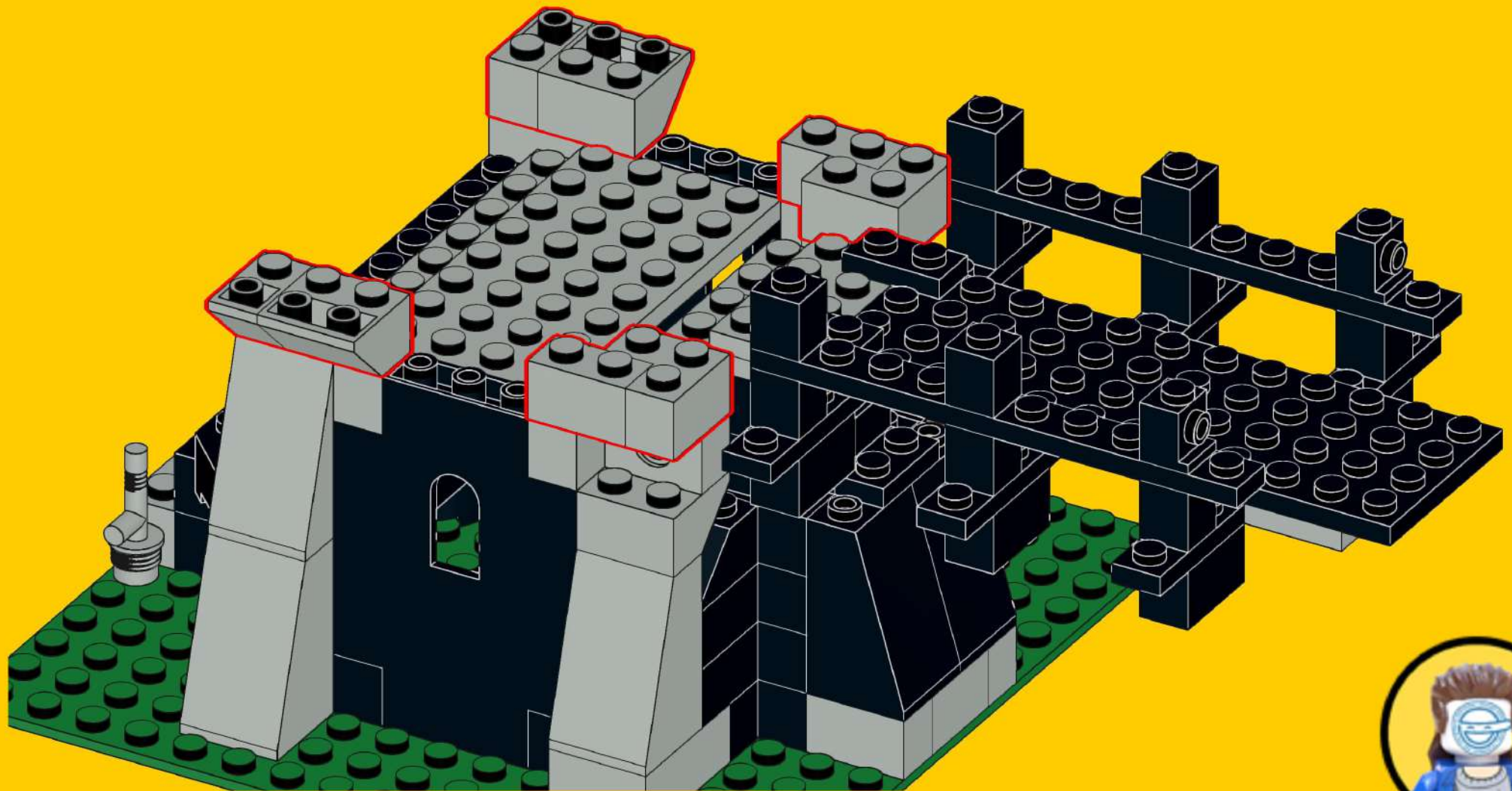
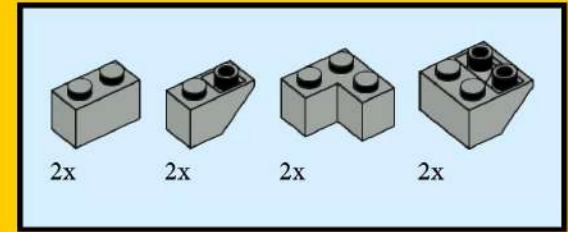

24

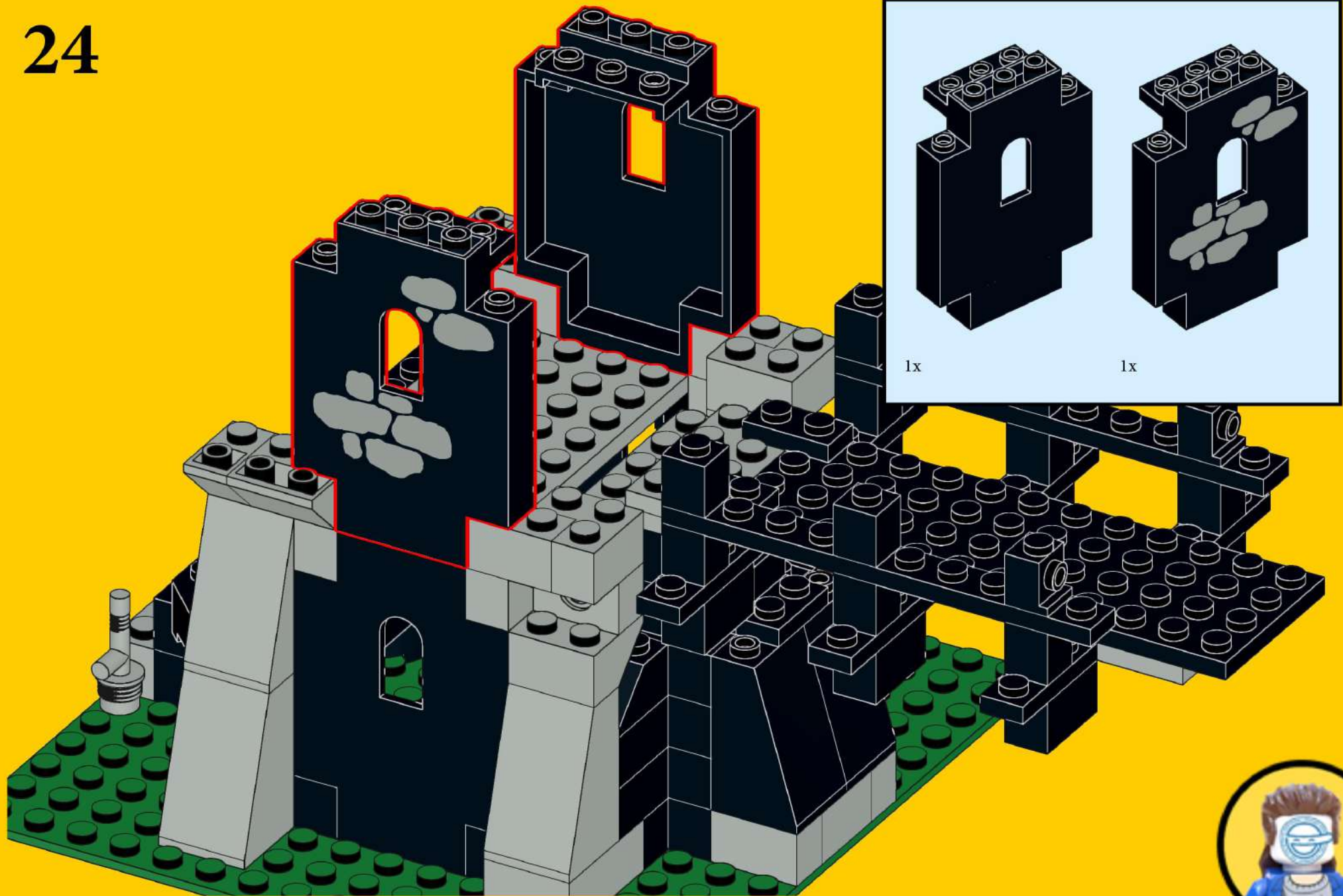

25

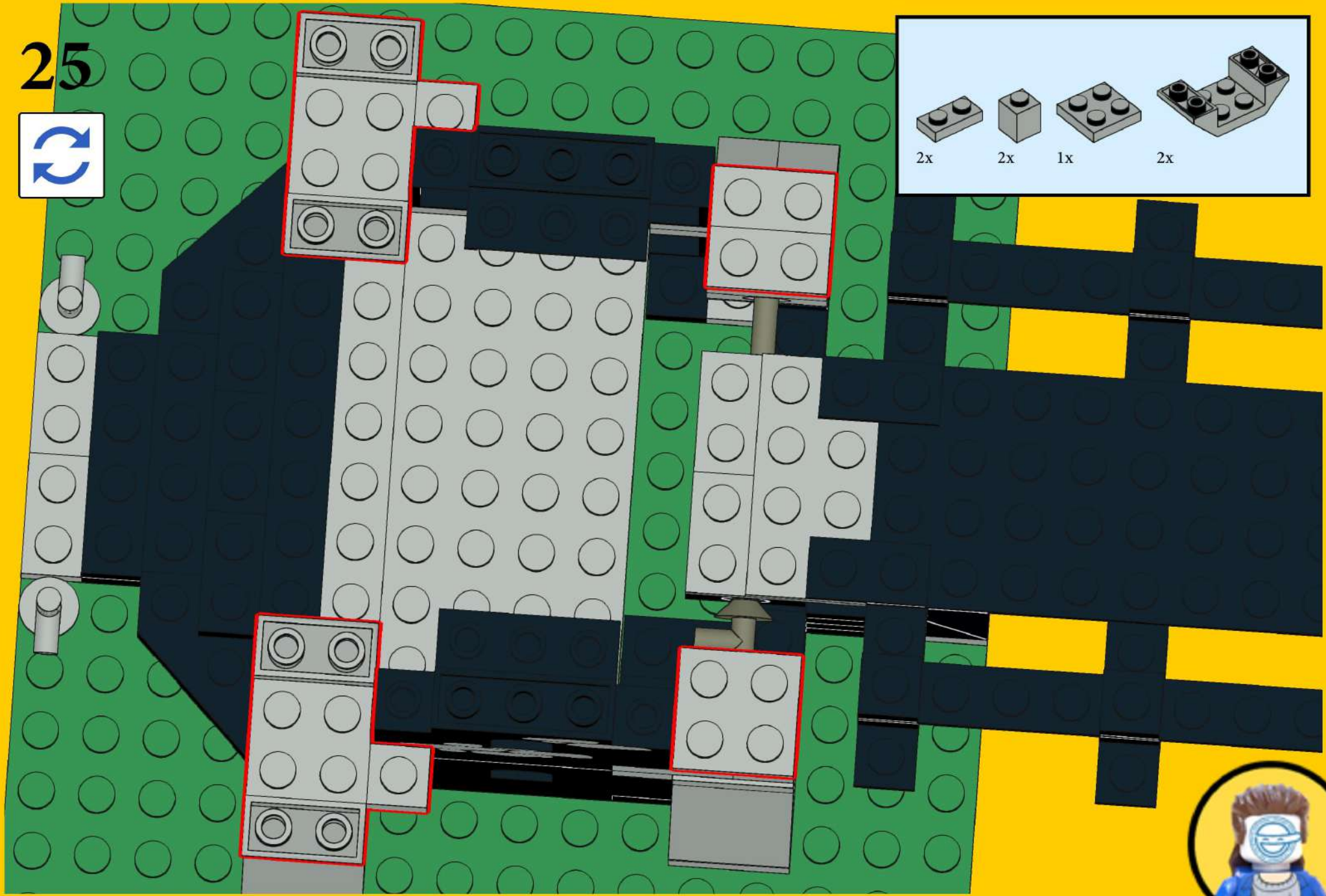

# 26

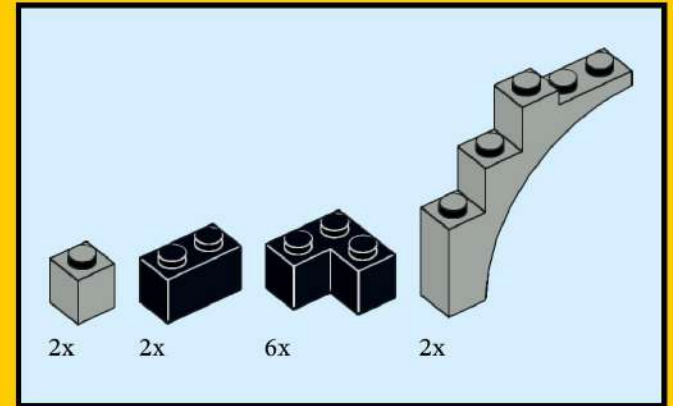
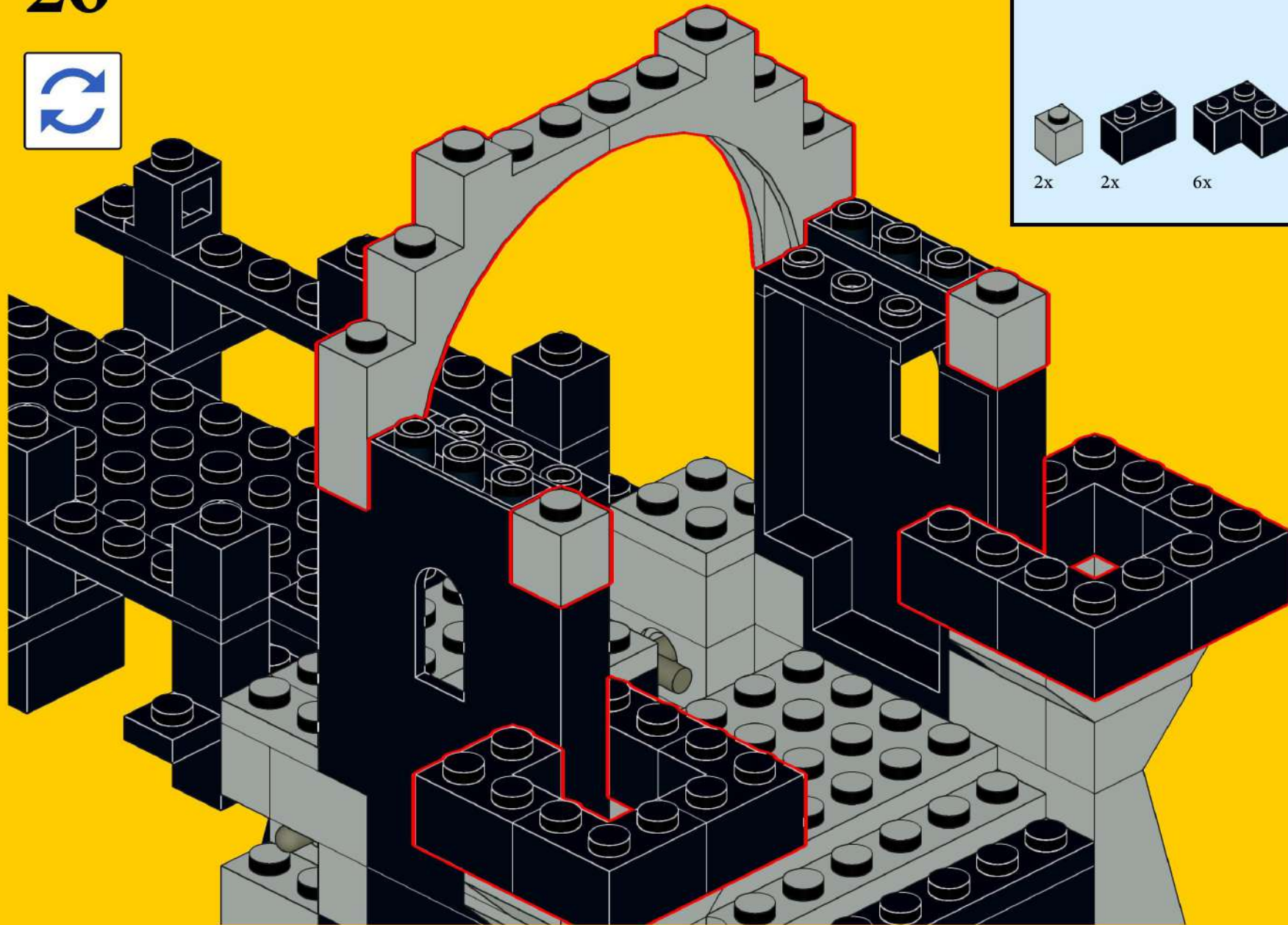

27

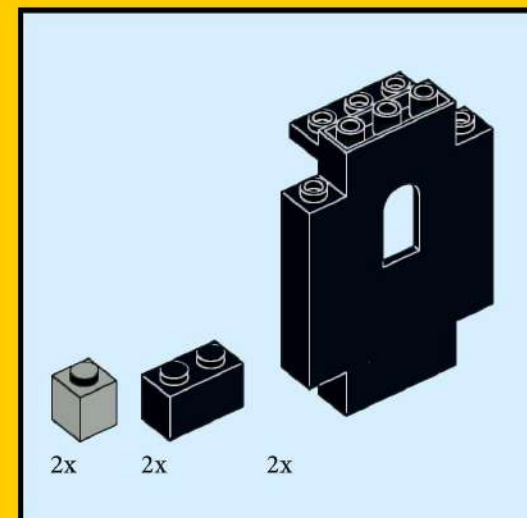
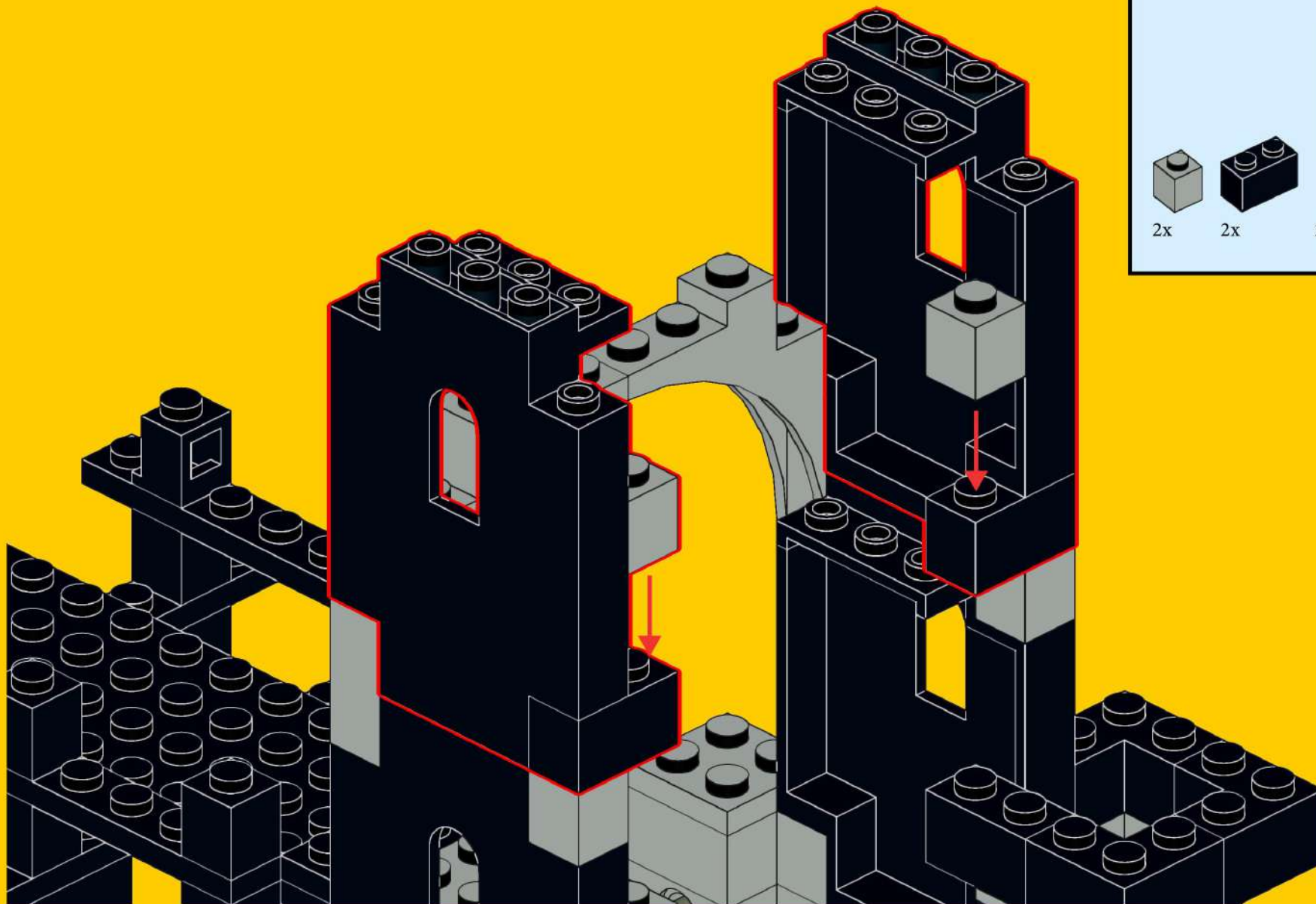

28

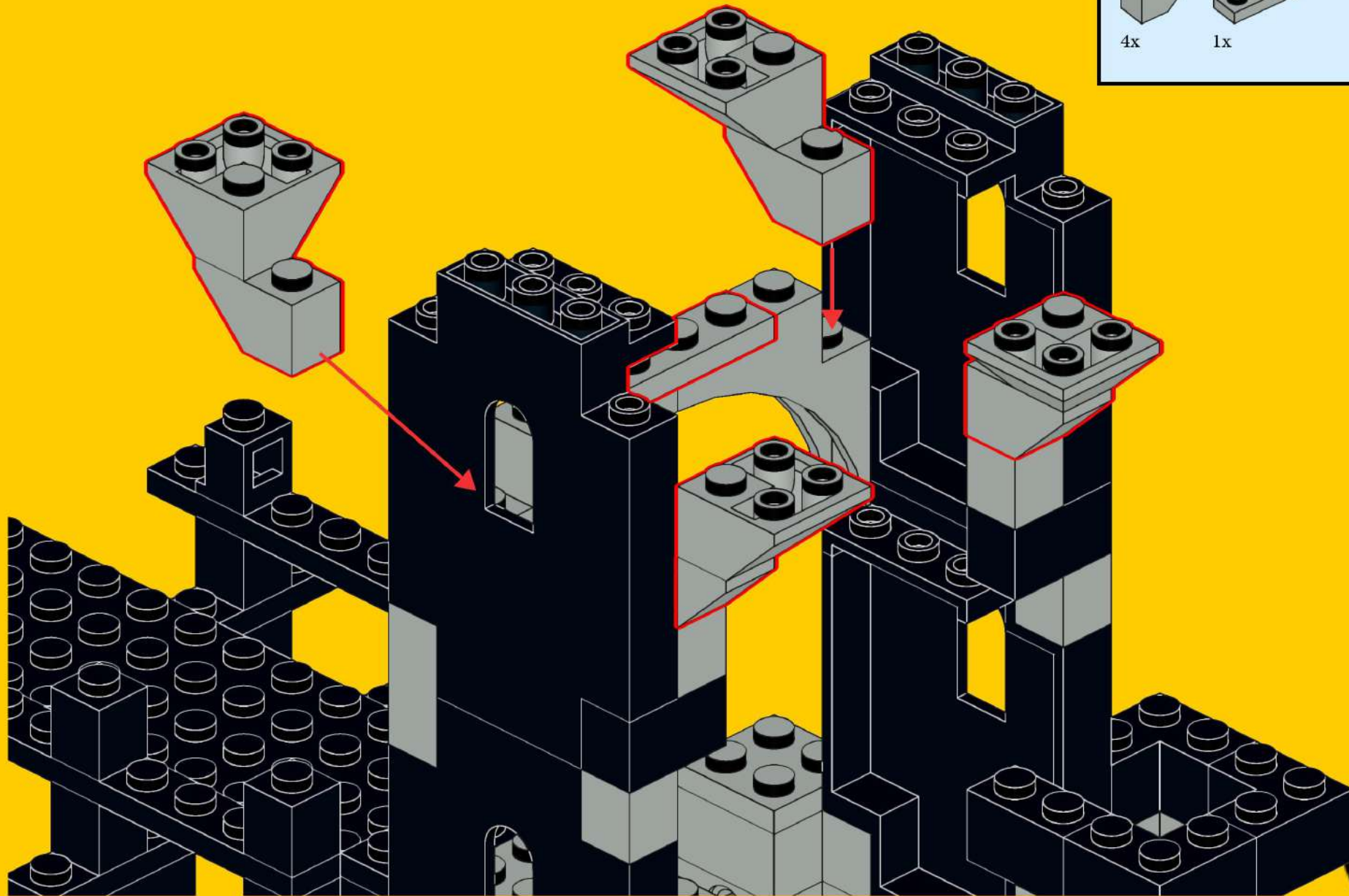
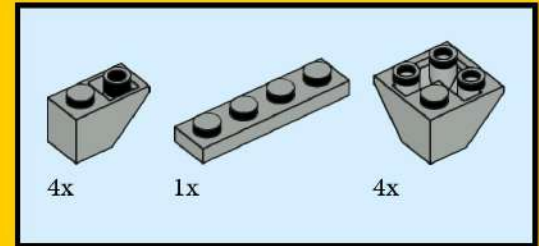

29

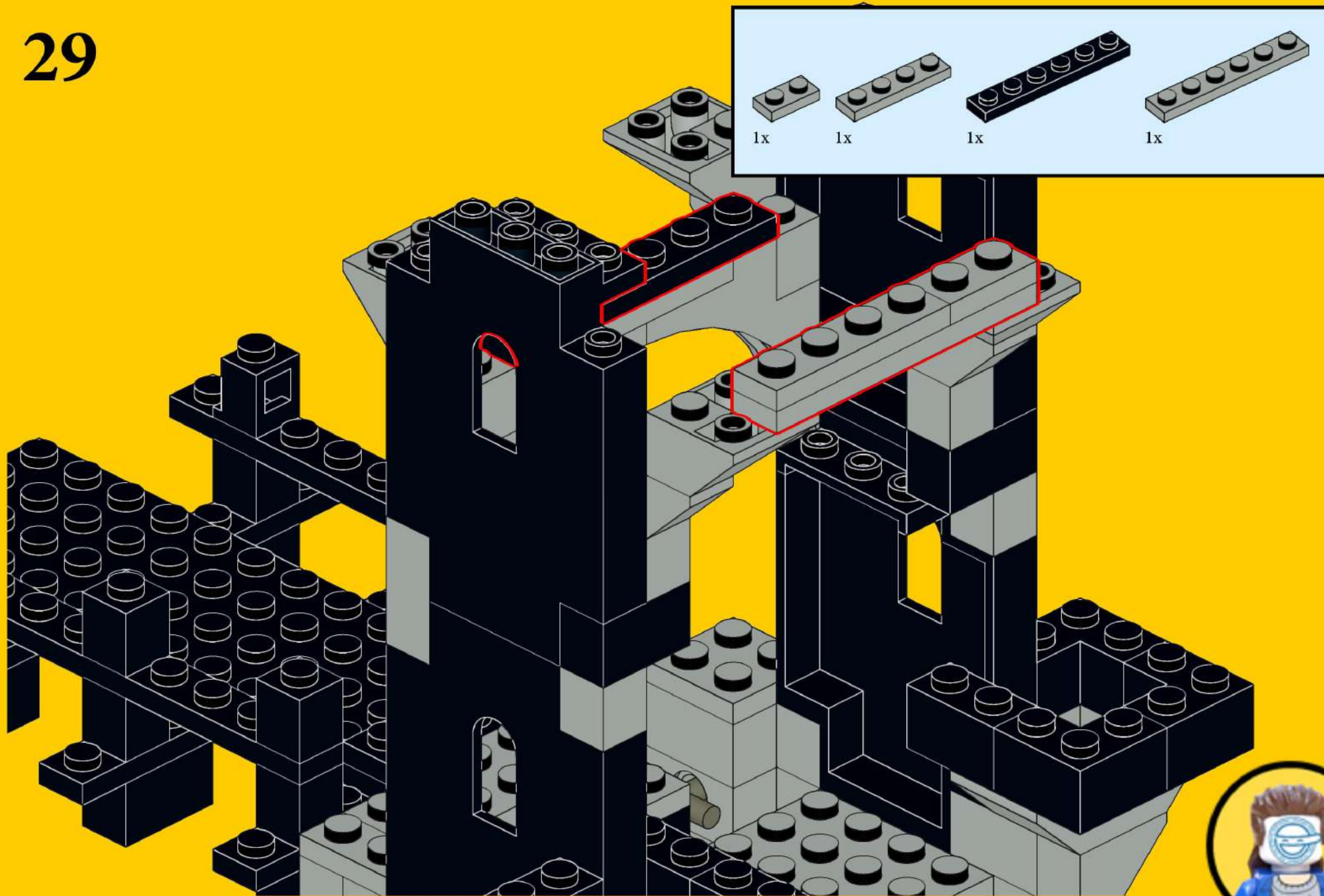

30

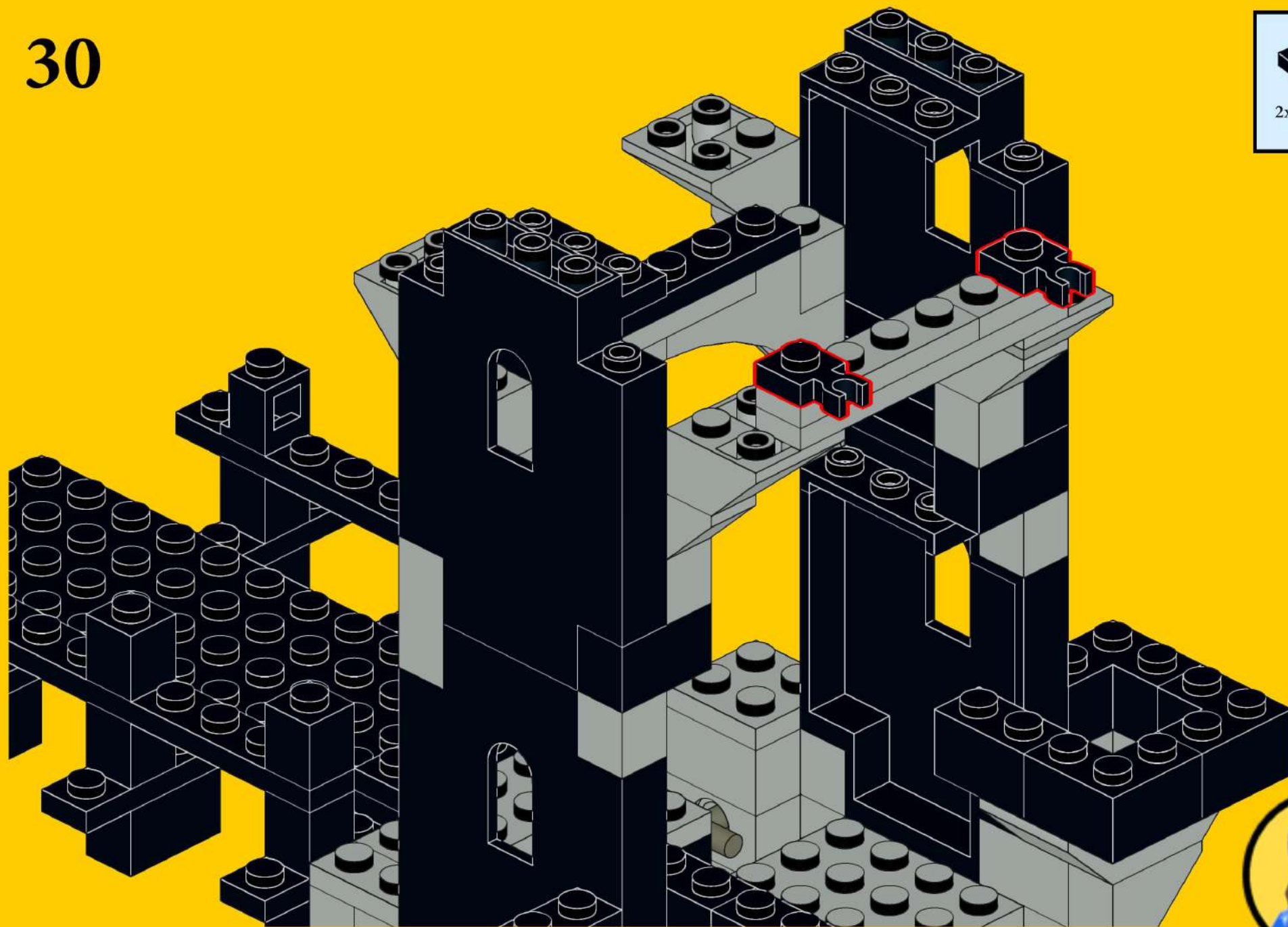
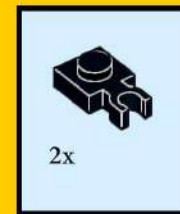



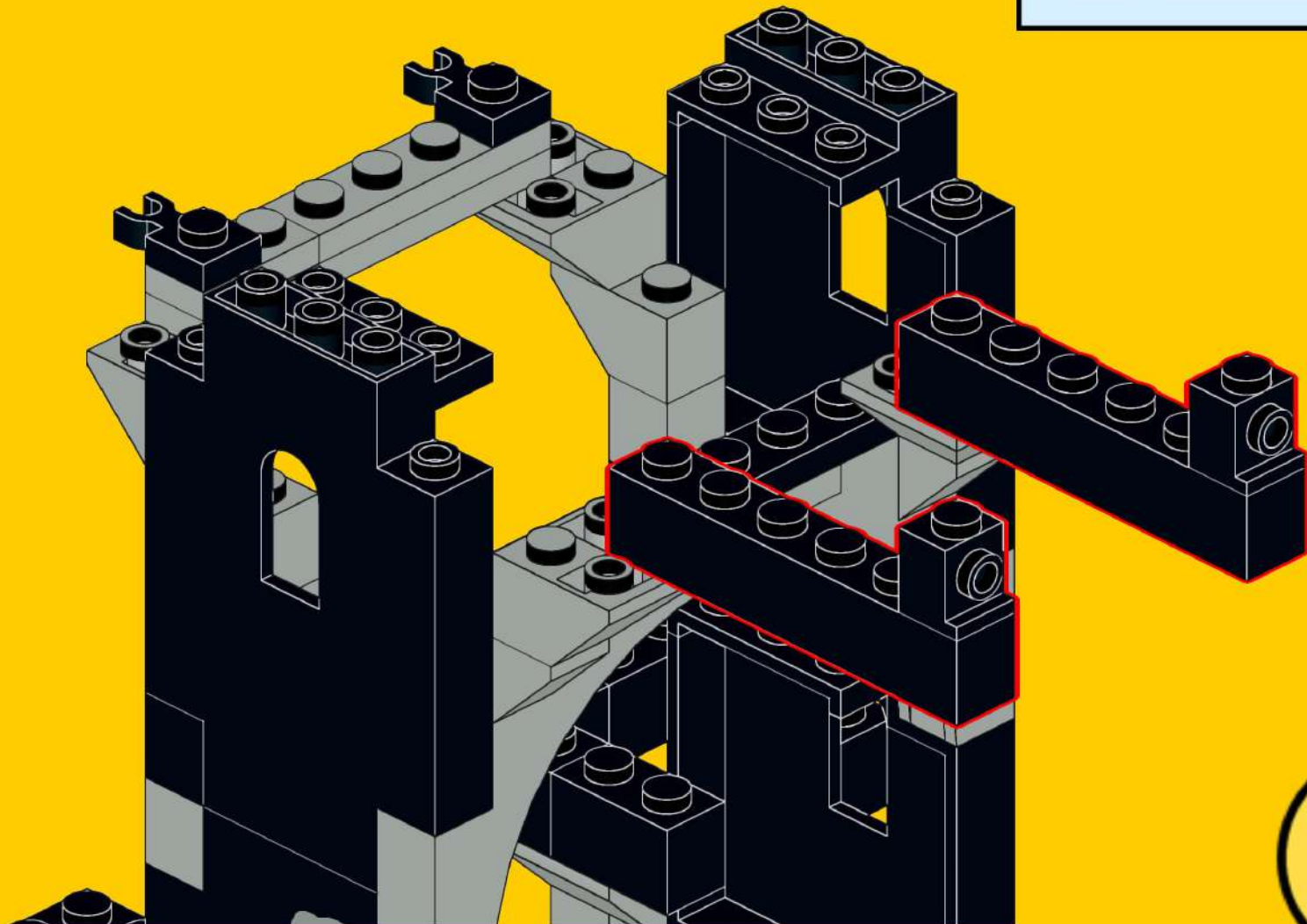
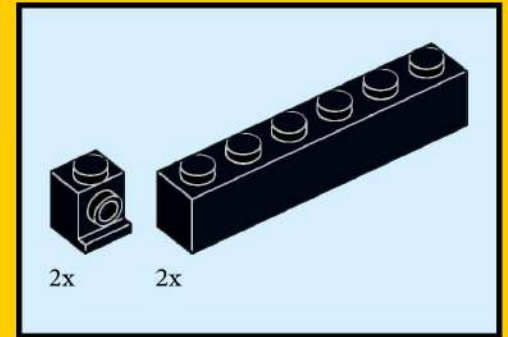

32

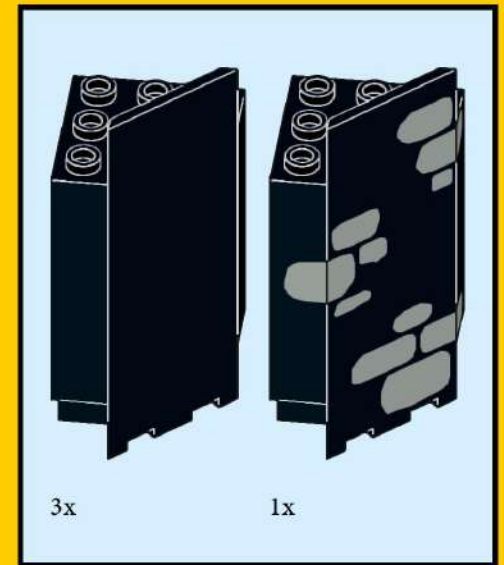
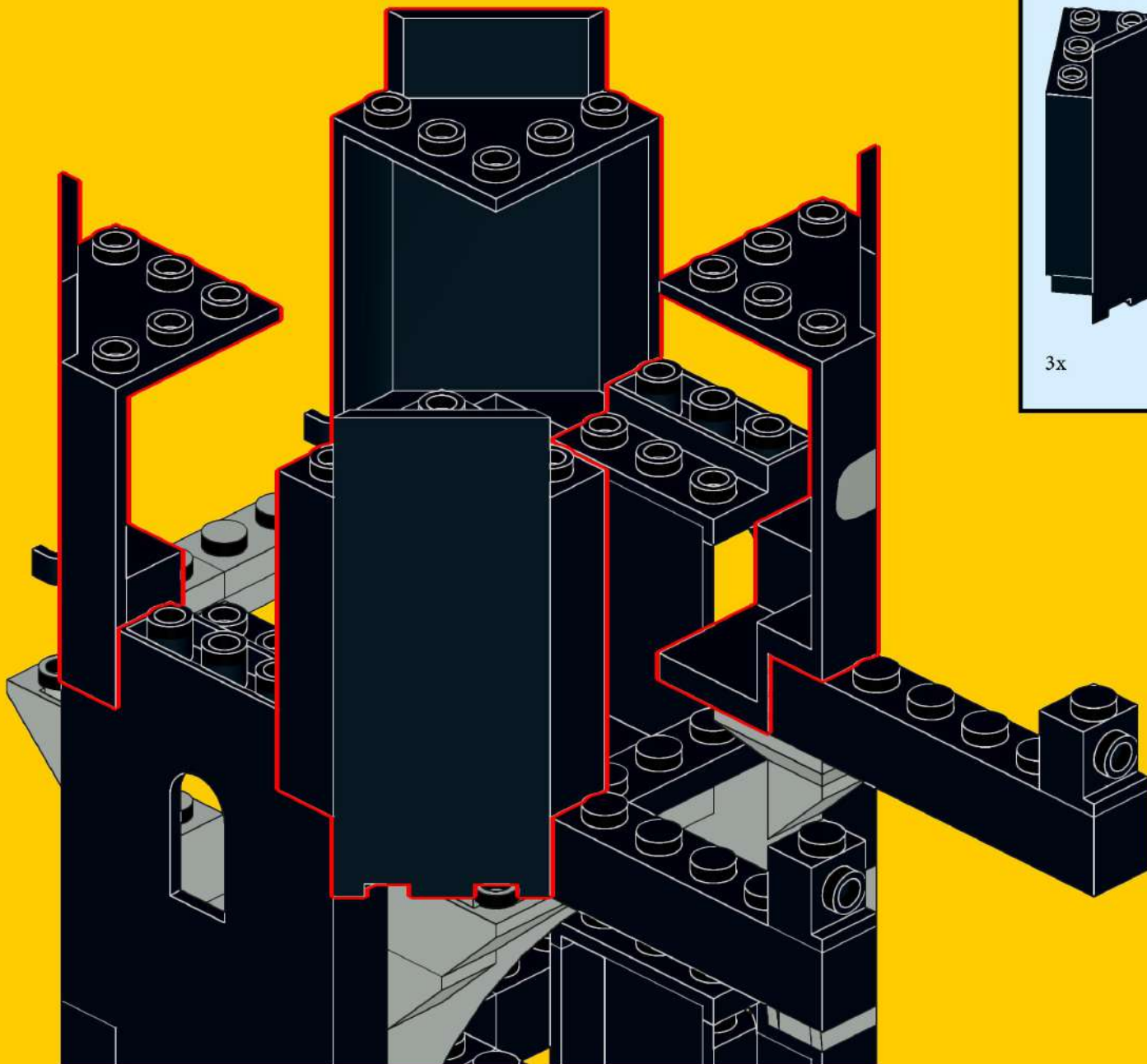

33

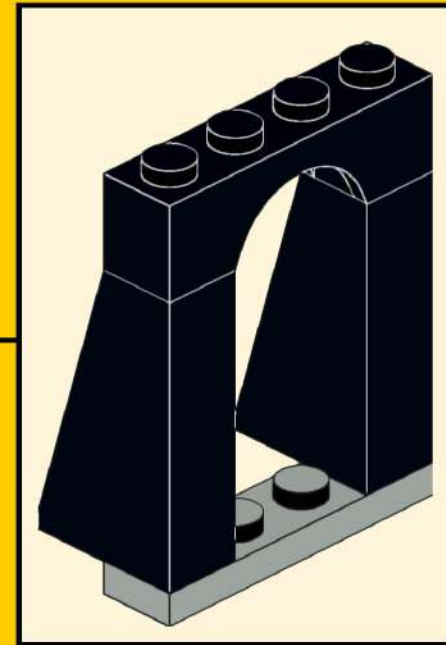
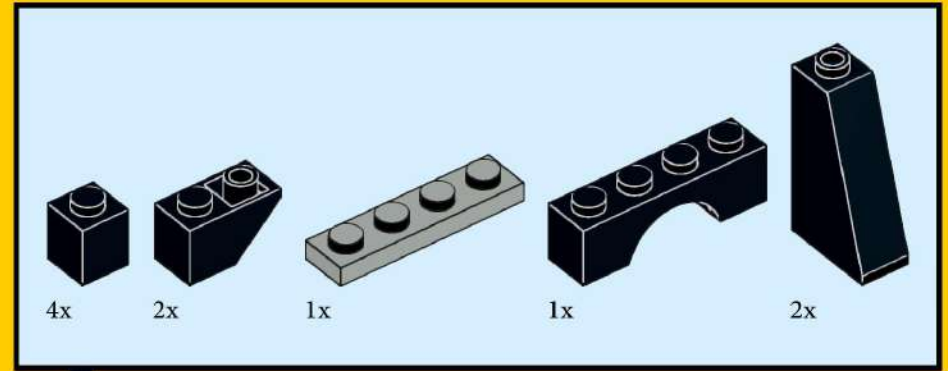
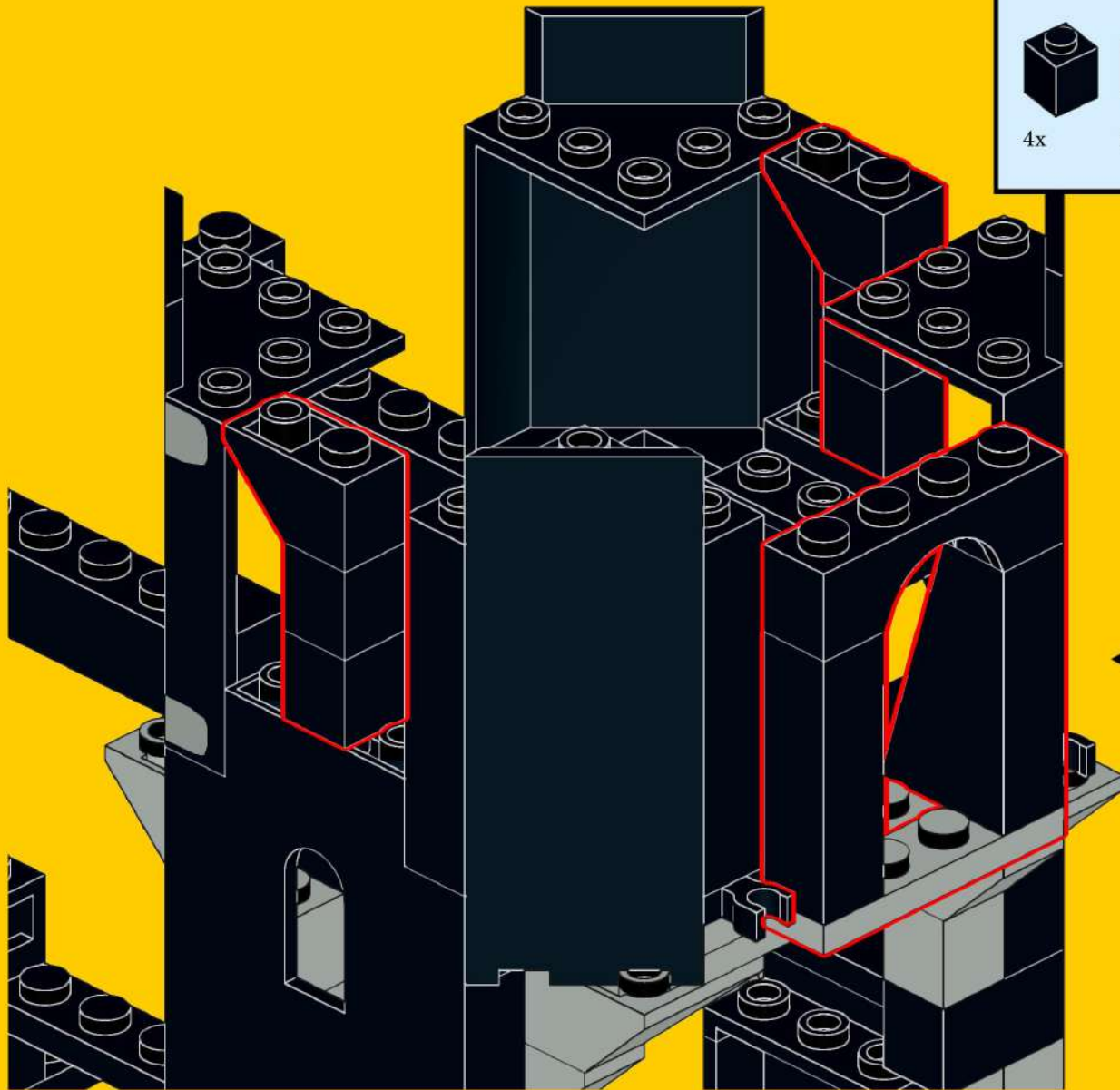

34

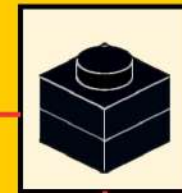
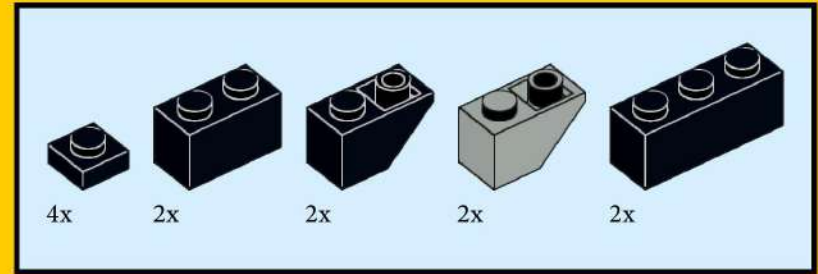
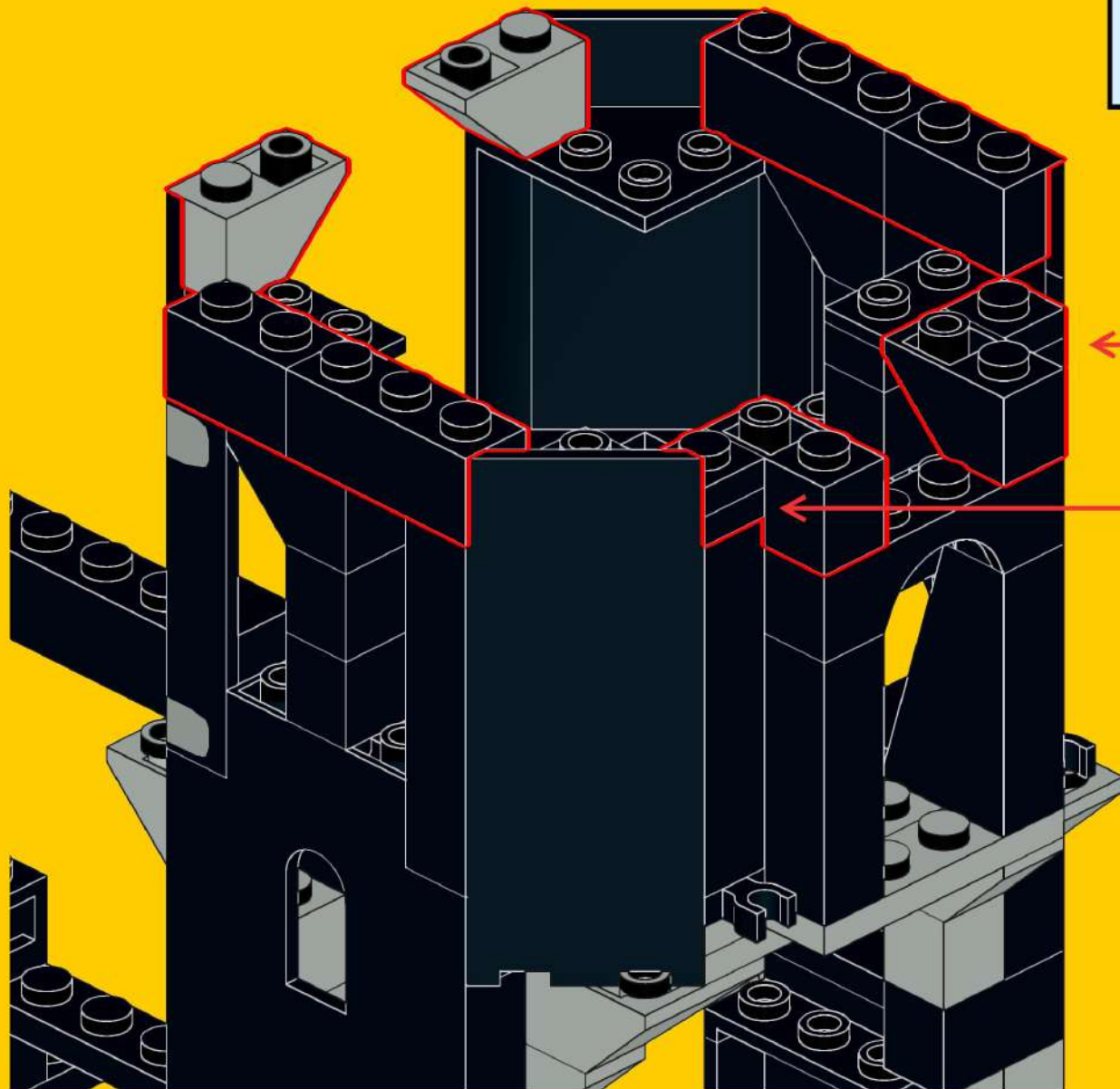

2x



35

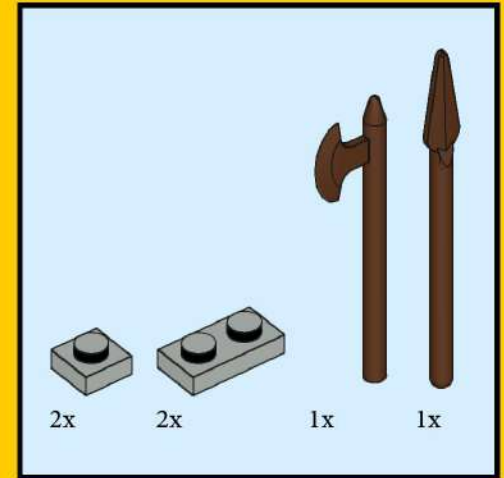
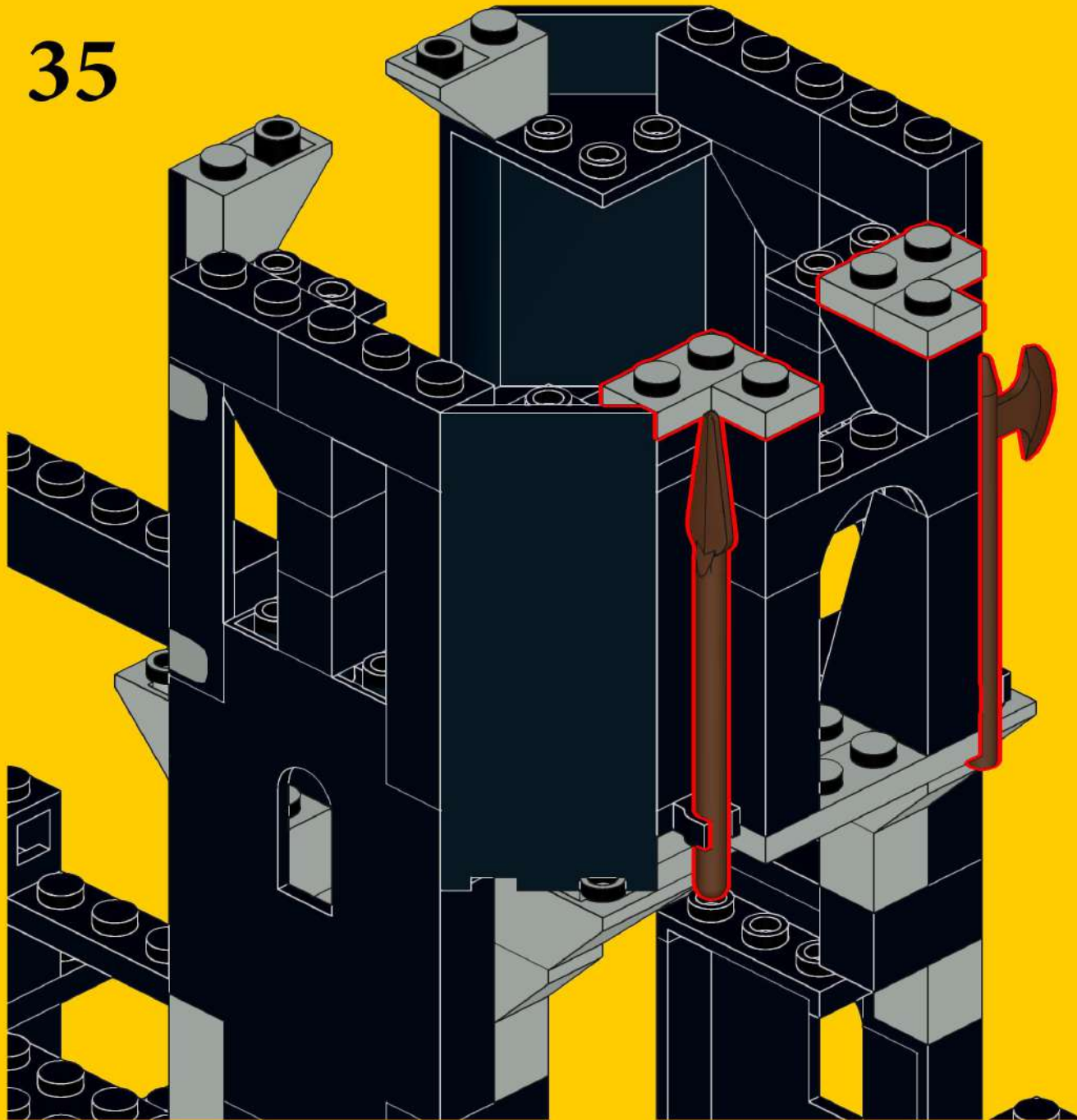

36

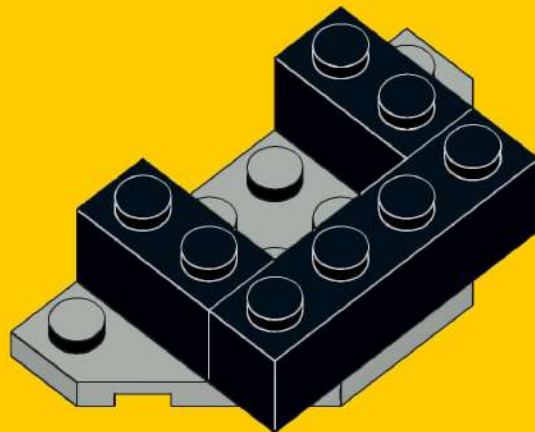
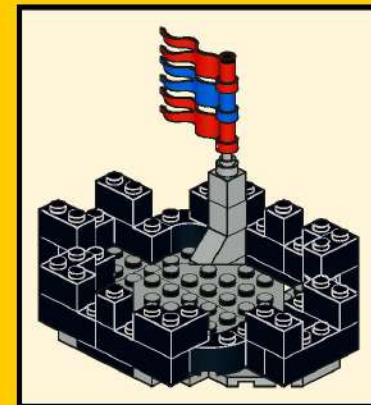
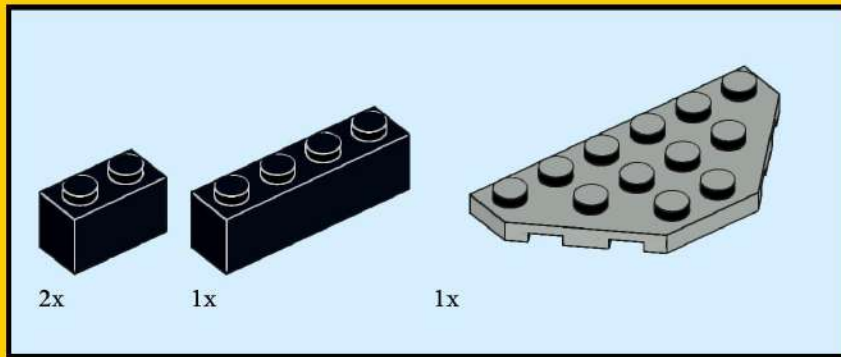

37

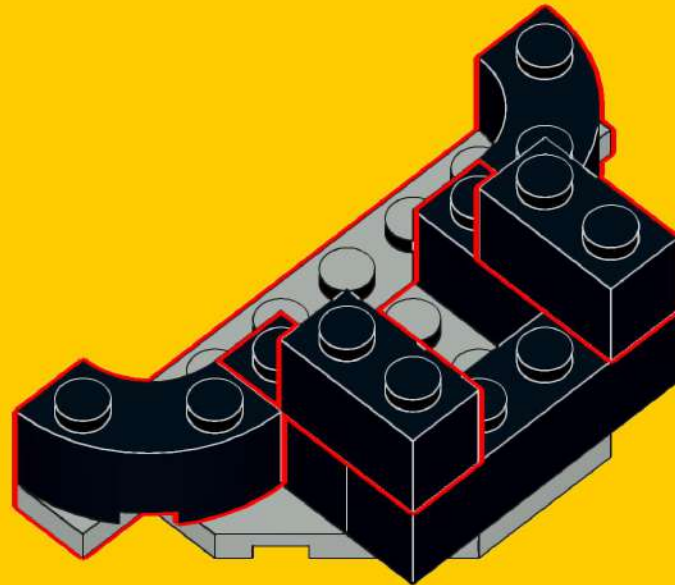
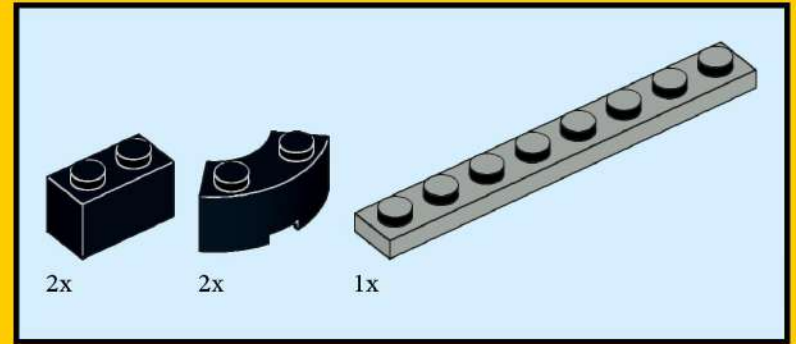

38

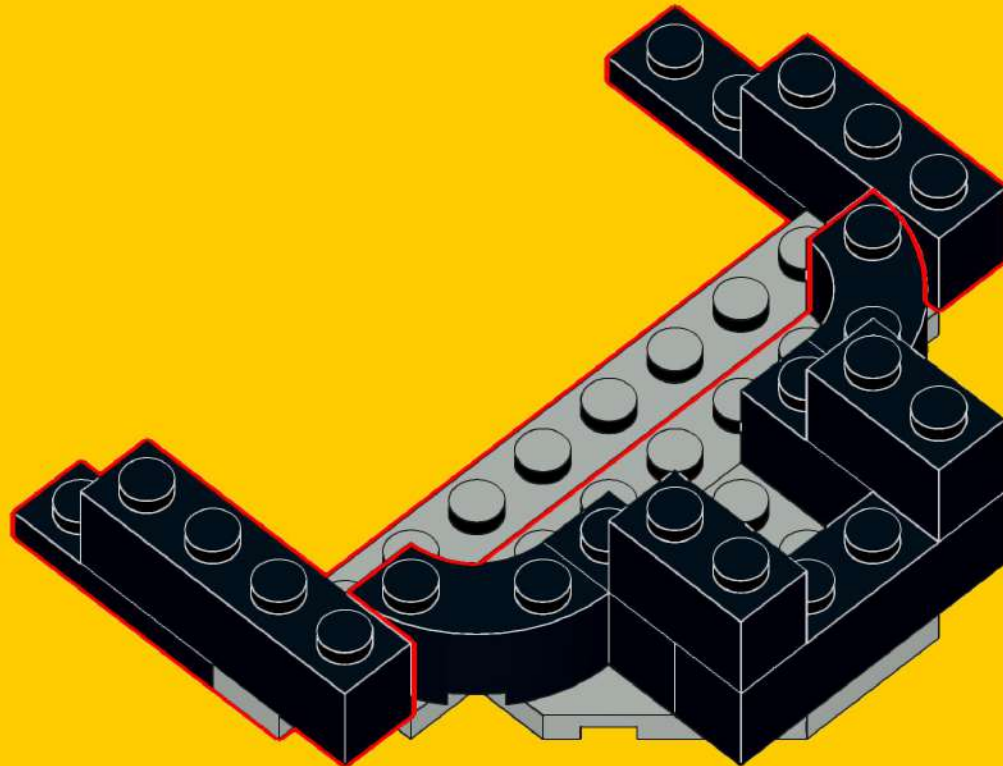
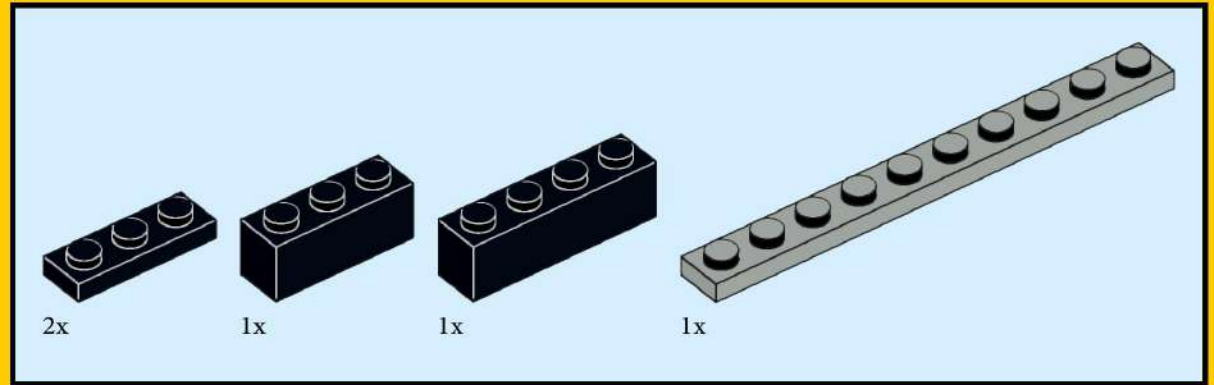



39

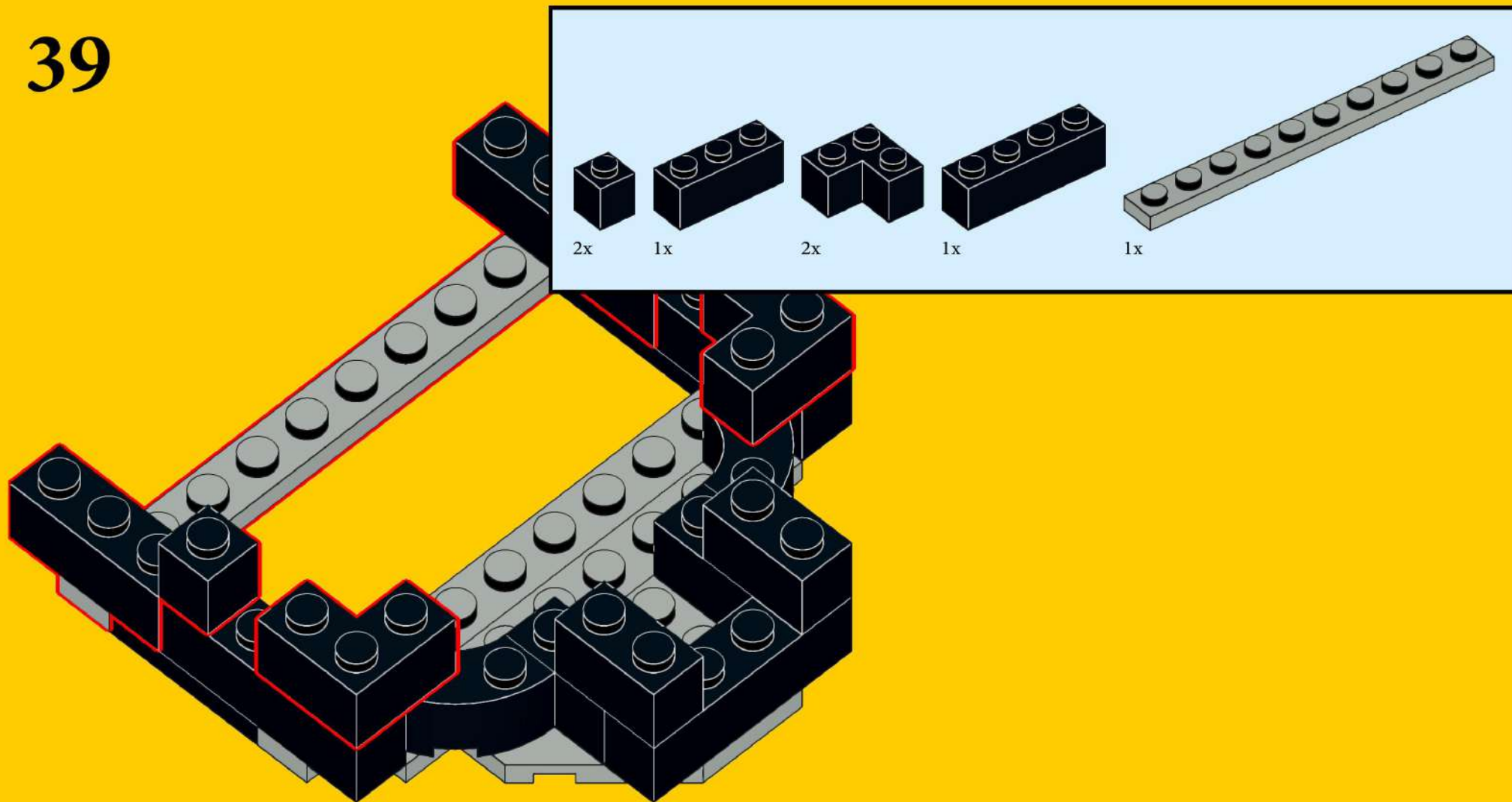

40

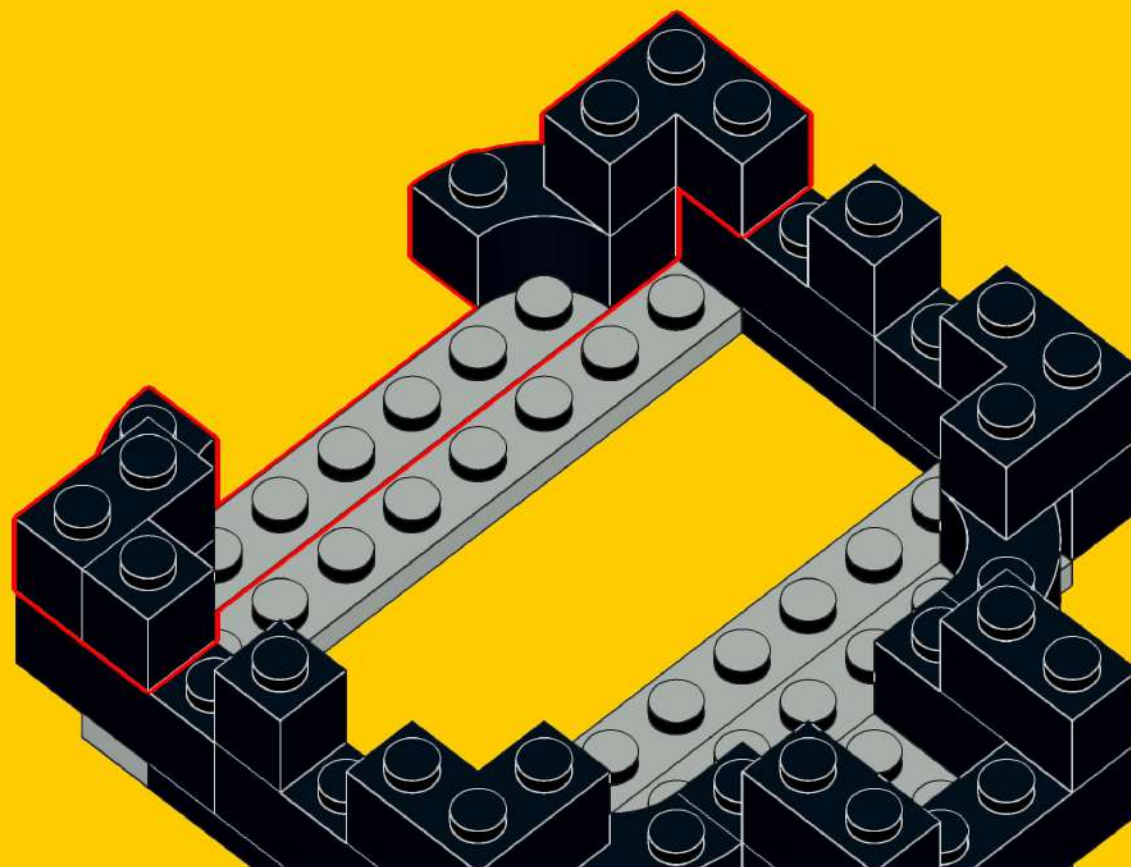
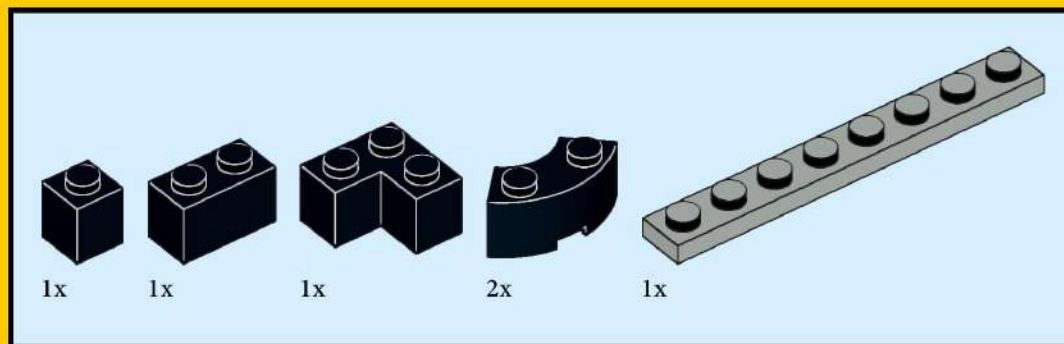

# 41

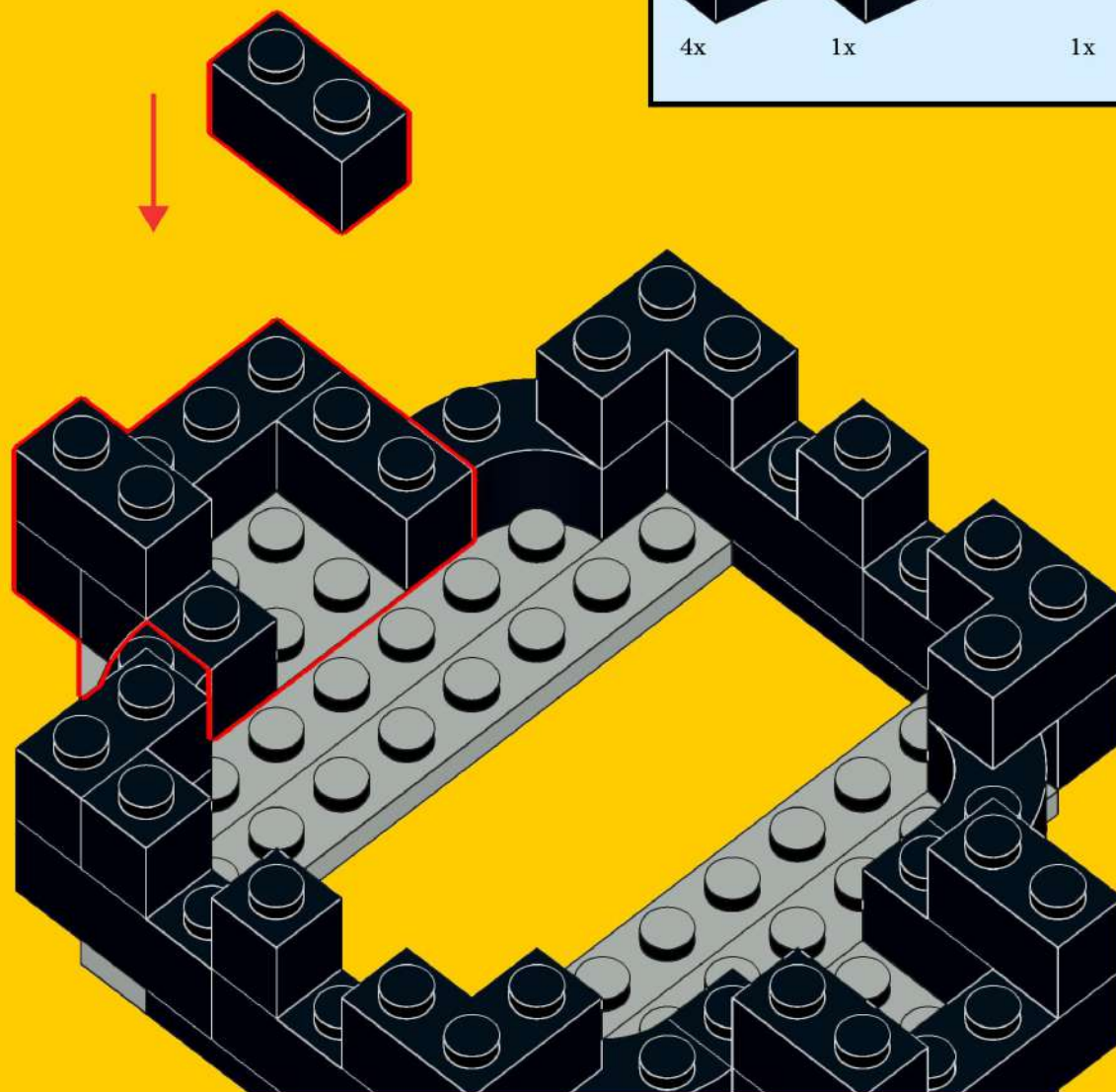
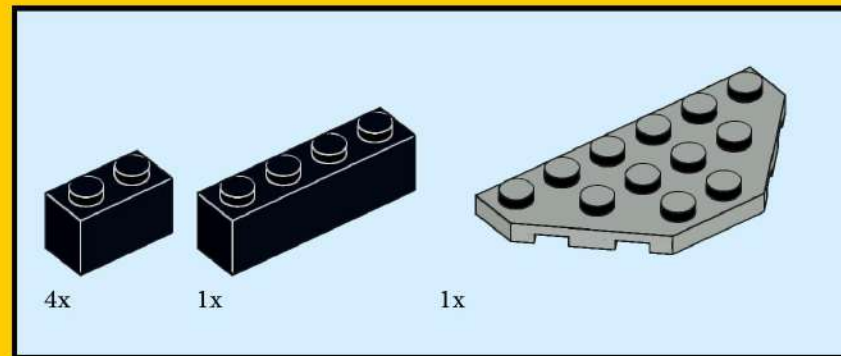

42

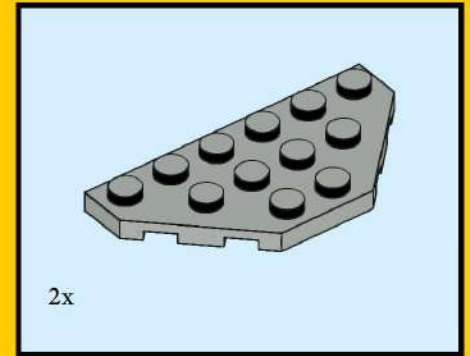

43

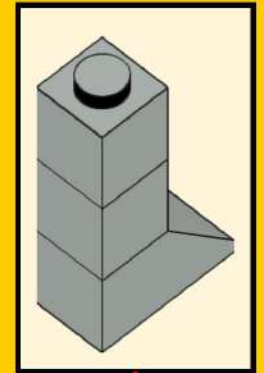
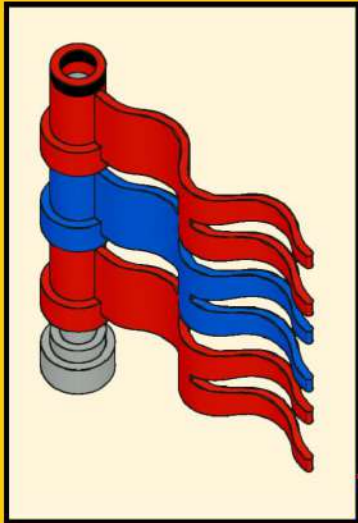
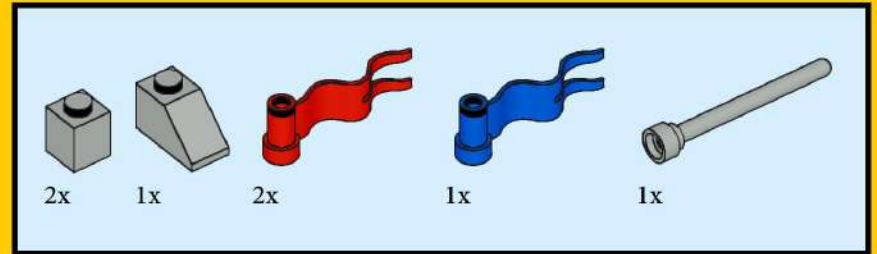

44

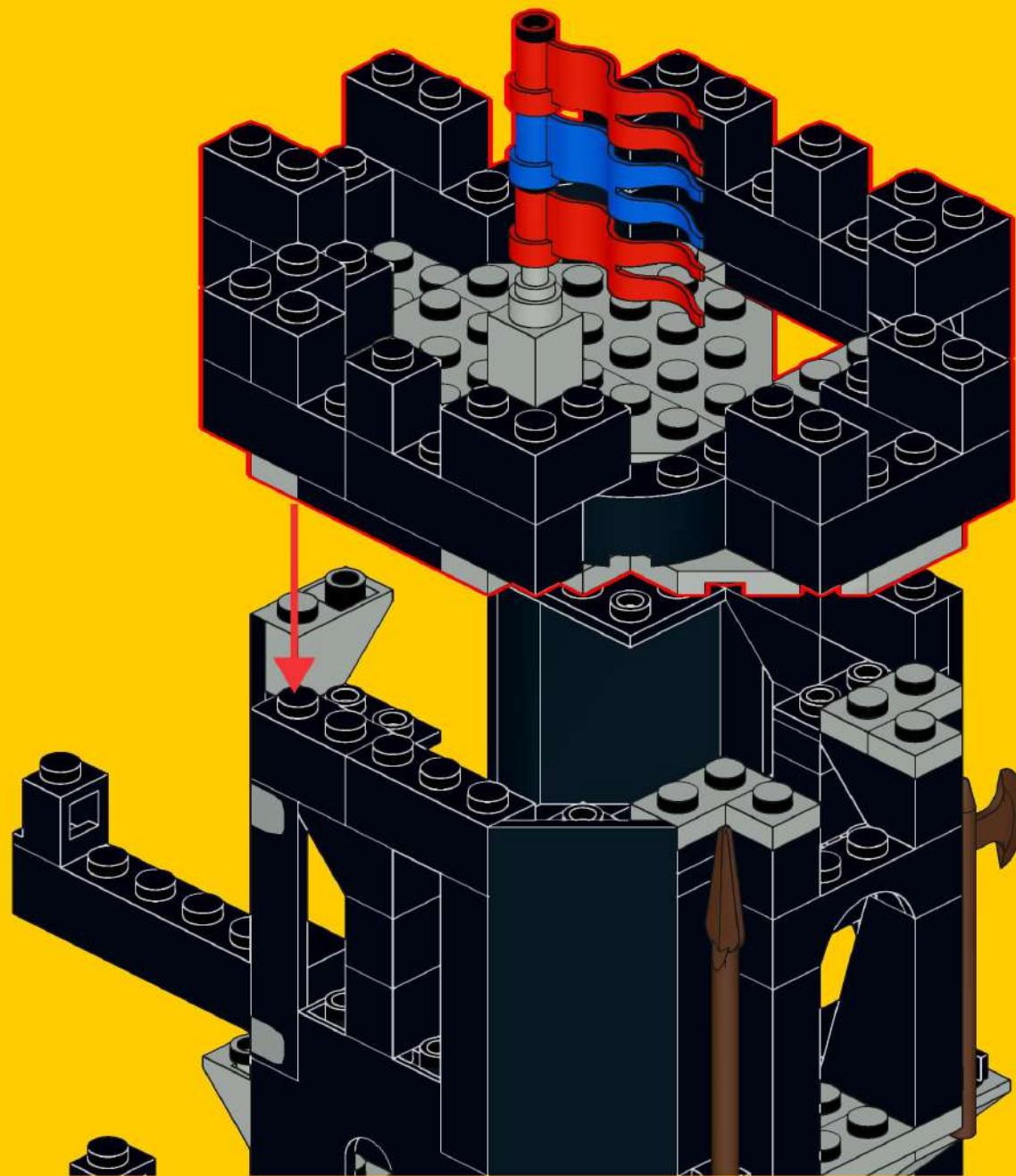

45

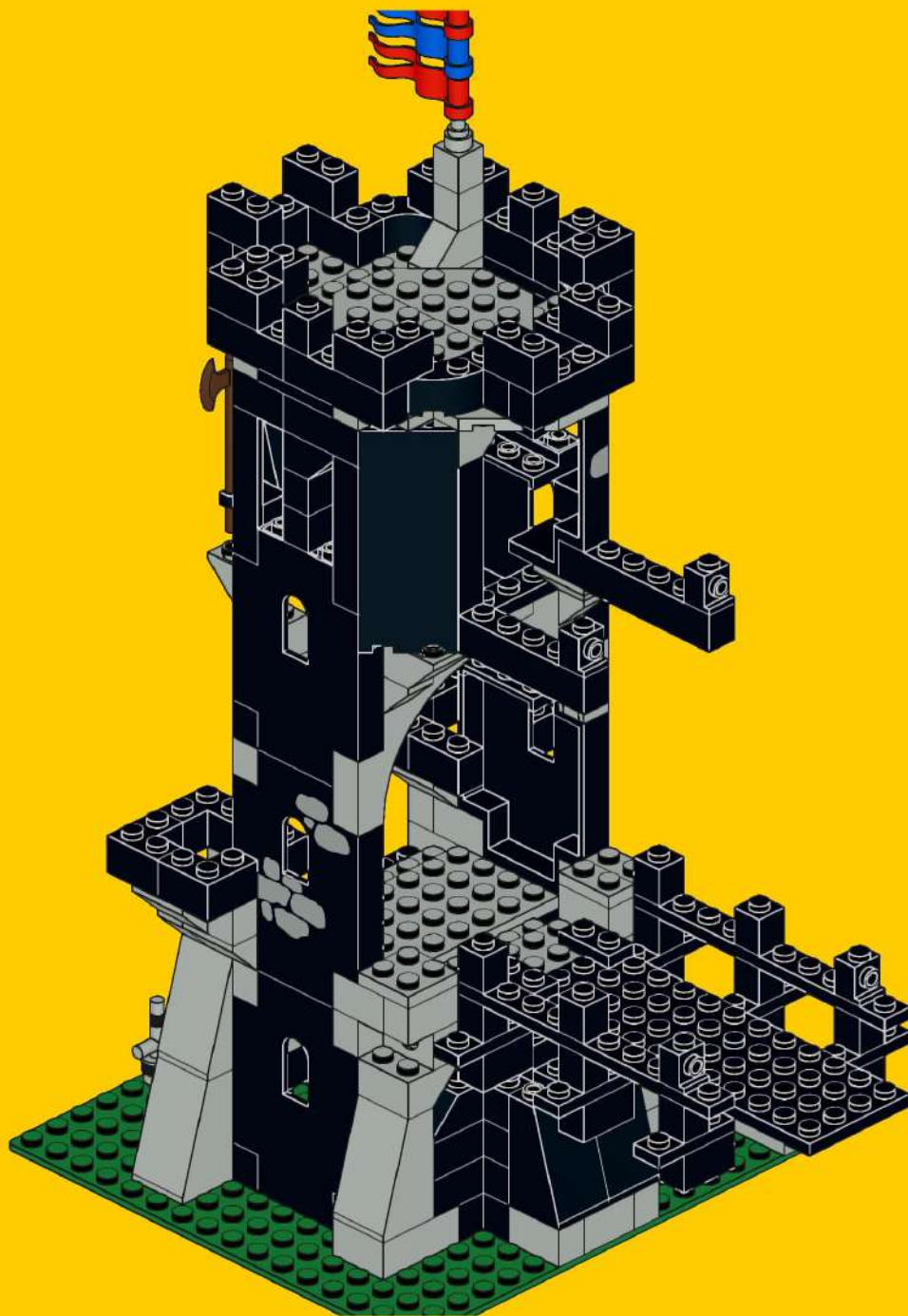

46

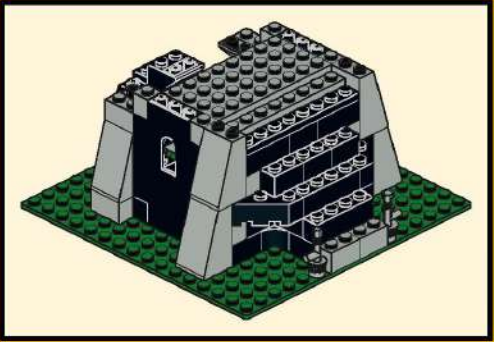
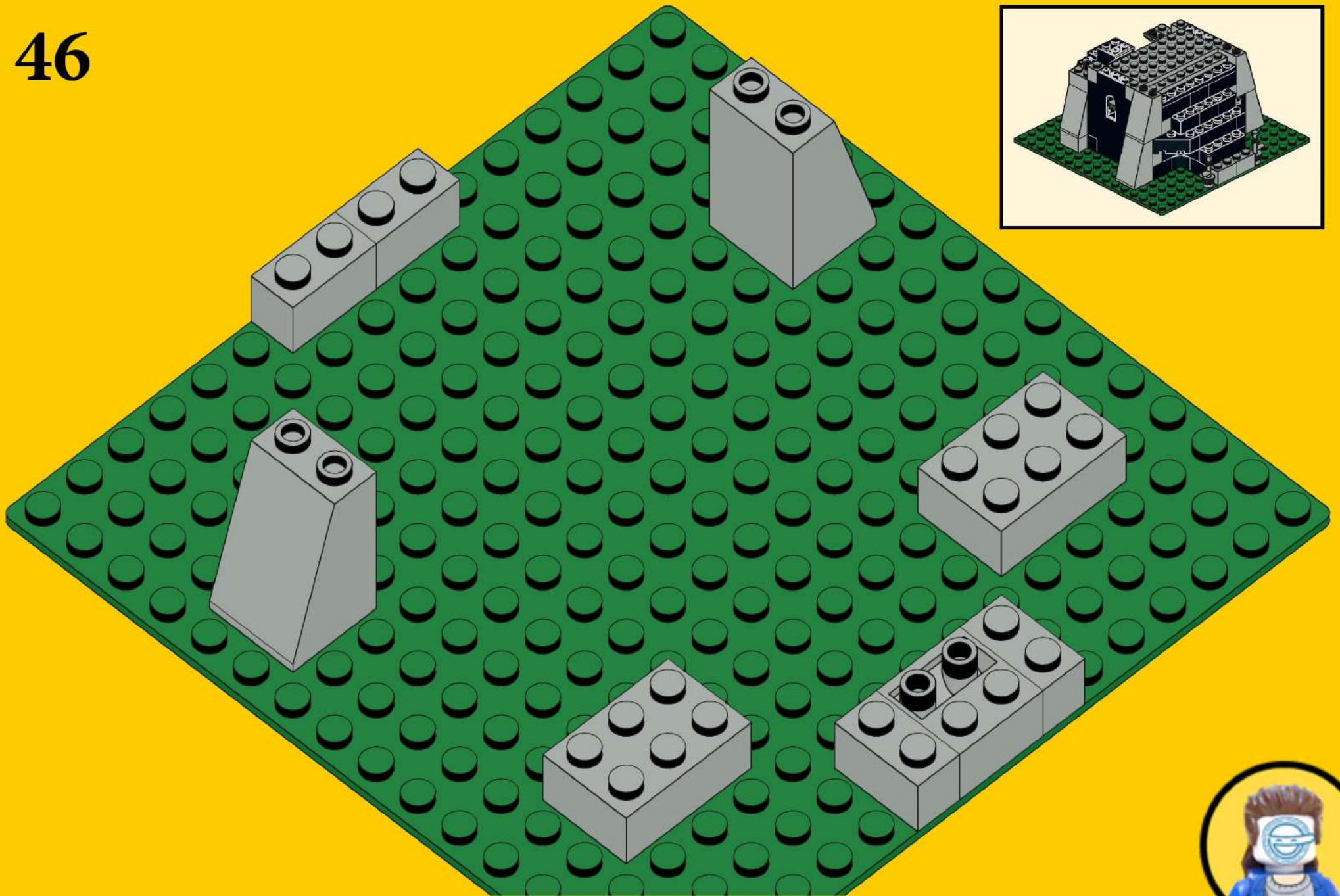



47

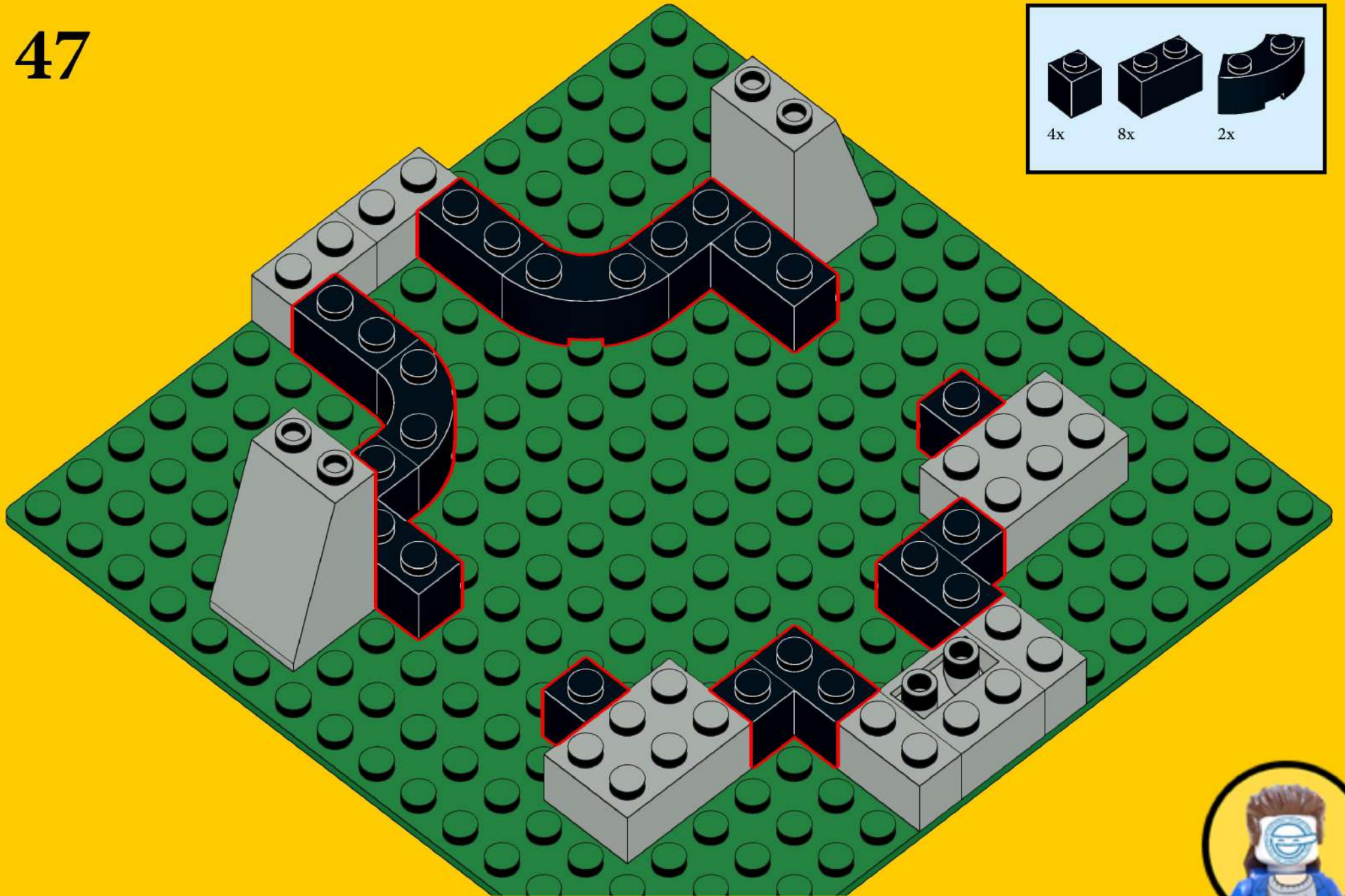



# 49

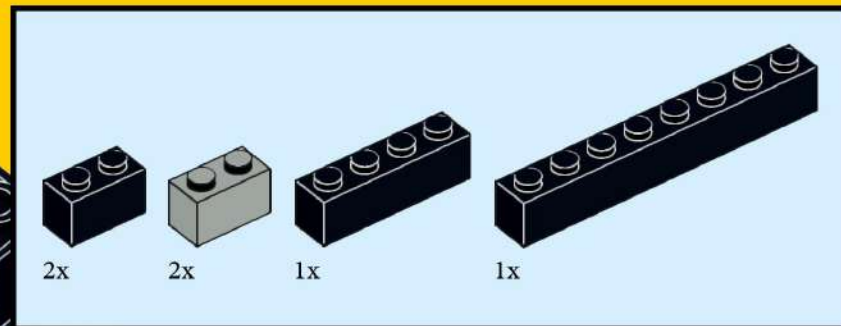
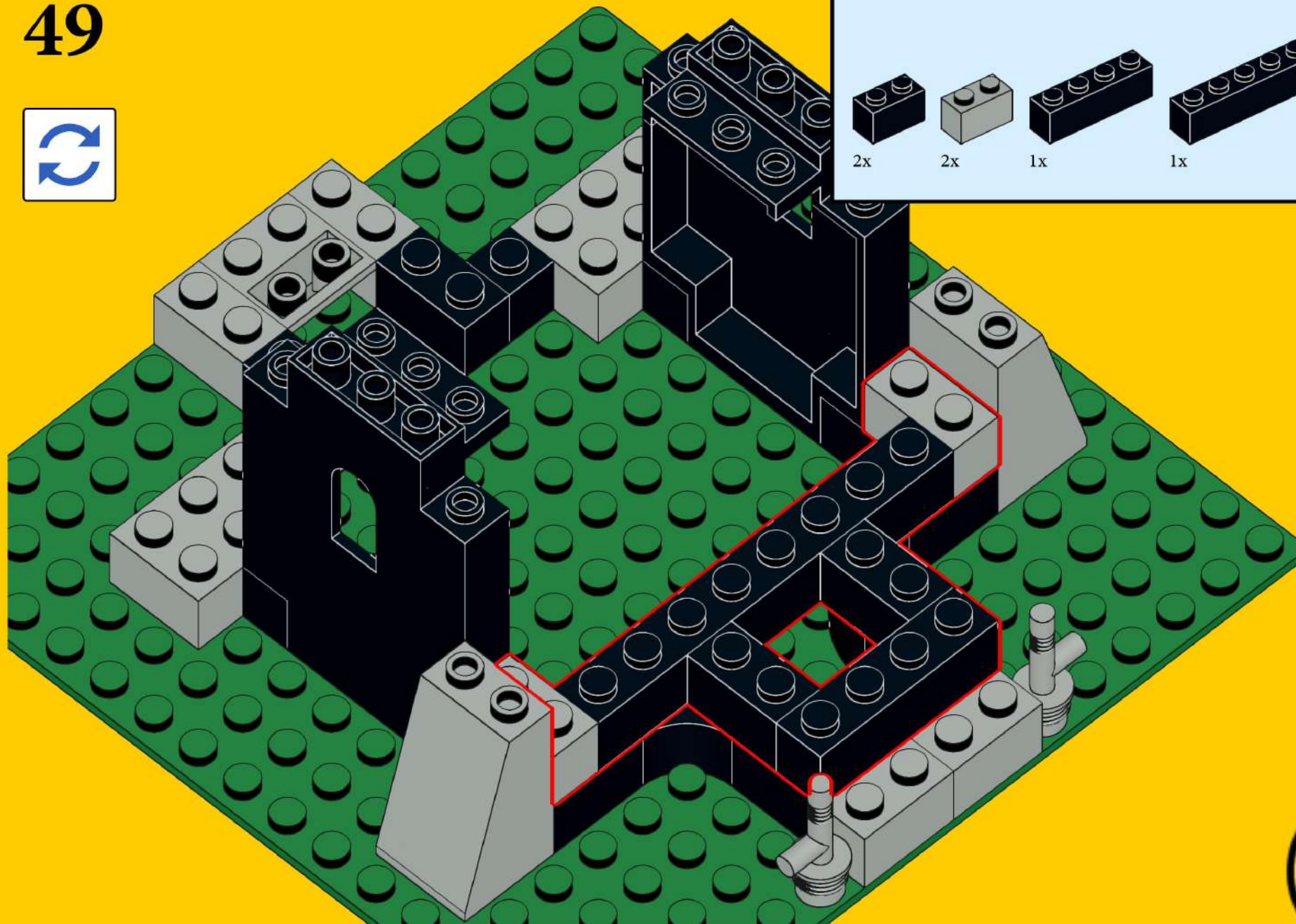

50

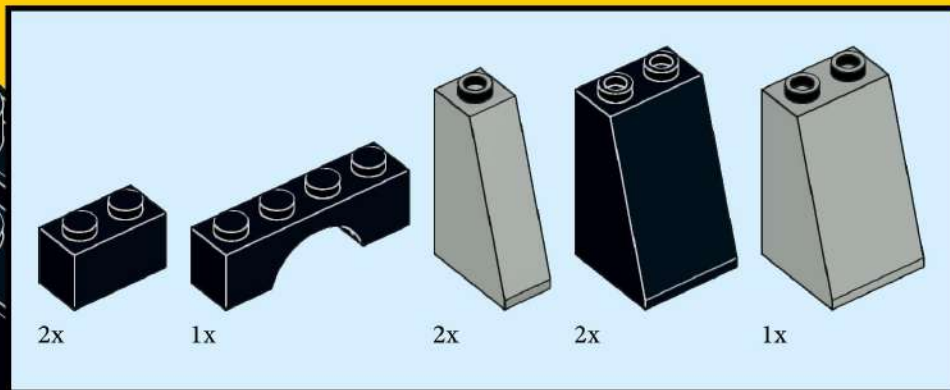
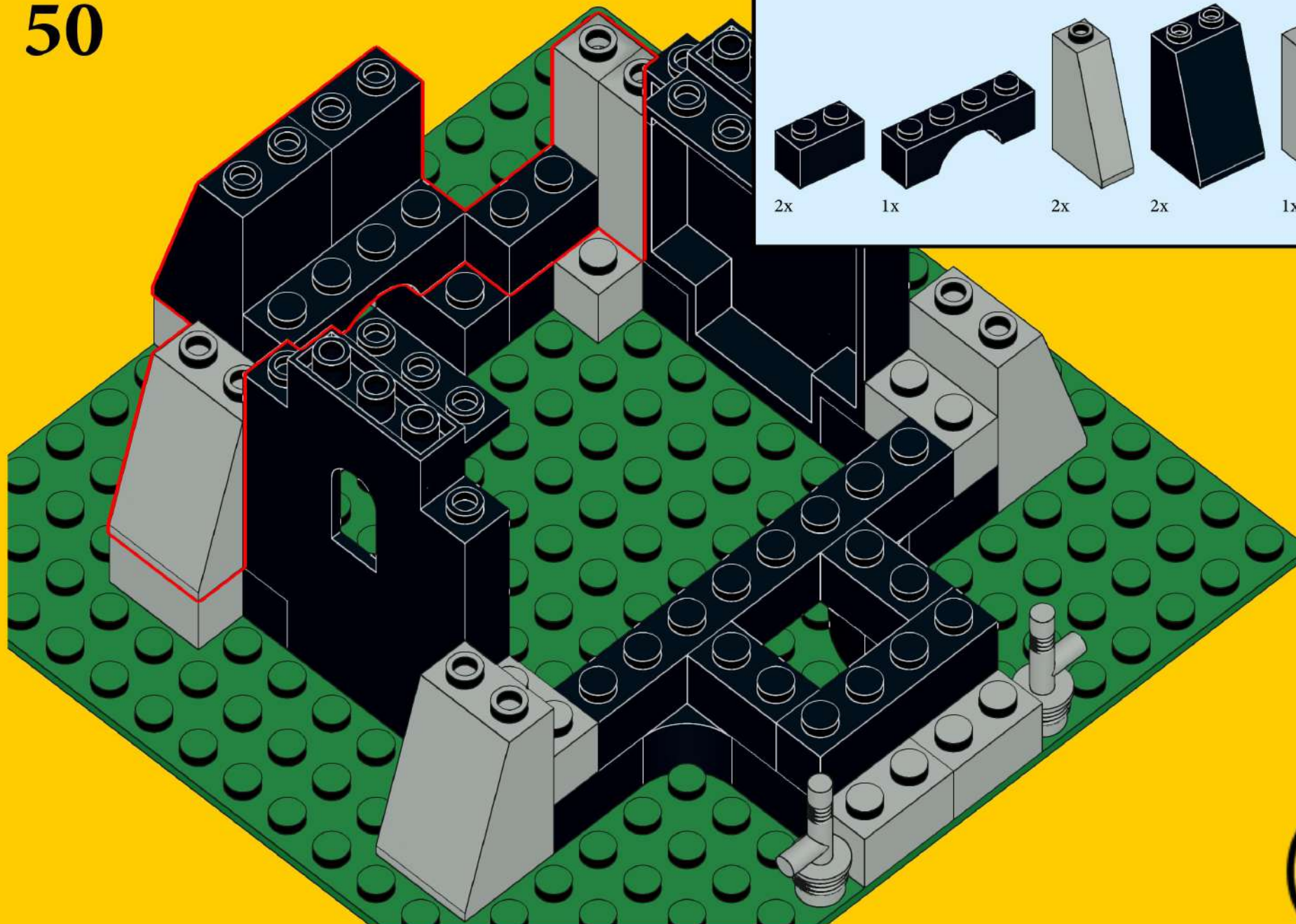

51

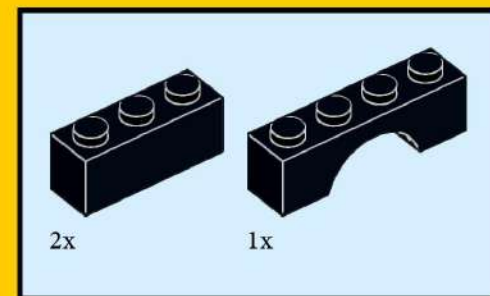
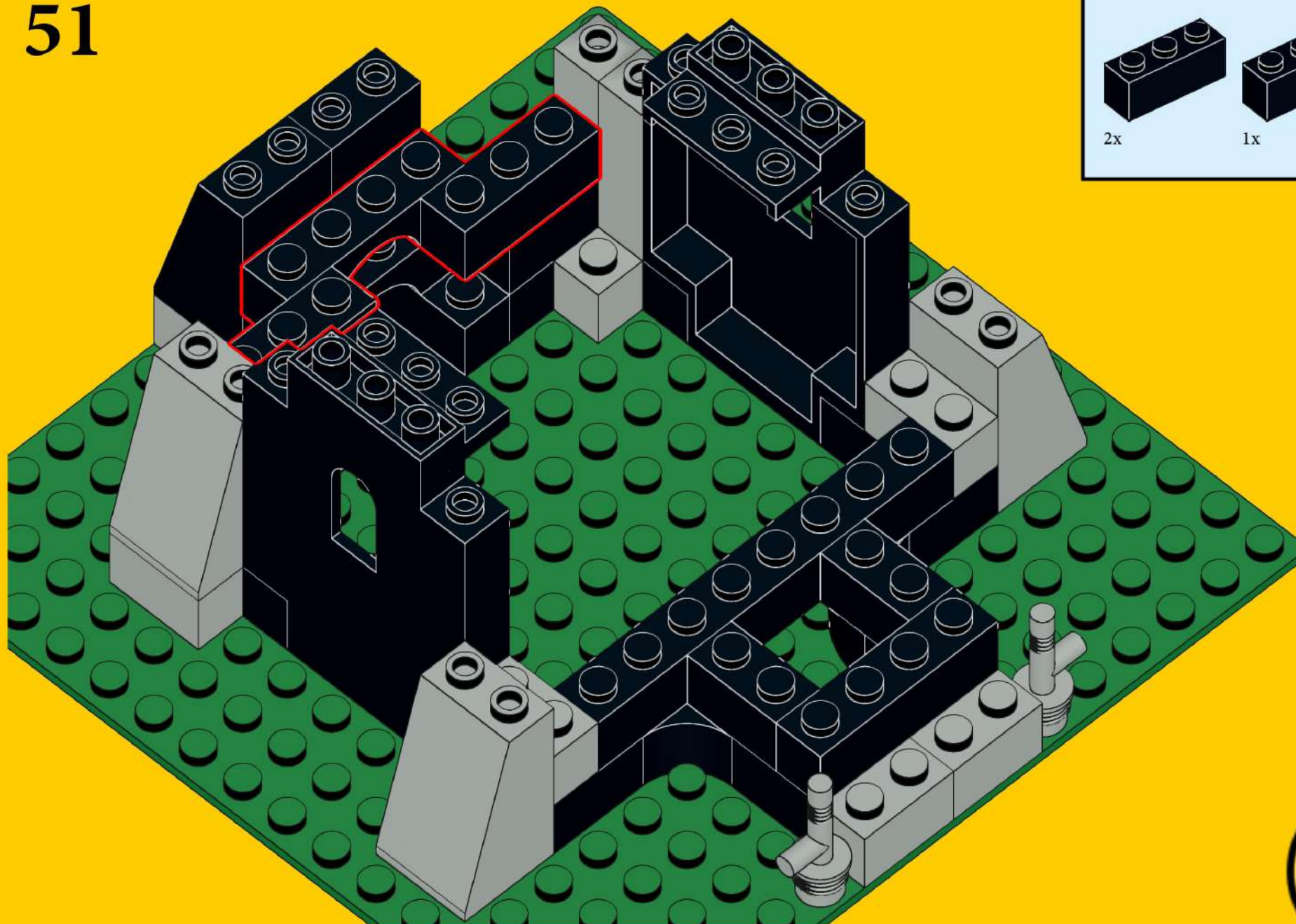

52

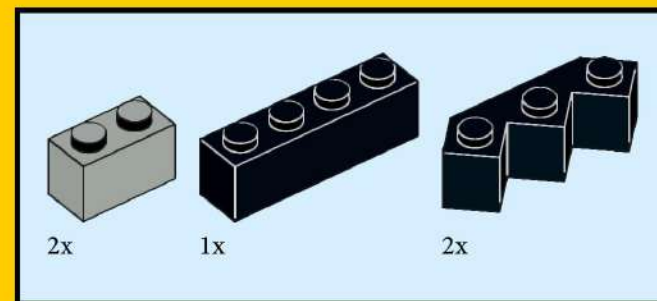
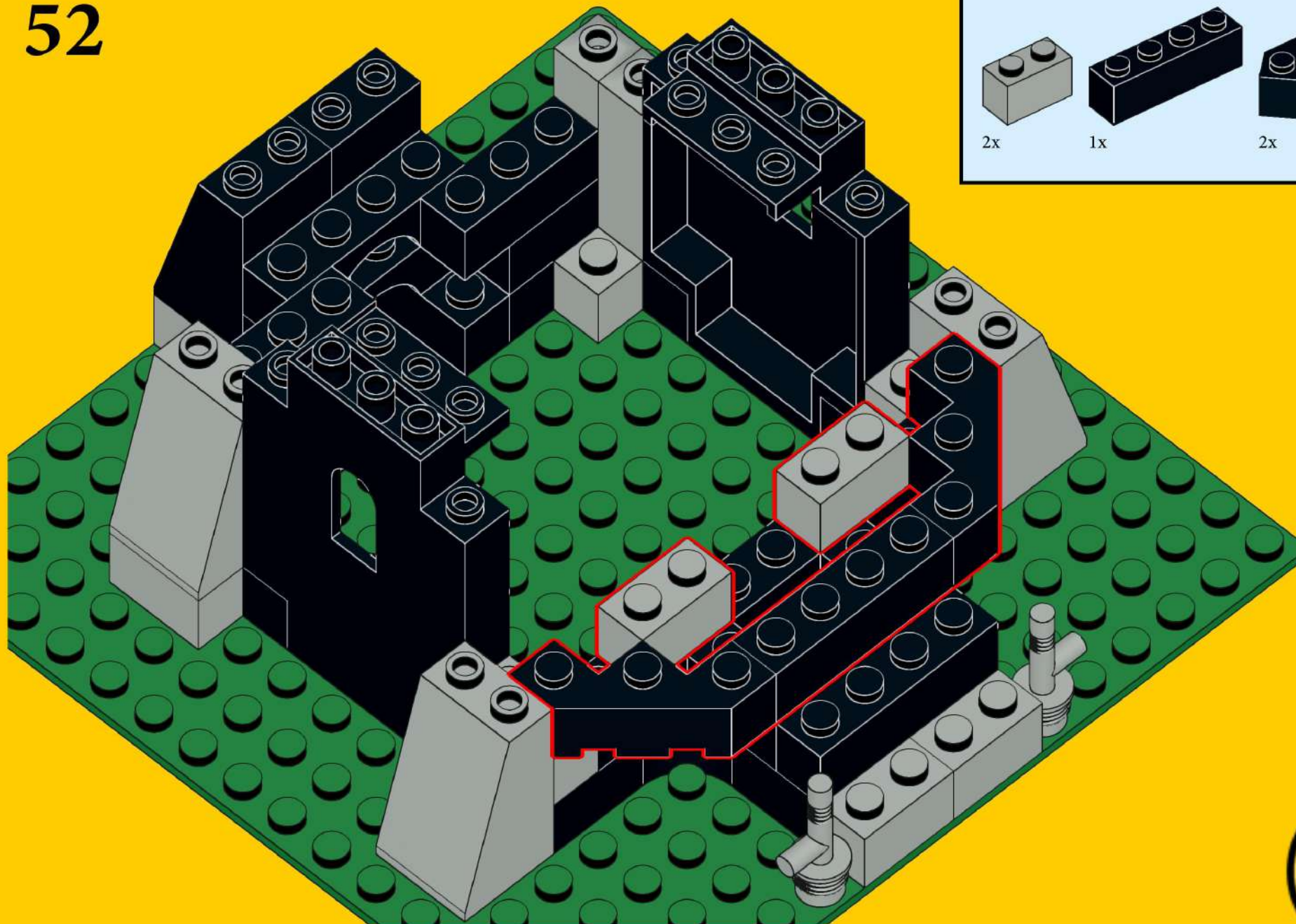

53

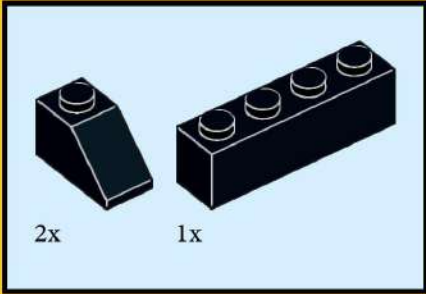
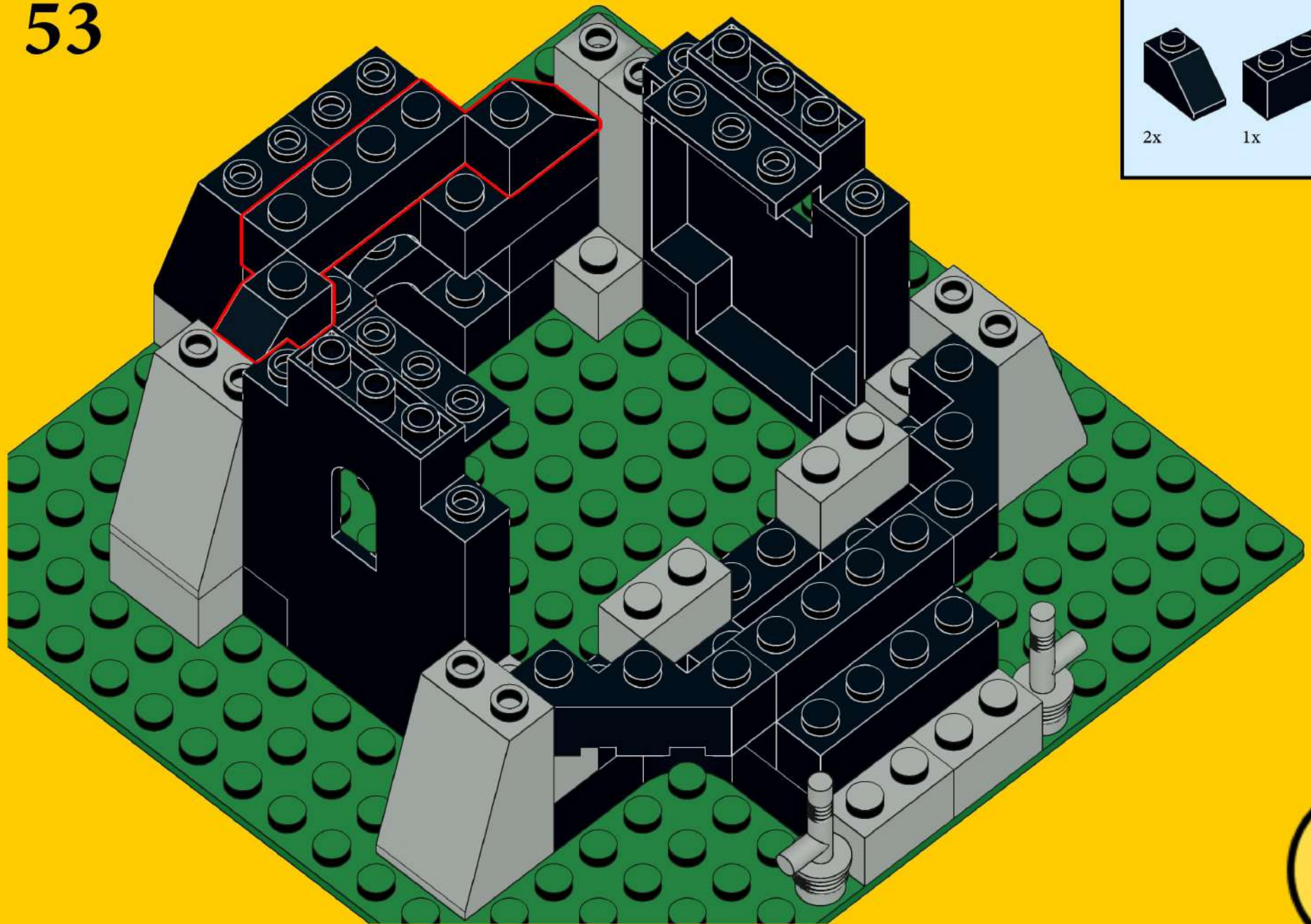

54

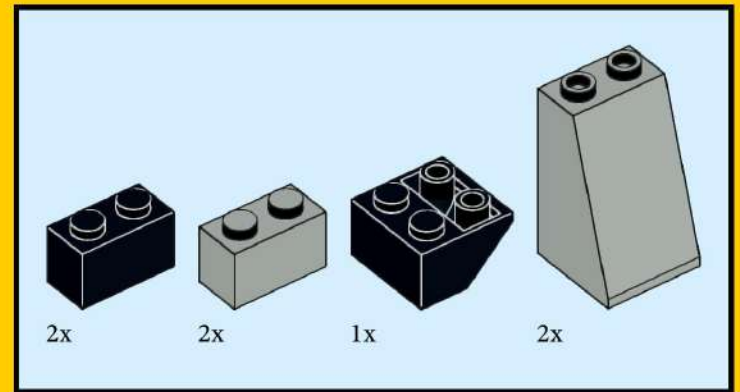
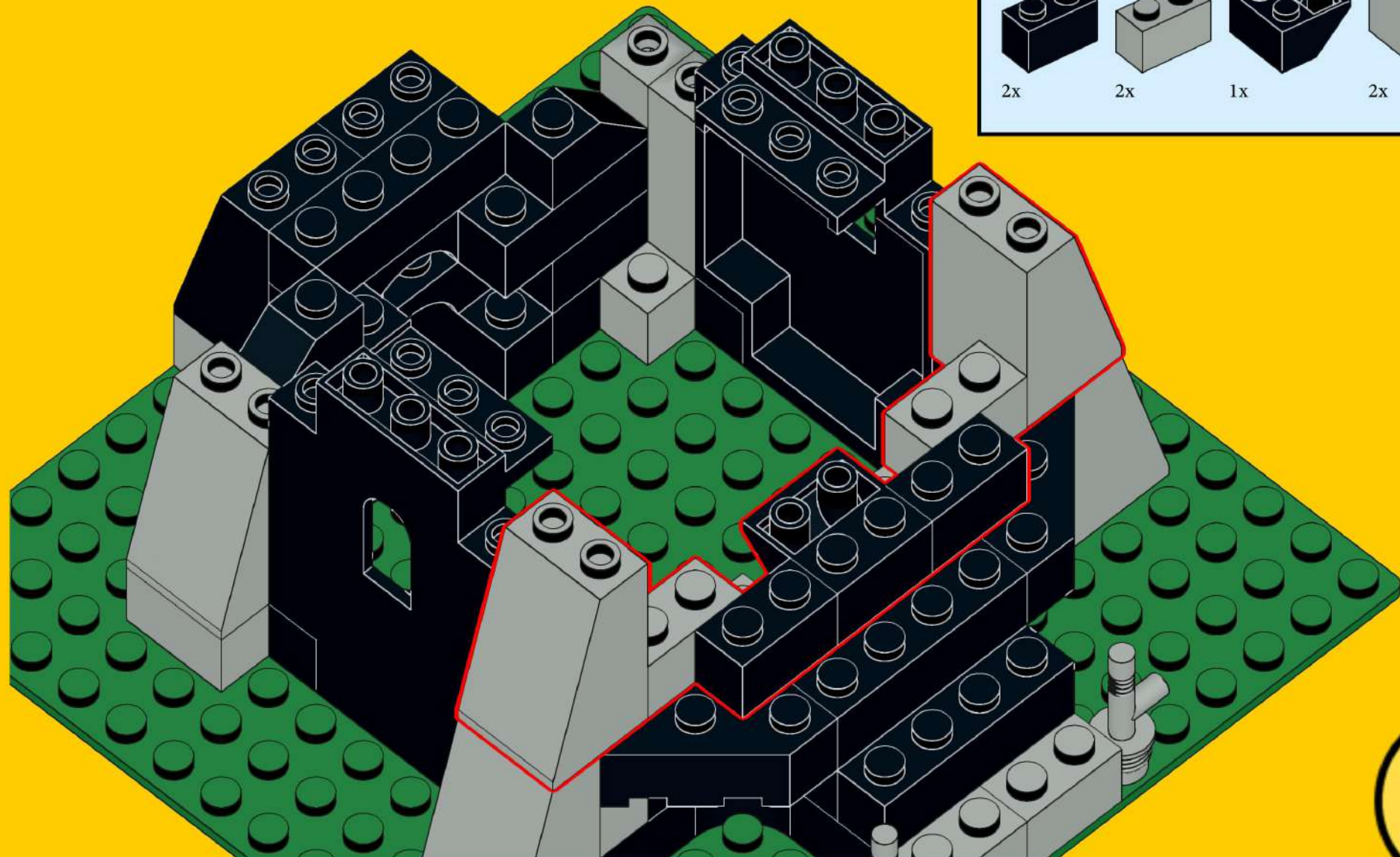



55

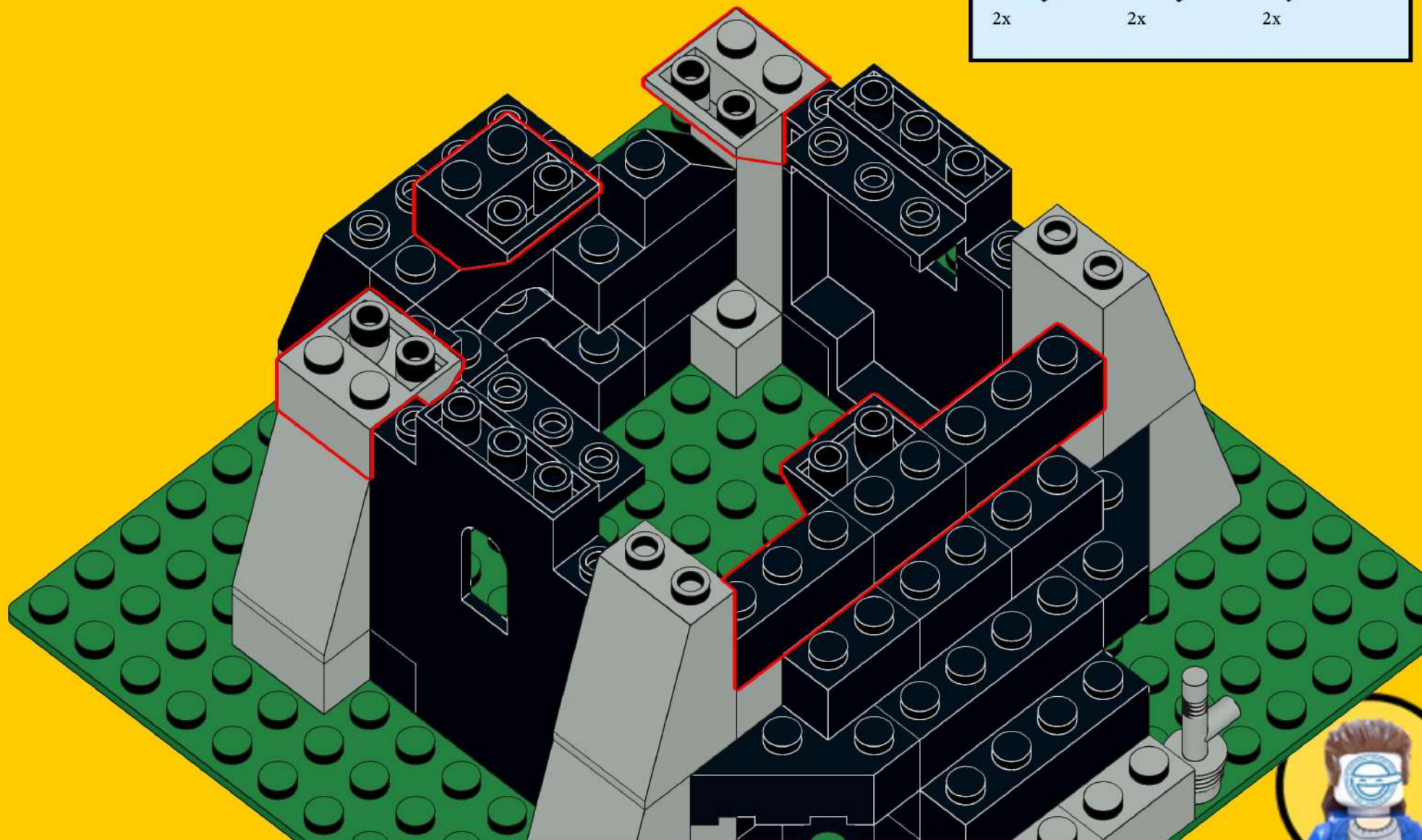
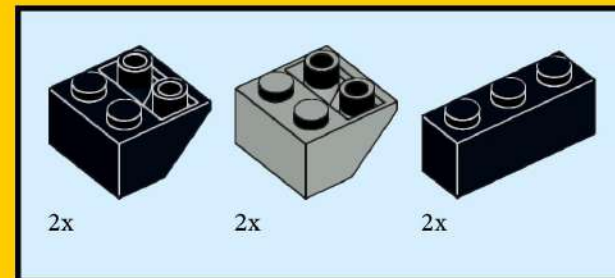

56

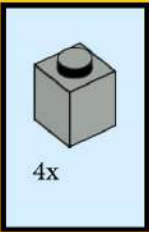
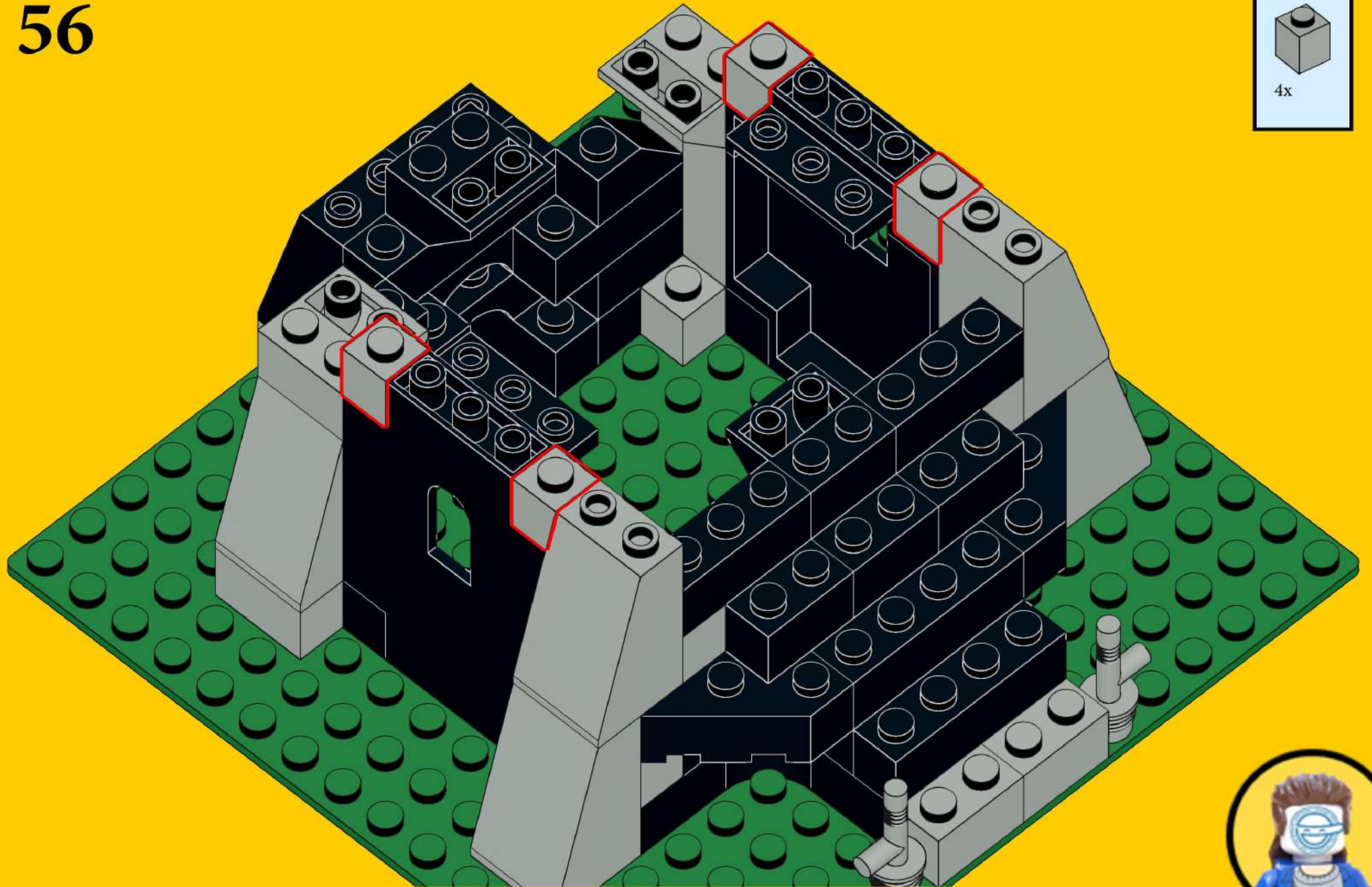

57

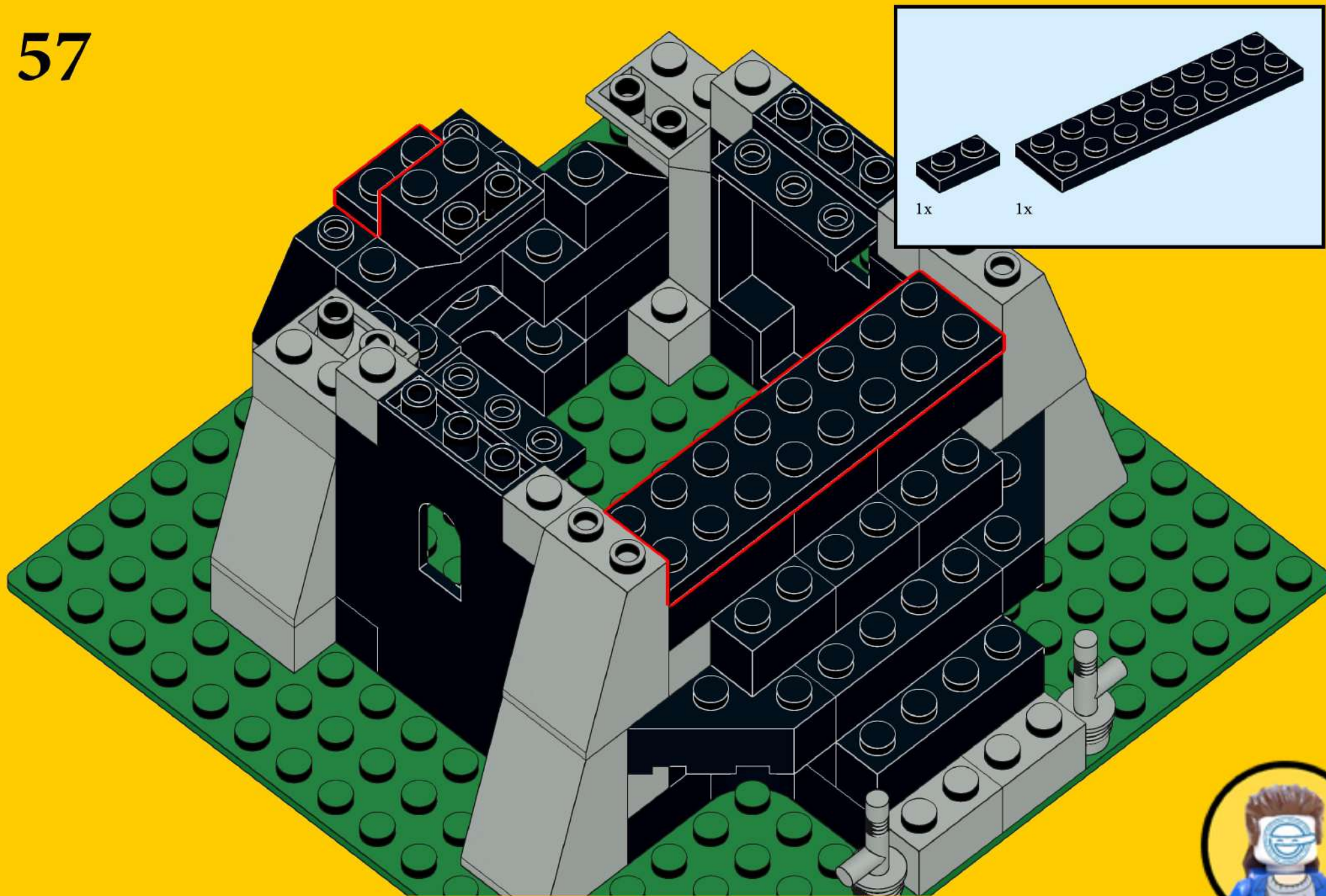

58

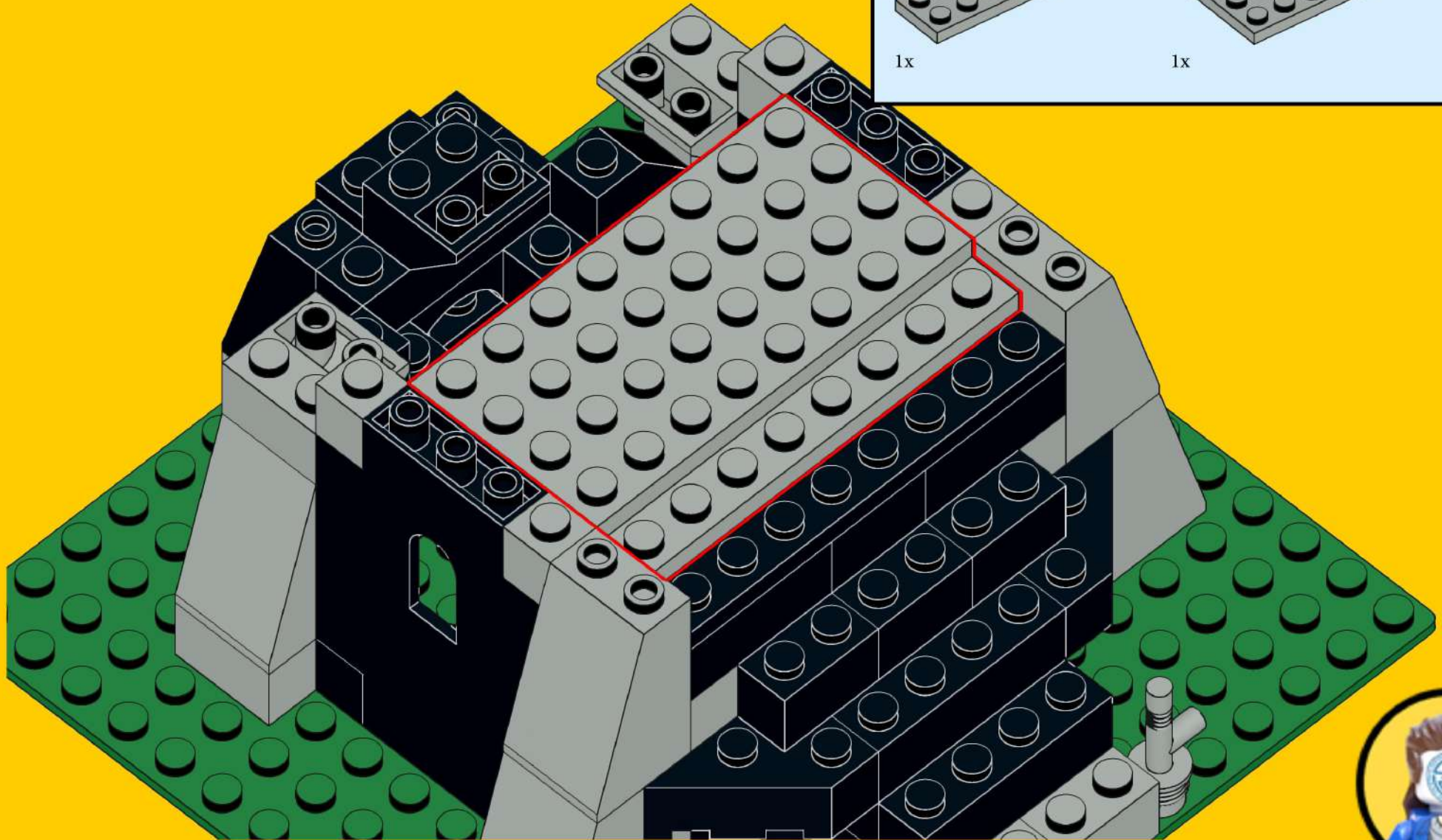
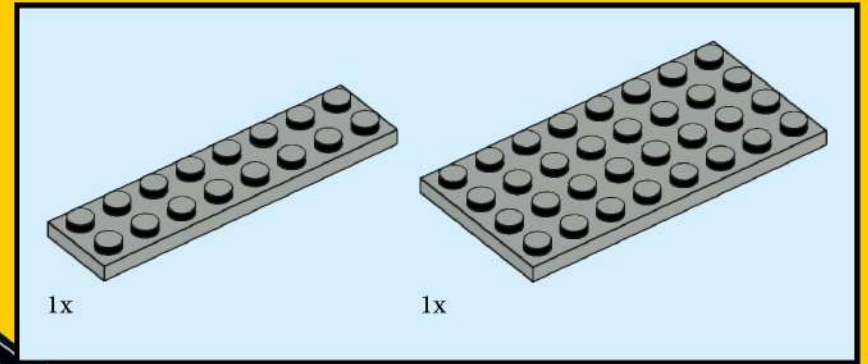

59

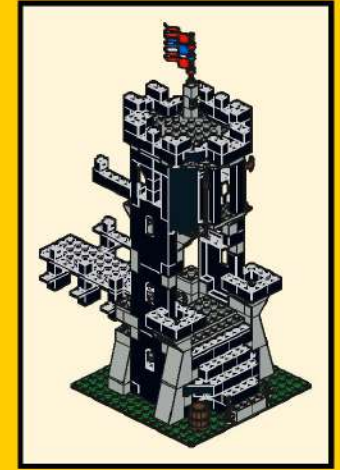
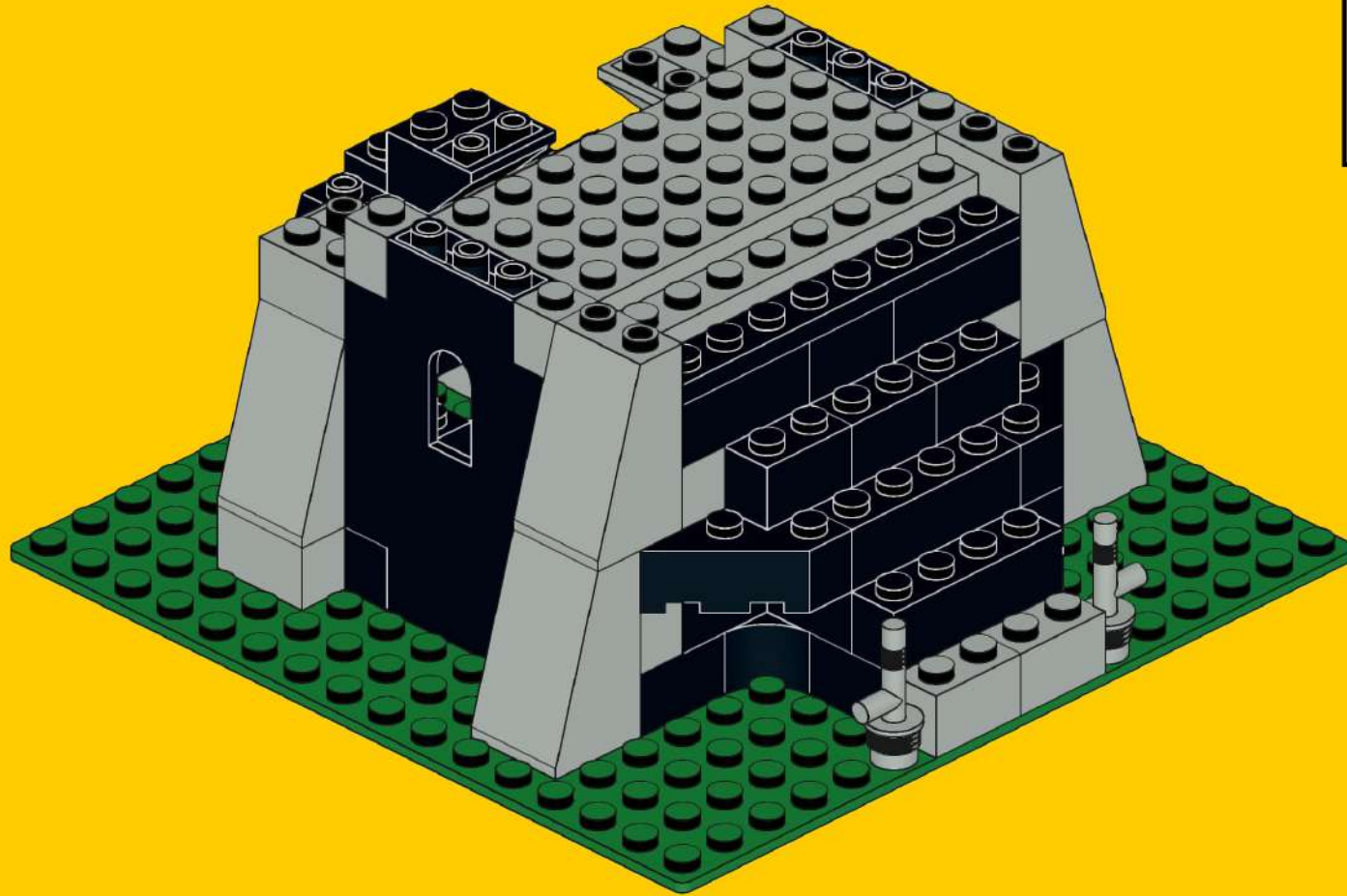

60

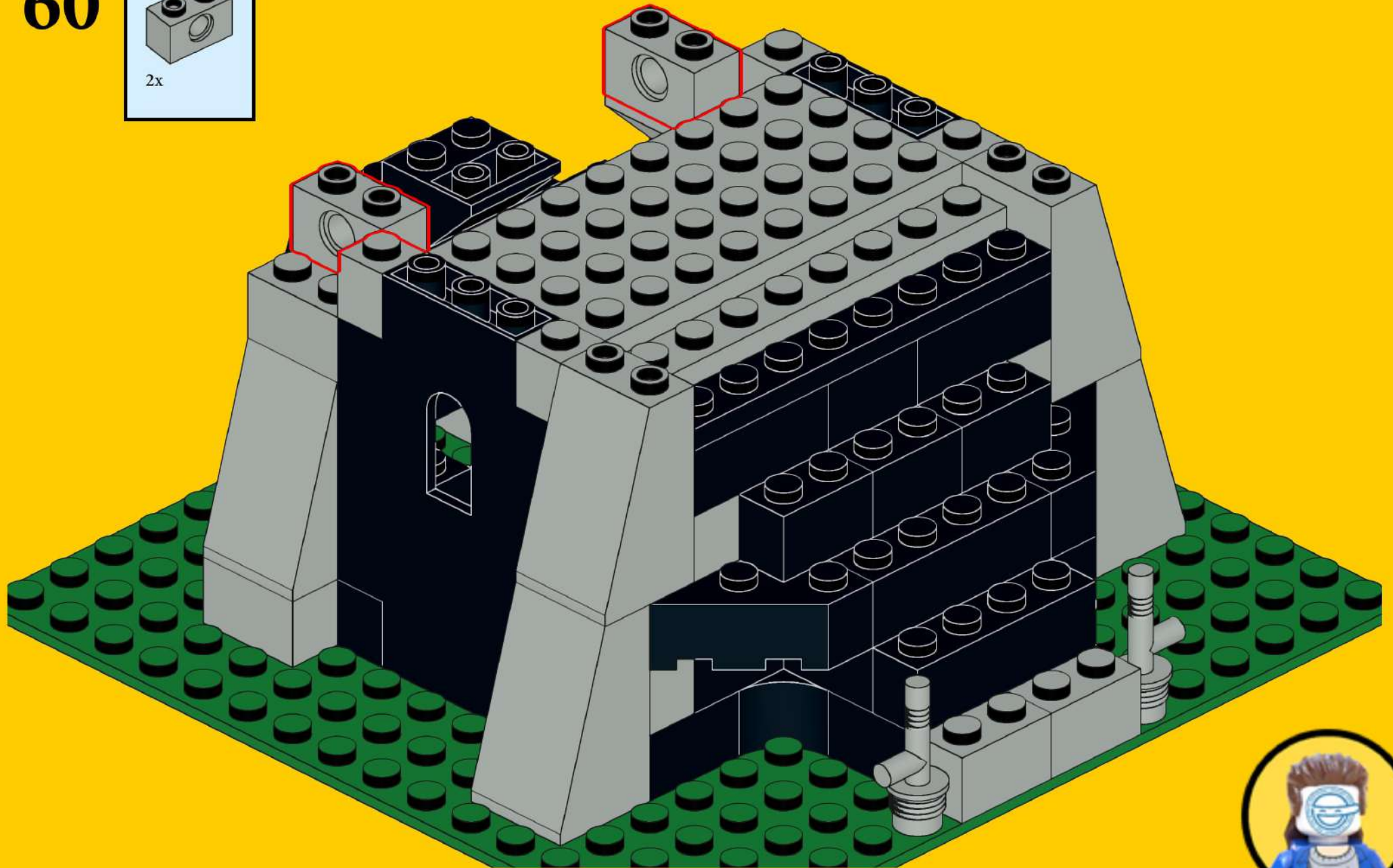
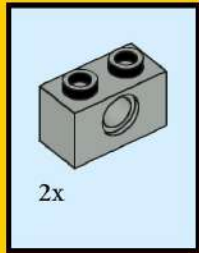

61

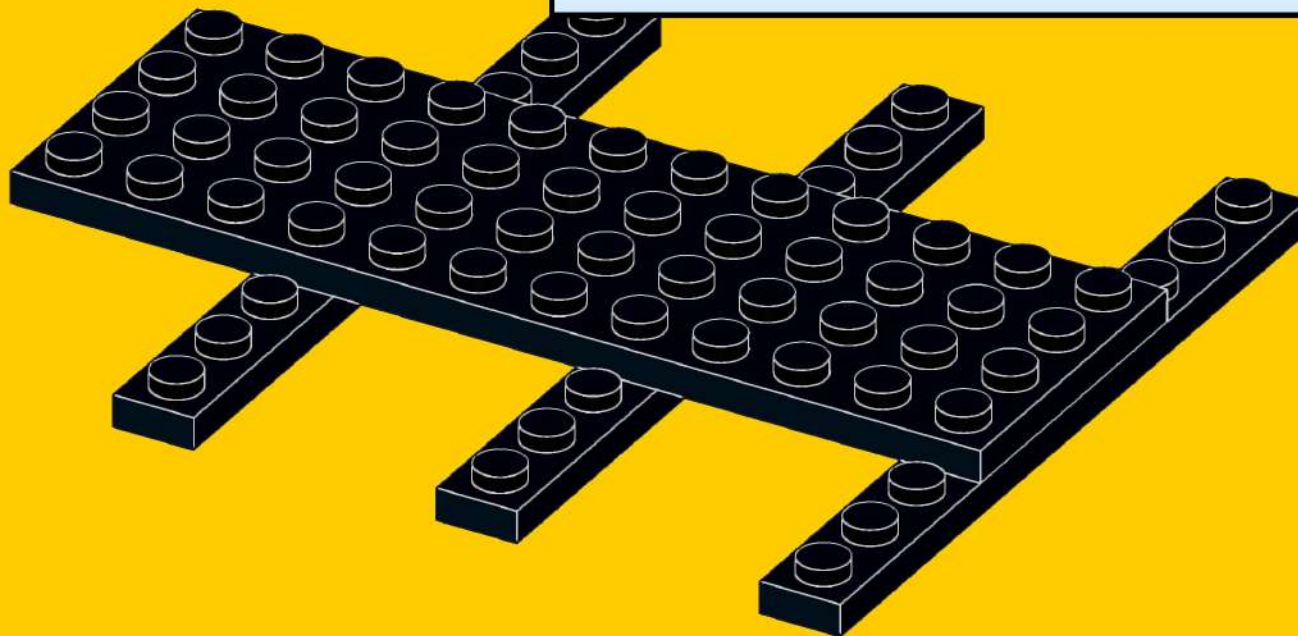
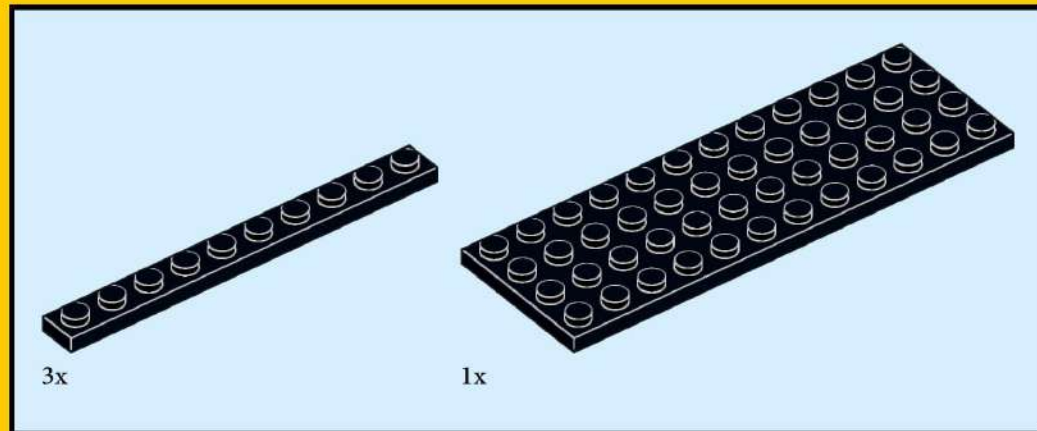
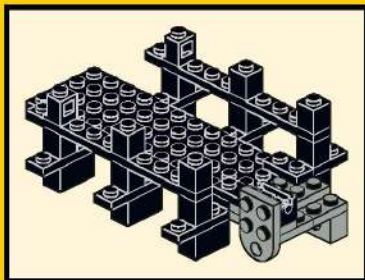

62

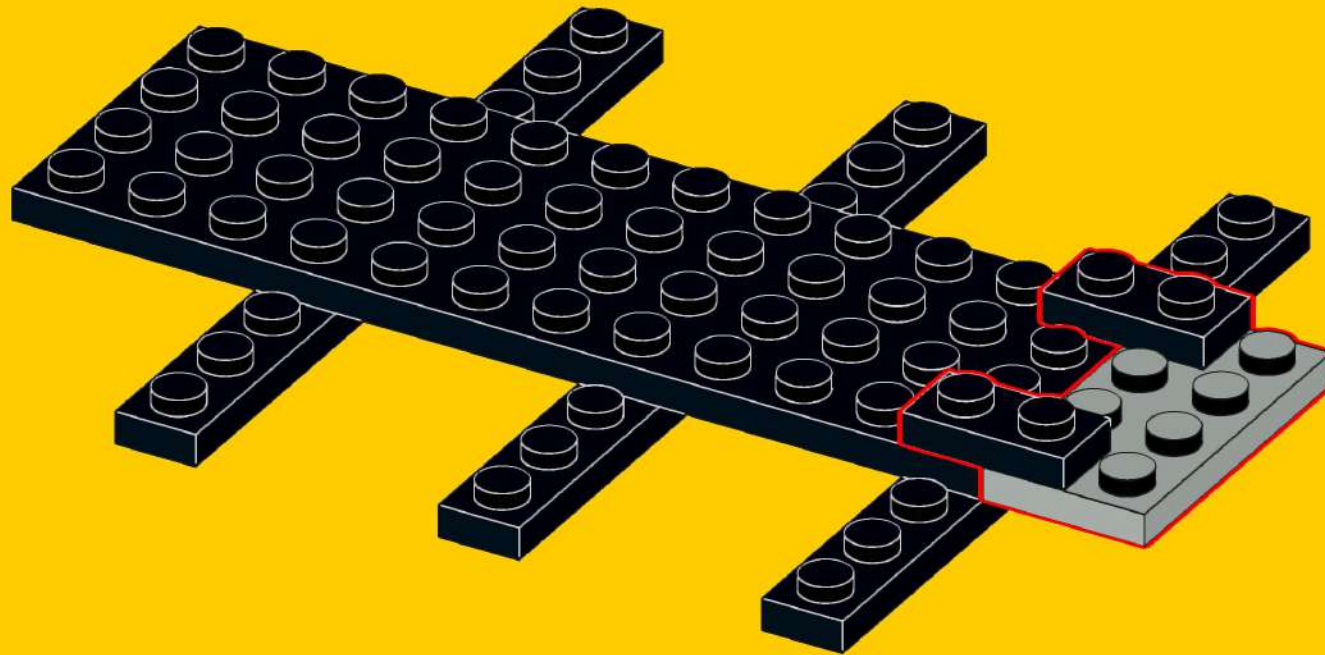
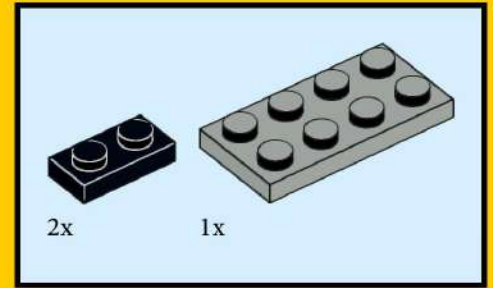



63

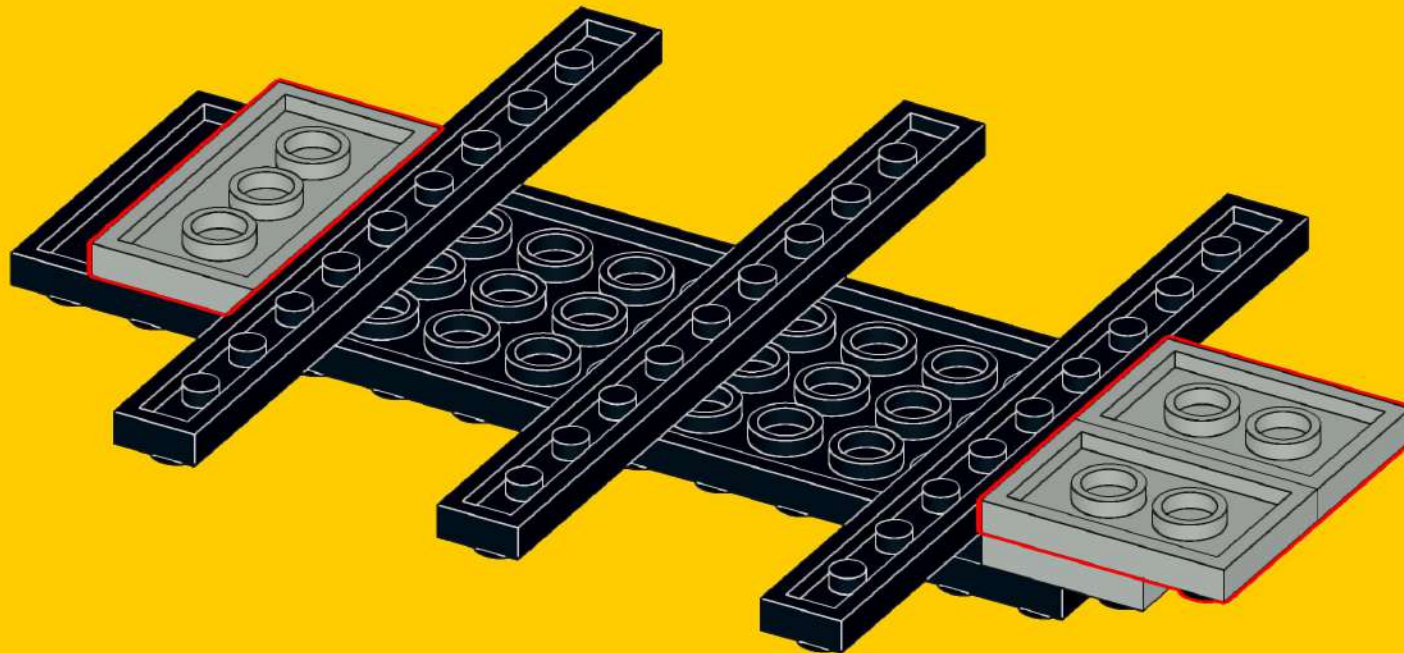
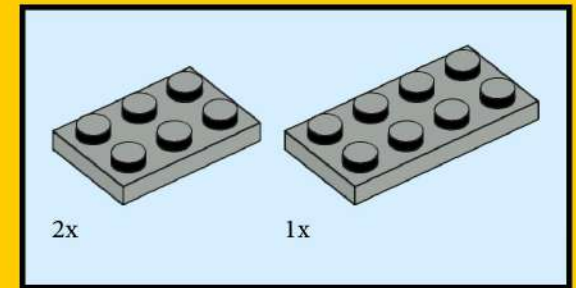

# 64

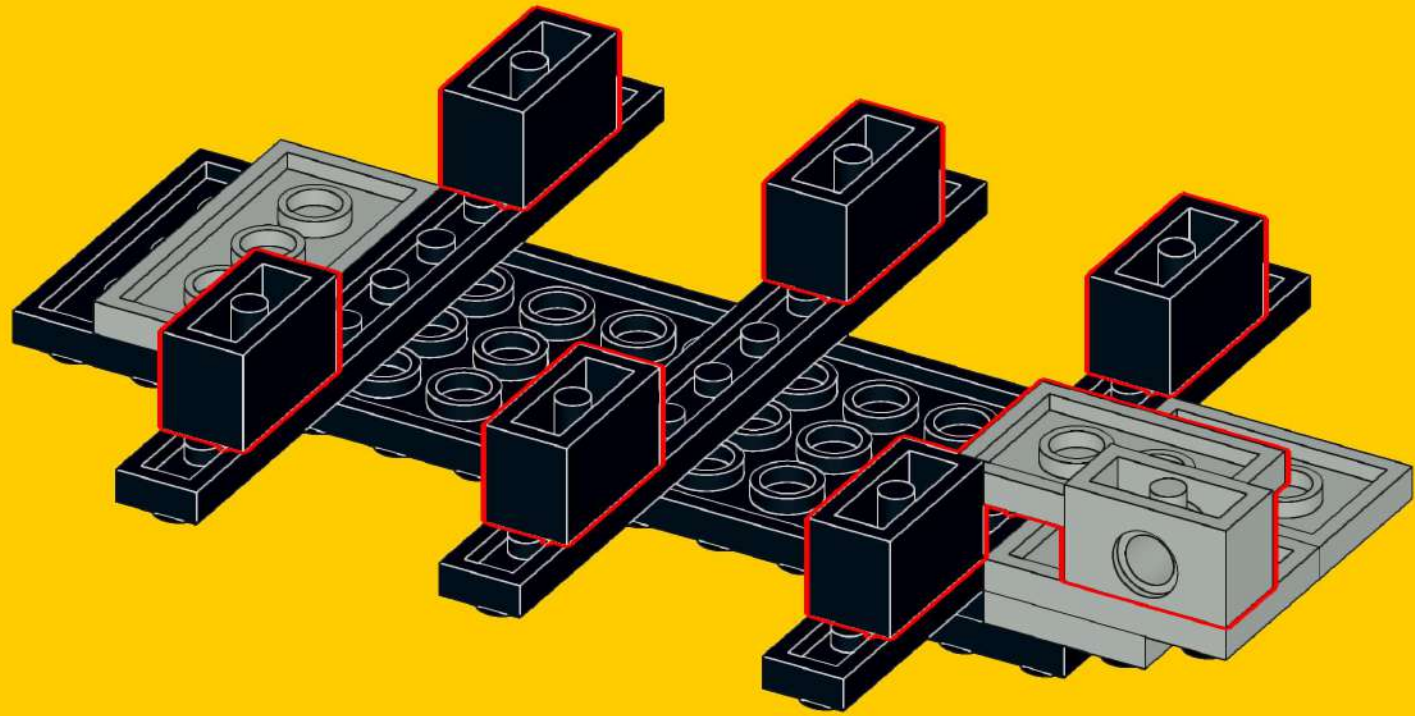
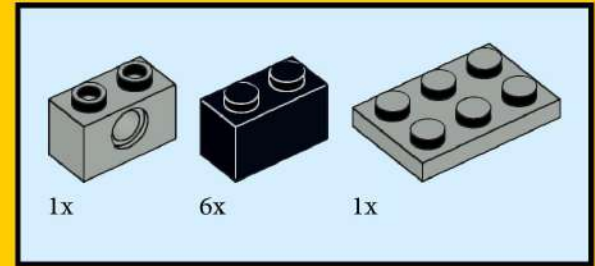

65

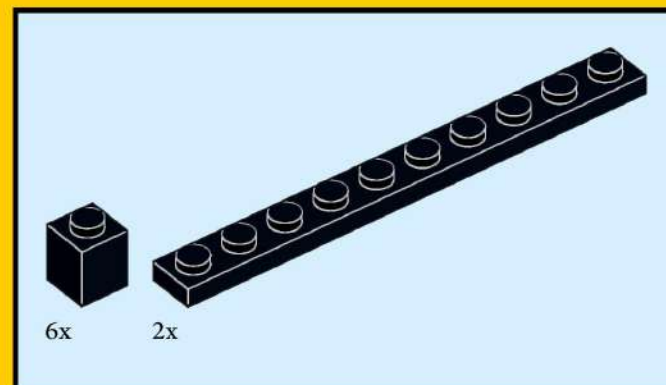
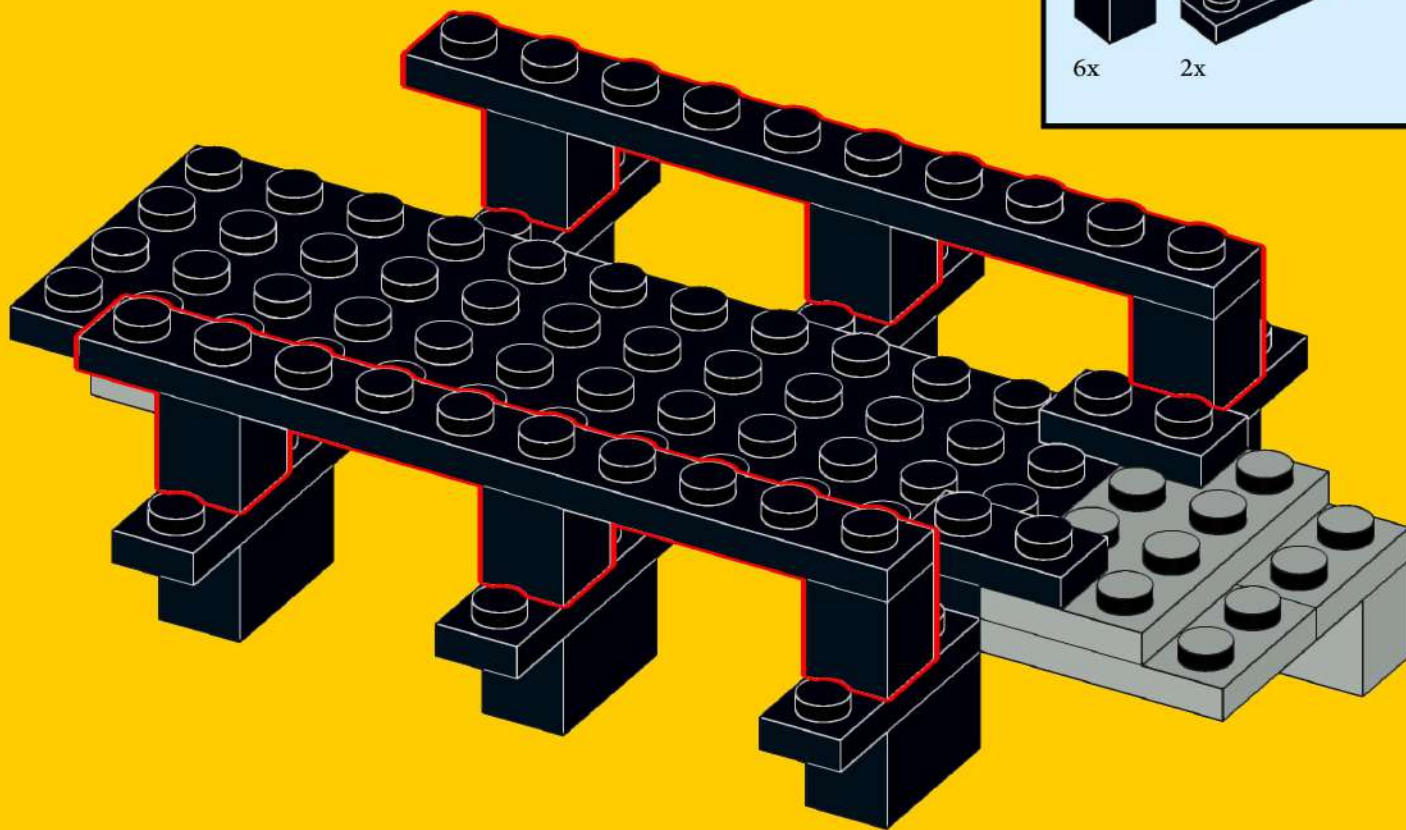

66

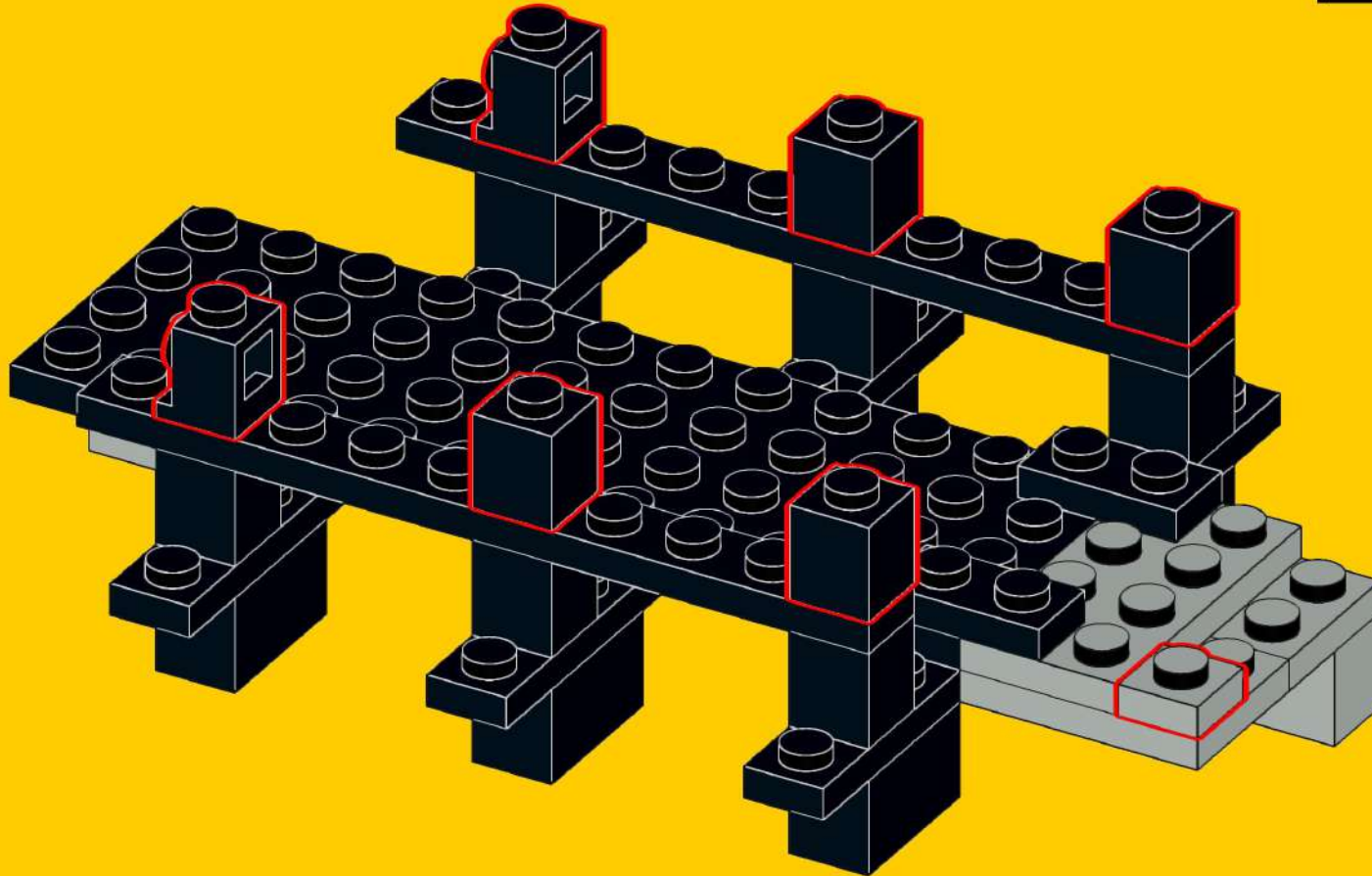
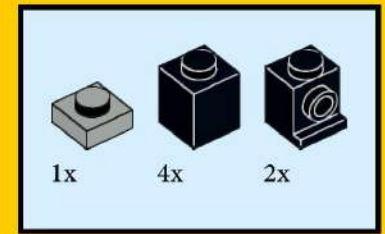

67

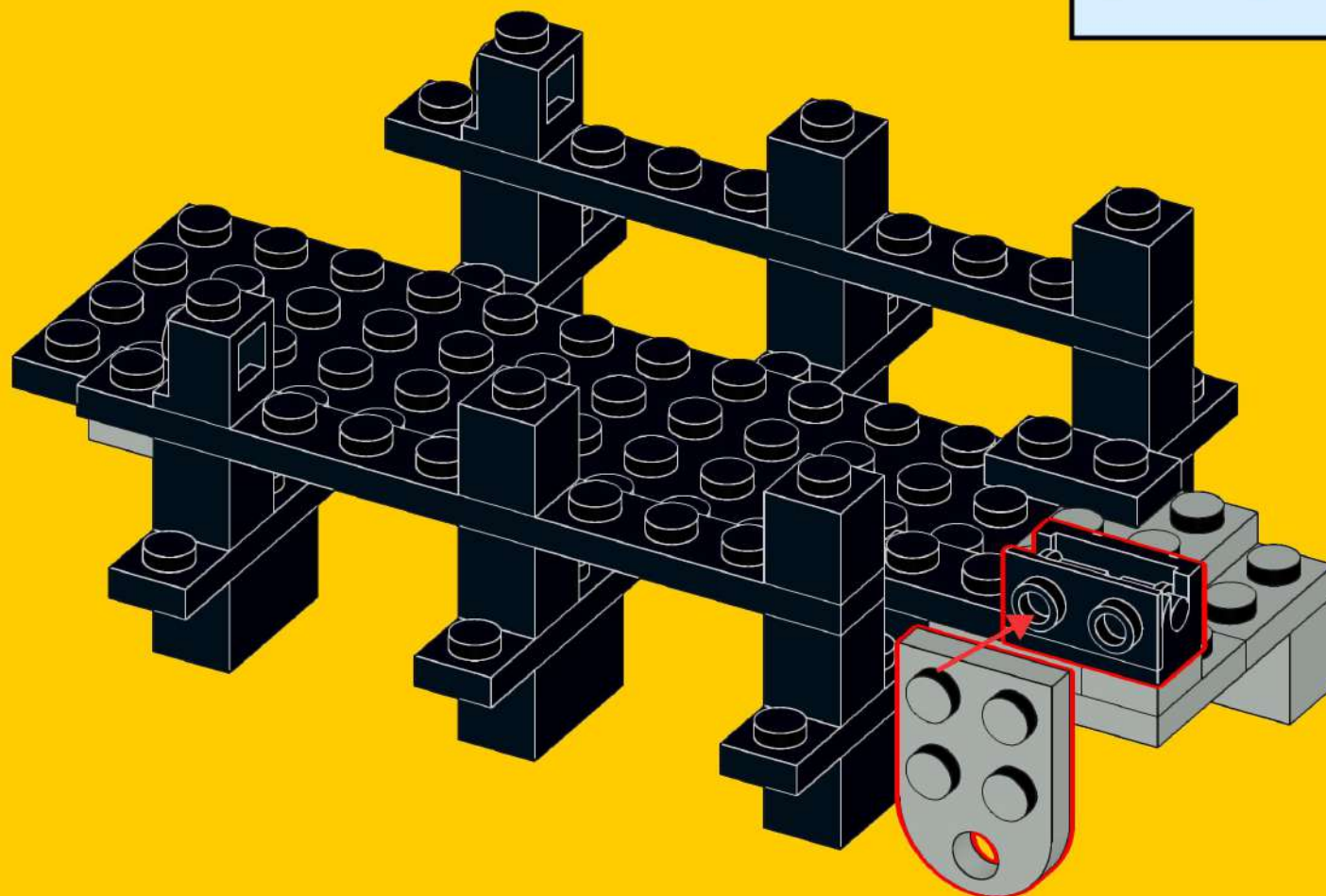
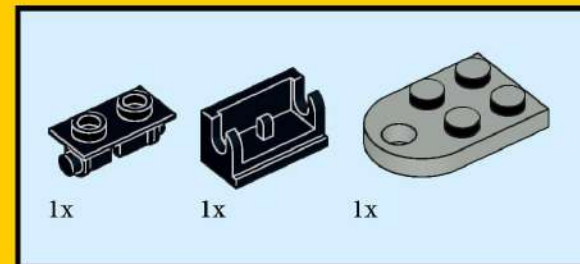

68

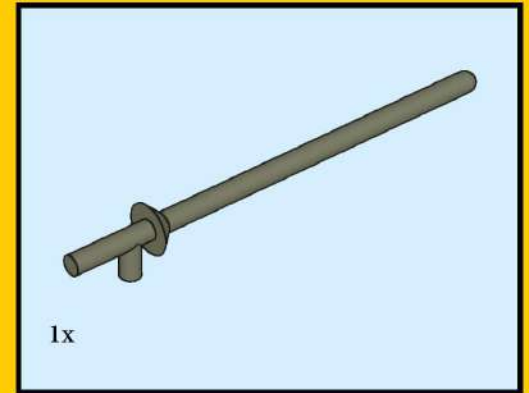
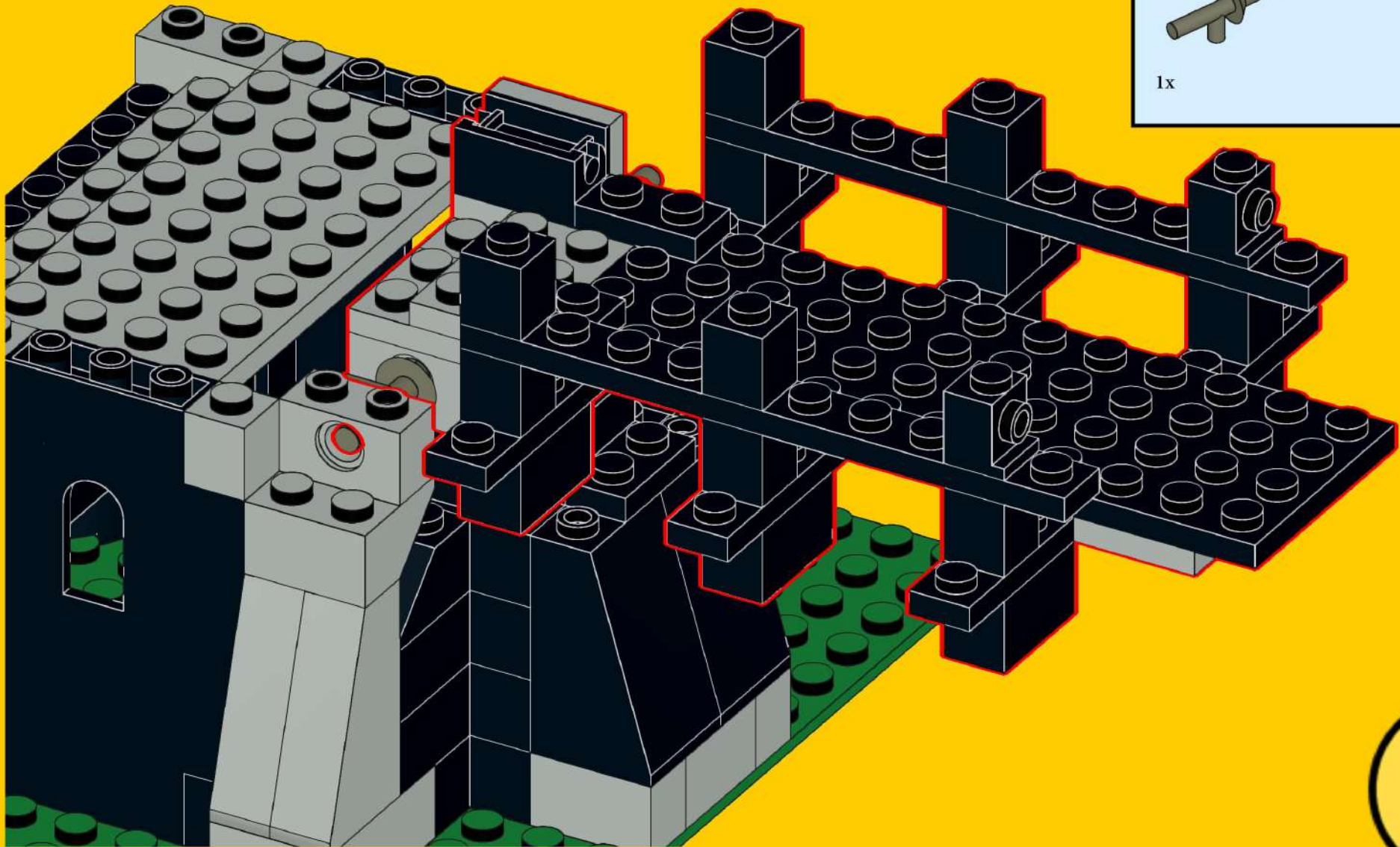

69

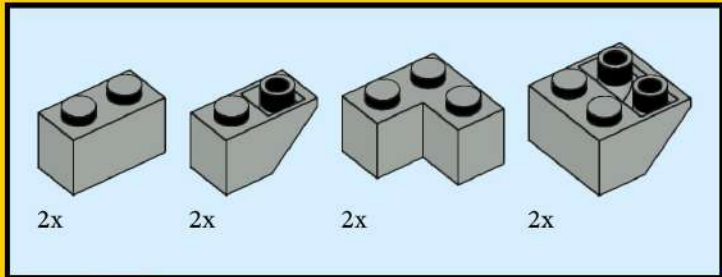
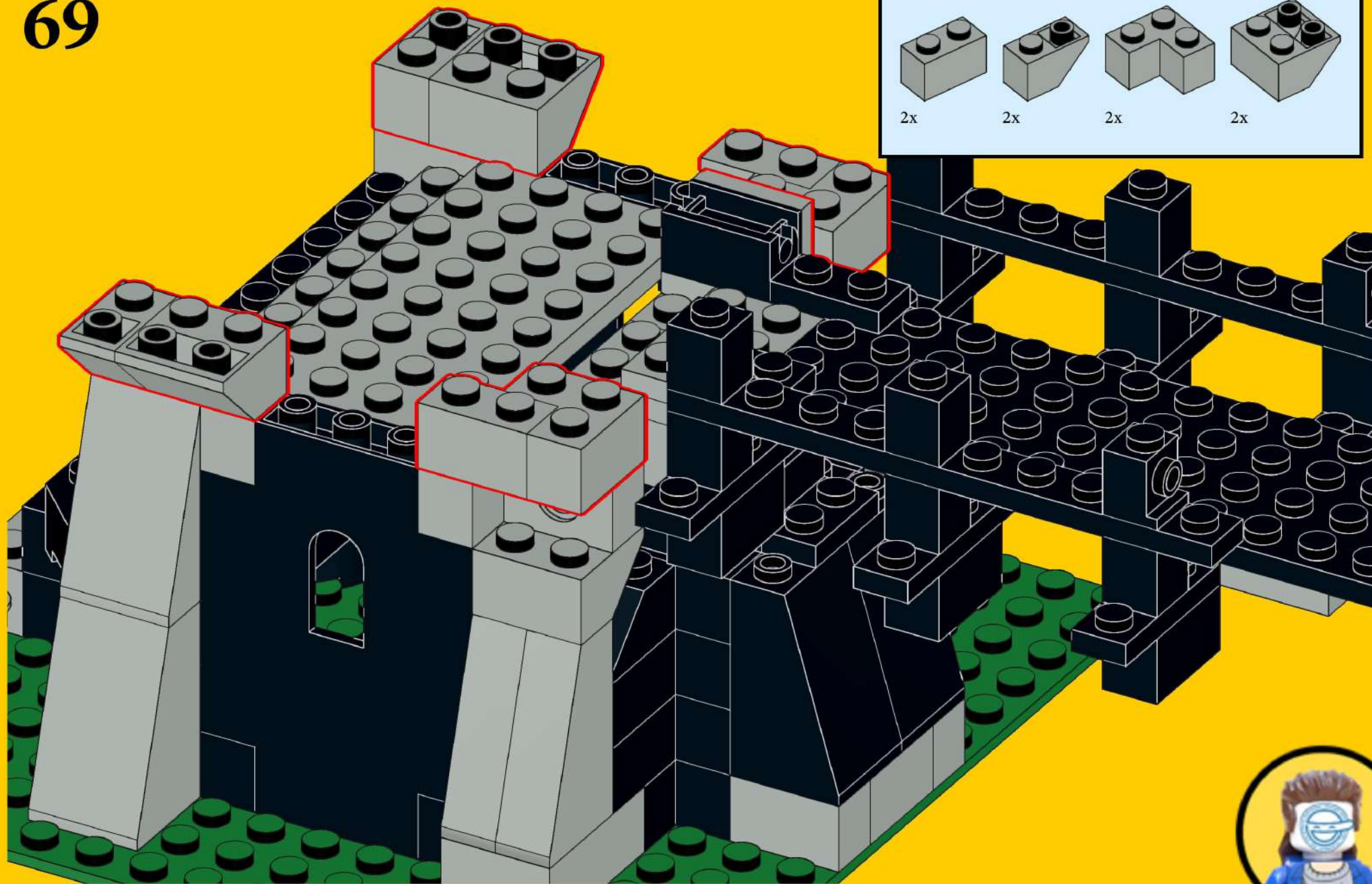

70

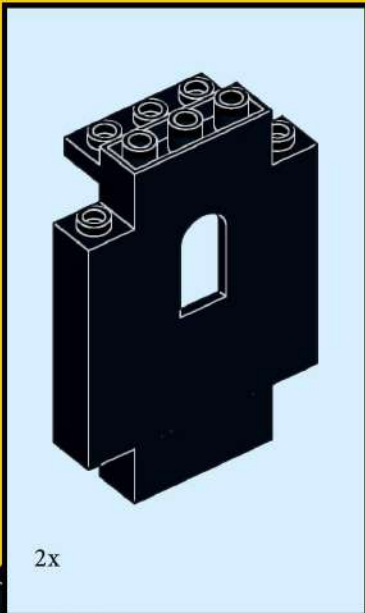
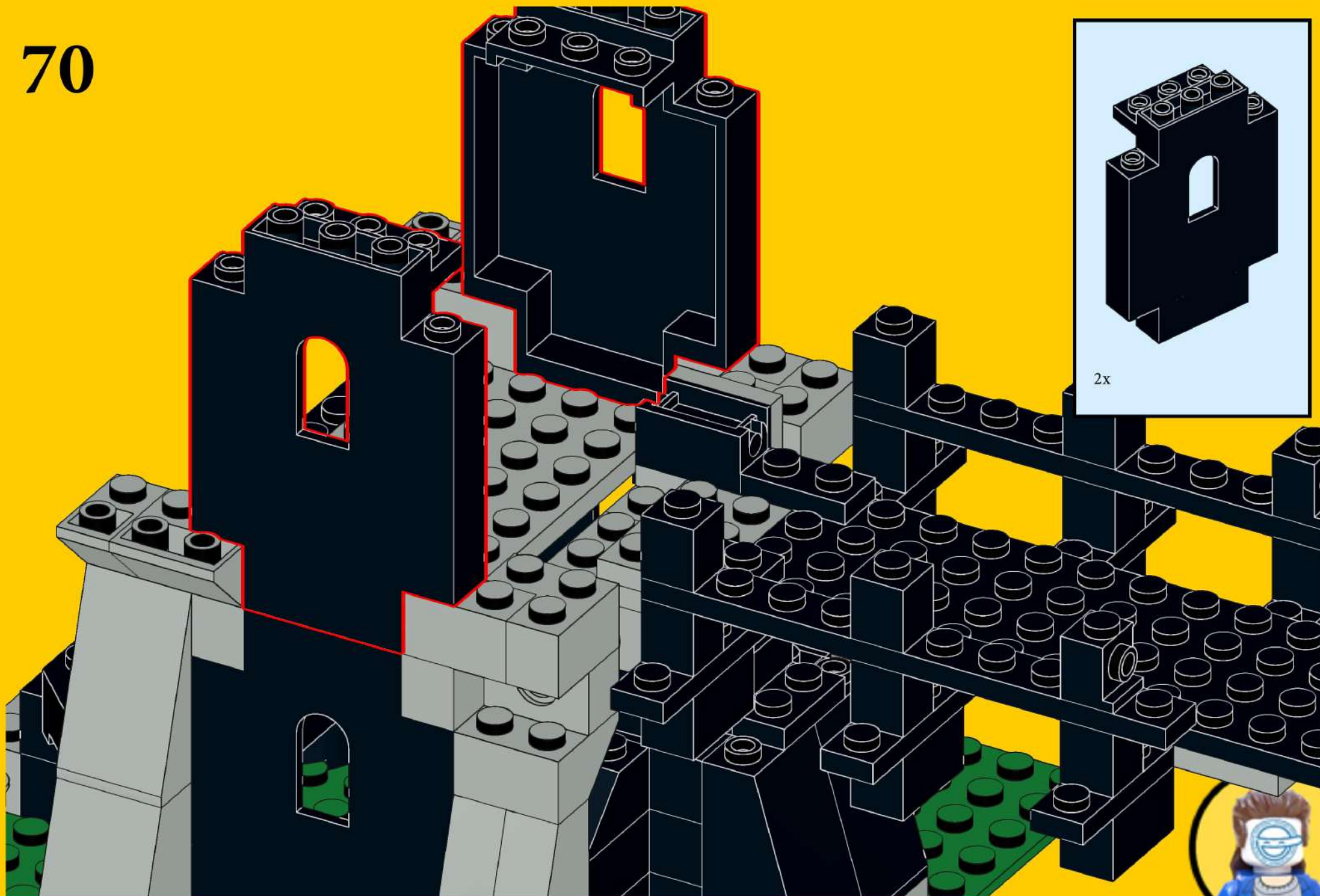



# 71

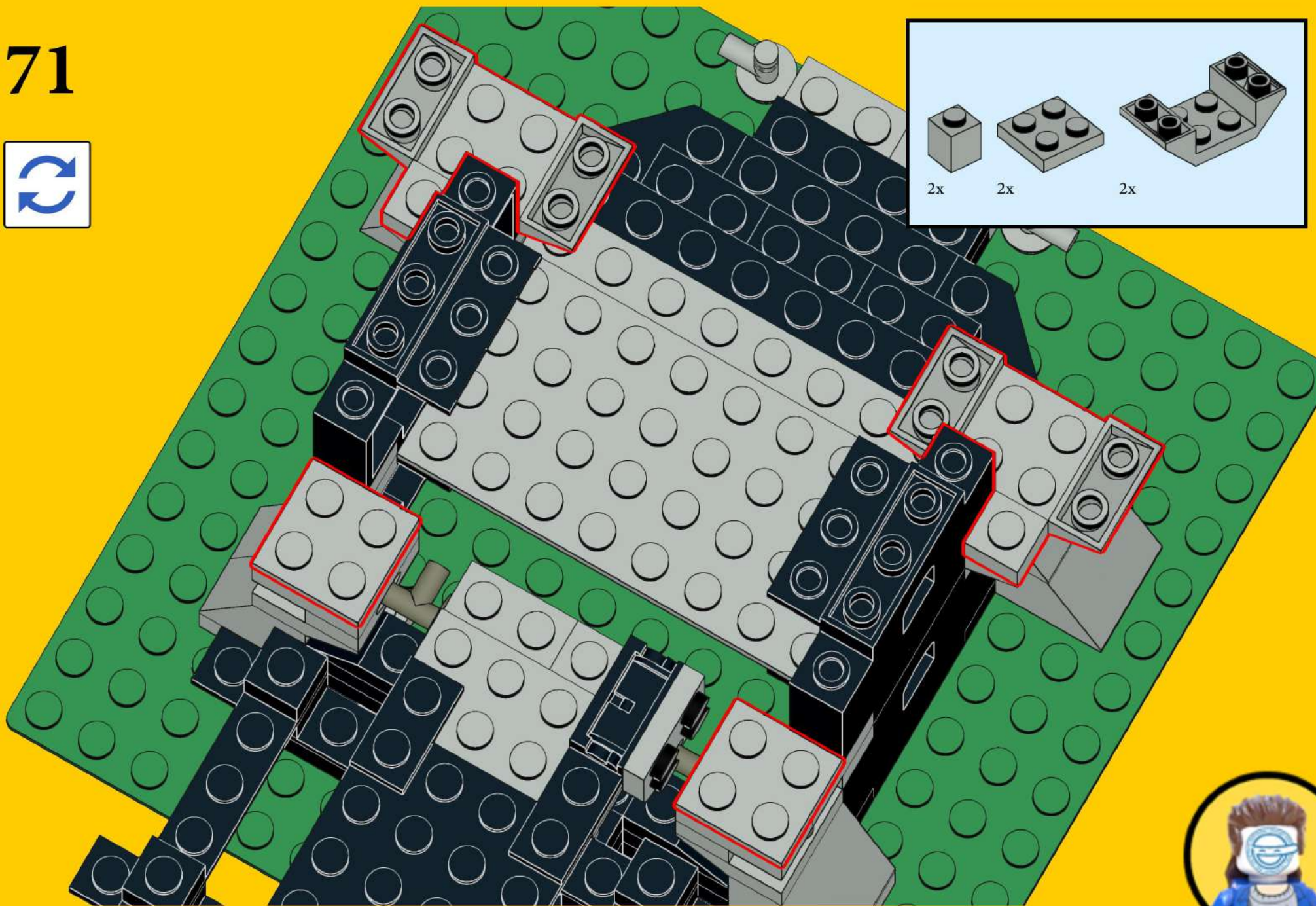

72

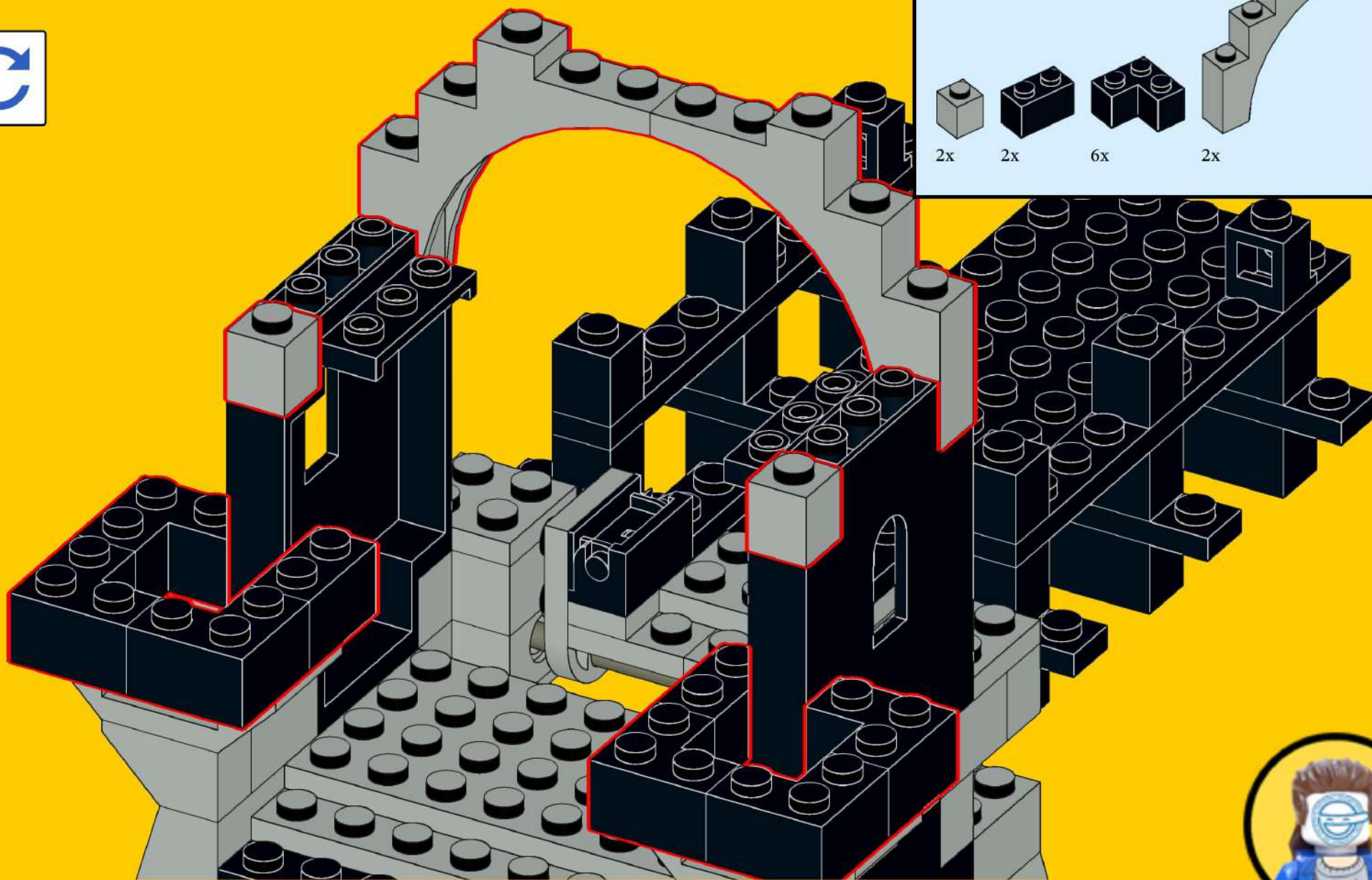

73

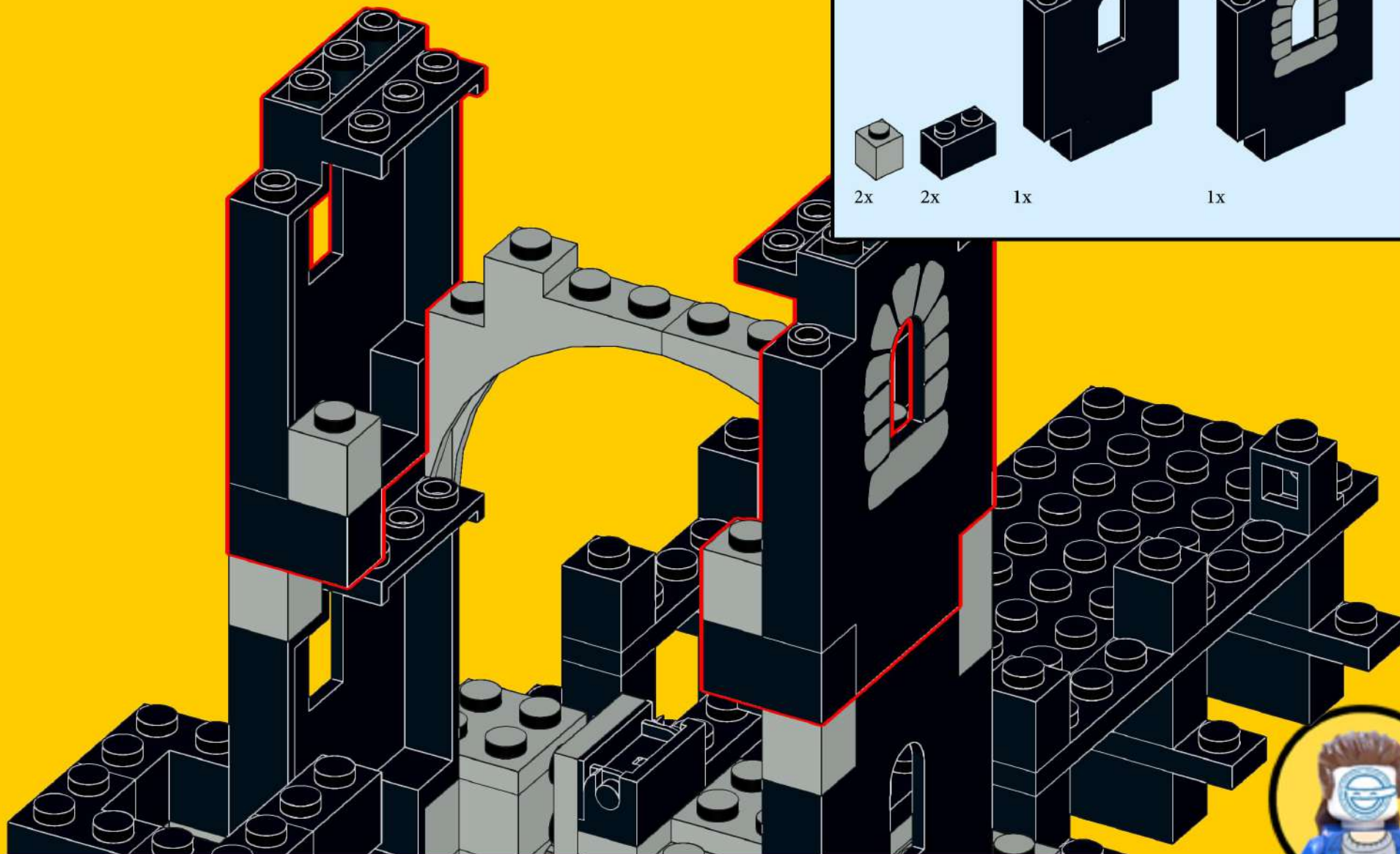

74

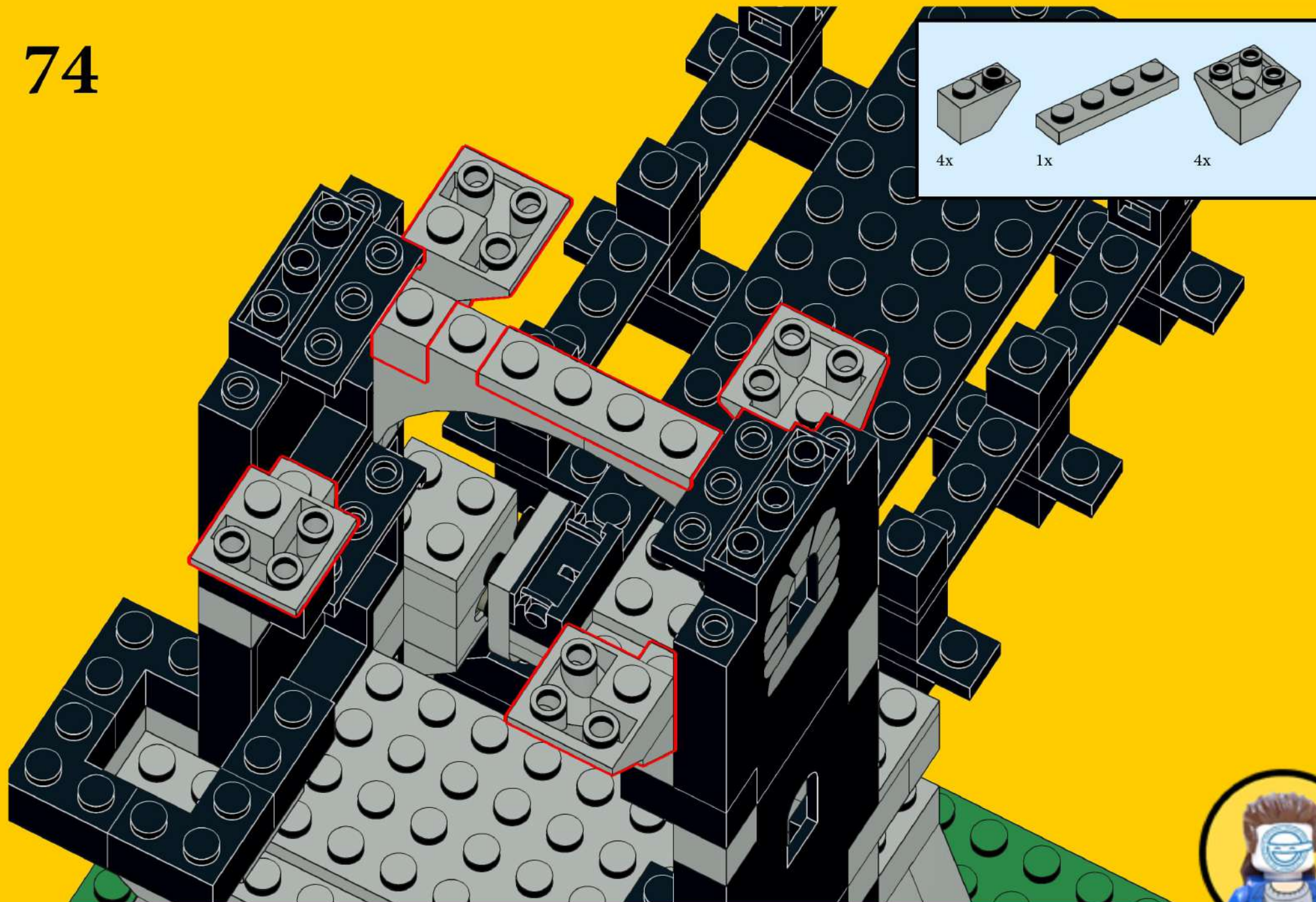

75

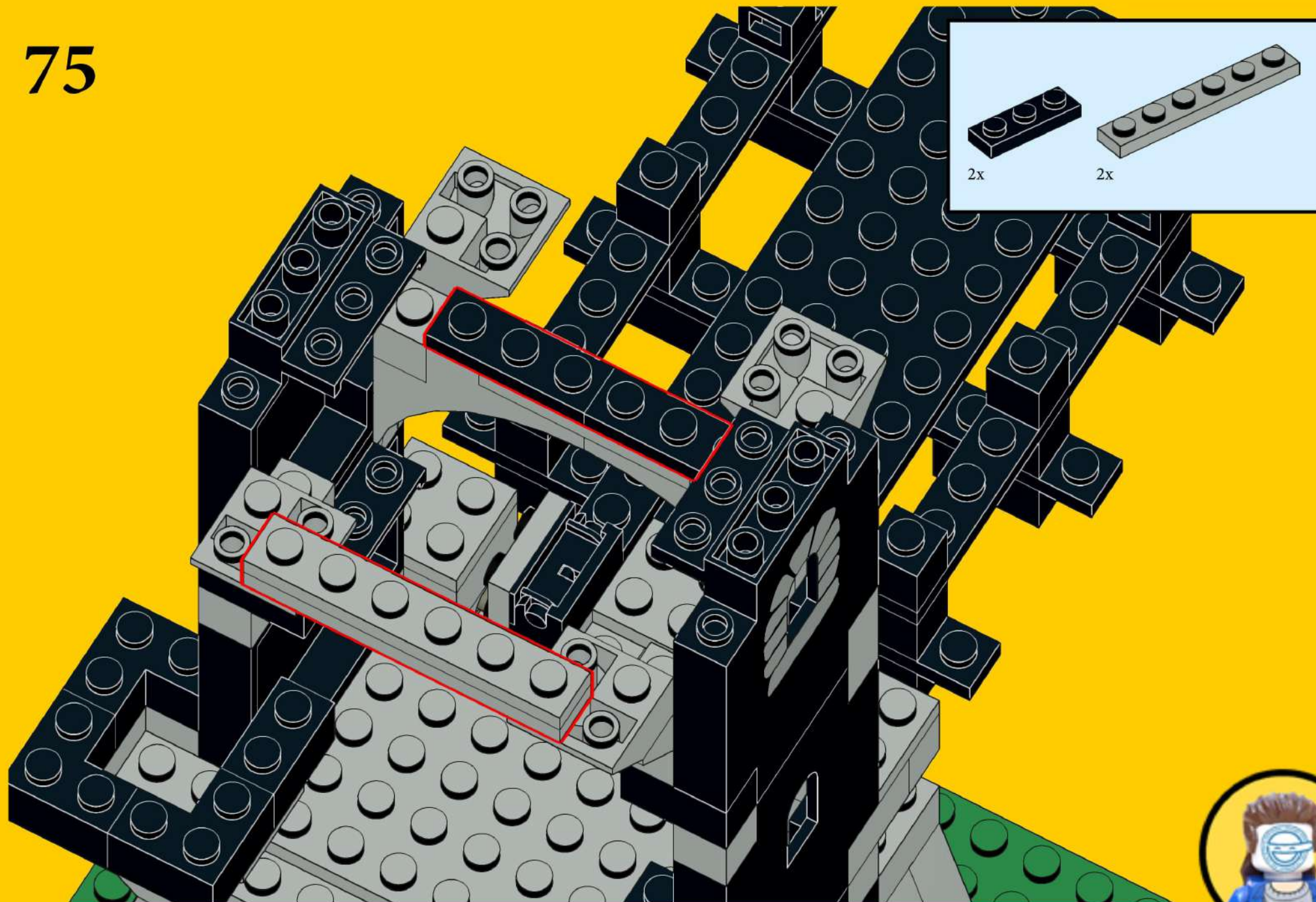

76

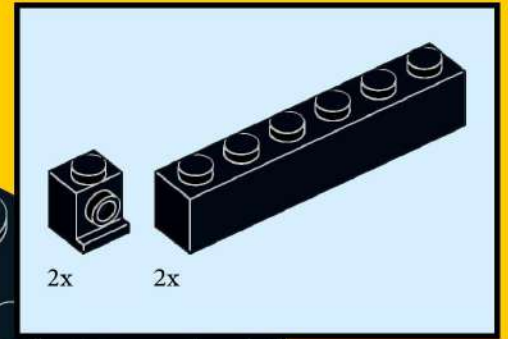
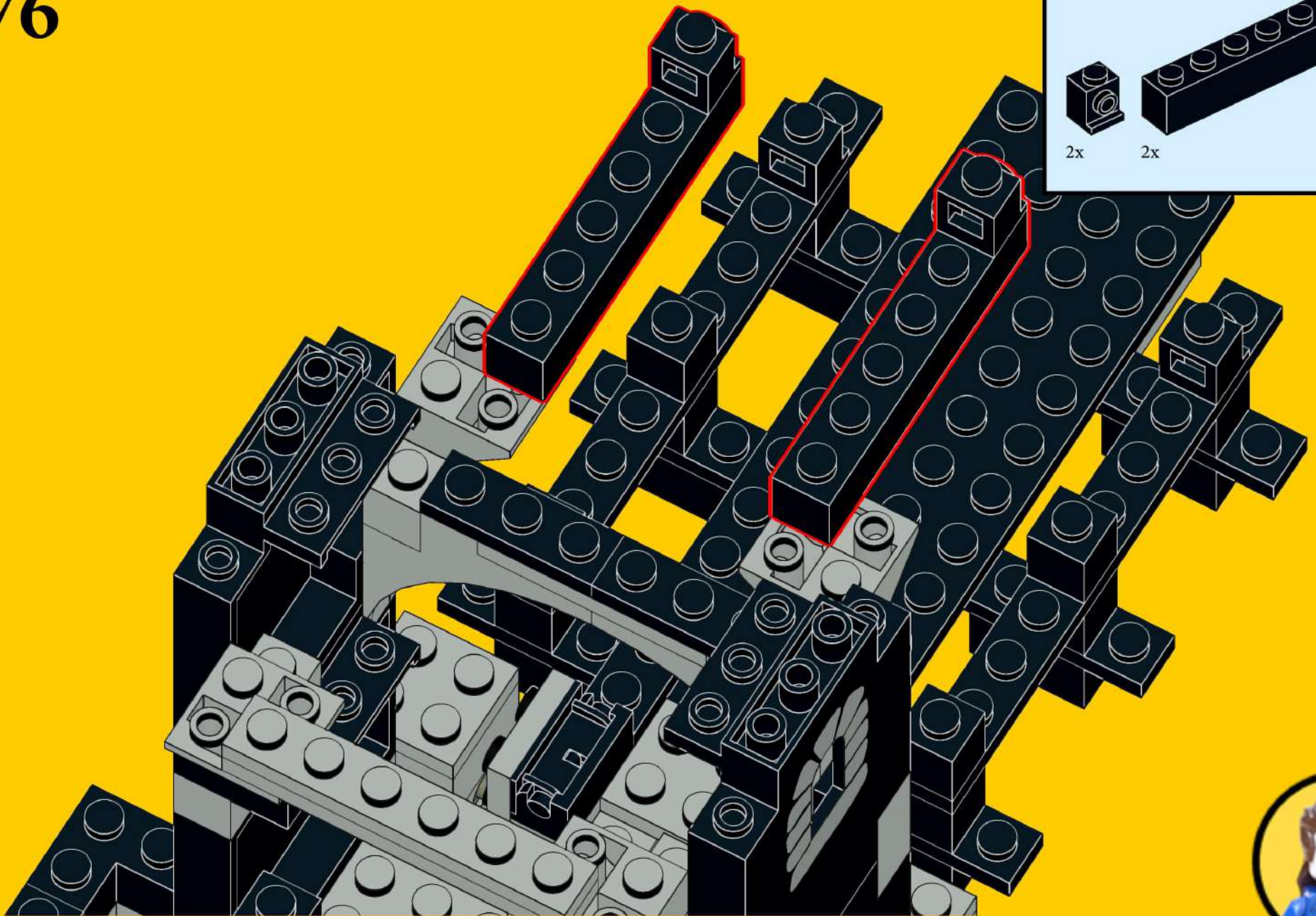

77

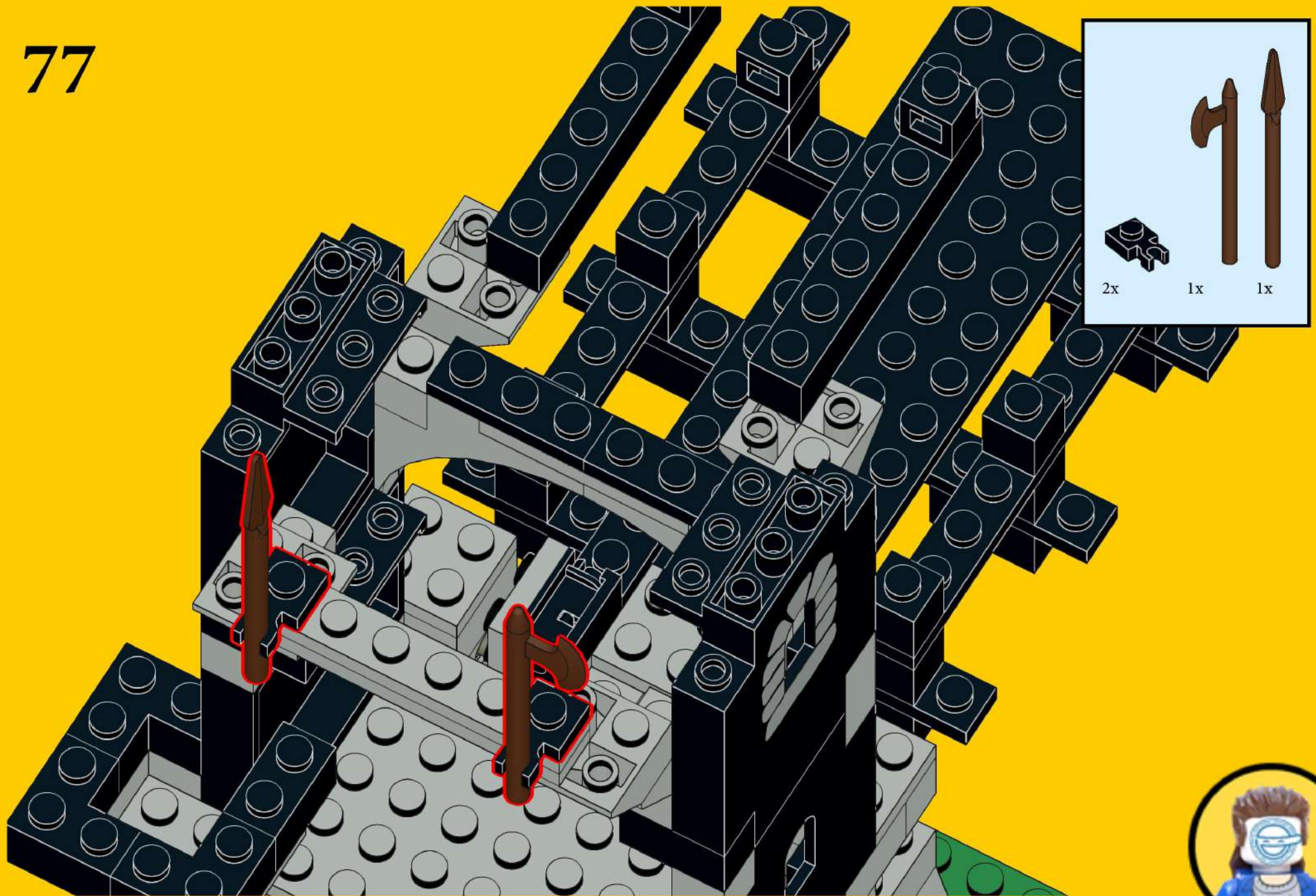

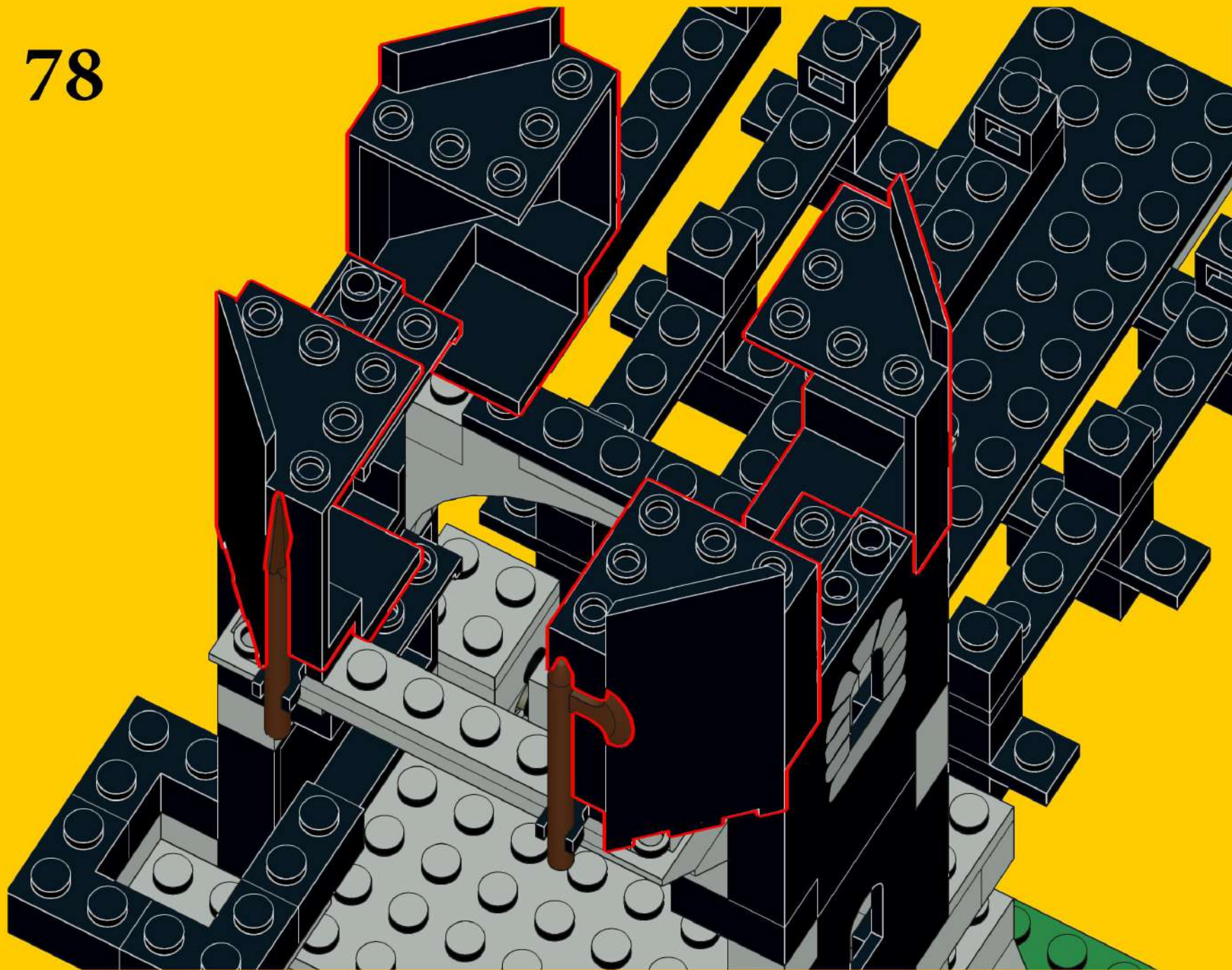

78



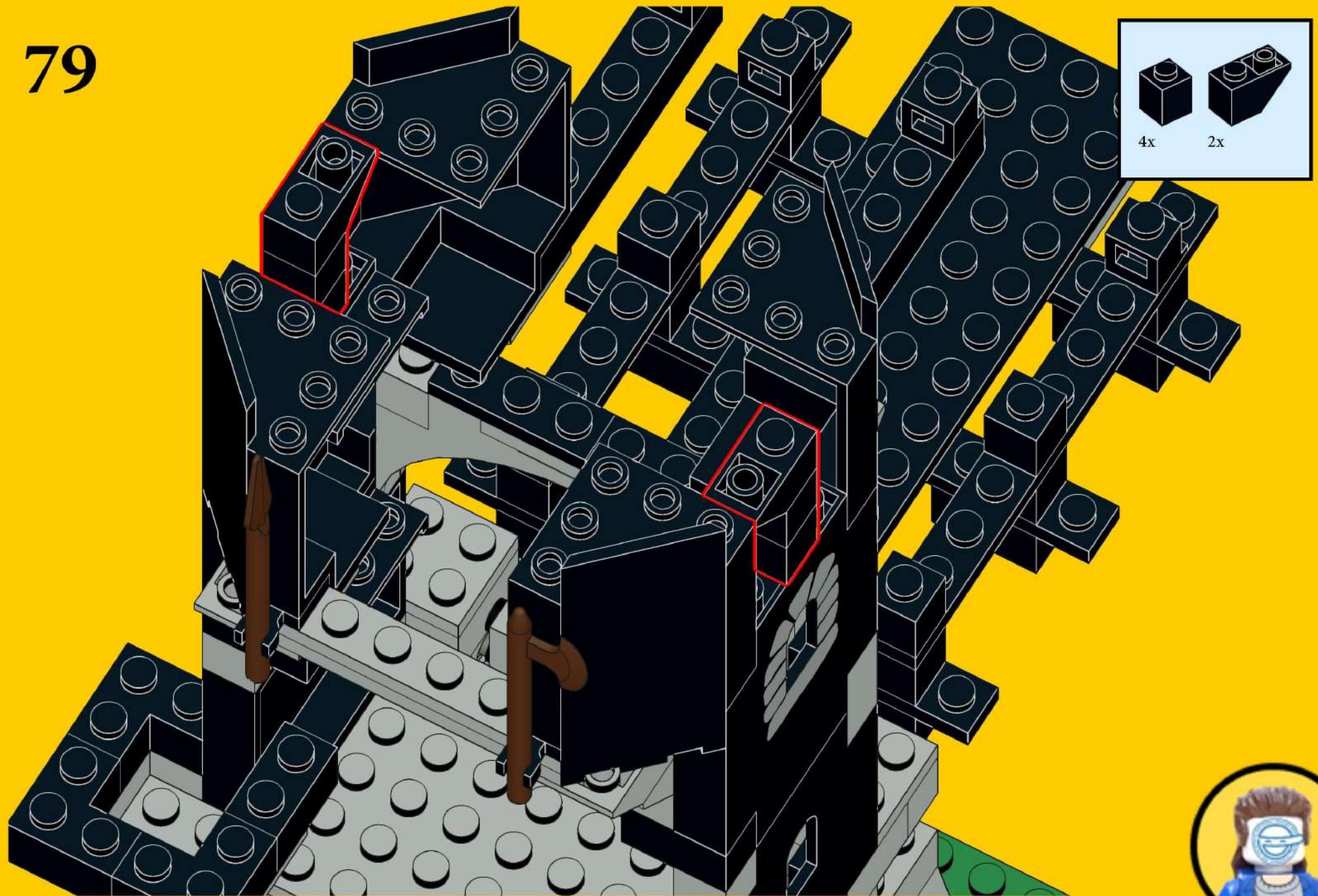

79

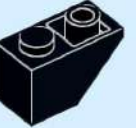

	
4x	2x



80

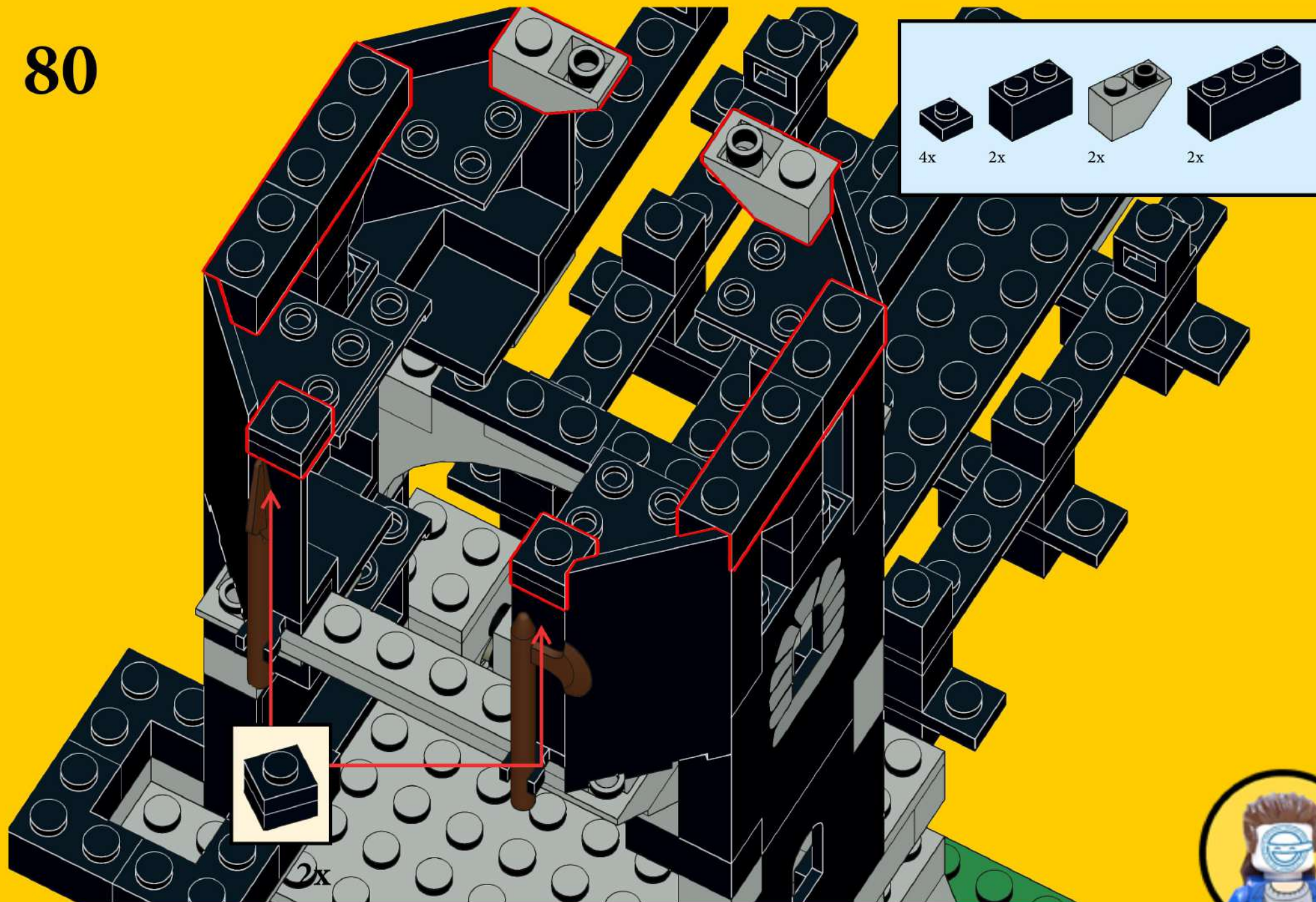

81

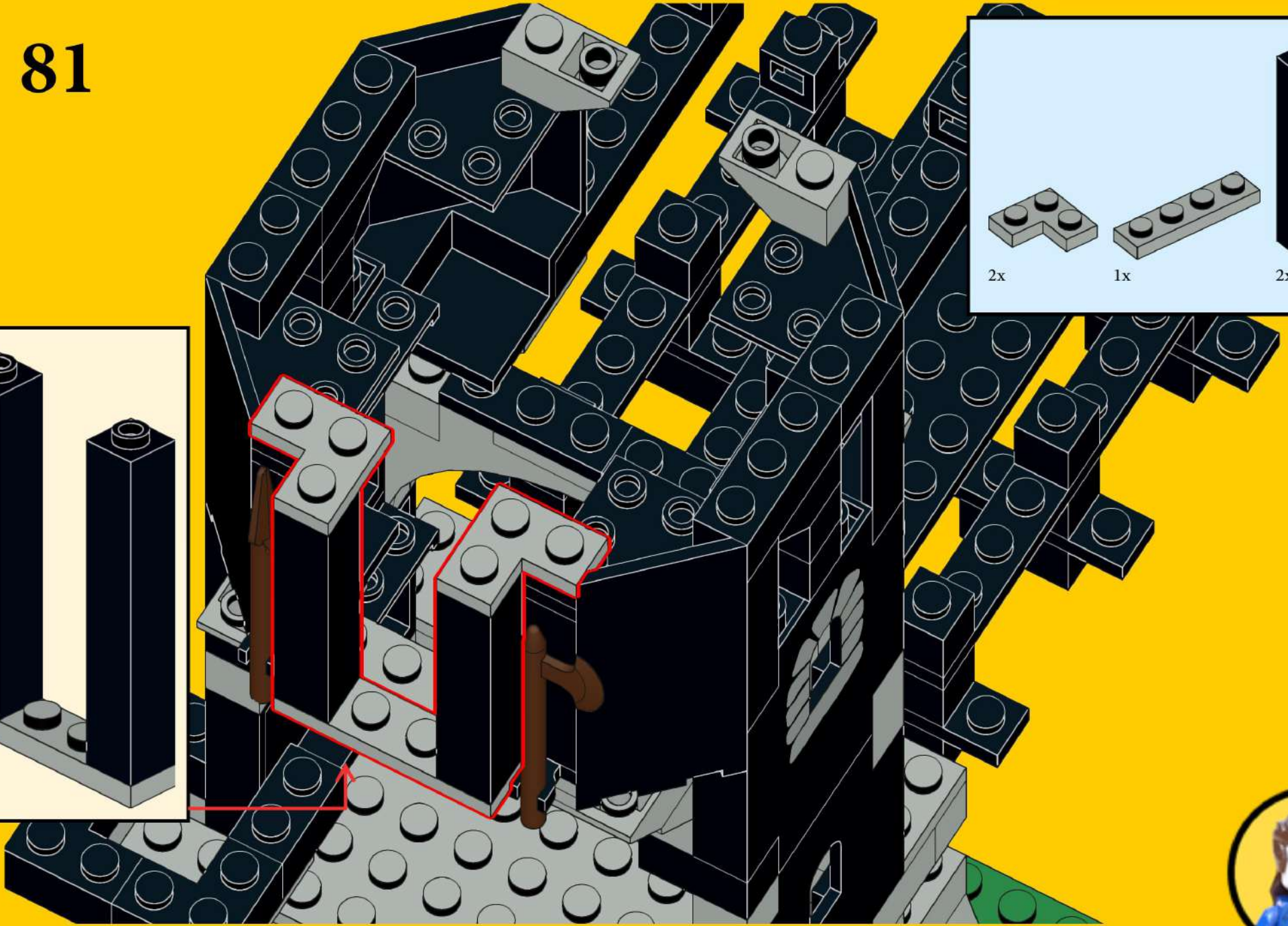
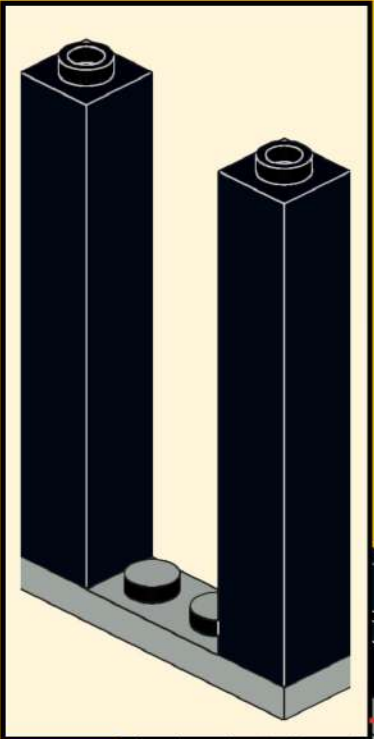
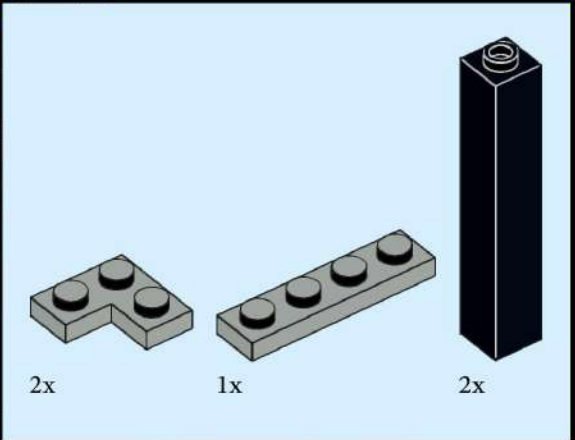

82

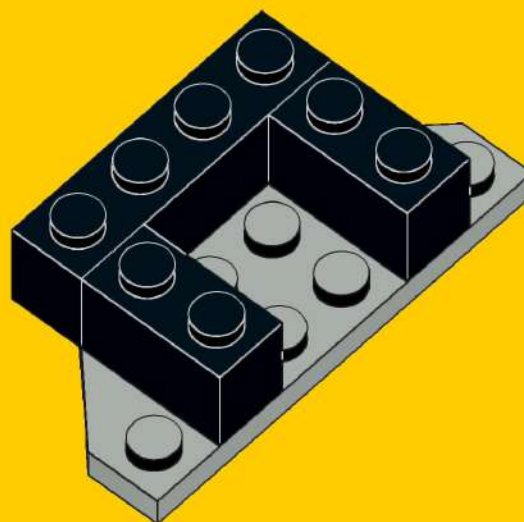
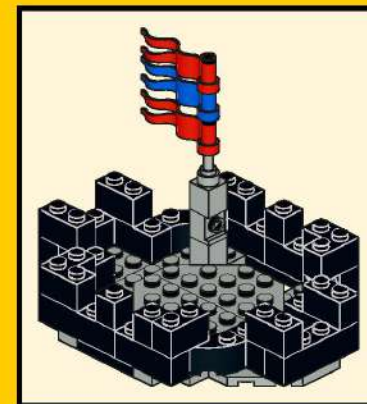
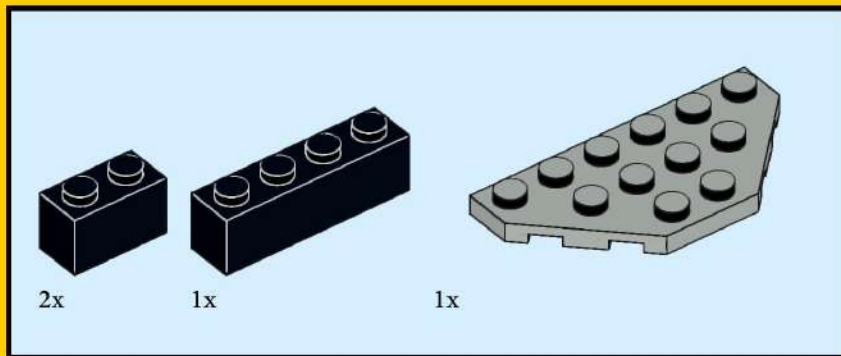

83

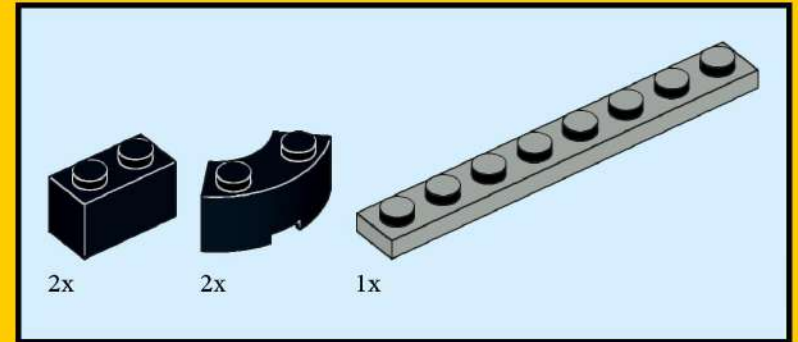
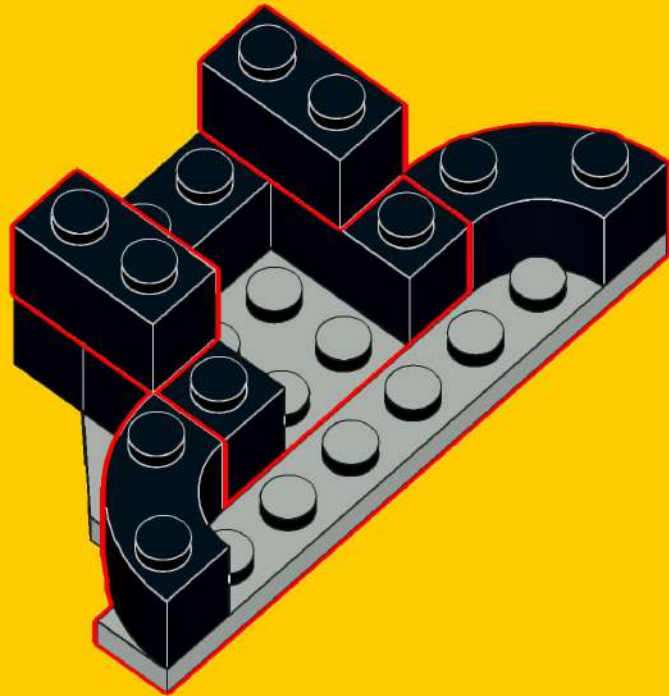

84

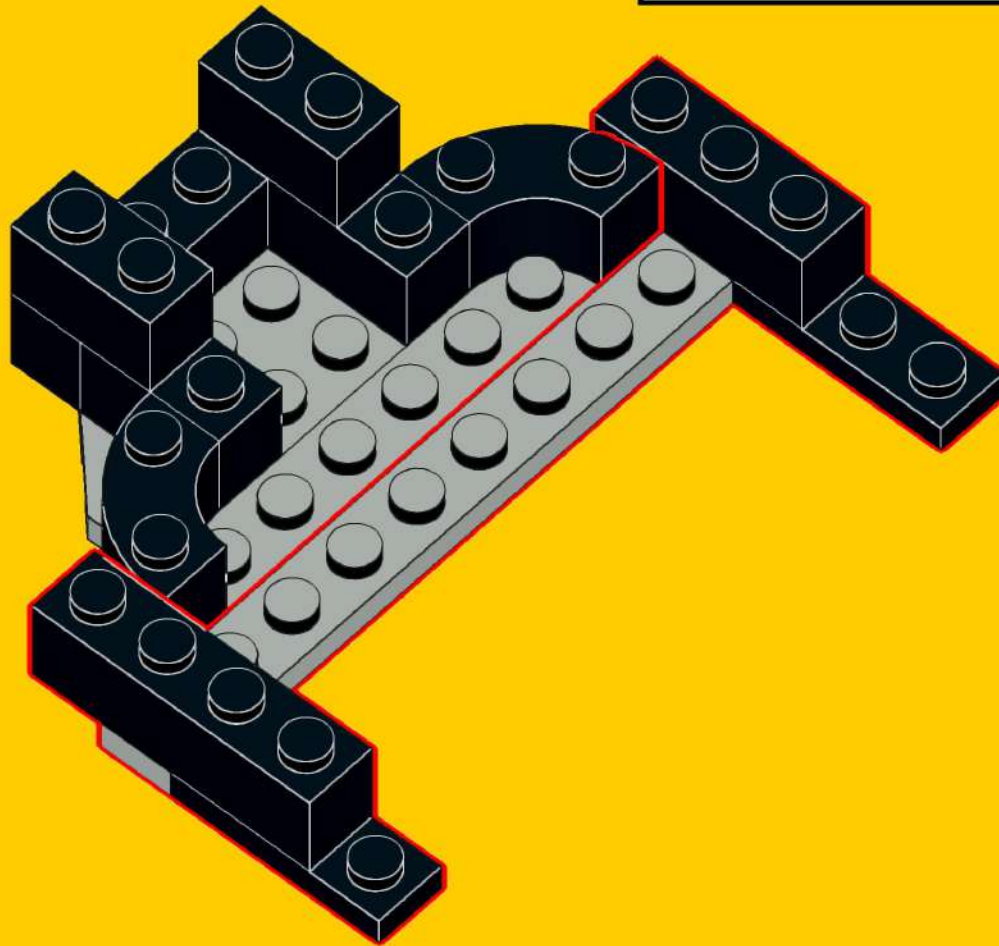
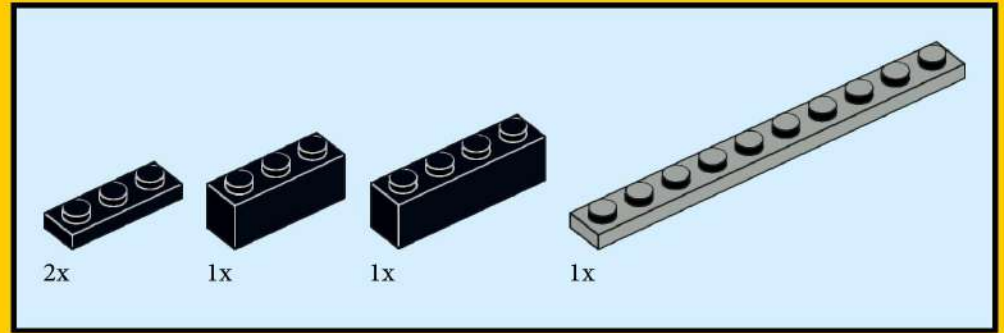

85

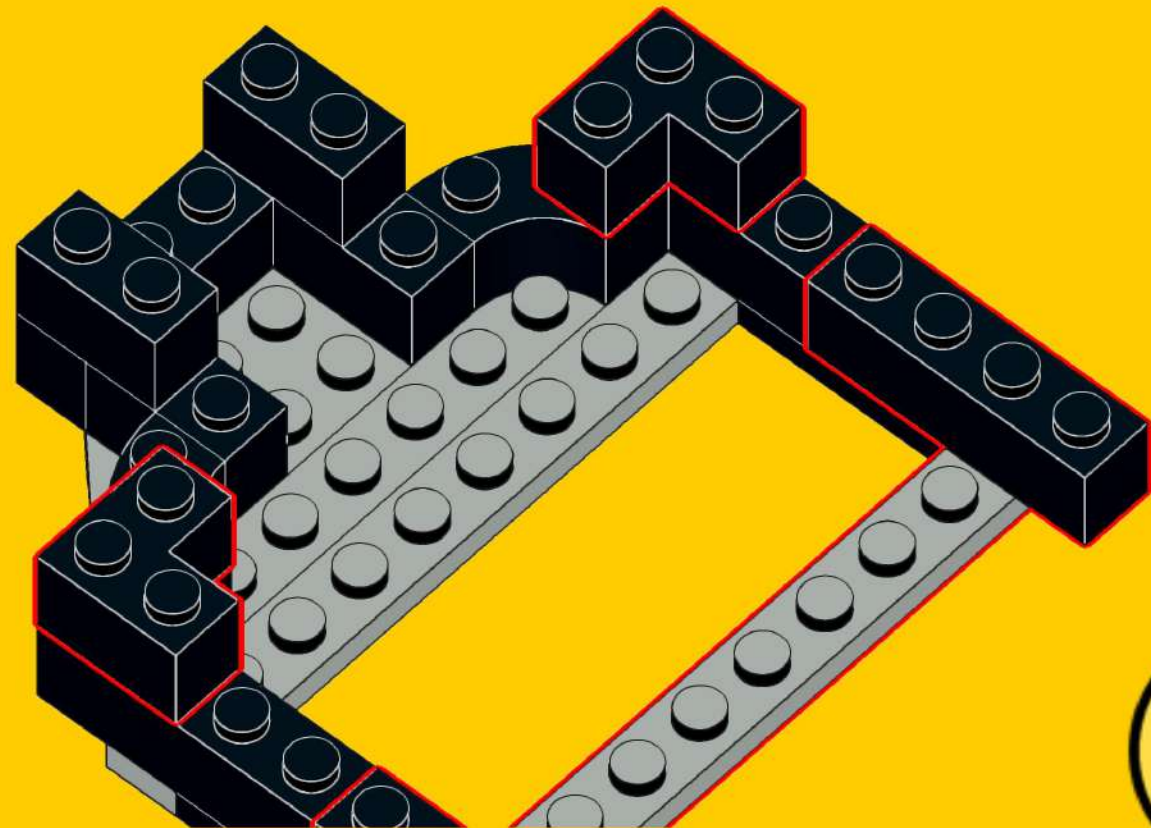
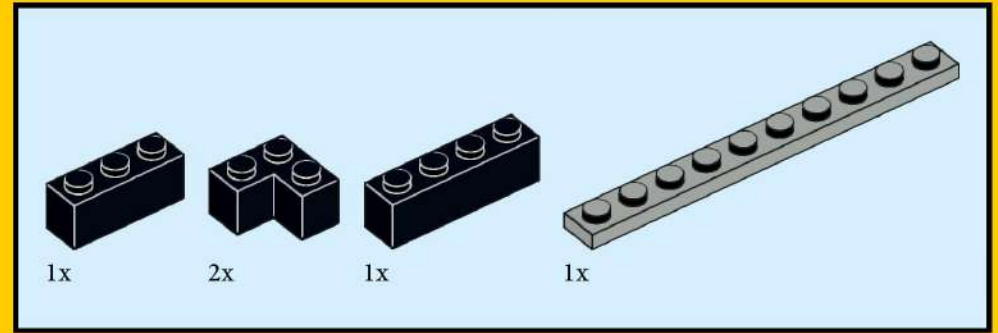

86

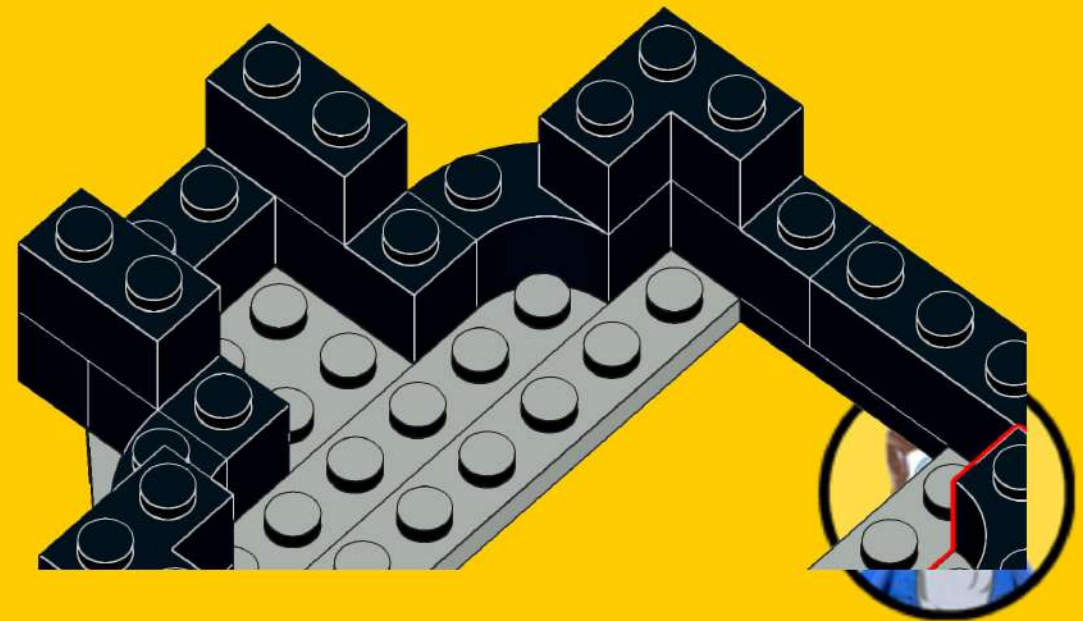
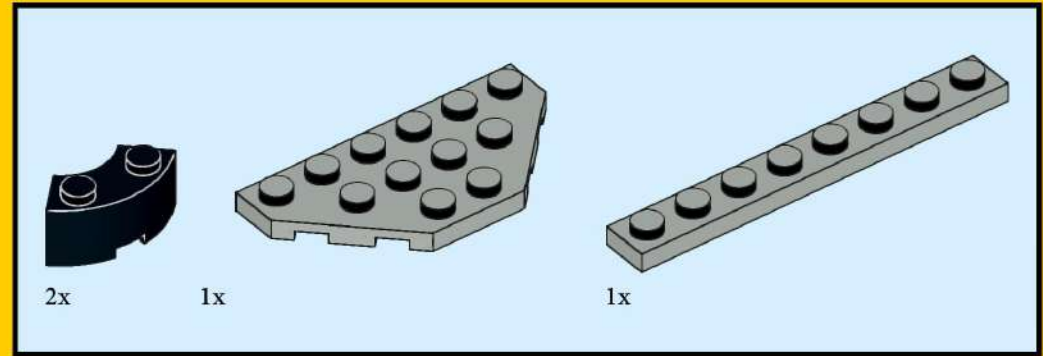



87

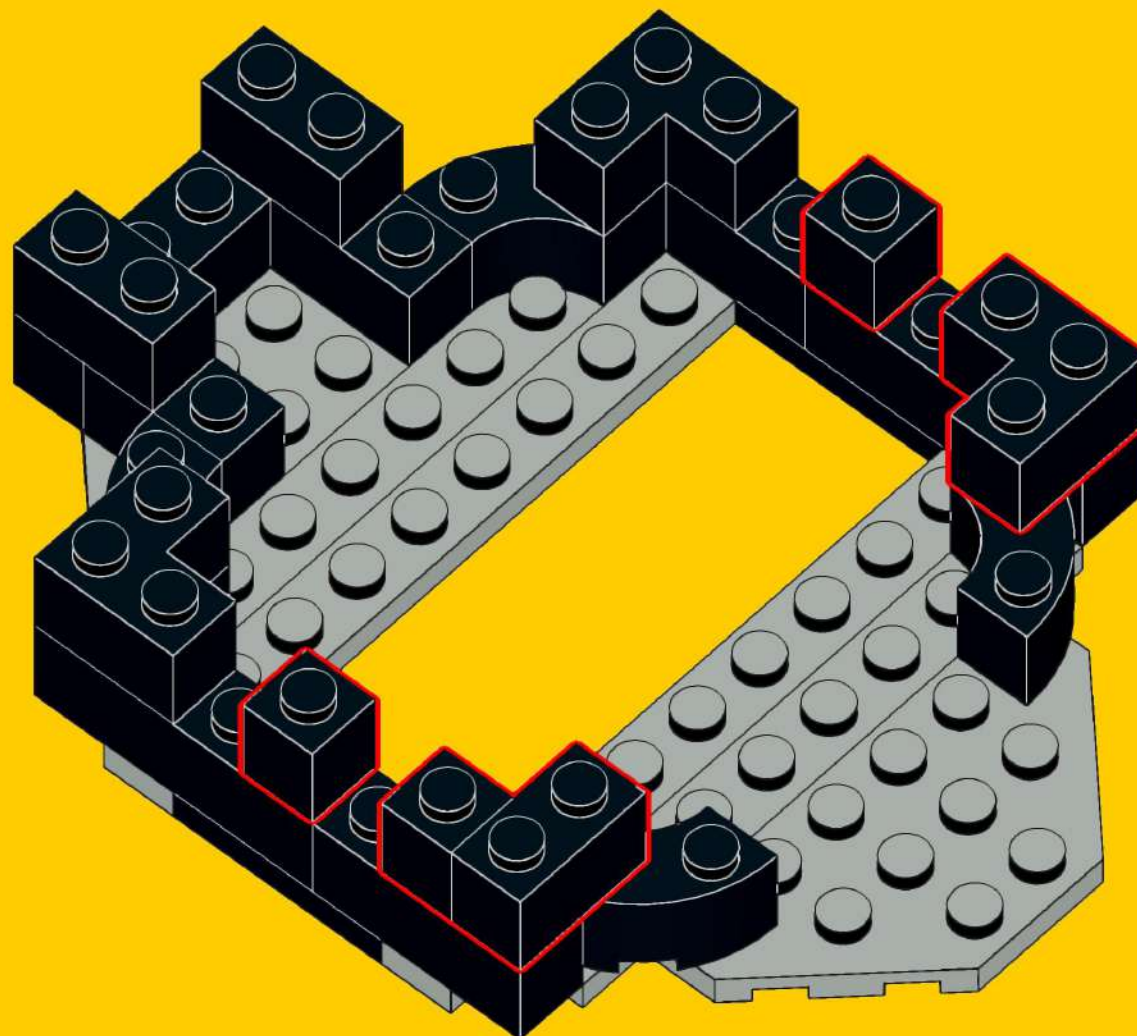
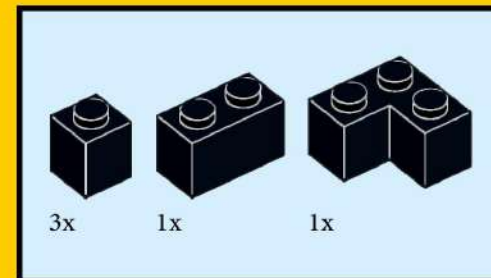

88

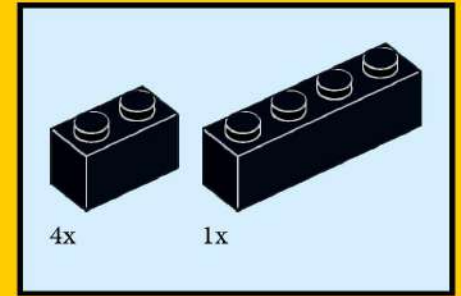

89

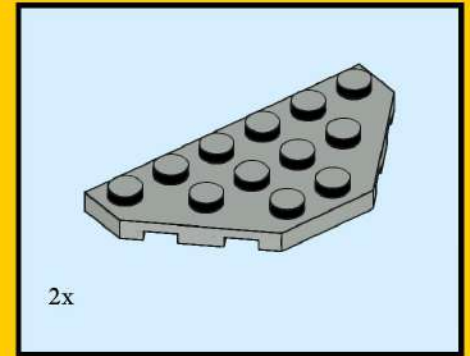



91

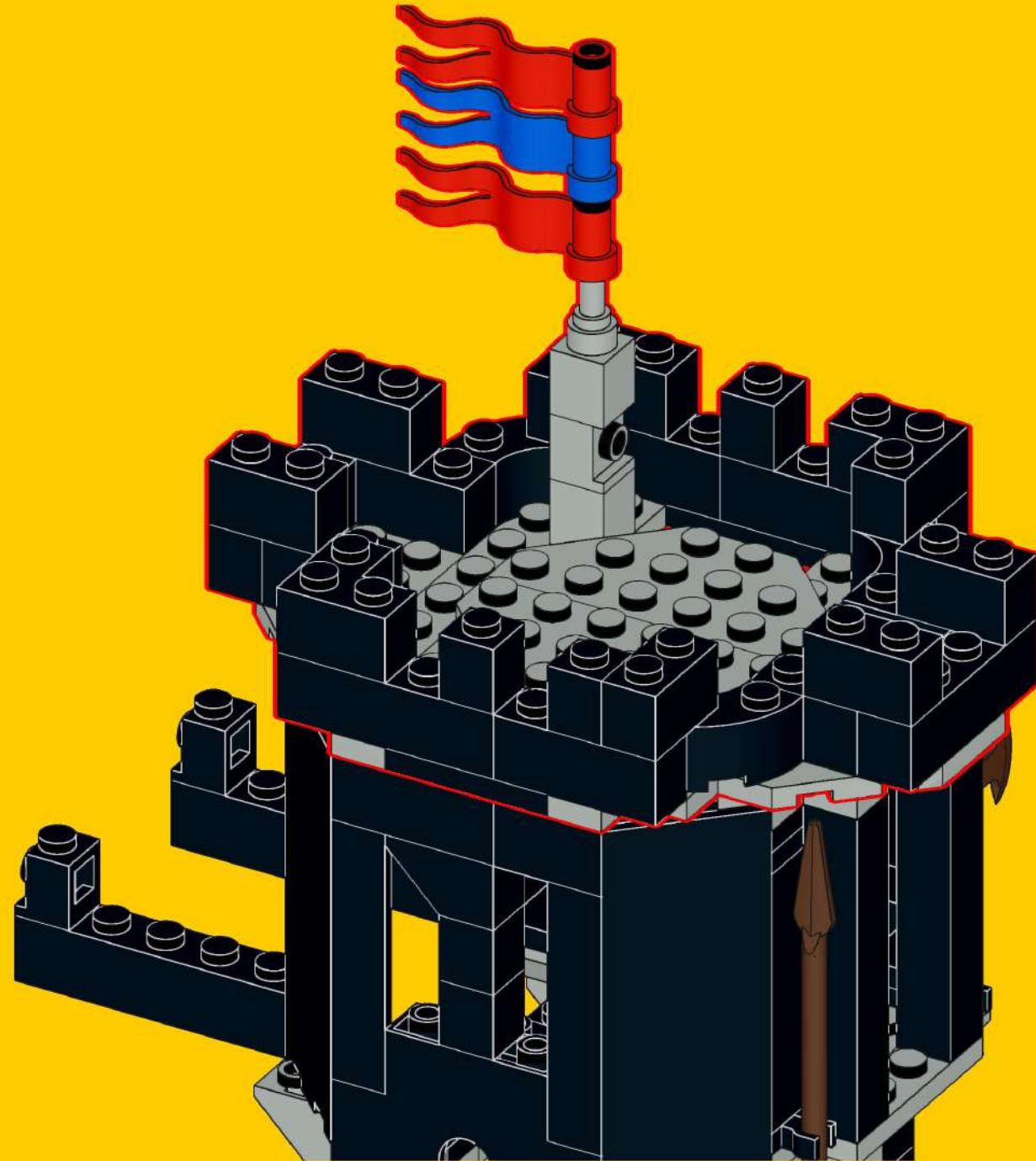

92

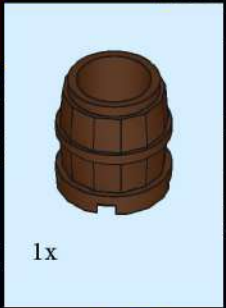

93



94



95



96



97





98



99



100



101



102



103



104



105



106

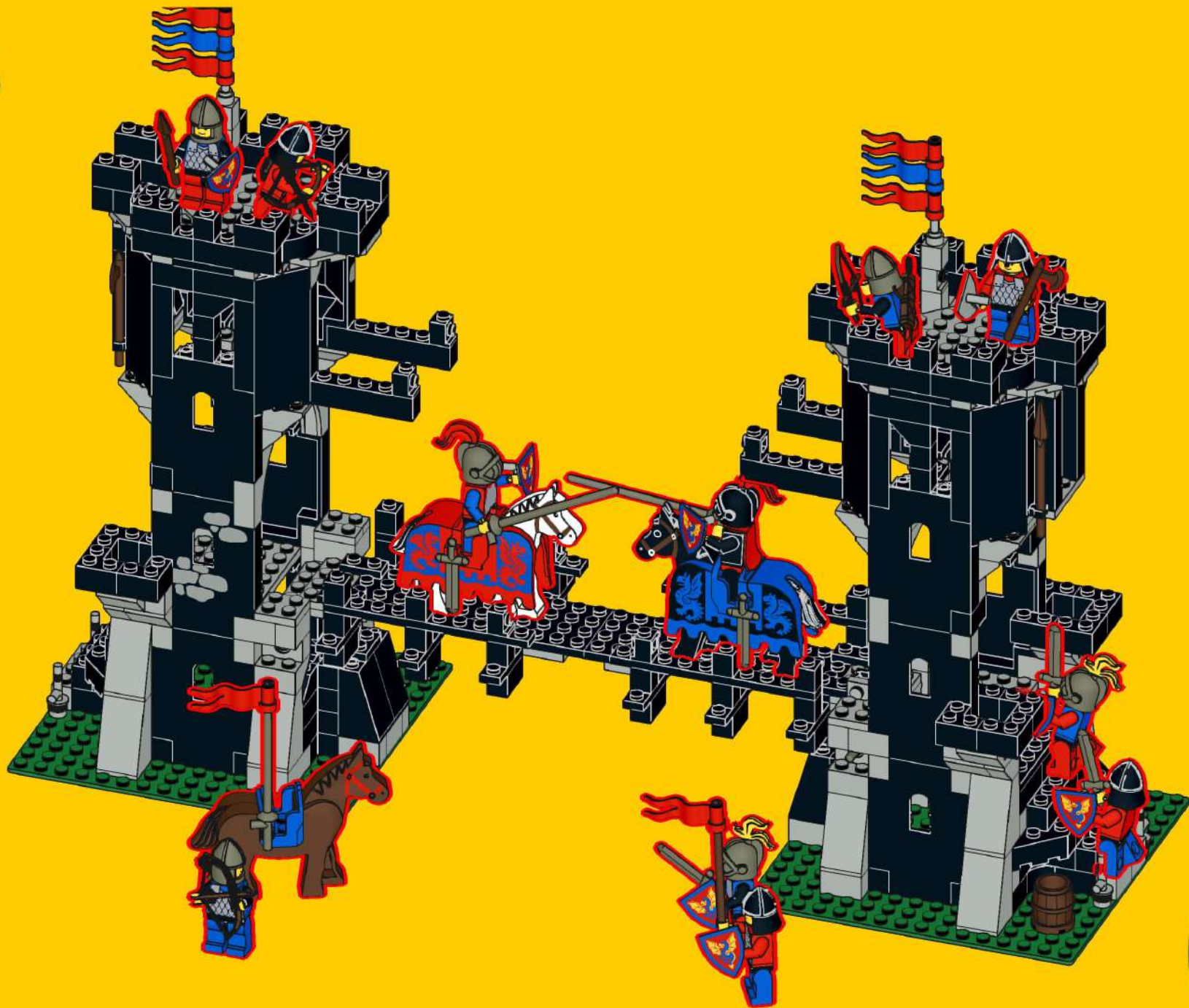

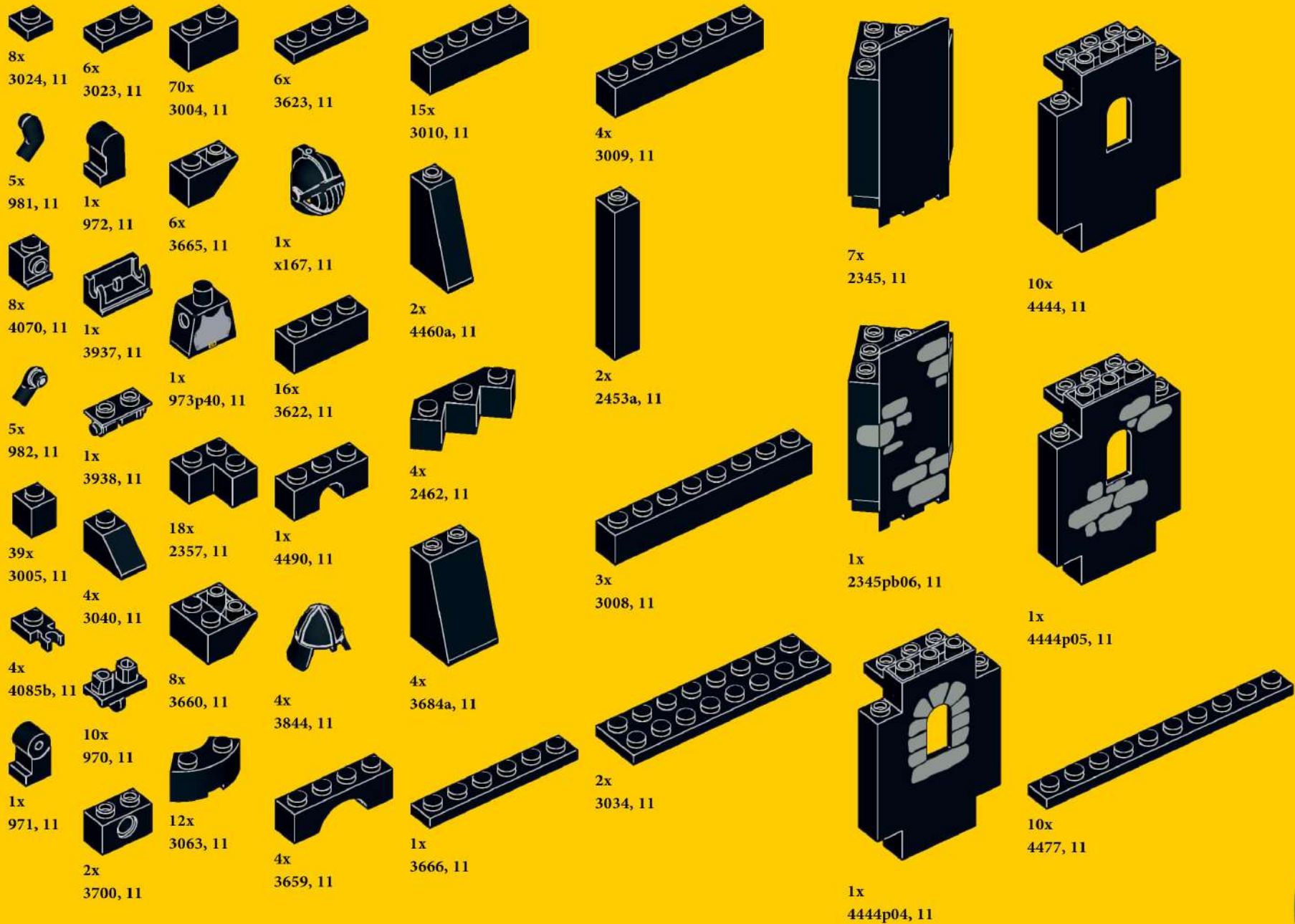



1x  
4493c01pb02, 11



2x  
3029, 11



3x  
3896, 10



3x  
x167, 10



5x  
3847, 10

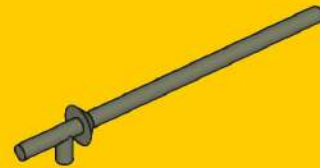

5x  
3849, 10



3x  
3024, 9



1x  
4070, 9



24x  
3005, 9



5x  
3023, 9



5x  
3700, 9



1x  
3040, 9



16x  
3665, 9

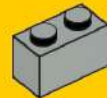

24x  
3004, 9



3x  
3022, 9



2x  
2420, 9



4x  
3959, 9



10x  
3660, 9



4x  
2357, 9



8x  
3676, 9



8x  
3846px10, 9



6x  
3021, 9



1x  
3176, 9



4x  
3002, 9

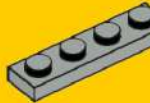

5x  
3710, 9

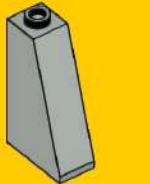

4x  
4460a, 9



4x  
3020, 9

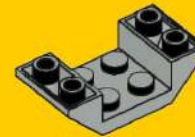

4x  
4871, 9



10x  
3684a, 9



2x  
3957, 9

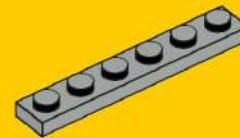

3x  
3666, 9

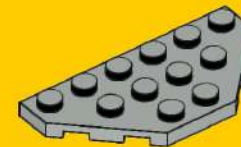

8x  
2419, 9



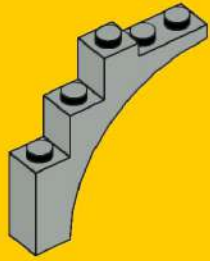

4x  
2339, 9

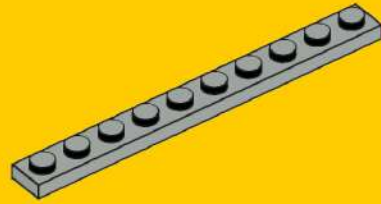

4x  
4477, 9



5x  
972, 5



1x  
973p40, 5



3x  
4498, 8



1x  
3849, 8



4x  
3460, 9

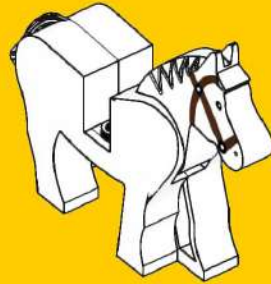

5x  
971, 5



6x  
4495a, 5



3x  
4499, 8



2x  
4502c, 5



1x  
970, 5



3x  
3848, 8



2x  
3034, 9

1x  
4493c01pb04, 1



1x  
2490pb02, 5

3x  
3848, 8

1x  
4493c01pb03, 8

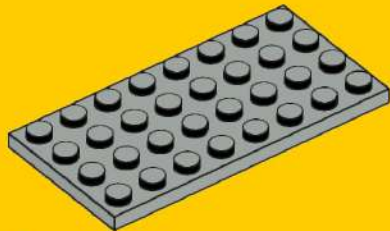

2x  
3035, 9



5x  
981, 5

1x  
4524, 5



1x  
2489, 8



3x  
4497, 8



22x  
983, 3



5x  
982, 5



4x  
973p41, 5



11x  
3626ap01, 3





2x  
4502b, 3

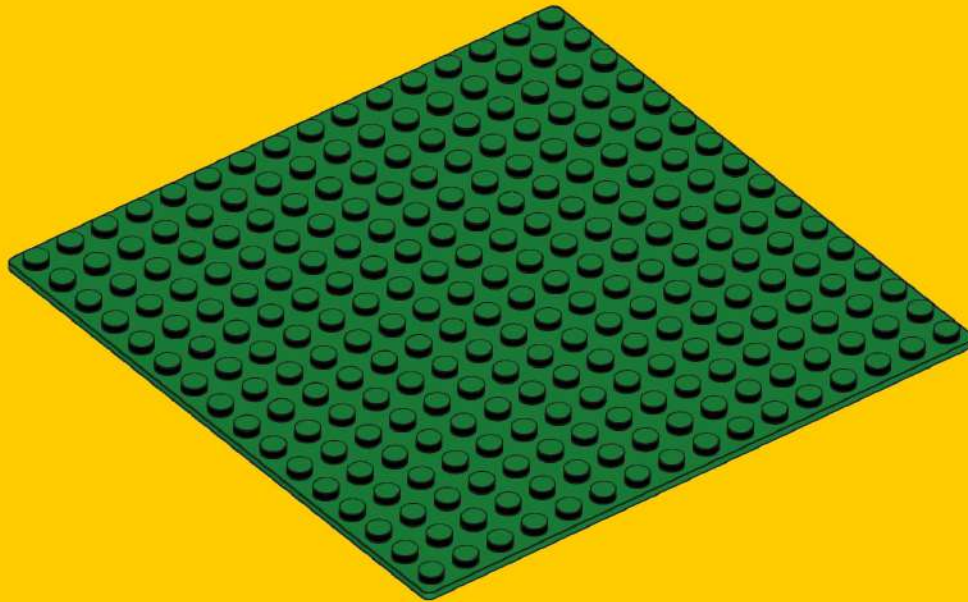

2x  
3867, 6



1x  
982, 7



1x  
981, 7



5x  
972, 7



5x  
971, 7



2x  
973p40, 7



3x  
973p41, 7



2x  
4495a, 7

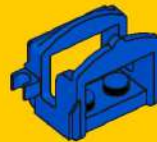

1x  
4491a, 7



1x  
2490px2, 7

