

IDEAS 250: Fortress Building Site - Castle Entrance

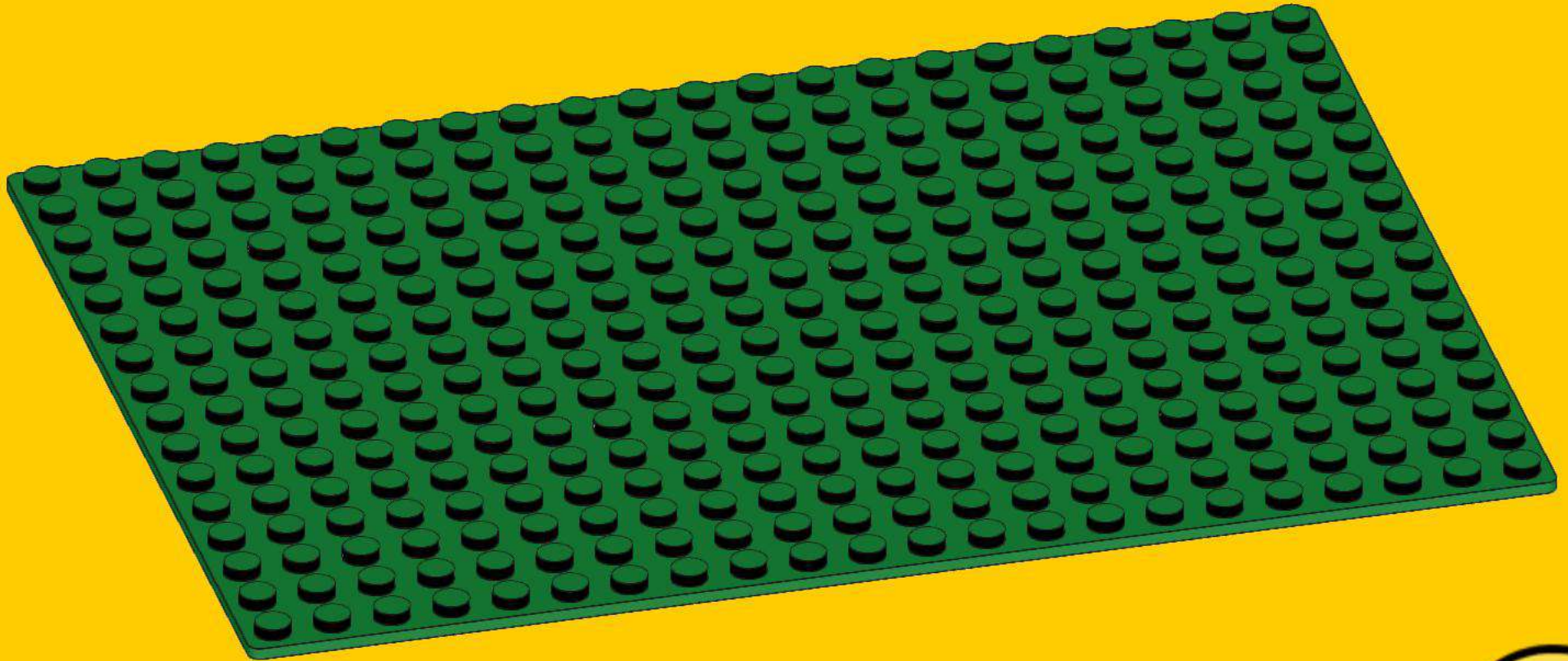

1

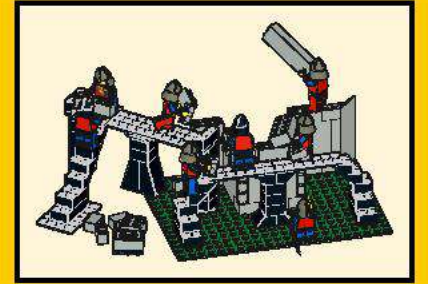

2

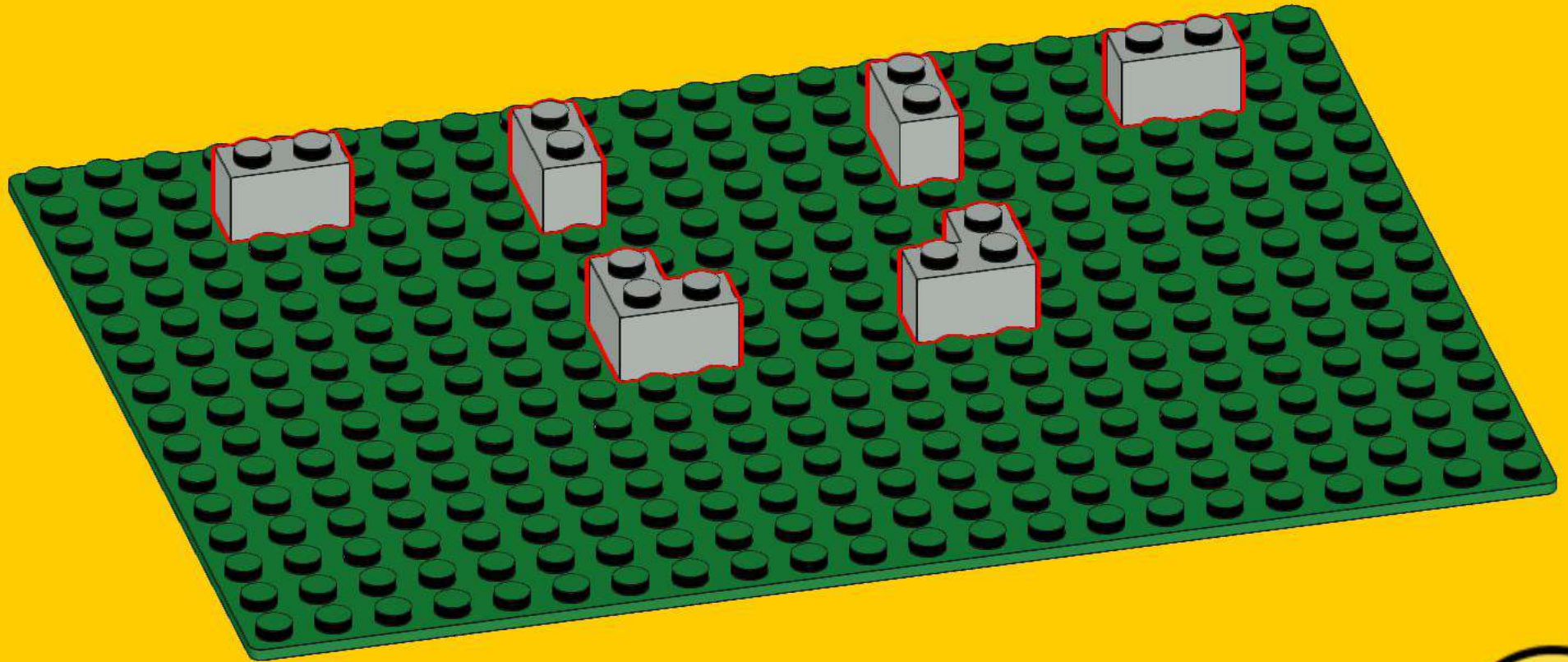
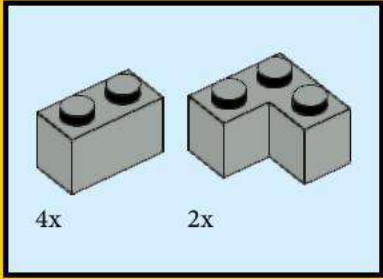

3

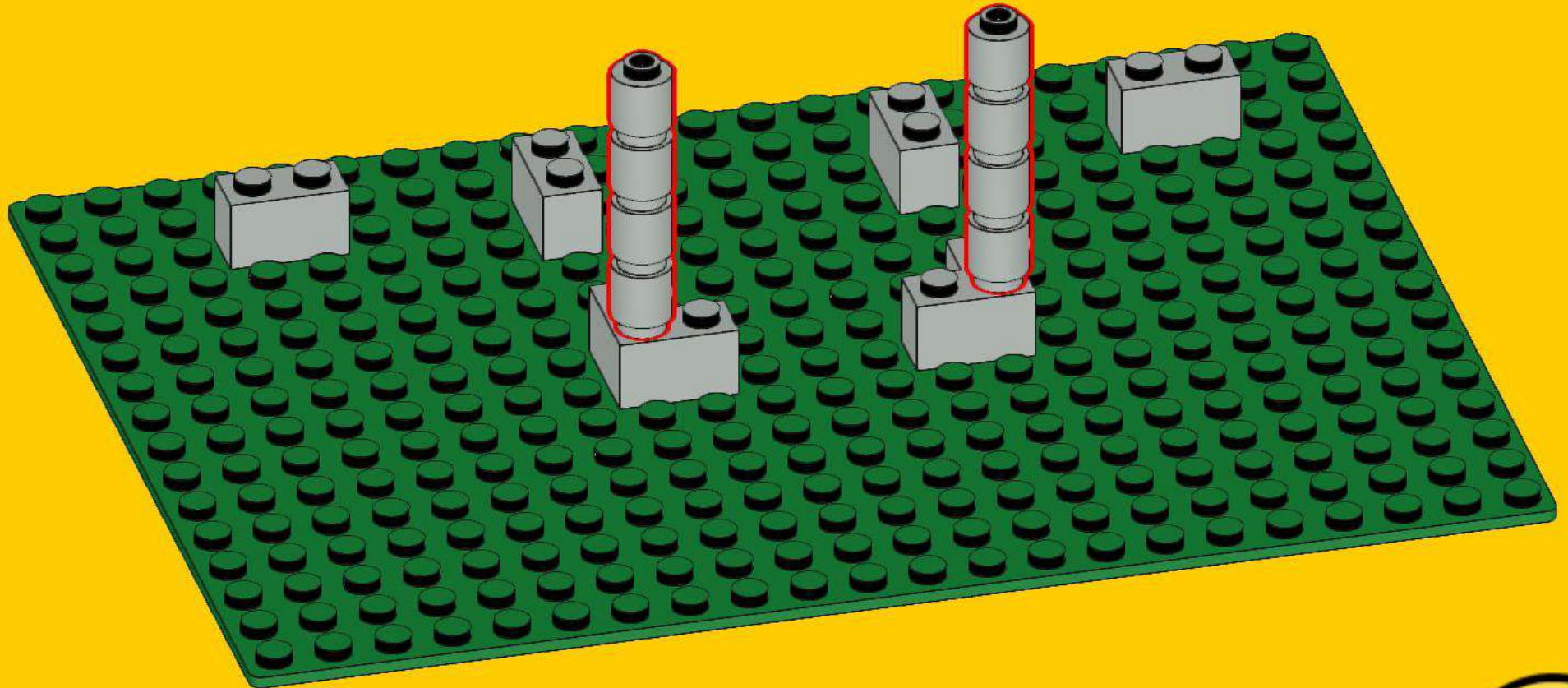

4

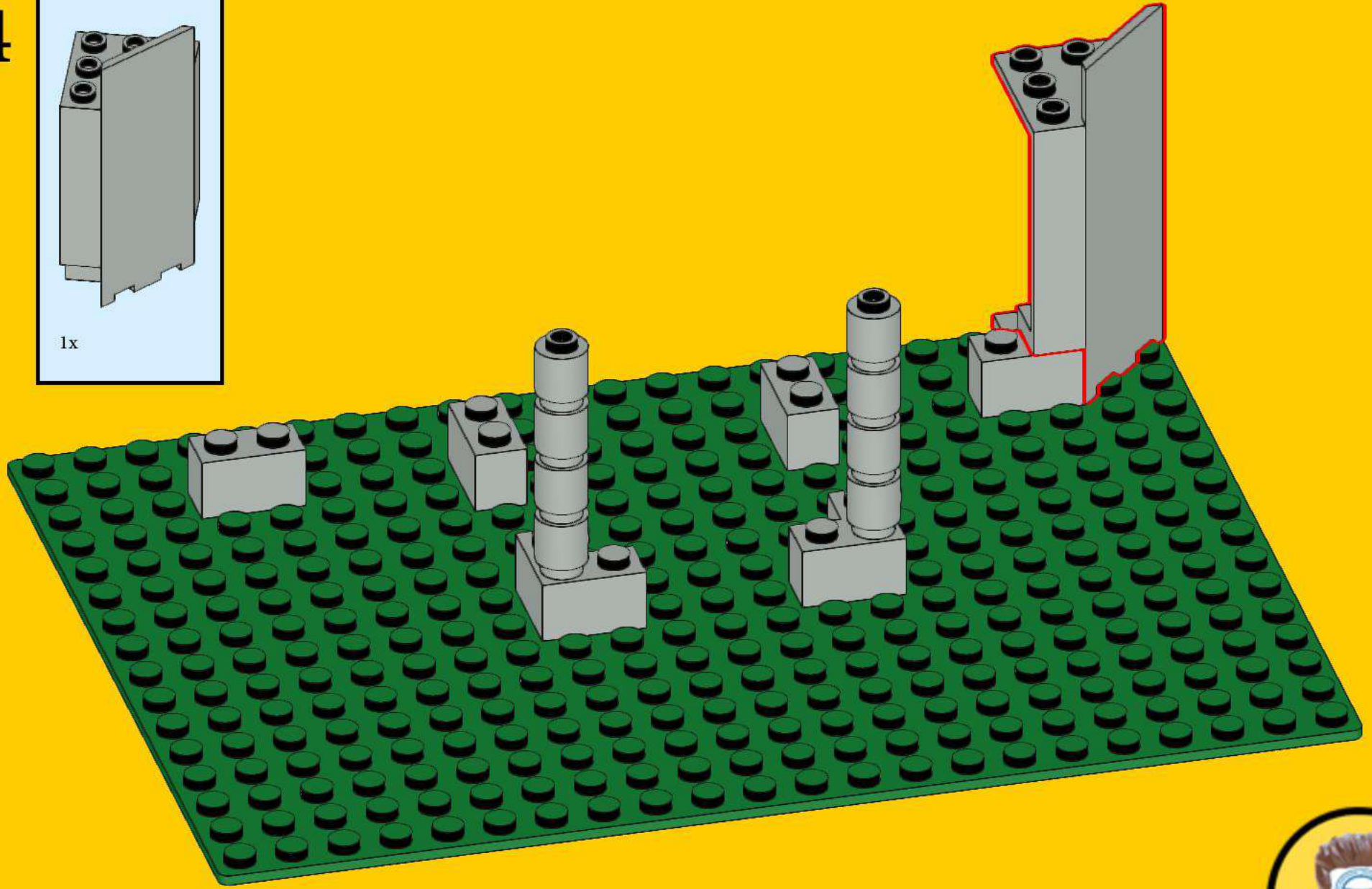
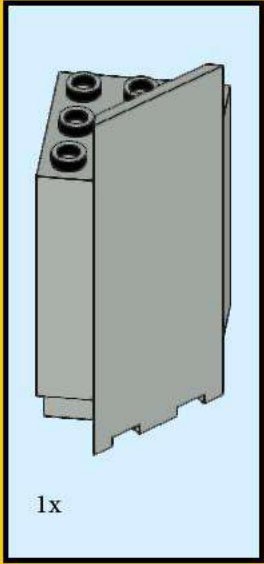

5

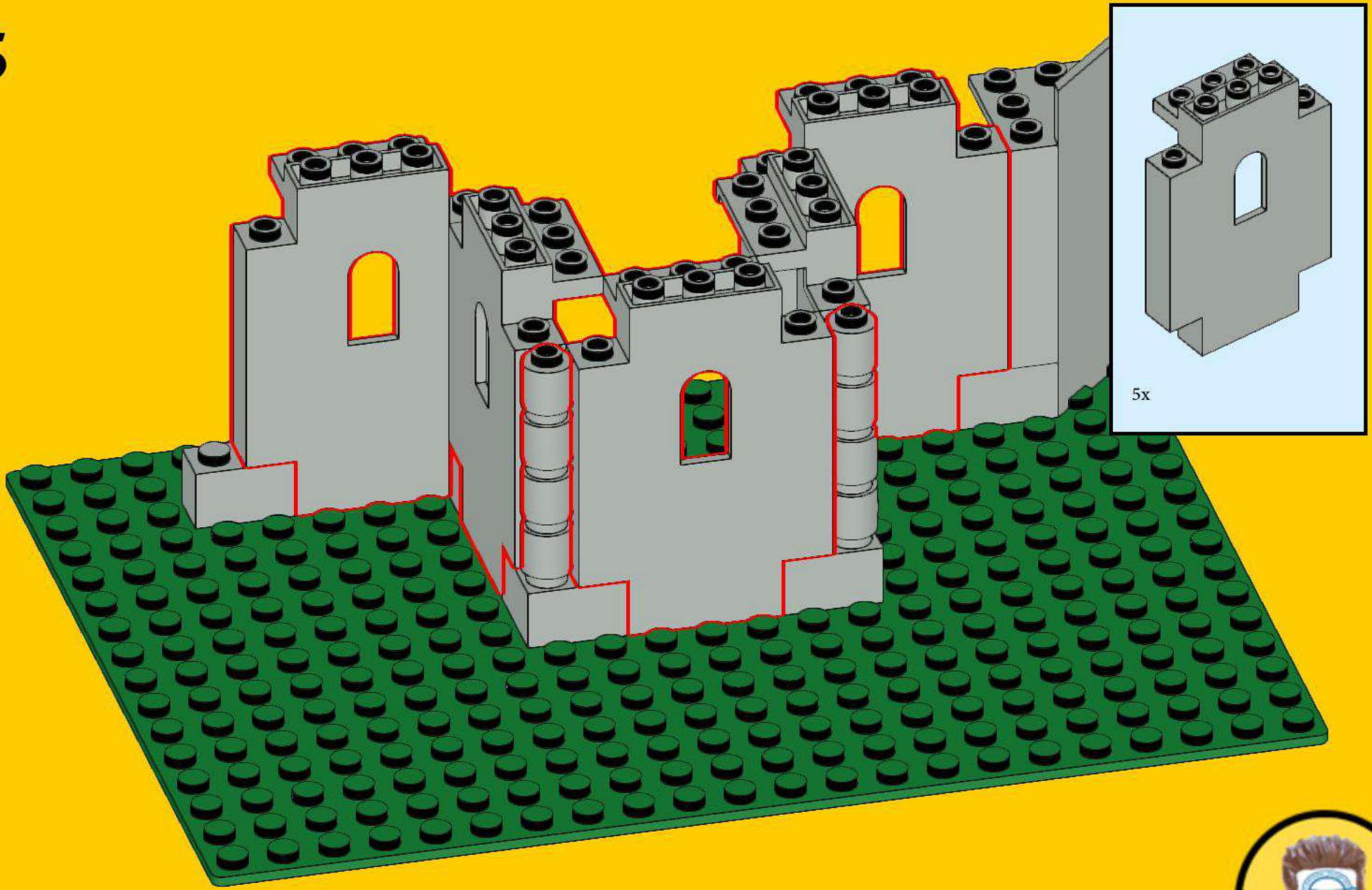

6

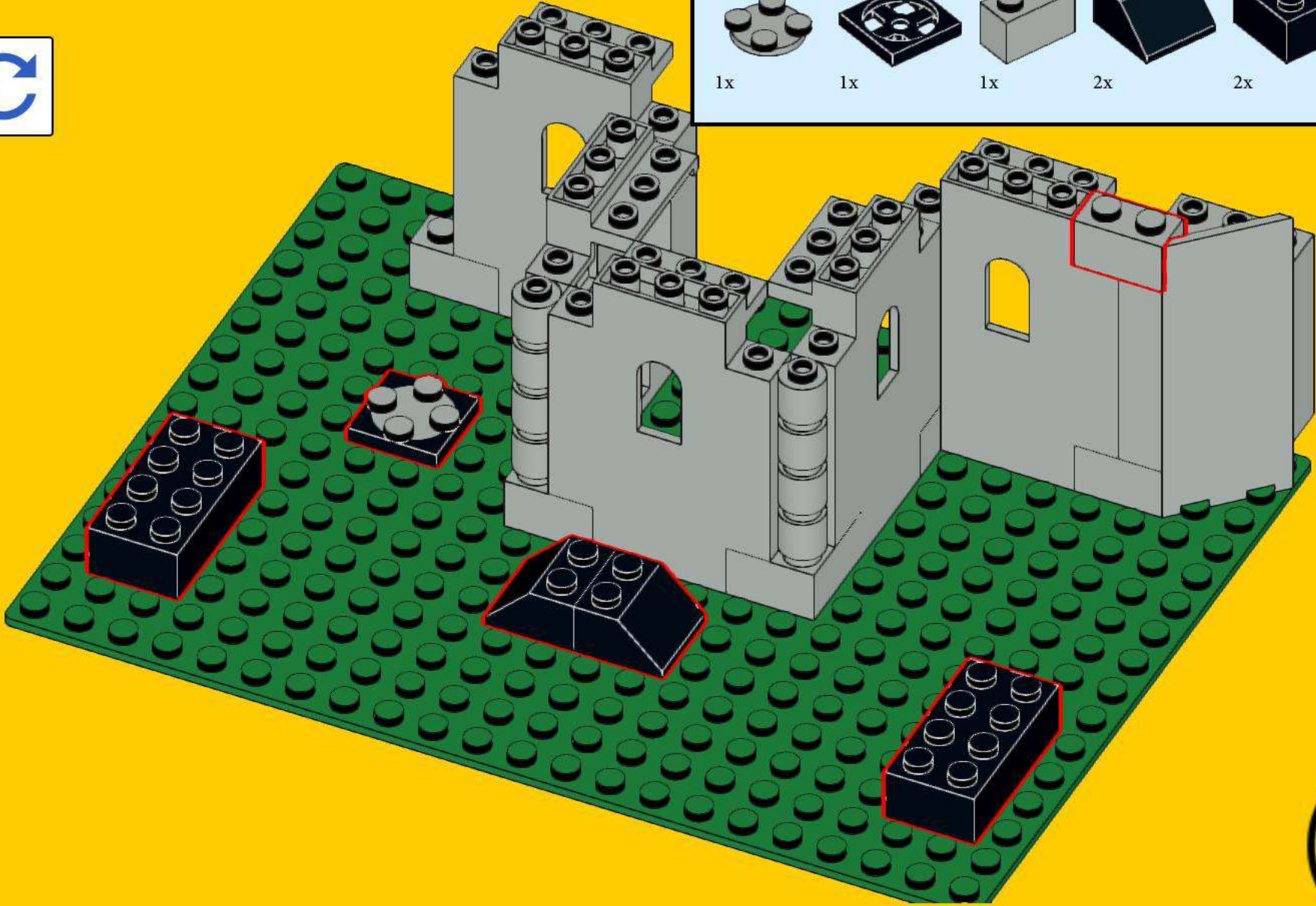
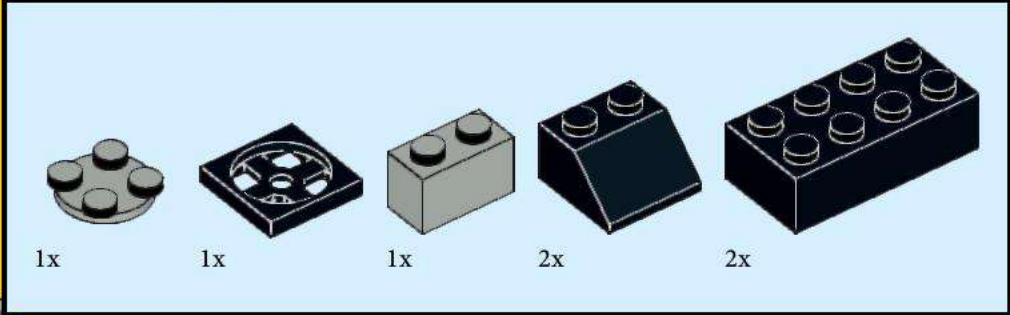

7

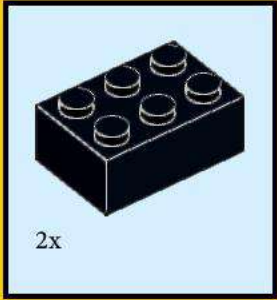

8

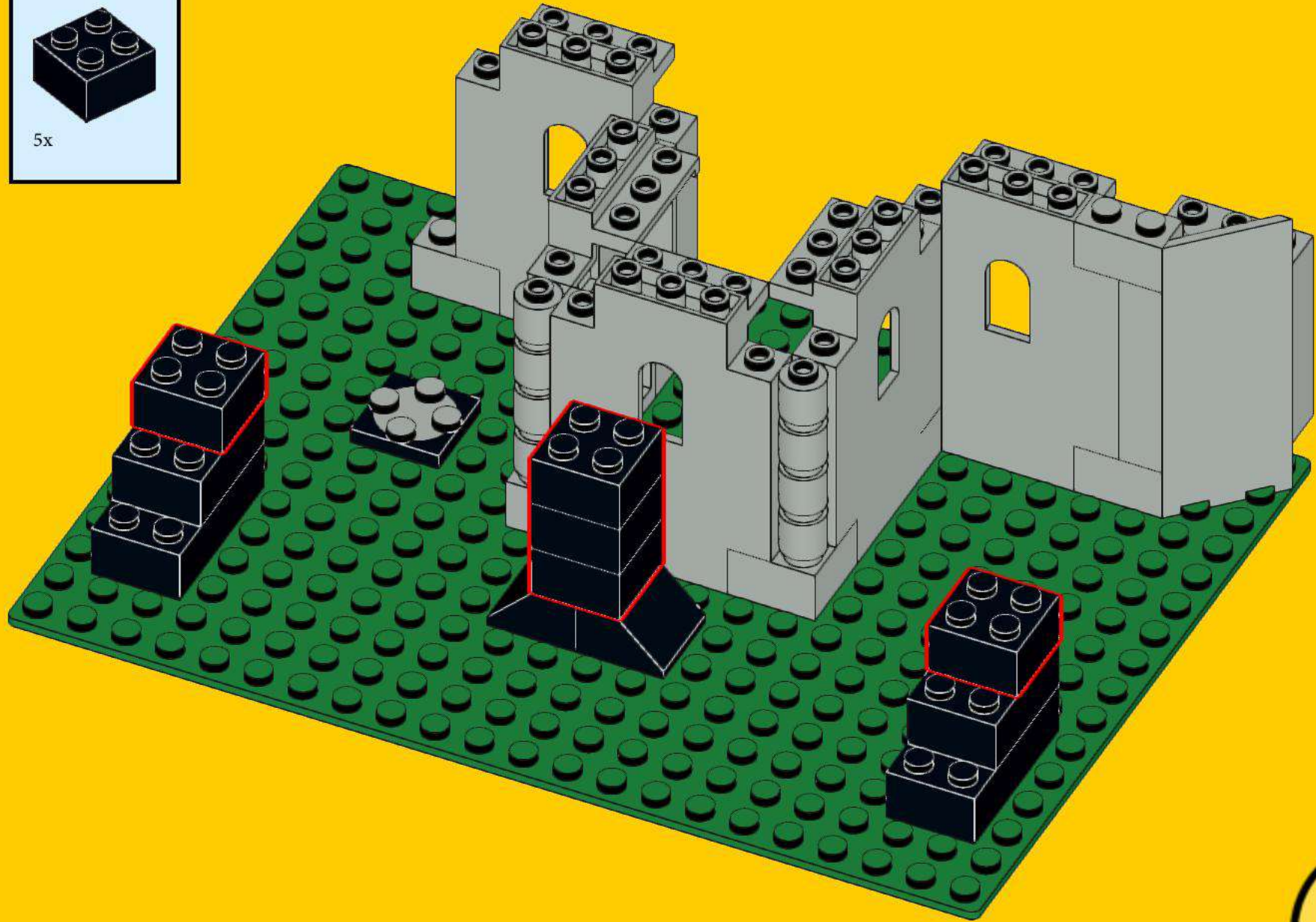
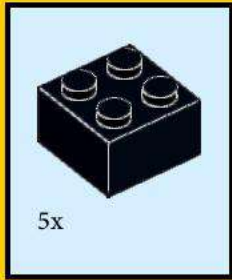

9

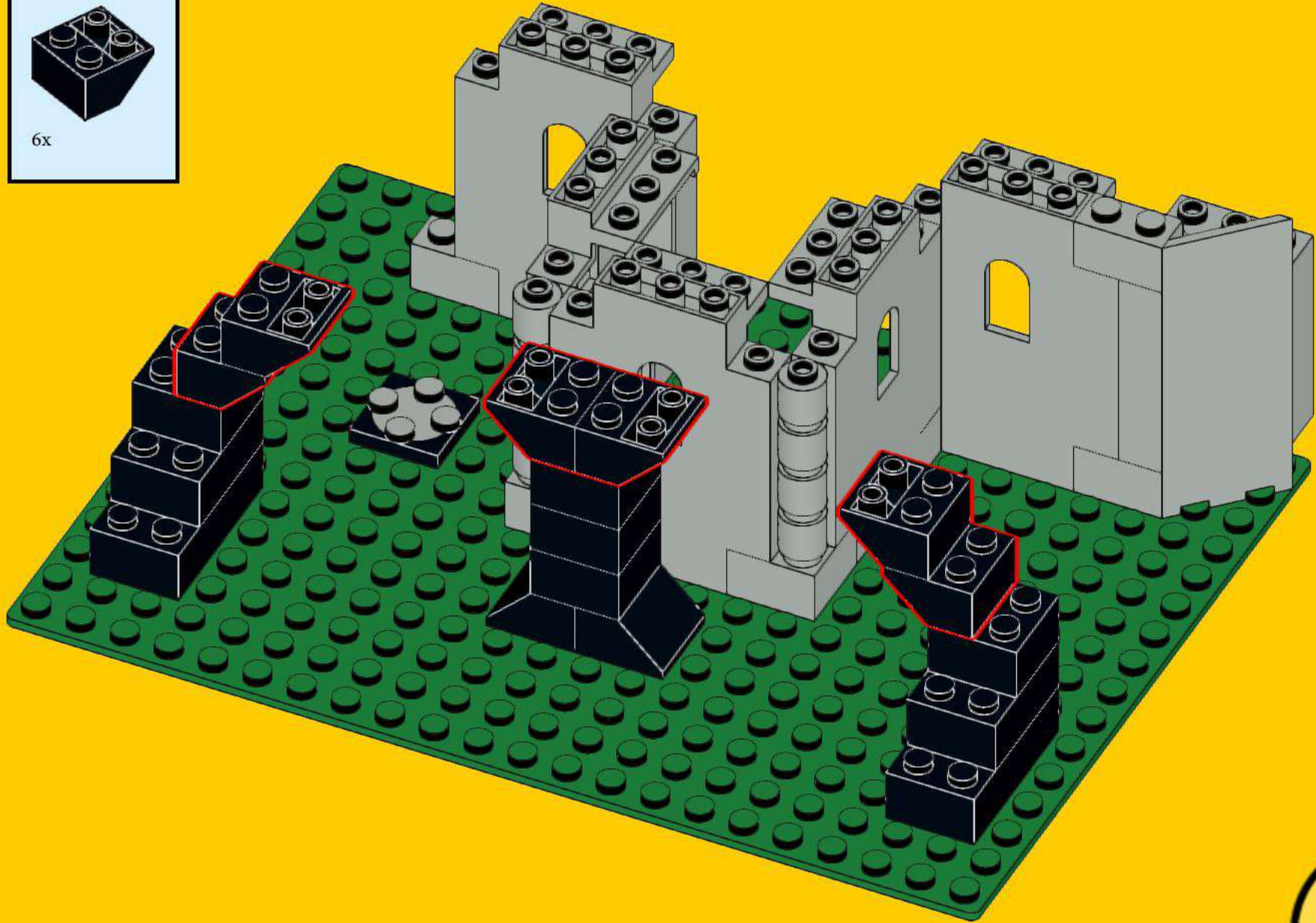
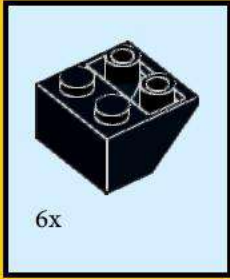

10

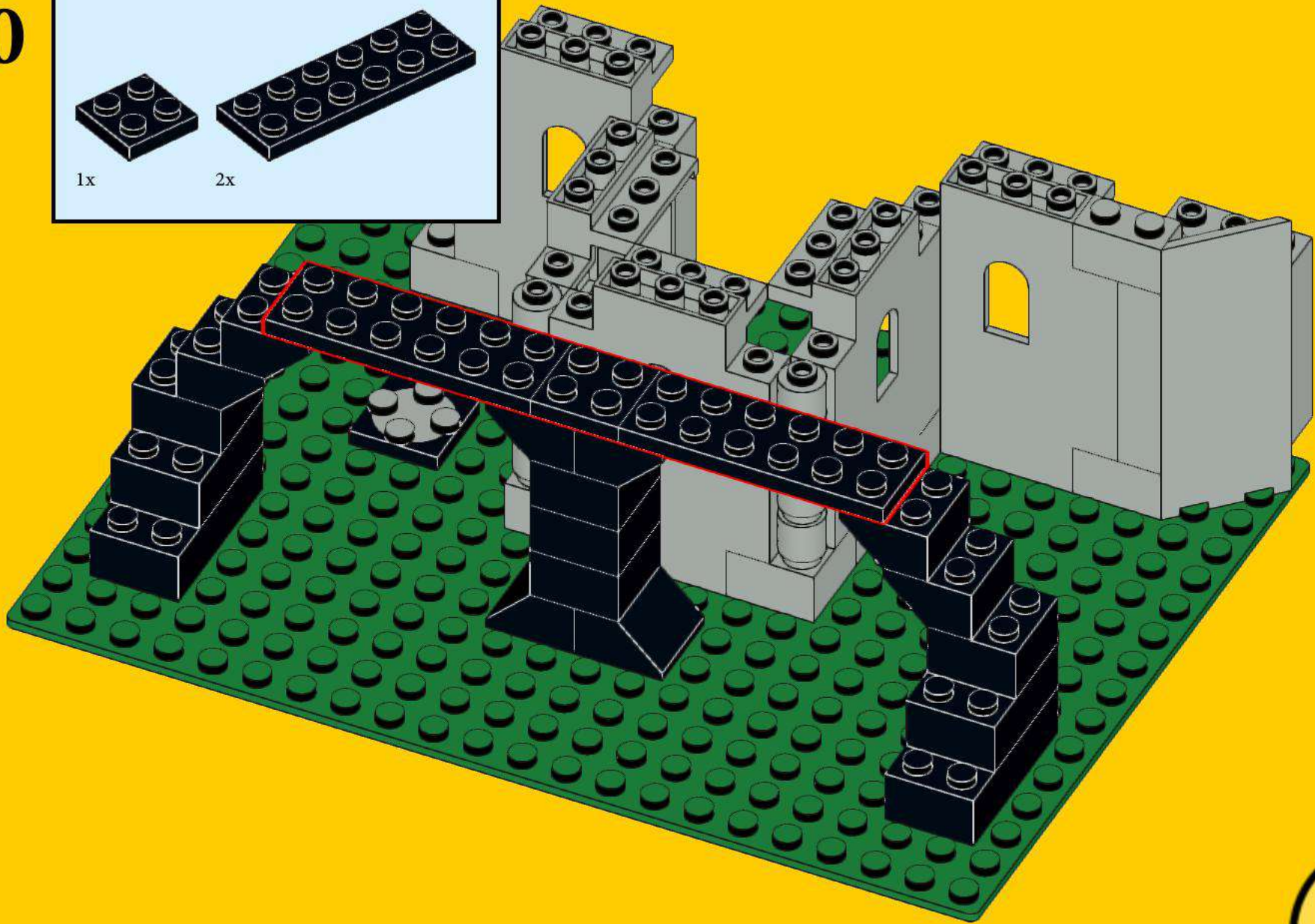
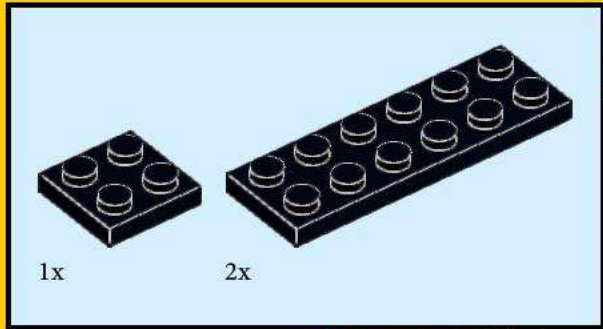

11

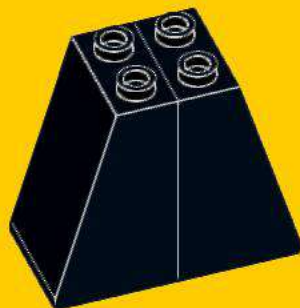
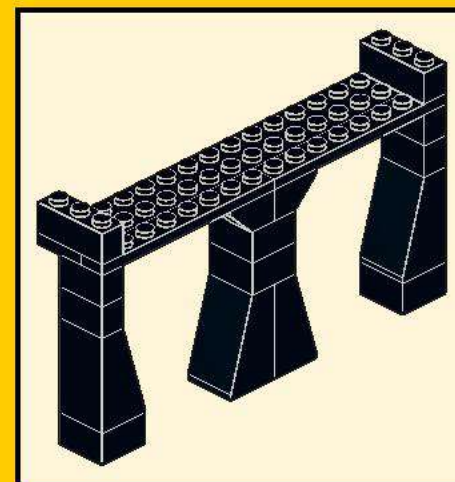
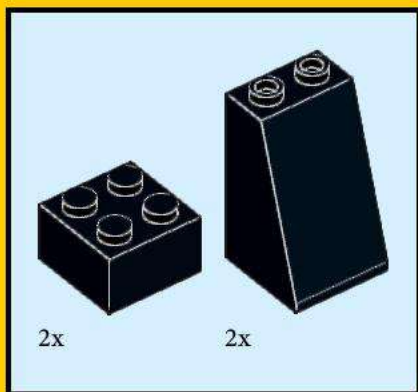

12

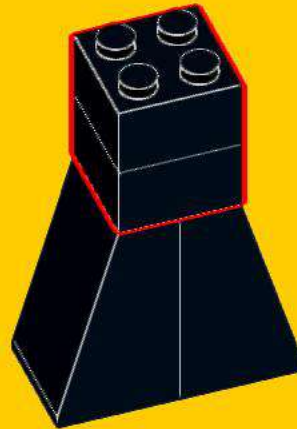
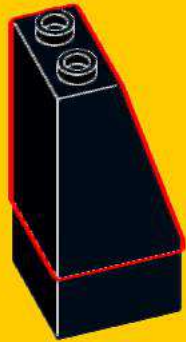
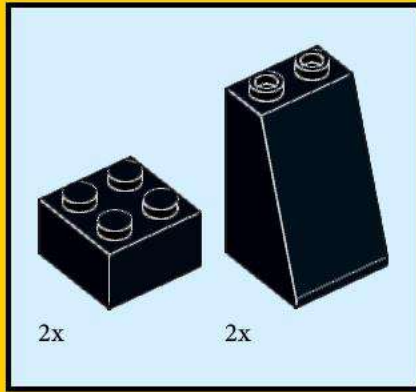

13

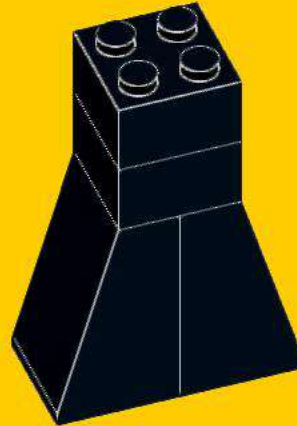
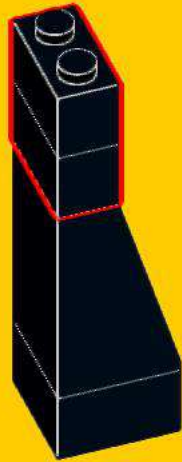
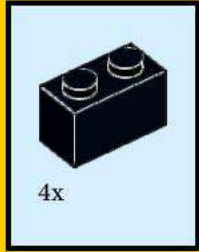

14

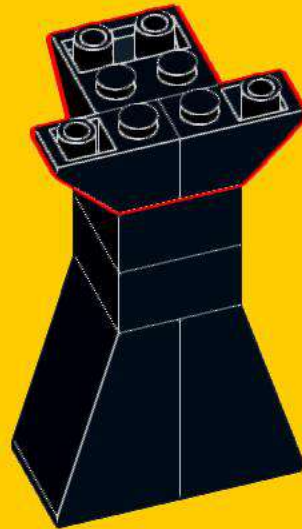
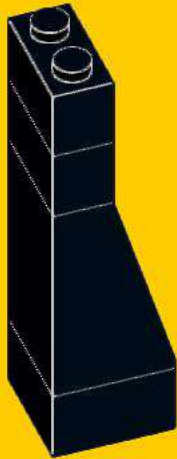
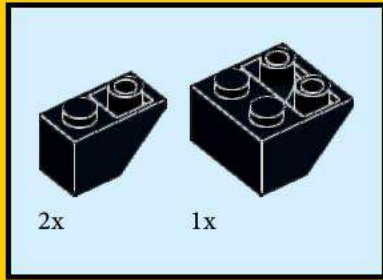

15

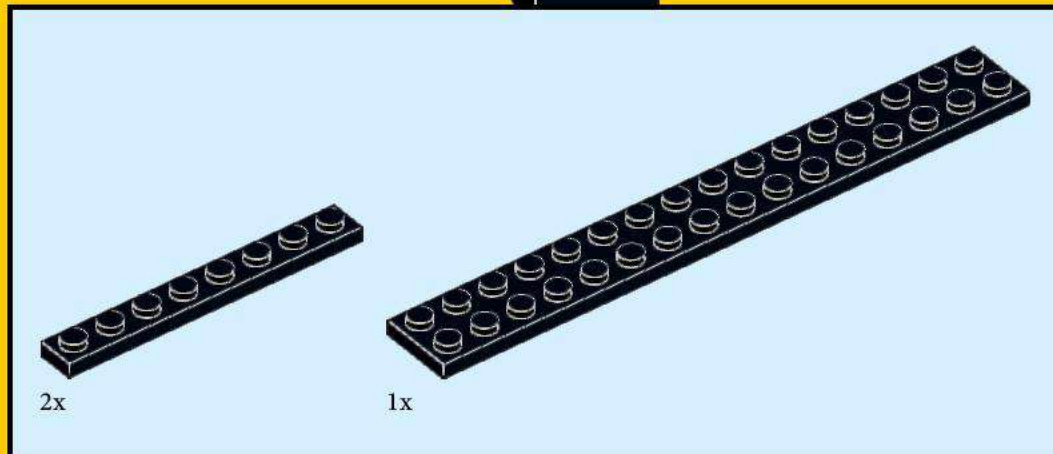
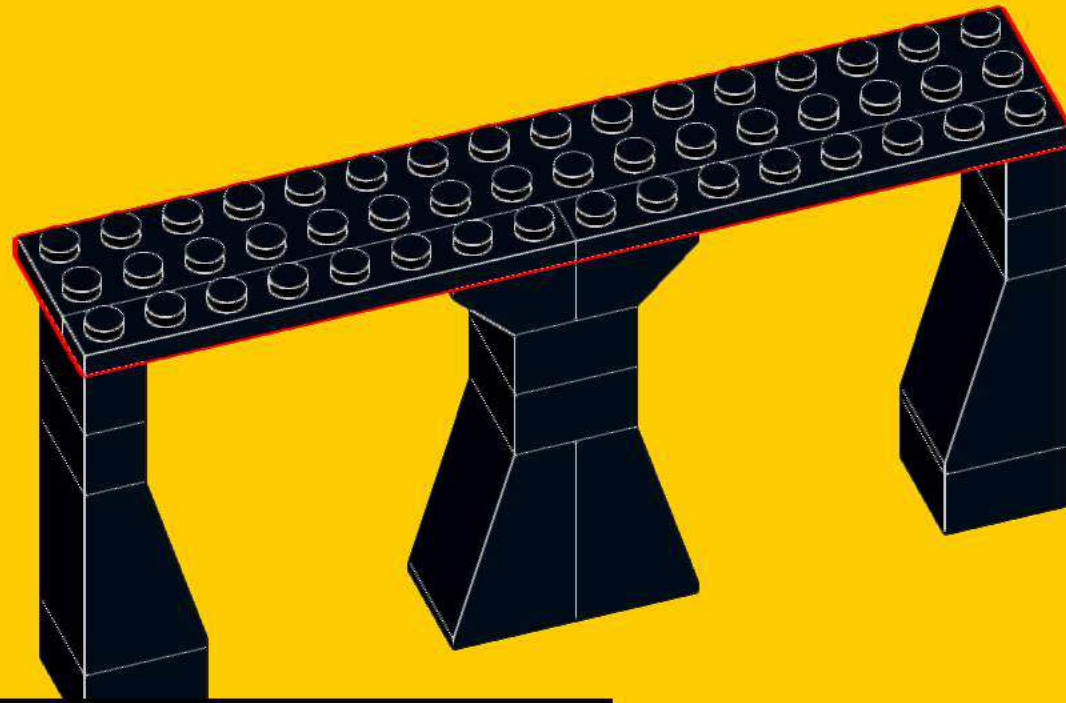

16

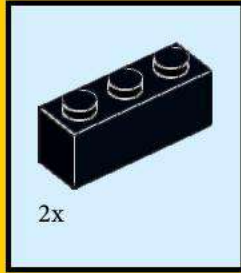

17

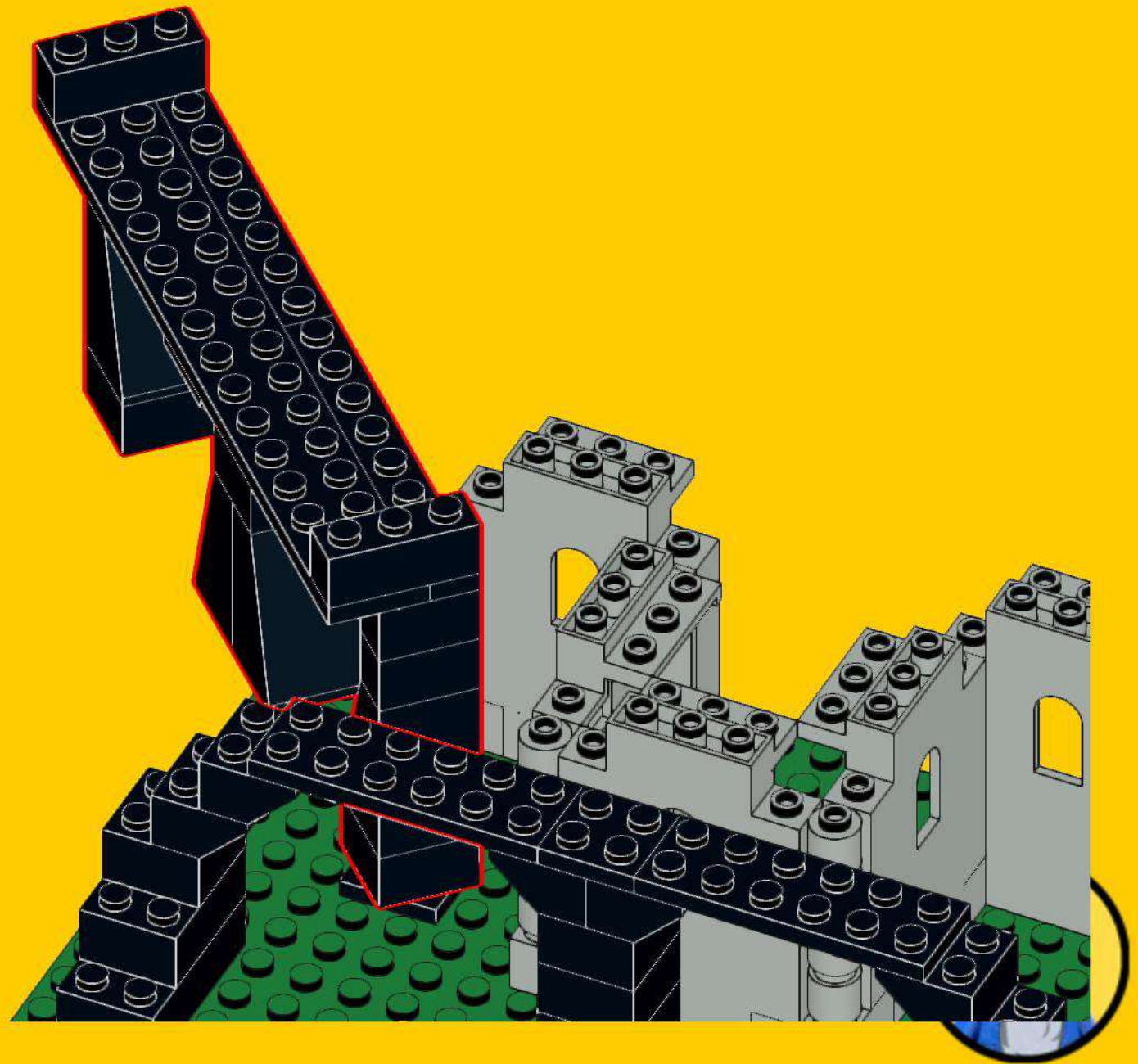

18

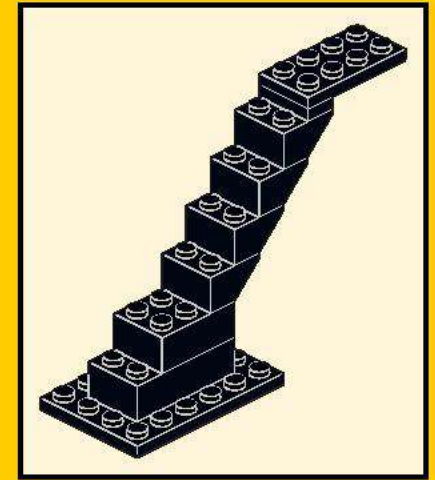
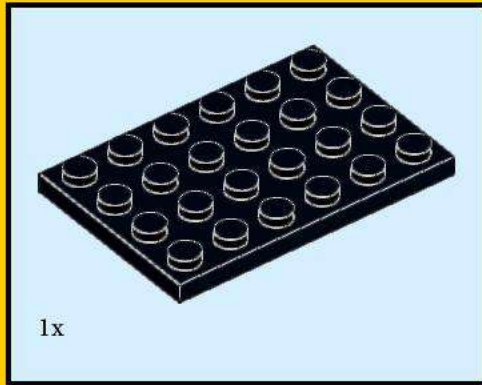

19

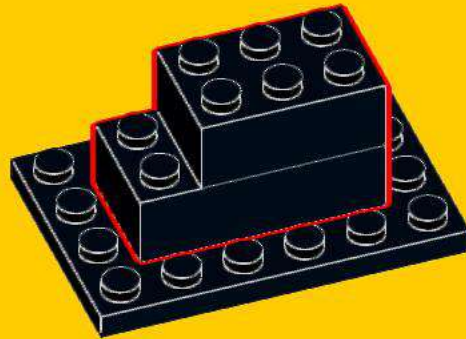
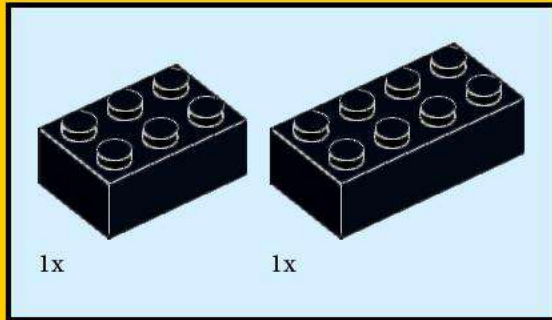

20

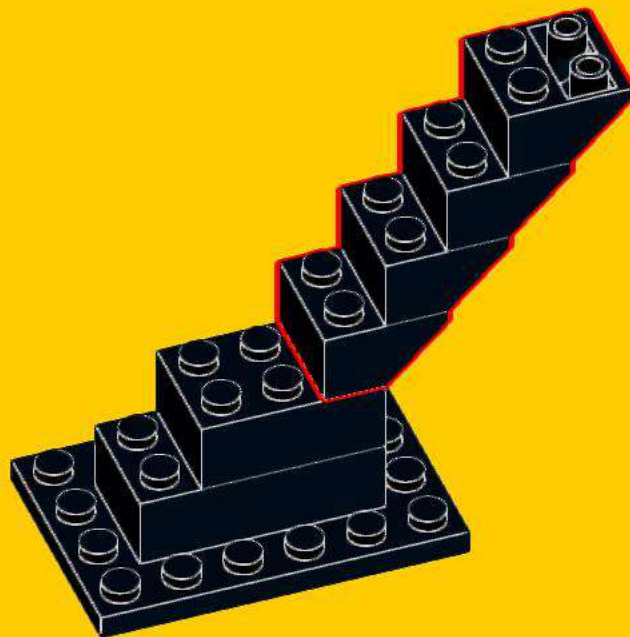
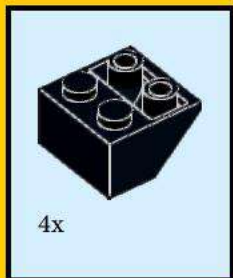

21

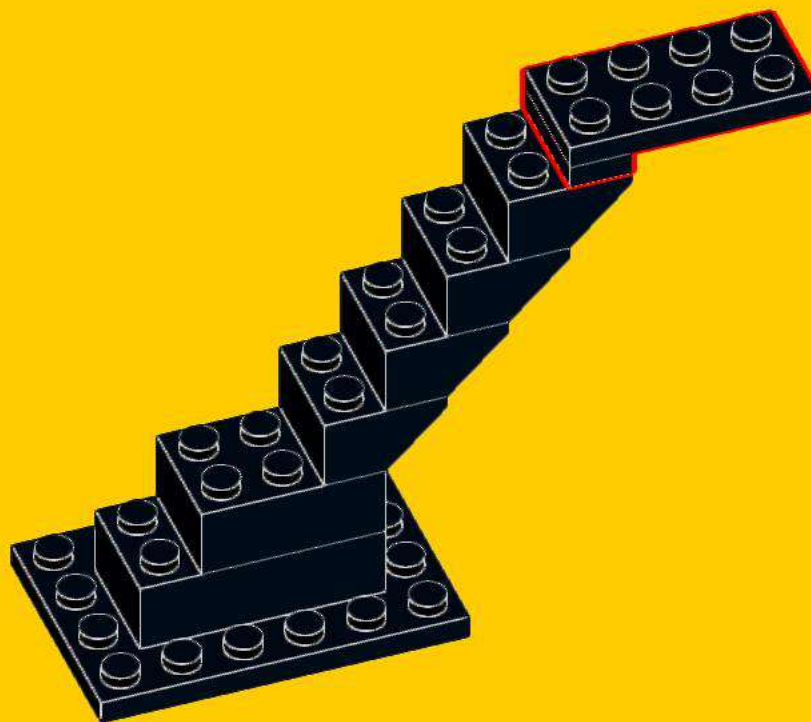
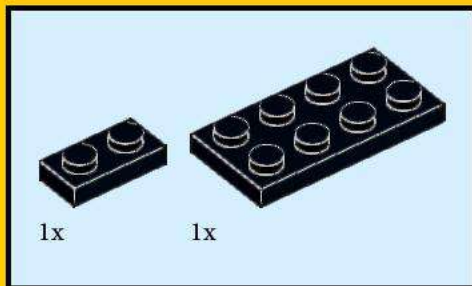

22

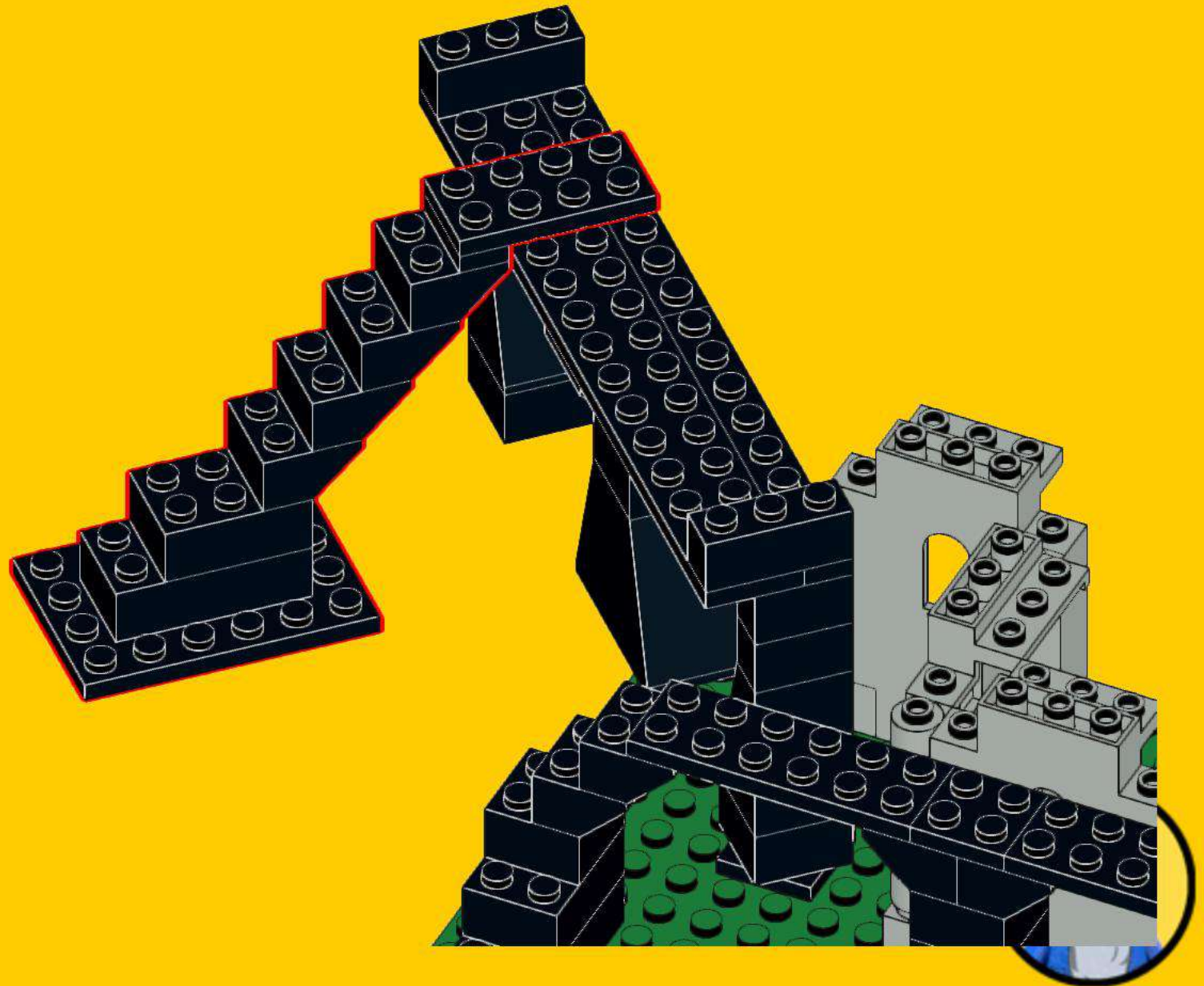

23

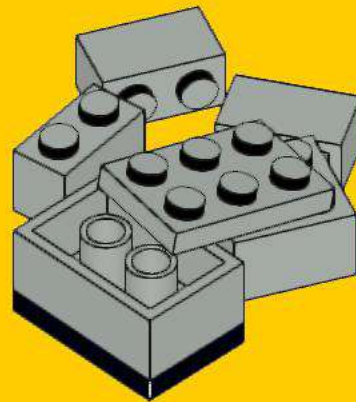
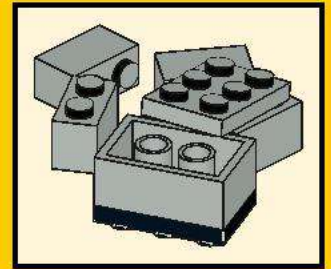
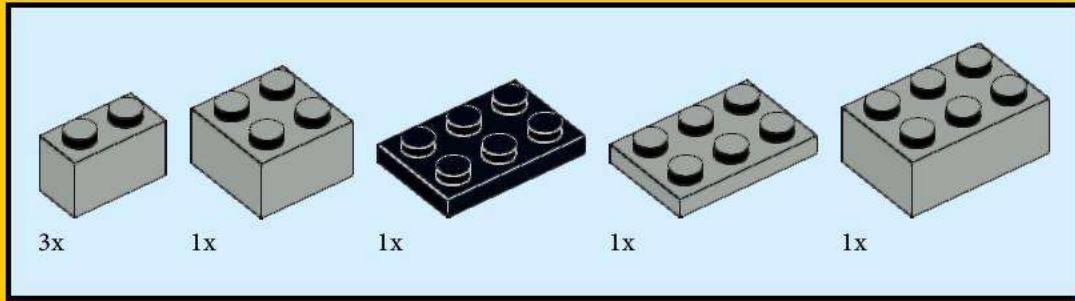

24

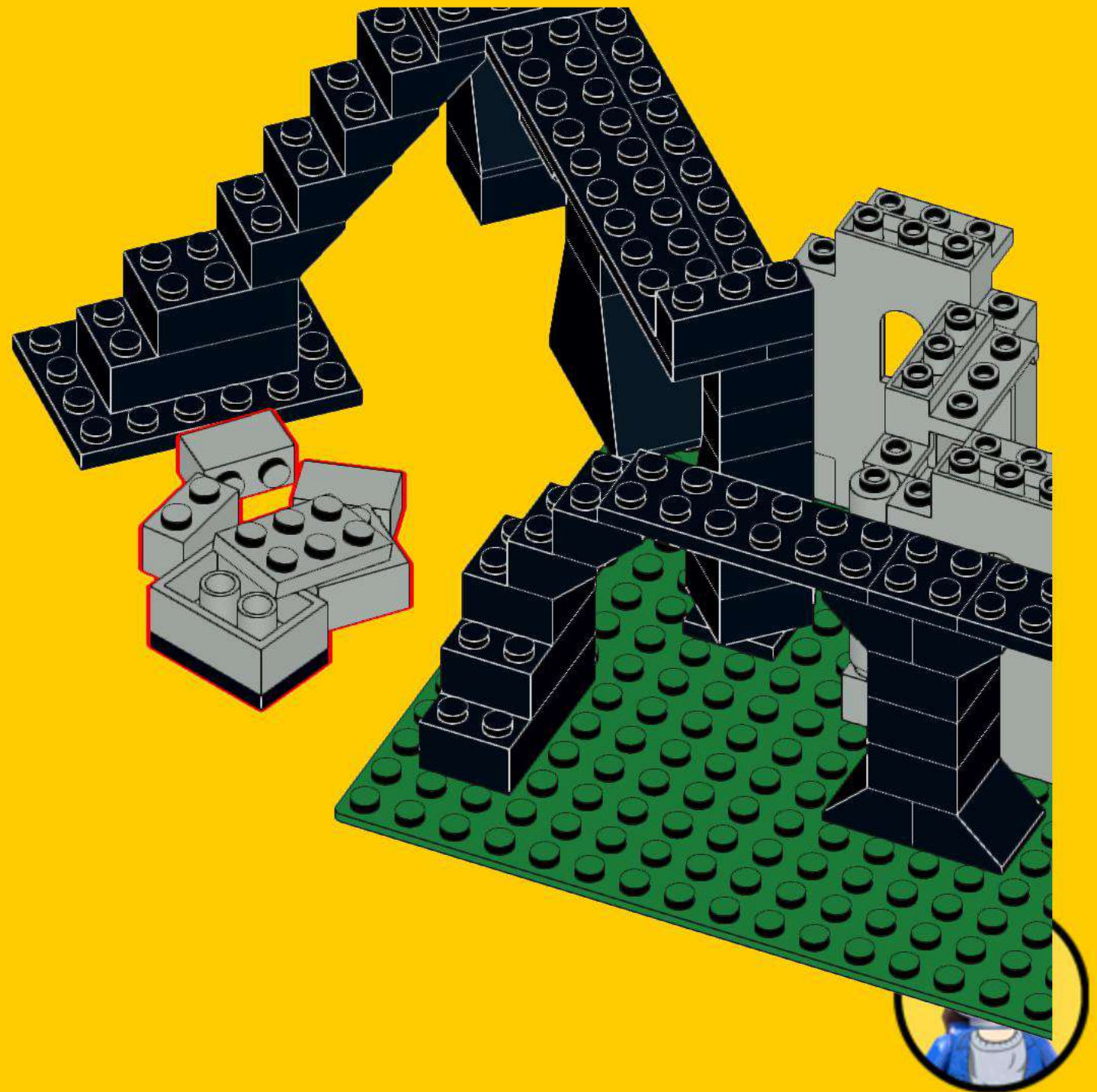

25



26



27



28



29

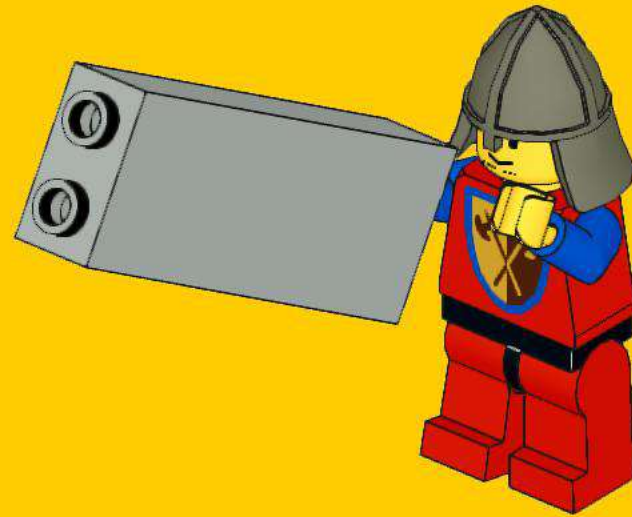

30

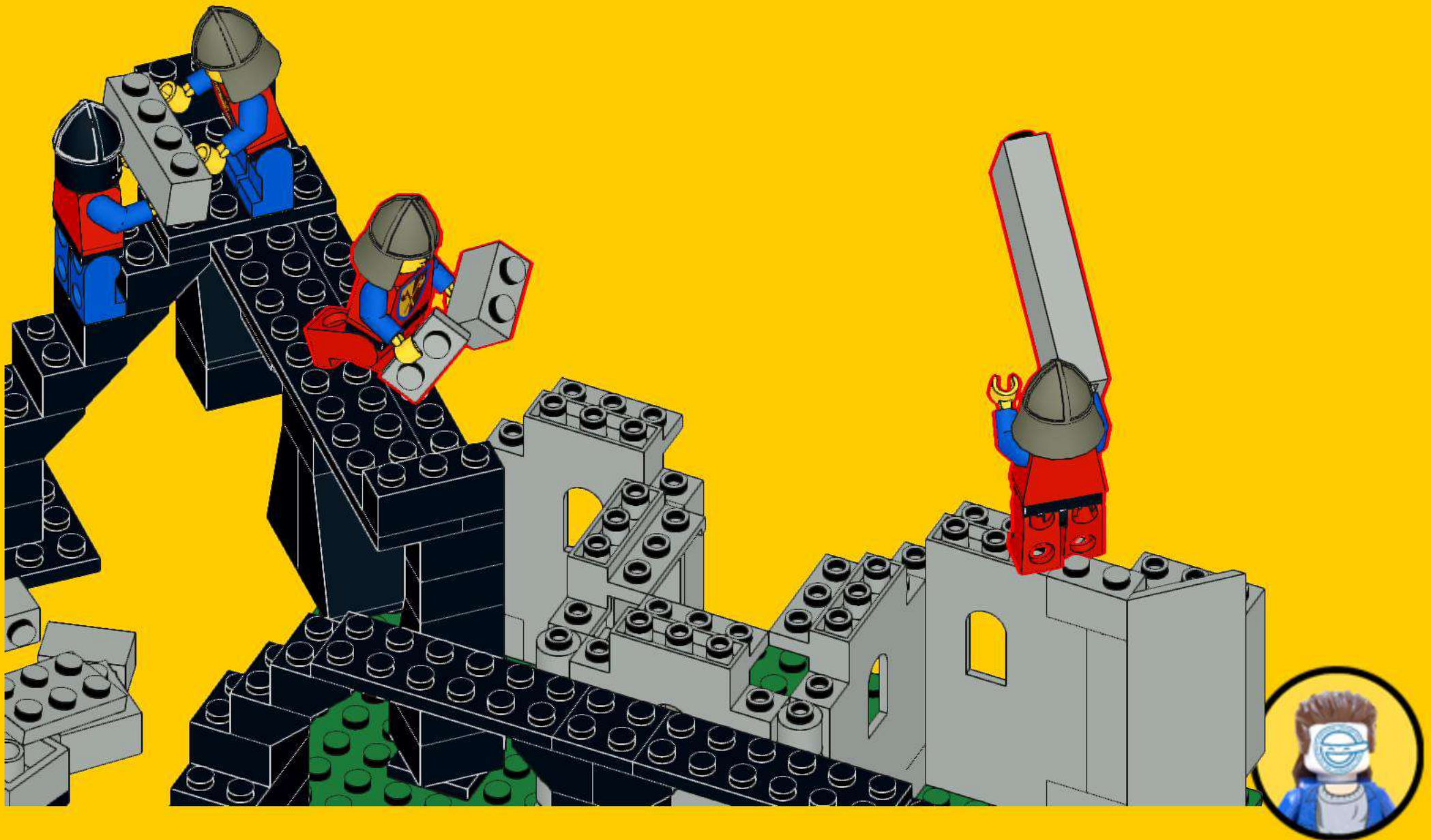

31



32



33



34



35

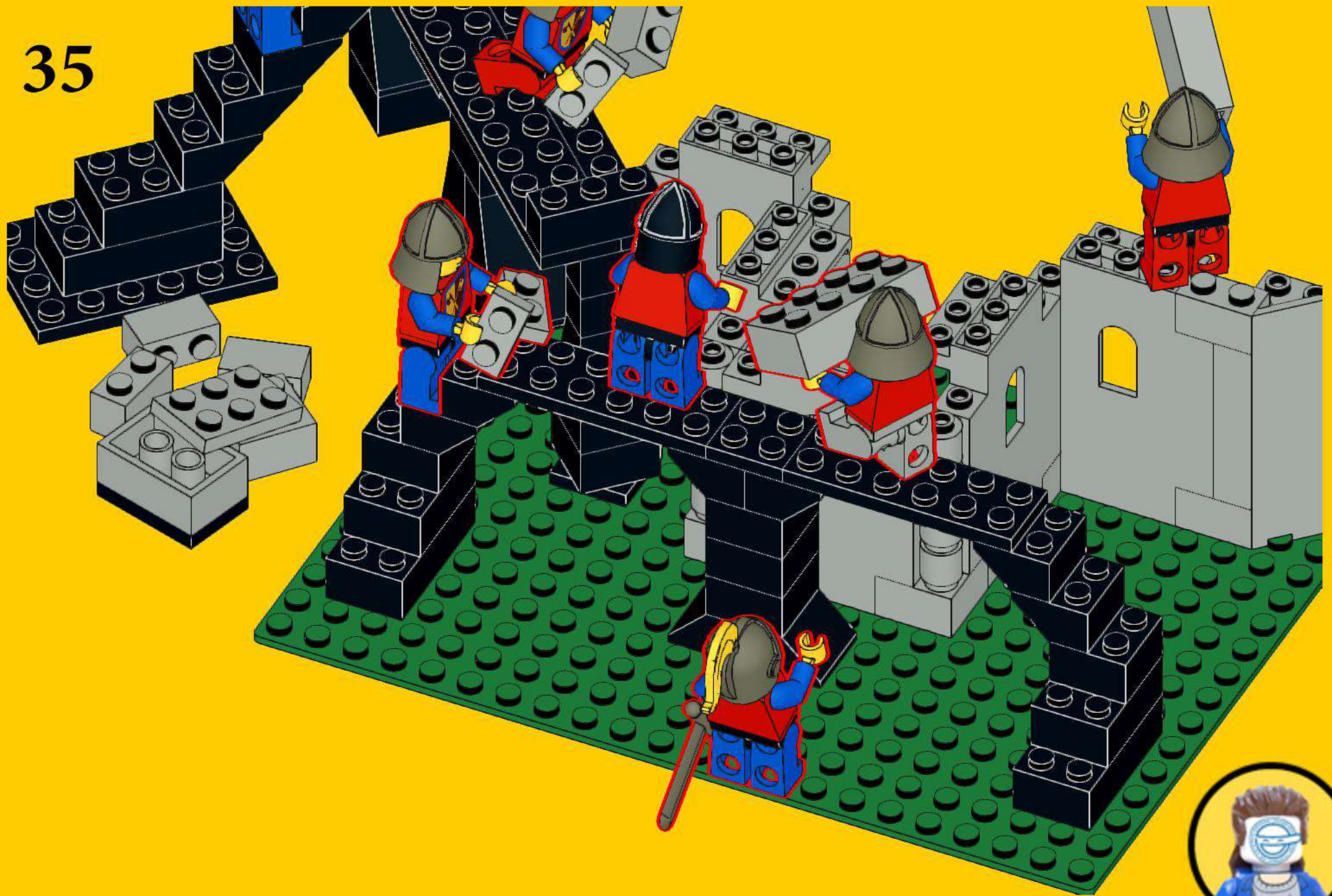

36

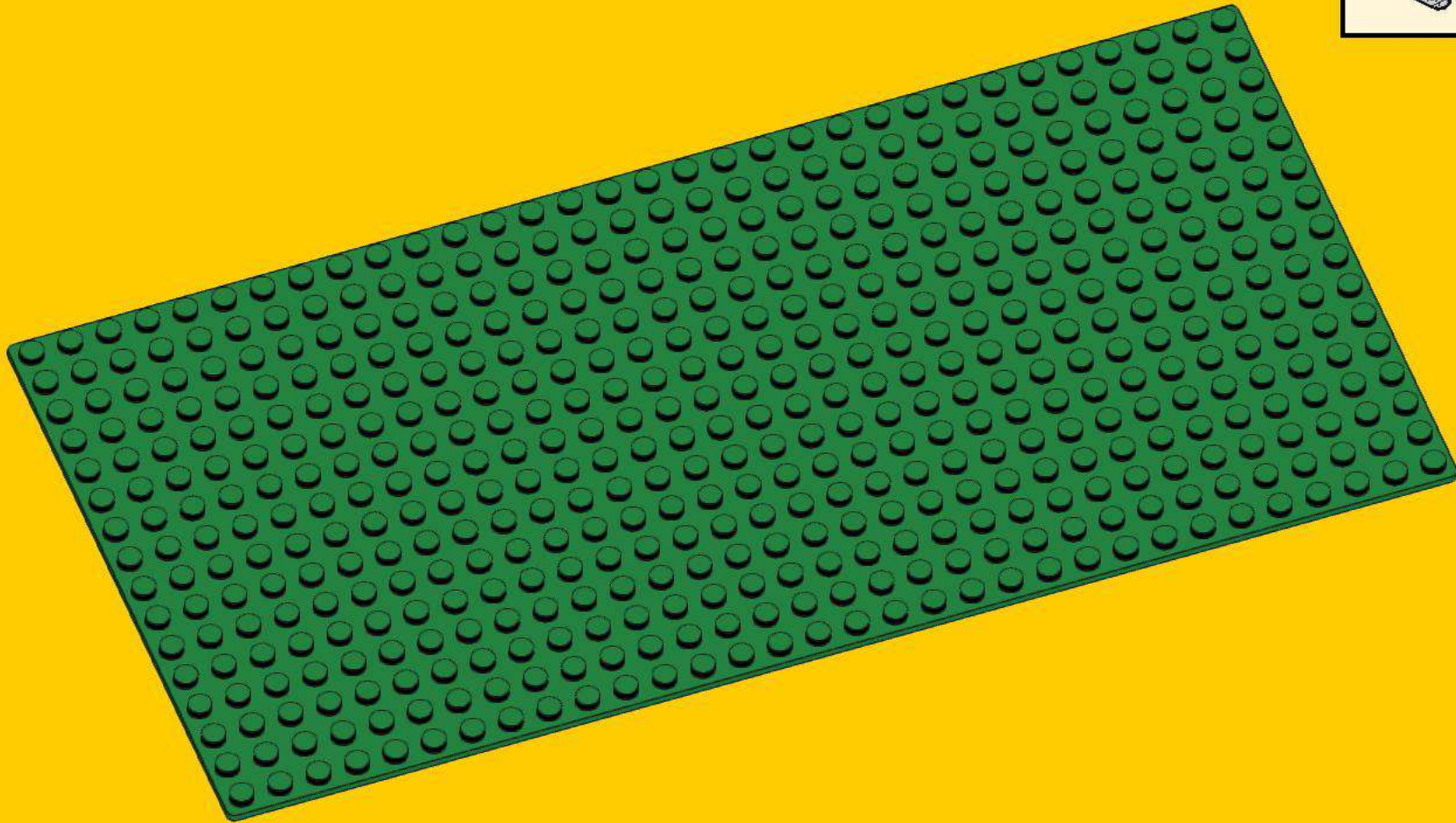
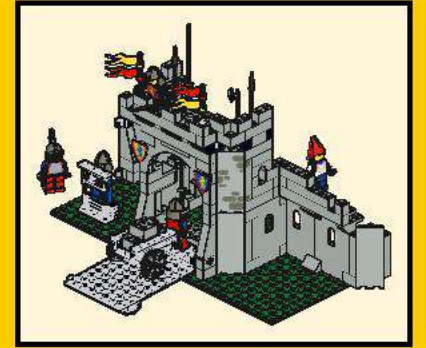

37

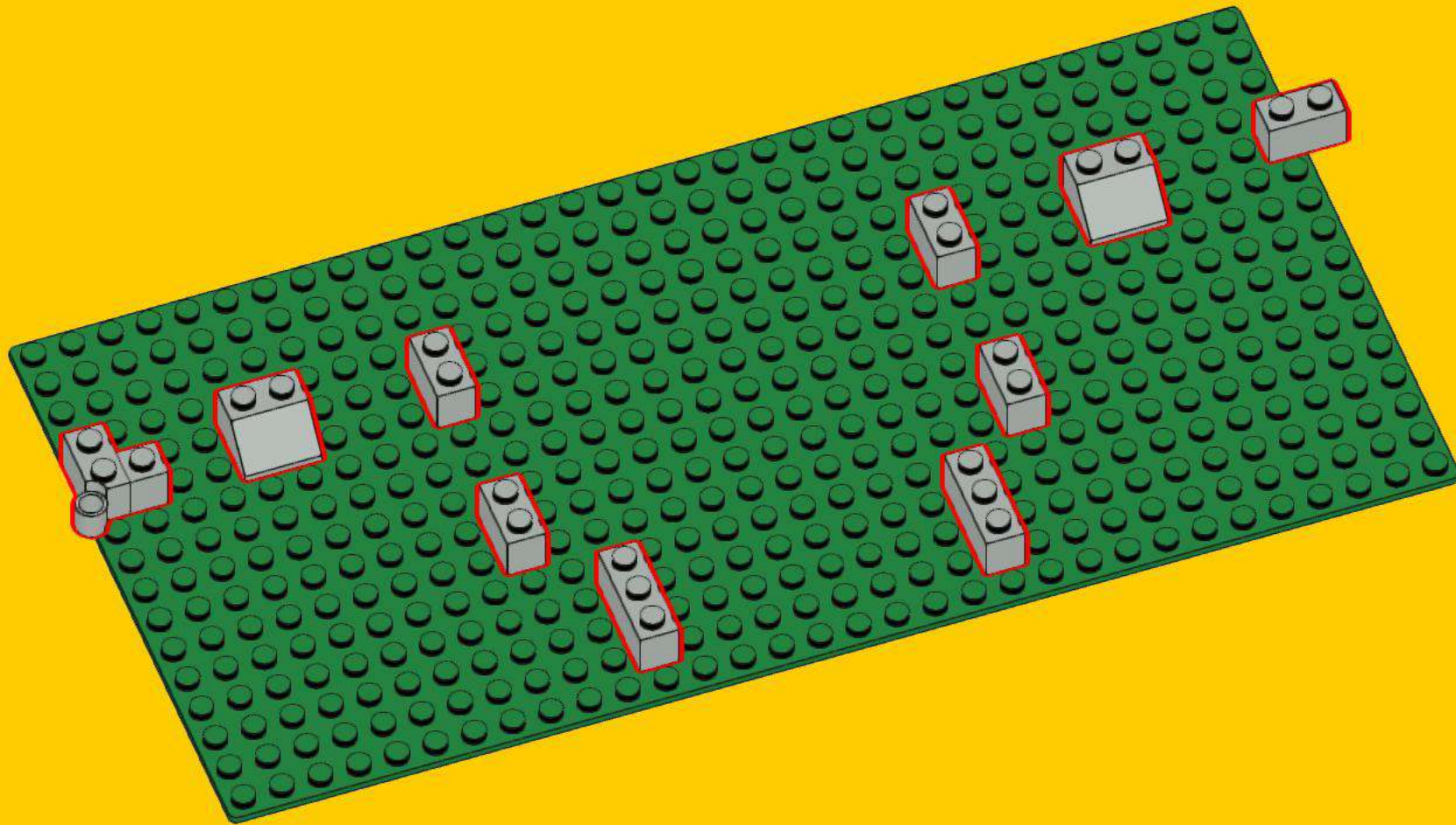
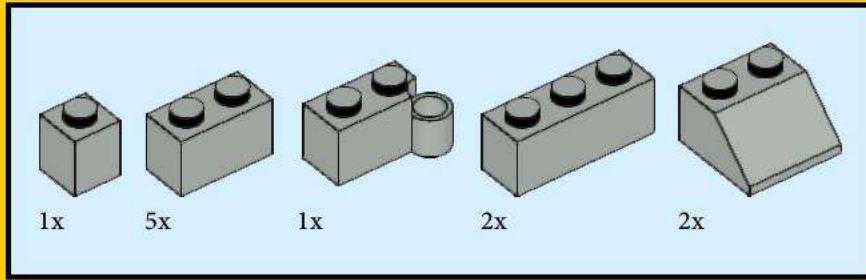

38

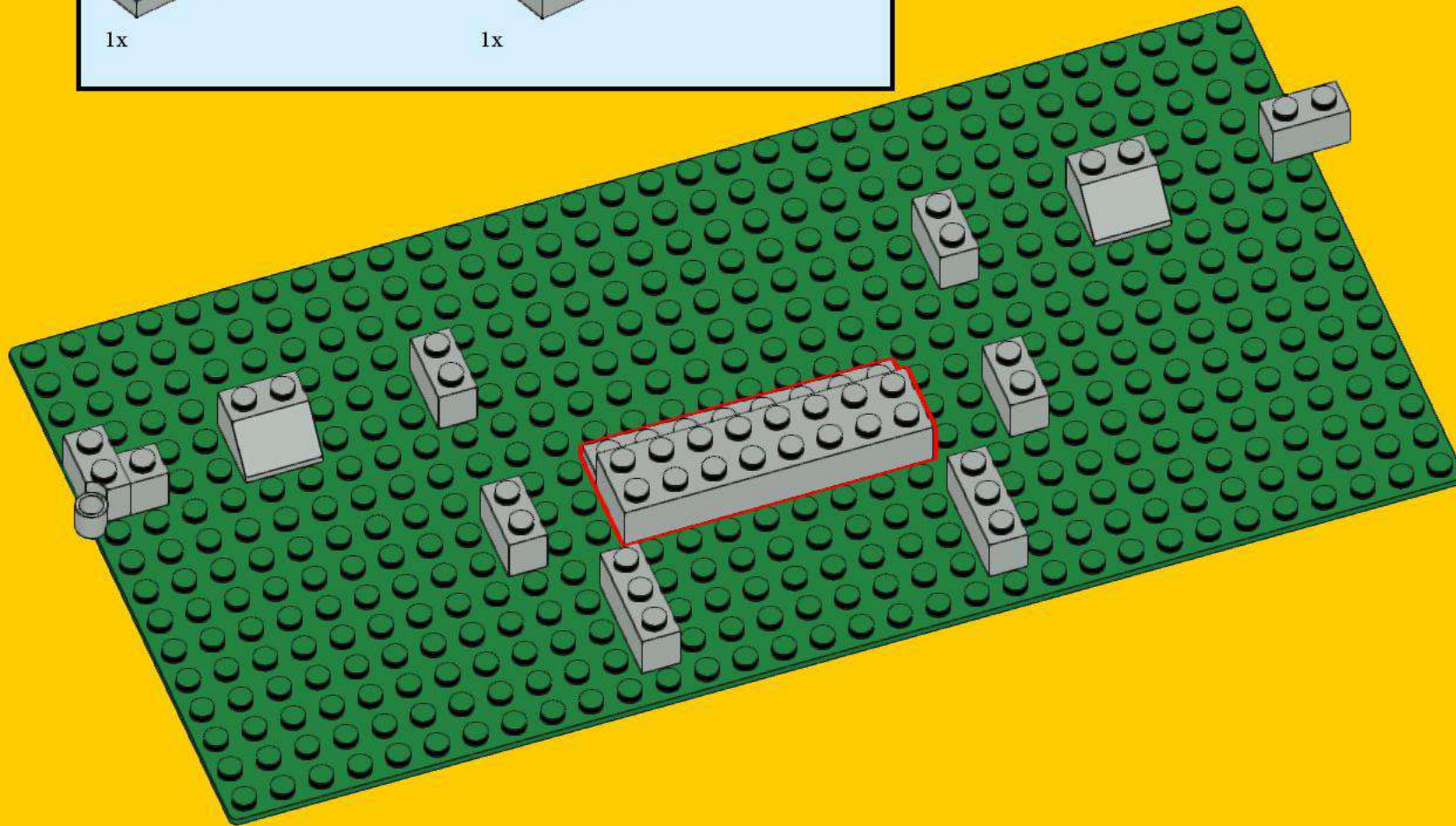
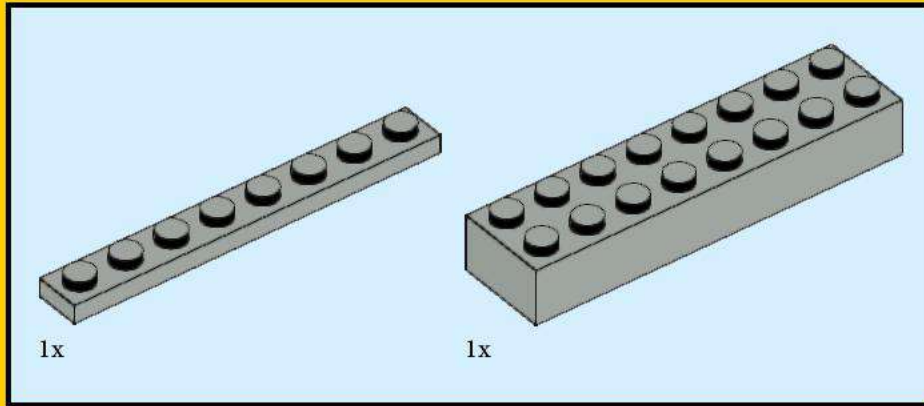

39

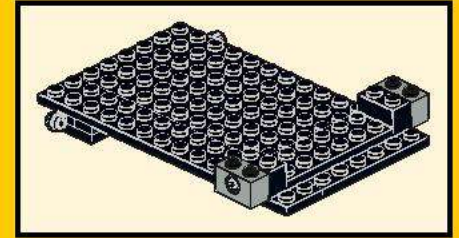
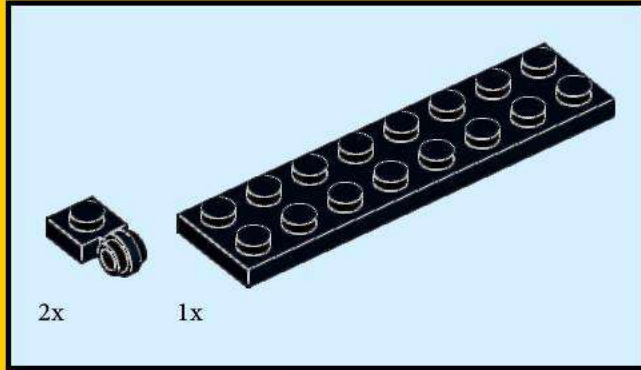

40

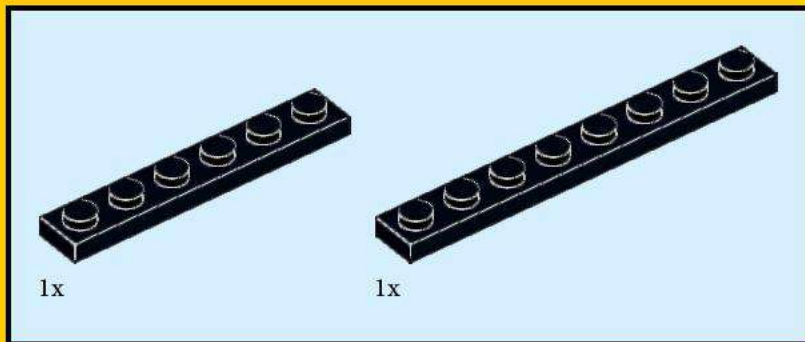

41

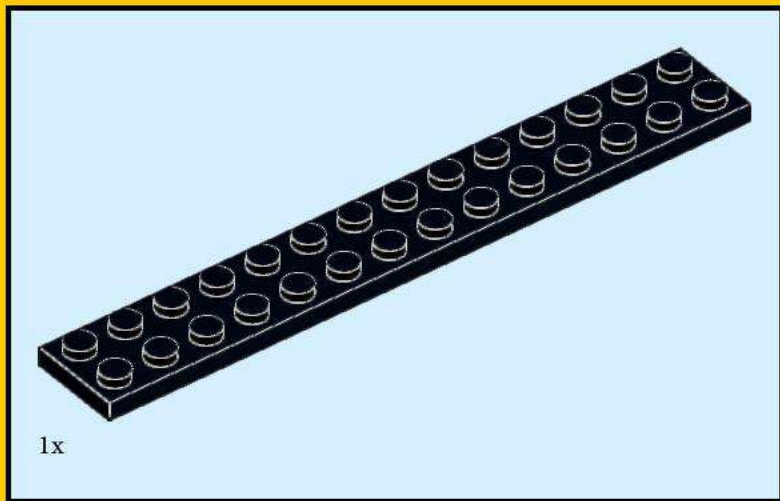

42

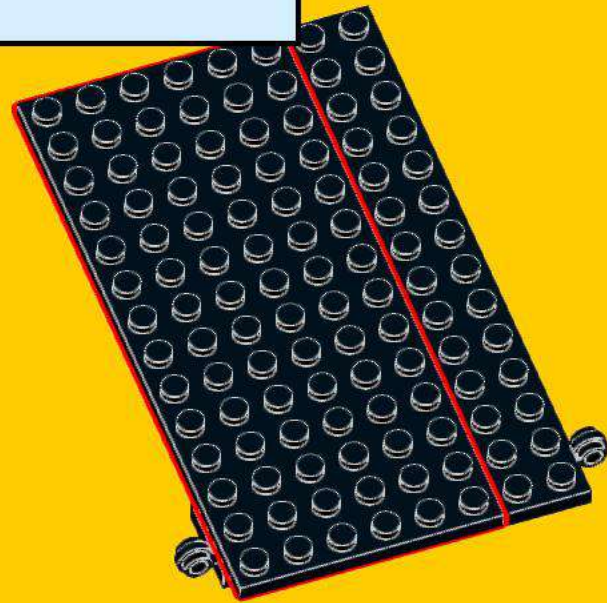
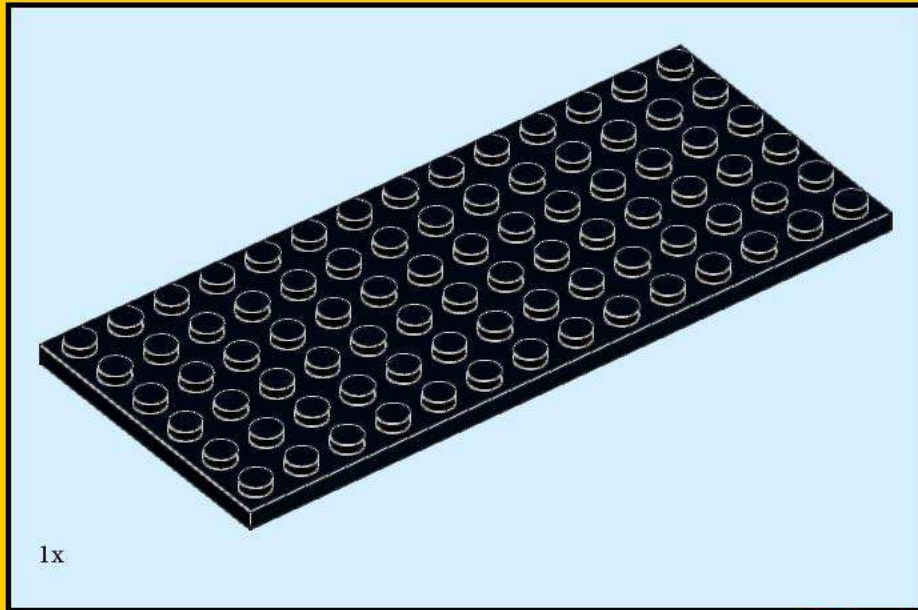

43

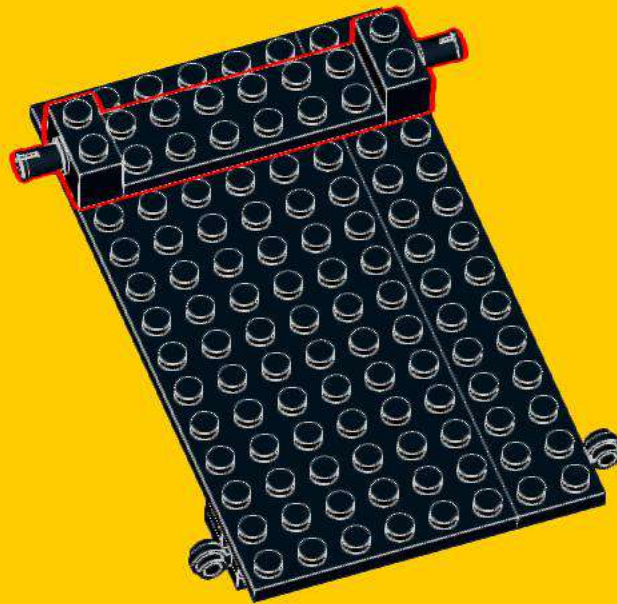
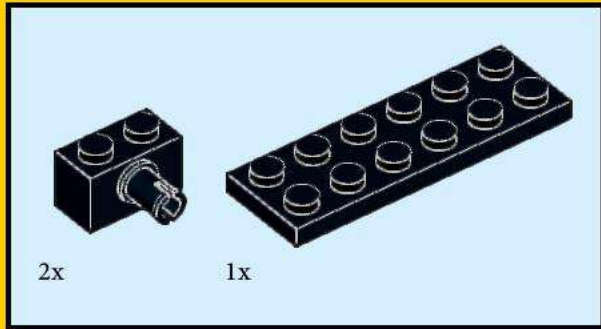

44

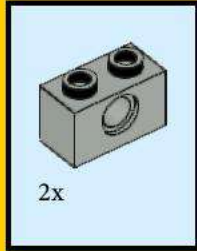

45

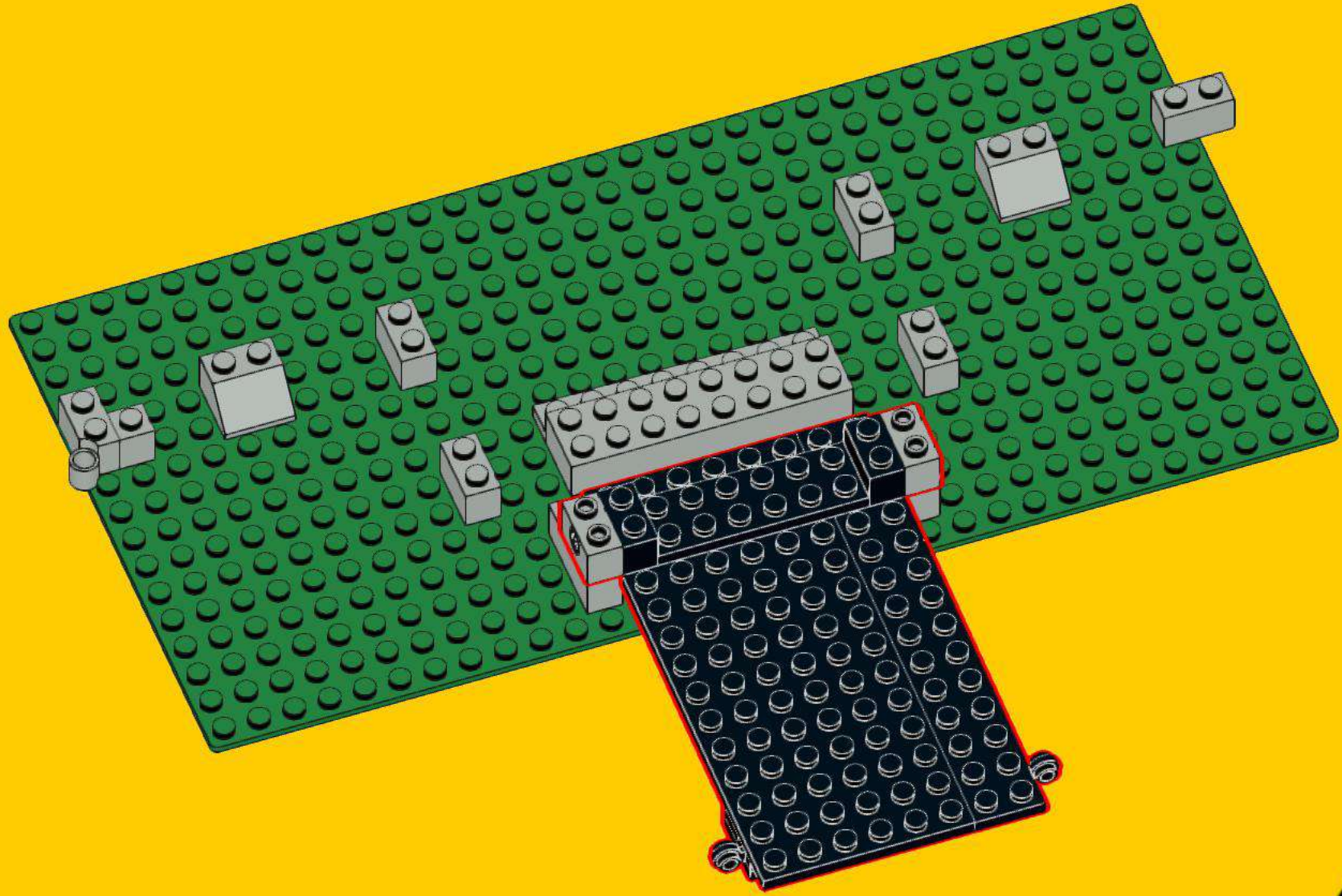

46

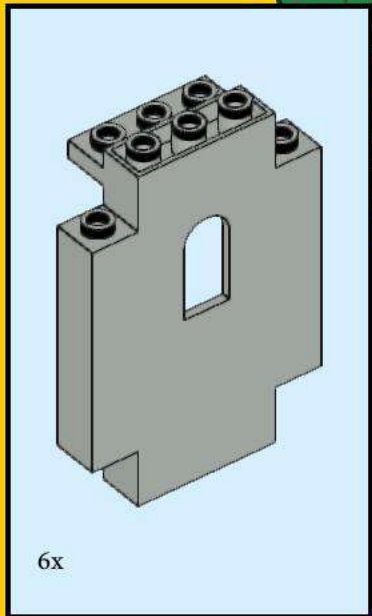
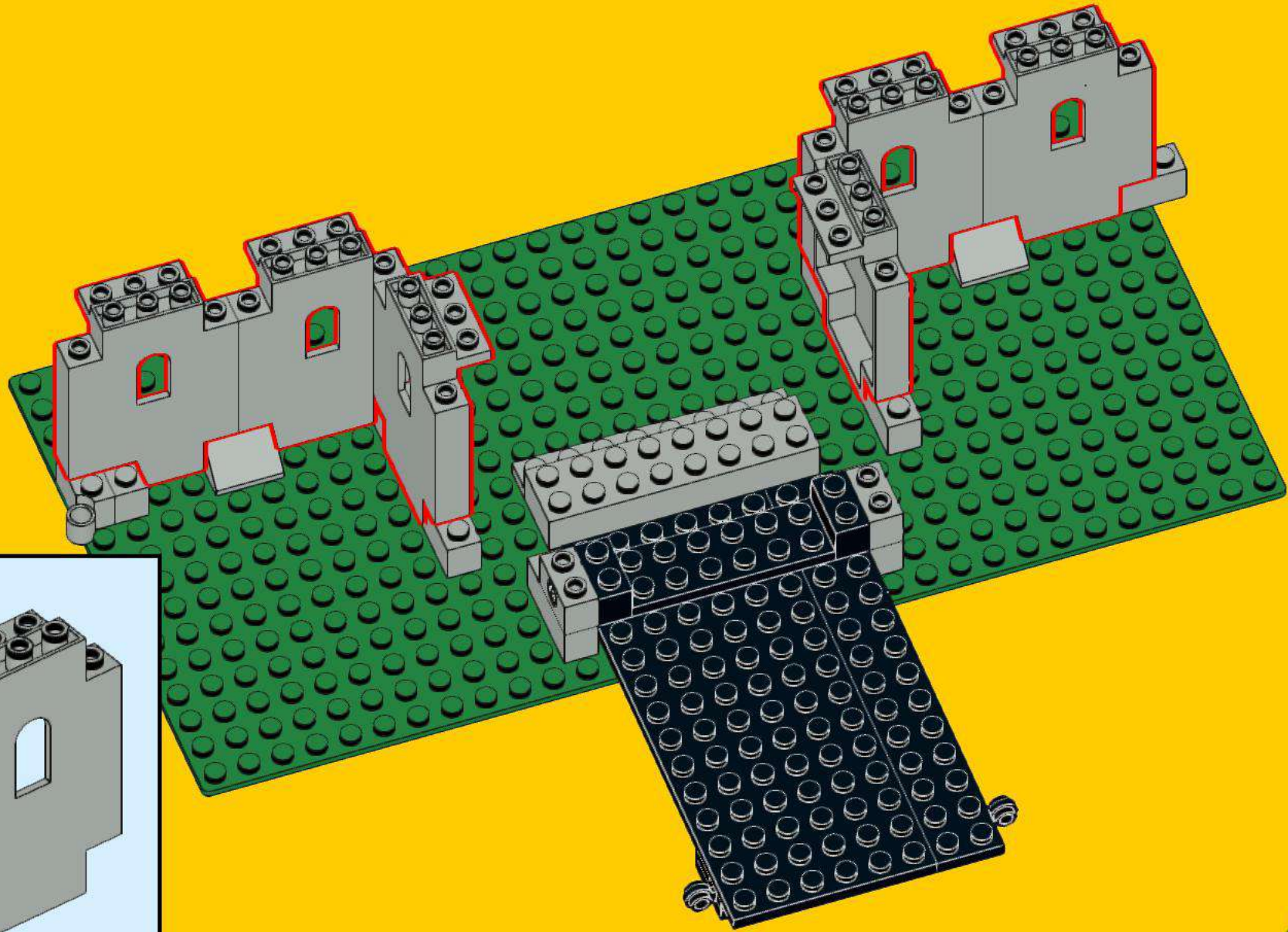

47

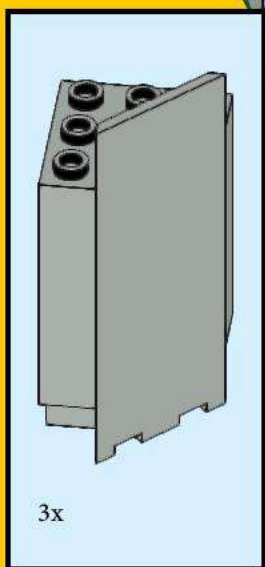
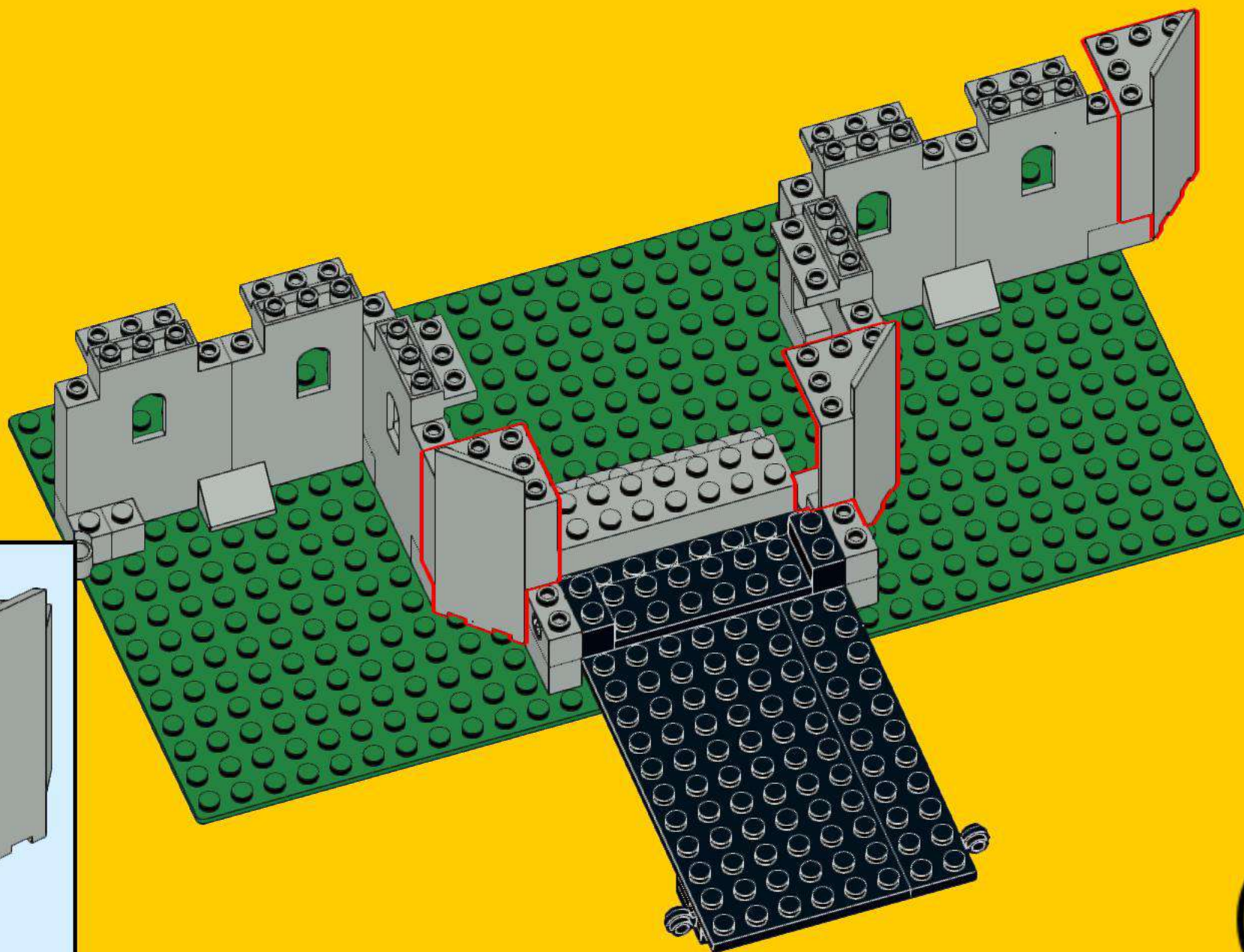

48

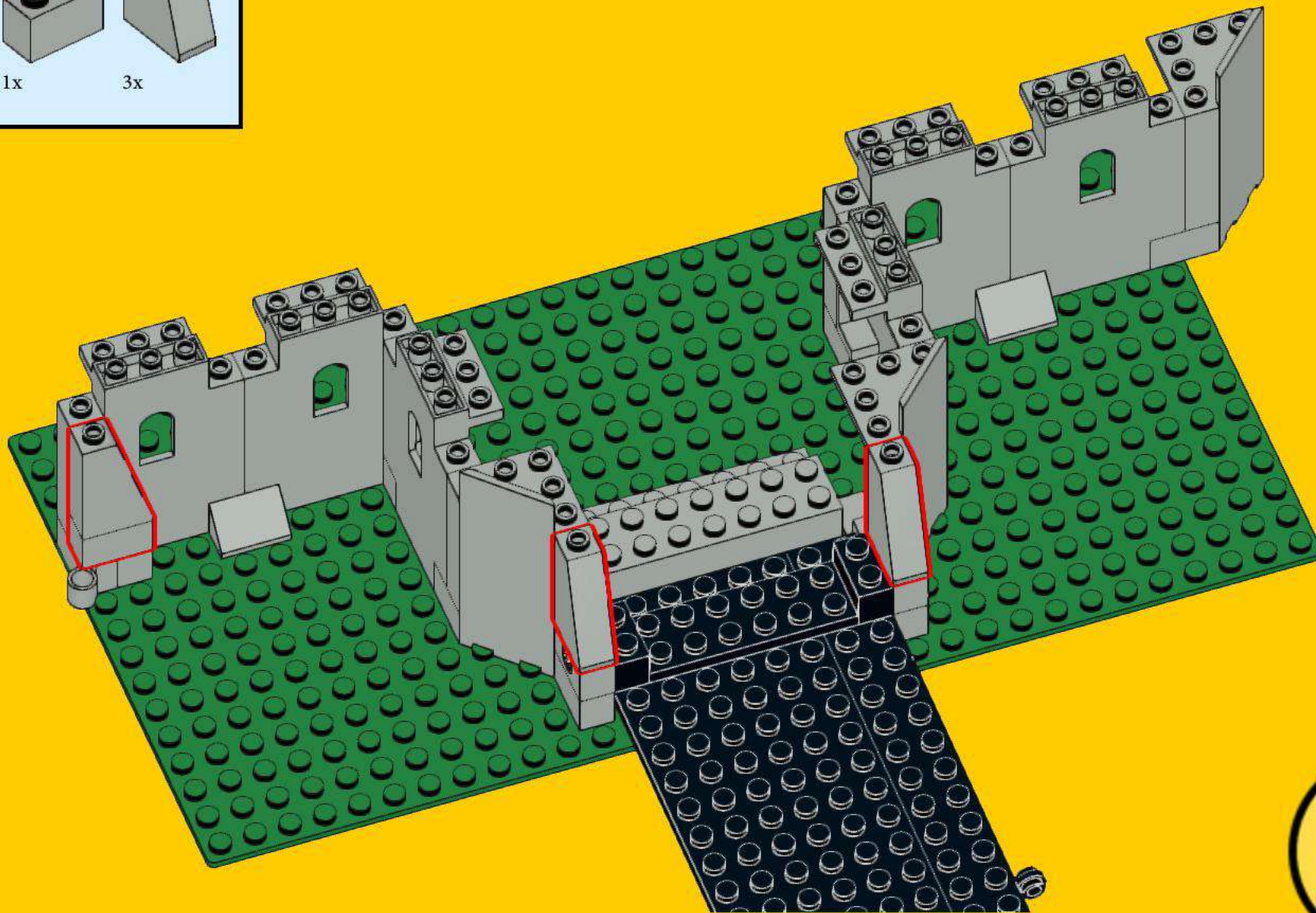
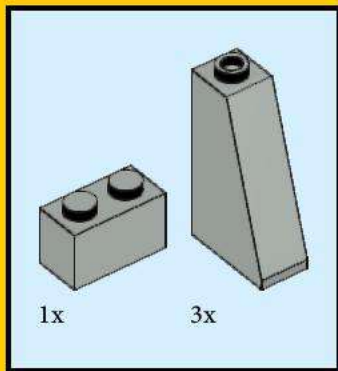

49

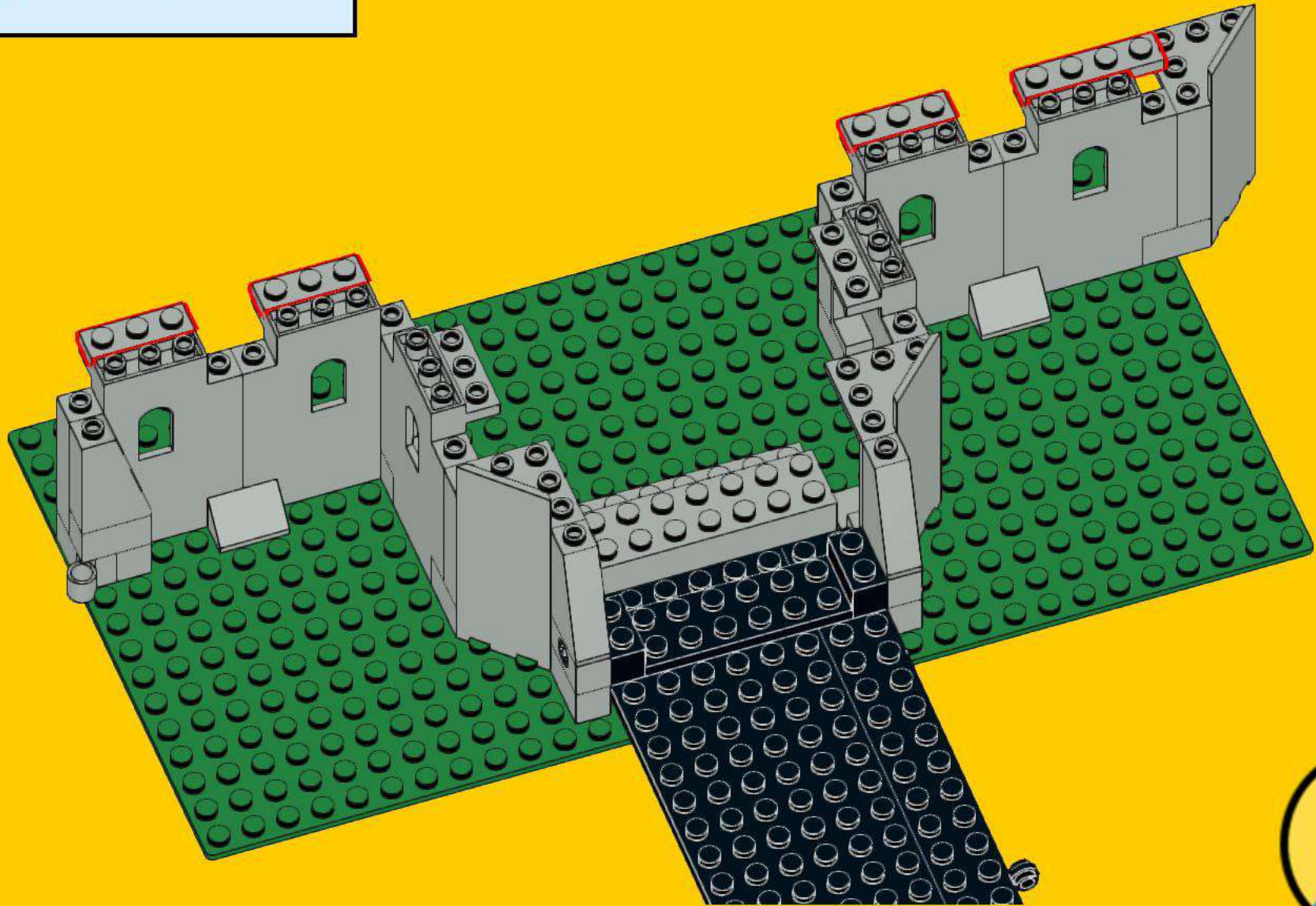
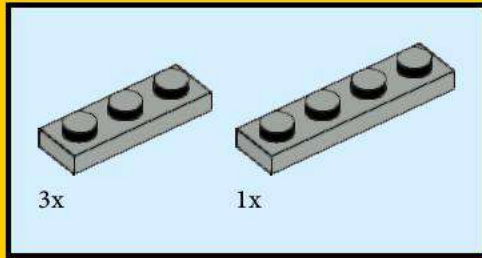

50

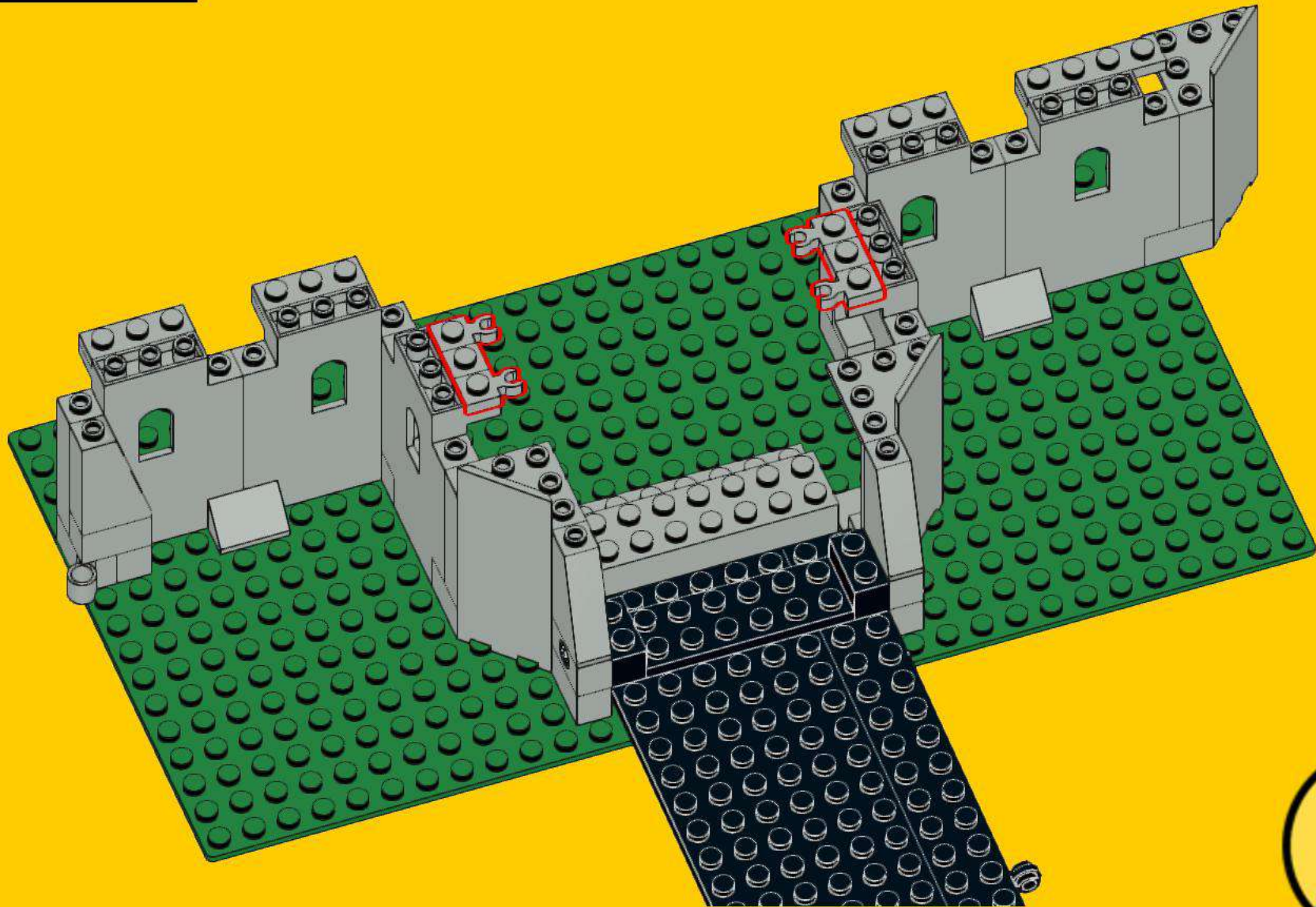
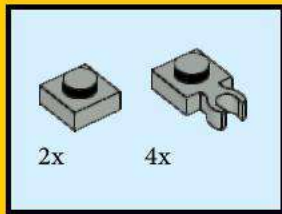

51

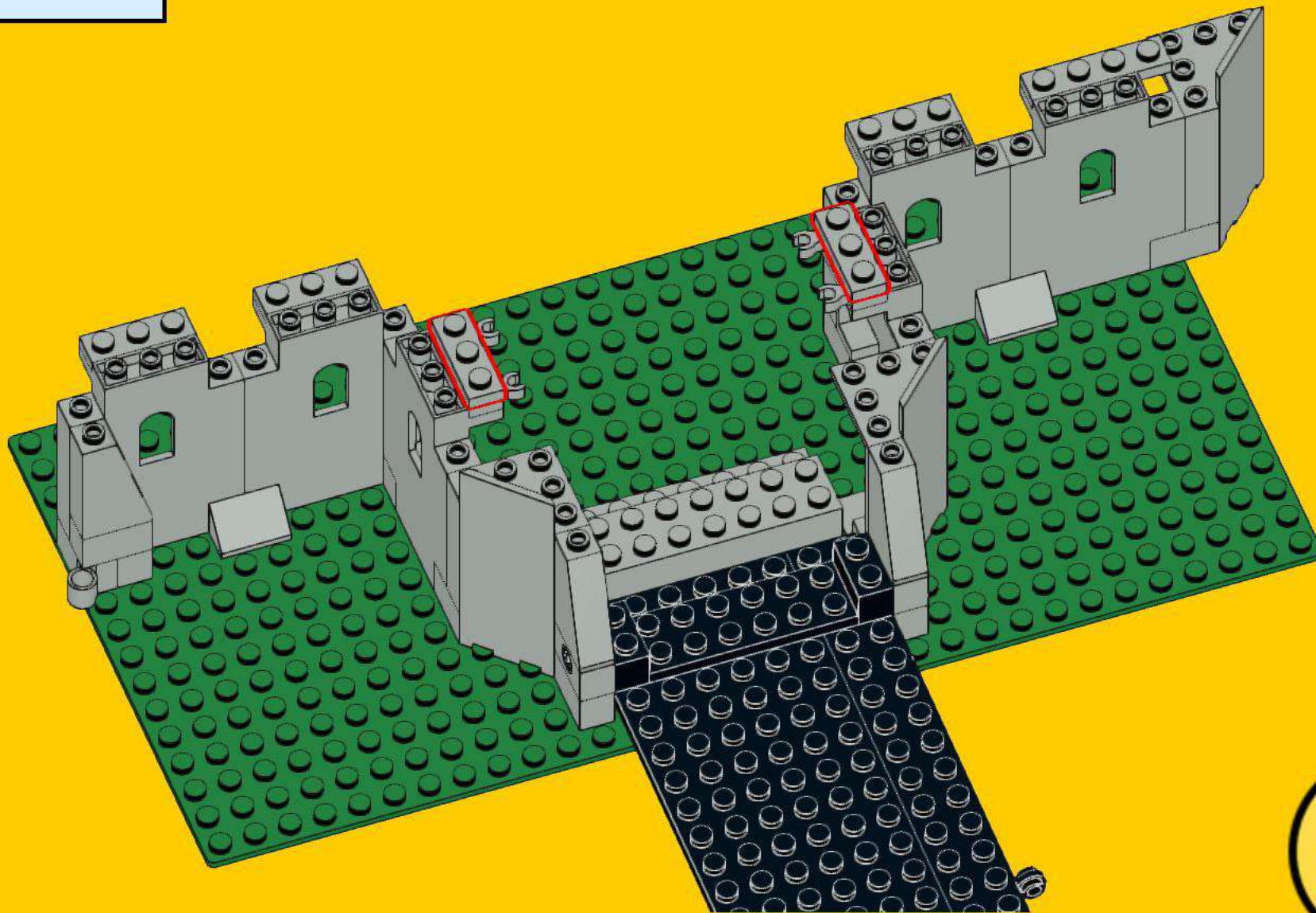
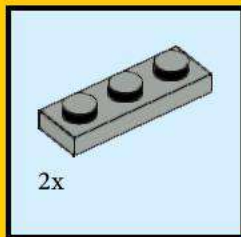

52

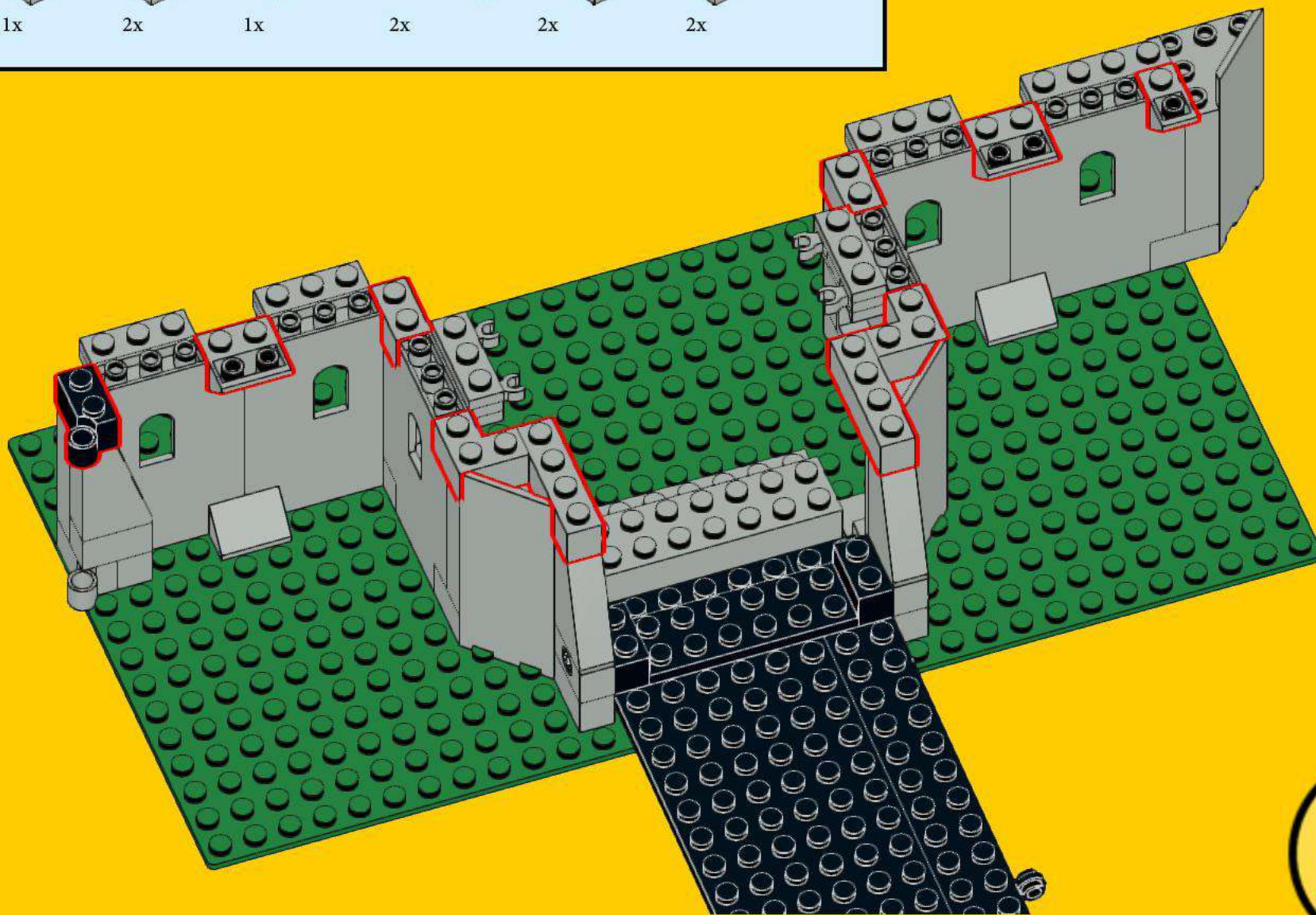
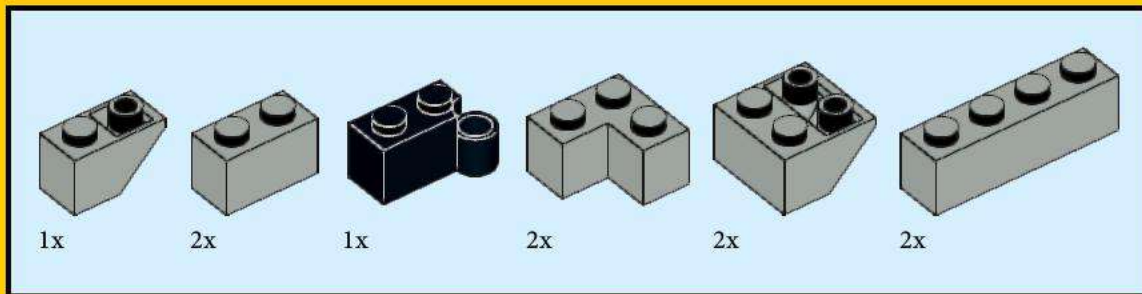

53

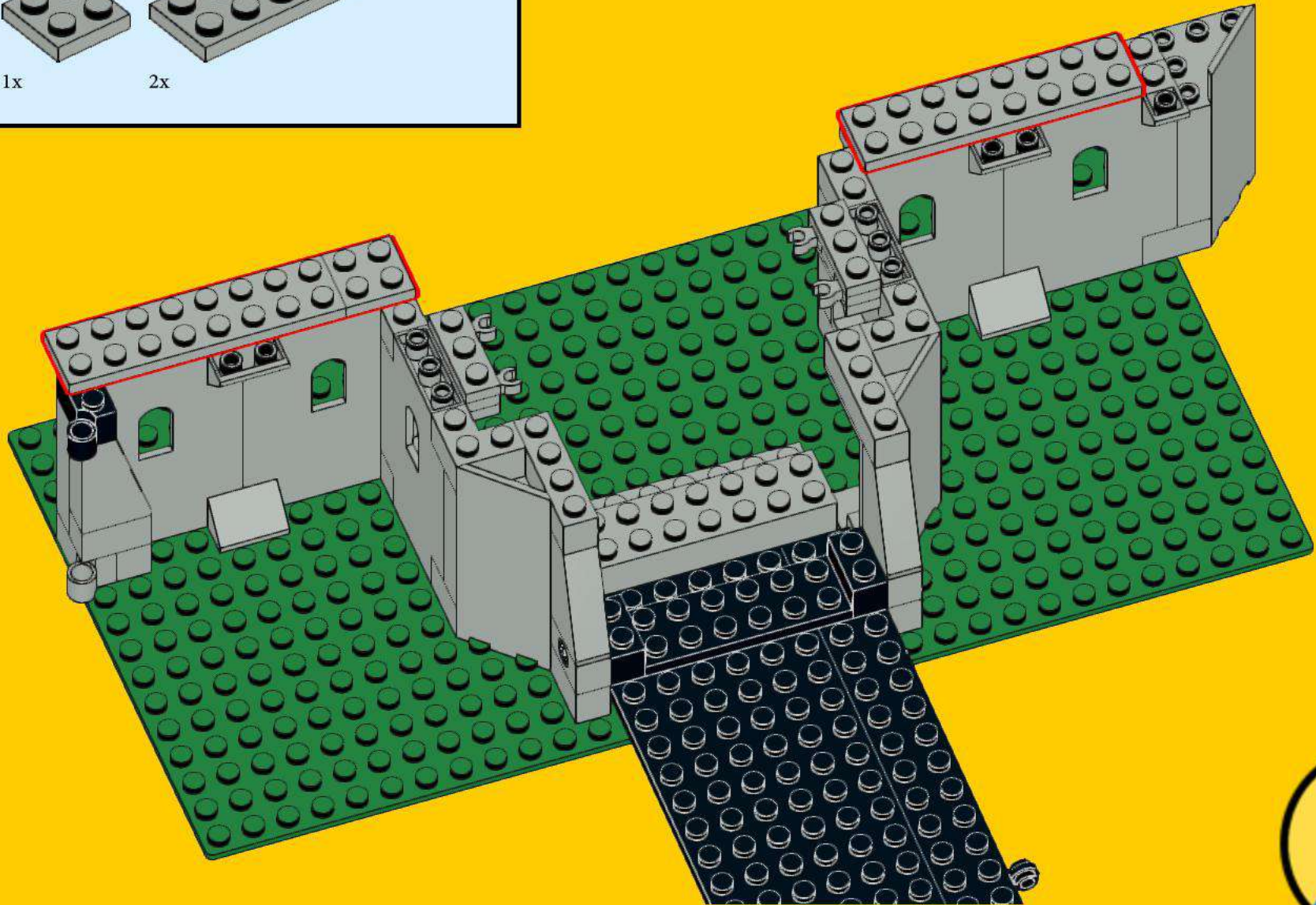
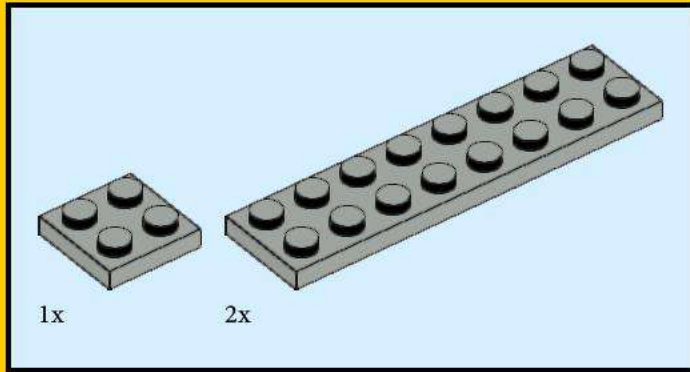

54

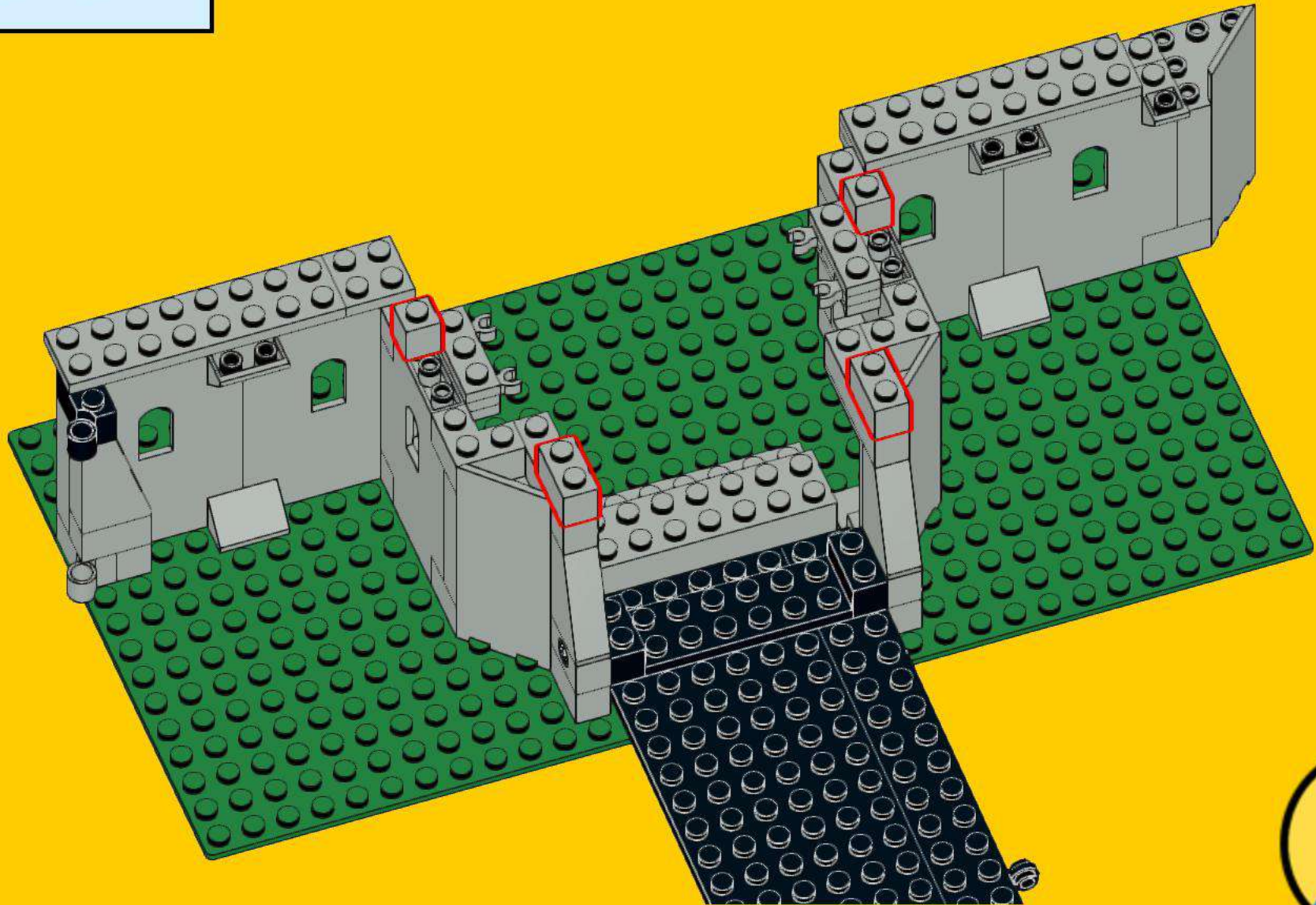
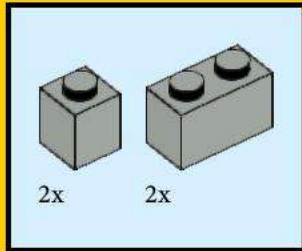

55

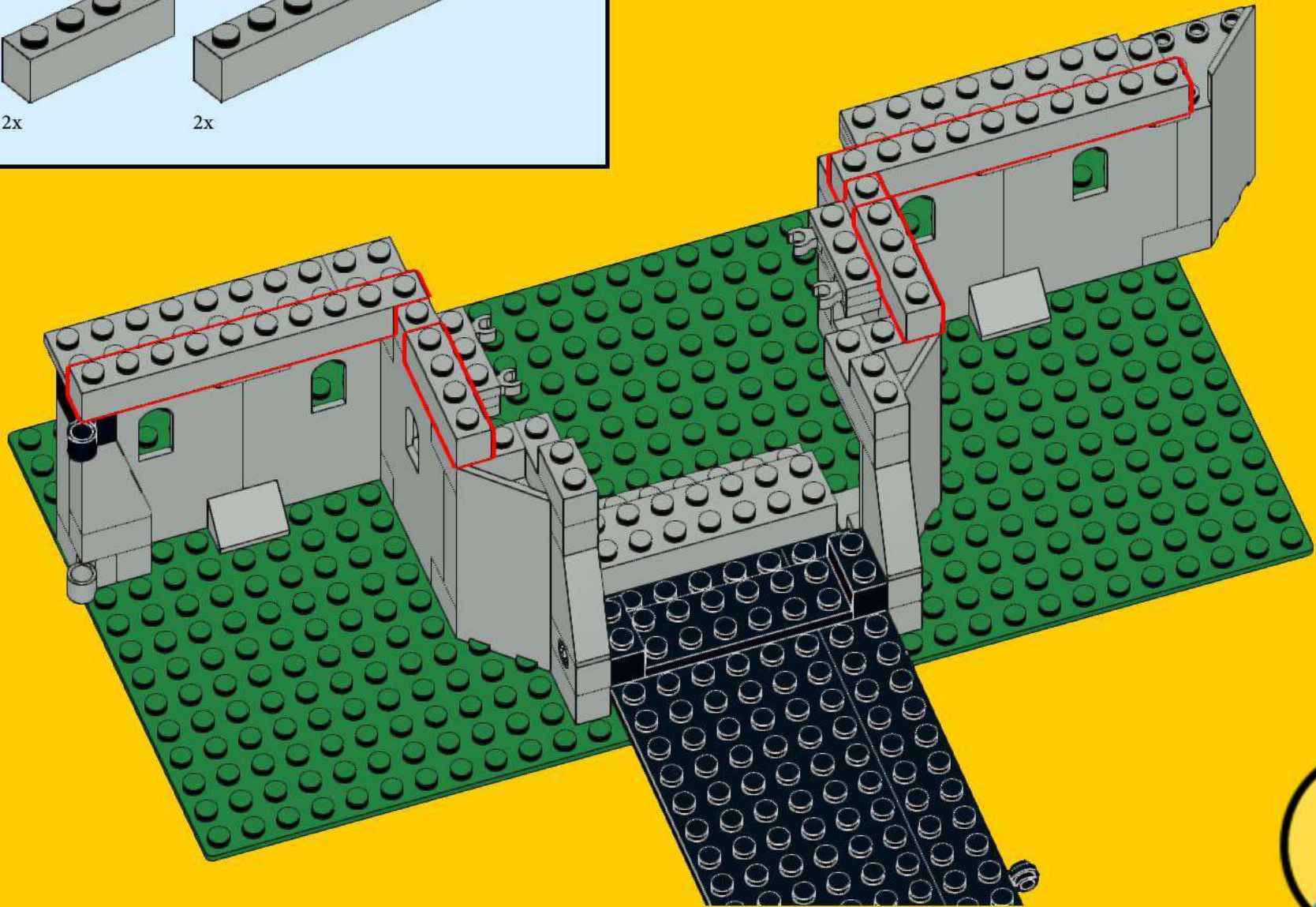
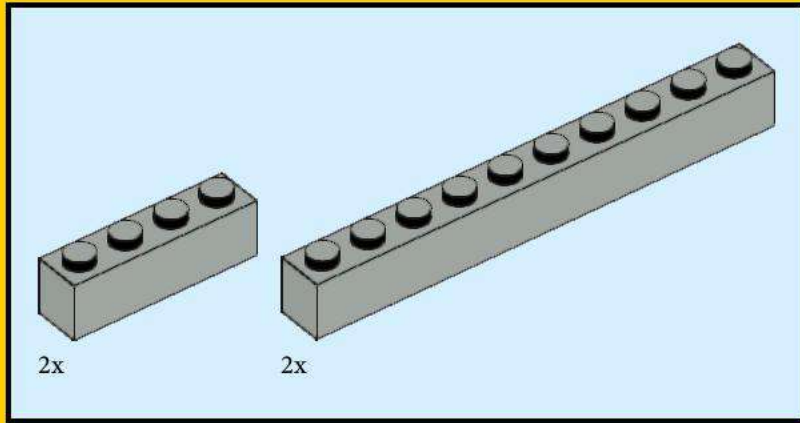

56

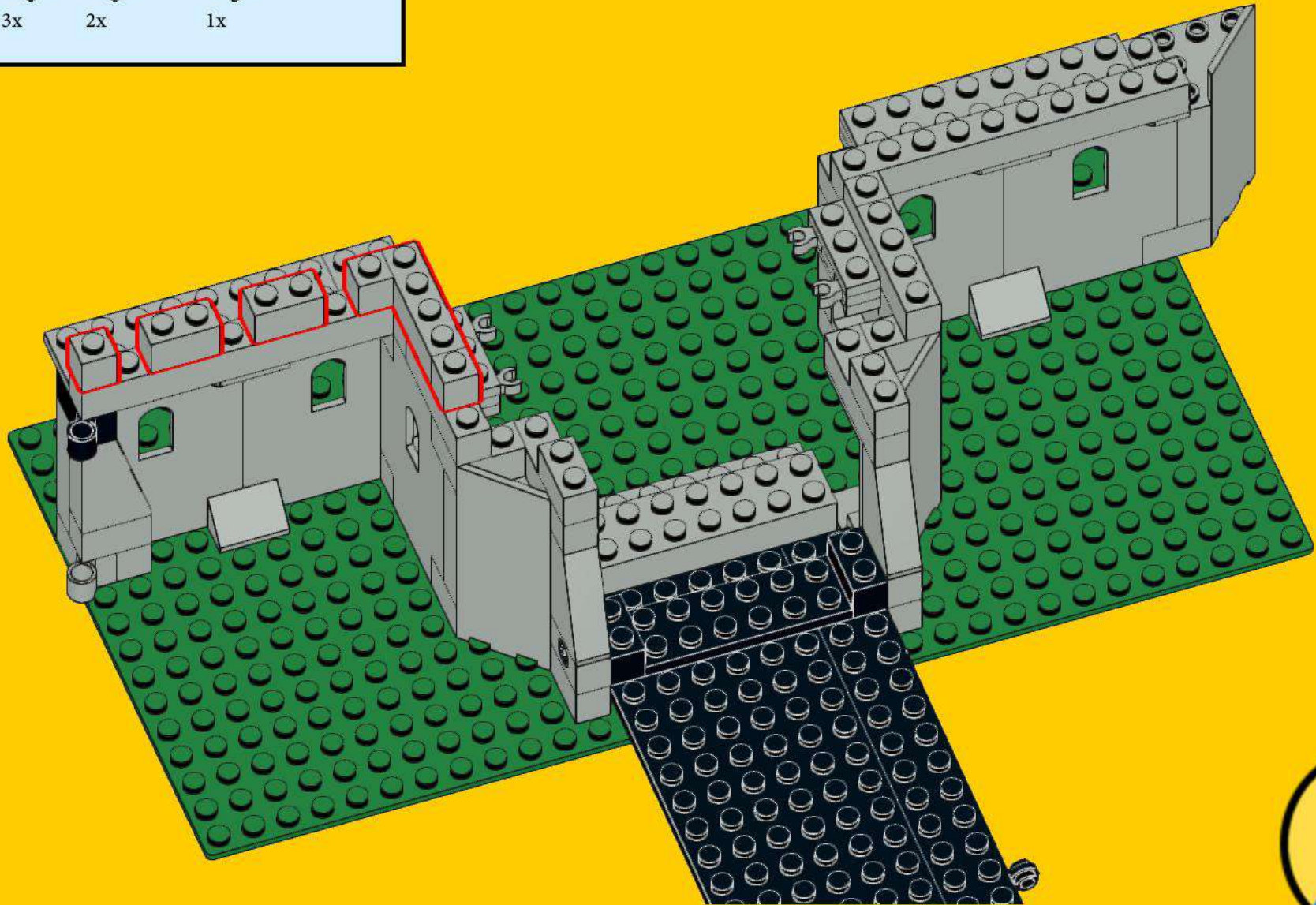
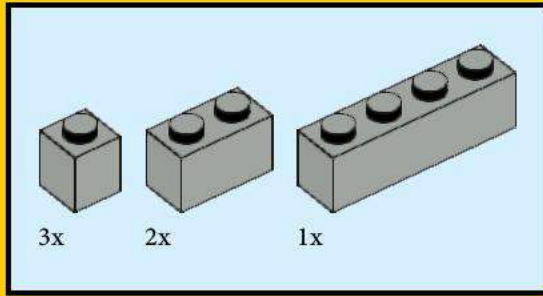

57

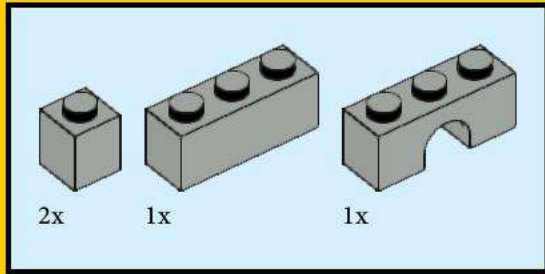

2x

1x

1x

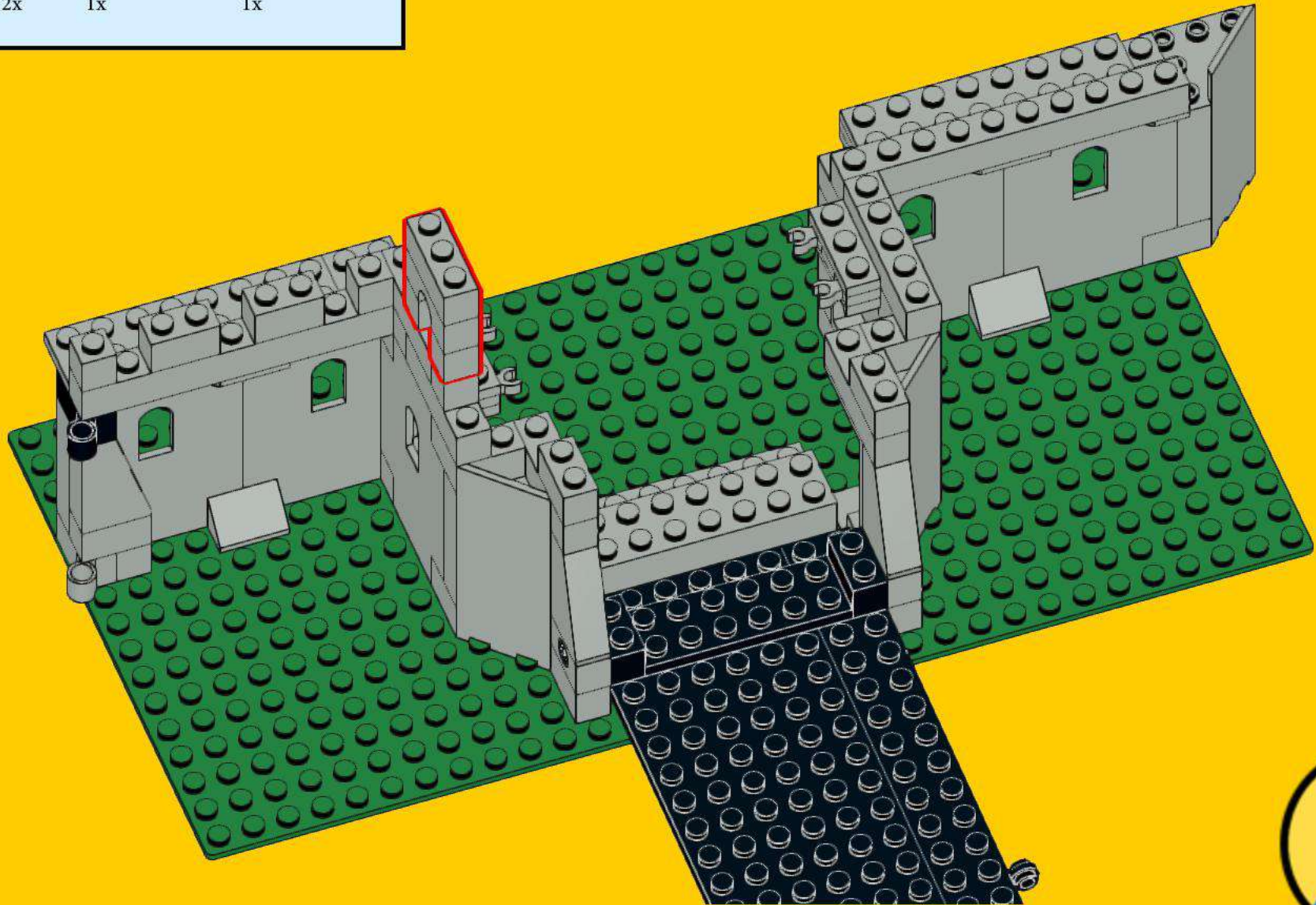

58

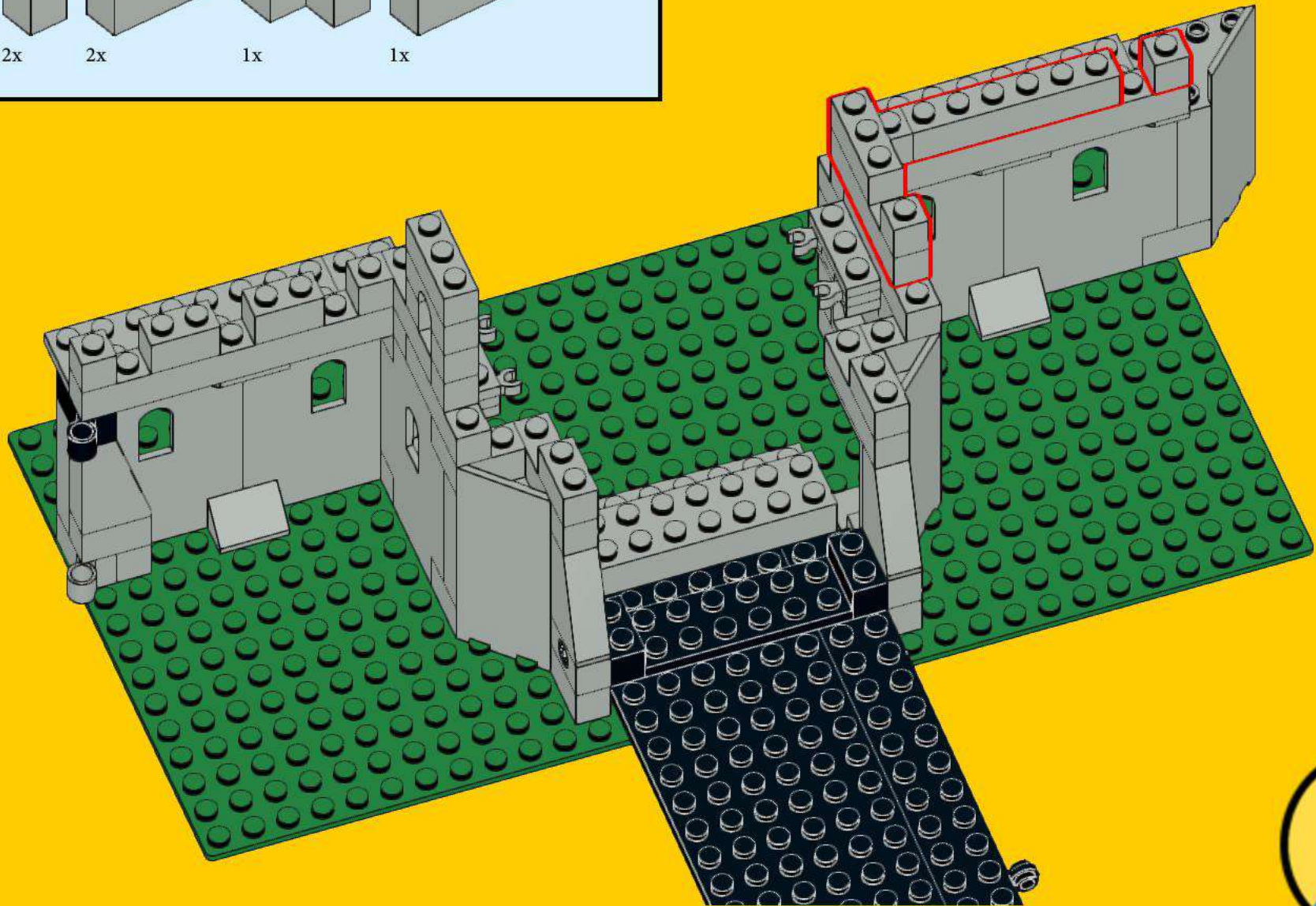
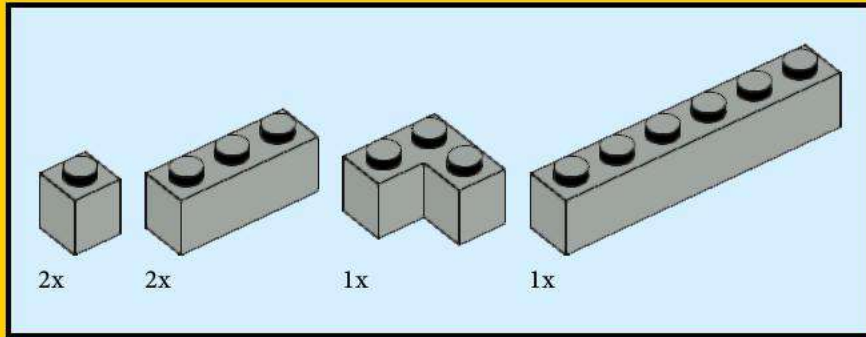

59

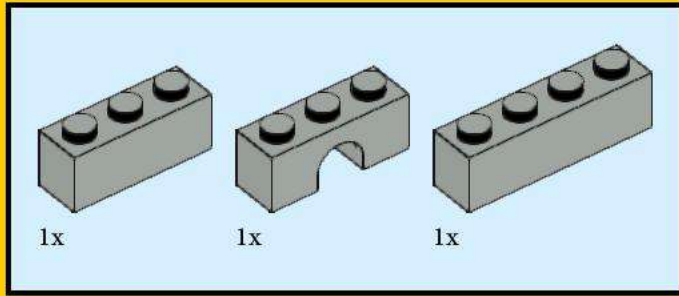

1x

1x

1x

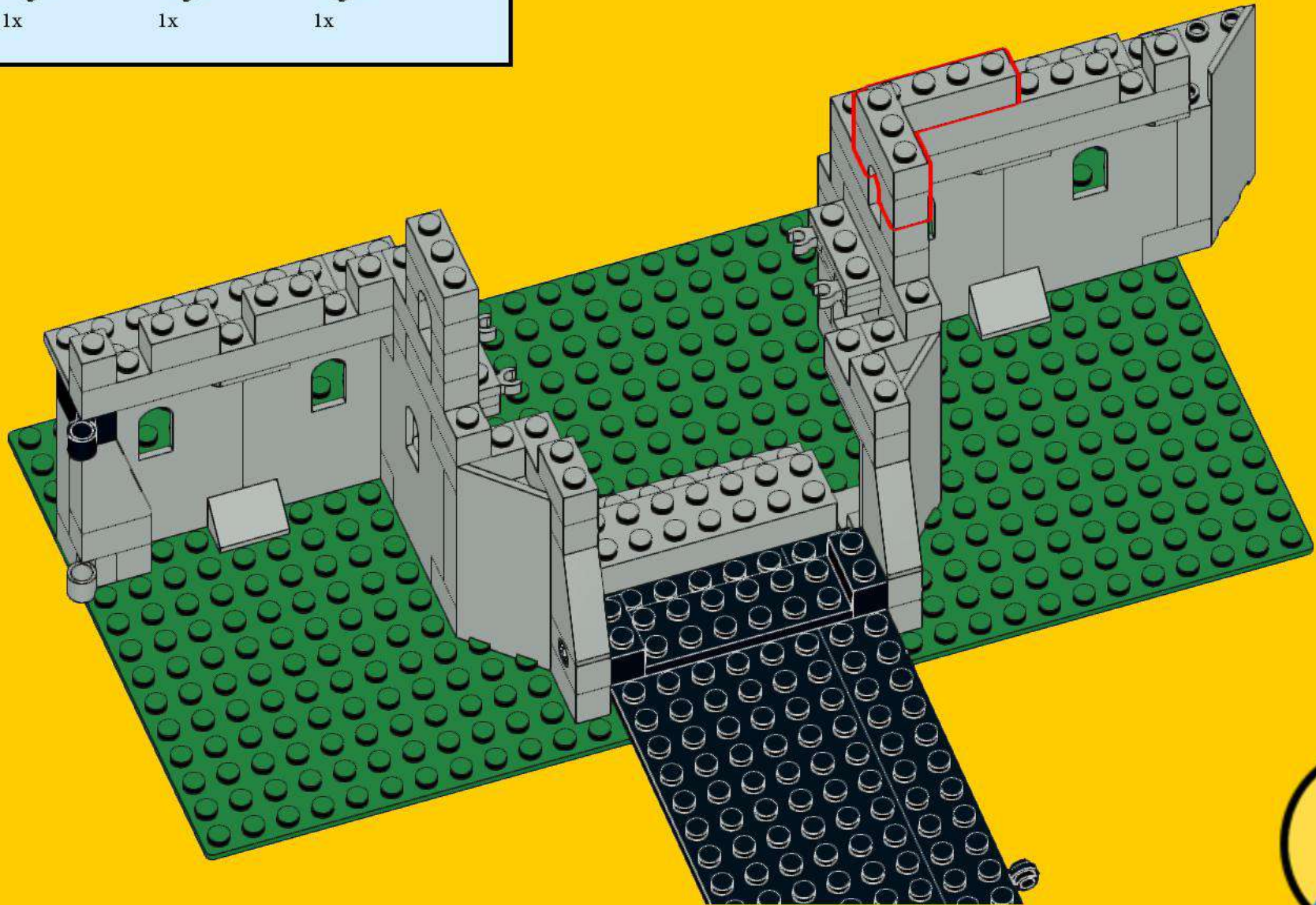

60

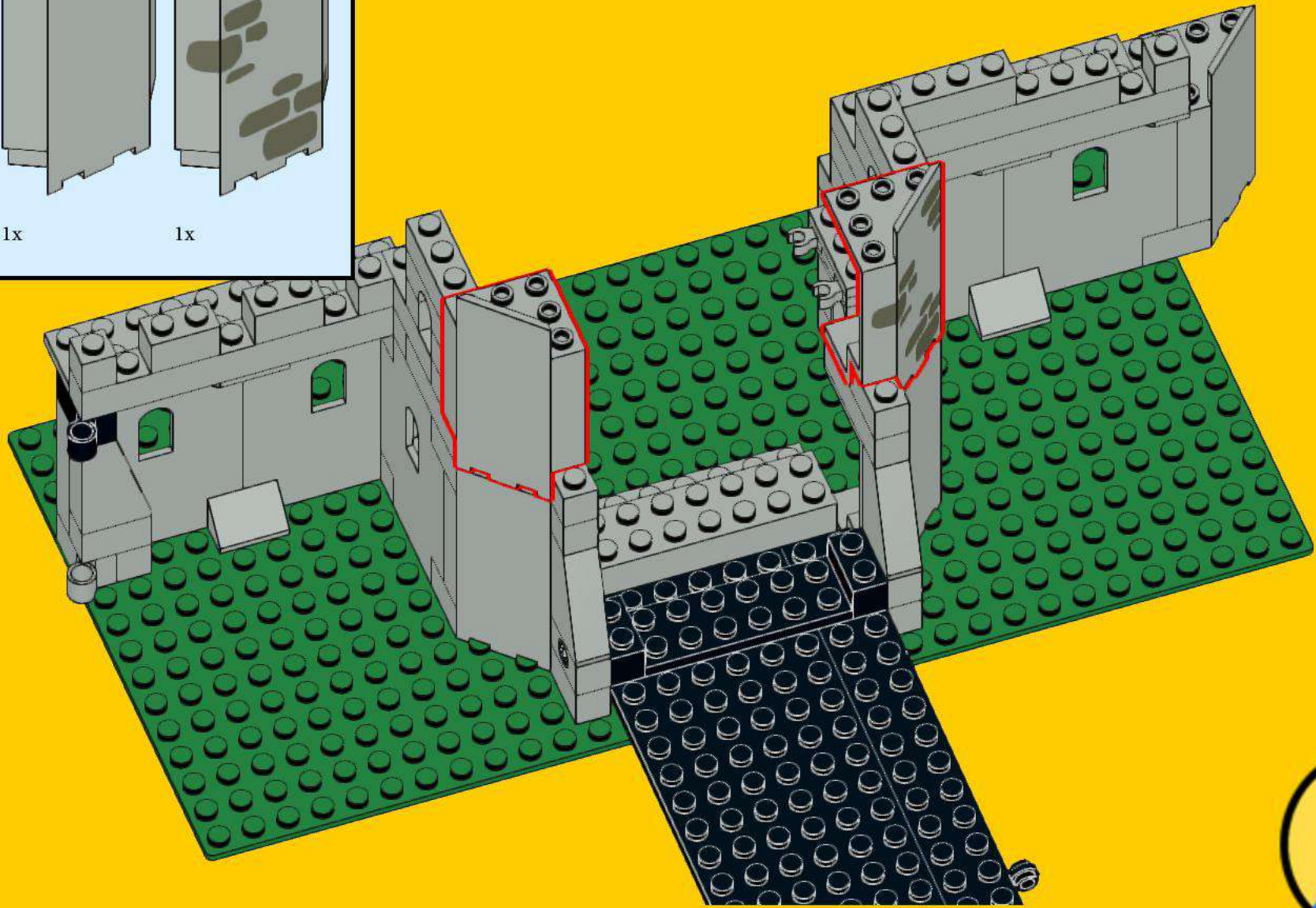
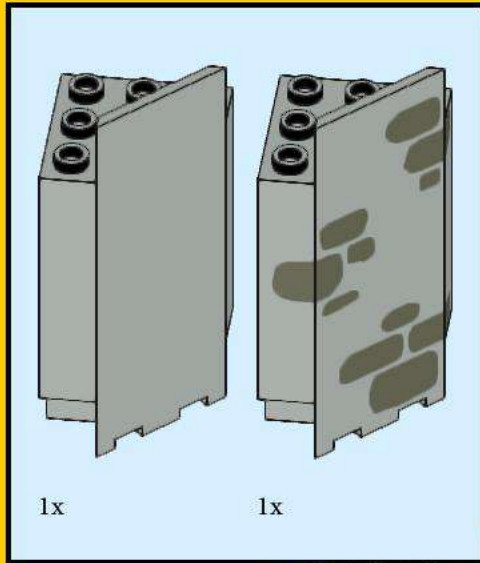

61

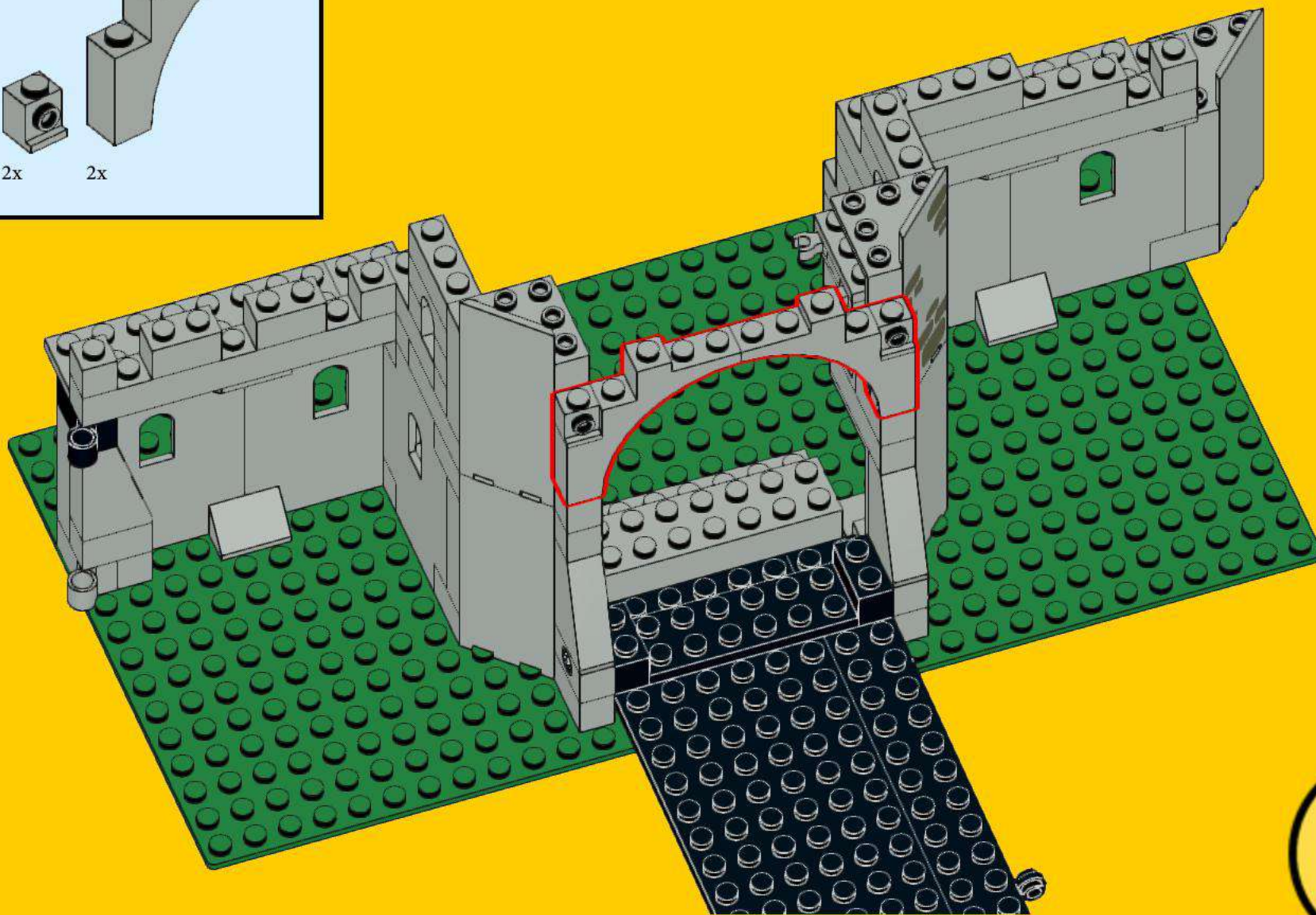
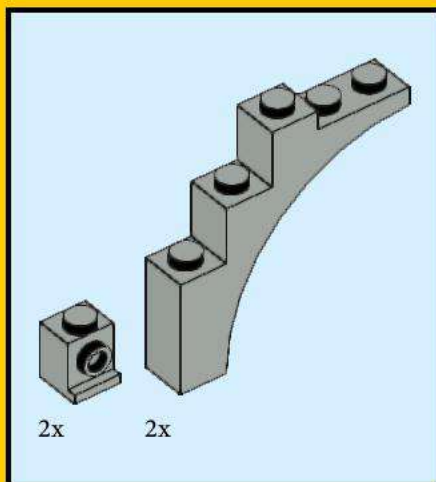

62

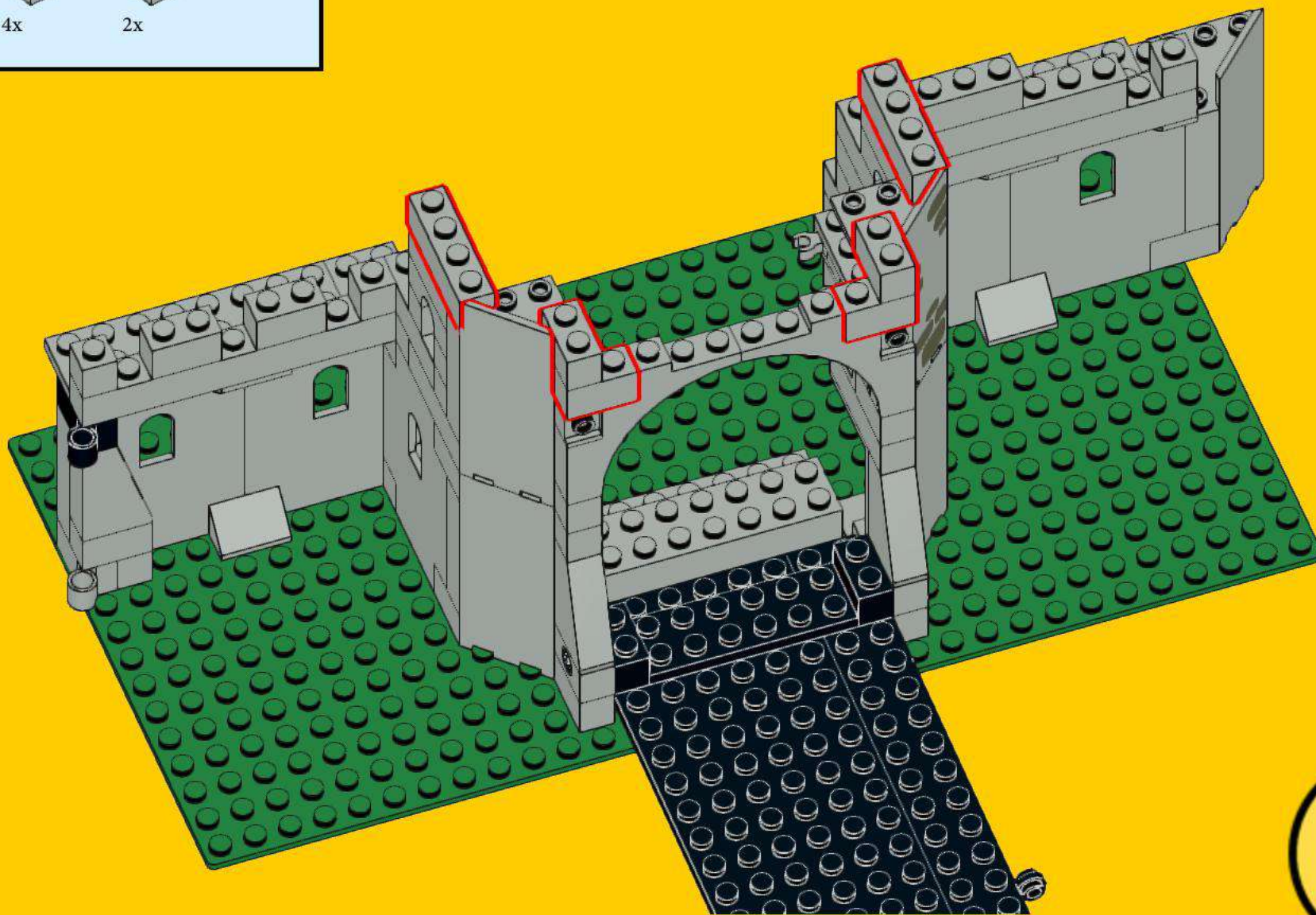
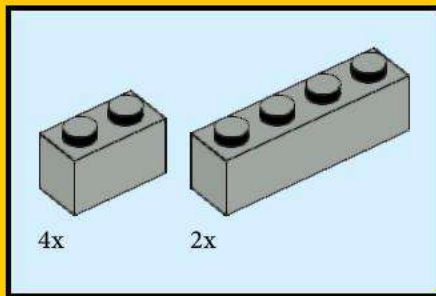

63

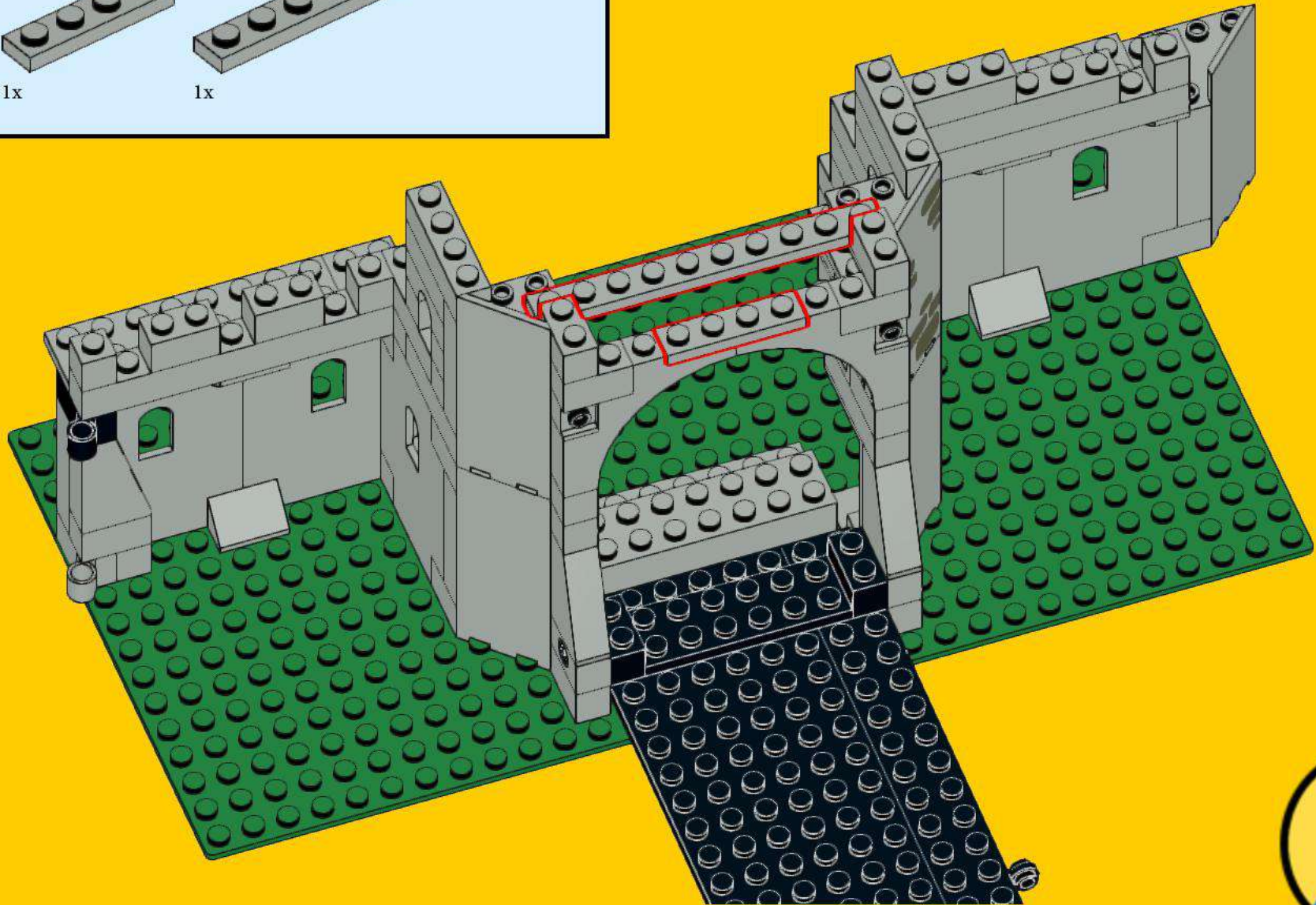
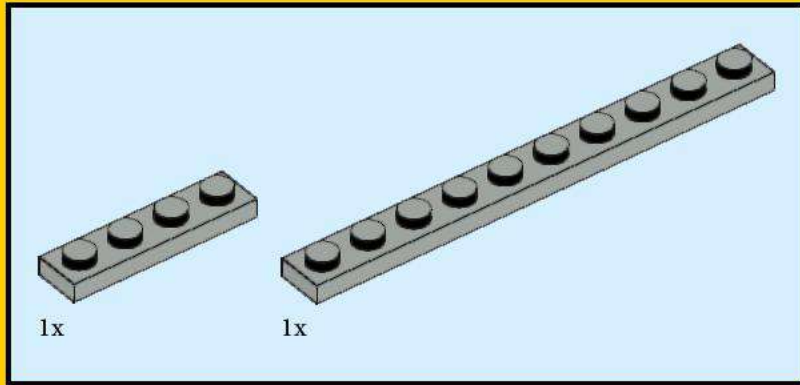

64

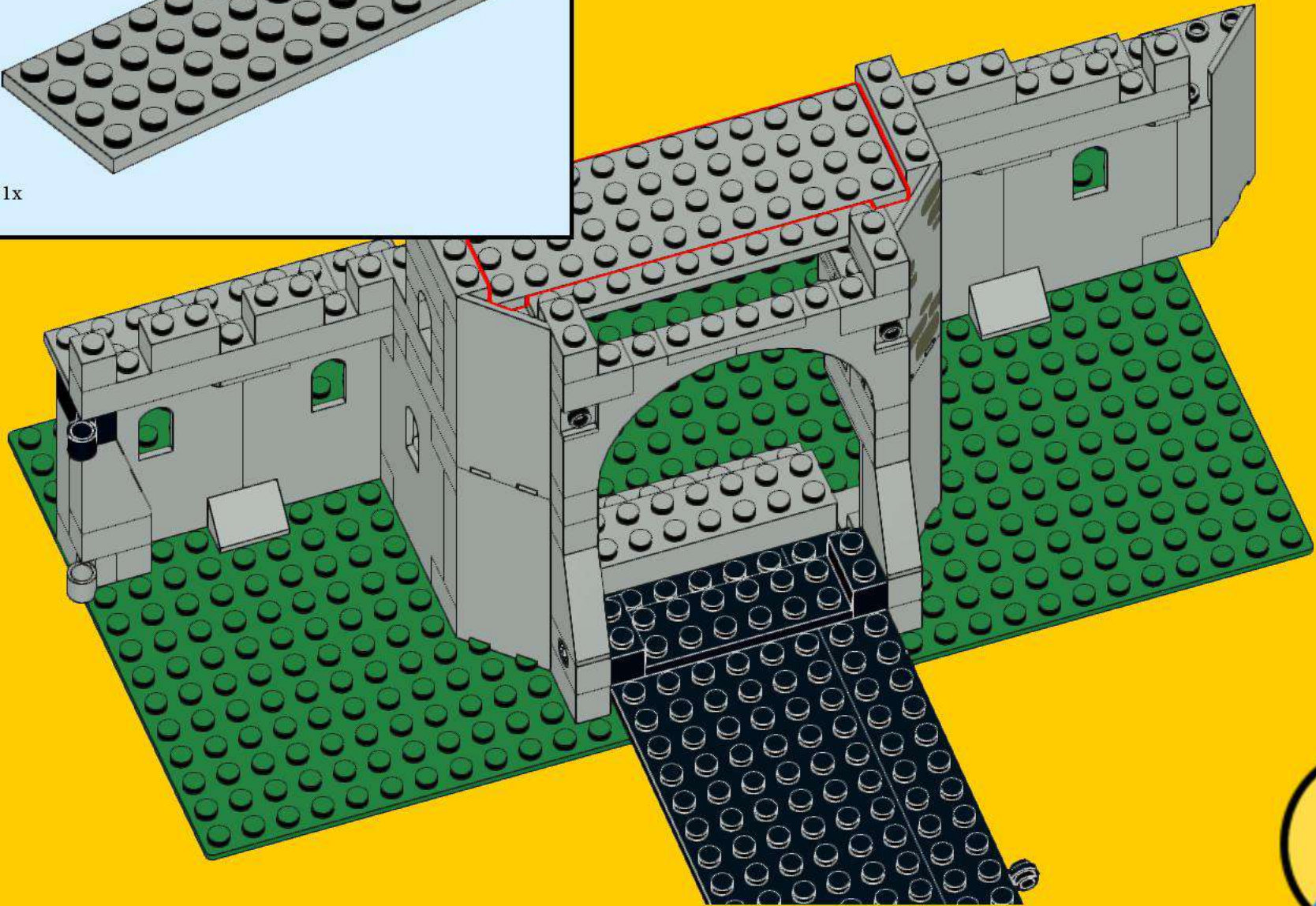
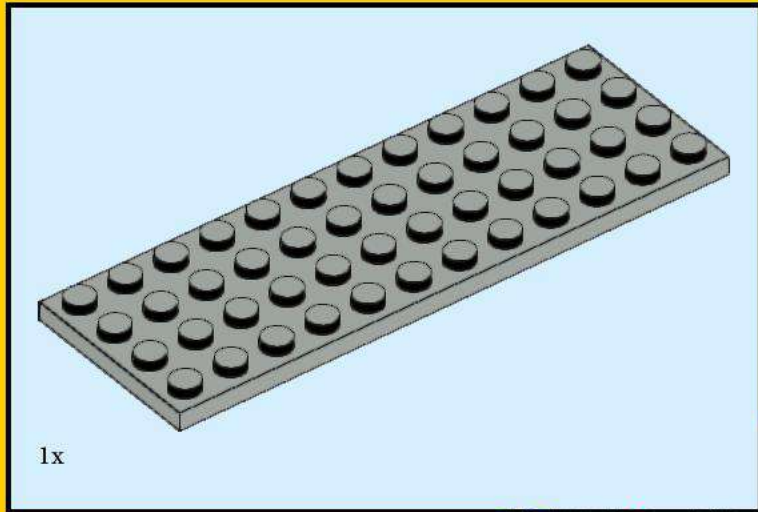

65

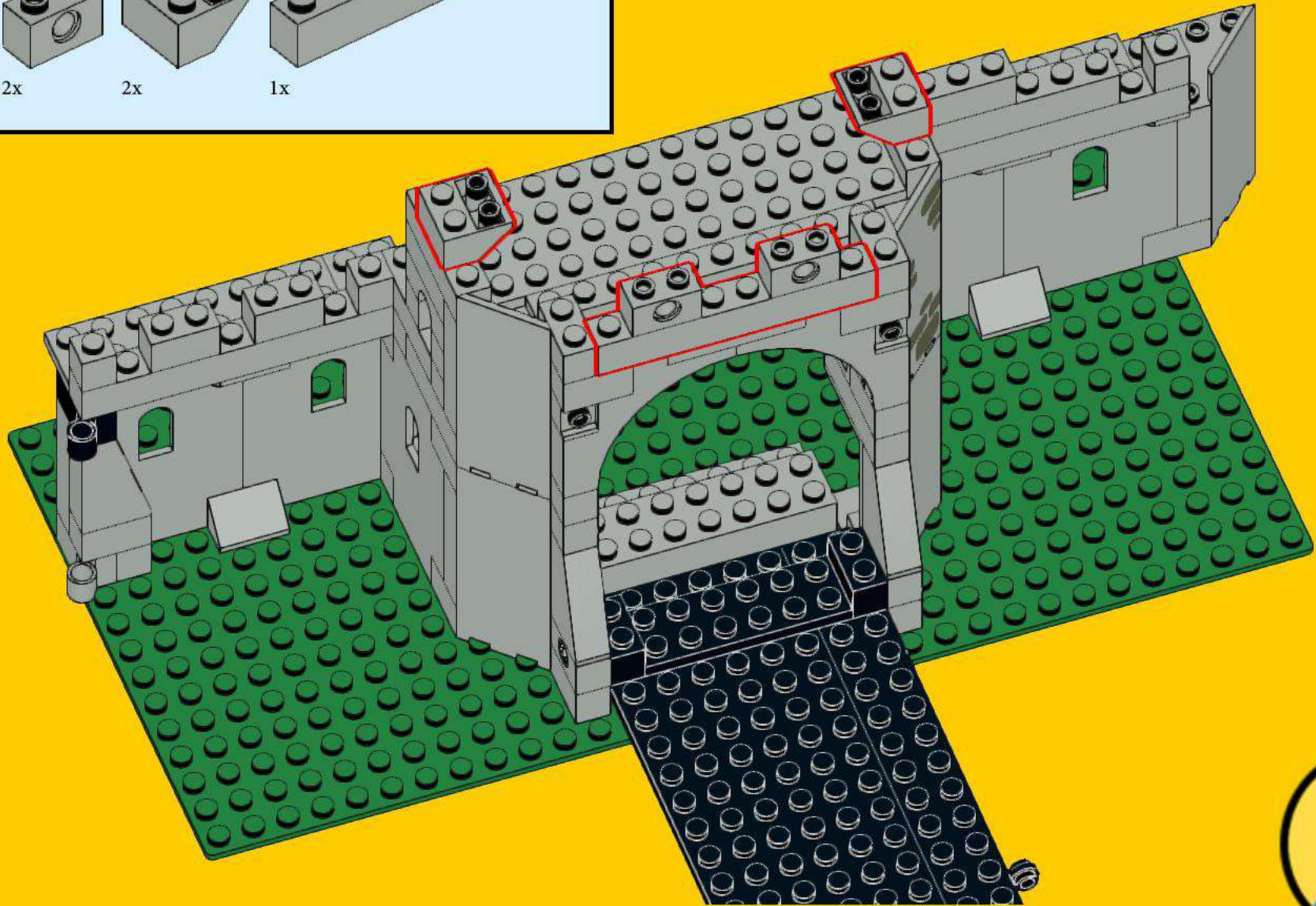
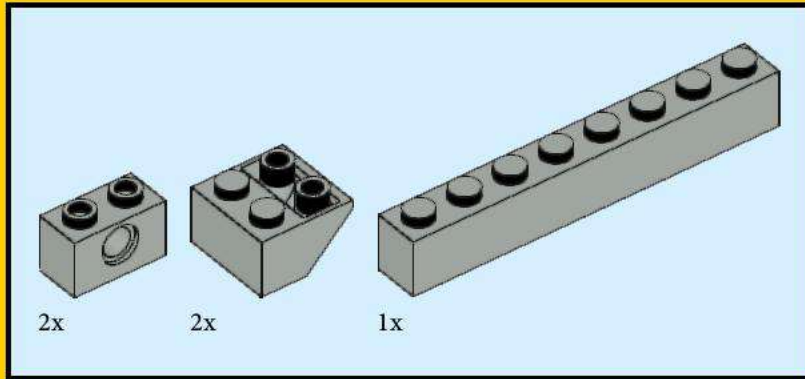

66

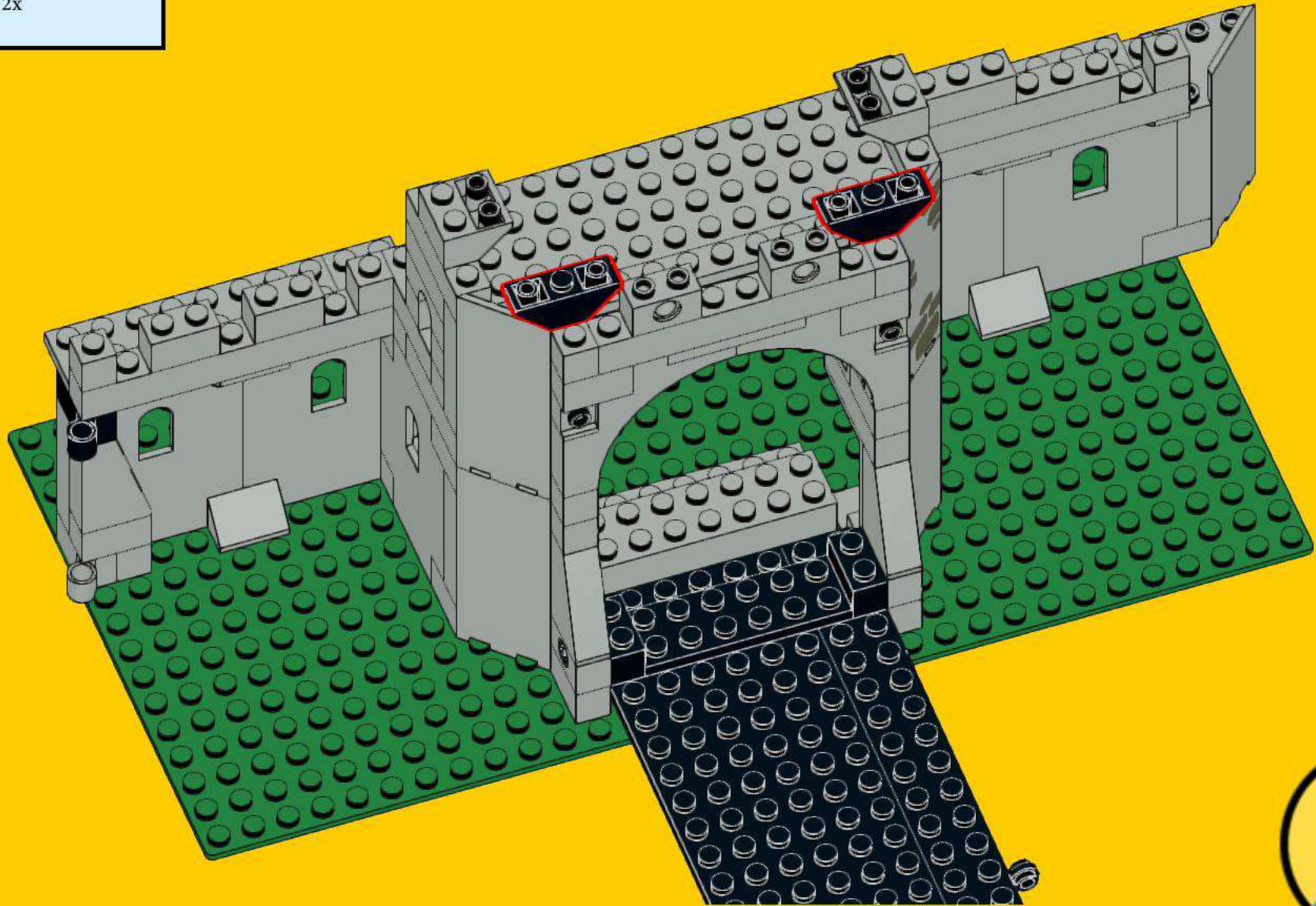
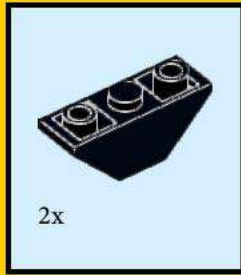

67

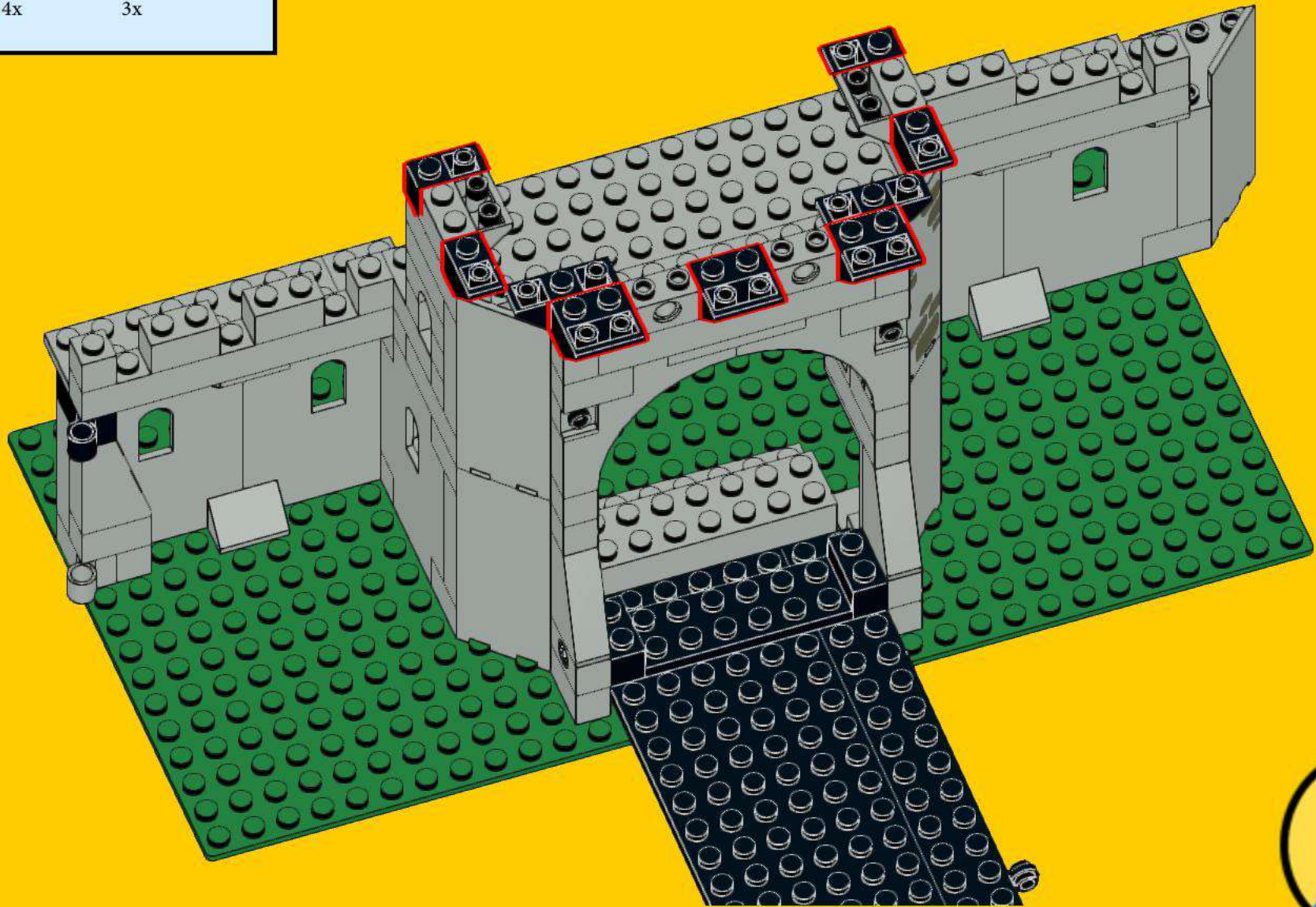
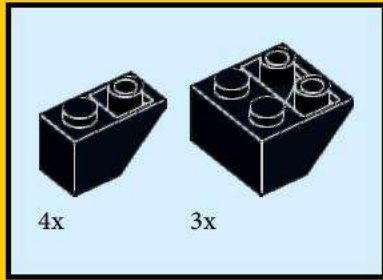

68

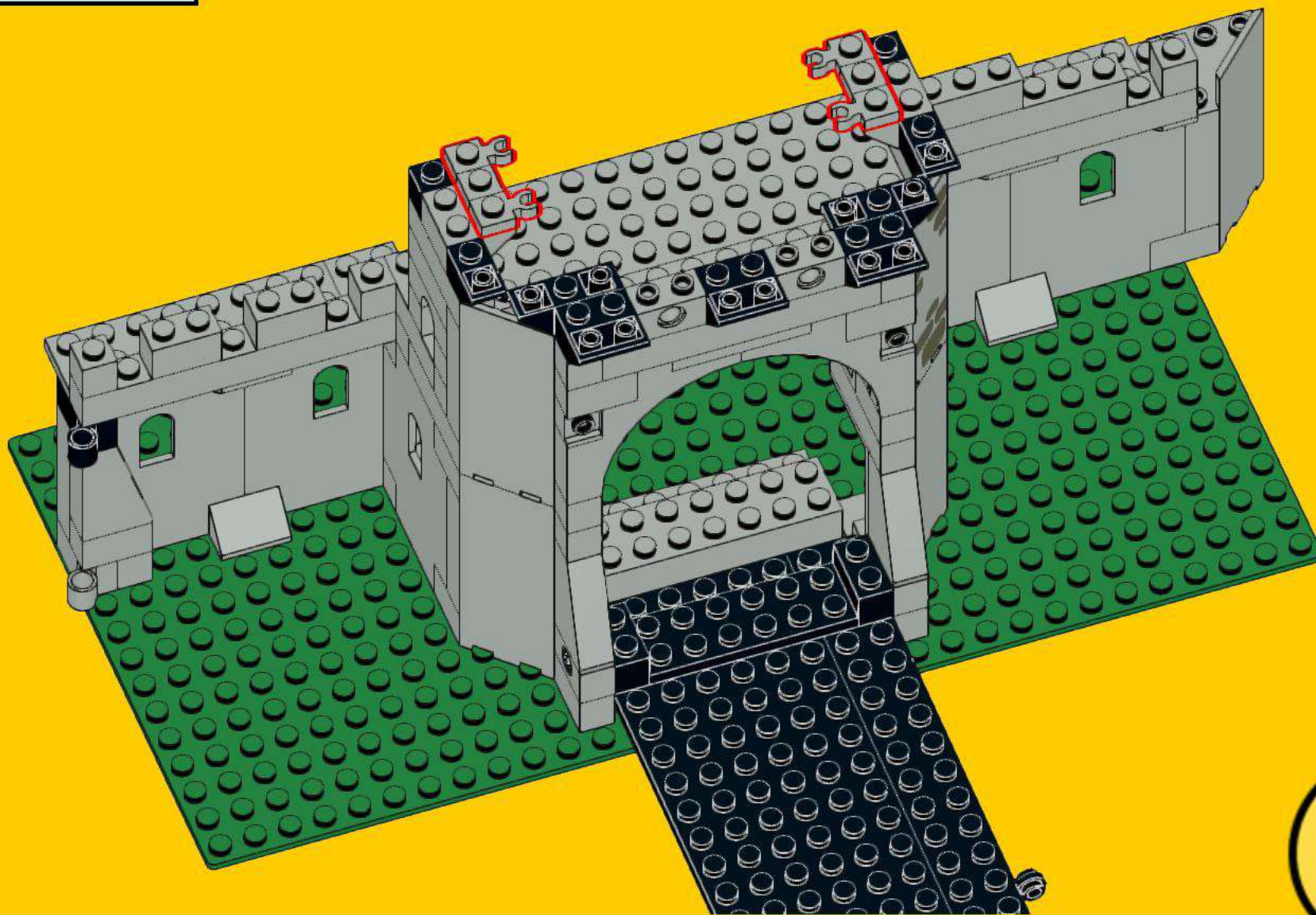
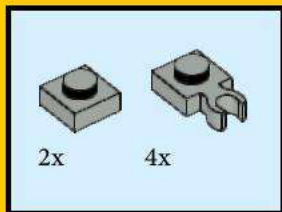

69

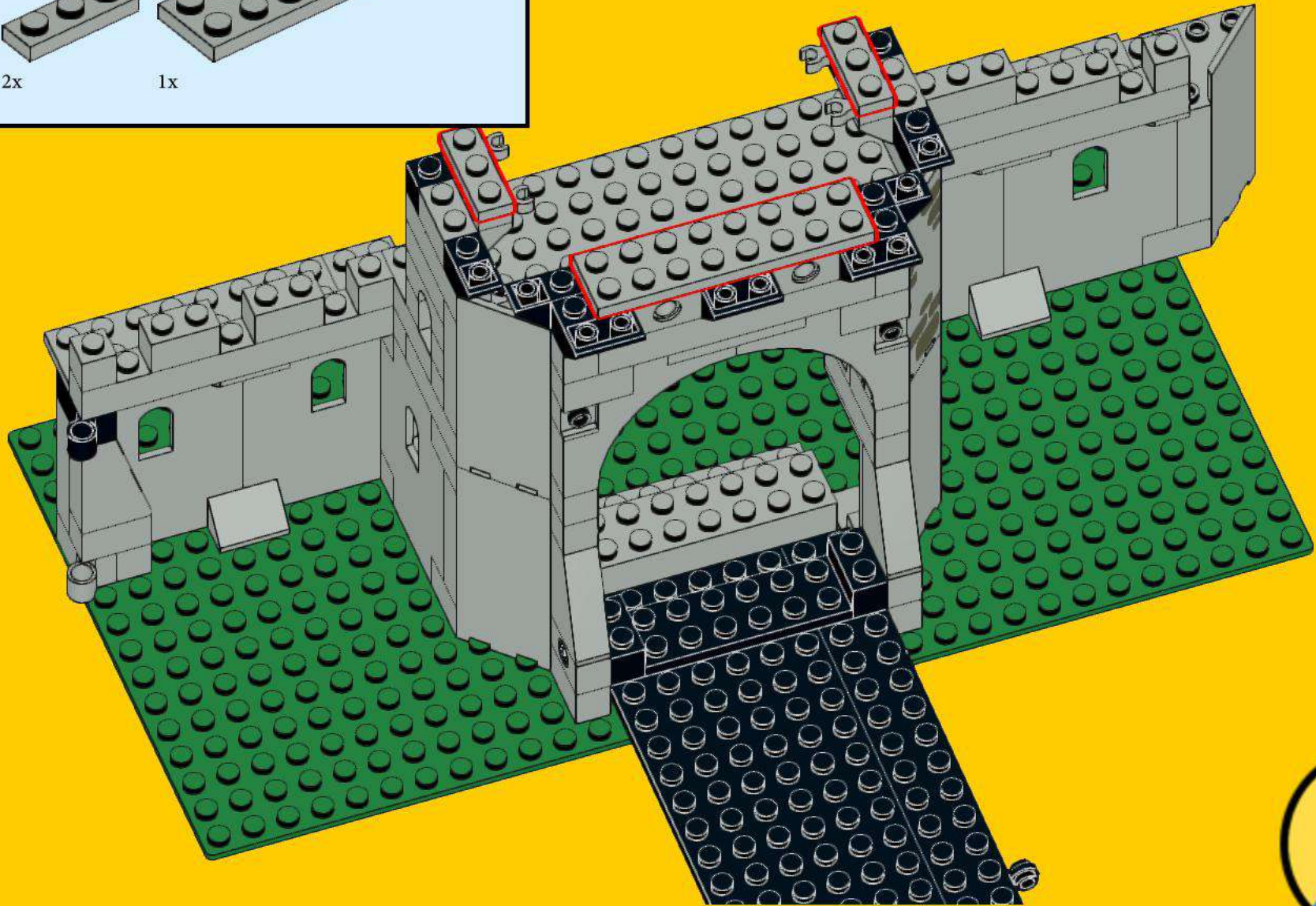
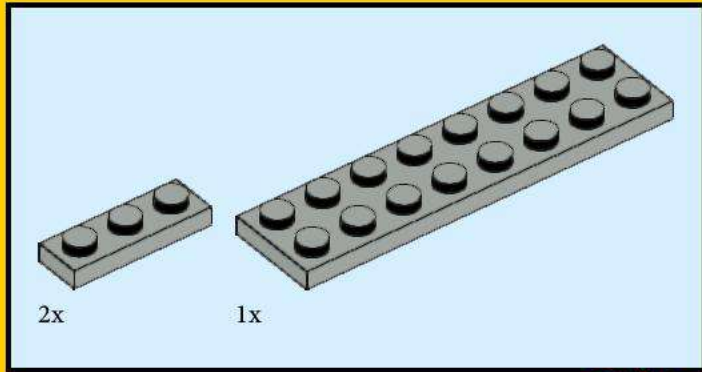

70

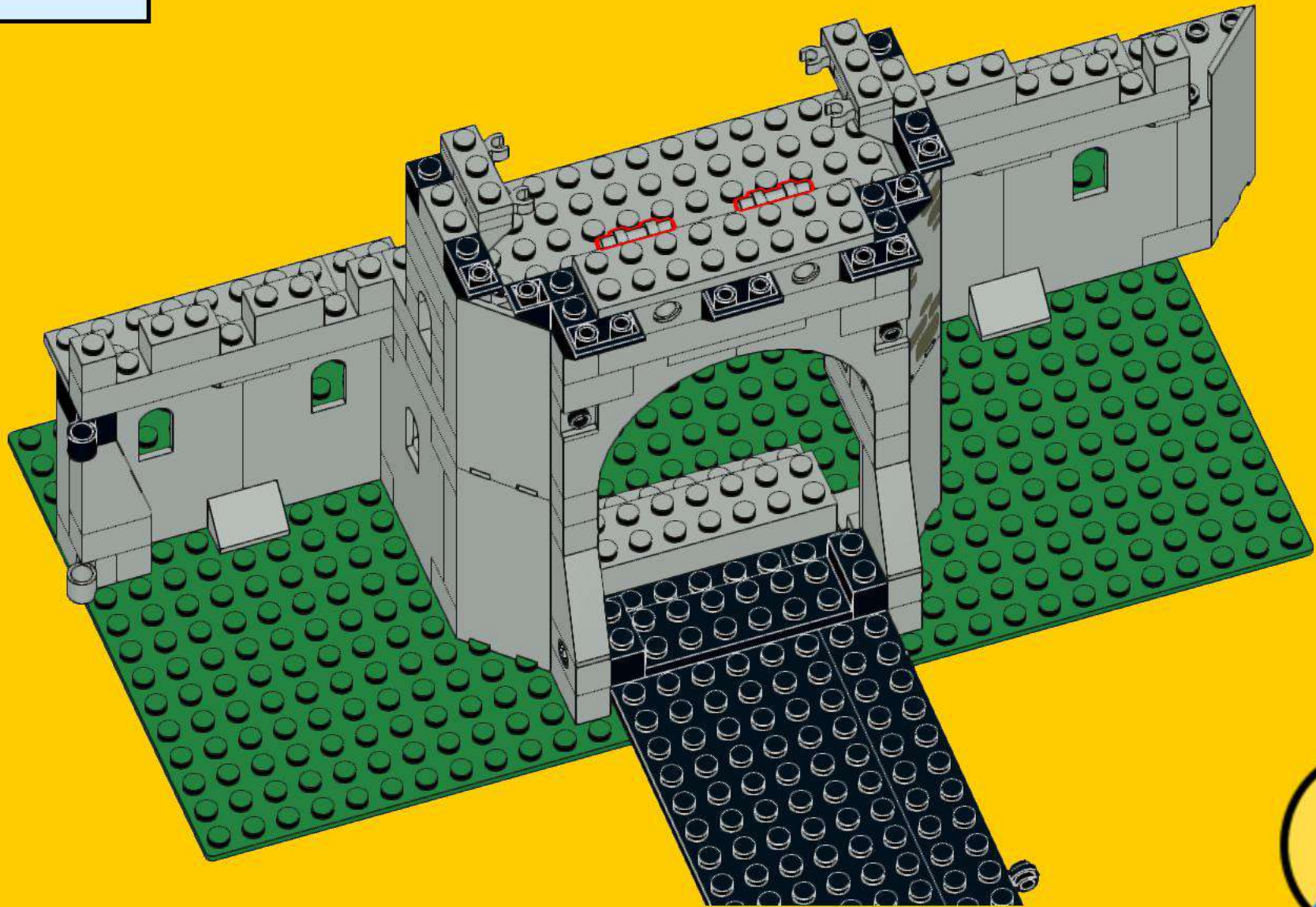
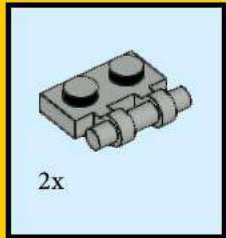

71

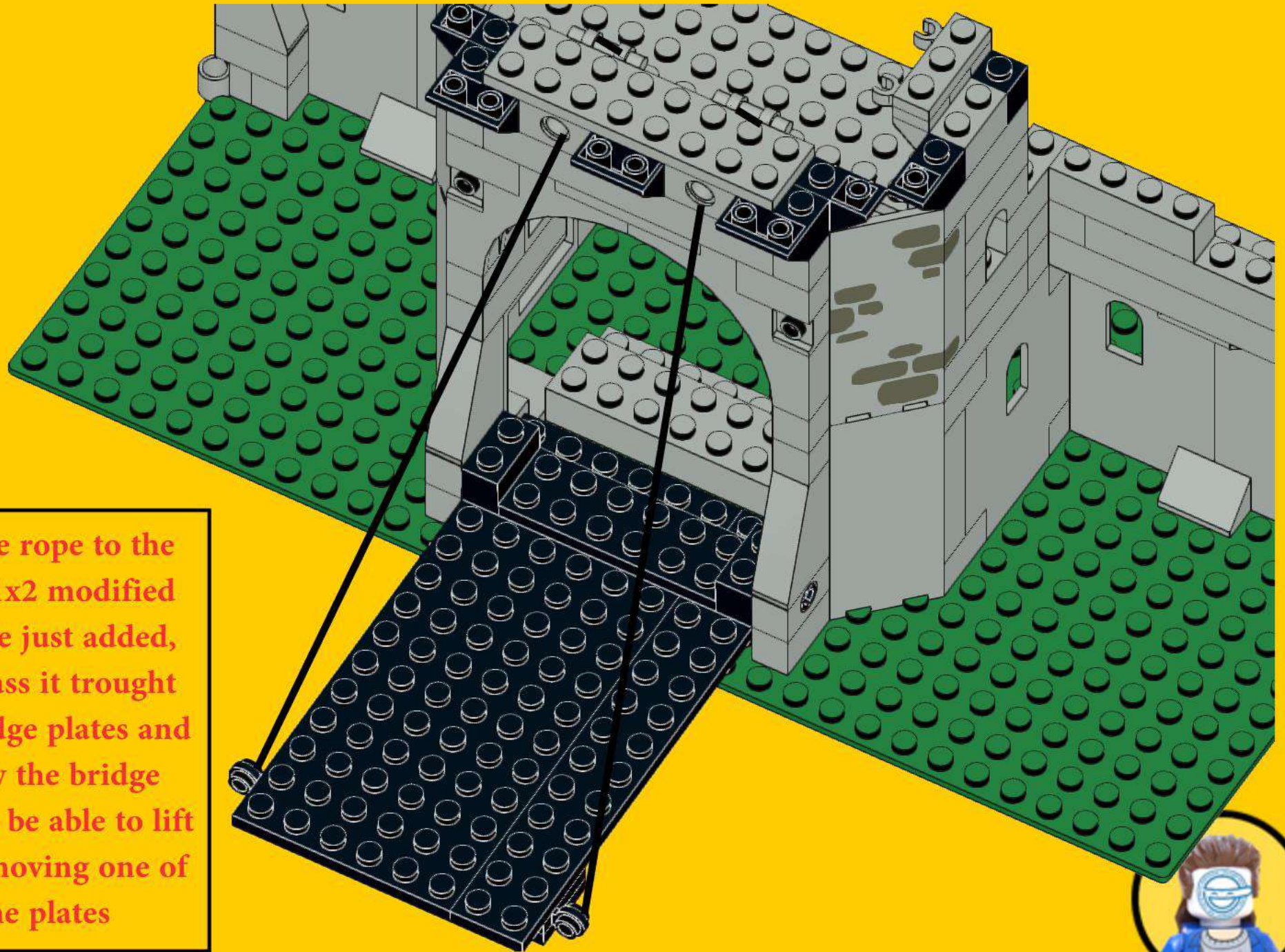

Tie the rope to the plate 1x2 modified that we just added, and pass it through the bridge plates and below the bridge itself to be able to lift it by moving one of the plates



72

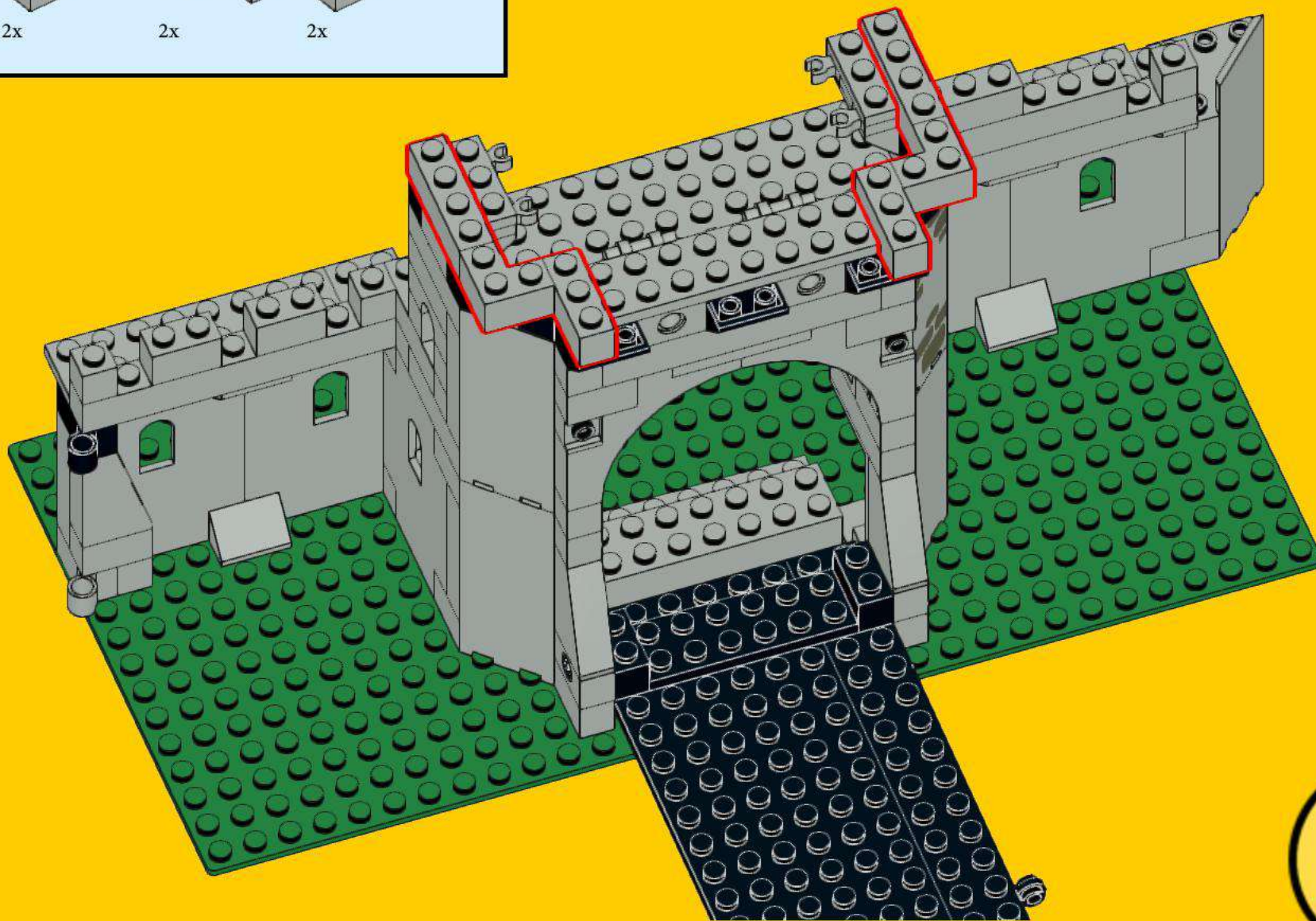
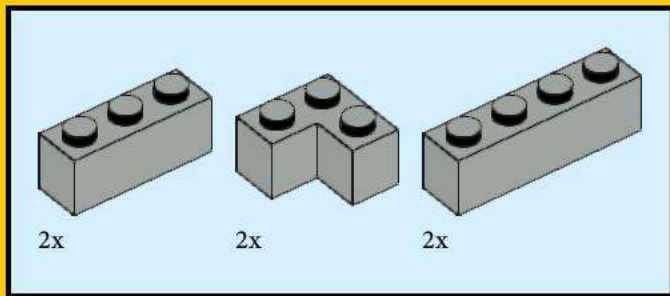

73

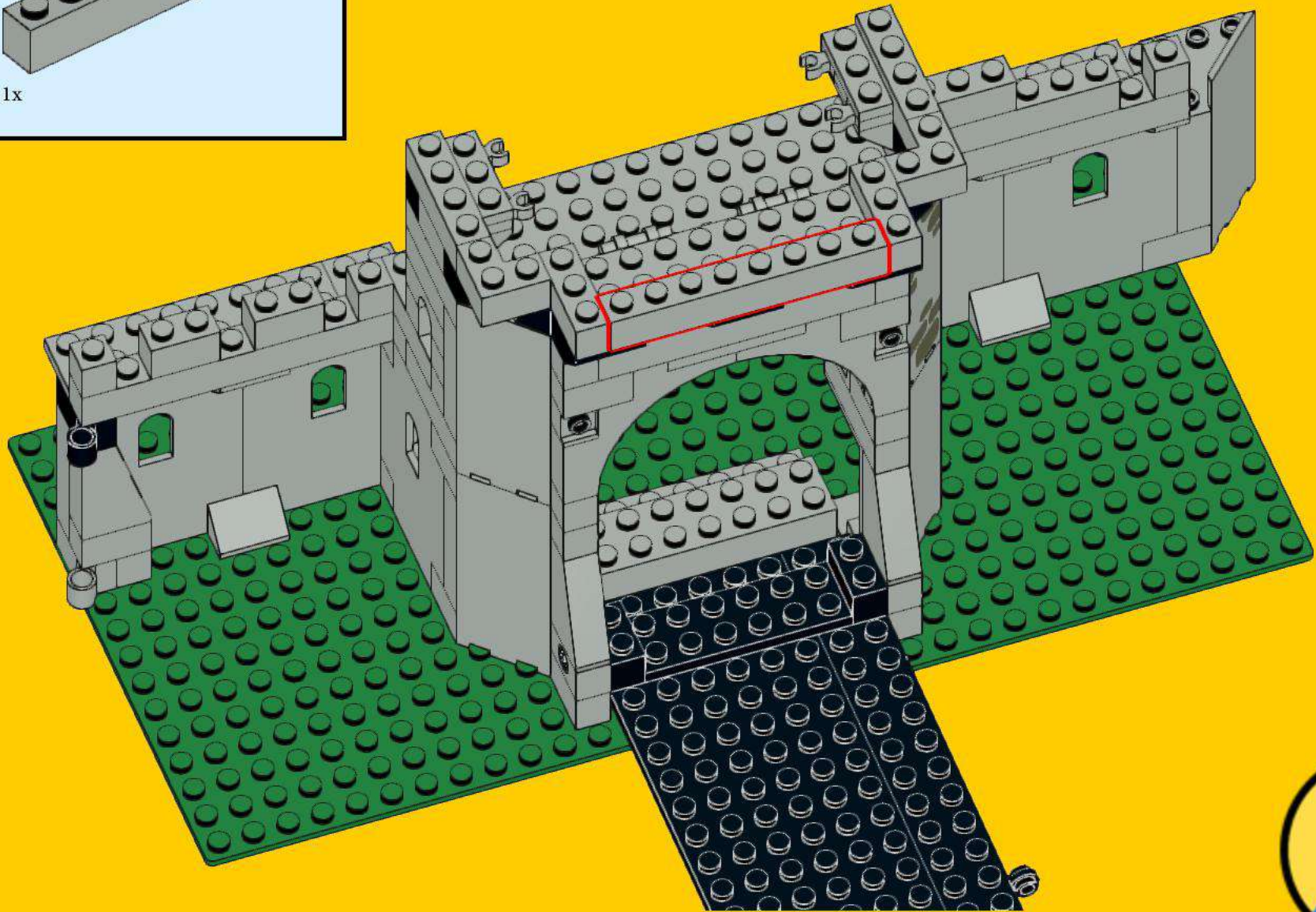
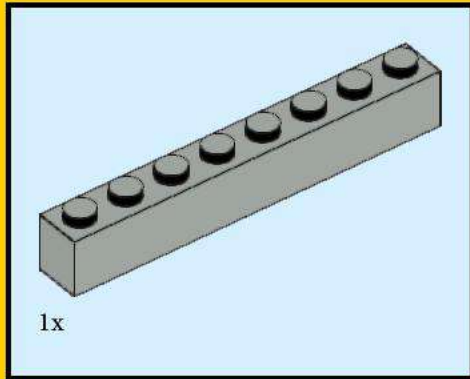

74

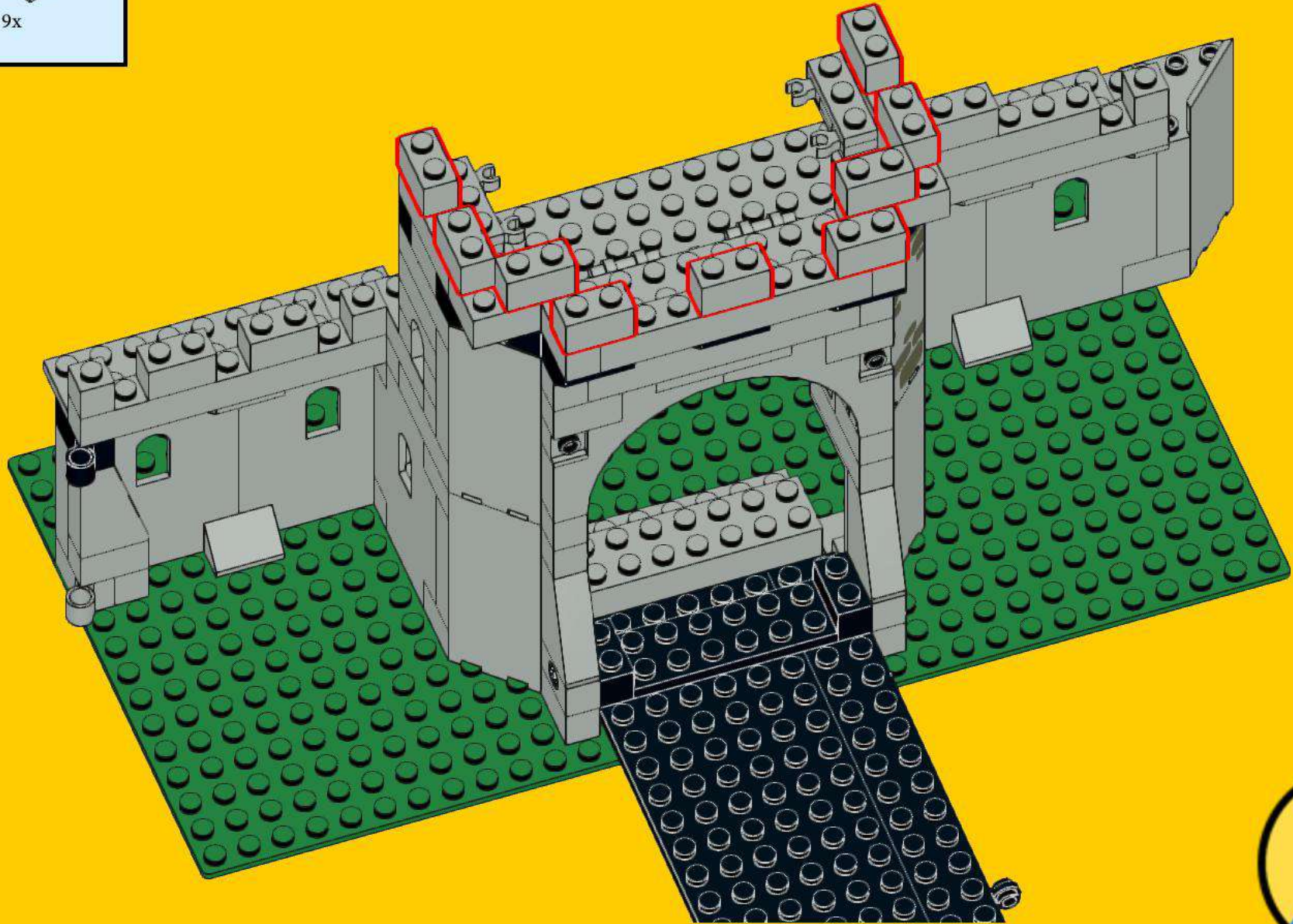
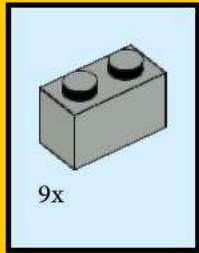

75

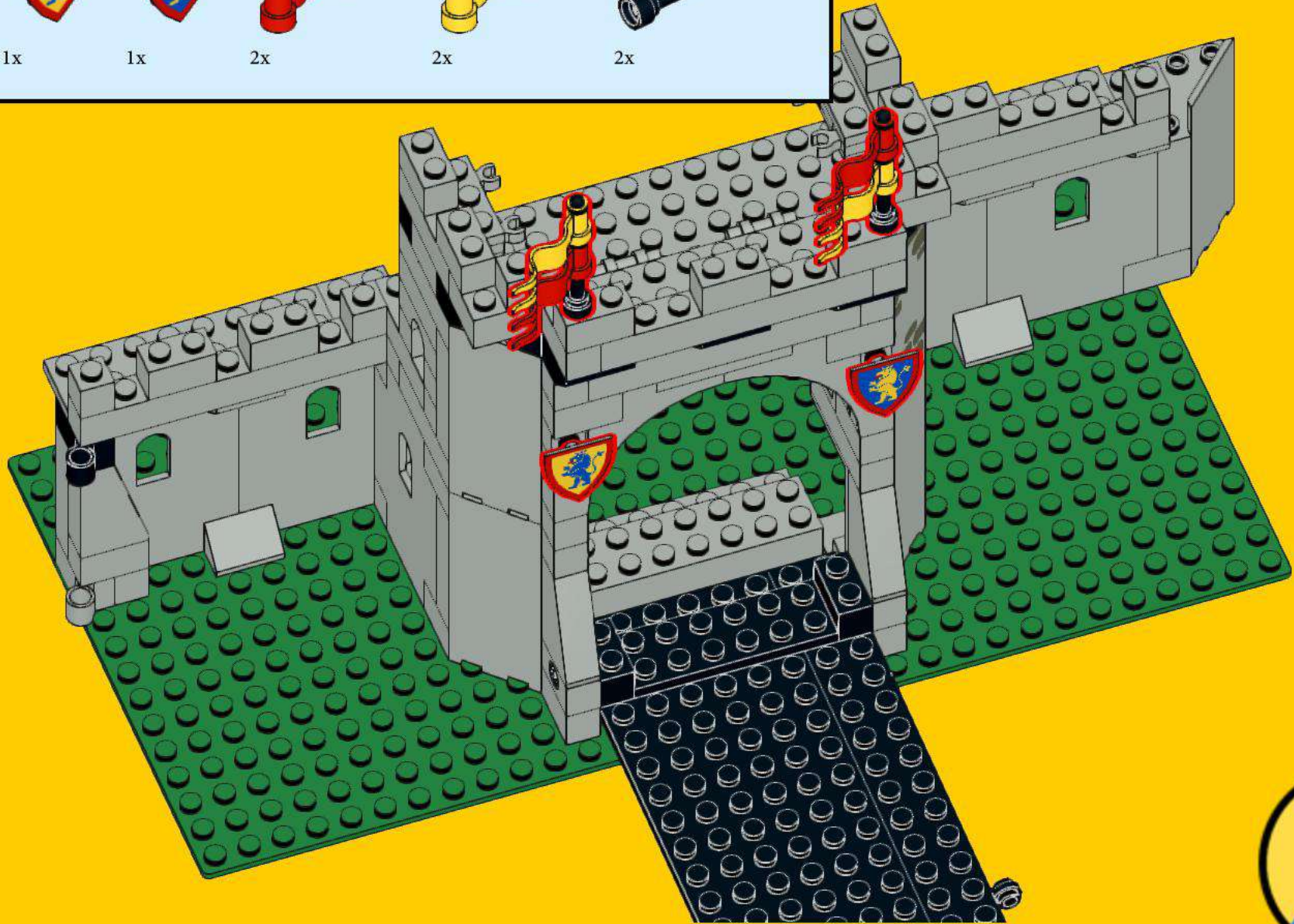
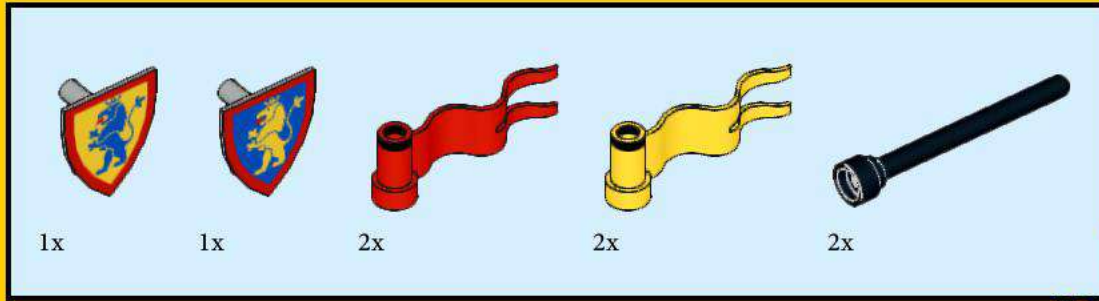

76

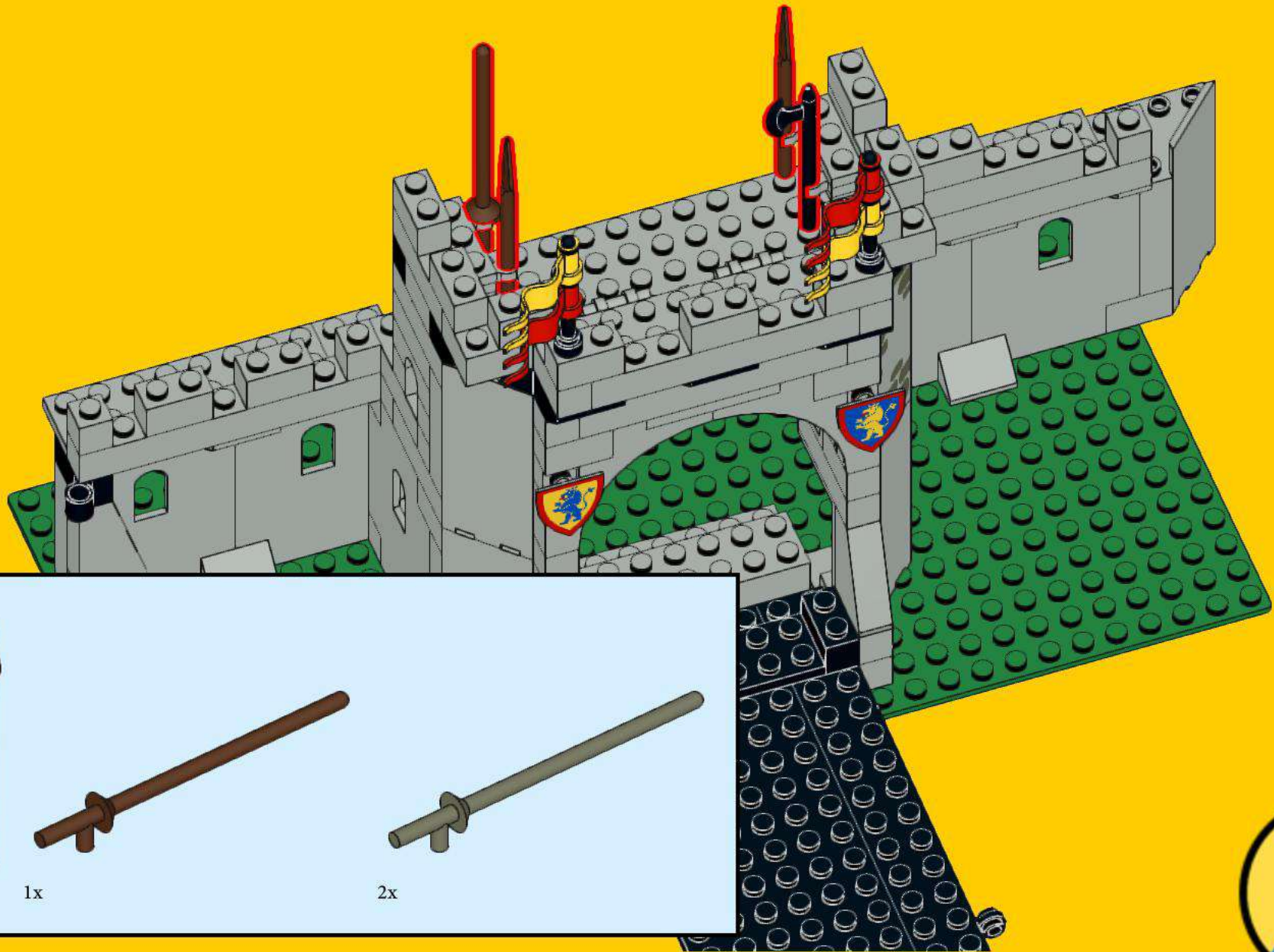

1x



2x



1x

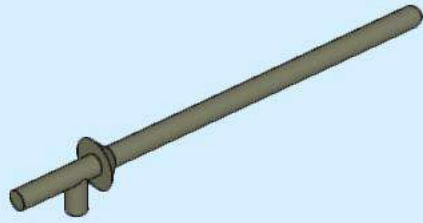

2x



77

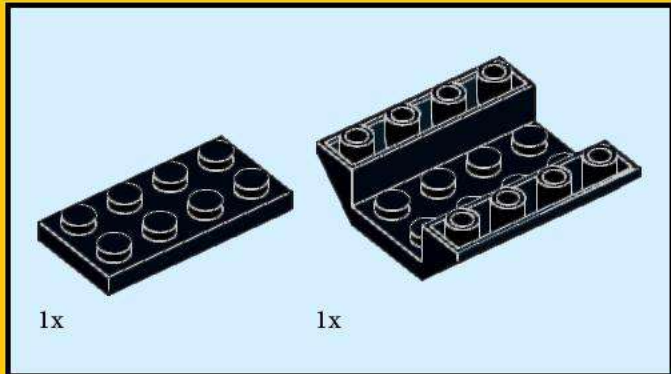
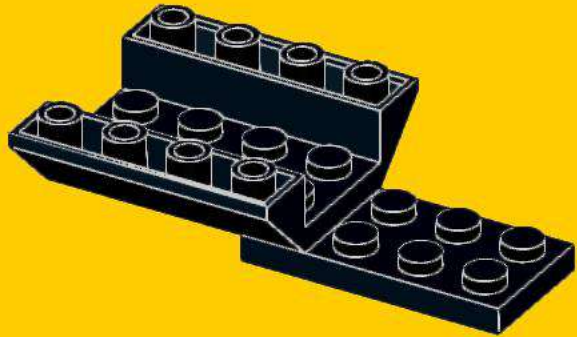
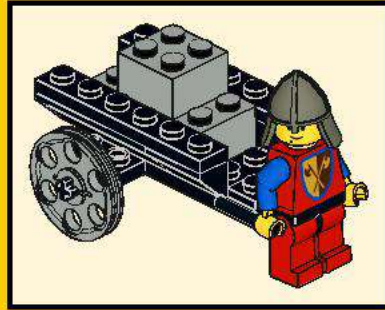

78

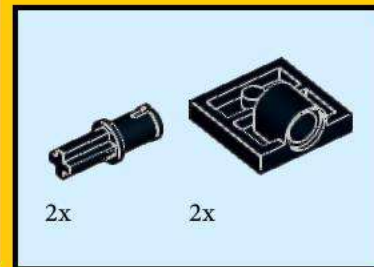
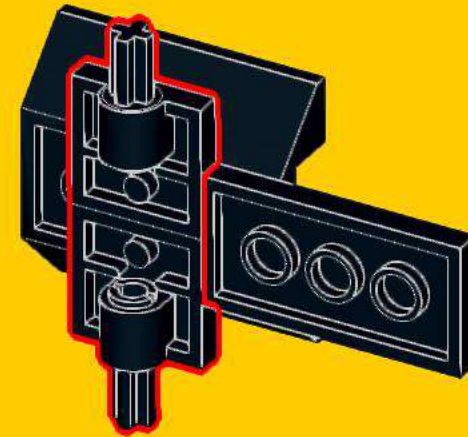

79

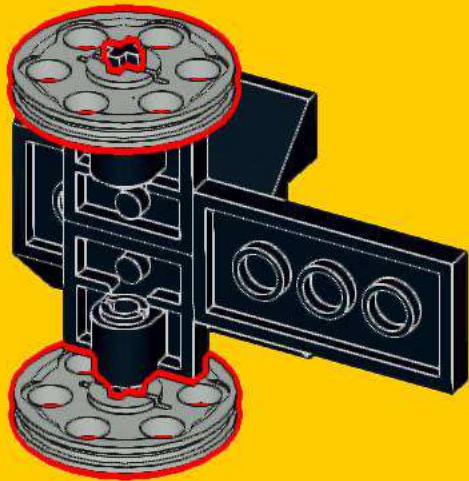
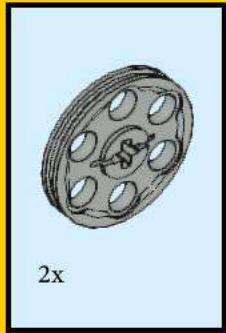

80

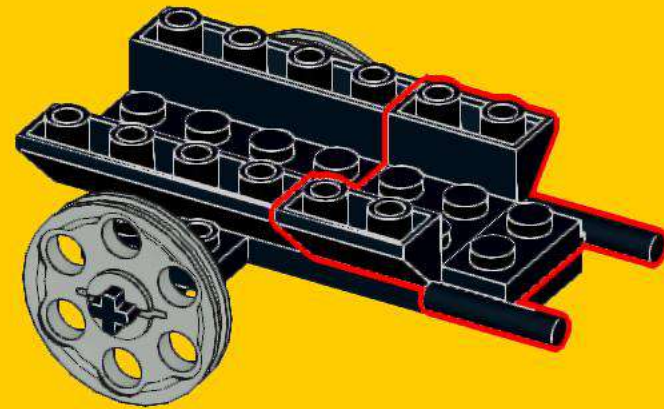
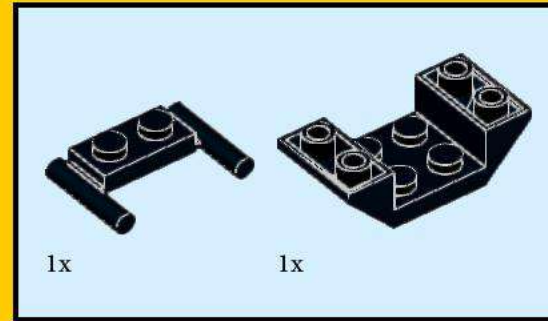

81

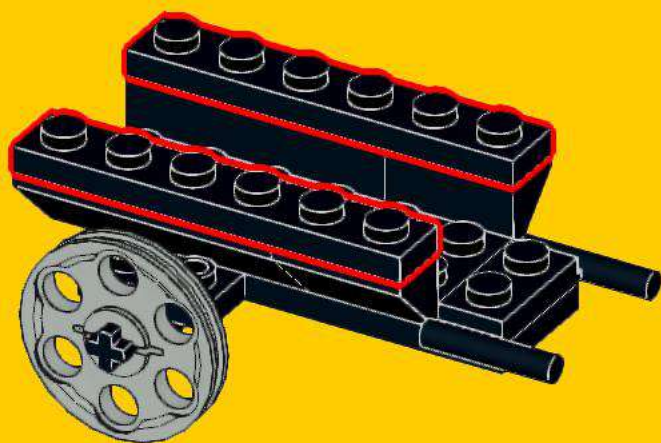
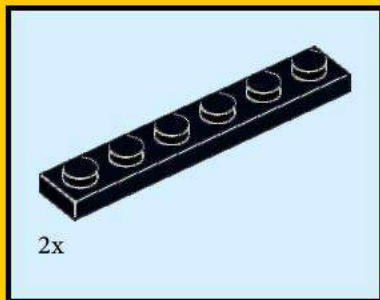

82

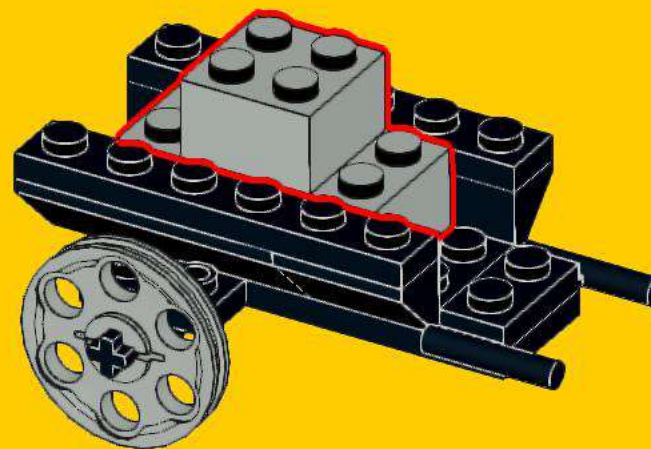
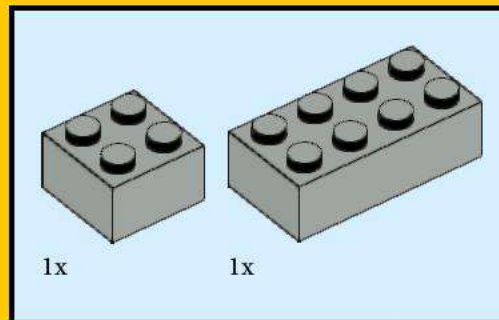

83

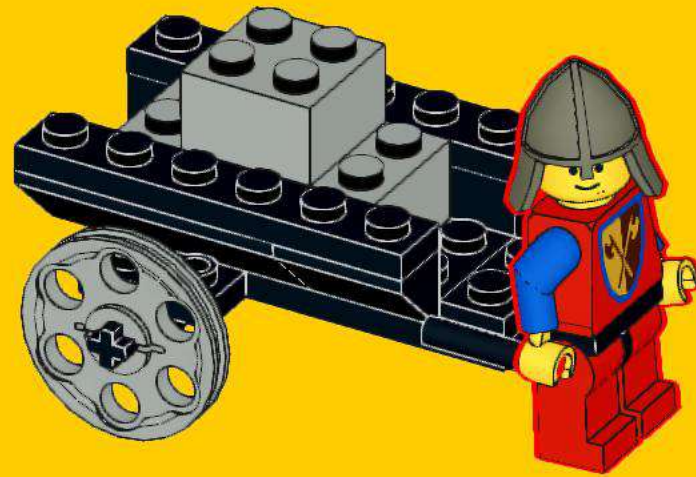

84

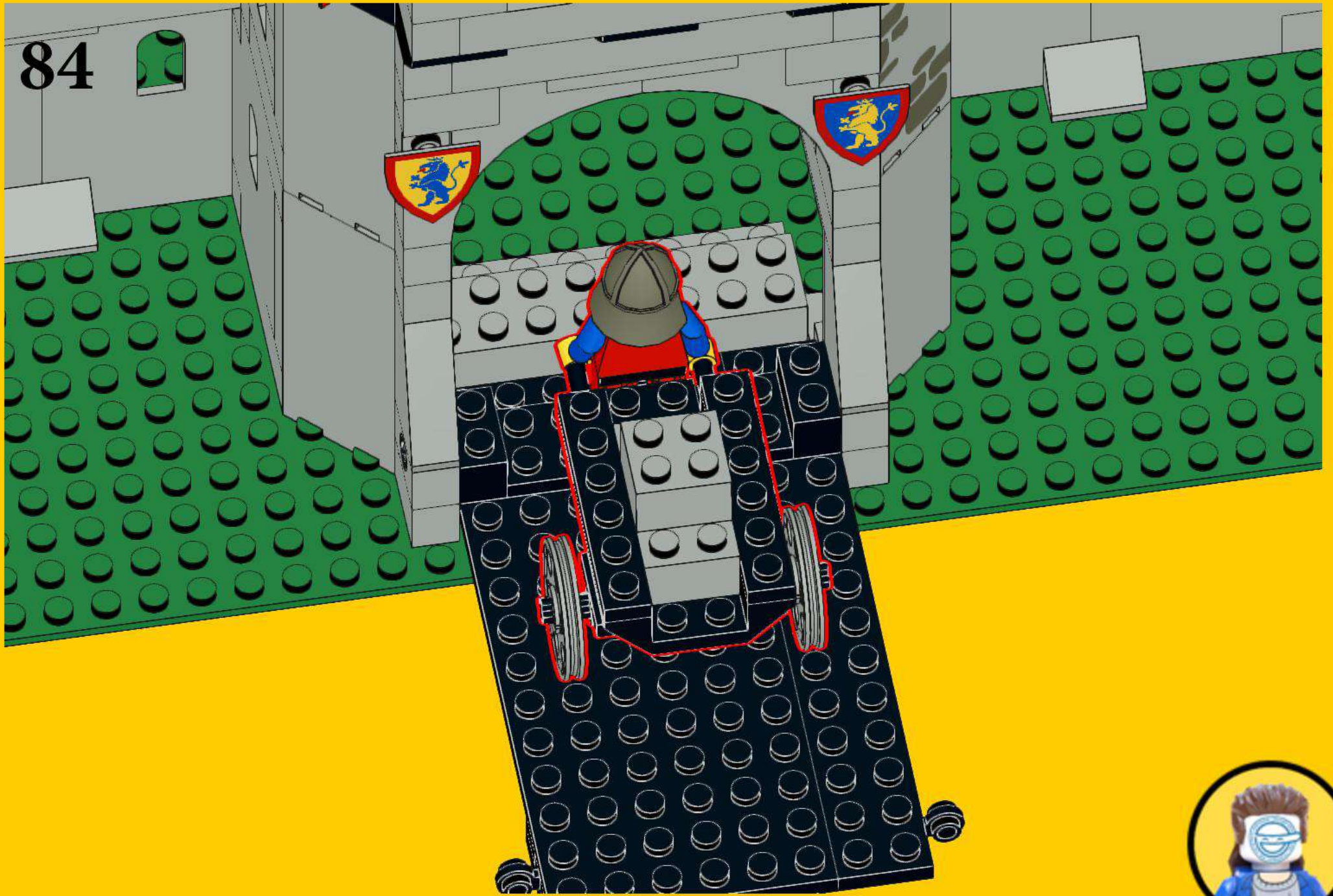

85

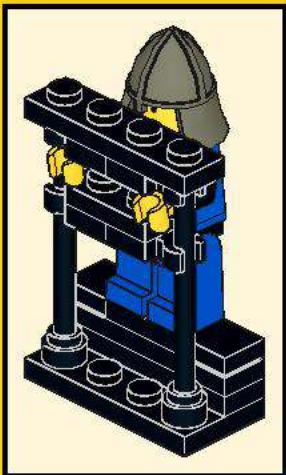
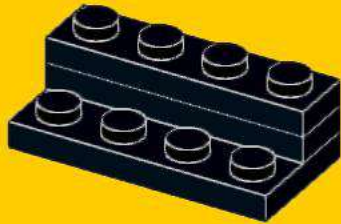
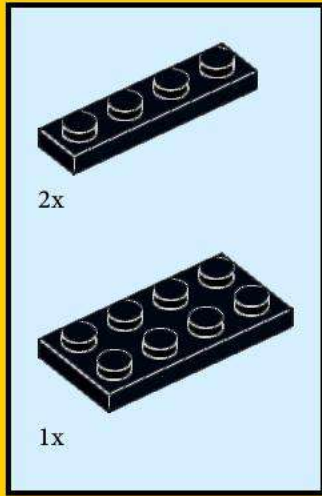

86

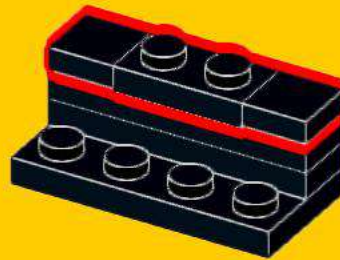
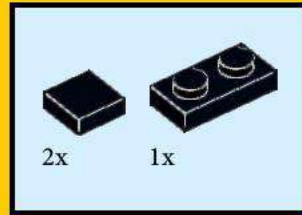

87

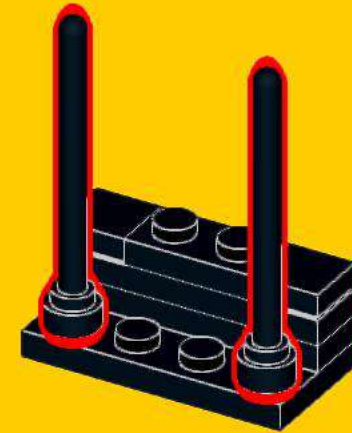

88

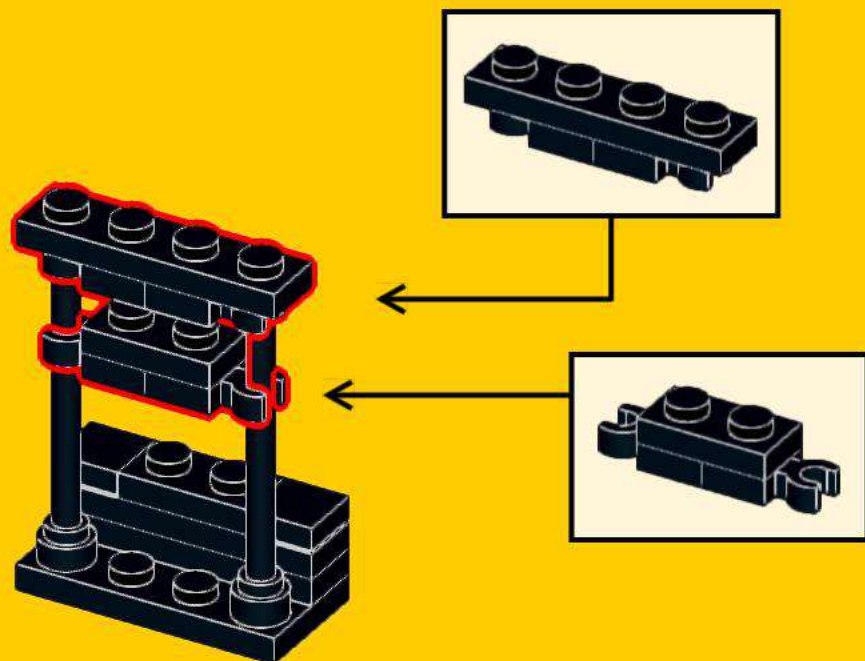
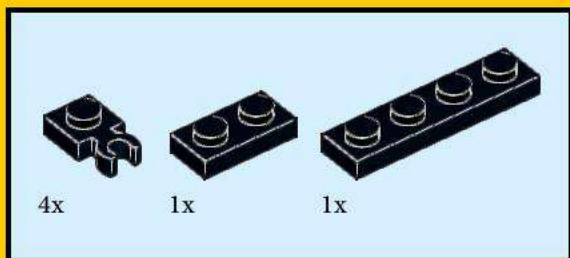

89

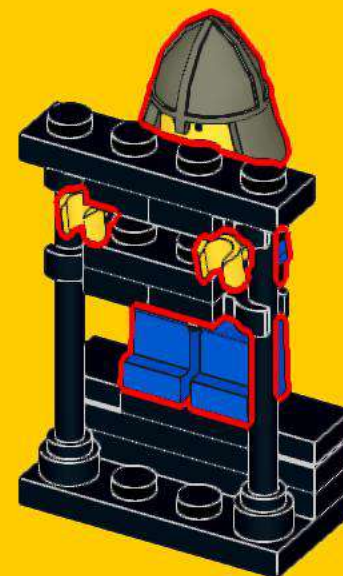

90

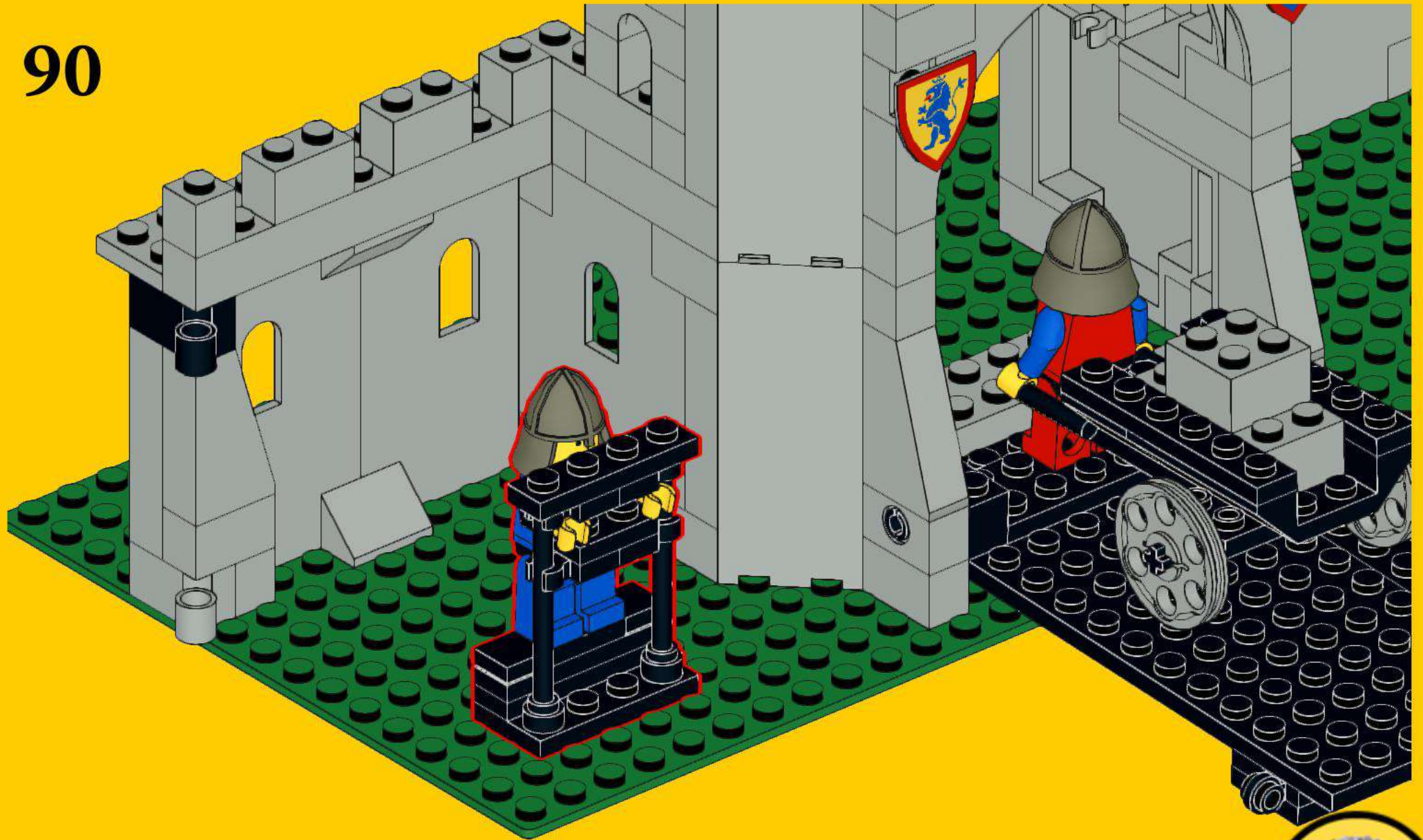

91



92

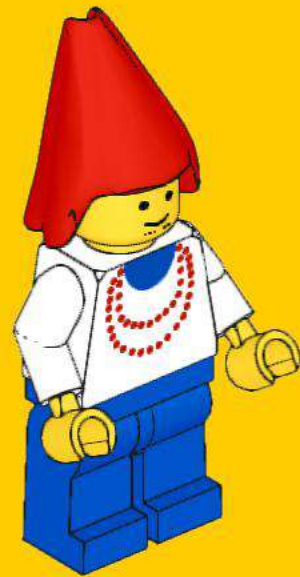

93

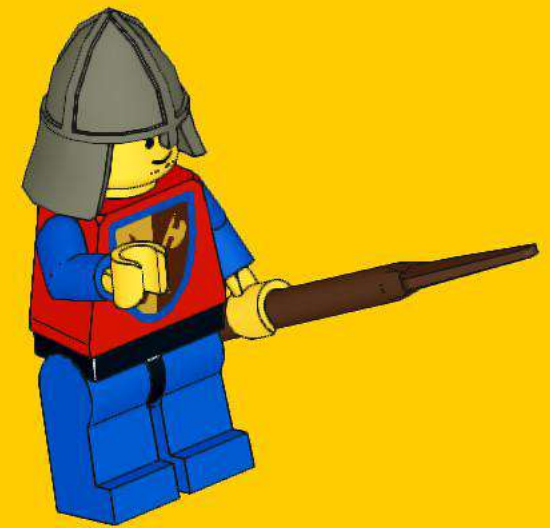

94

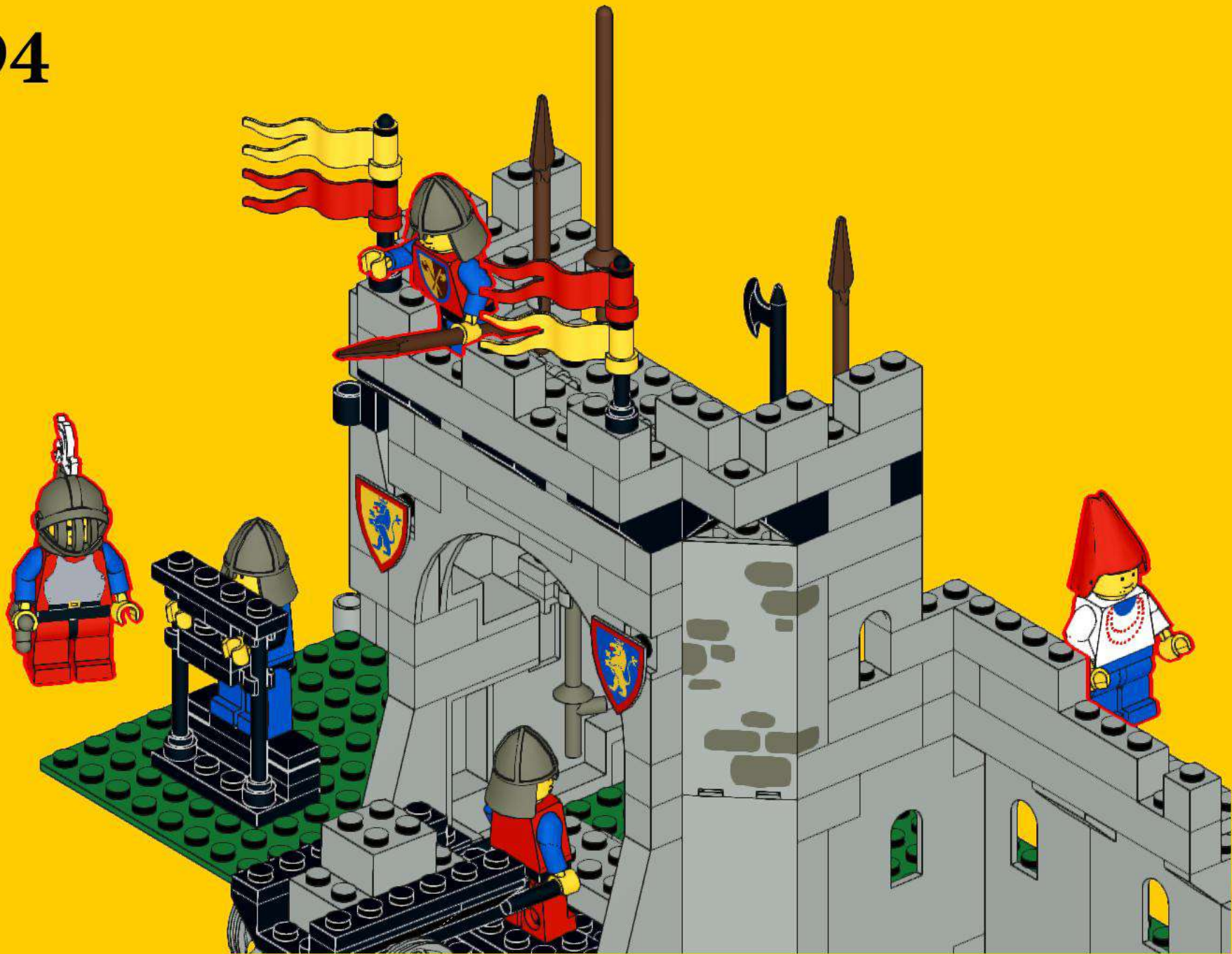

95

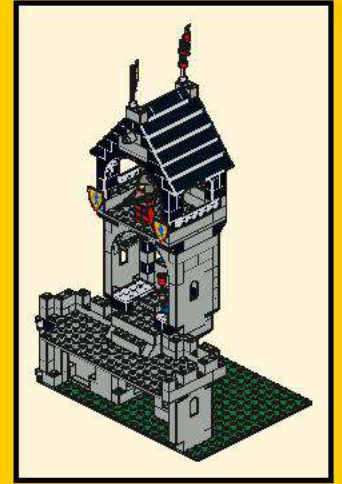
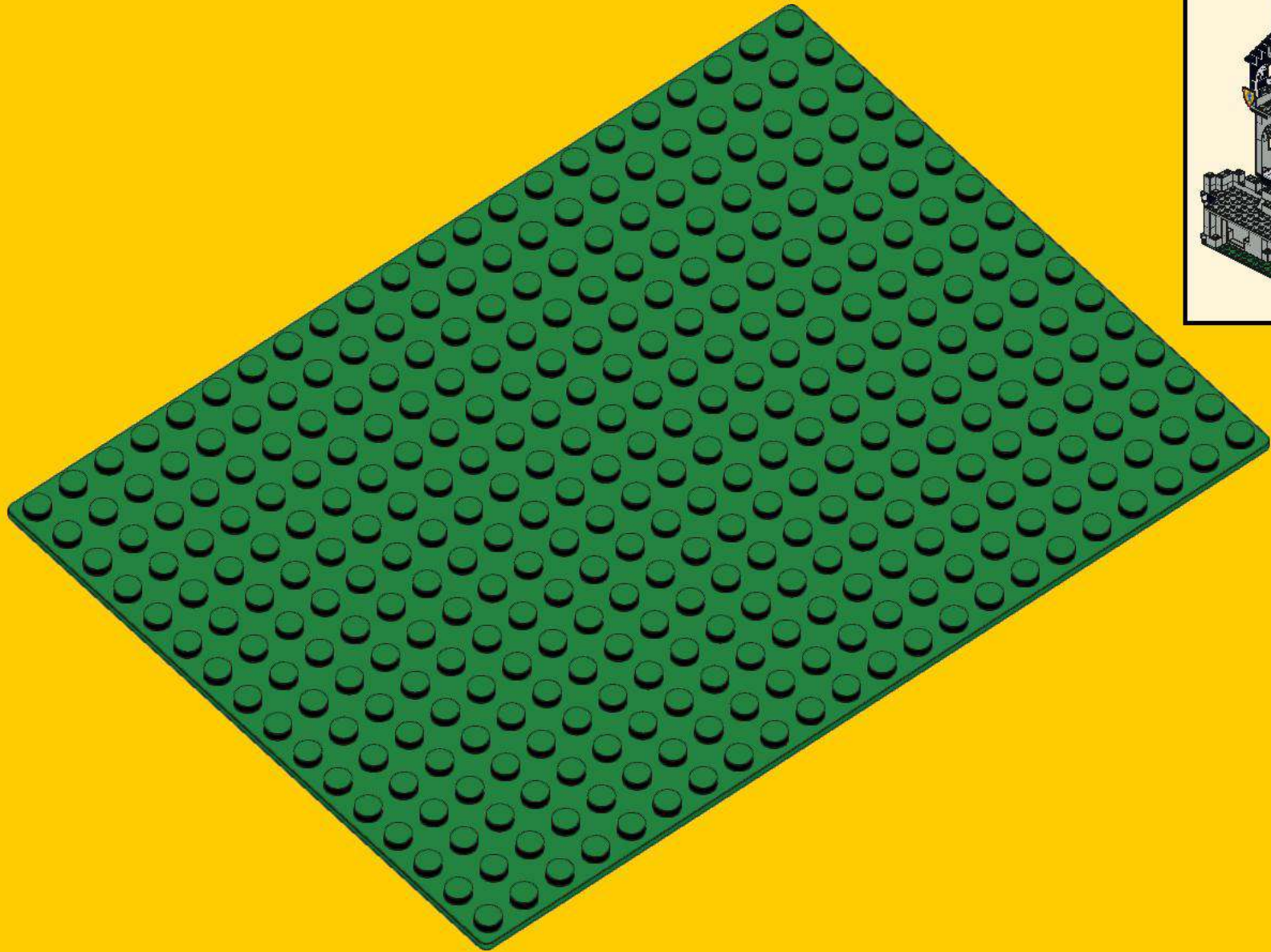

96

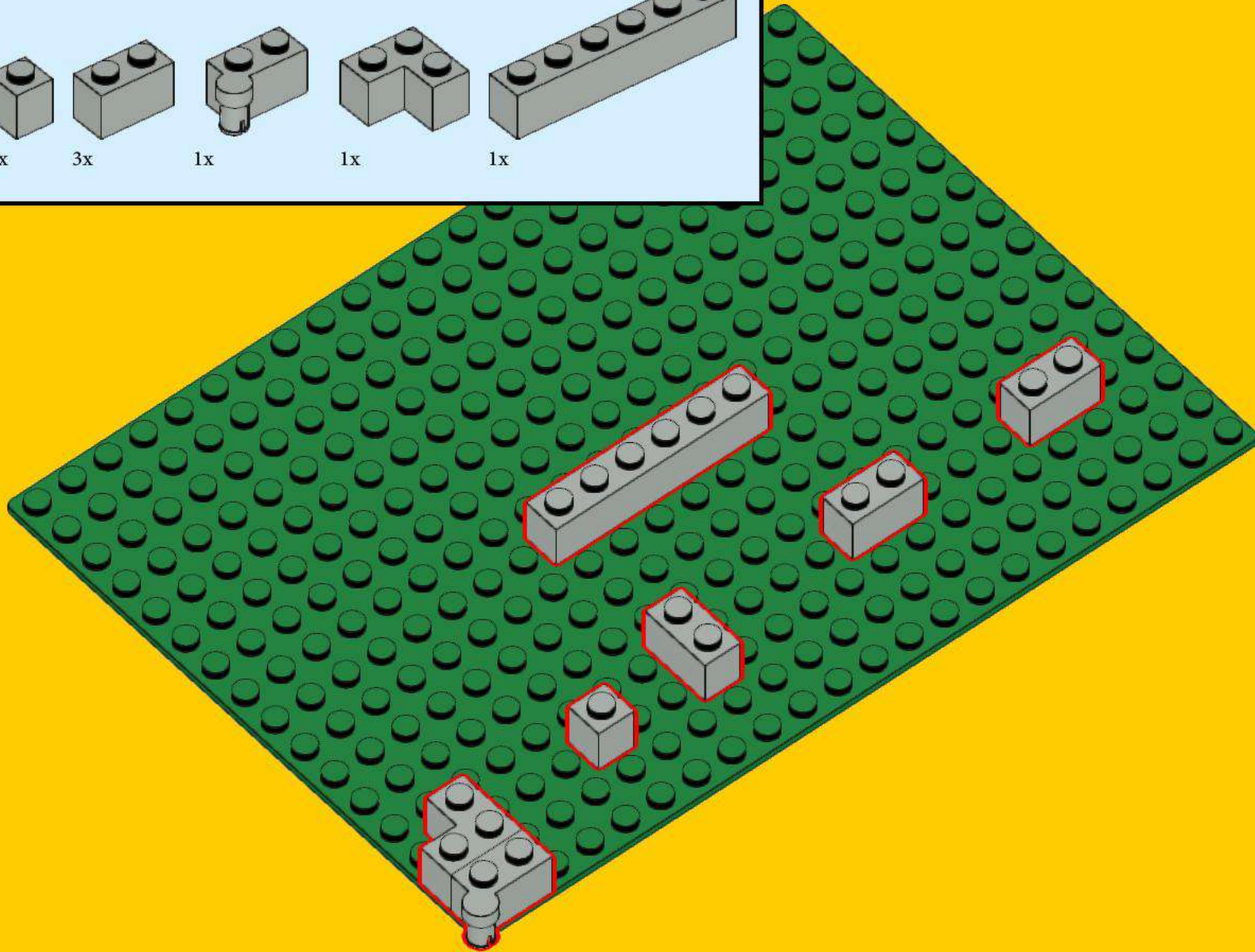
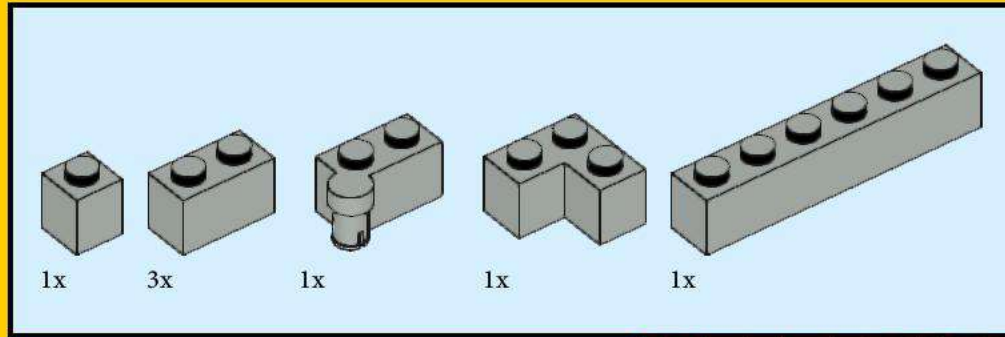

97

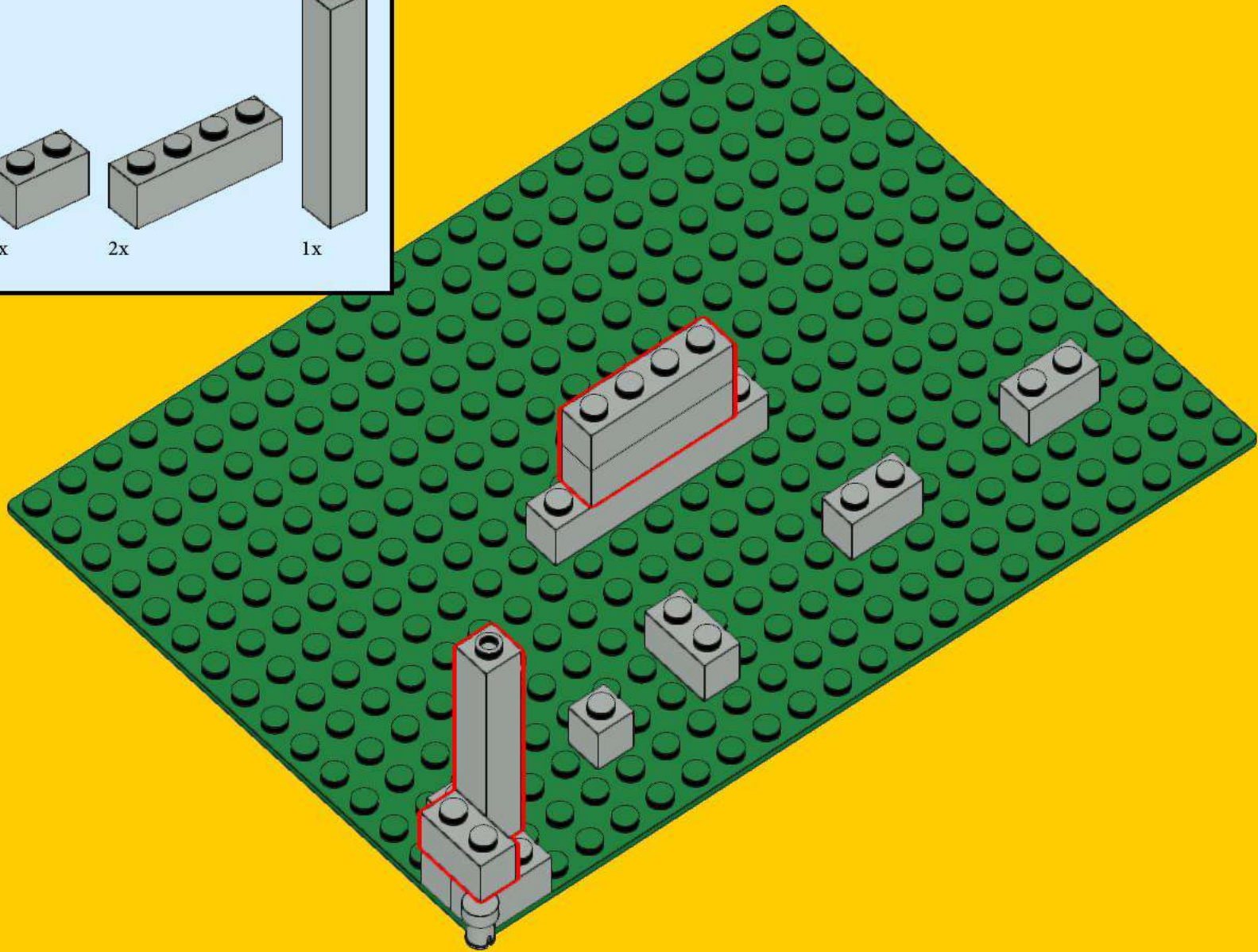
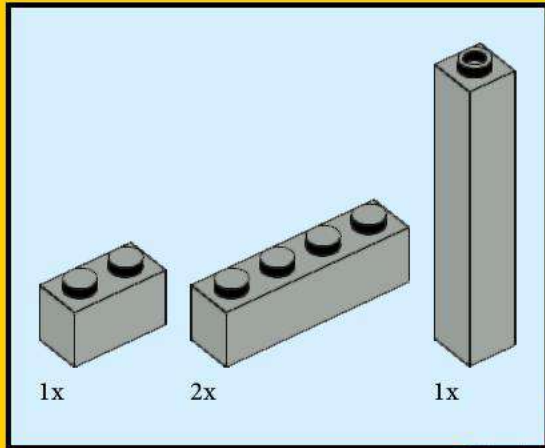

98

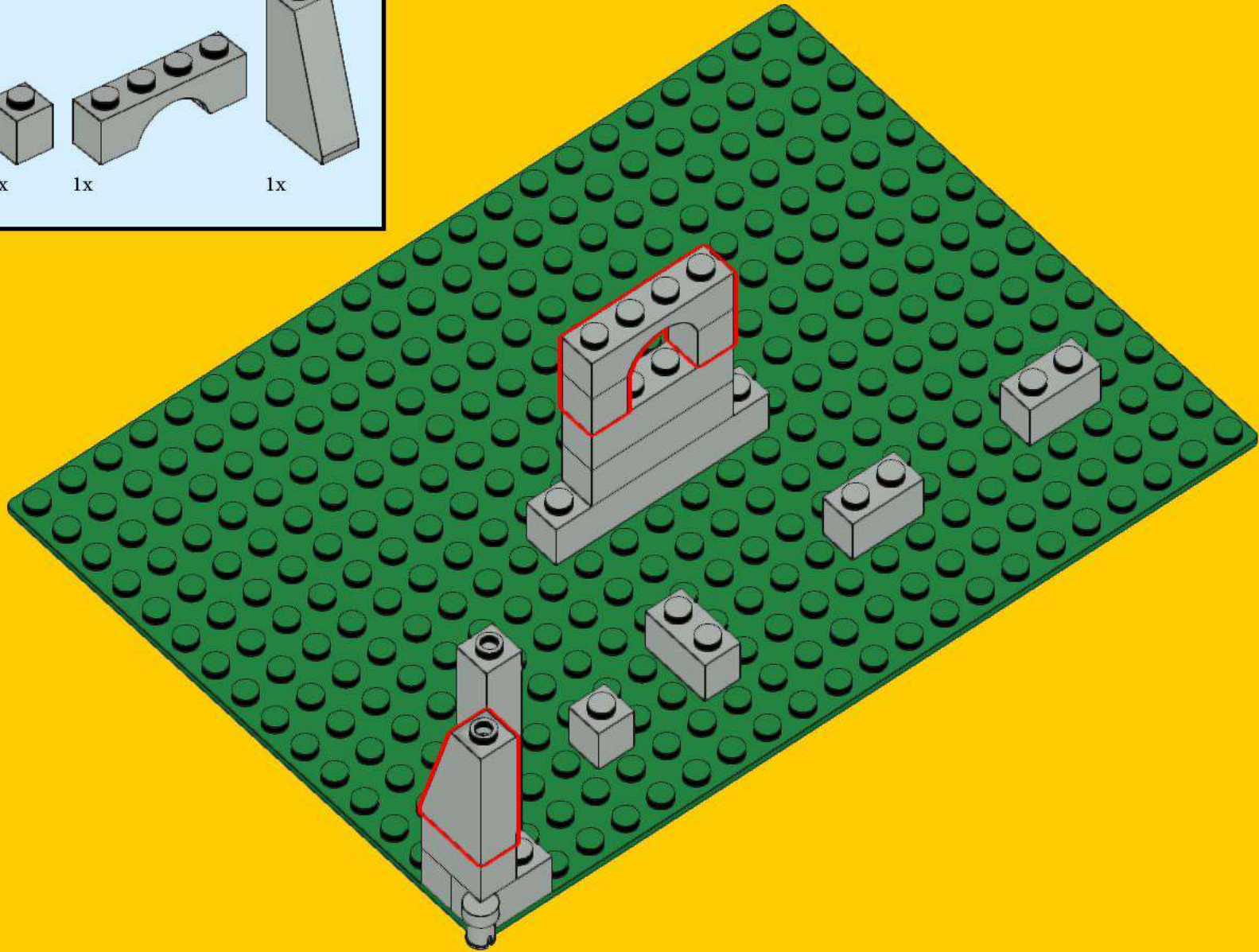
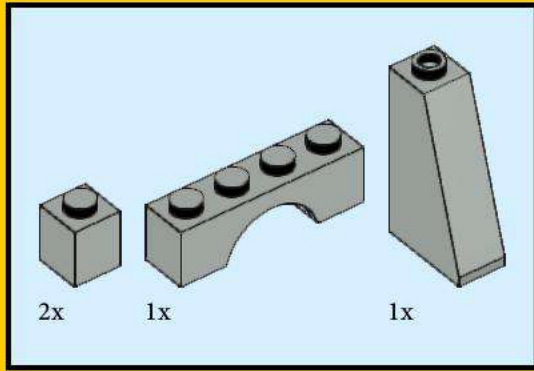

99

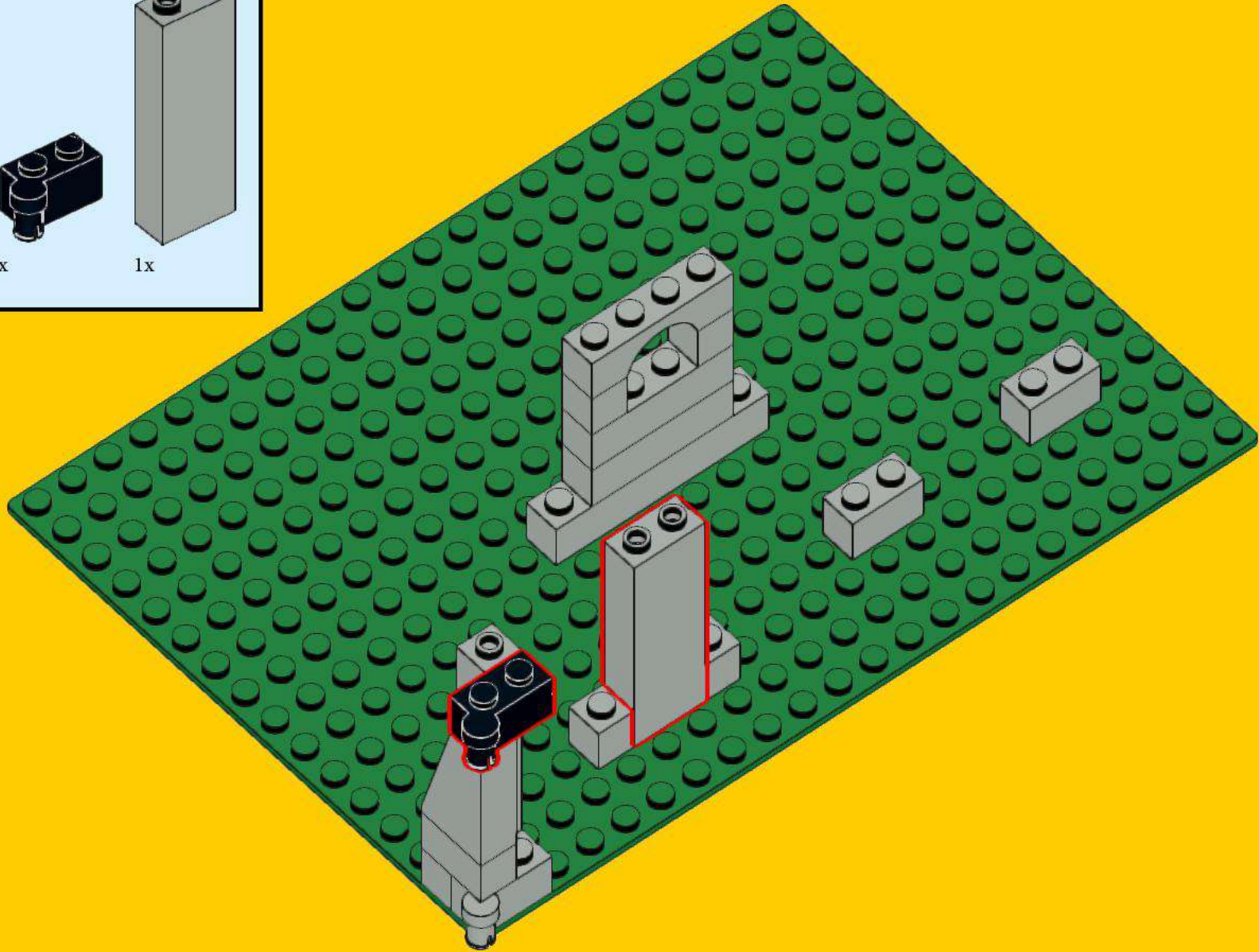
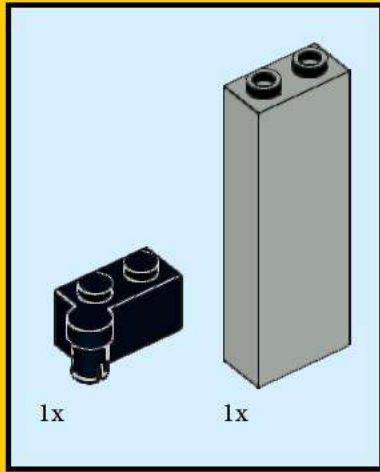

100

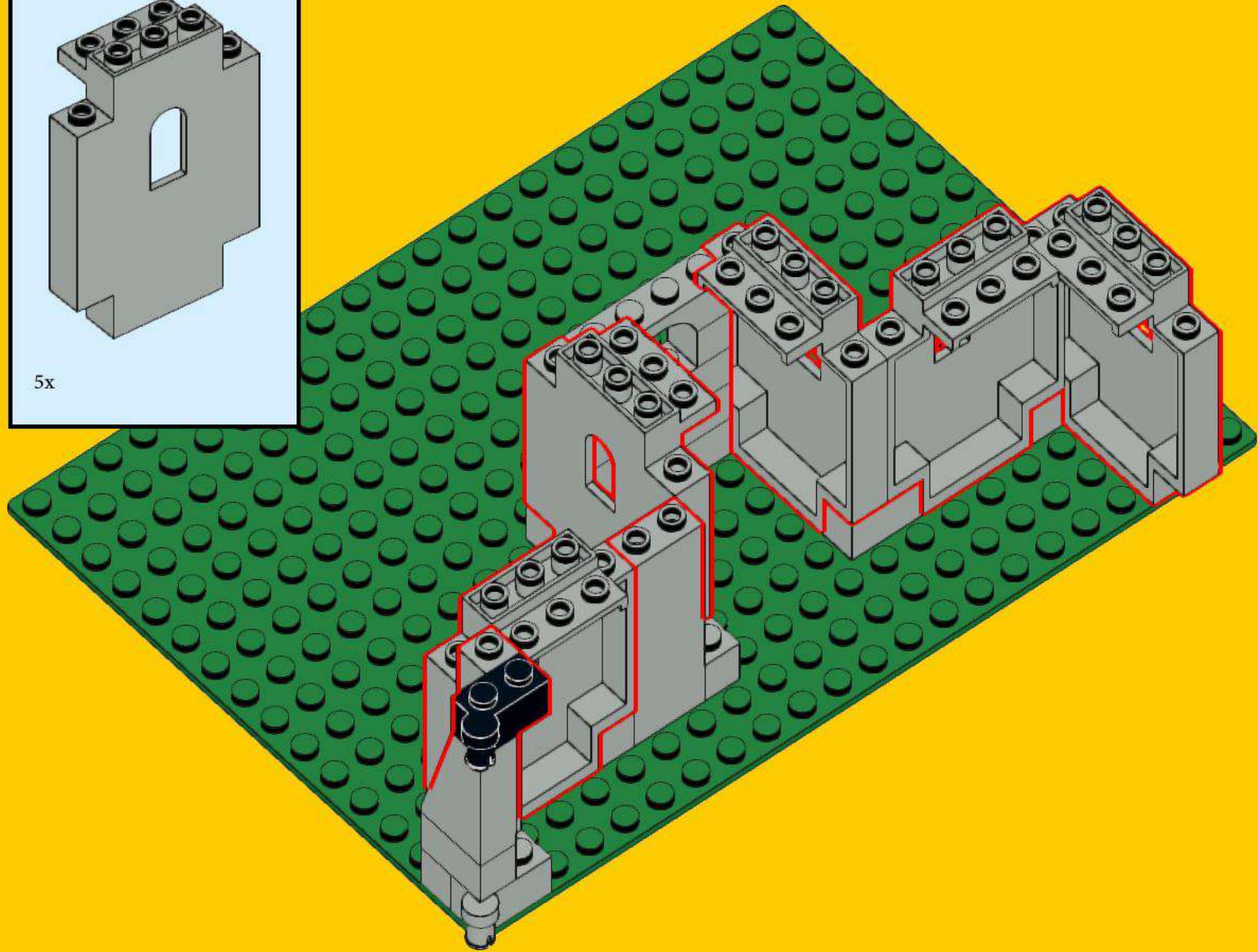
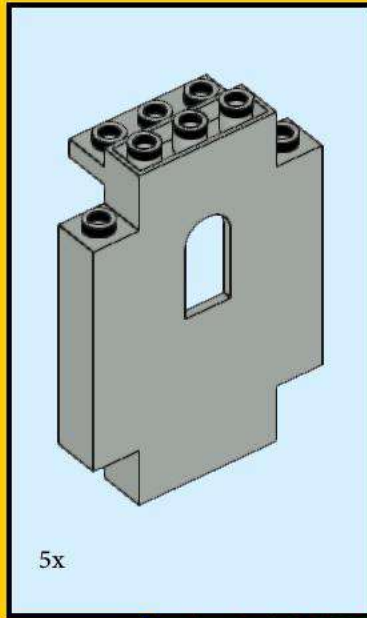

101

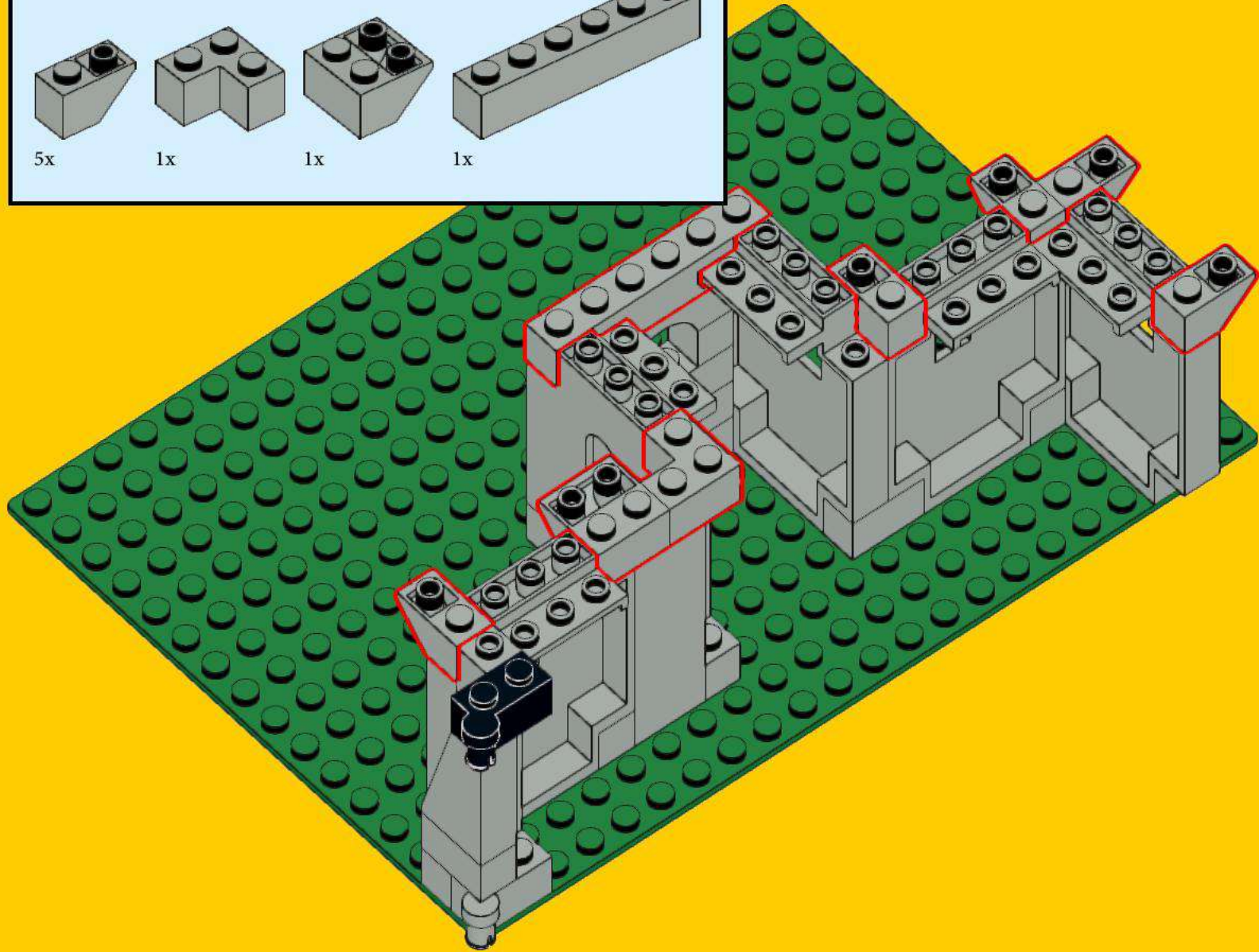
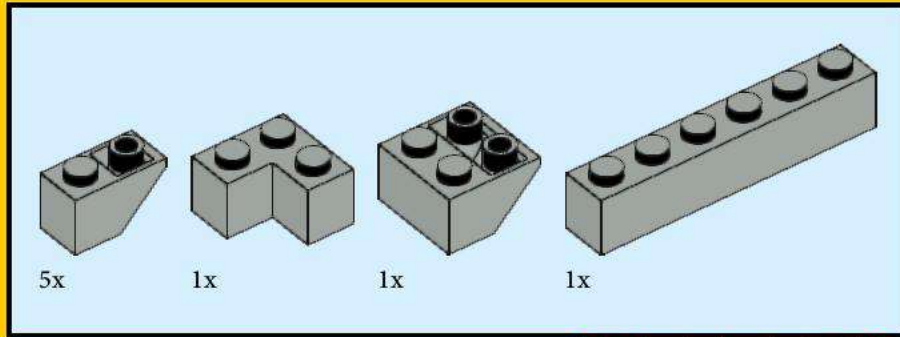

102

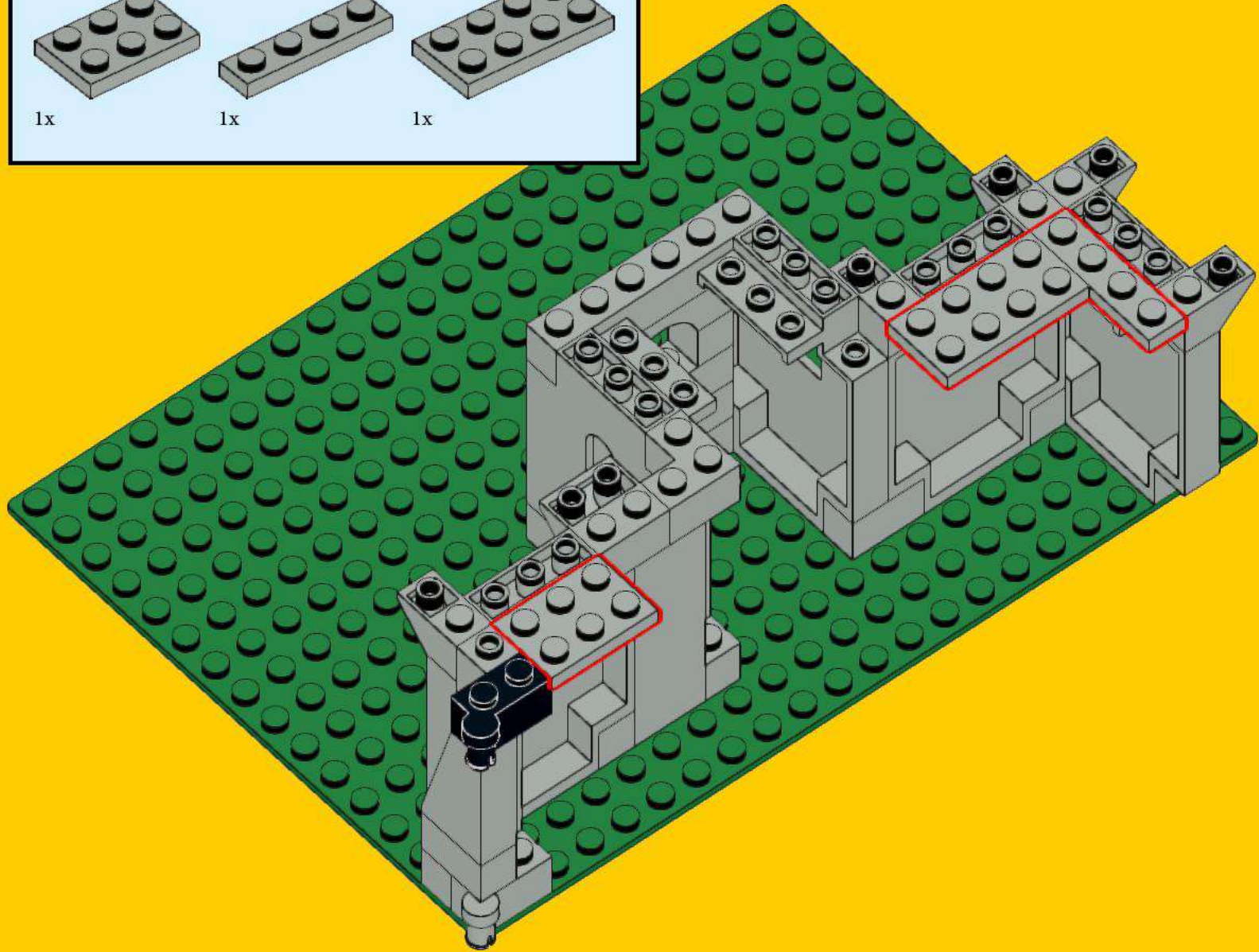
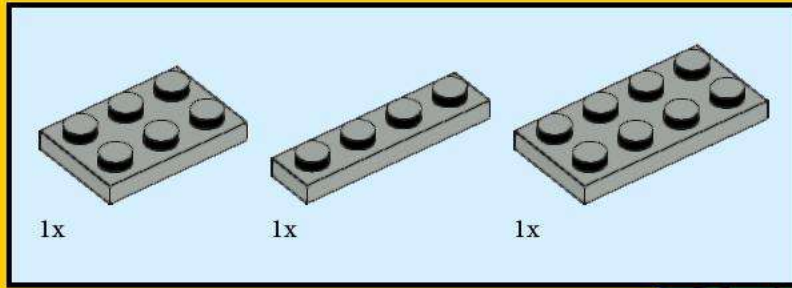

103

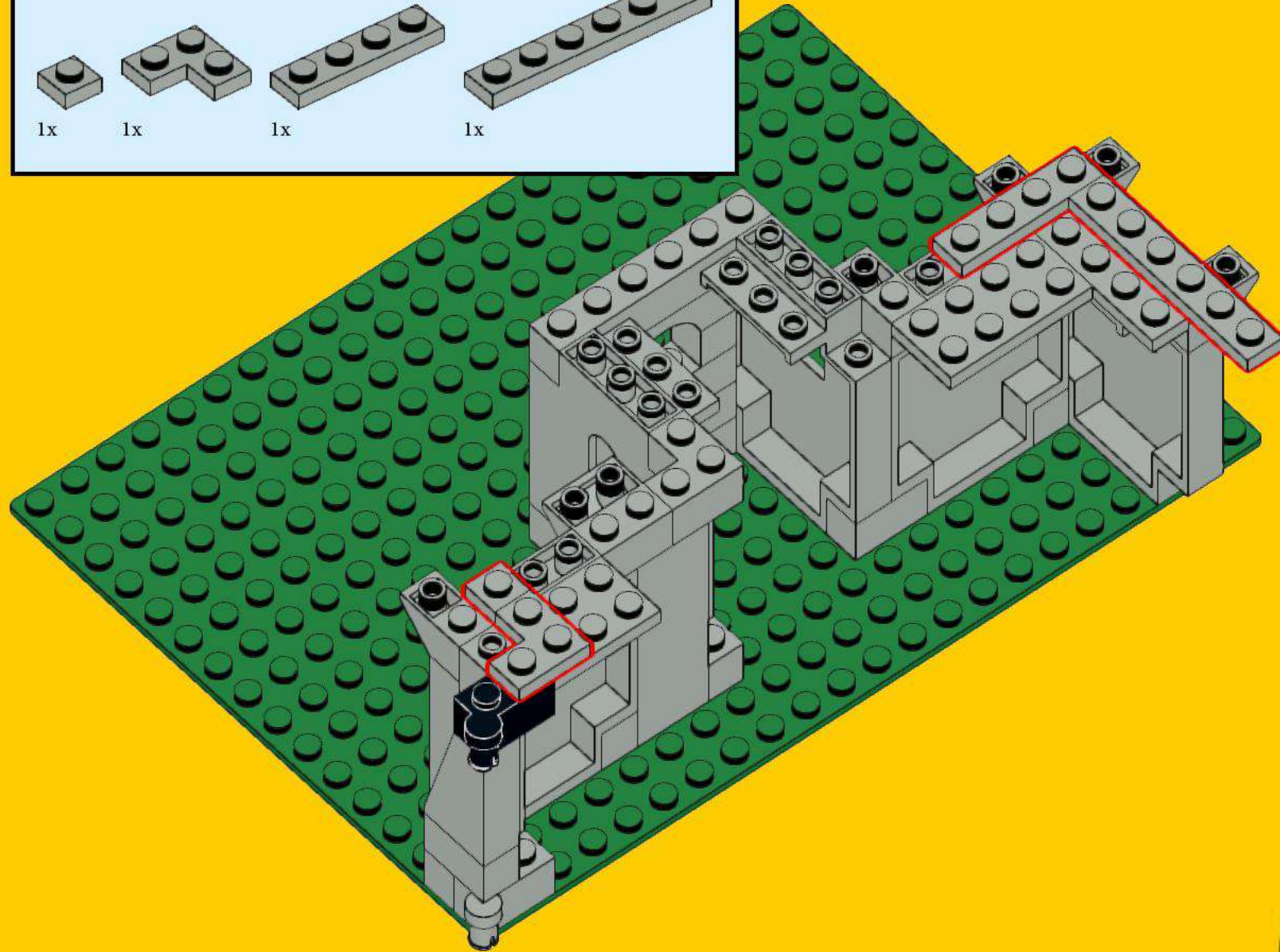
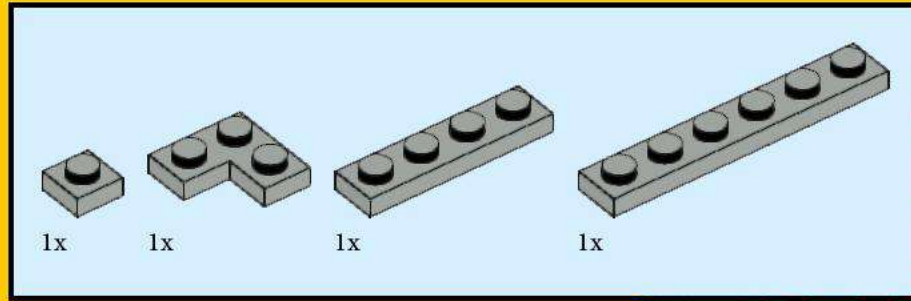

104

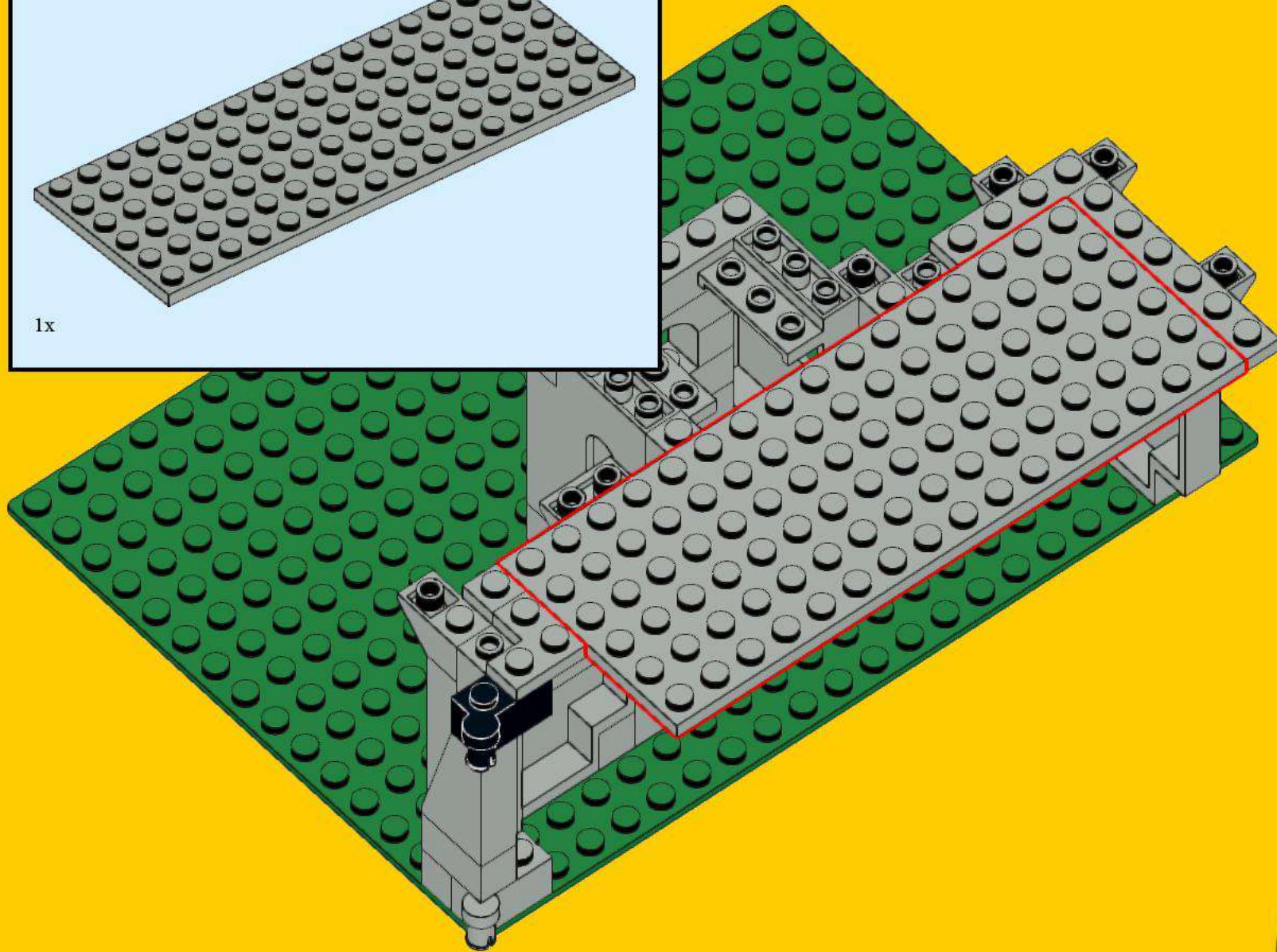
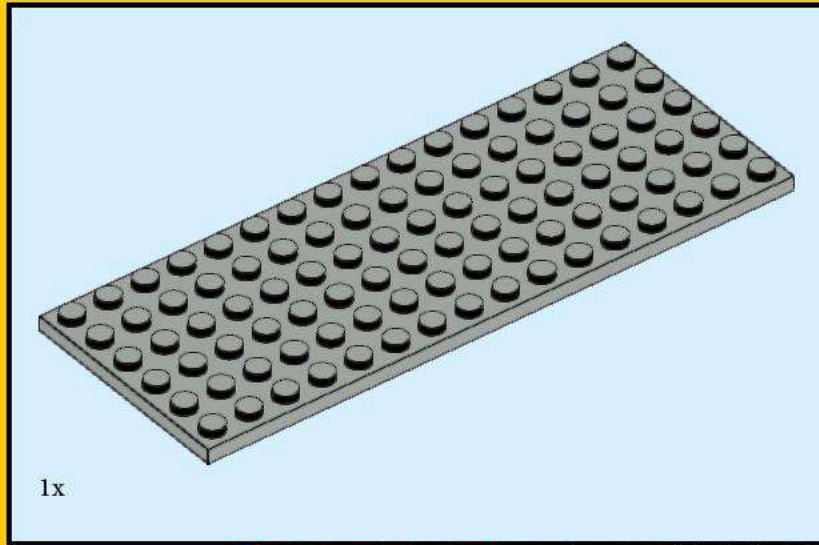

105

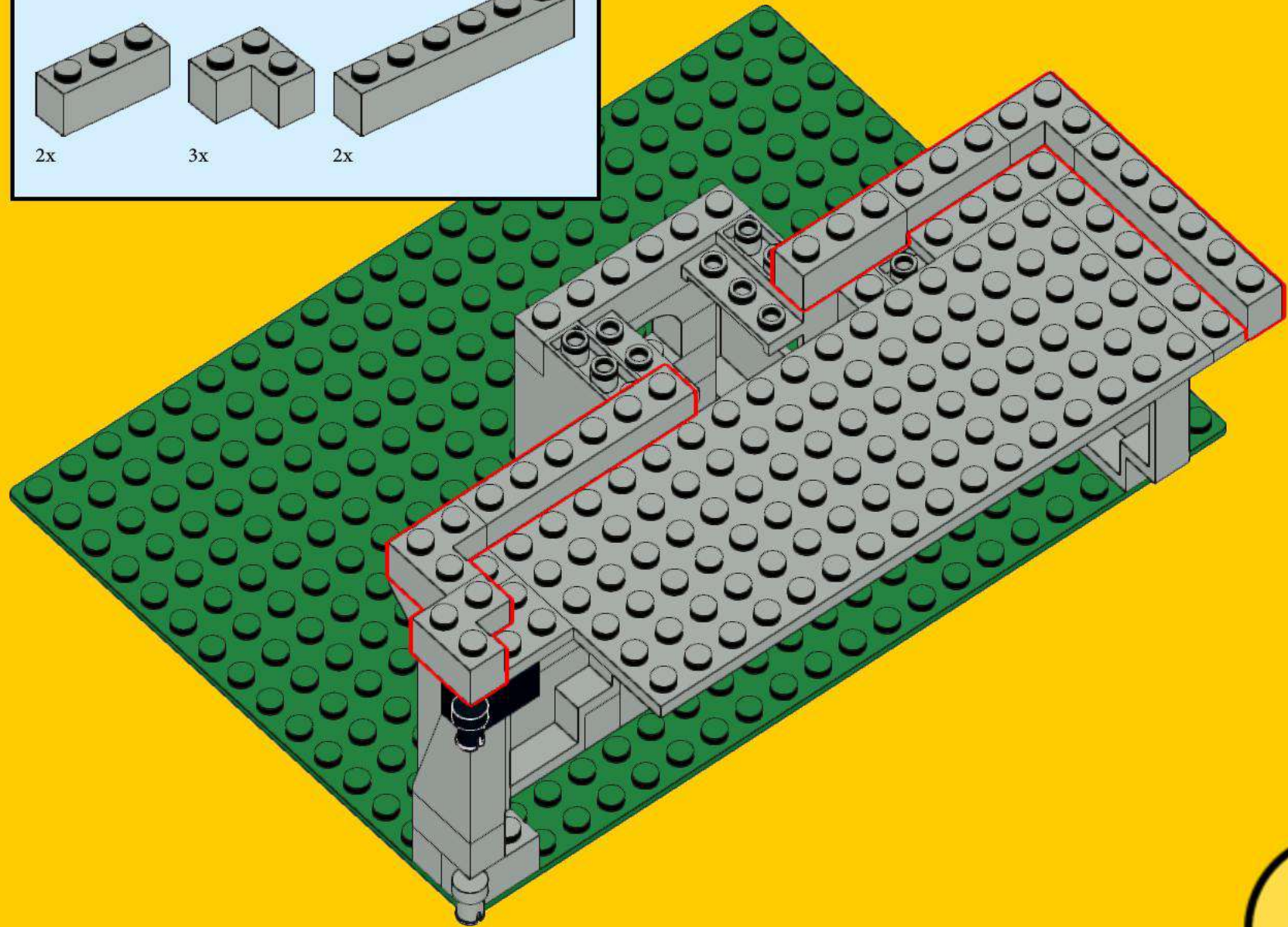
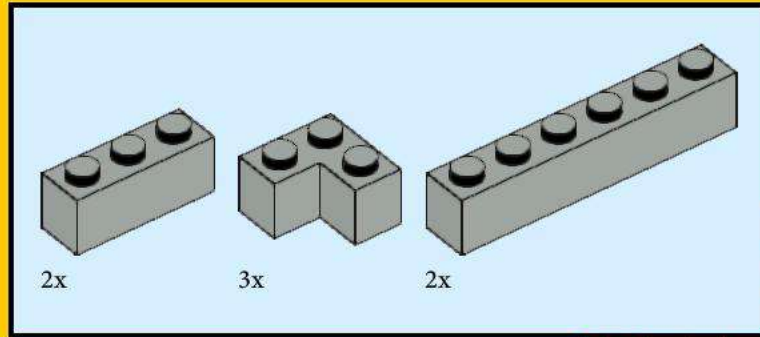

106

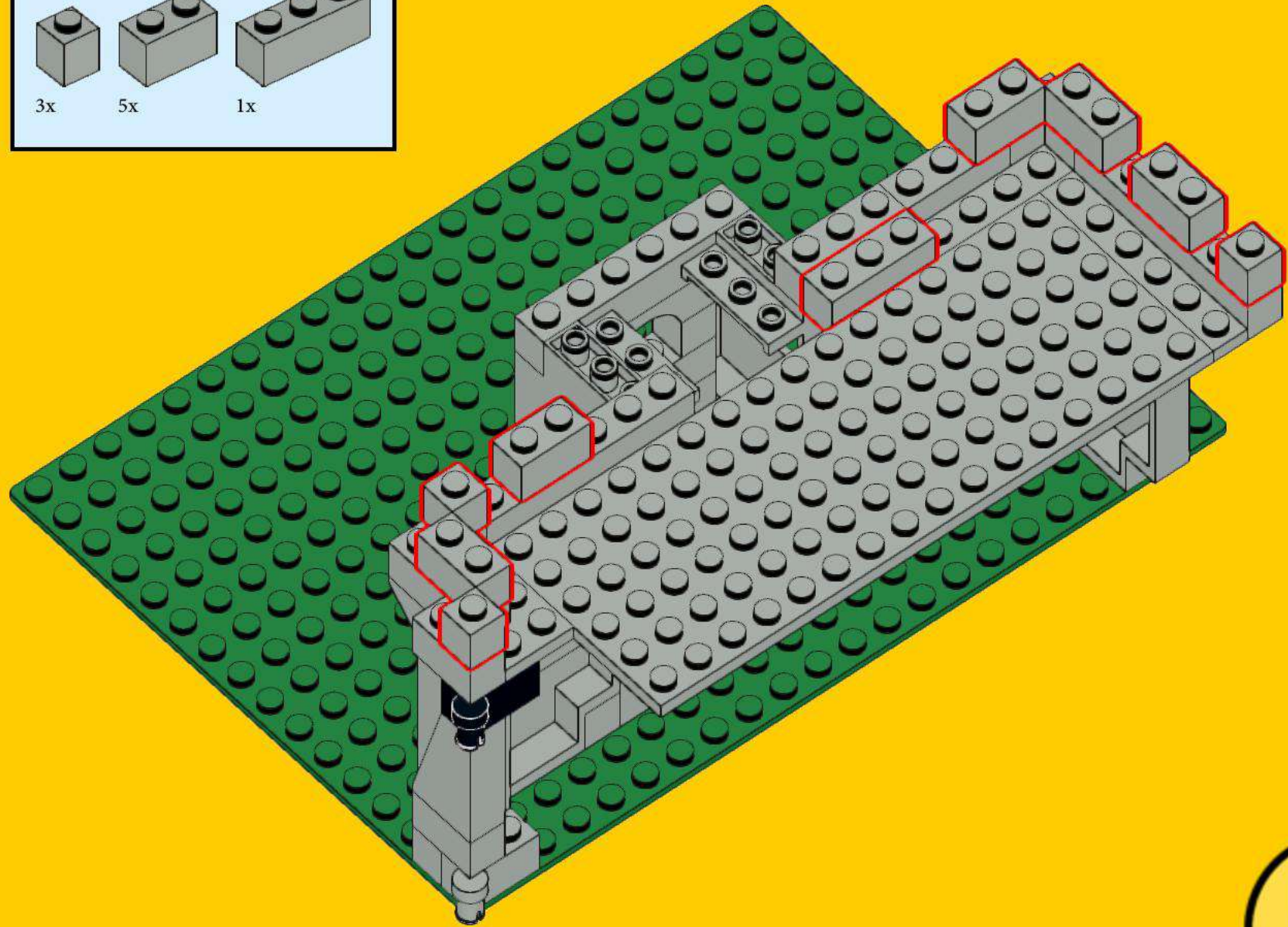
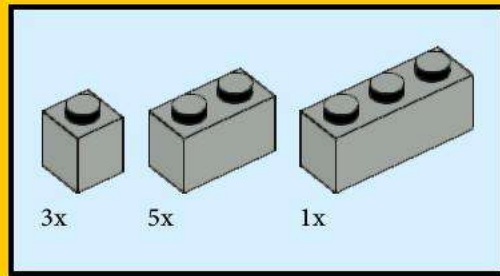

107

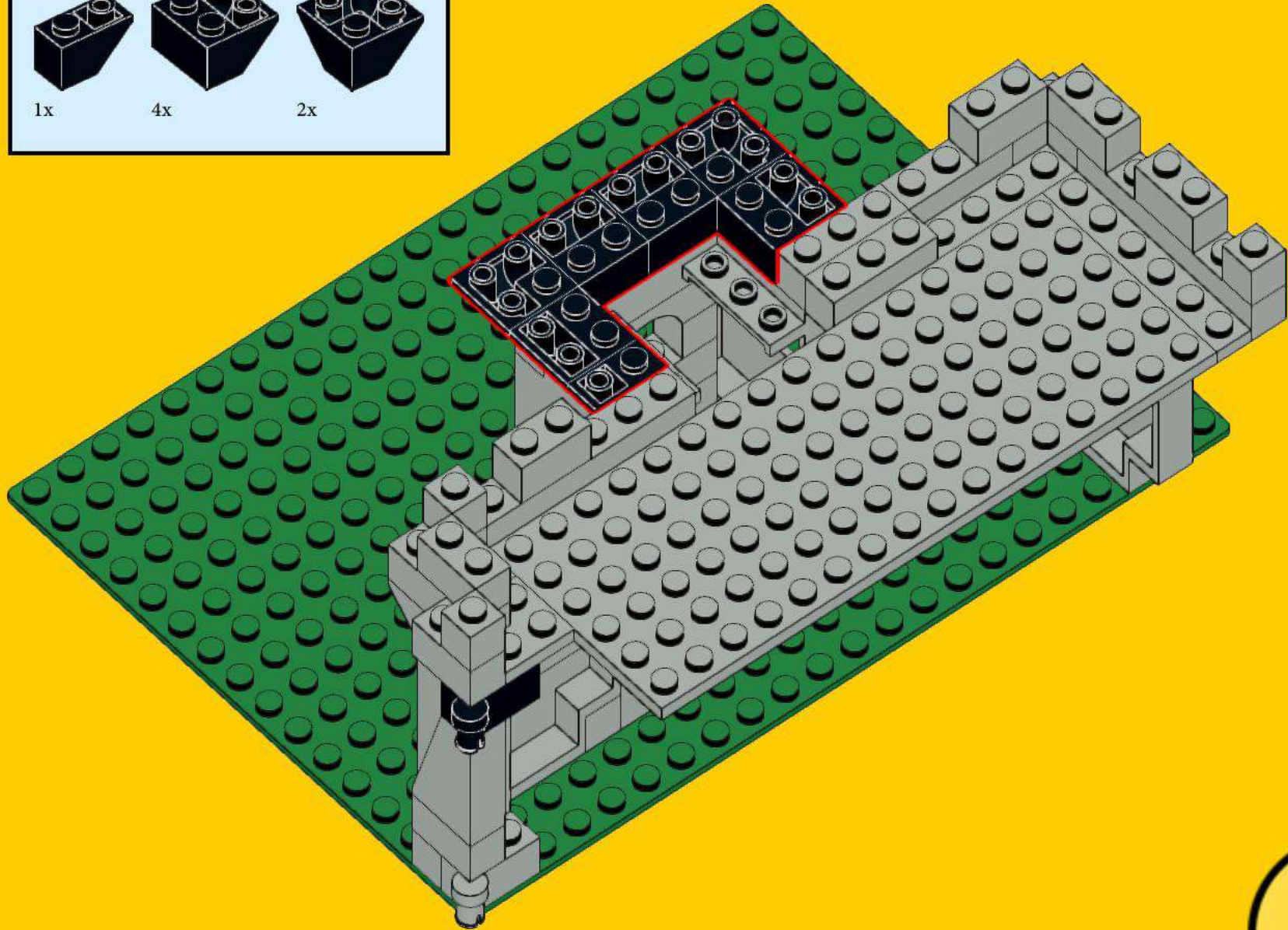
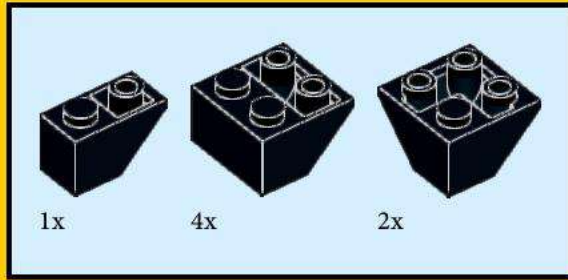

108

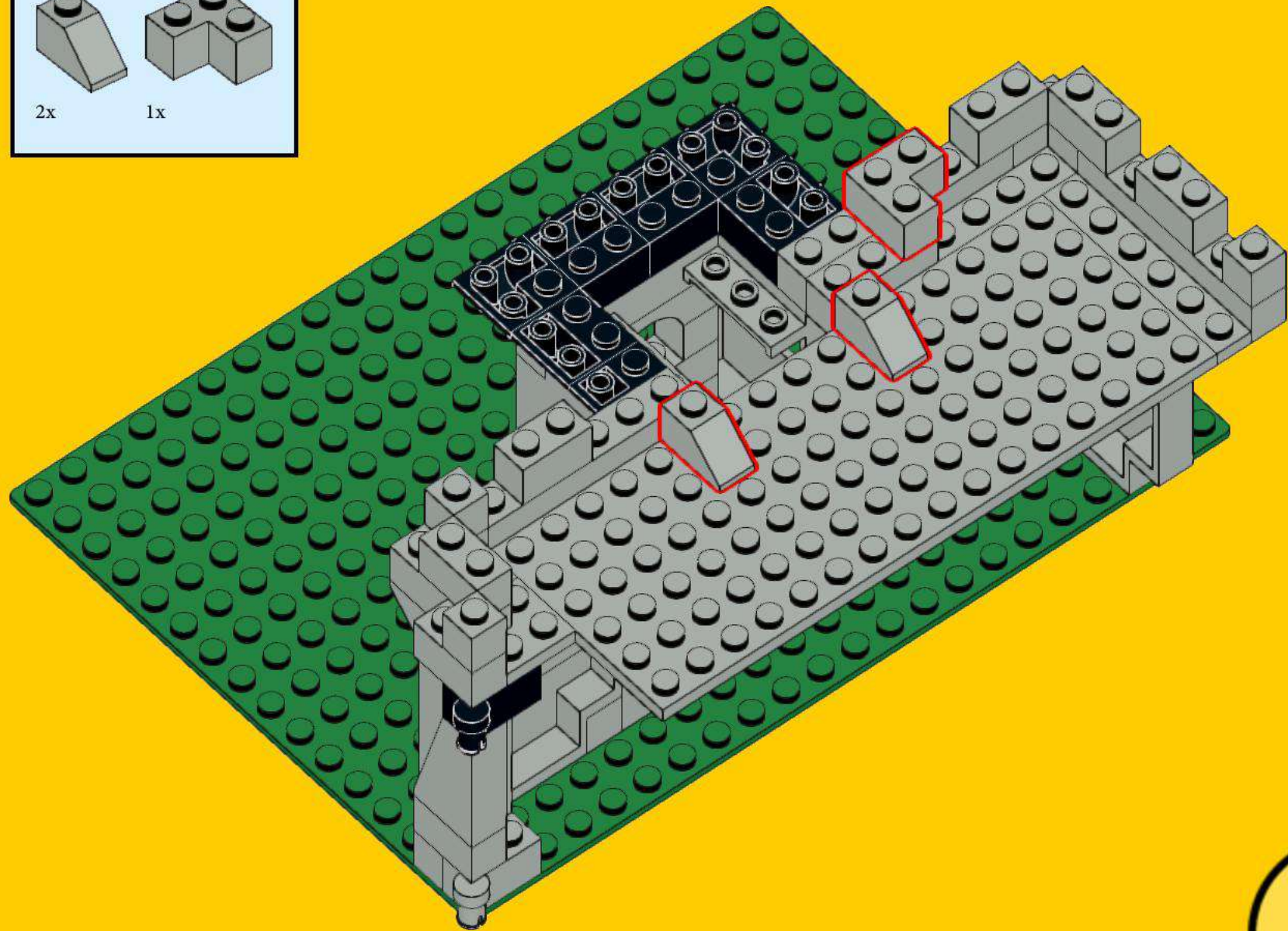
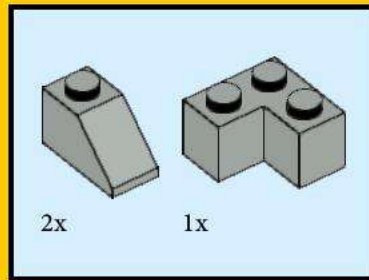

109

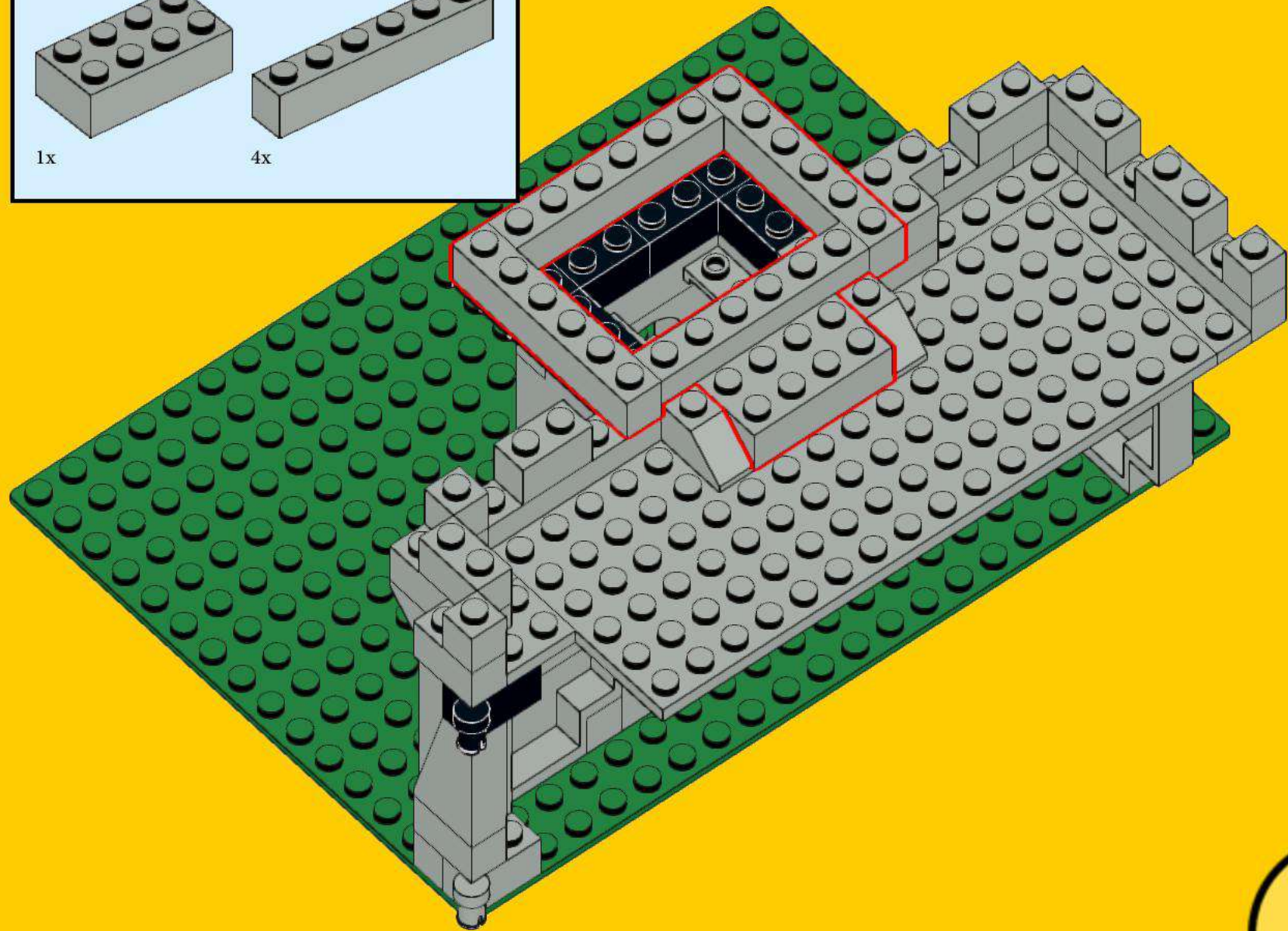
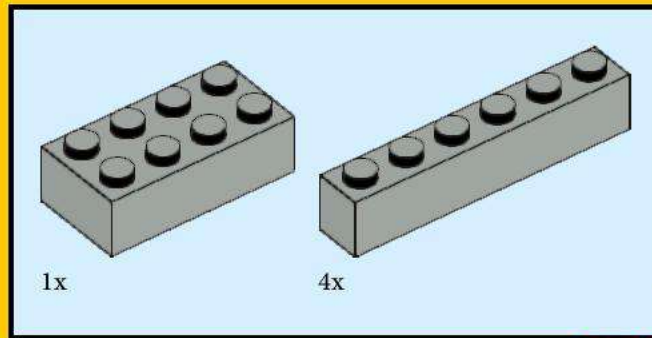

110

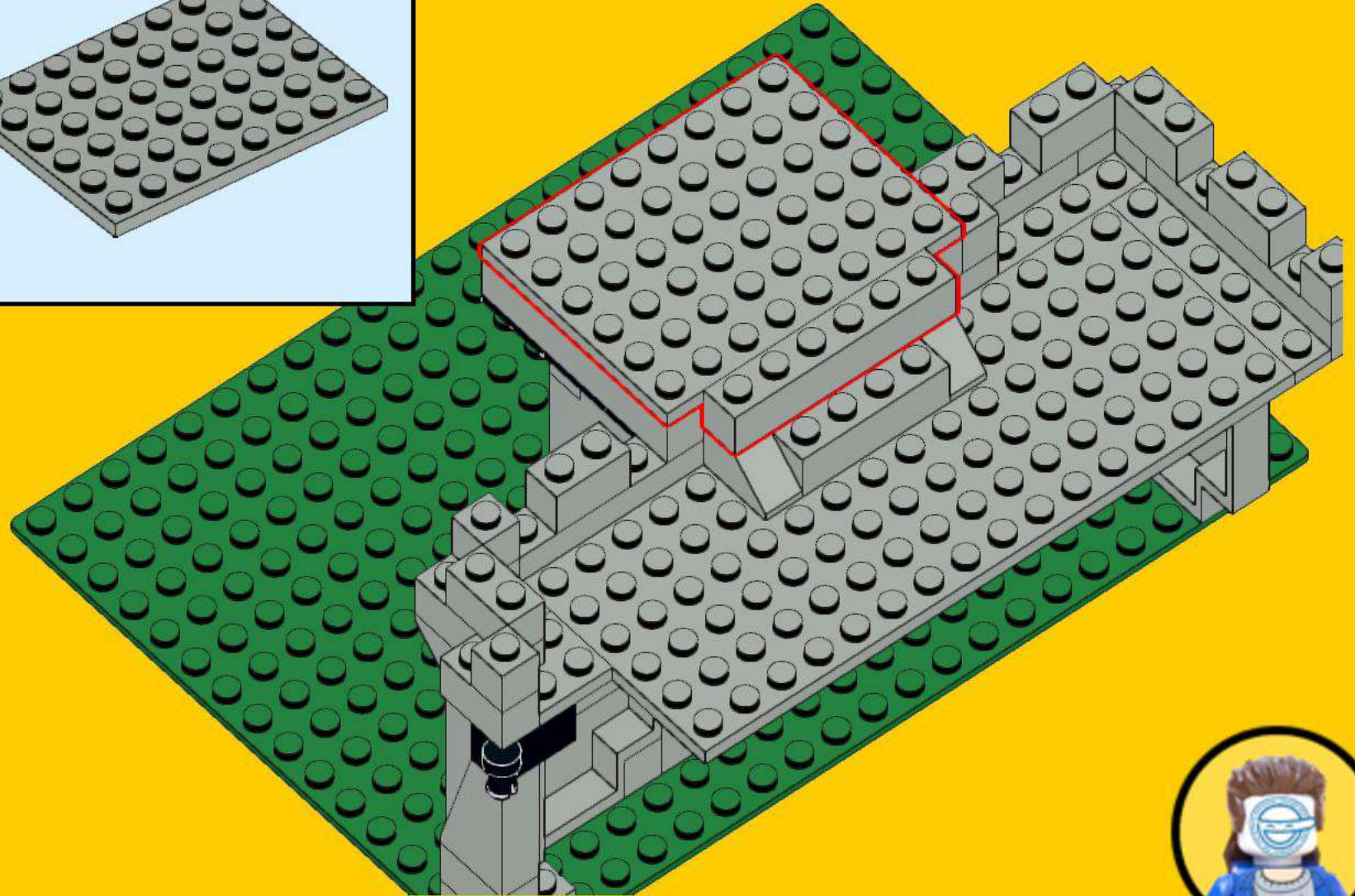
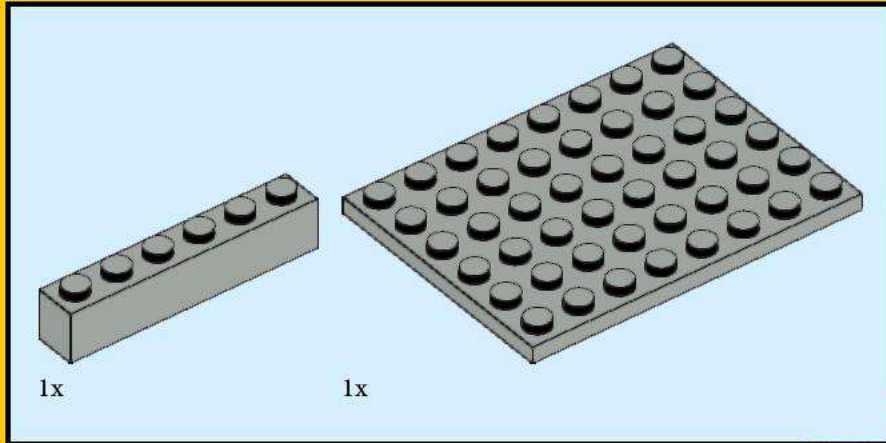

111

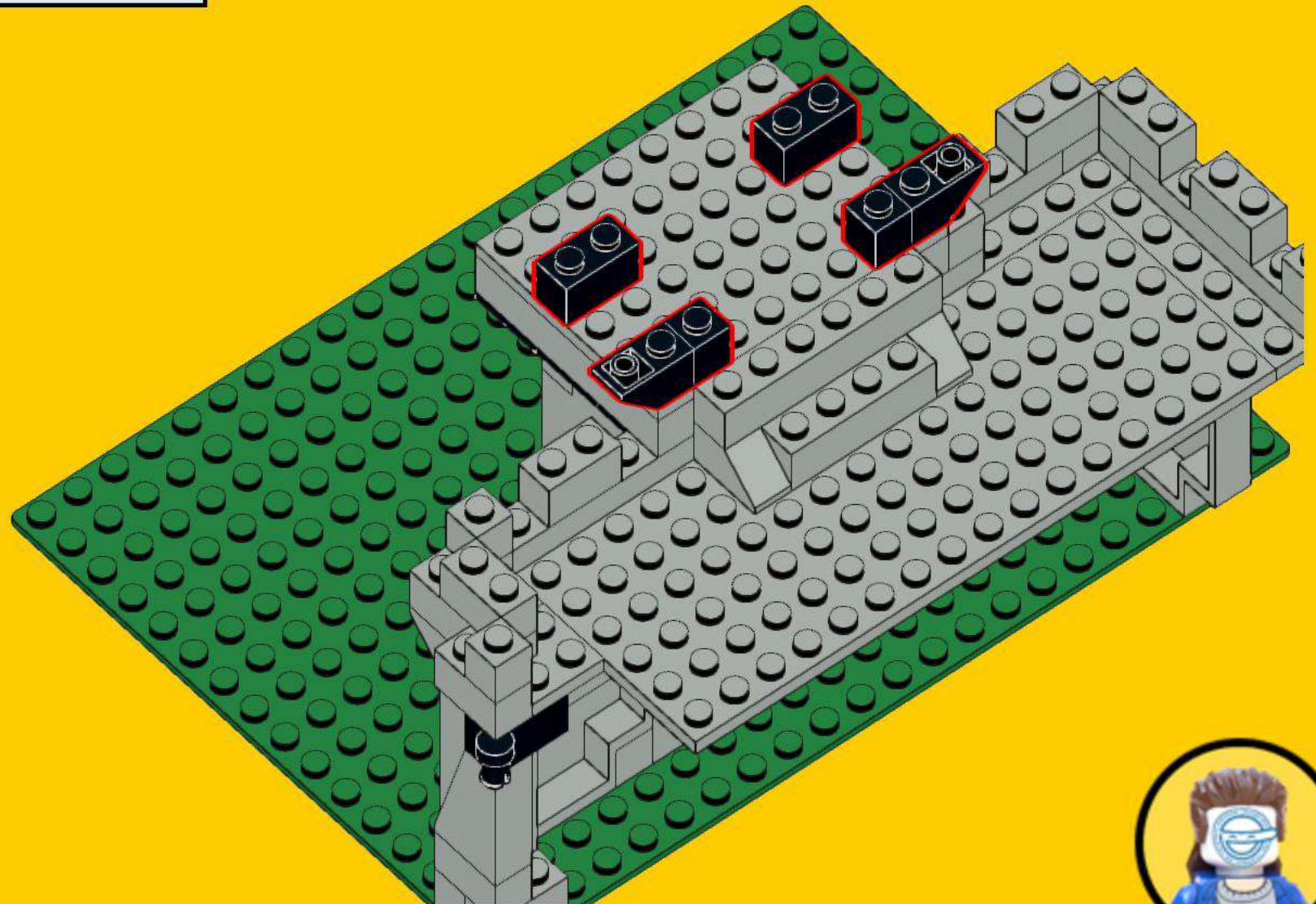
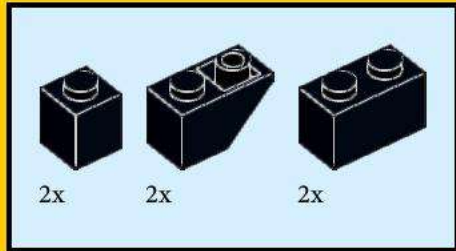

112

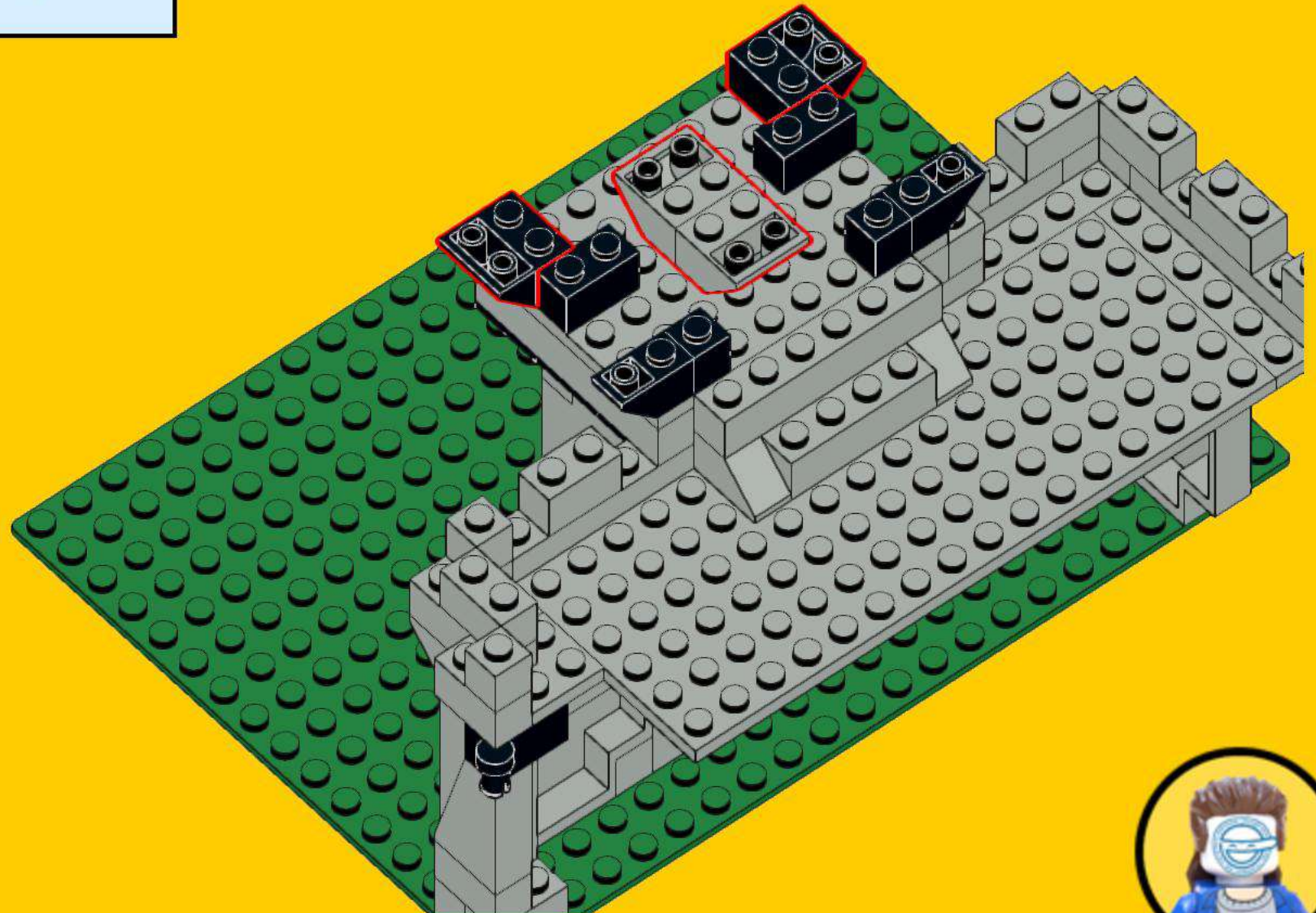
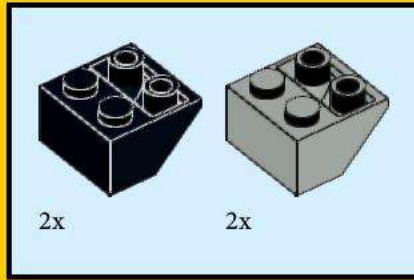

113

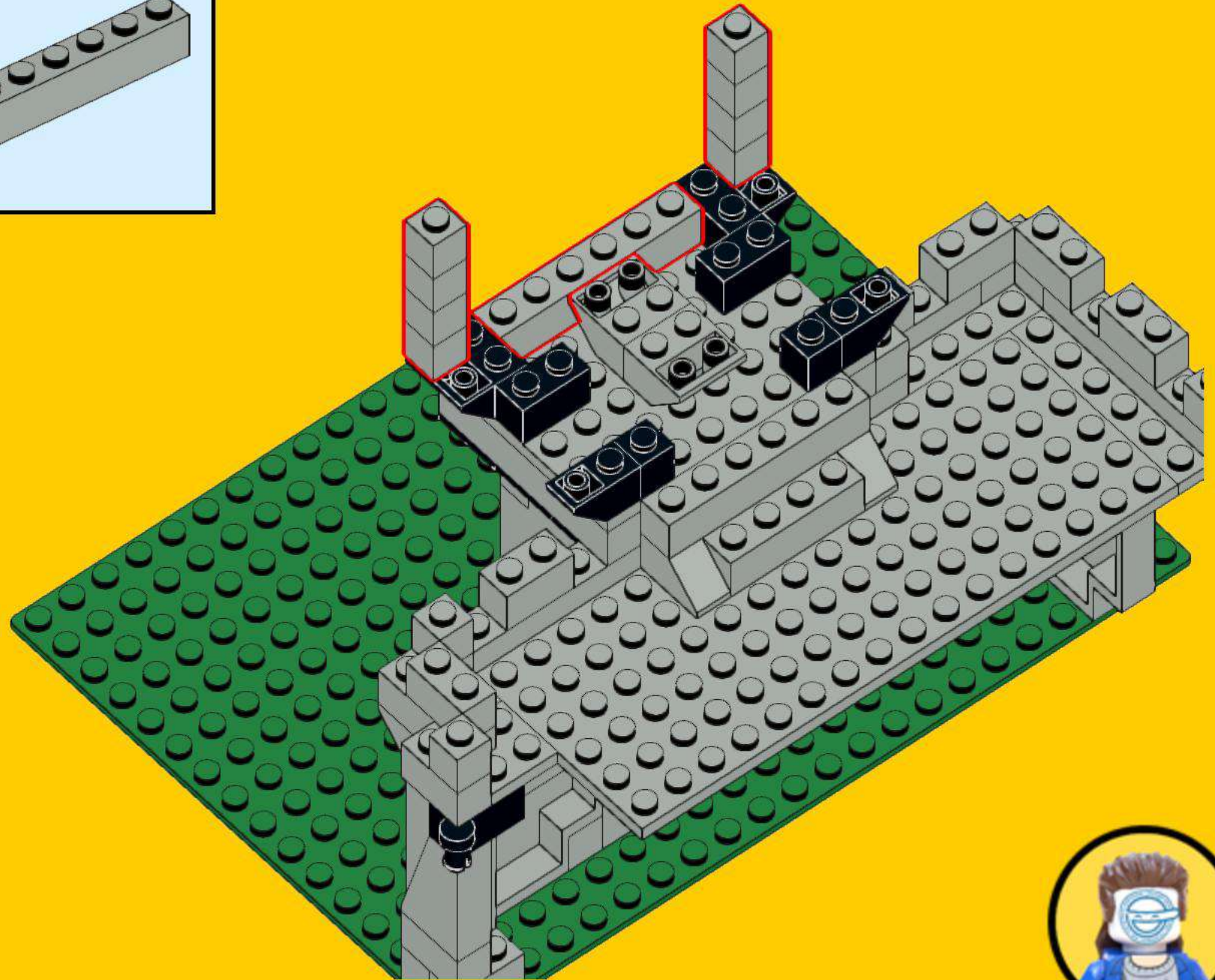
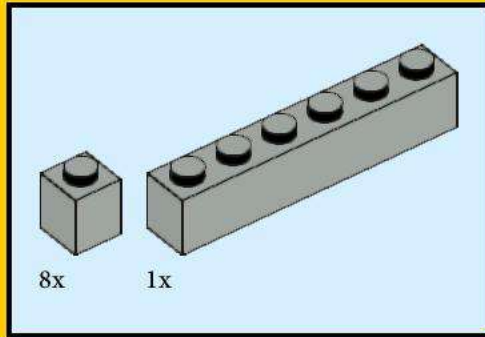

114

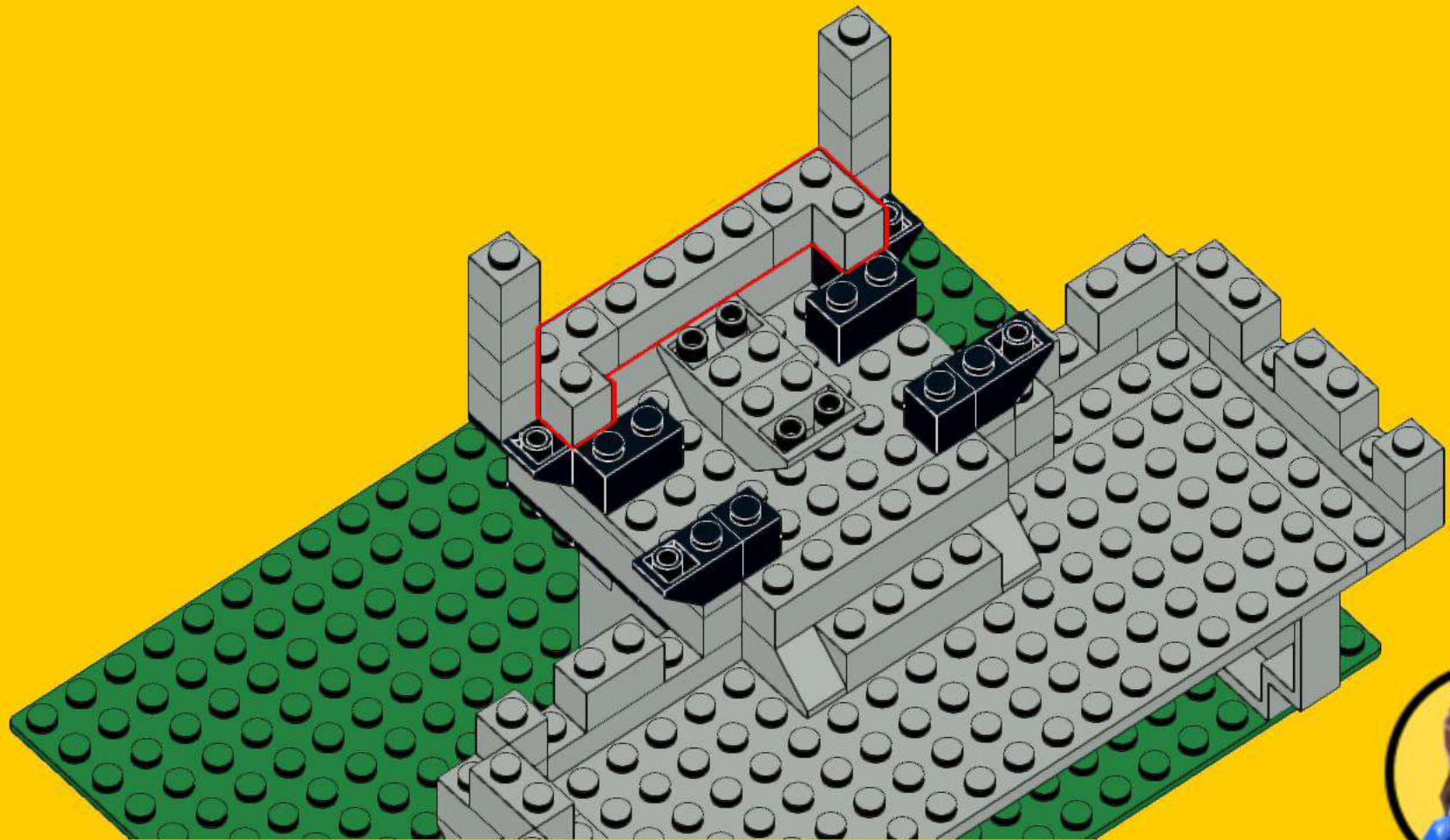
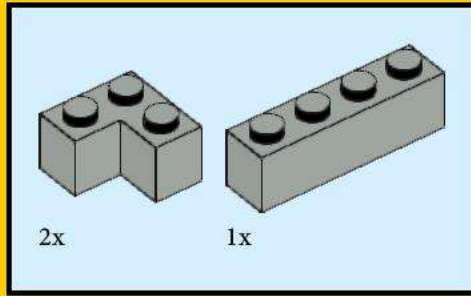

115

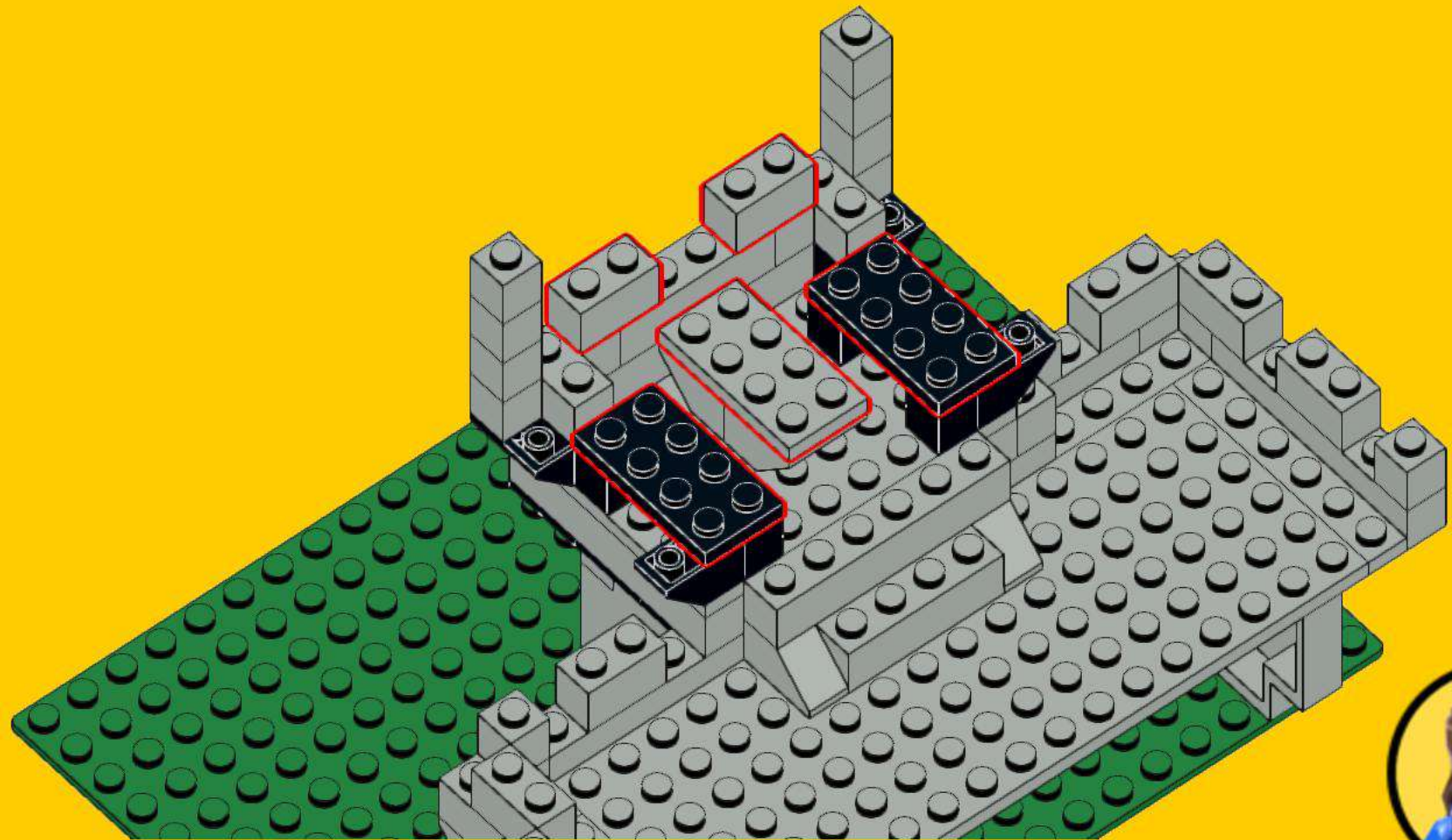
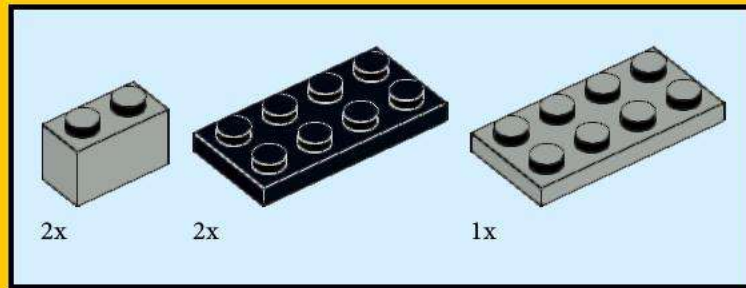

116

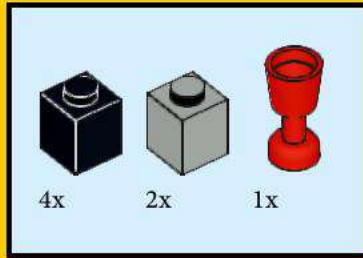

117

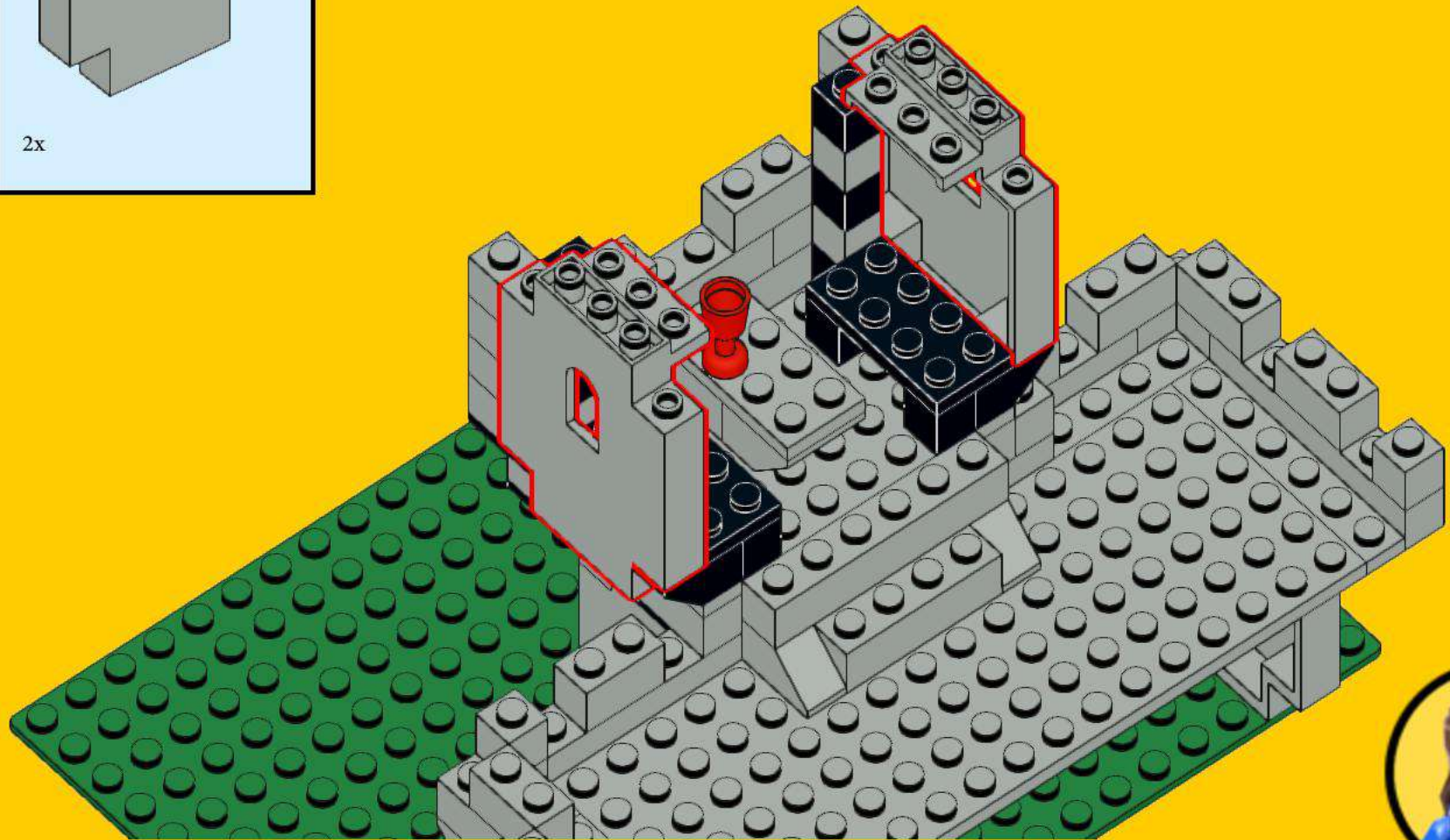
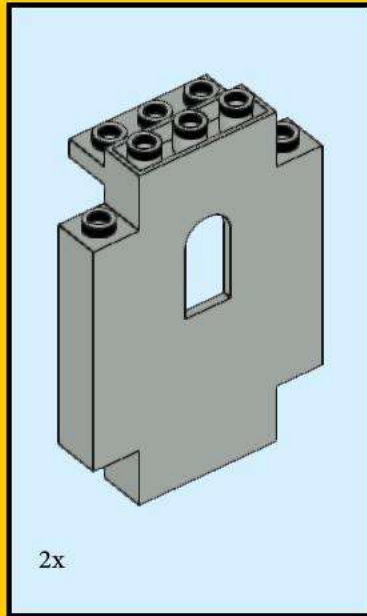

118

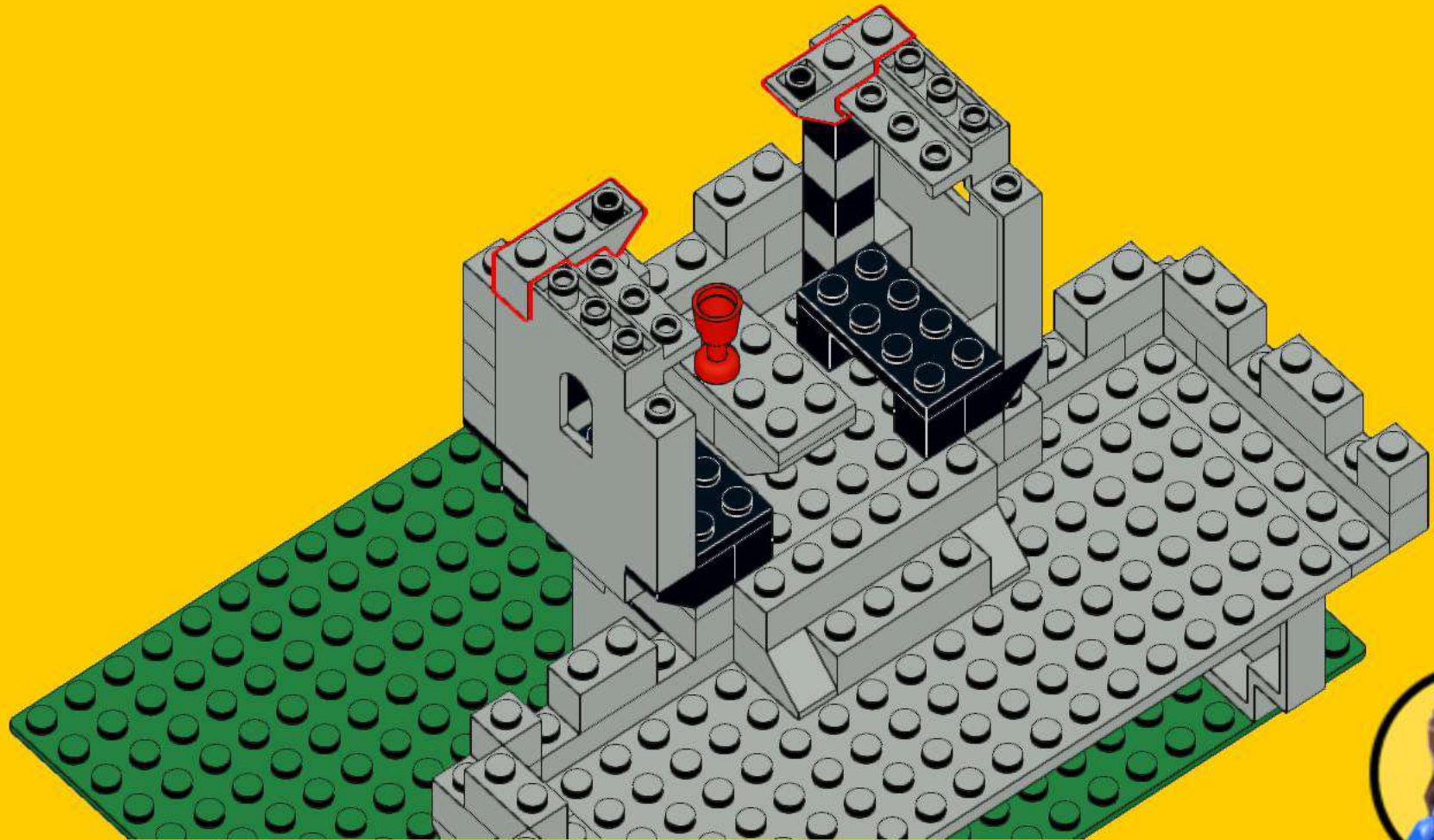
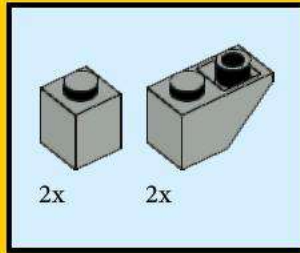

119

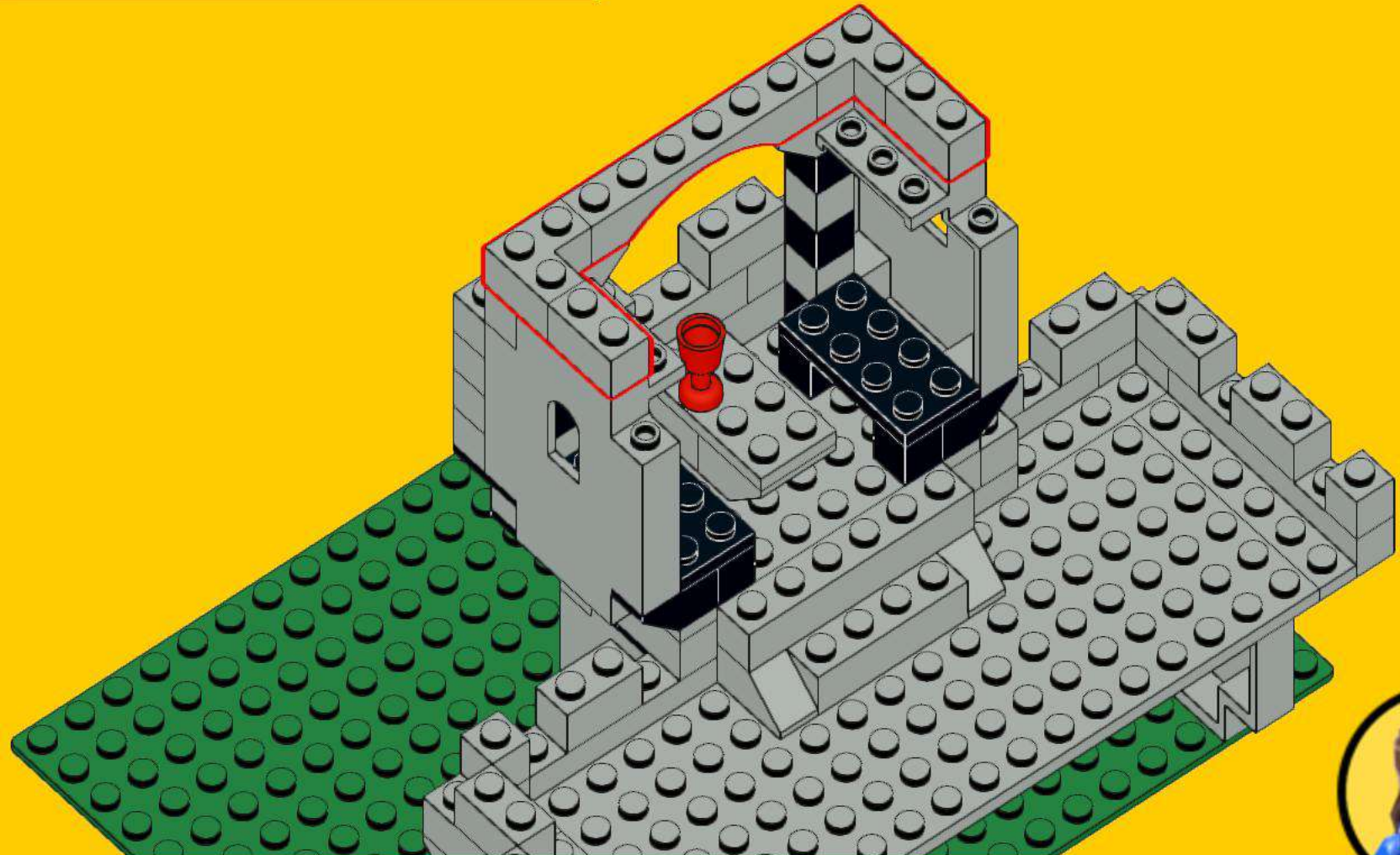
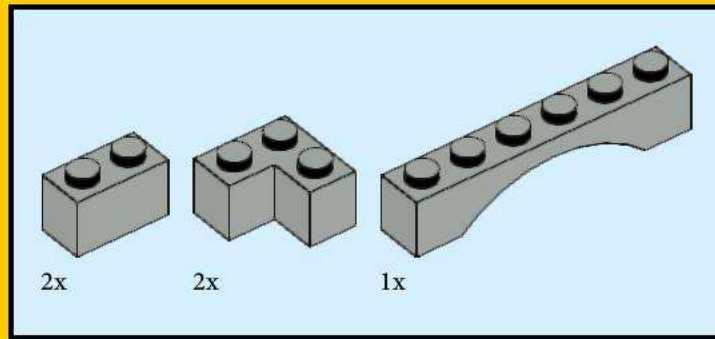

120

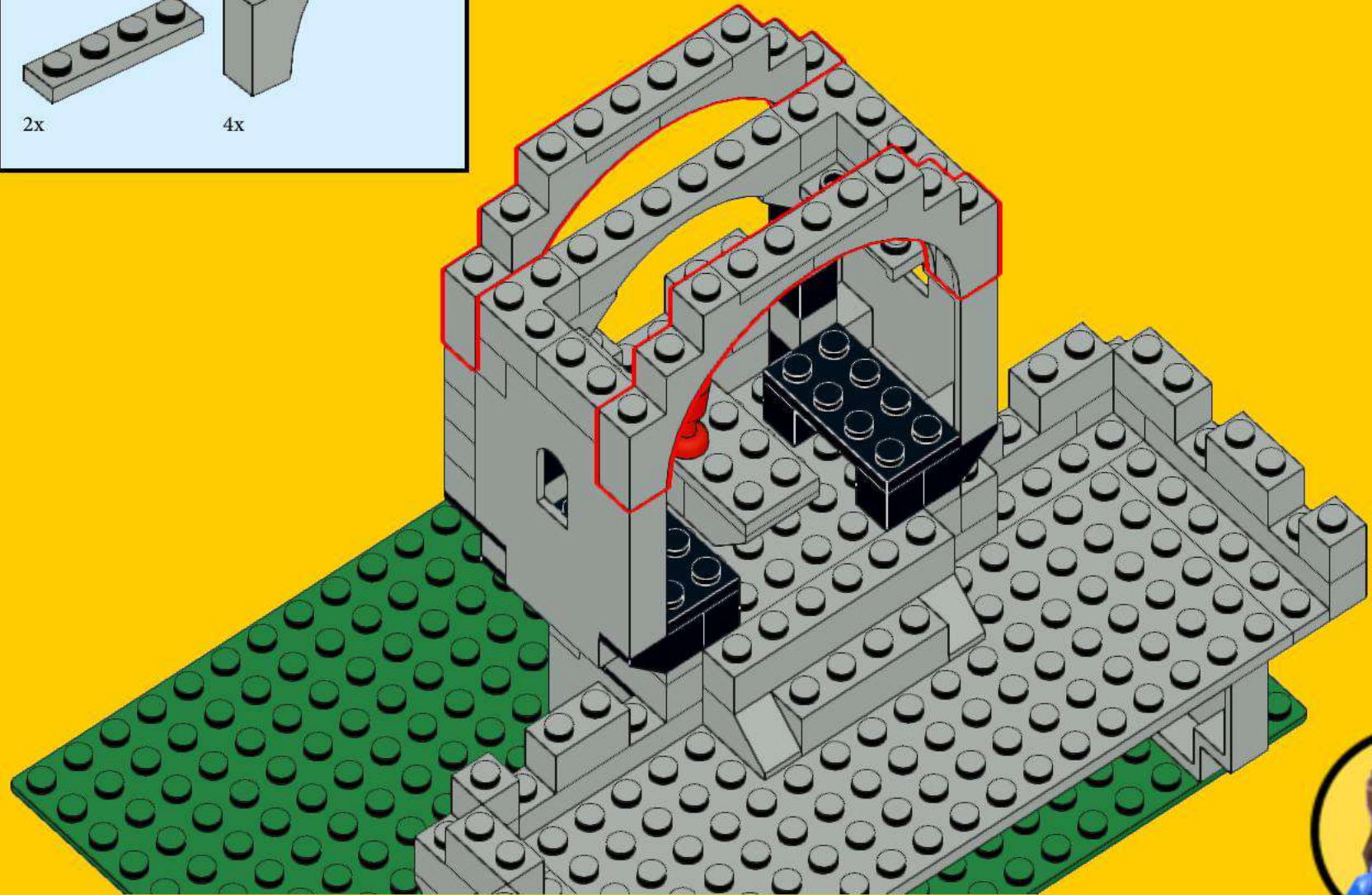
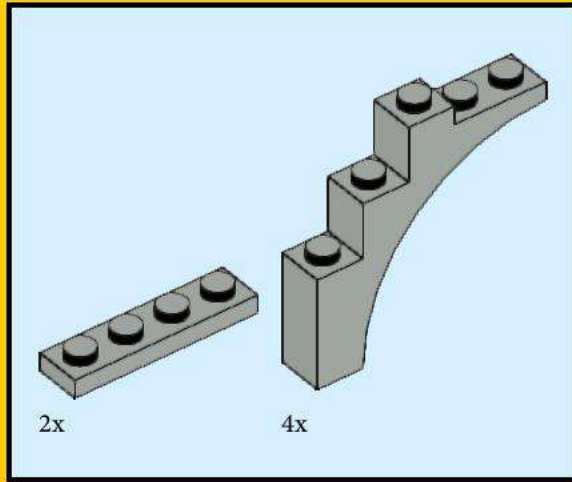

121

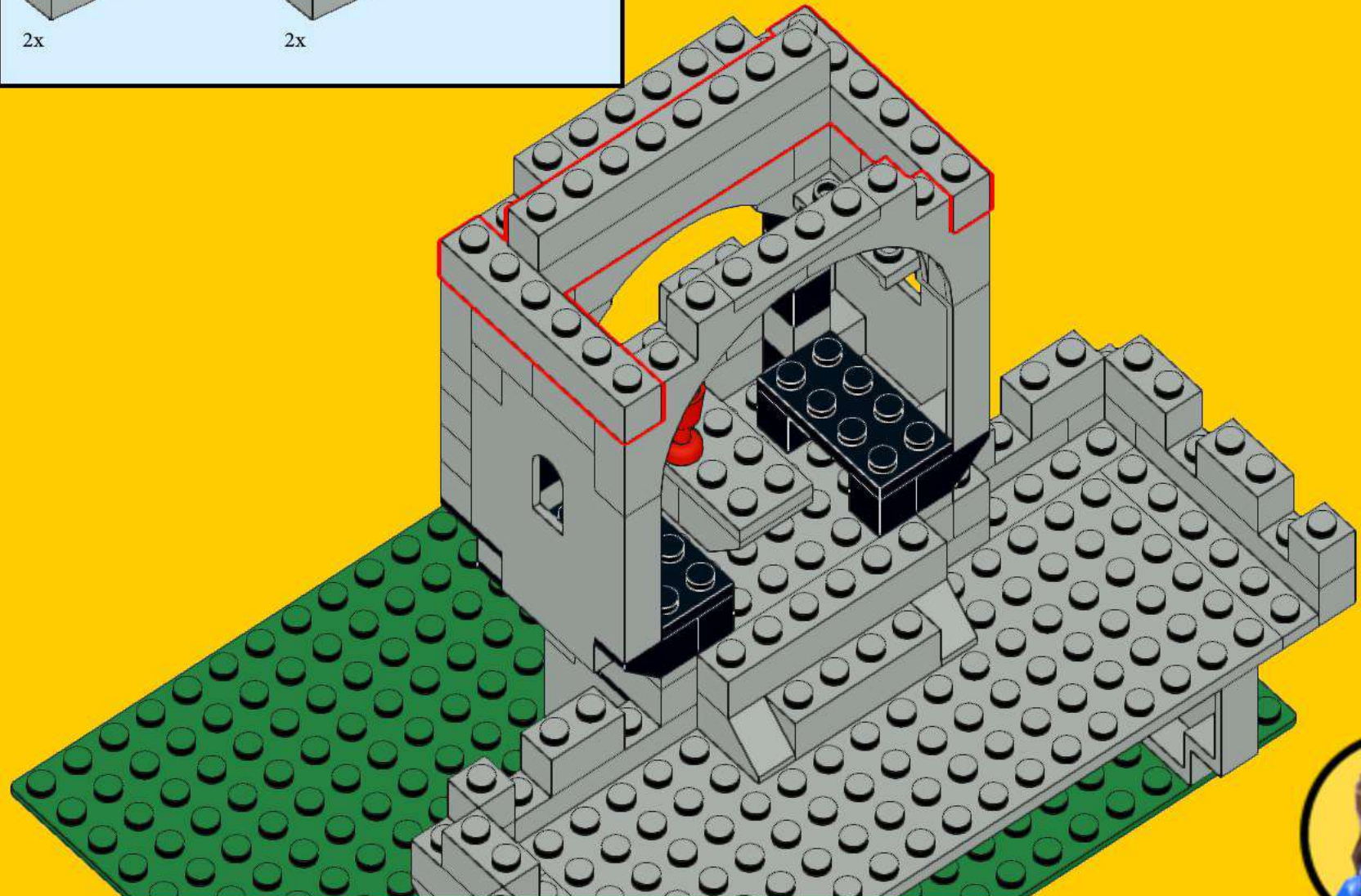
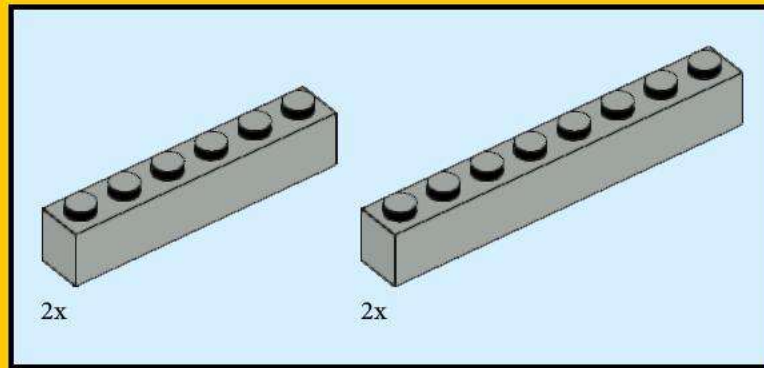

122

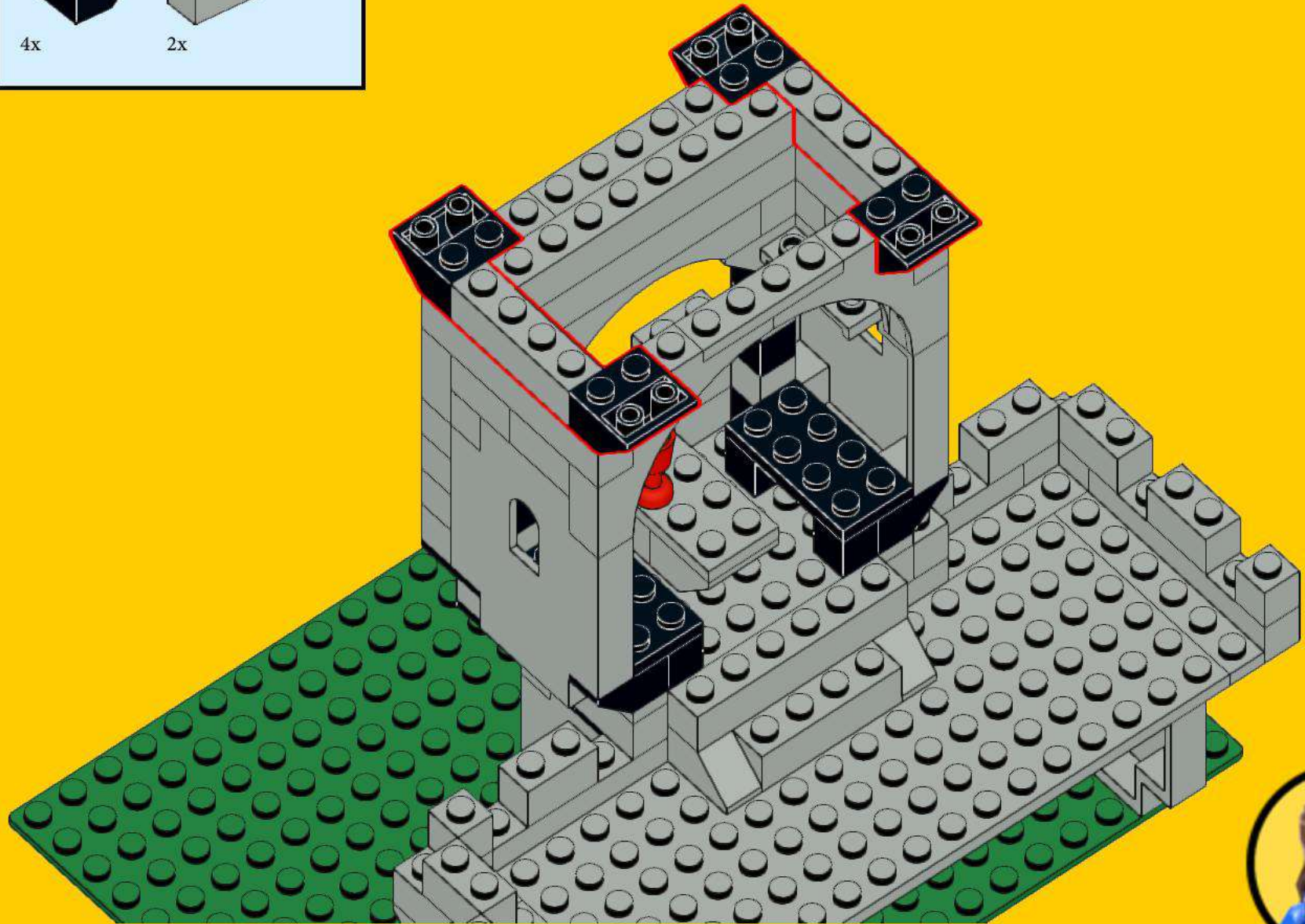
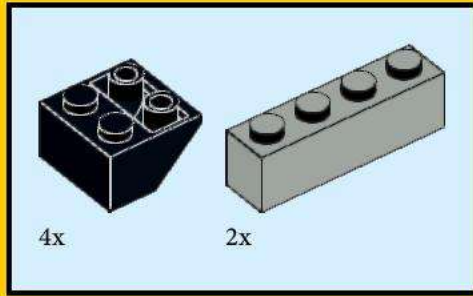

123

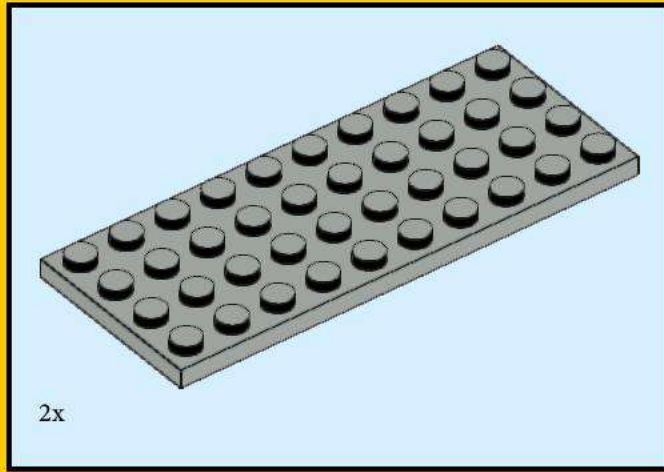

124

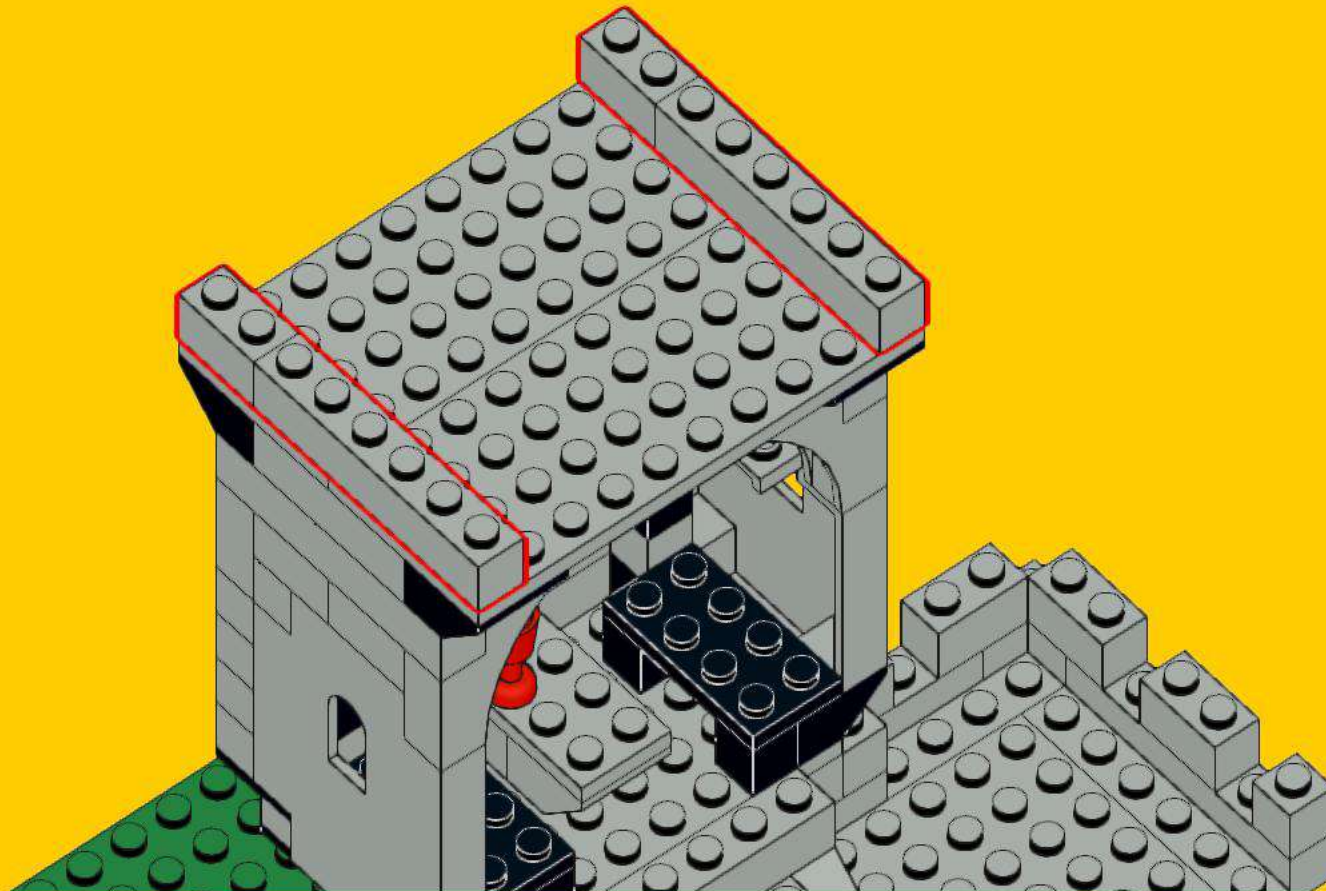
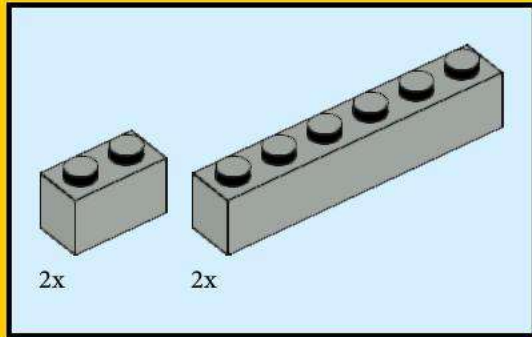

125

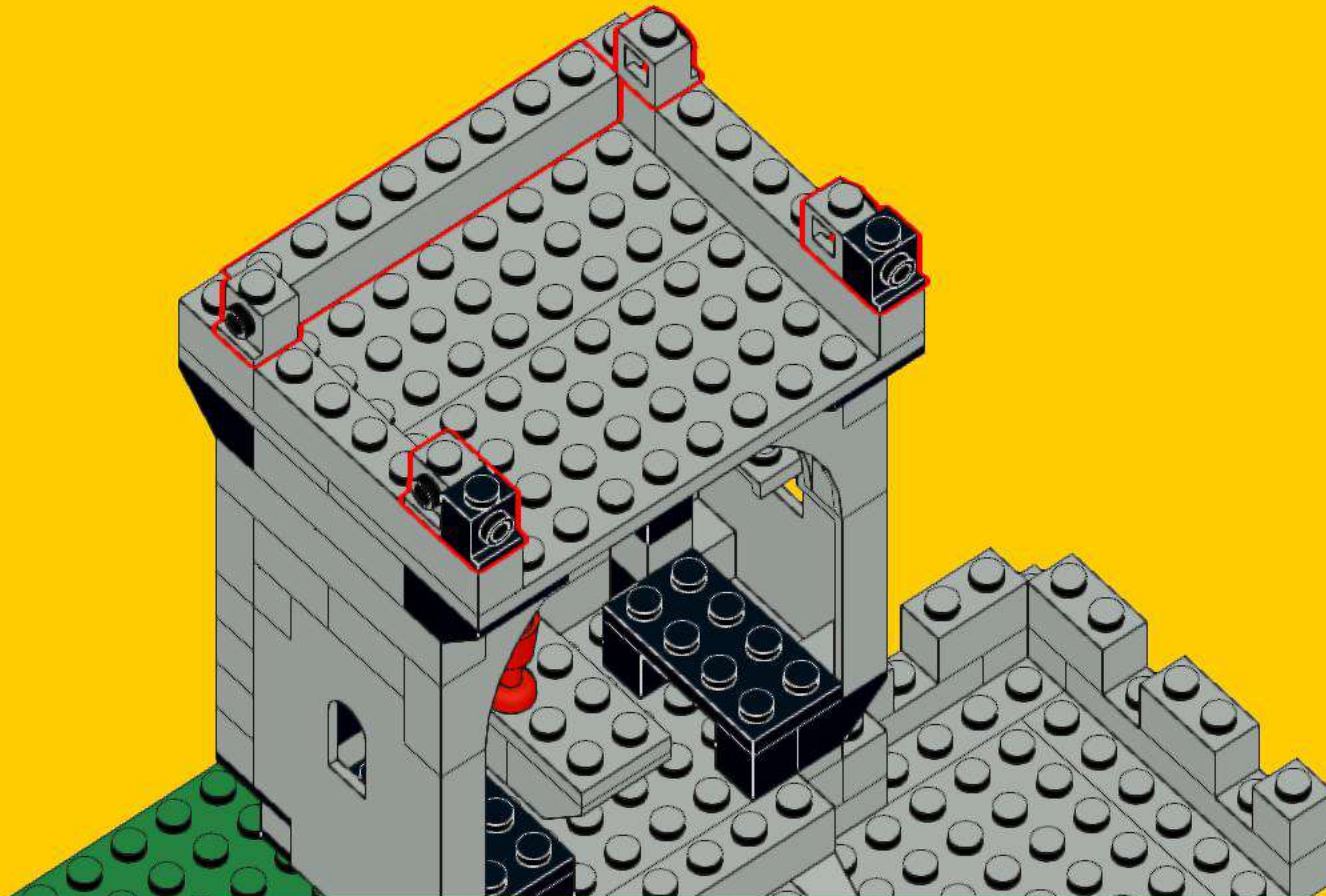
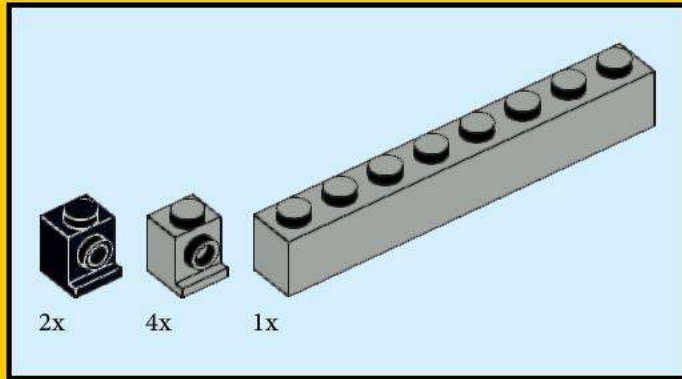

126

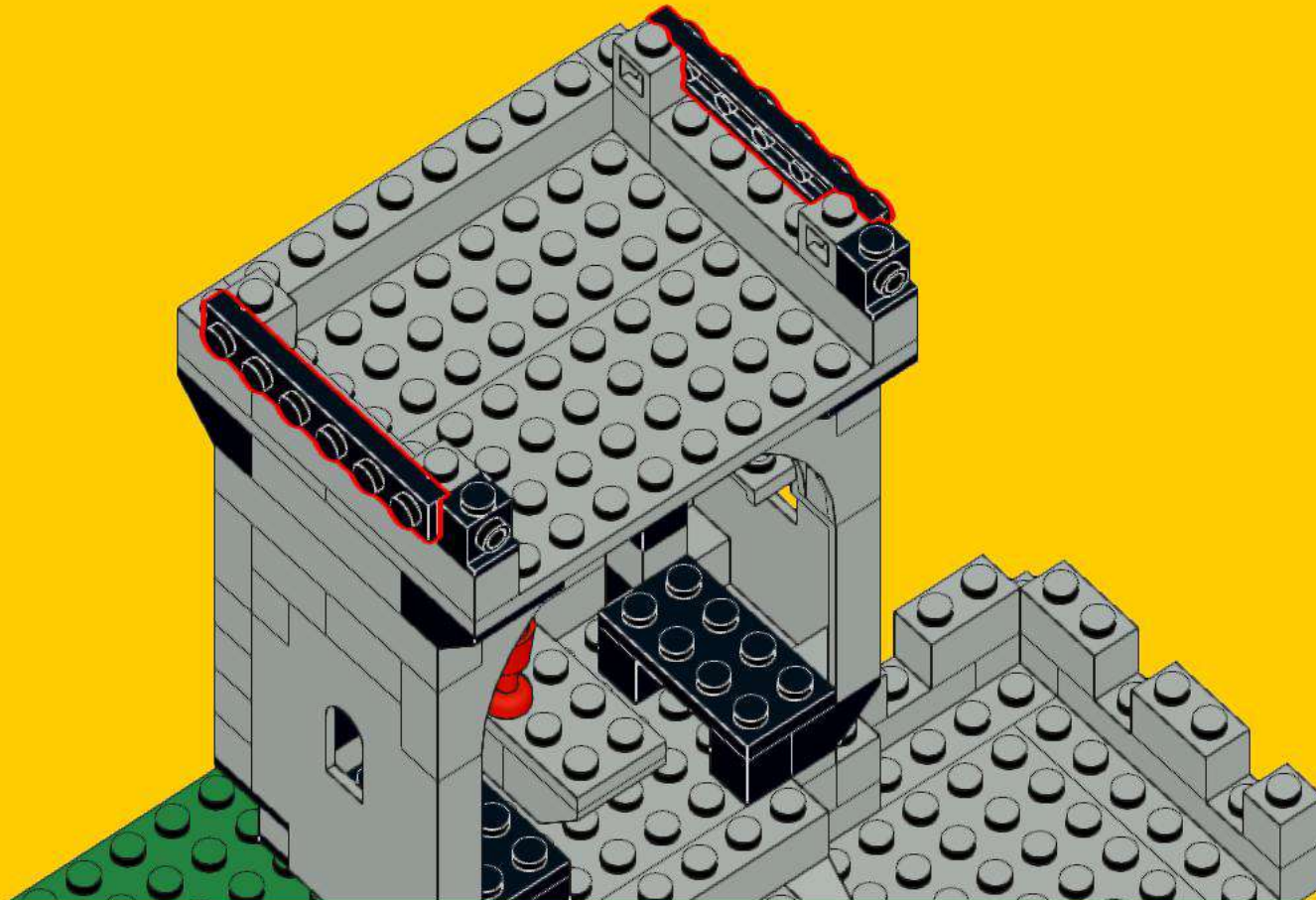
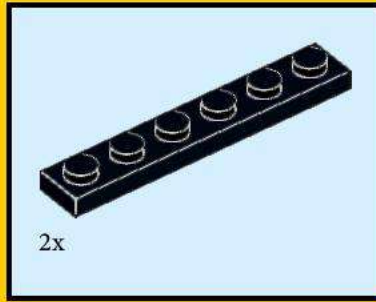

127

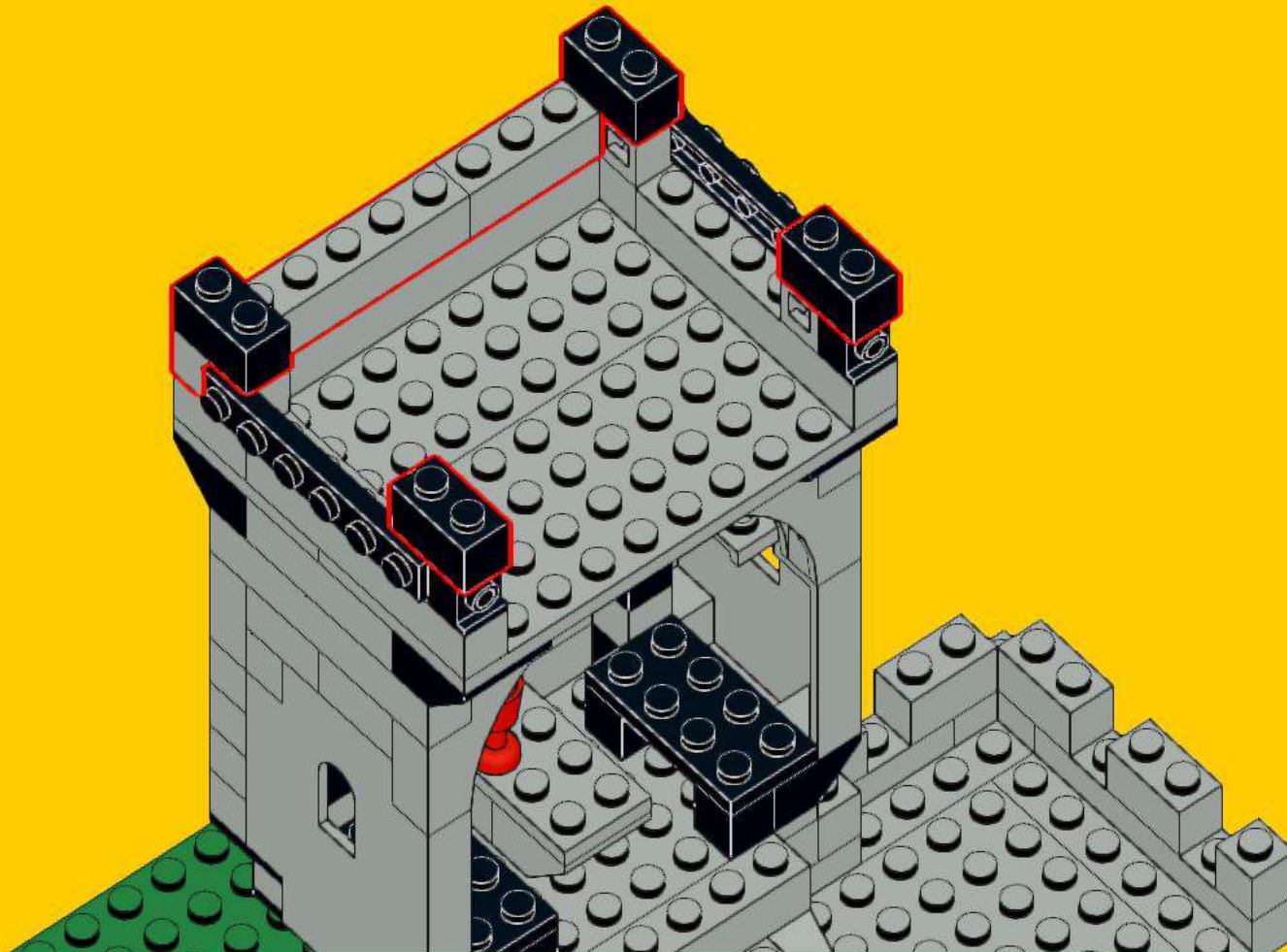
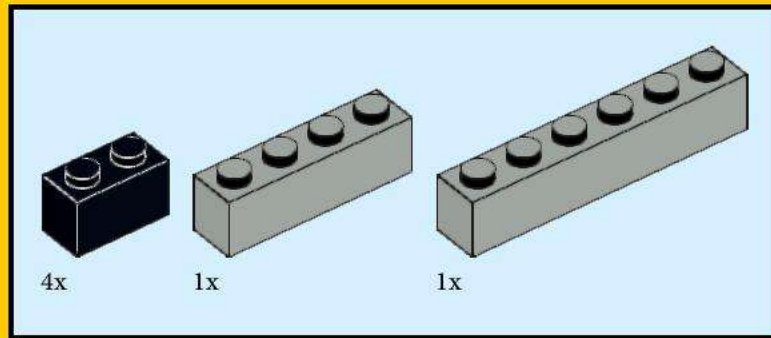

128

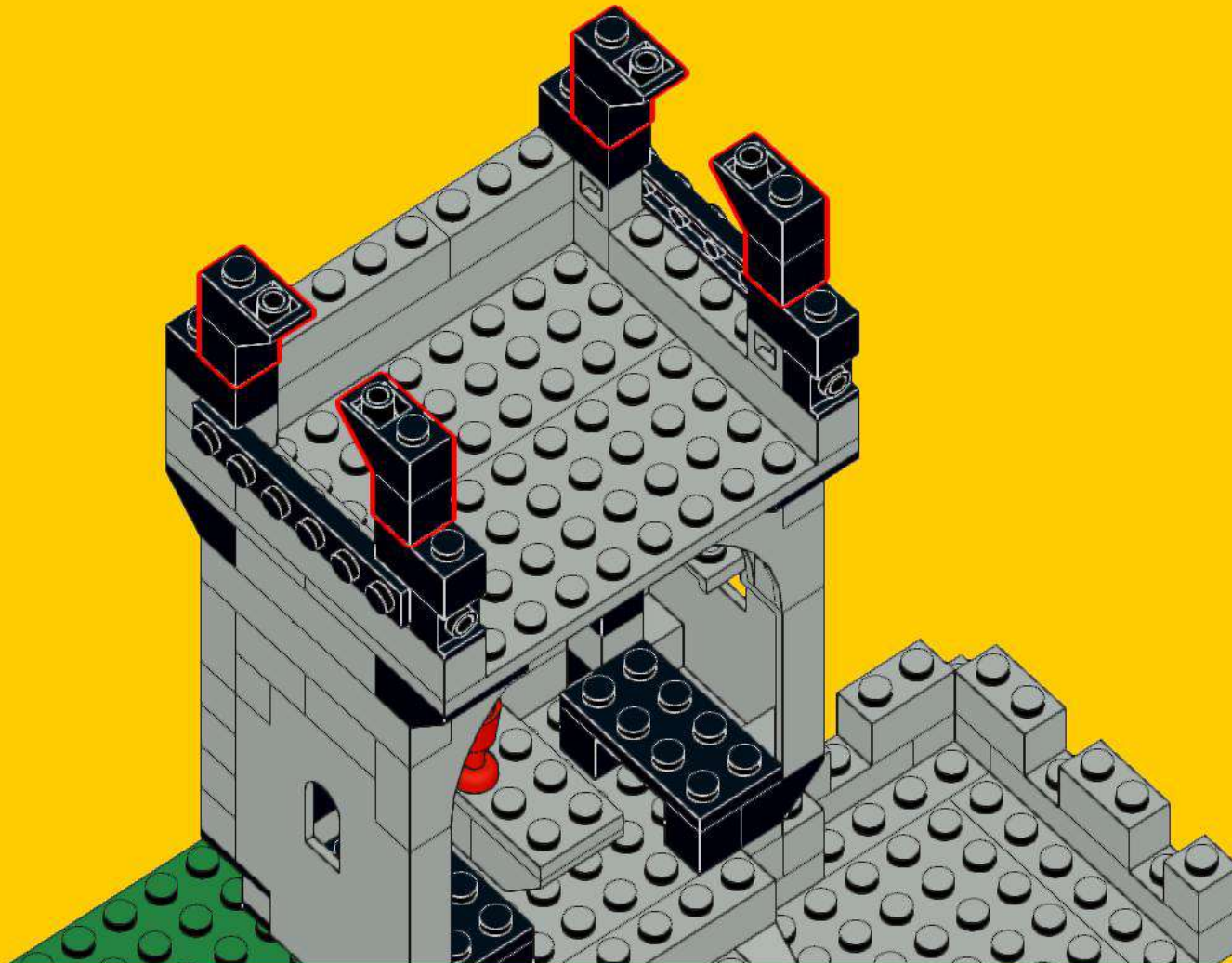
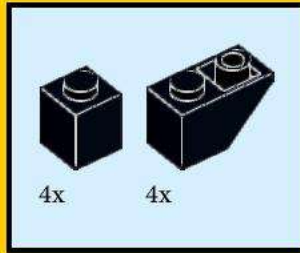

129

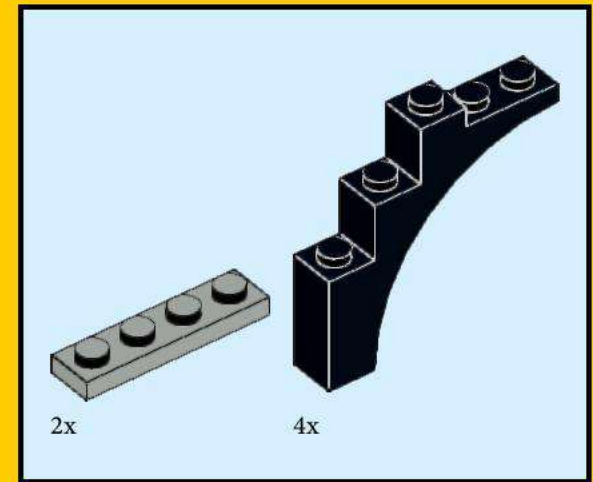
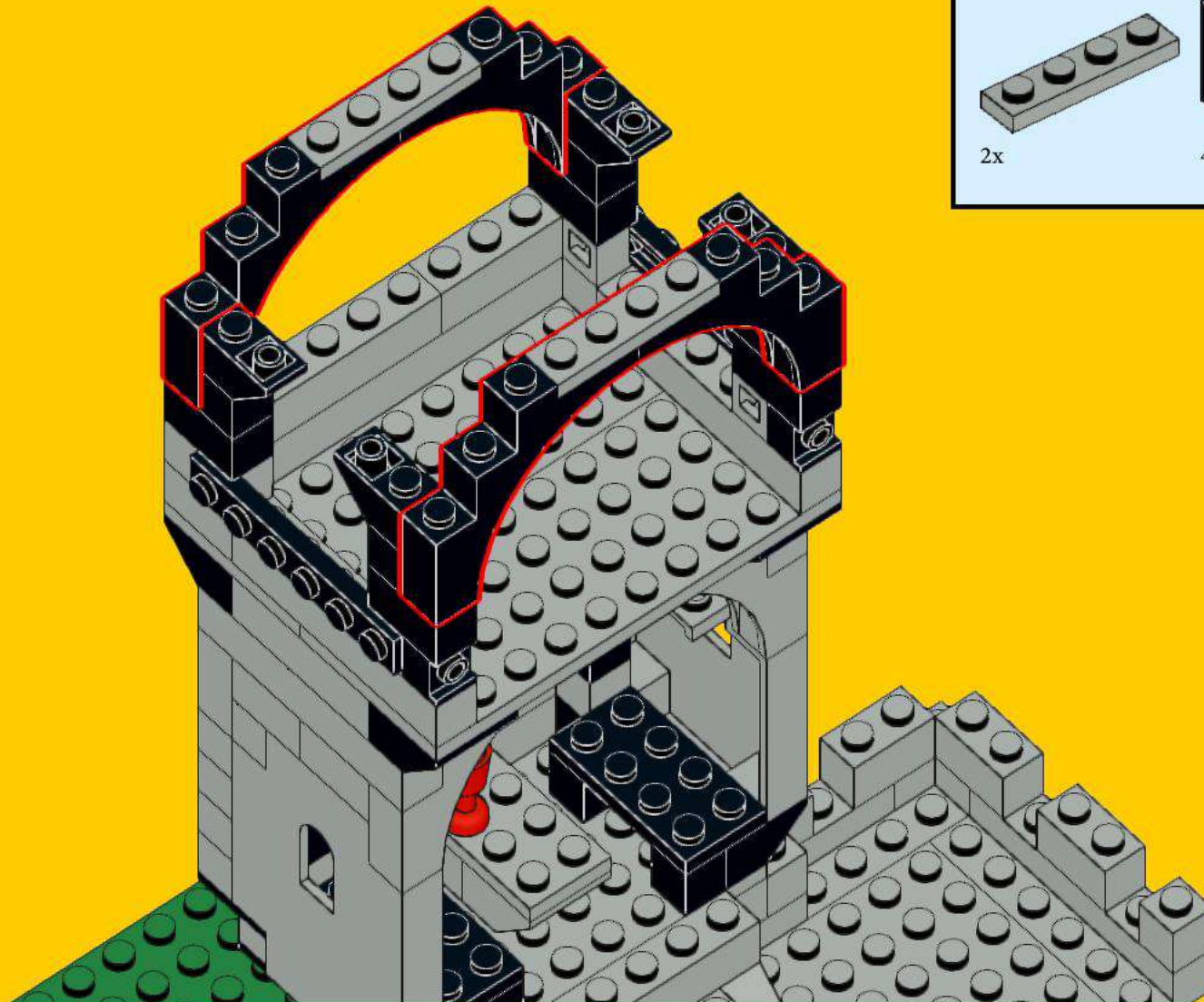

130

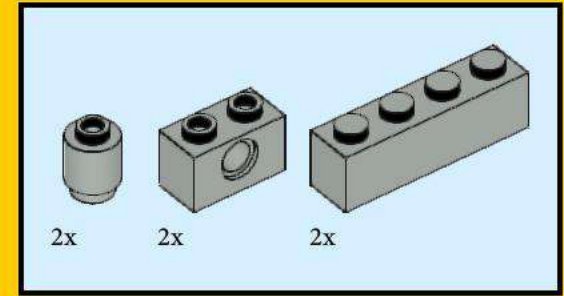

131

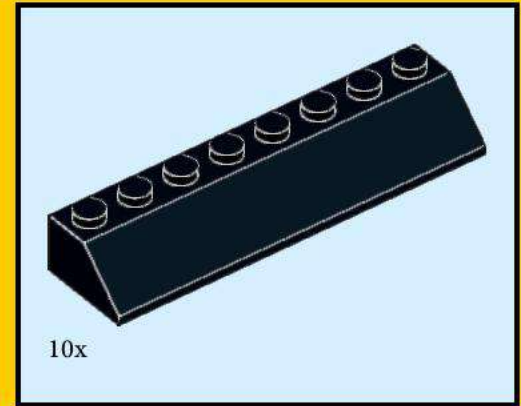
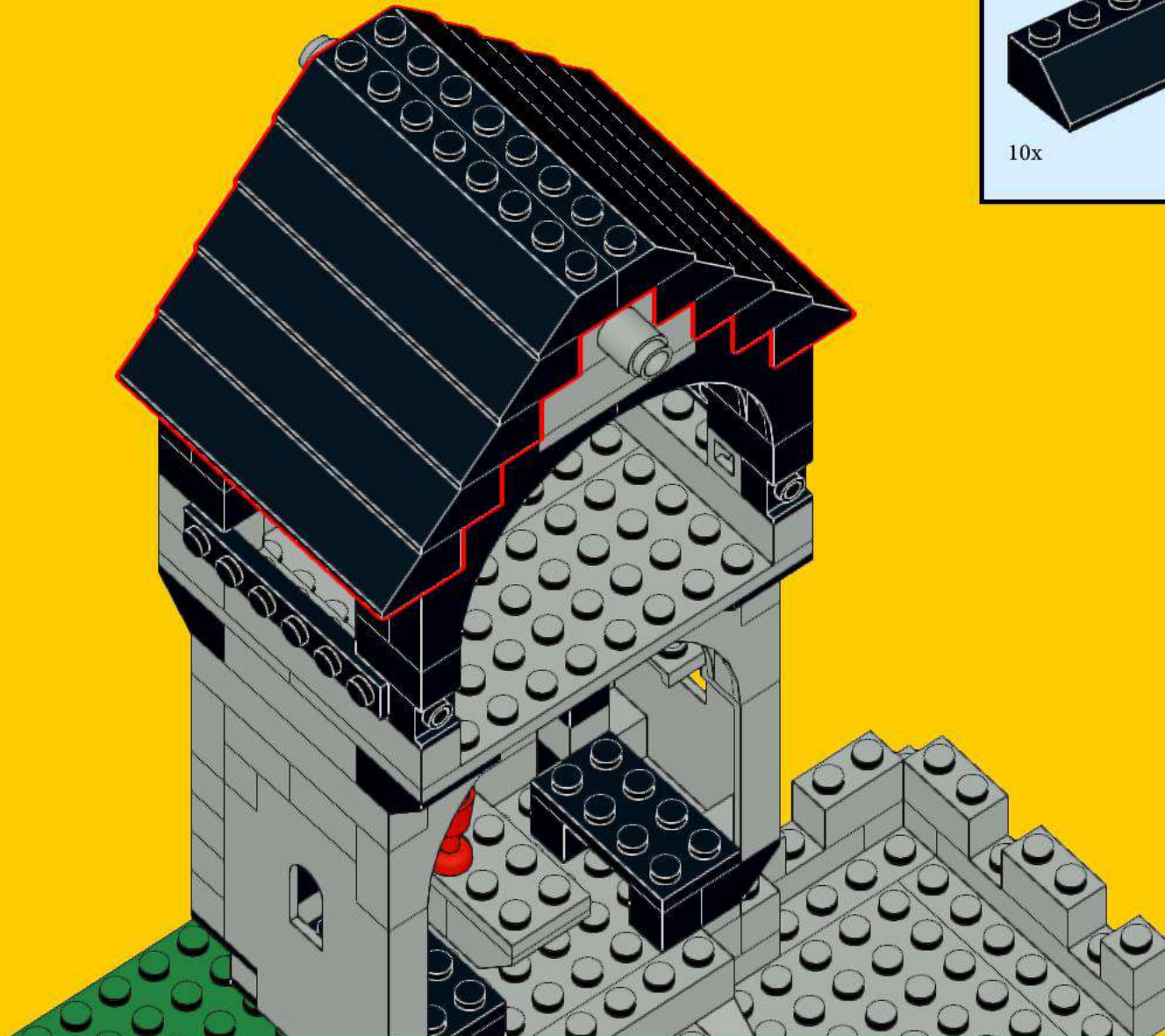

132

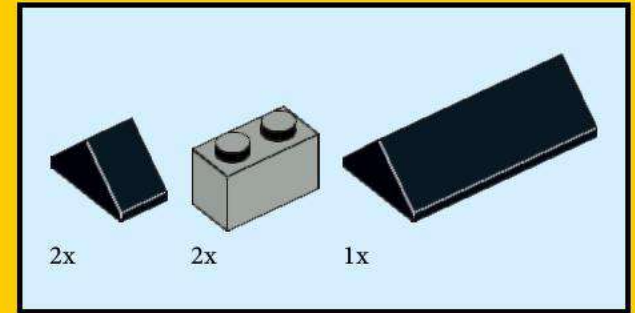
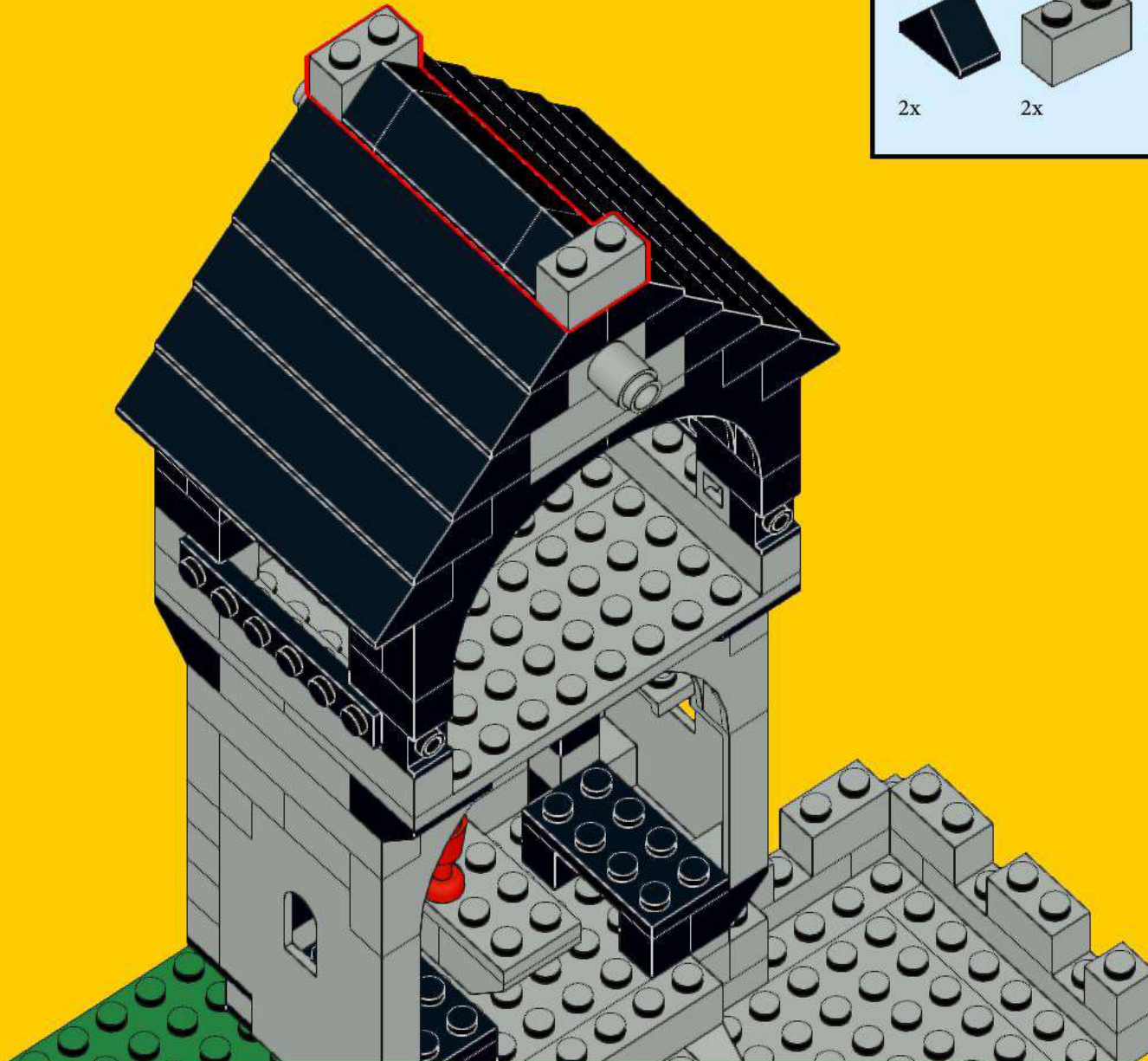

133

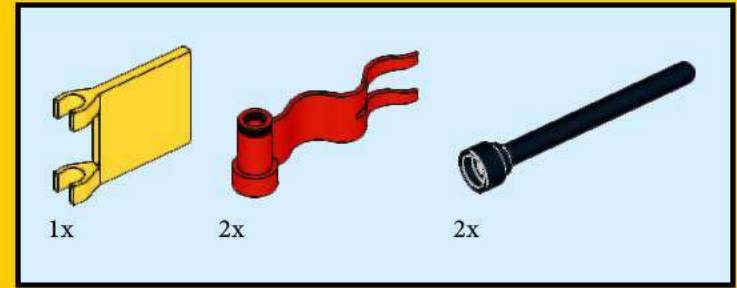

134



135



136



137

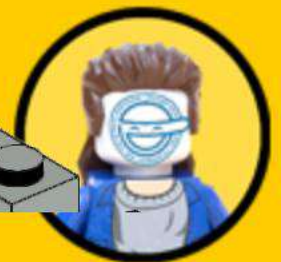

138

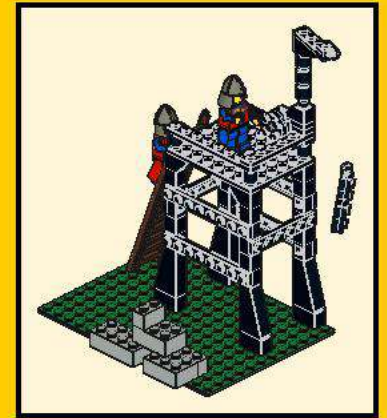
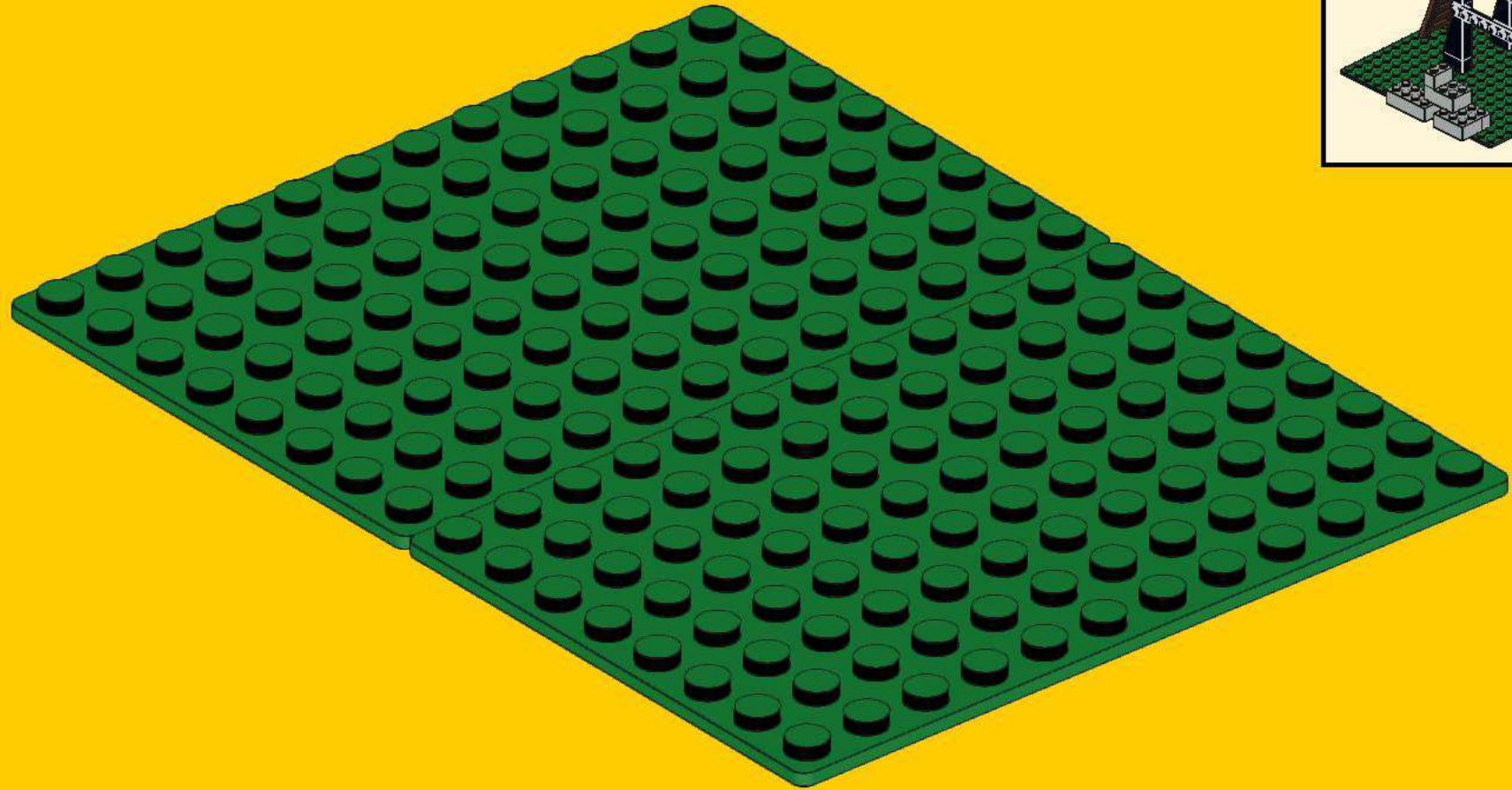

139

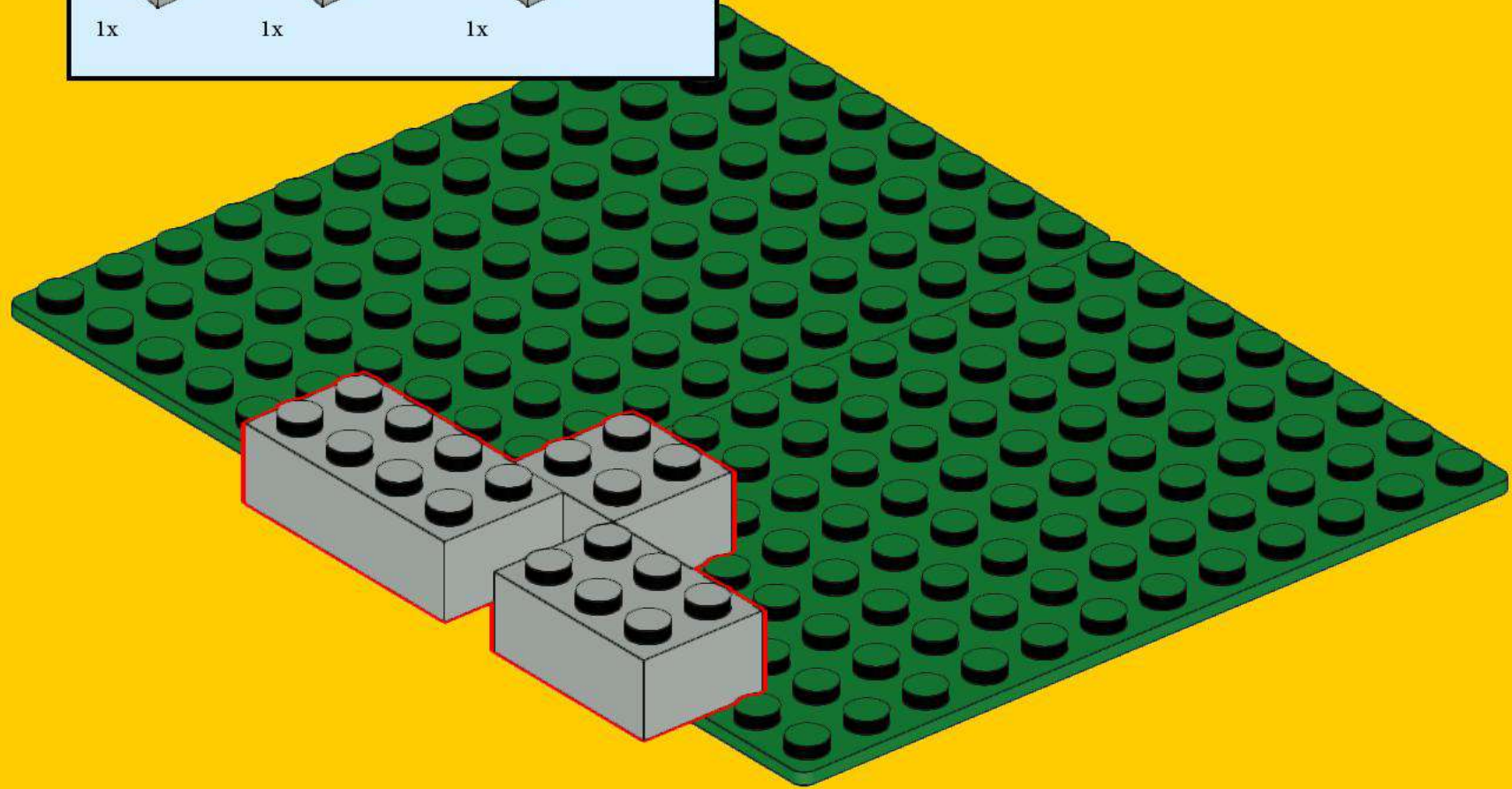
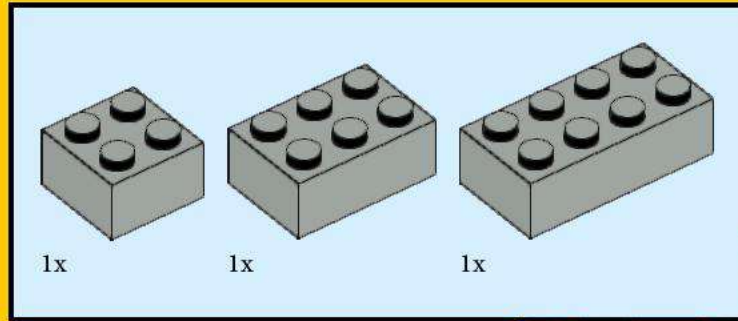

140

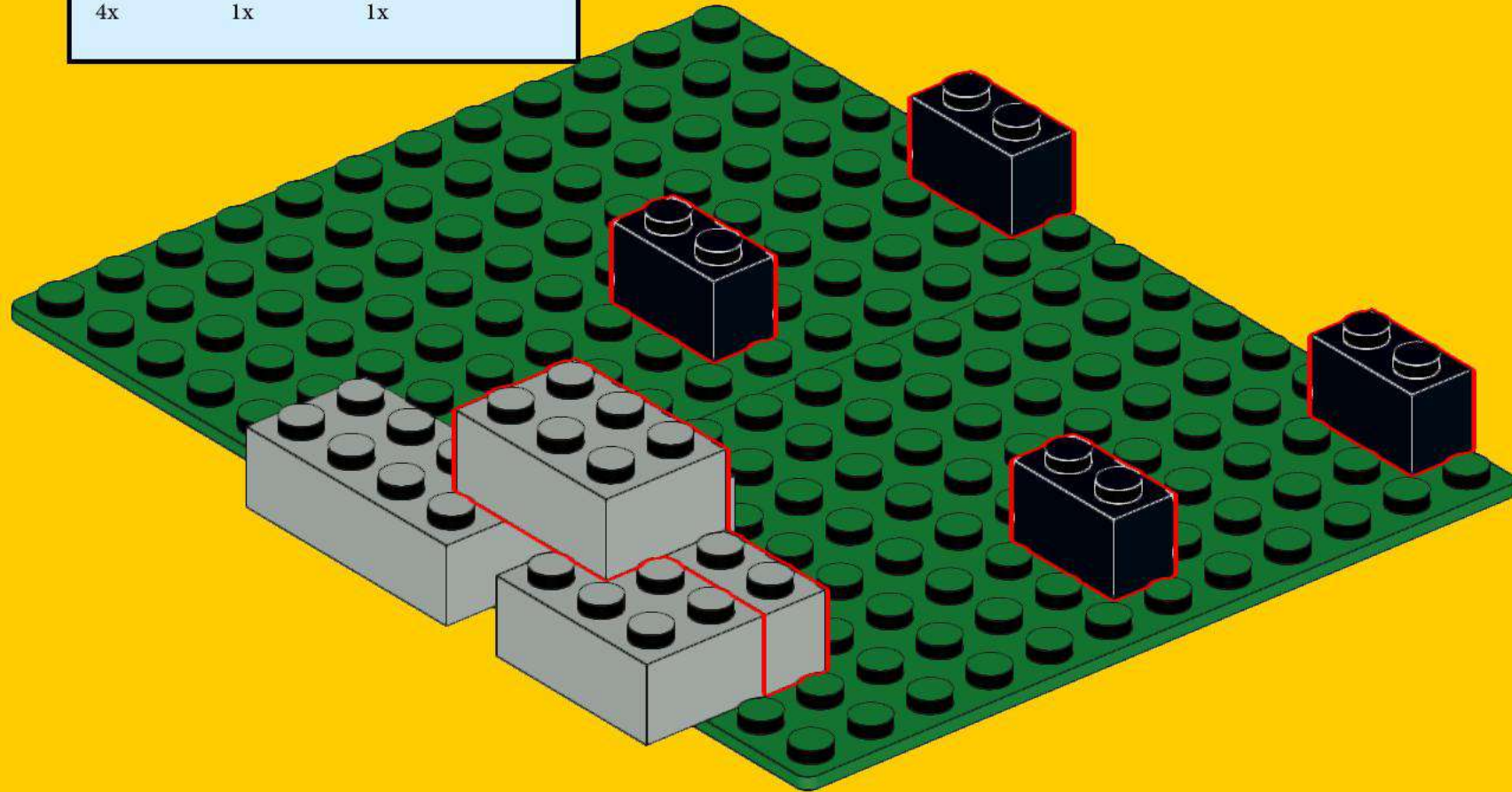
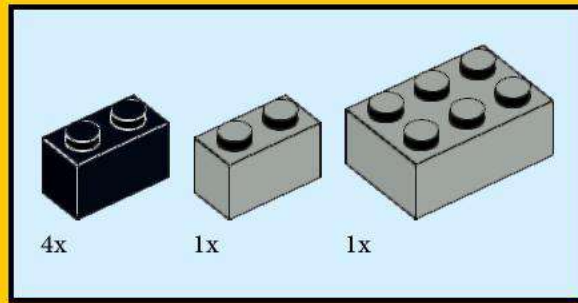

141

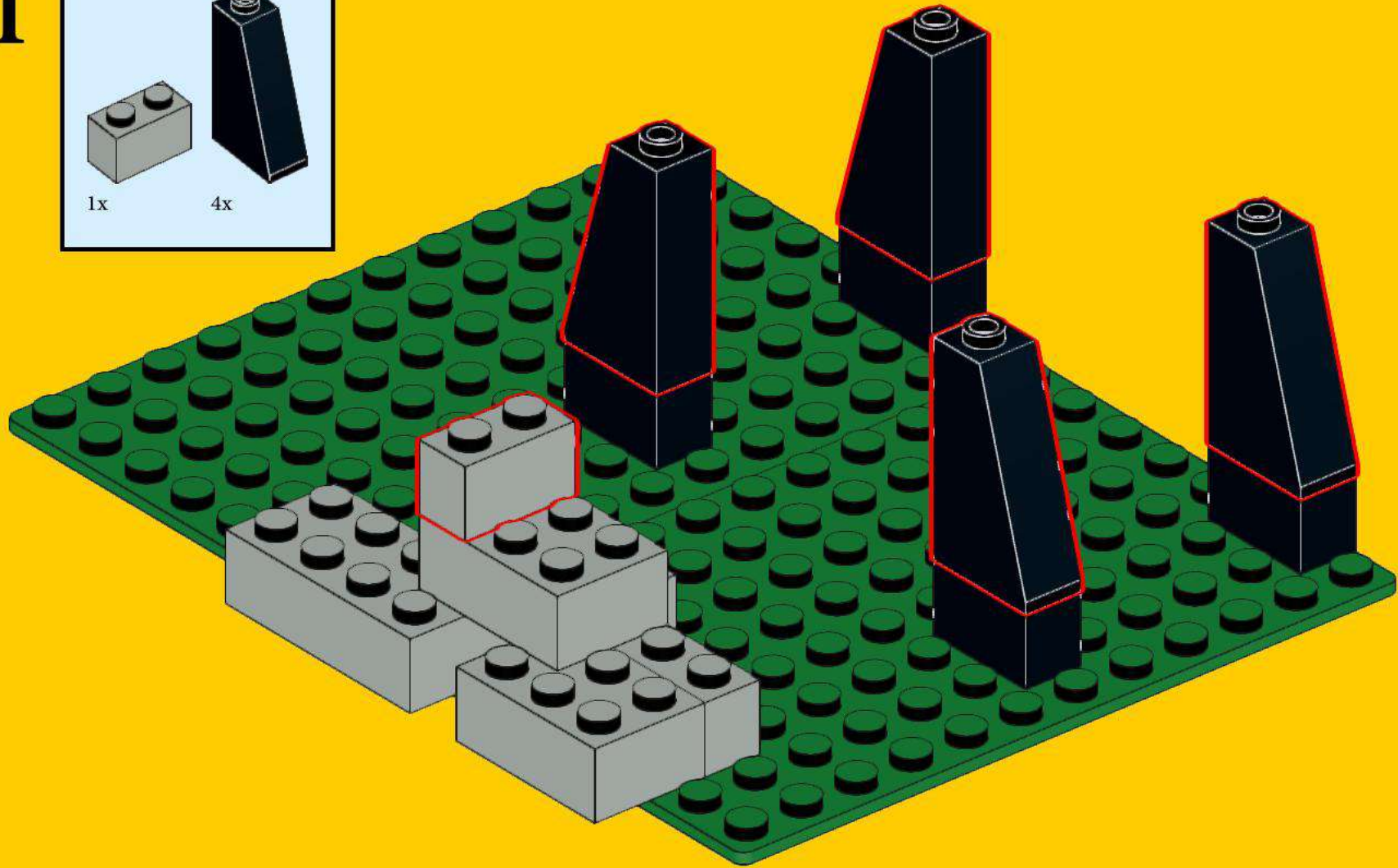
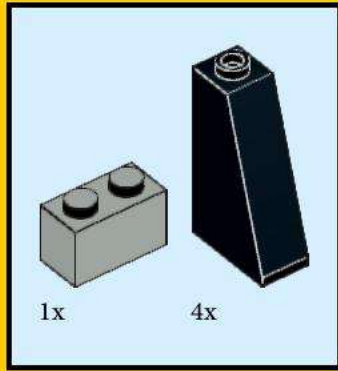

142

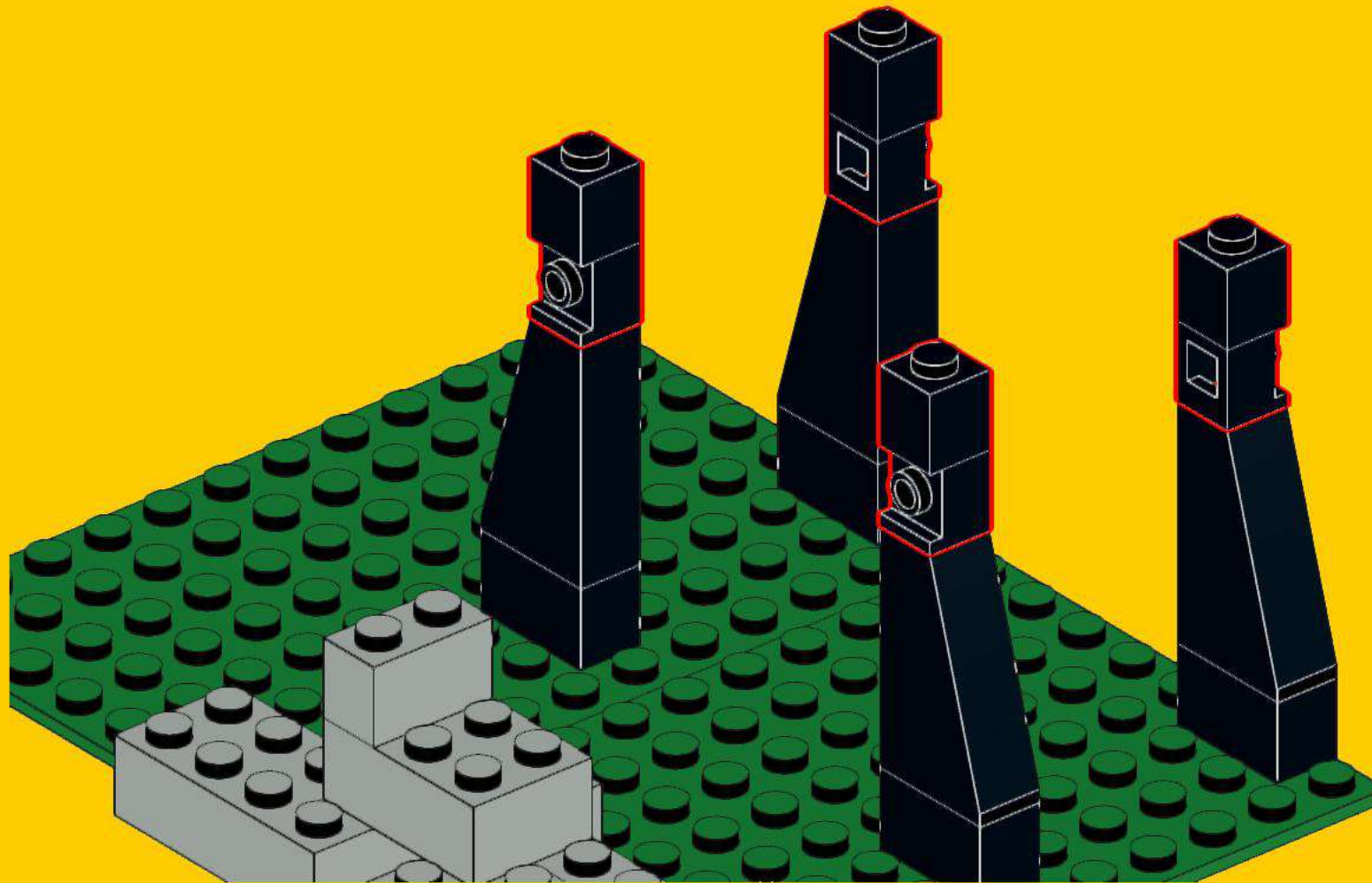
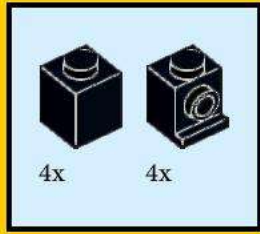

143

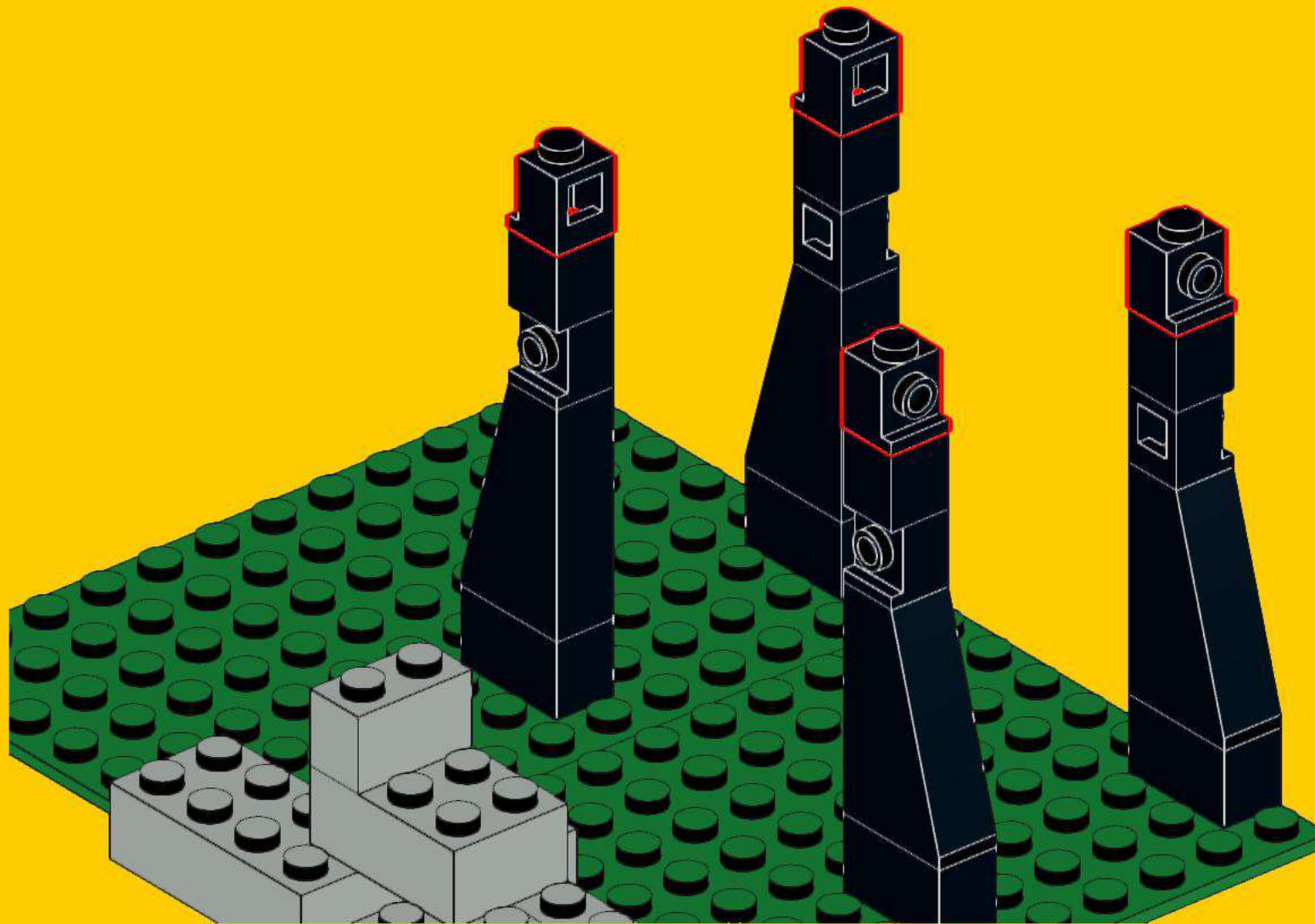

144

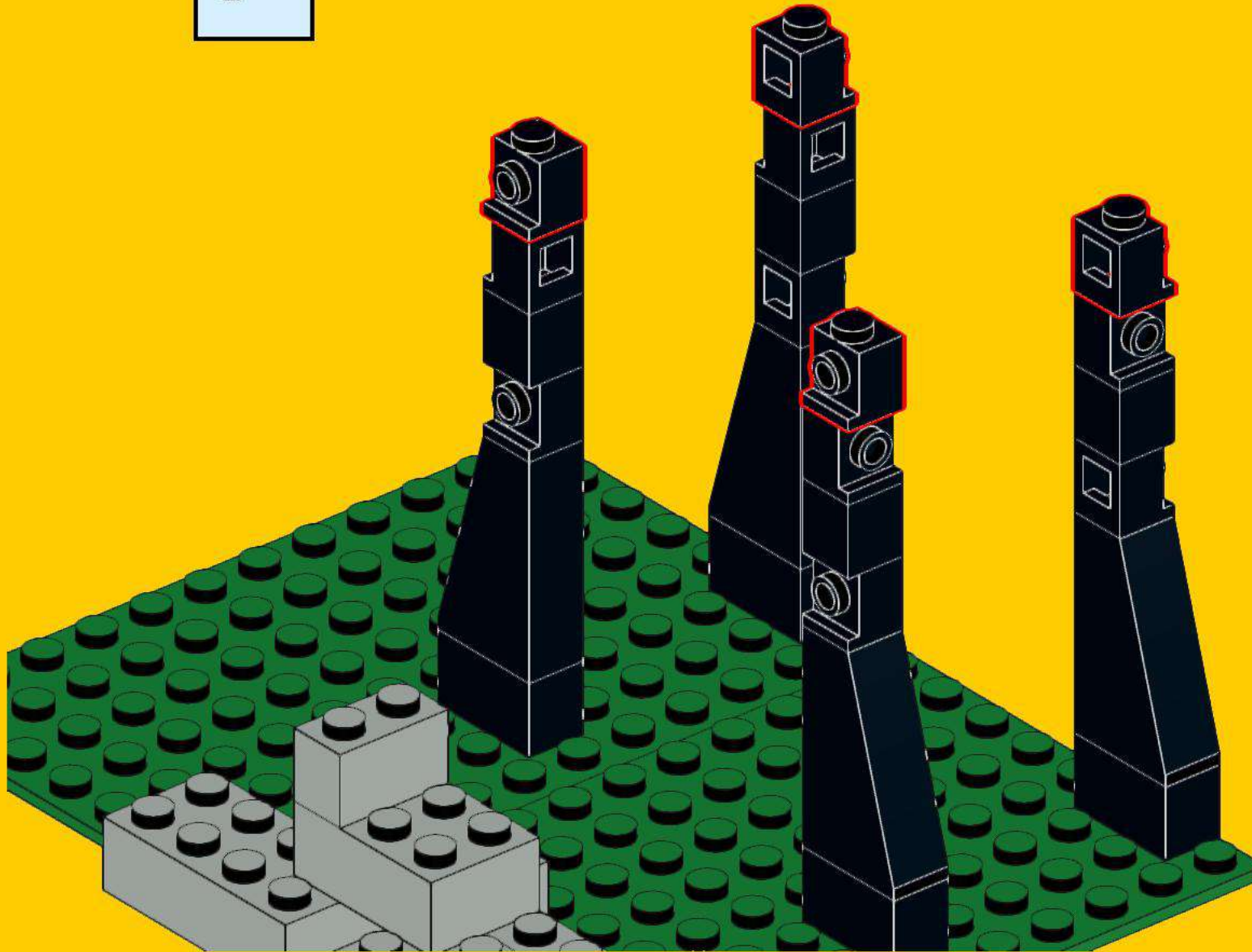

145

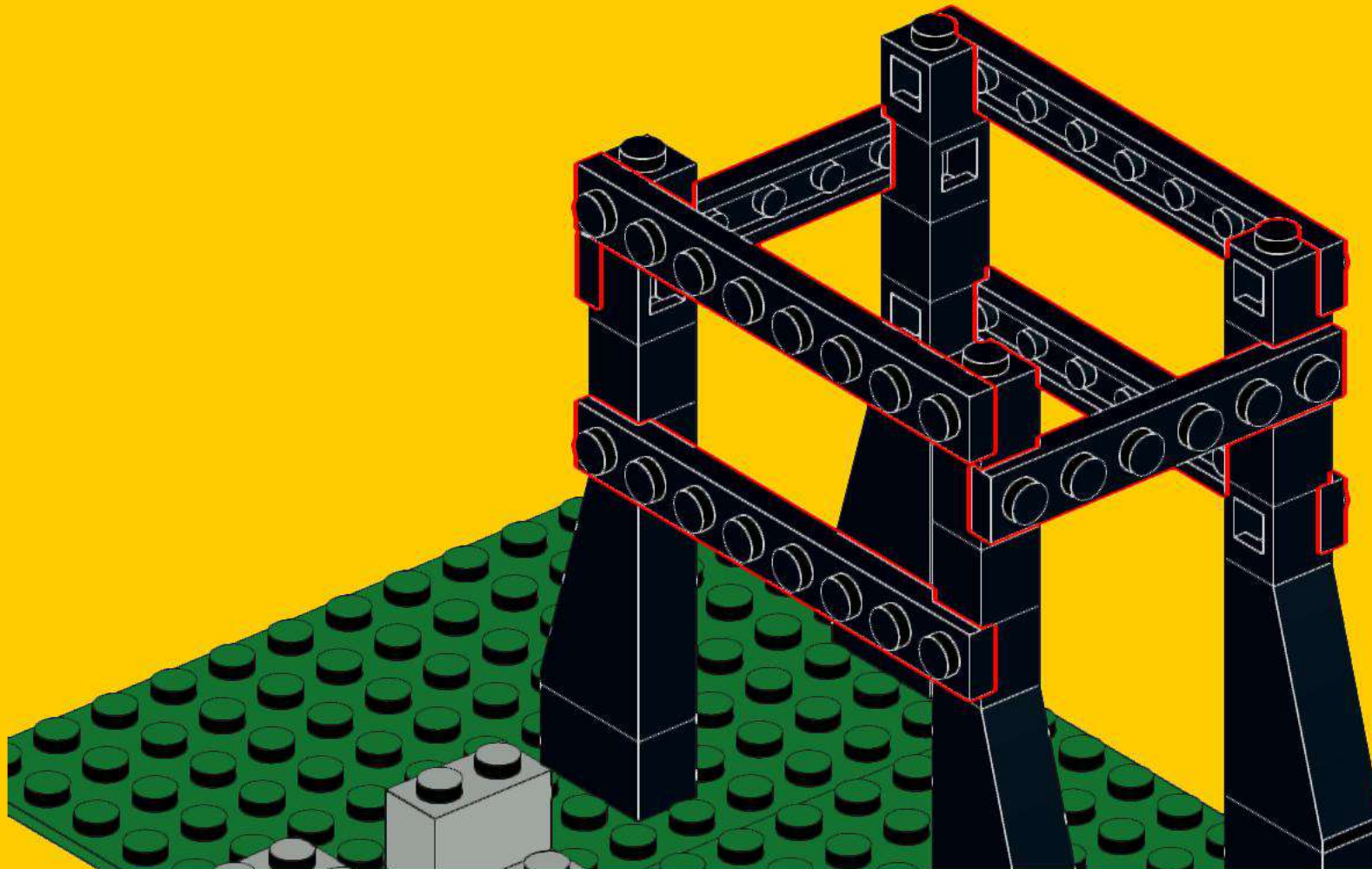
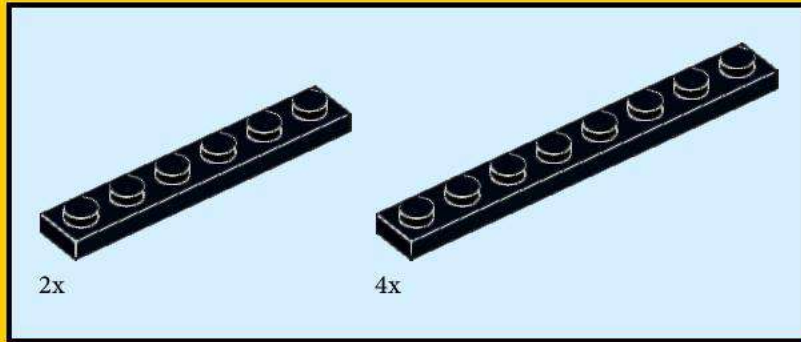

146

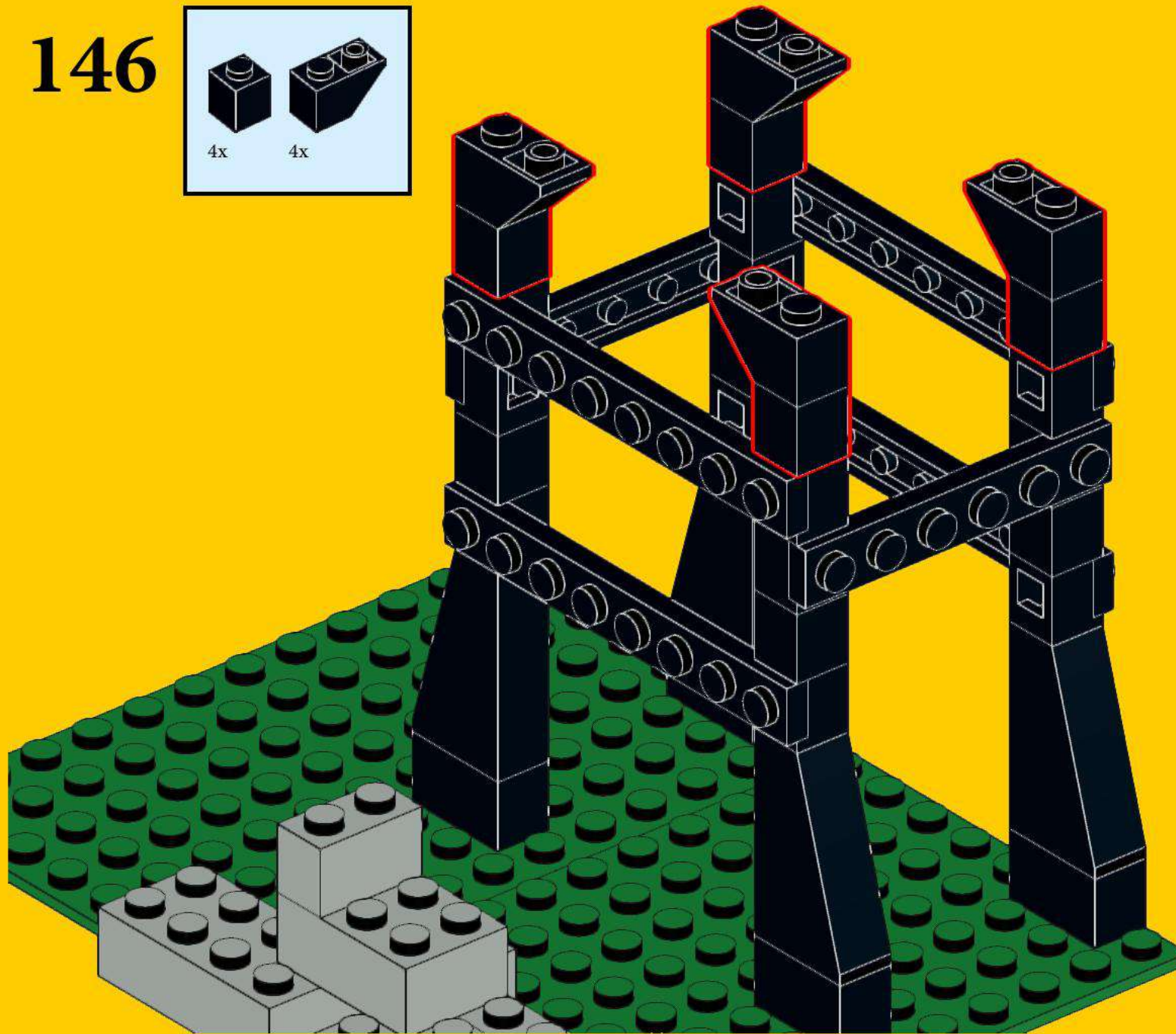
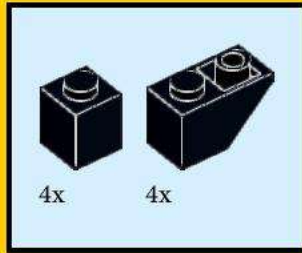

147

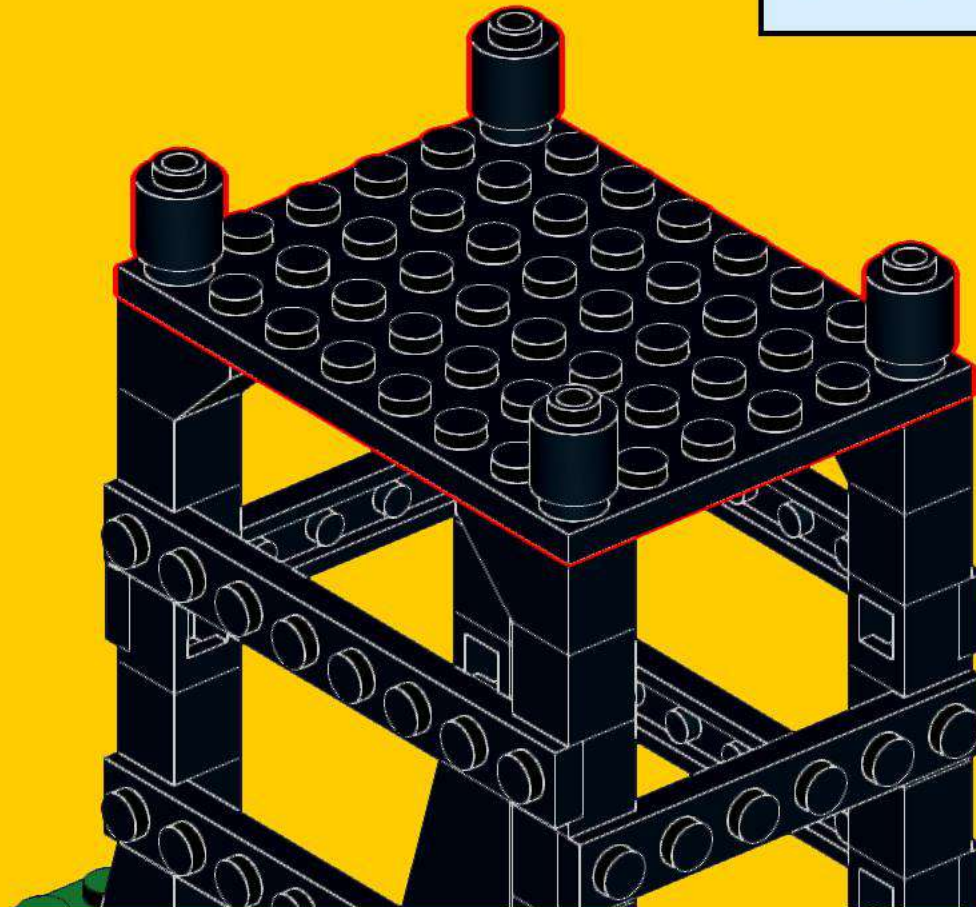
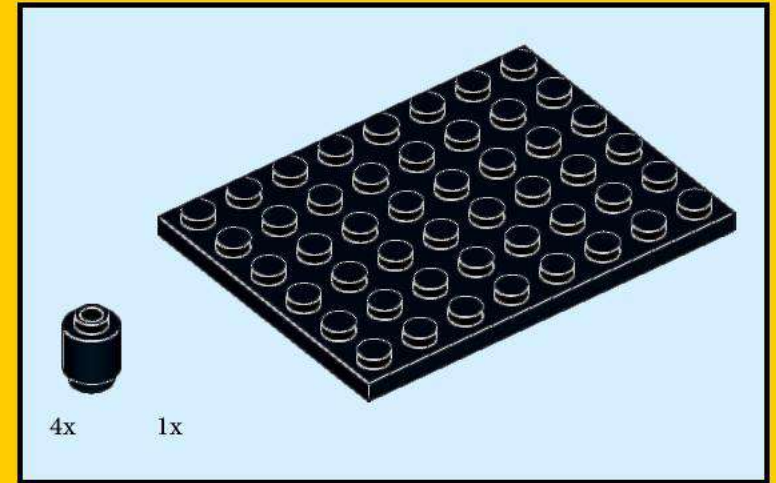

148

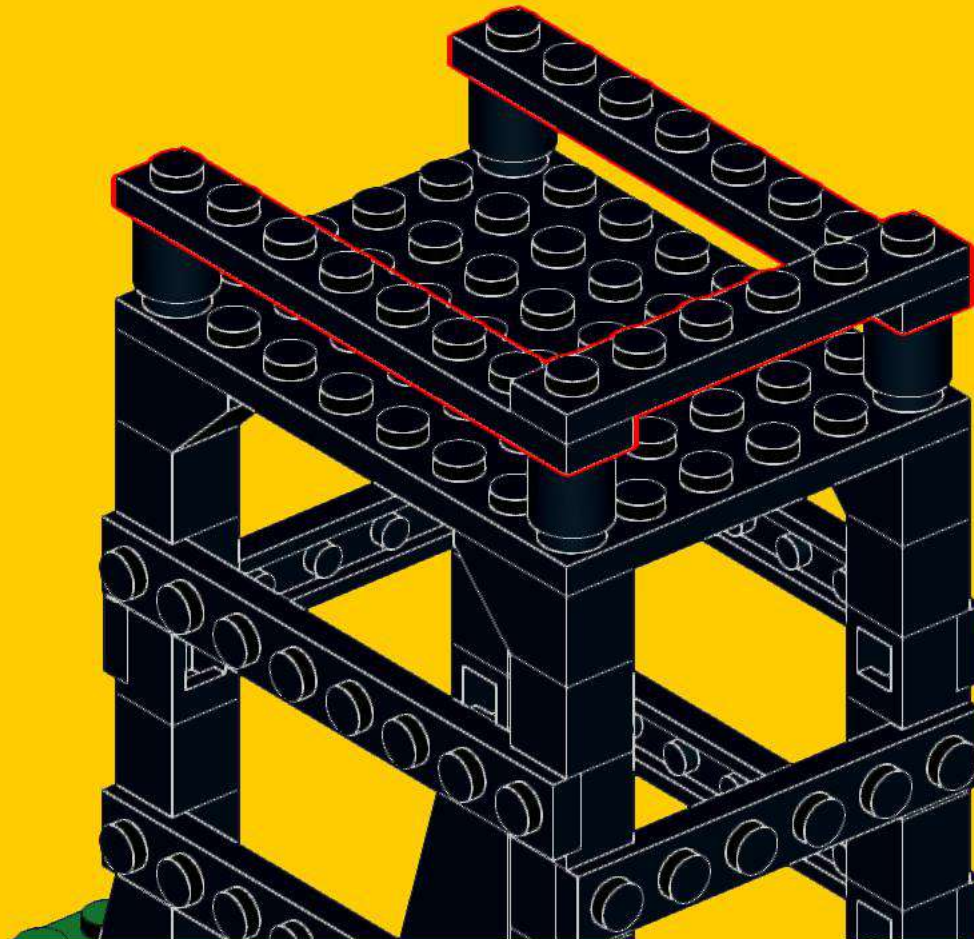
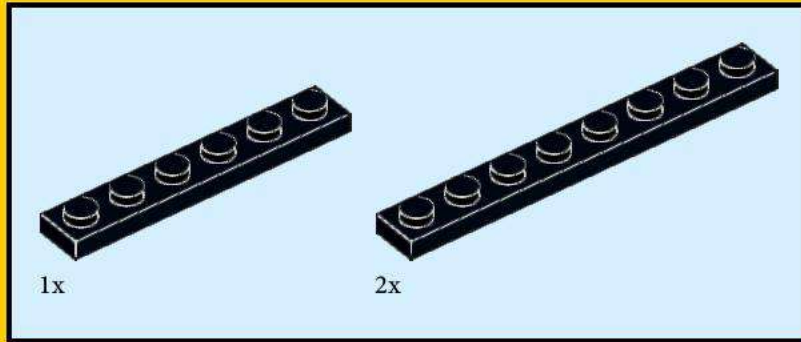

149

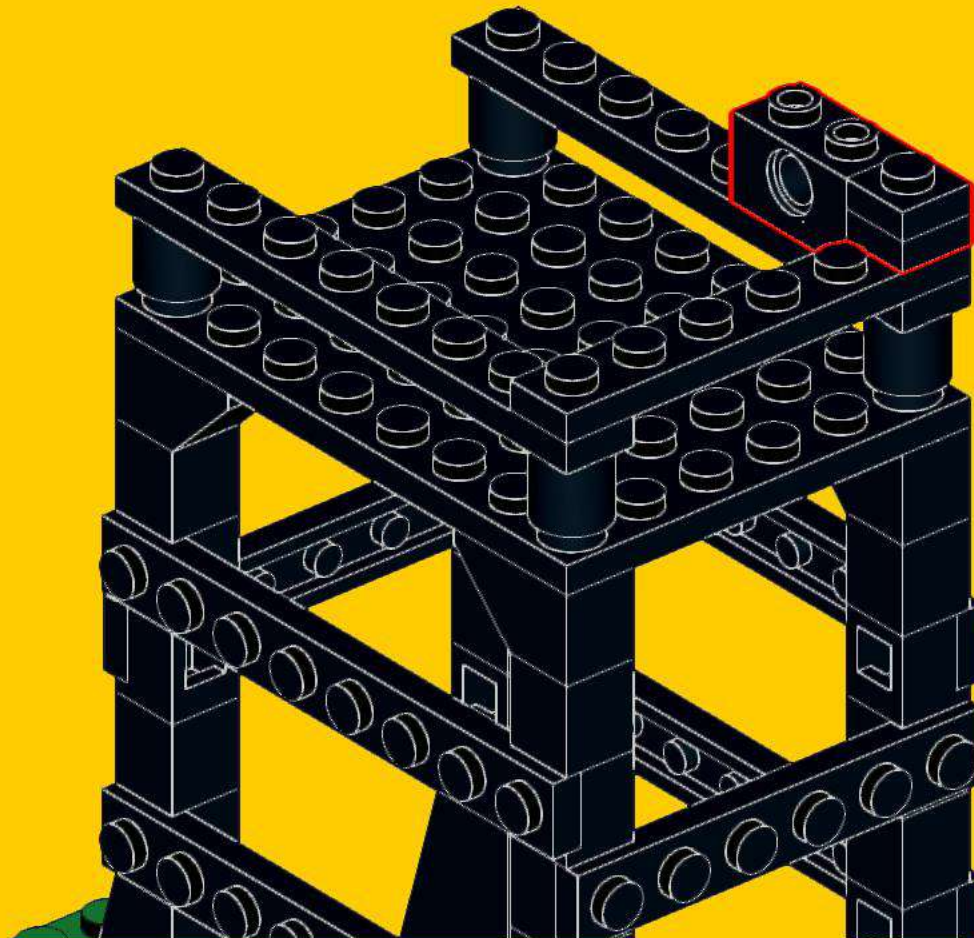
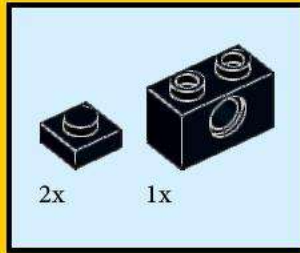

150

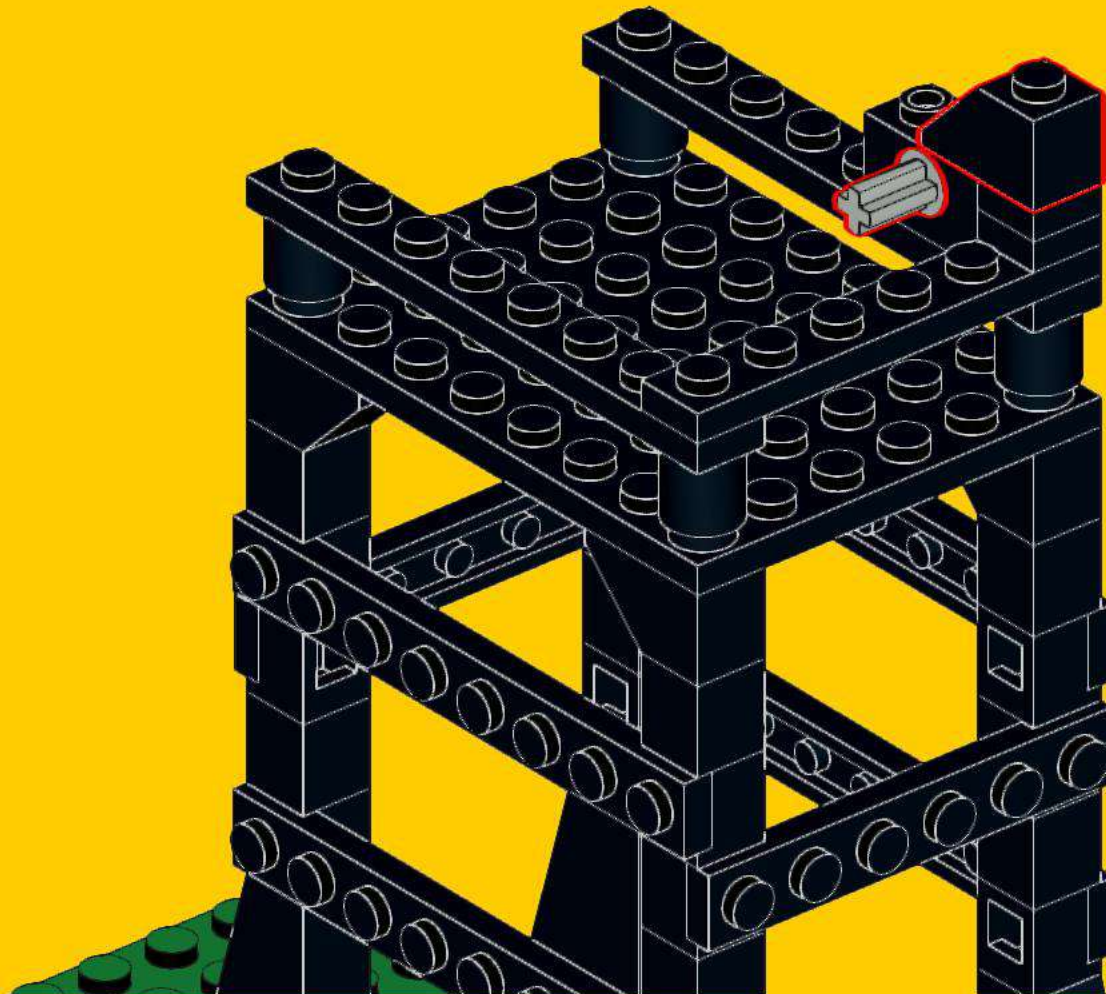
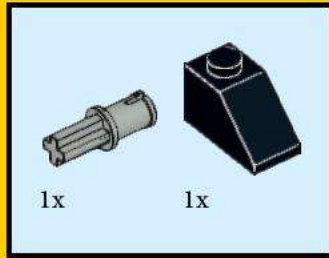

151

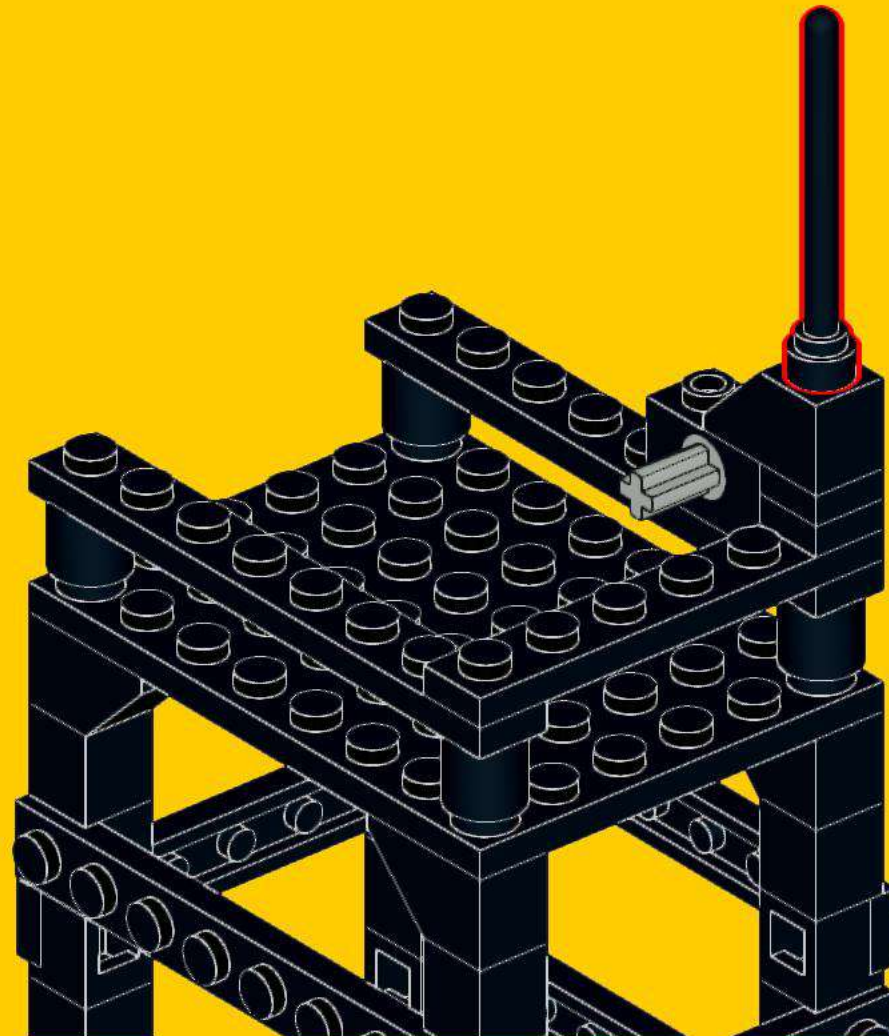

152

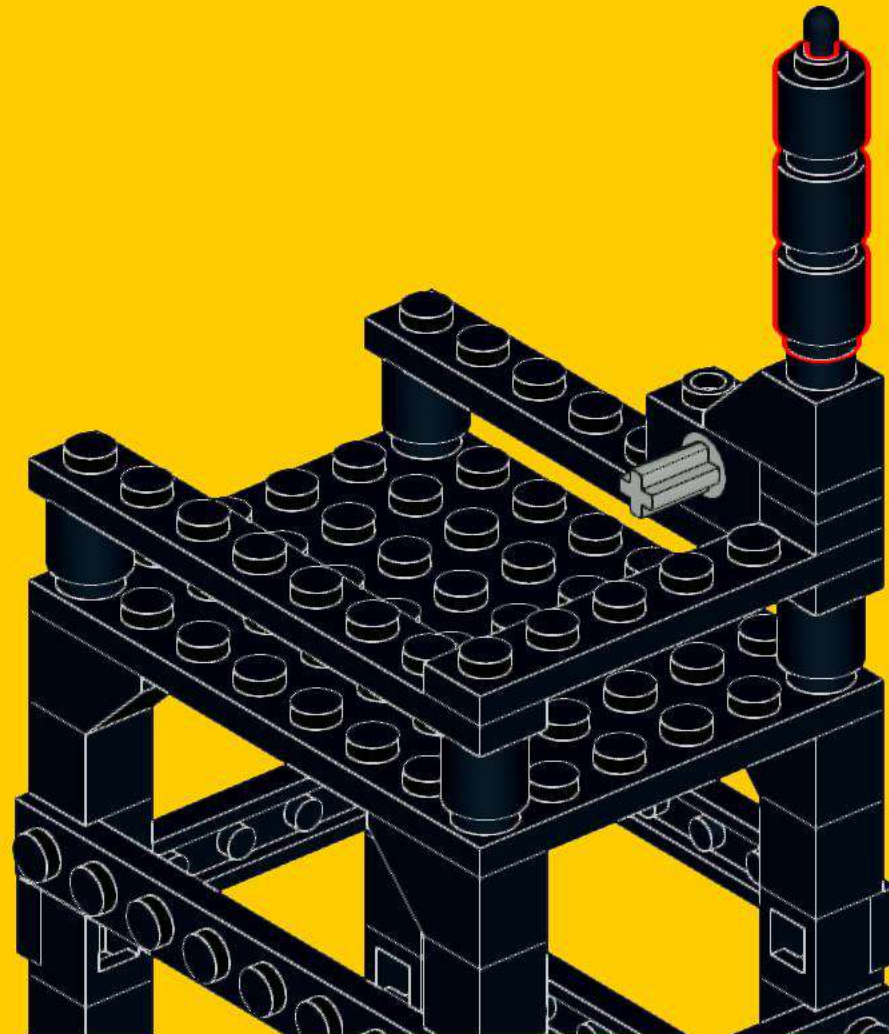

153

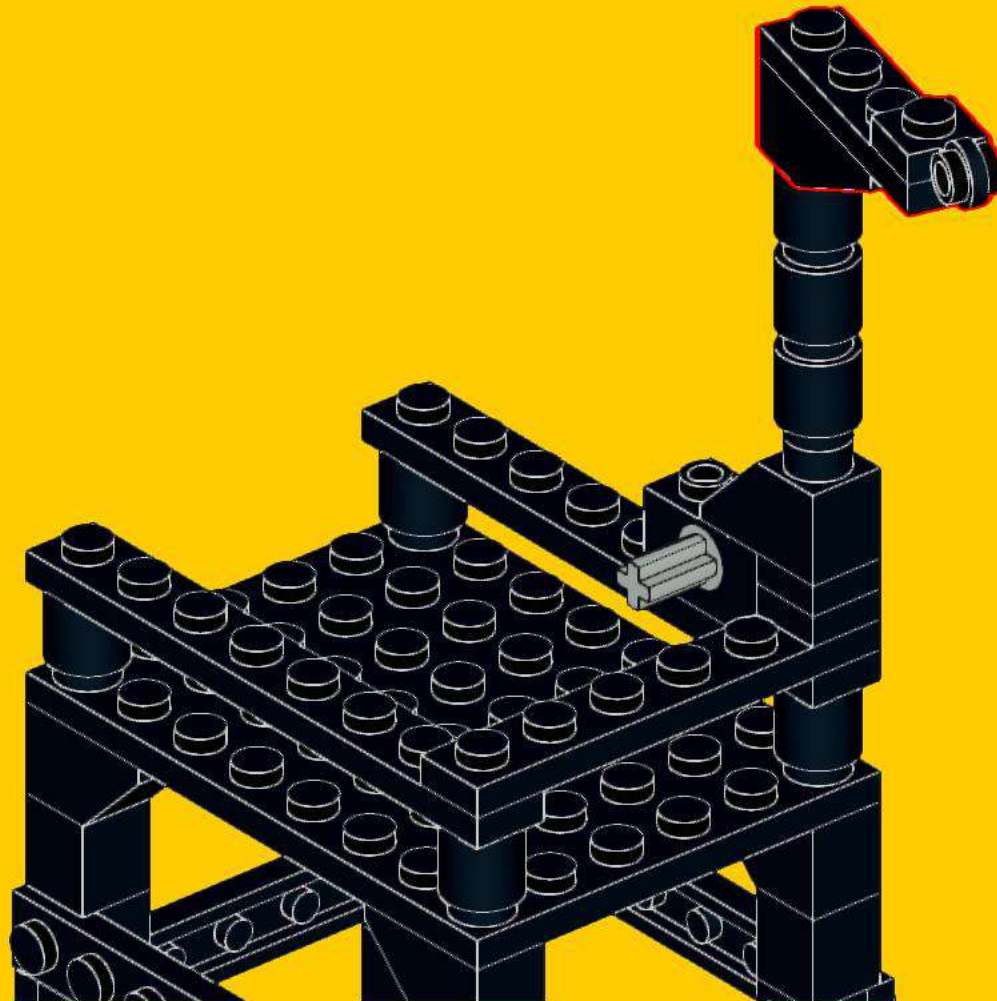
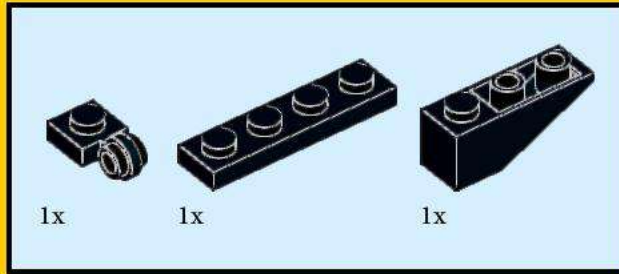

154

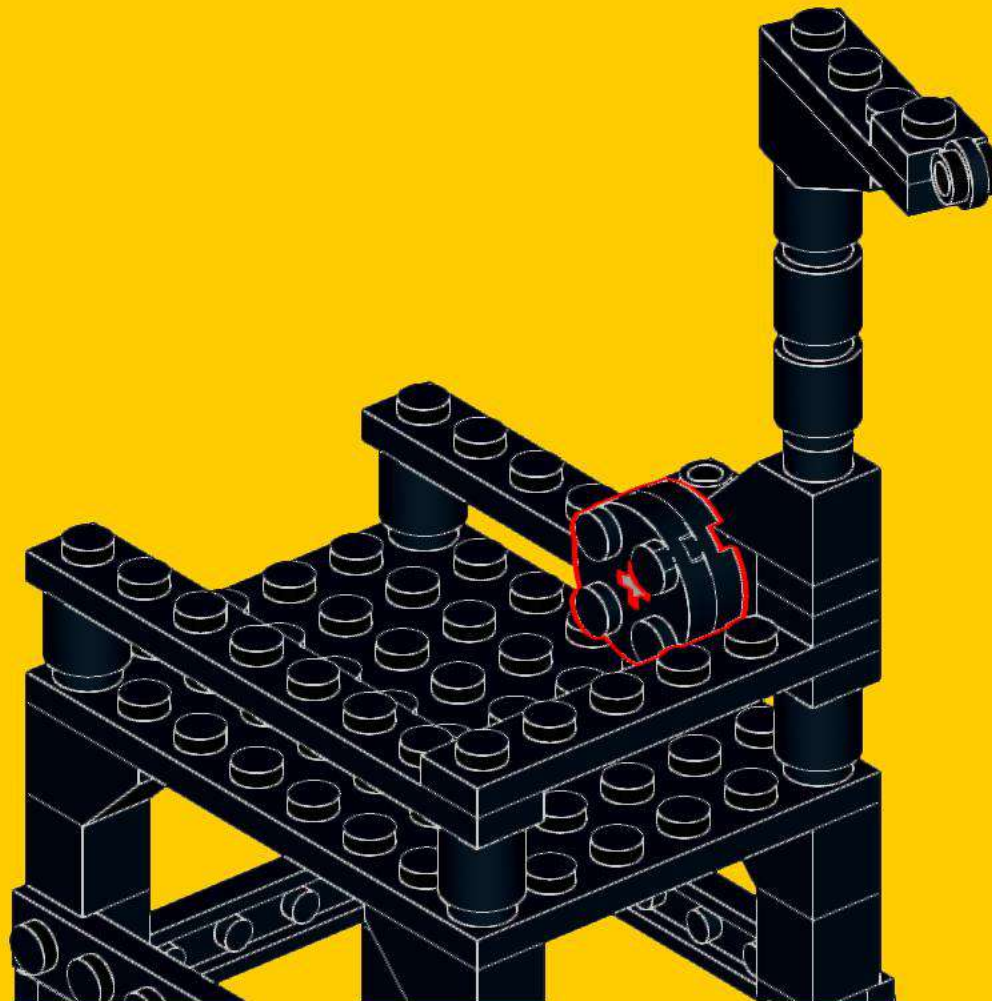
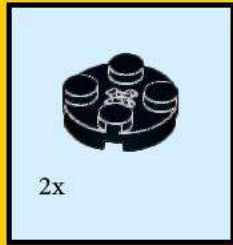

155

Block a rope between the 2 plate round
2x2 and pass it trough the plate 1x1
modified



156

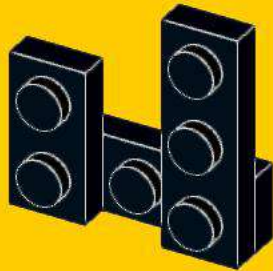
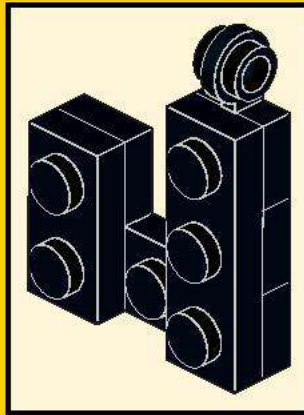
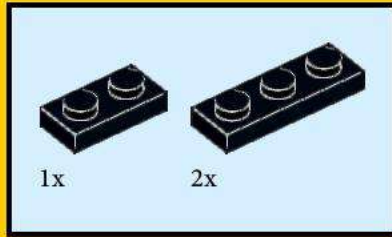

157

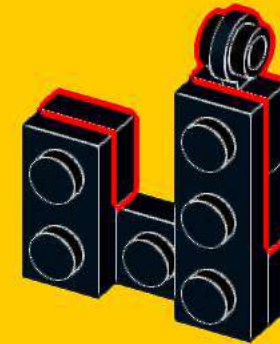
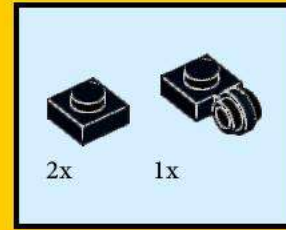

158

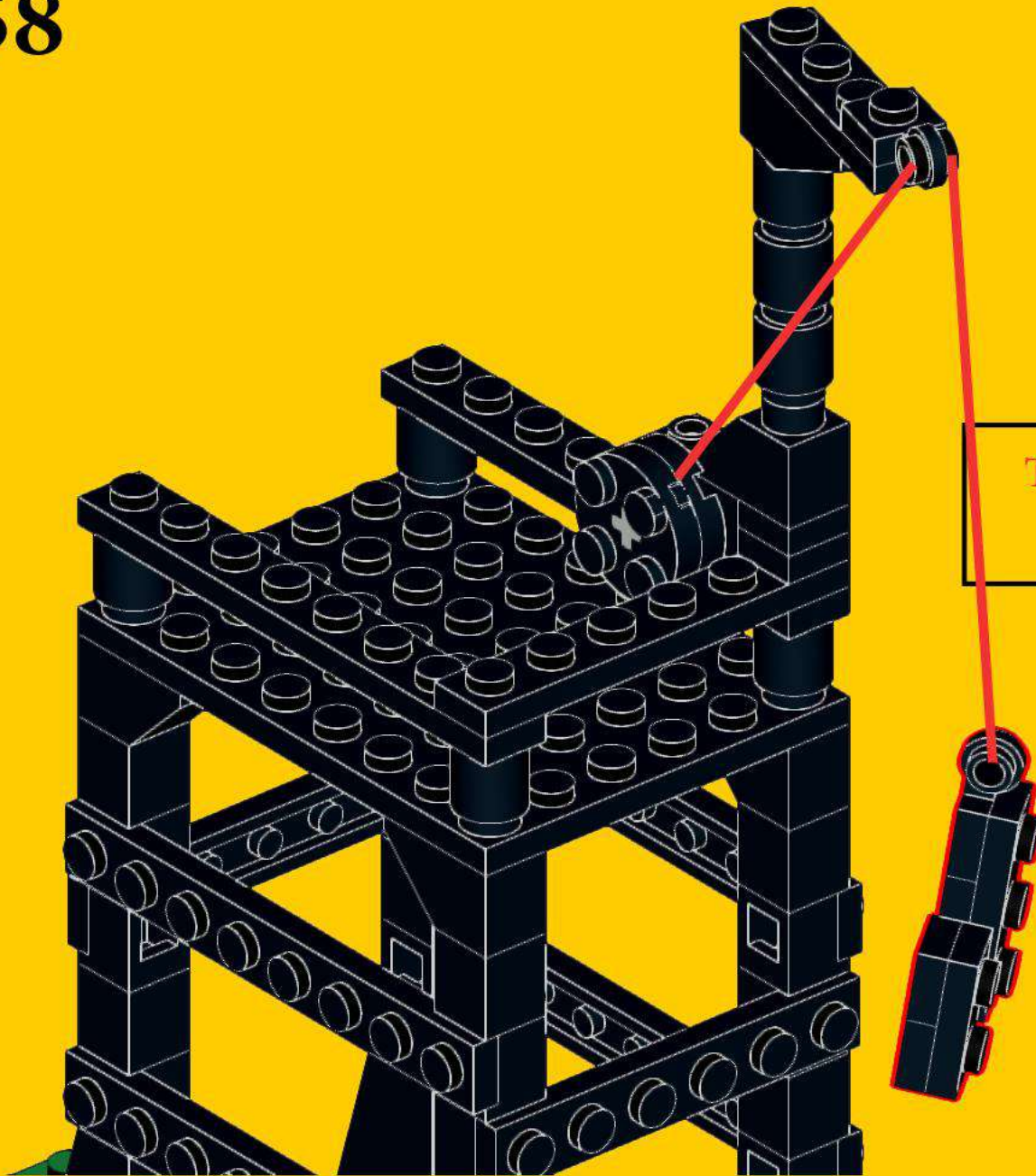

Tie the rope to the newly built lego hook



159



160



161

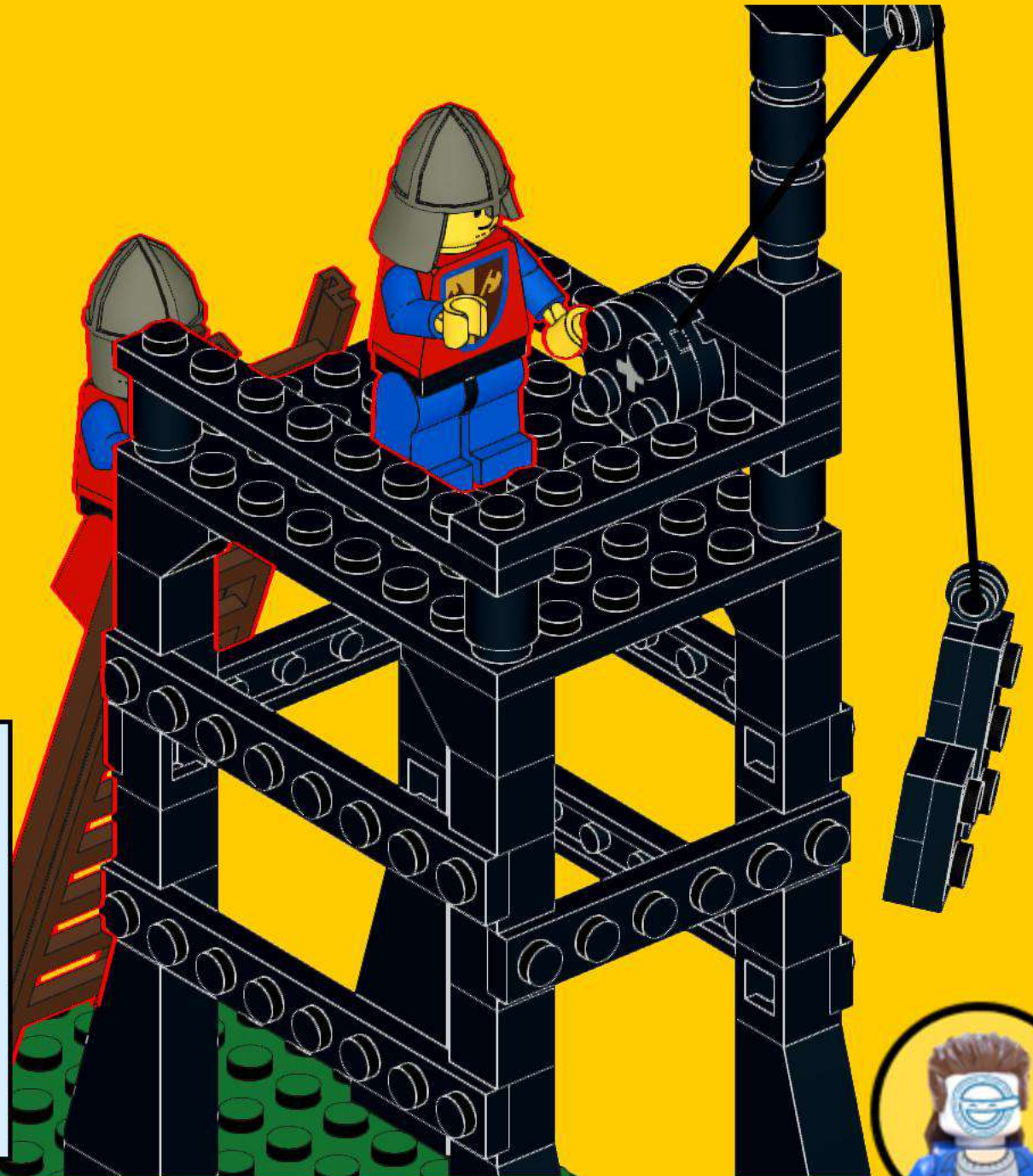
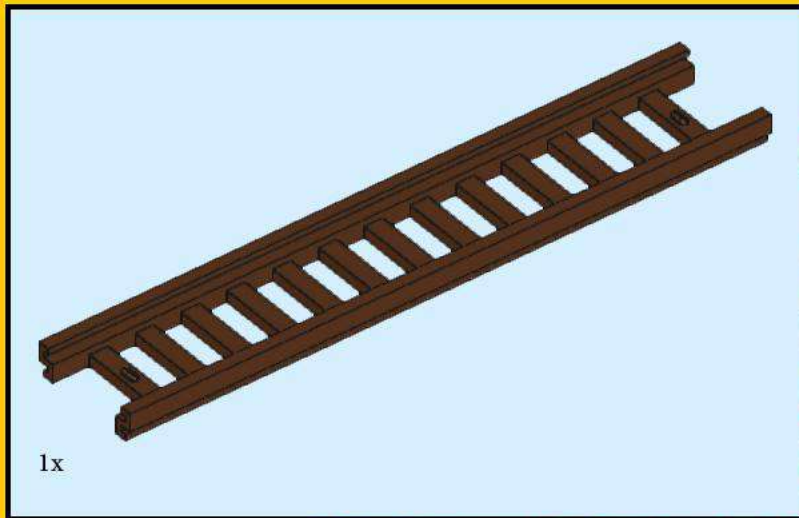

162

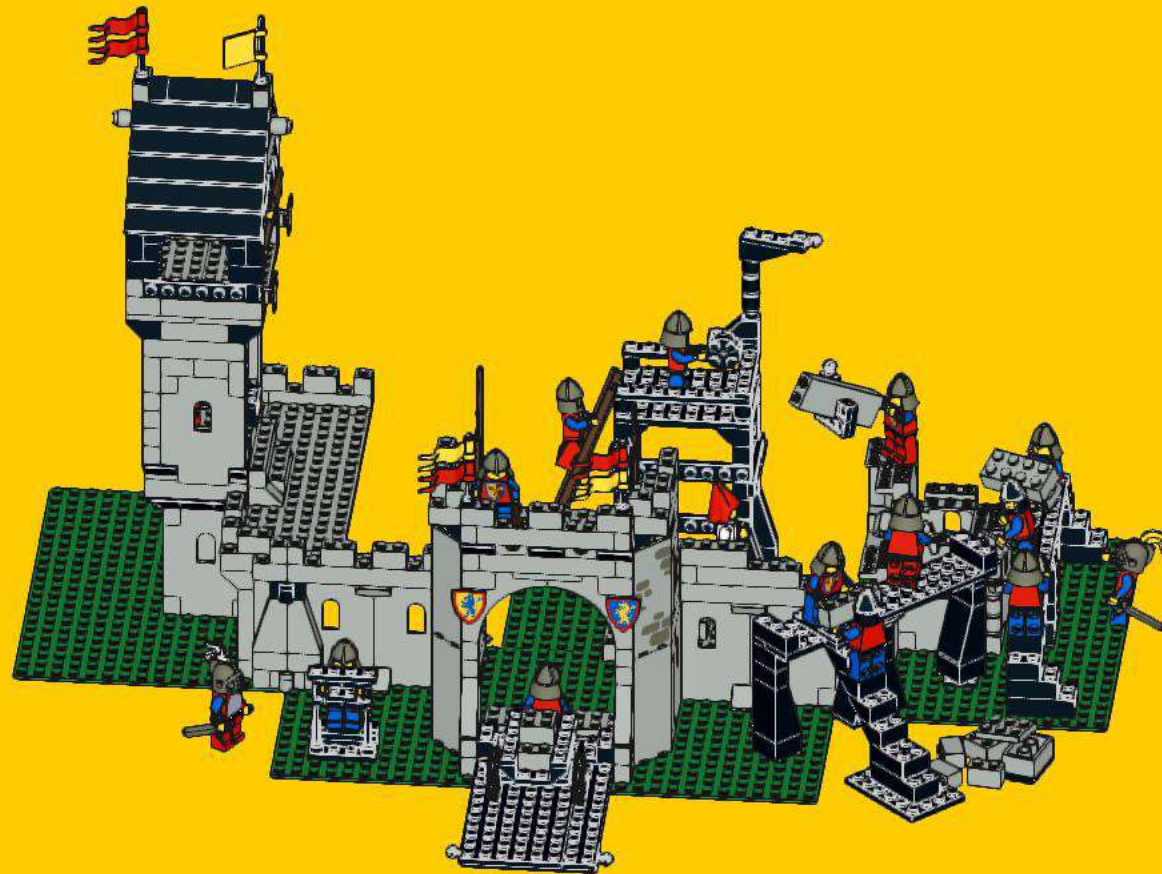
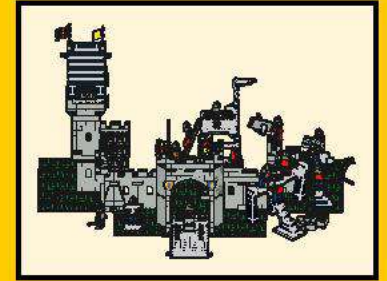

163

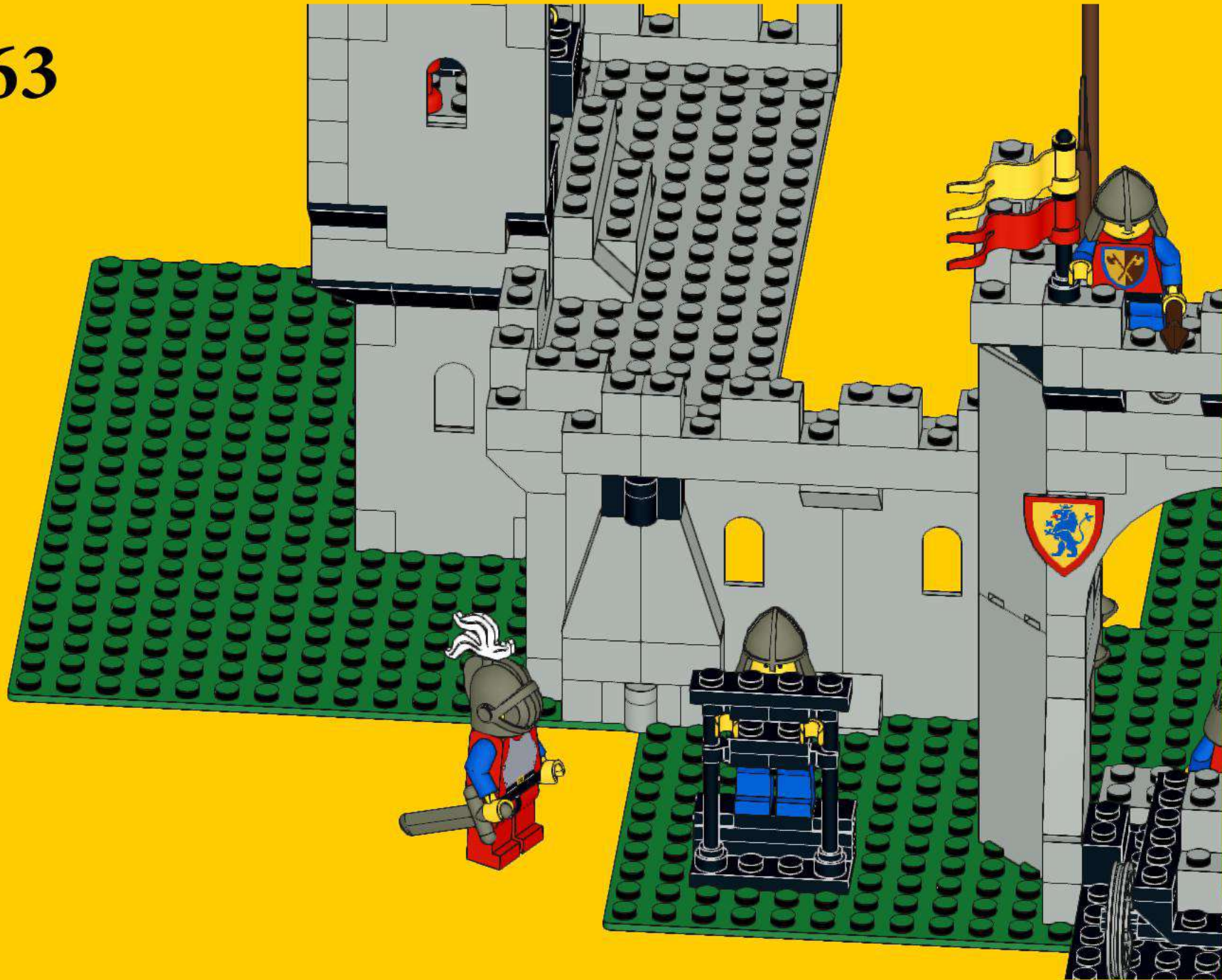

164

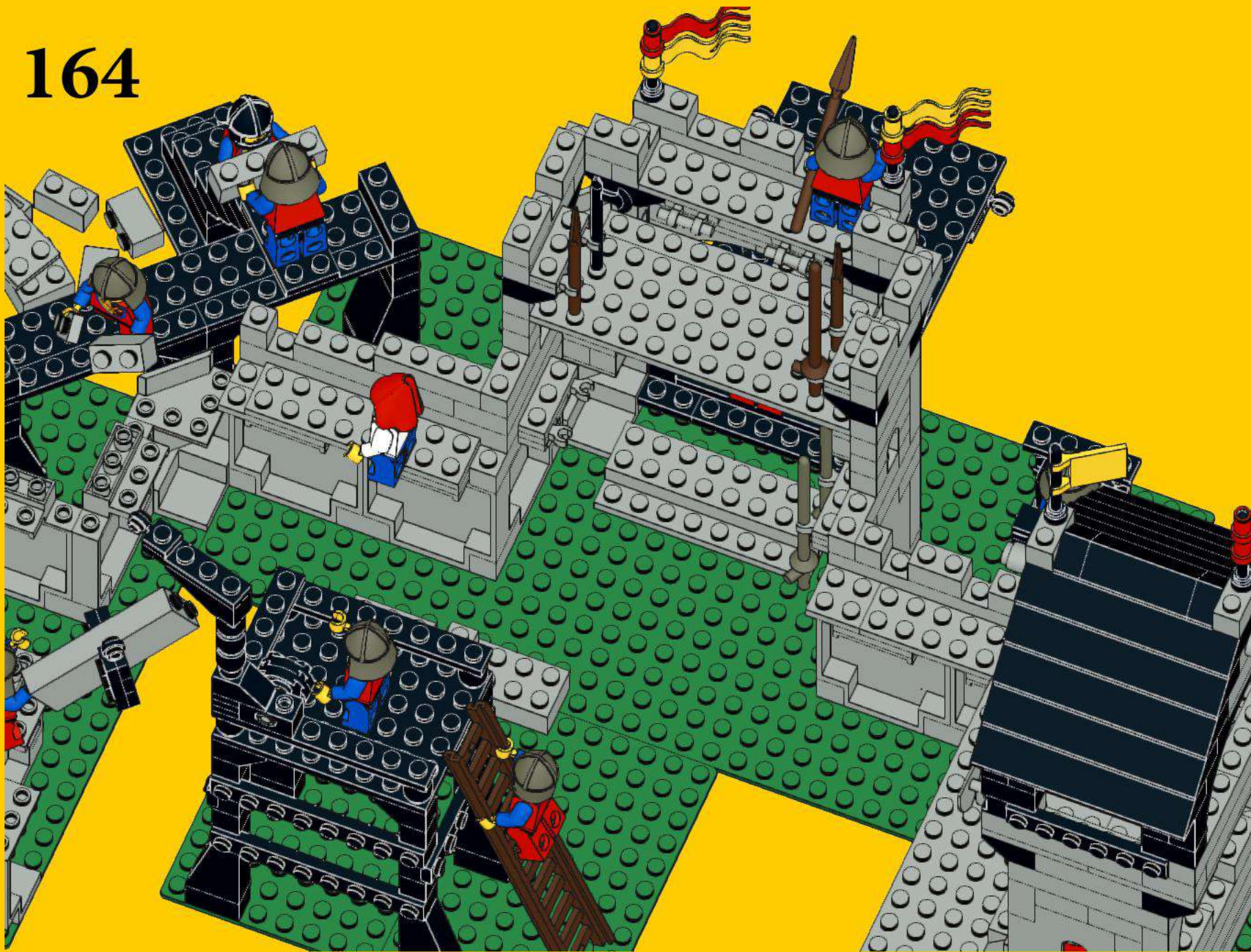

- 2x 3070b, 11
- 2x 3749, 11
- 15x 970, 11
- 2x 3896, 11
- 2x 3039, 11
- 1x 3021, 11
- 1x 3041, 11
- 1x 4854, 11
- 4x 2339, 11
- 4x 3024, 11
- 4x 4081a, 11
- 14x 3004, 11
- 1x 3830, 11
- 1x 3831, 11
- 1x 3839b, 11
- 3x 3001, 11
- 8x 3666, 11
- 1x 3022, 11
- 2x 2458, 11
- 2x 3623, 11
- 3x 3002, 11
- 1x 982, 11
- 2x 3044b, 11
- 1x 3680, 11
- 2x 2458, 11
- 2x 3623, 11
- 3x 3002, 11
- 1x 982, 11
- 2x 3044b, 11
- 1x 3680, 11
- 2x 2458, 11
- 2x 3623, 11
- 3x 3002, 11
- 14x 4070, 11
- 17x 3665, 11
- 1x 3680, 11
- 2x 2458, 11
- 2x 3623, 11
- 3x 3002, 11
- 7x 3062b, 11
- 2x 4032, 11
- 2x 3676, 11
- 1x 4287, 11
- 4x 3710, 11
- 1x 3848, 11
- 1x 3848, 11
- 9x 3460, 11
- 1x 3700, 11
- 2x 2444, 11
- 24x 3660, 11
- 2x 2341, 11
- 4x 4460b, 11
- 4x 3684a, 11
- 1x 3848, 11
- 1x 3848, 11
- 9x 3460, 11
- 1x 981, 11
- 1x 3700, 11
- 2x 2444, 11
- 24x 3660, 11
- 2x 2341, 11
- 4x 4460b, 11
- 4x 3684a, 11
- 1x 981, 11
- 1x 3700, 11
- 2x 2444, 11
- 24x 3660, 11
- 2x 2341, 11
- 4x 4460b, 11
- 4x 3684a, 11
- 4x 4085d, 11
- 1x 3040, 11
- 9x 3003, 11
- 2x 3622, 11
- 5x 3020, 11
- 7x 3957, 11
- 3x 3795, 11
- 1x 3034, 11



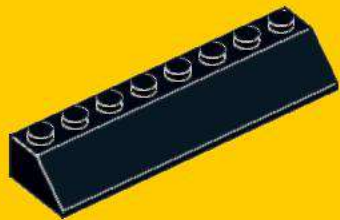

10x
4445, 11

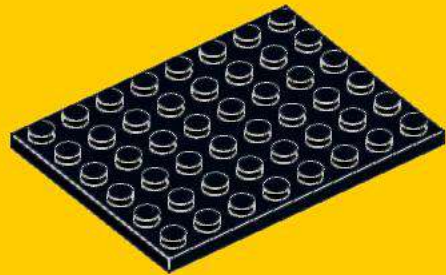

1x
3036, 11

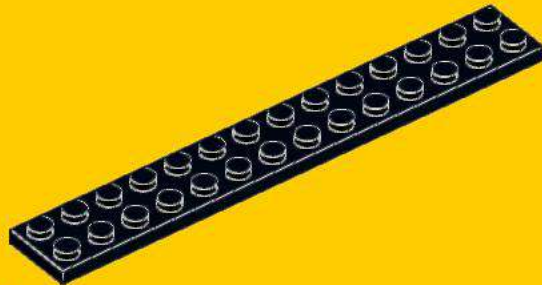

1x
91988, 11



1x
3456, 11

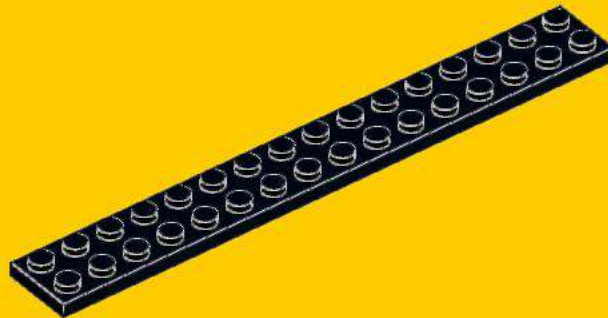

1x
4282, 11



1x
3896, 10



2x
x167, 10



11x
3844, 10

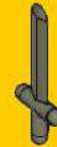

2x
3847, 10

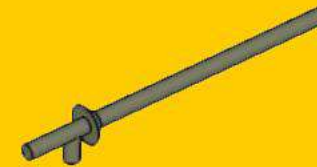

2x
3849, 10



5x
3024, 9



10x
3062b, 9



28x
3005, 9



6x
4070, 9

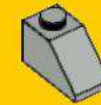

2x
3040, 9



8x
4085a, 9

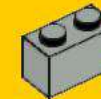

53x
3004, 9



1x
3749, 9



1x
970, 9



1x
972, 9



6x
3700, 9



1x
971, 9



8x
3665, 9



4x
3023, 9



2x
2540, 9



1x
3679, 9



1x
3022, 9



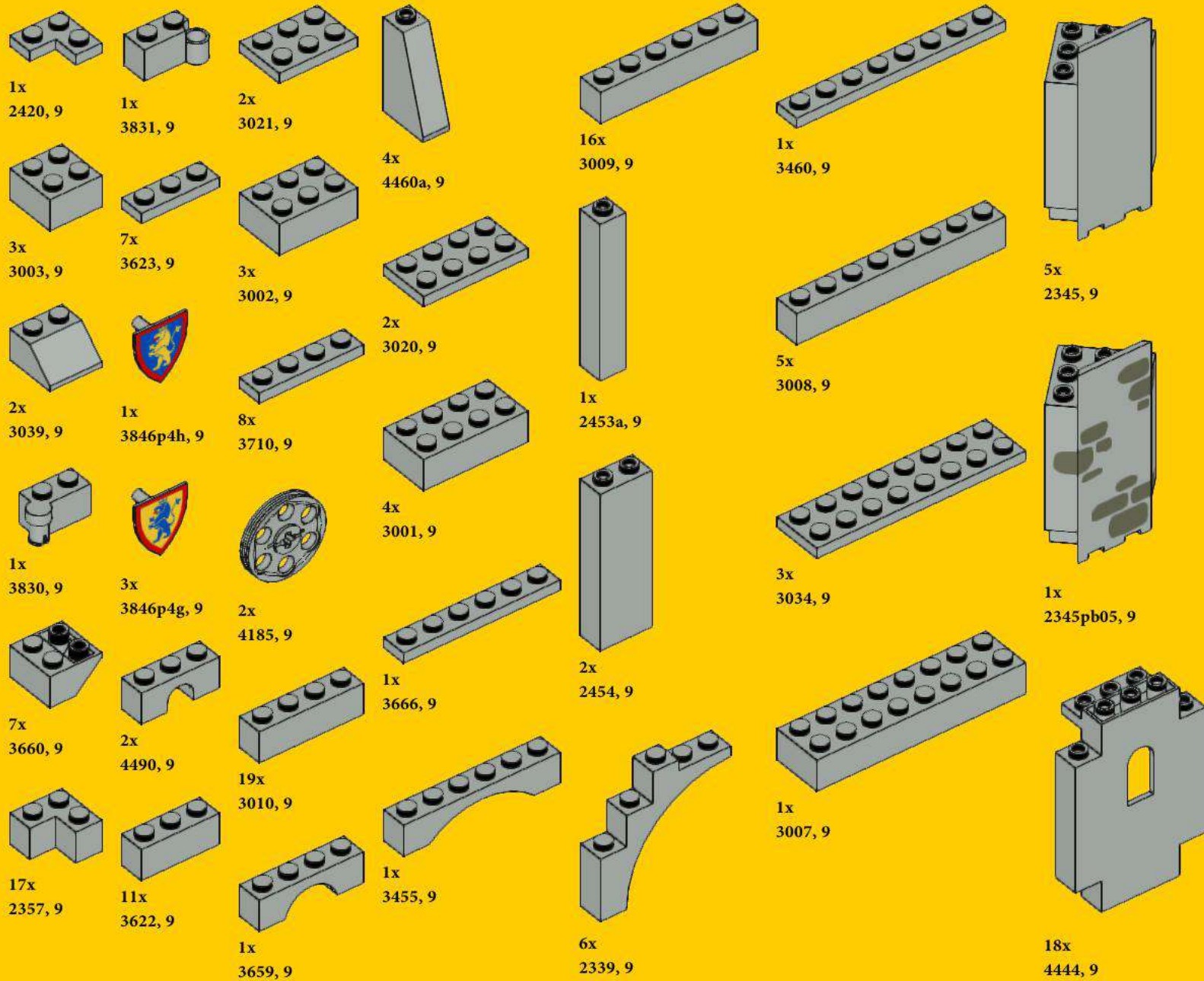

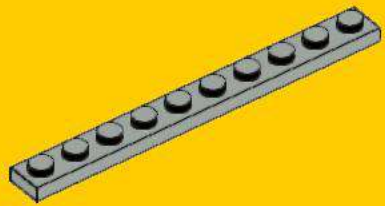

1x
4477, 9

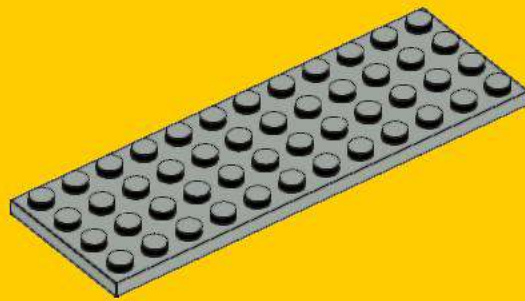

1x
3029, 9

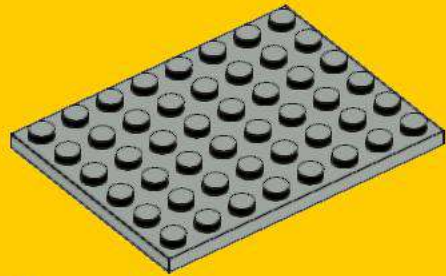

1x
3036, 9

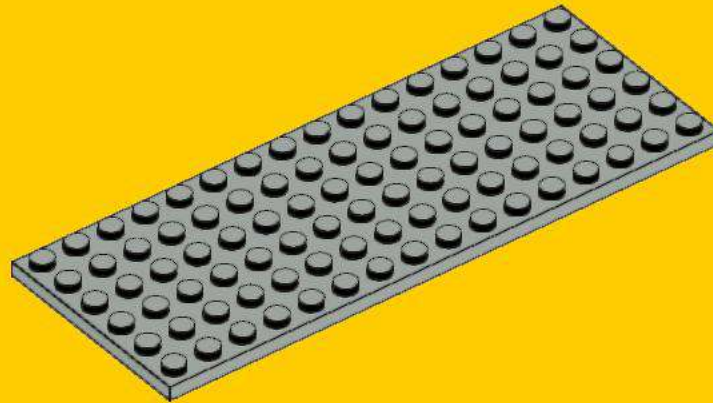

1x
3027, 9

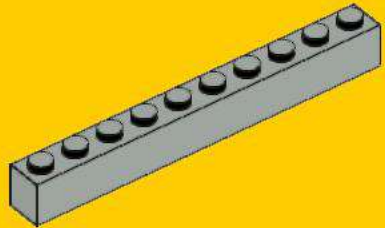

2x
6111, 9



1x
981, 1

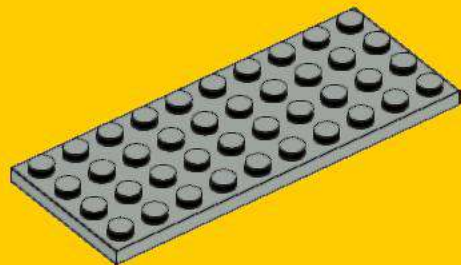

1x
982, 1

2x
3030, 9



1x
2343, 1



3x
973p40, 5



1x
4502b, 1



12x
973p42, 5



1x
973p71, 1



1x
x107, 5



6x
971, 5



4x
4495a, 5



6x
972, 5



1x
2343, 5



4x
4497, 8





1x
3849, 8



1x
4502c, 3

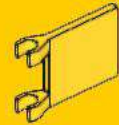

1x
2335, 3

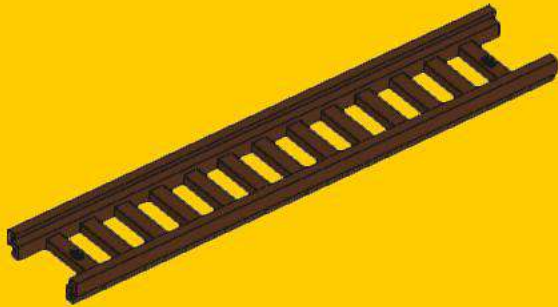

1x
4207, 8



2x
4495a, 3



34x
983, 3

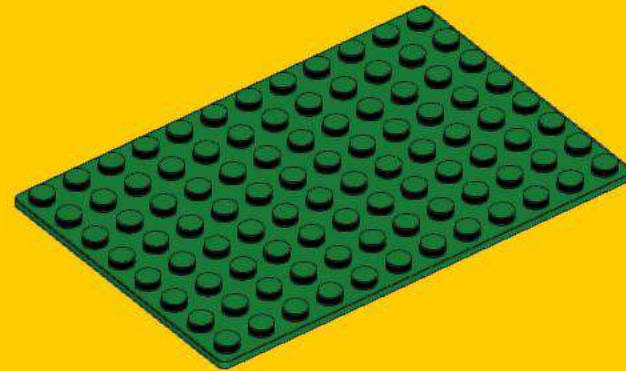

2x
bb0031, 6



16x
3626ap01, 3



1x
3626bp01, 3



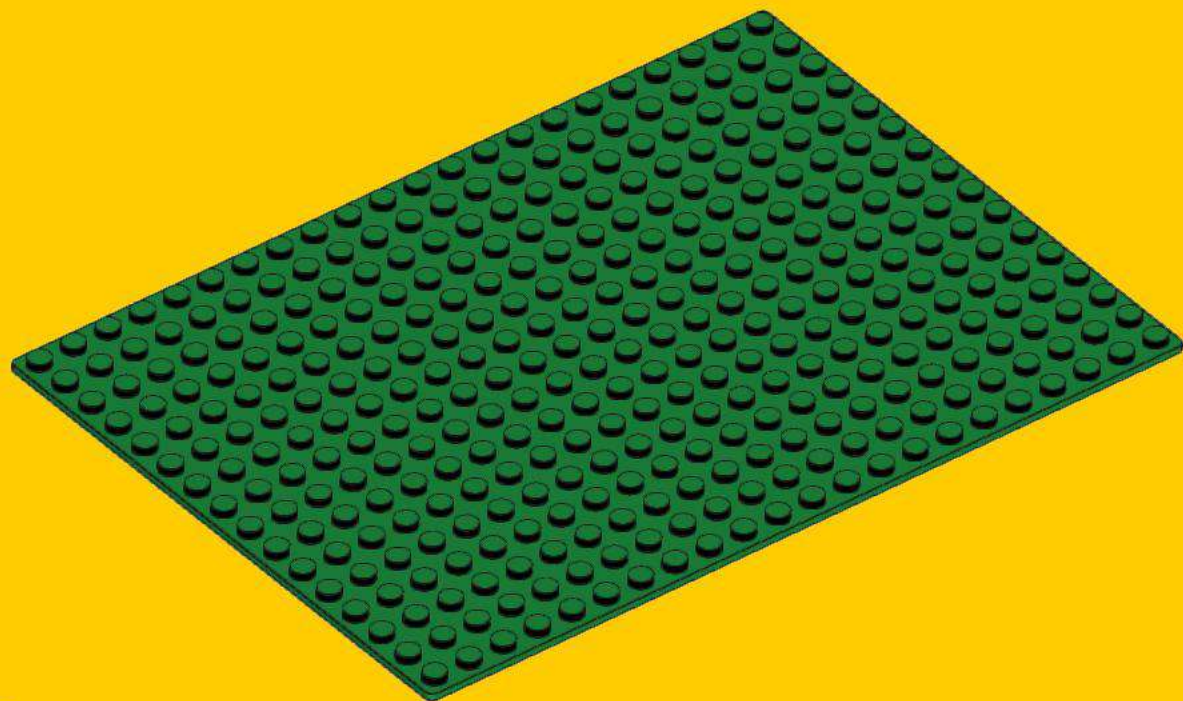

2x
210, 6



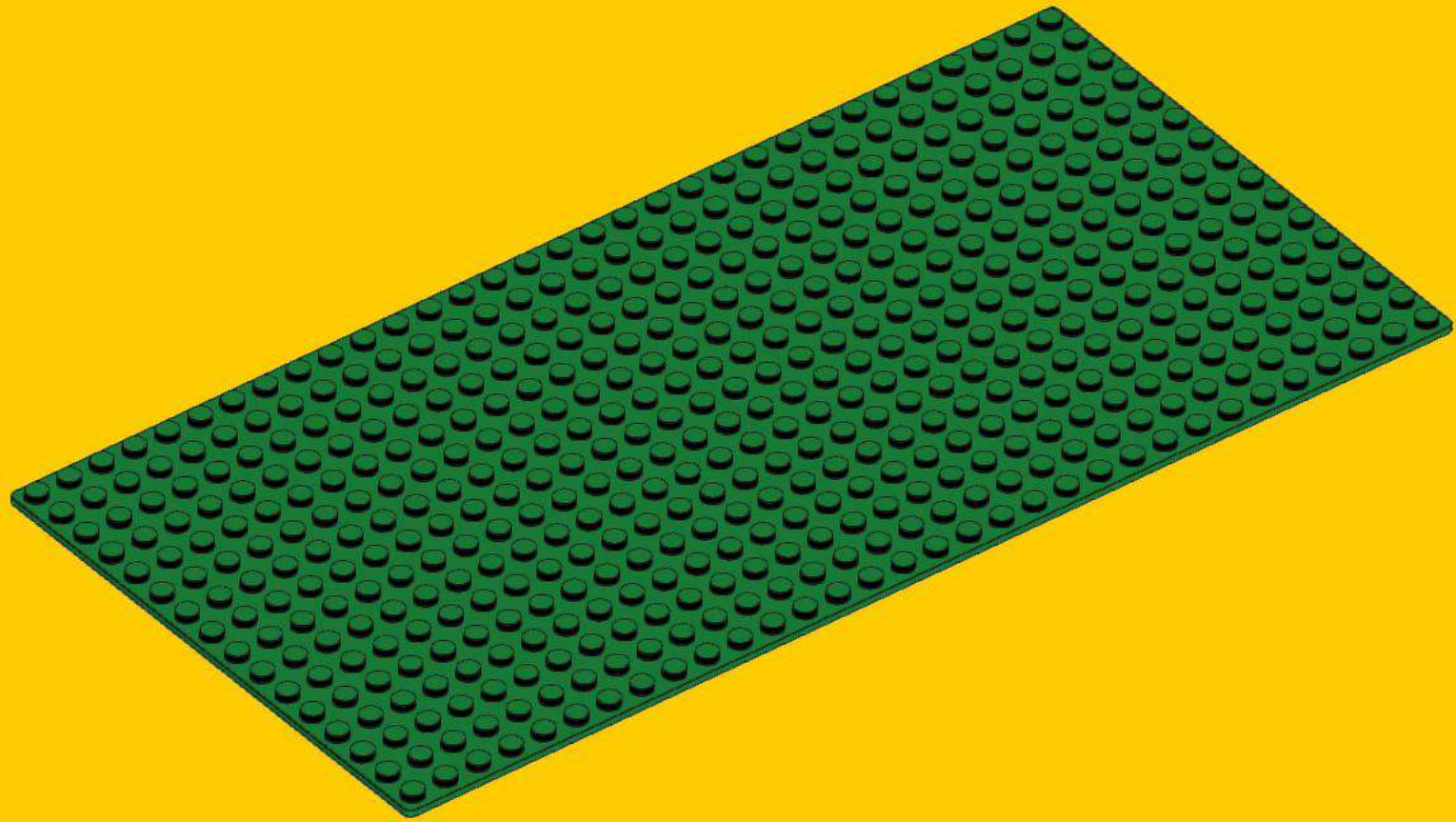

1x
3857, 6



15x
982, 7



15x
981, 7



9x
972, 7



9x
971, 7



1x
4524, 7



1x
973p40, 7

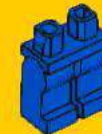

1x
970c00, 7

