

# IDEAS 250 : Fortress Building Site - Horse Powered Crane

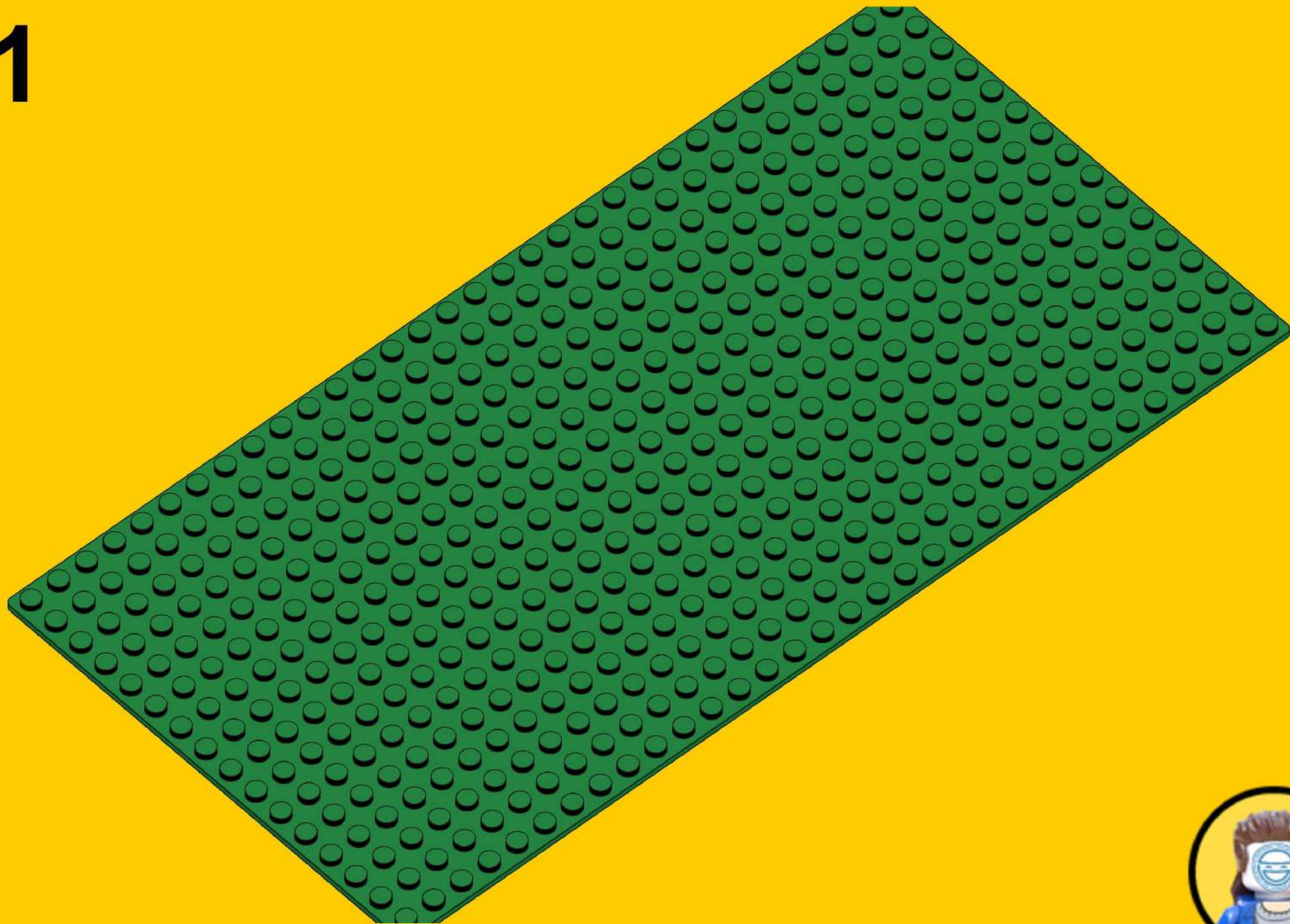

1



# 2

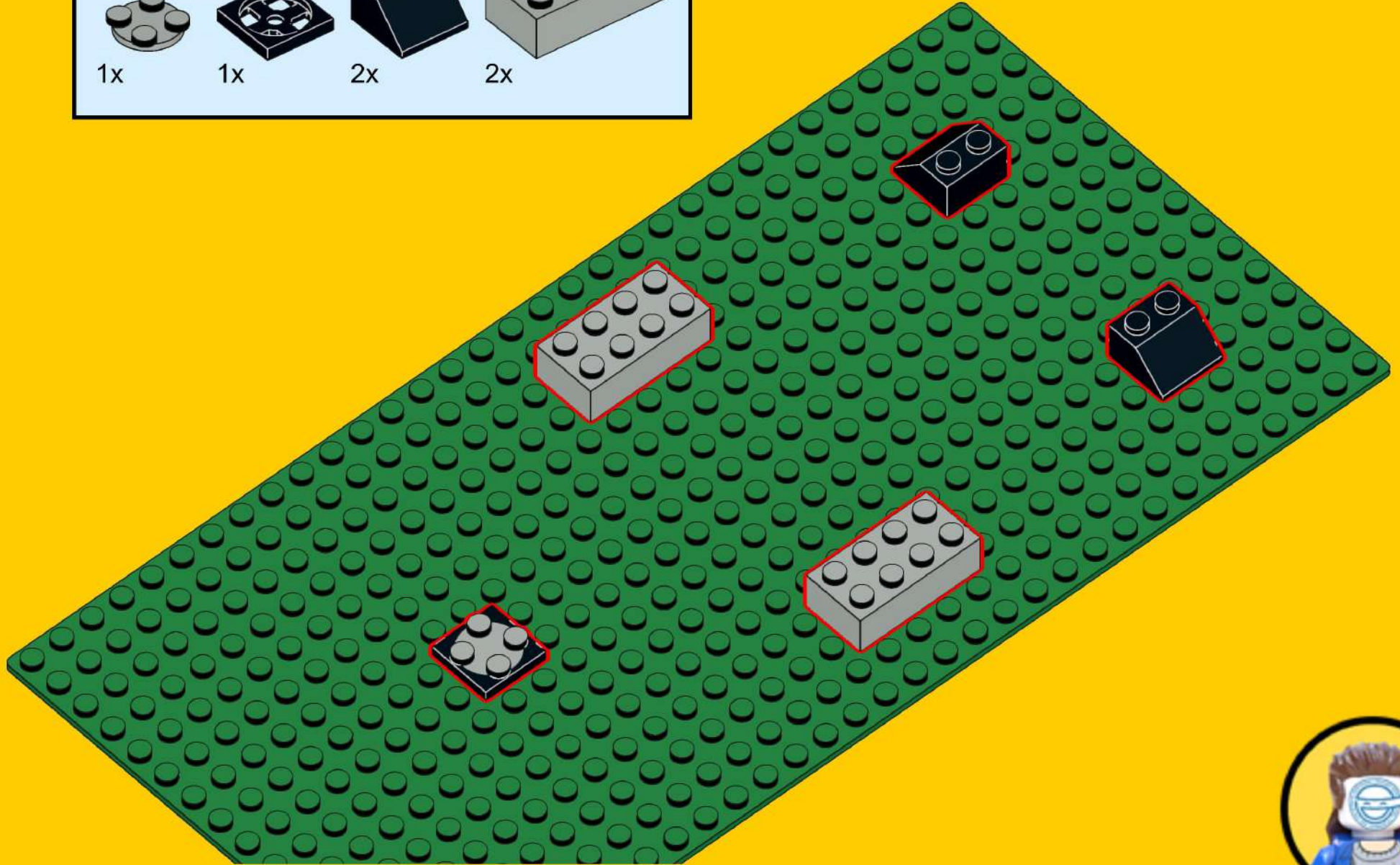
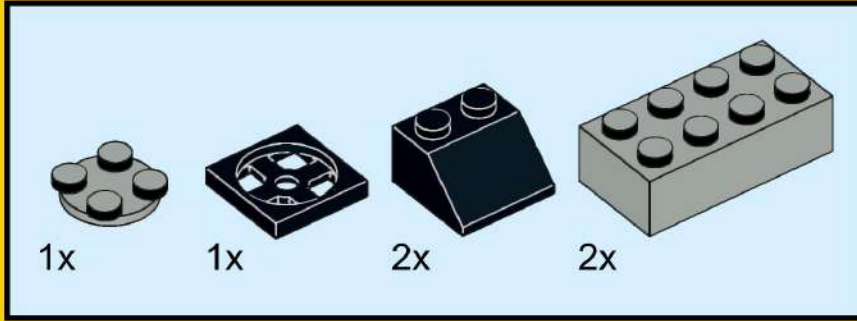



4

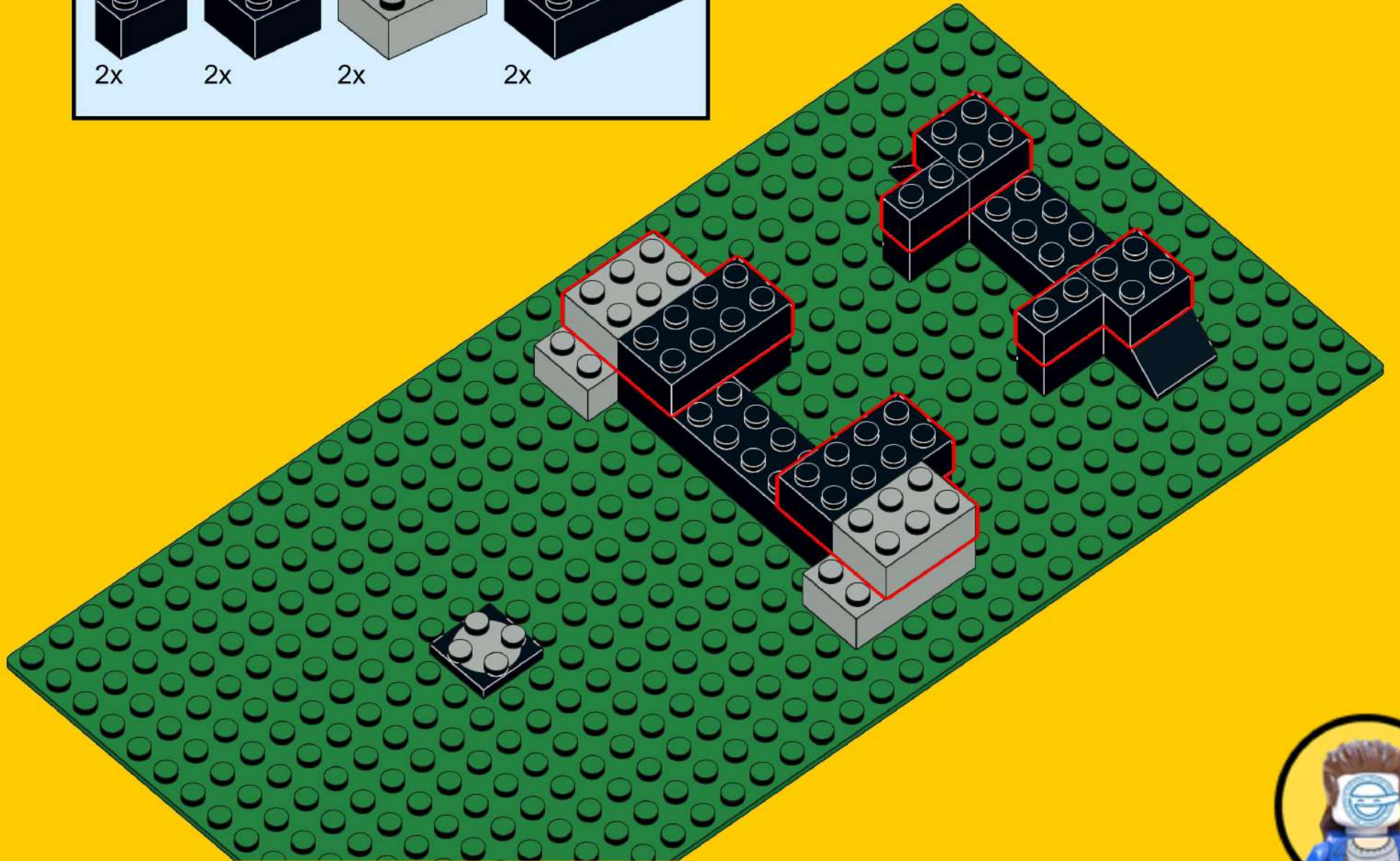
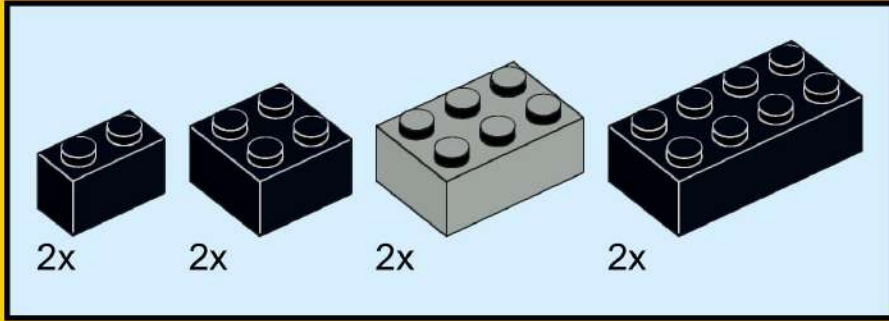

5

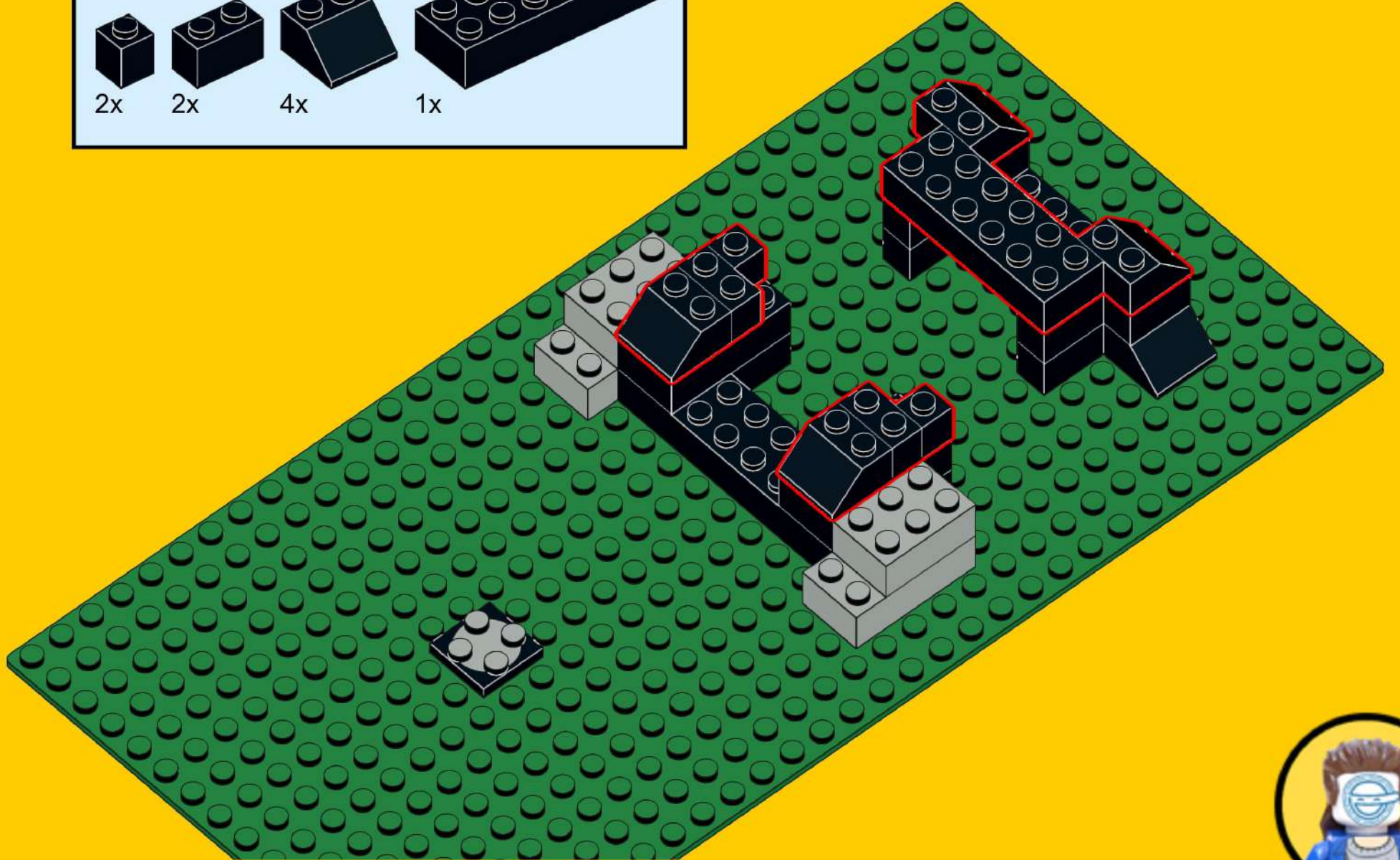
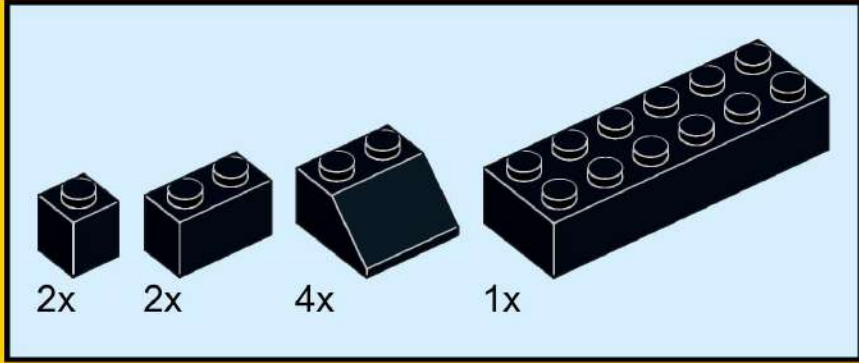

# 6

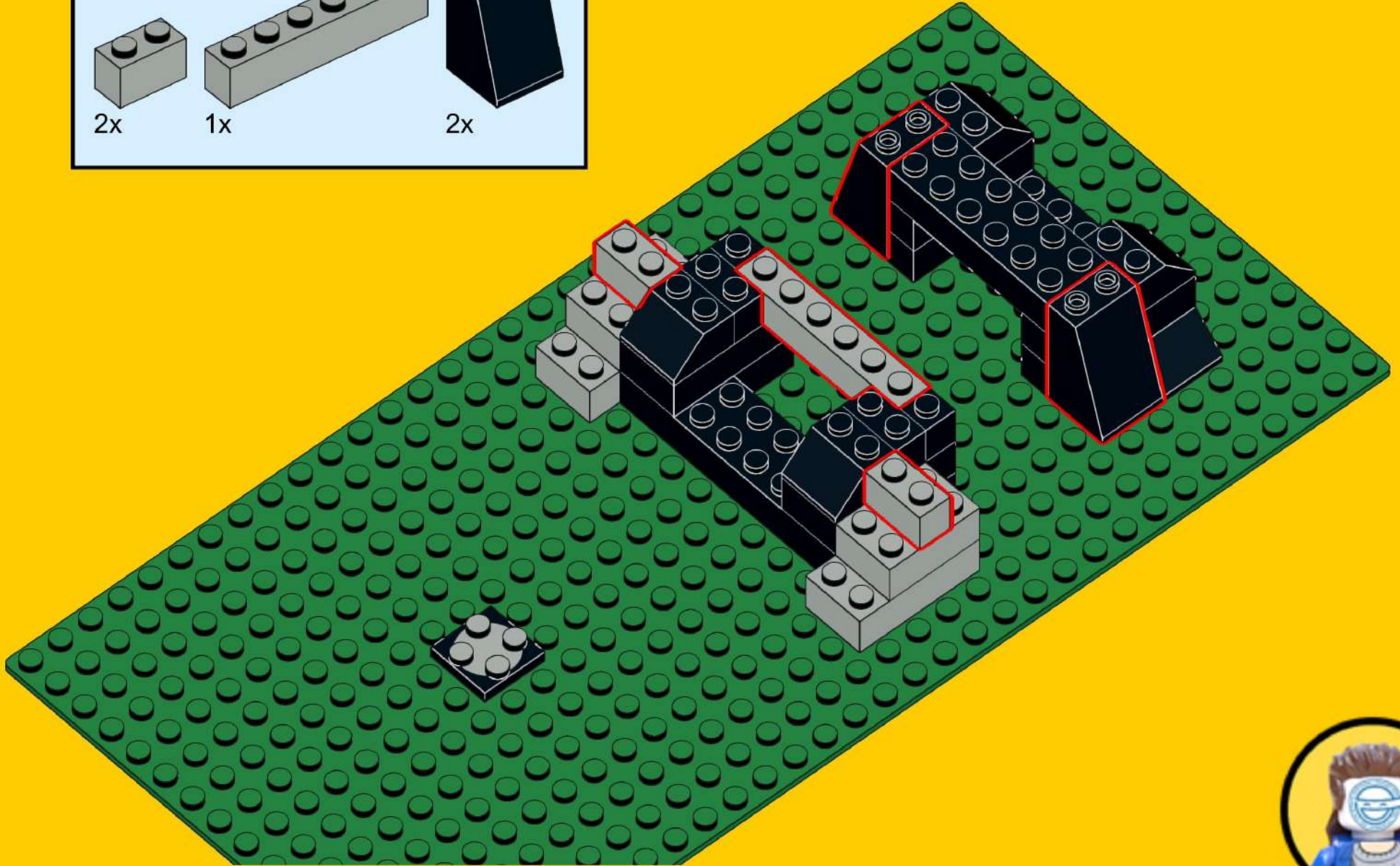
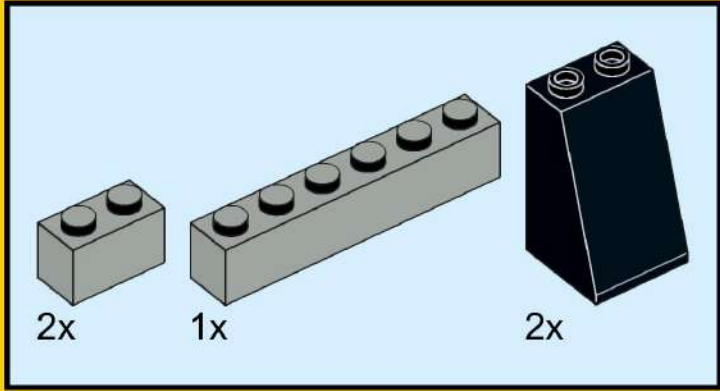

7

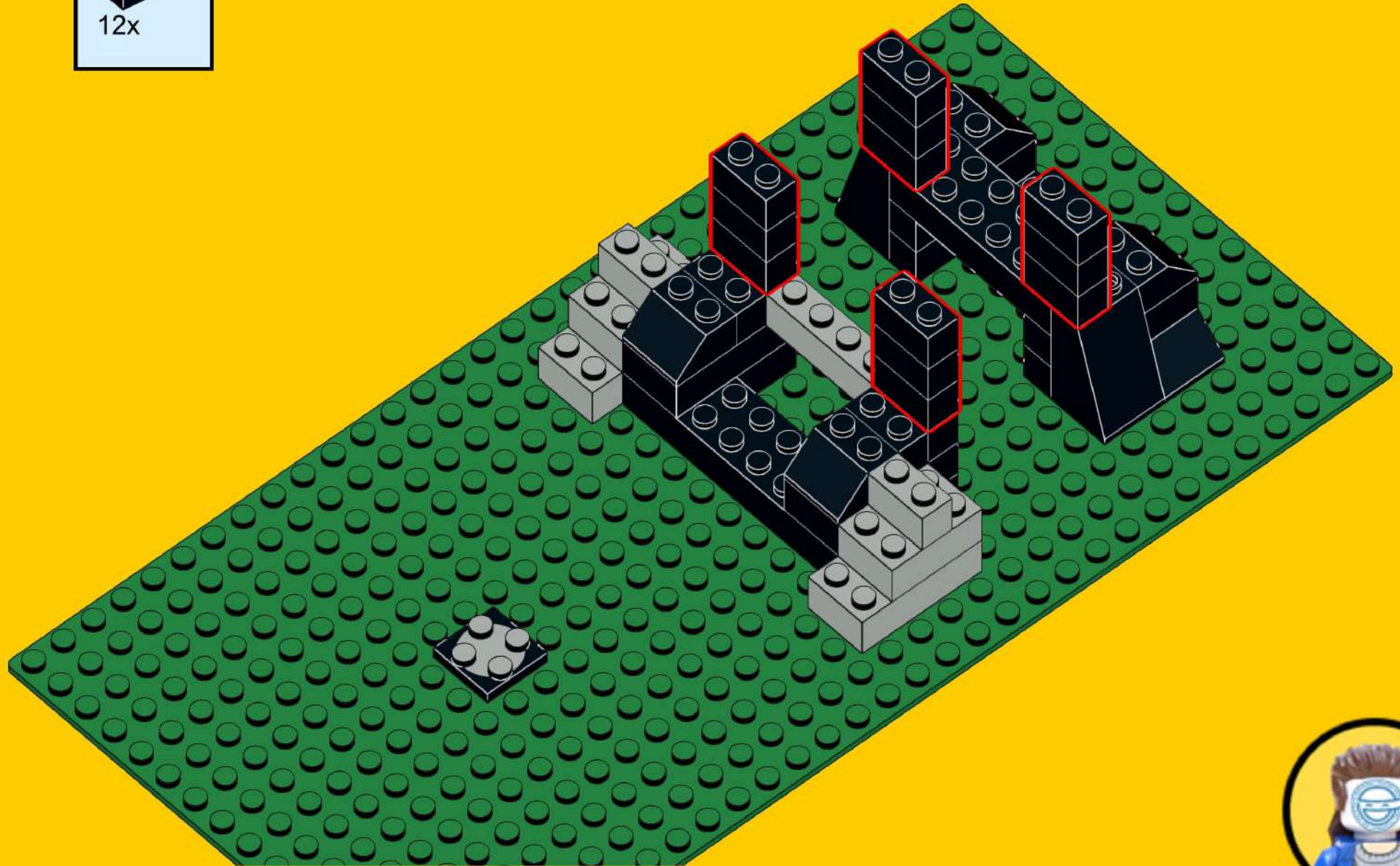
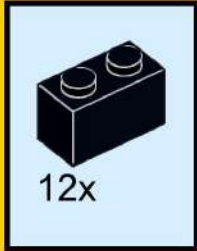



8

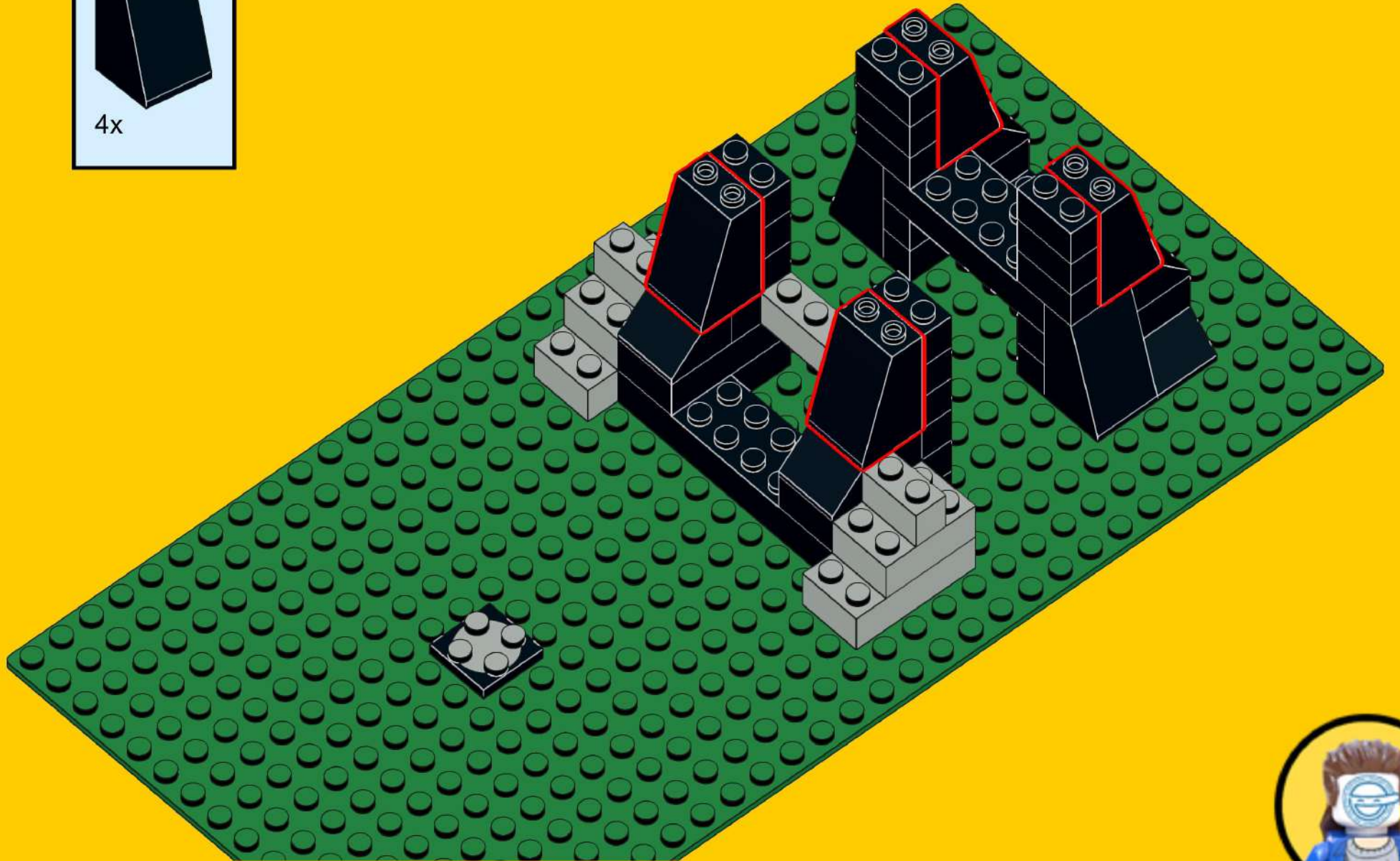
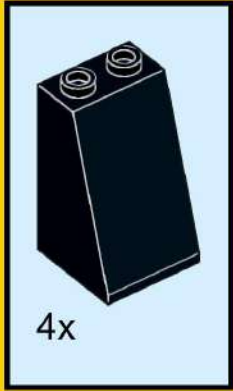

9

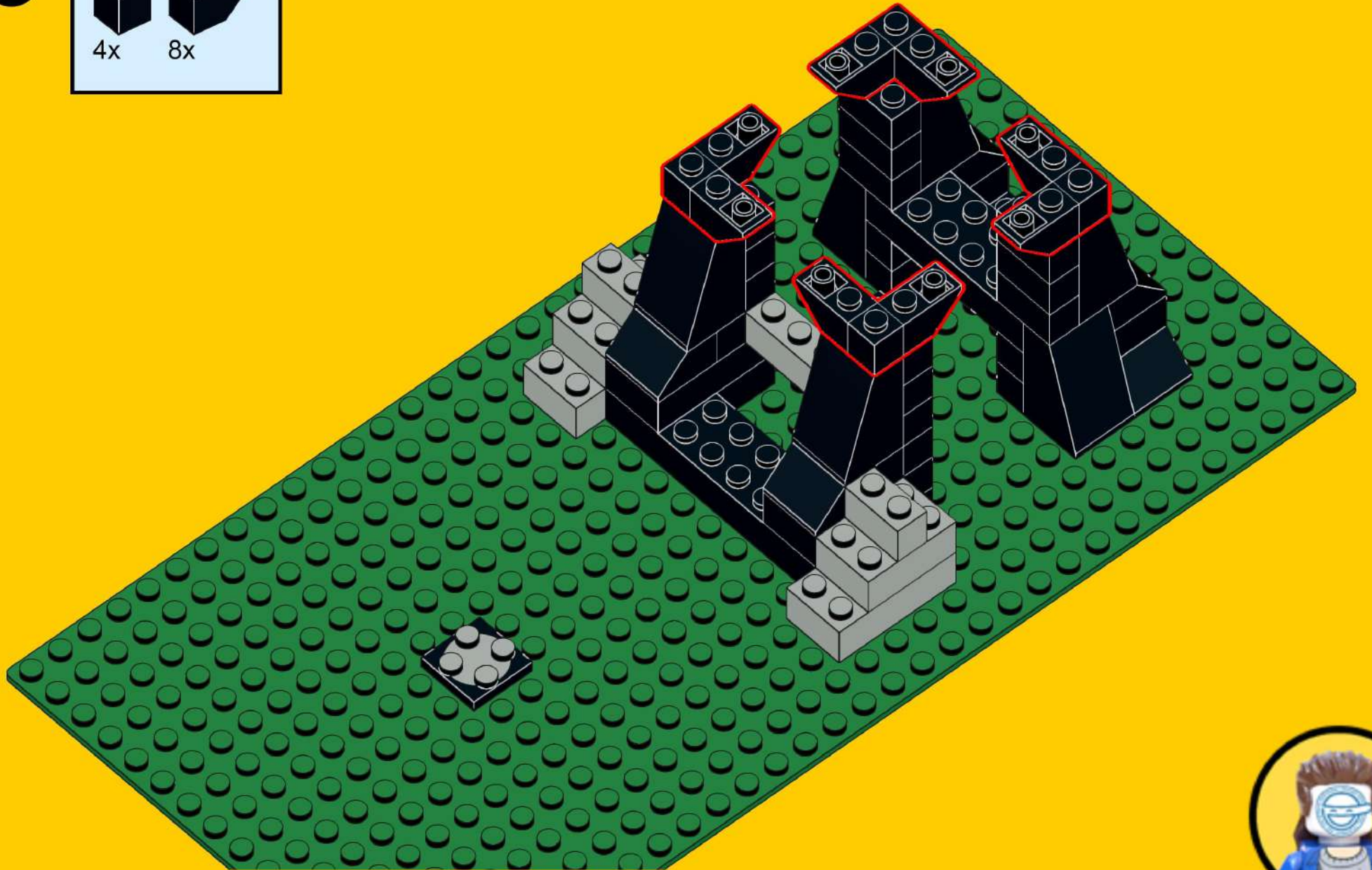
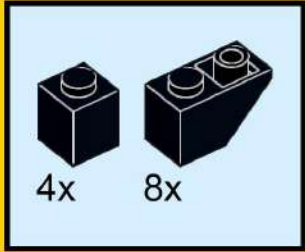

# 10

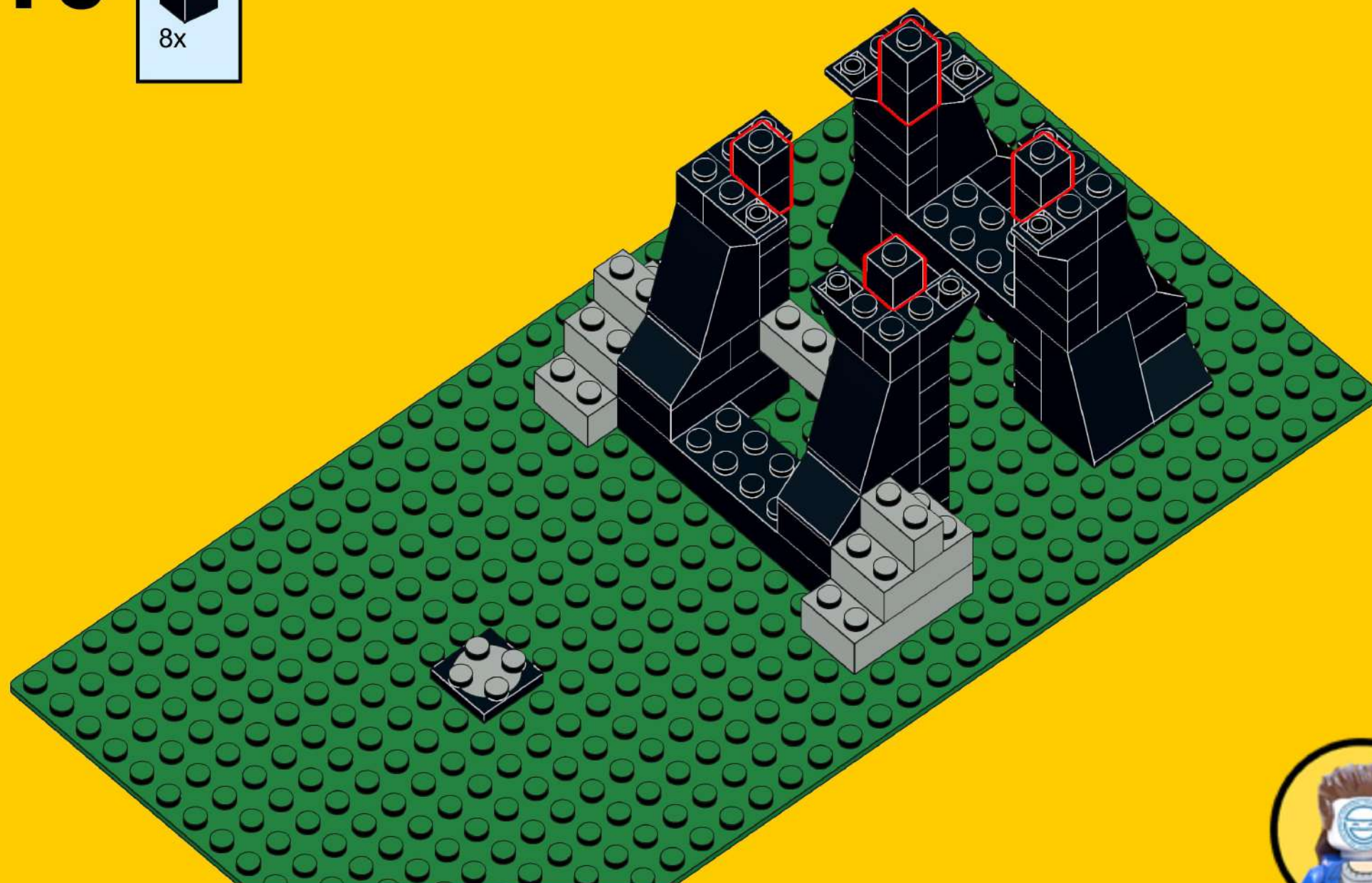

# 11

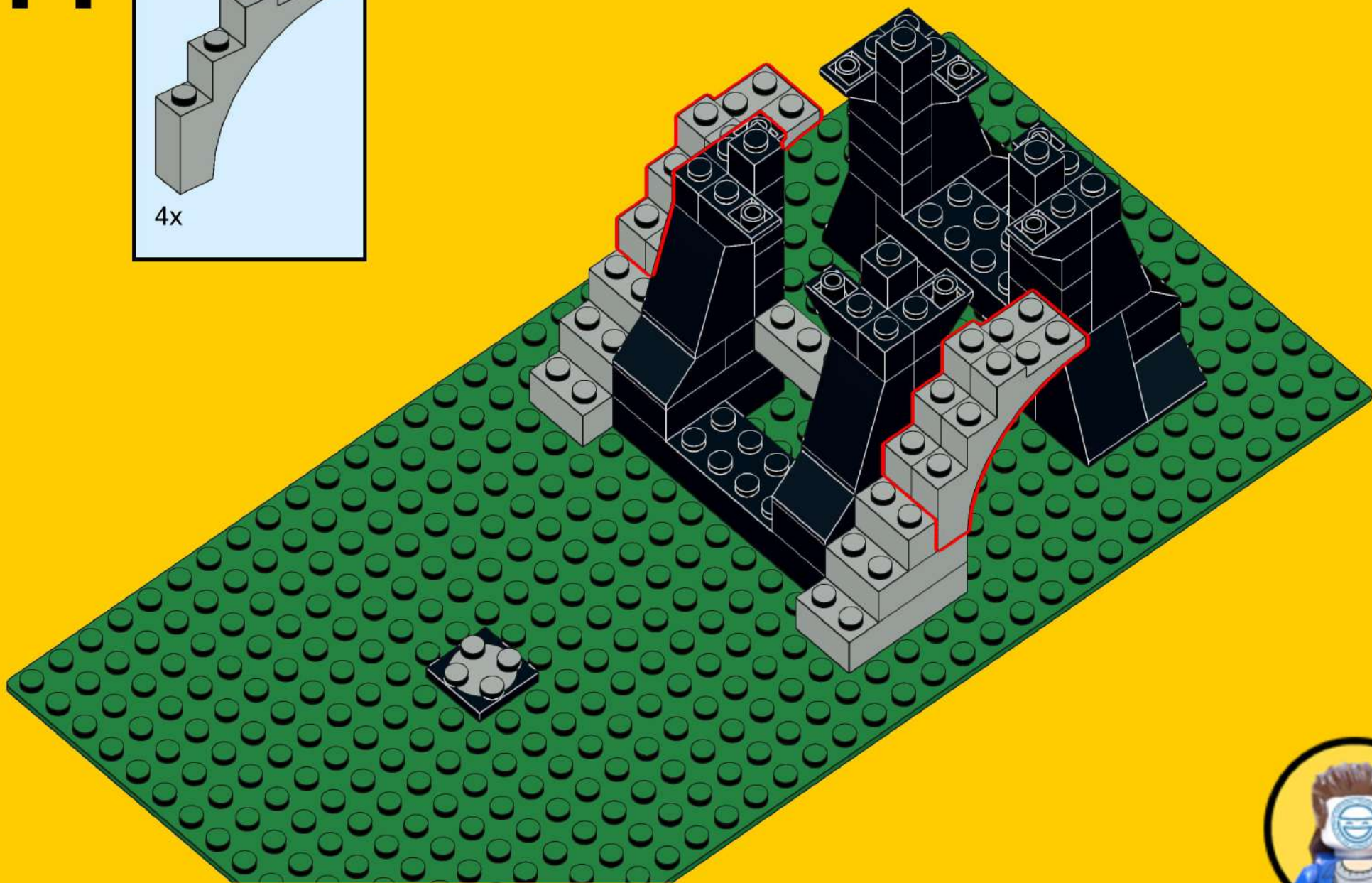
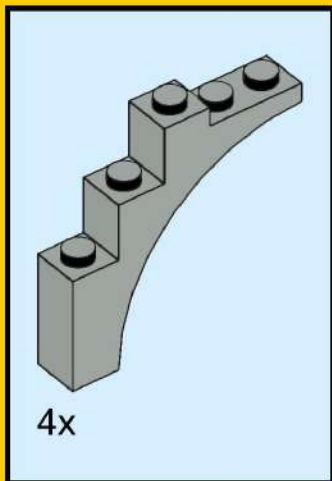

# 12

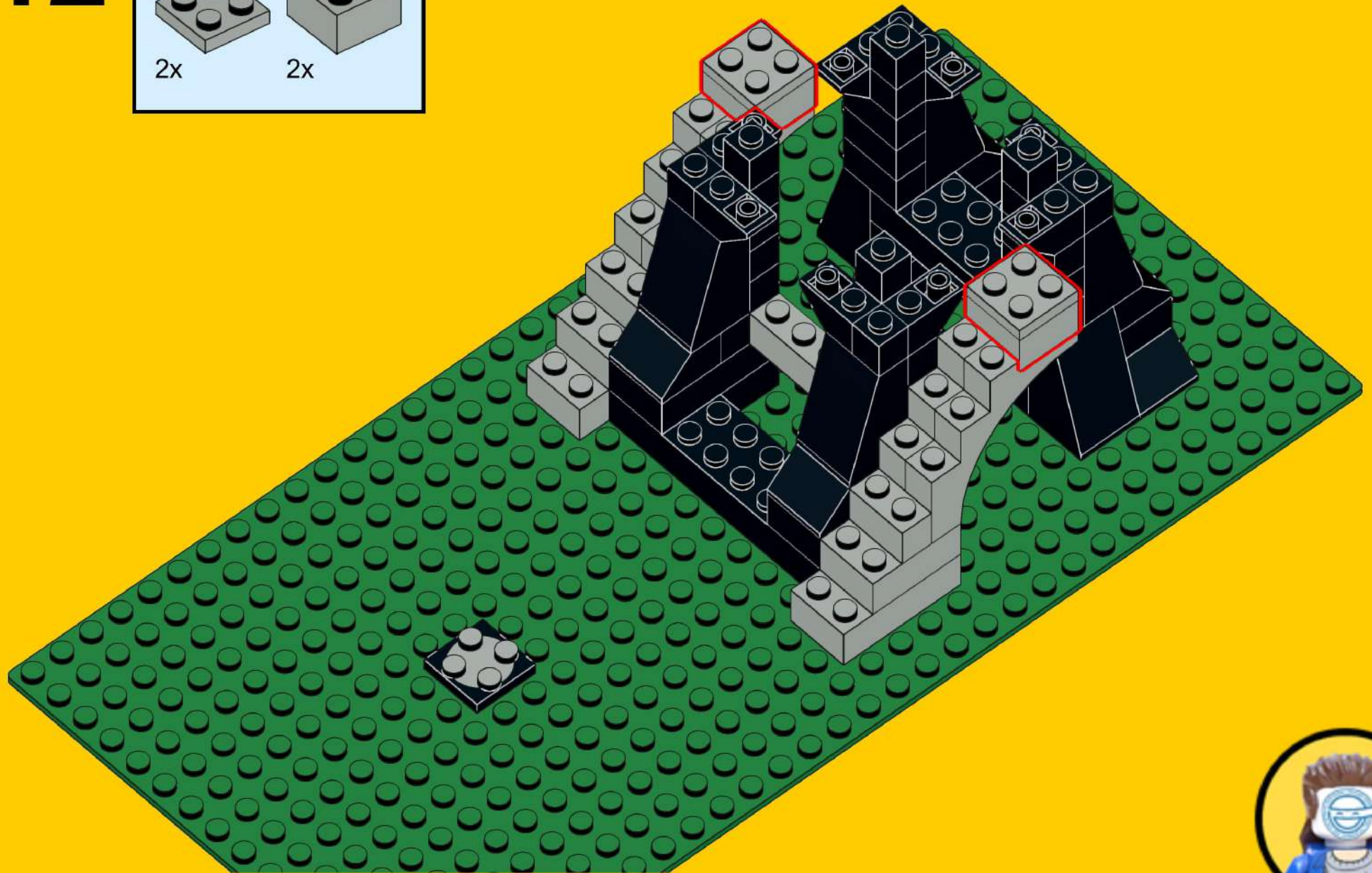
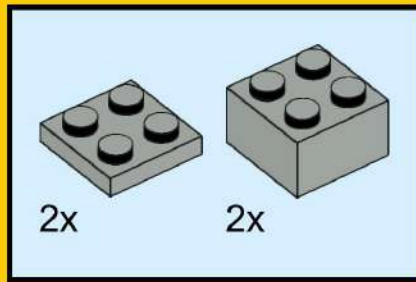

# 13

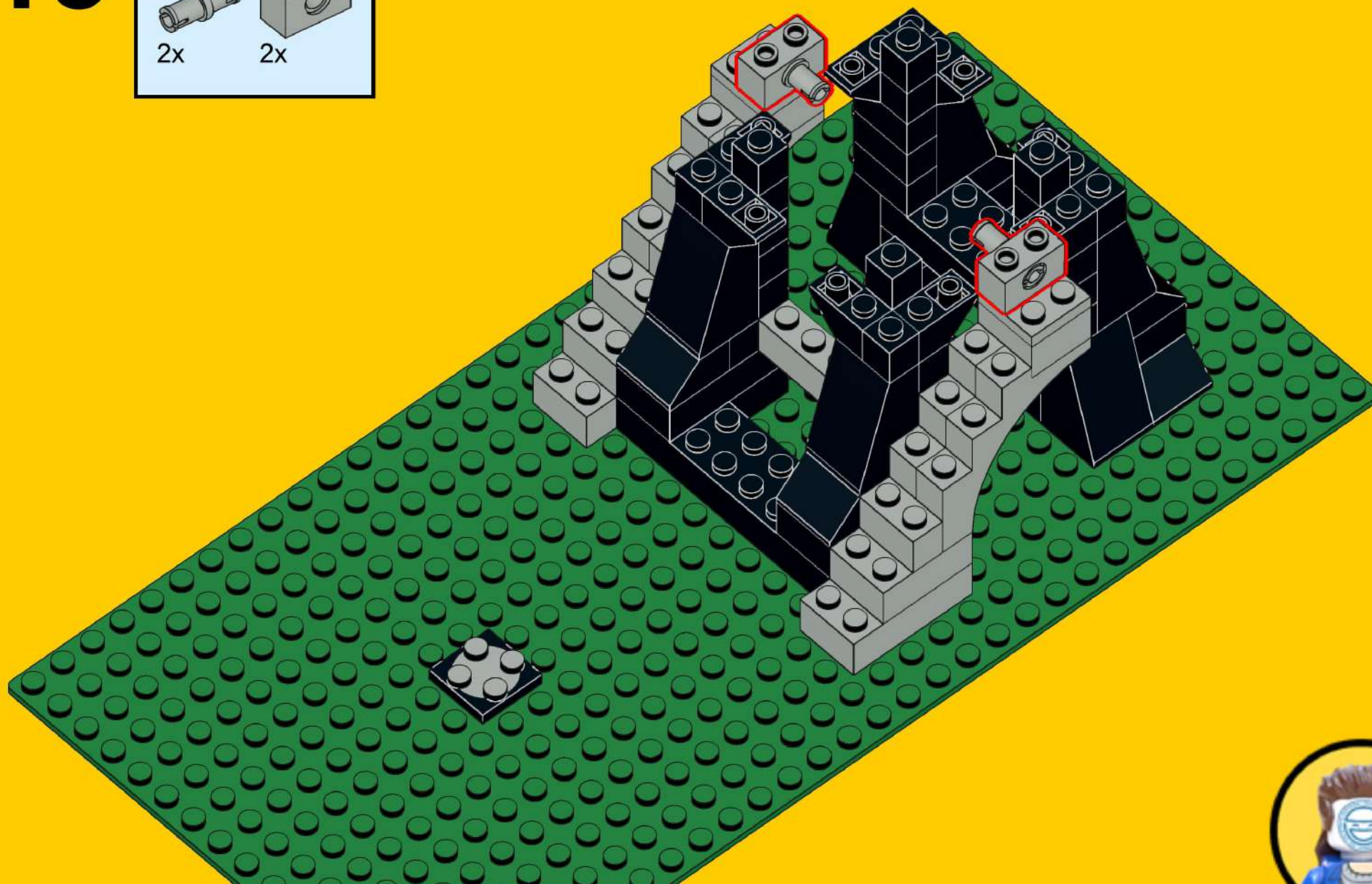
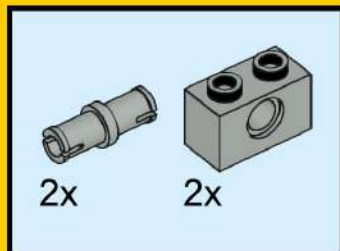

# 14

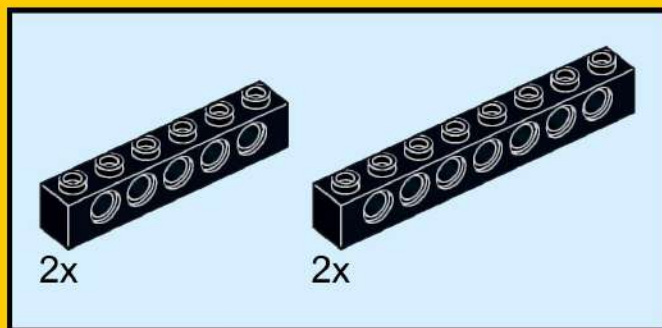

Pass the rope in the  
technic brick

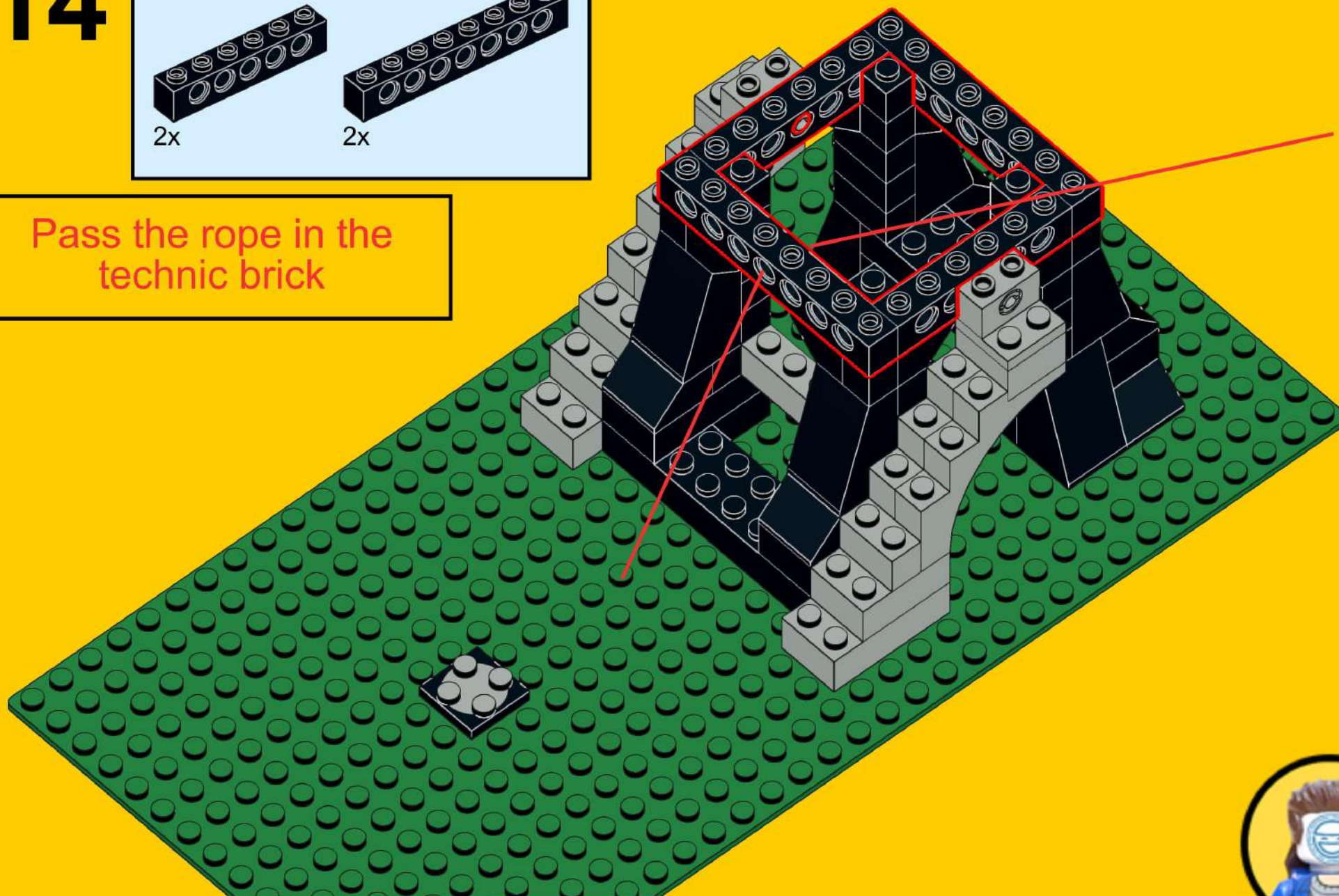

# 15

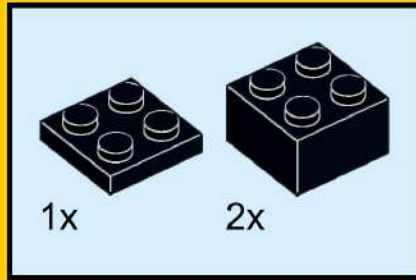



# 16

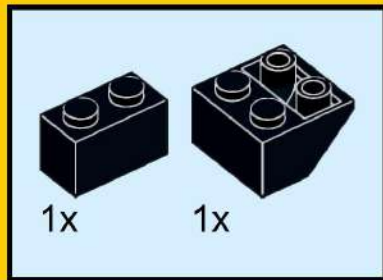

# 17

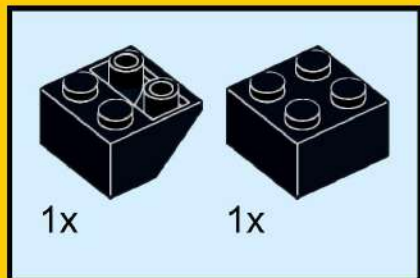

# 18

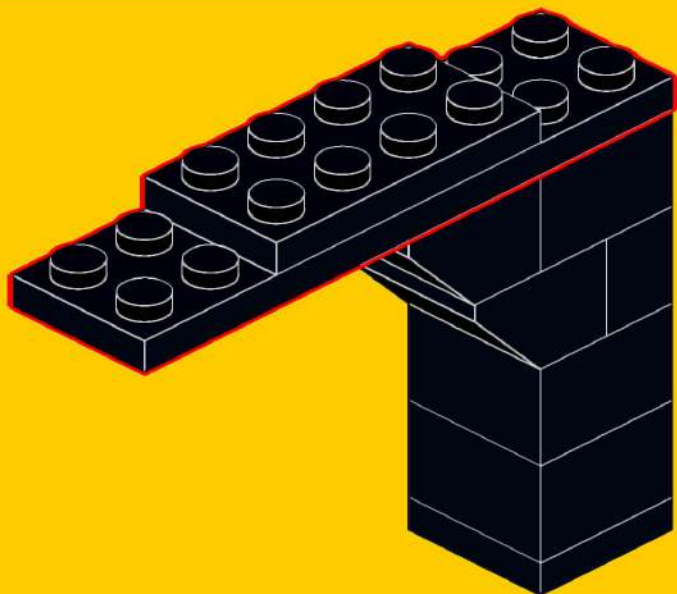
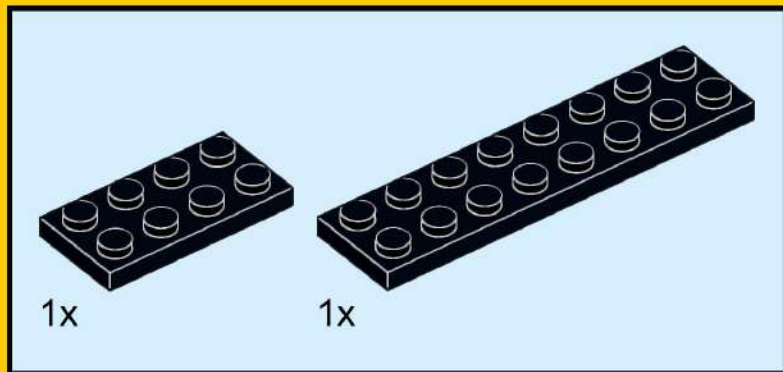

# 19

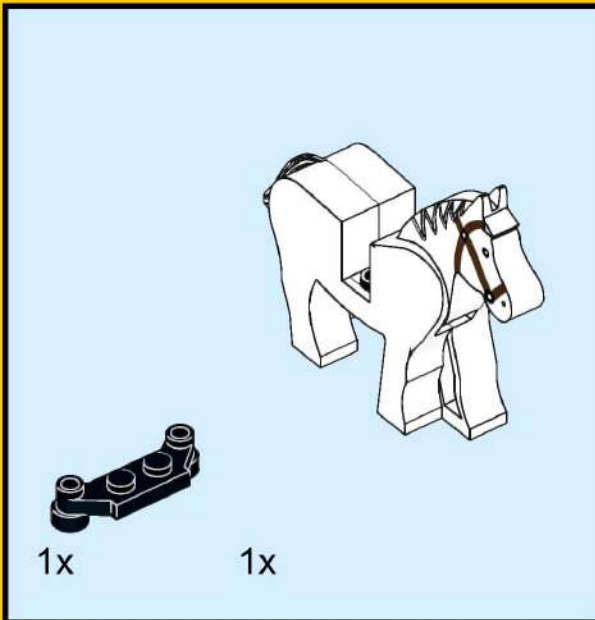
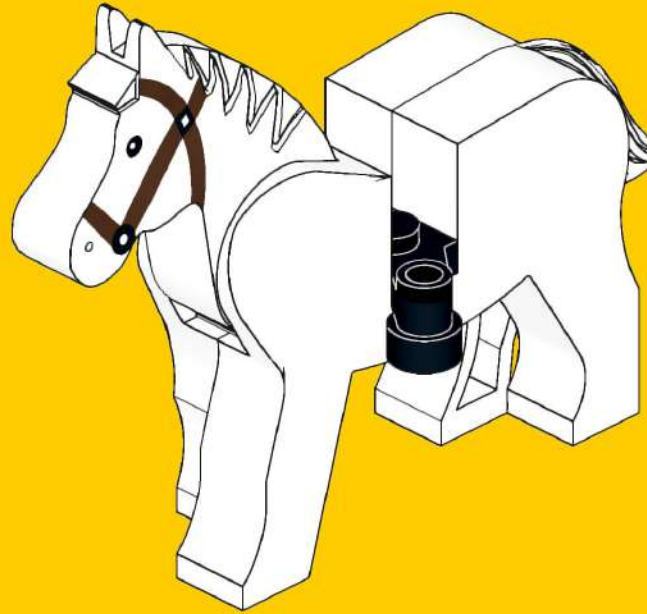

20

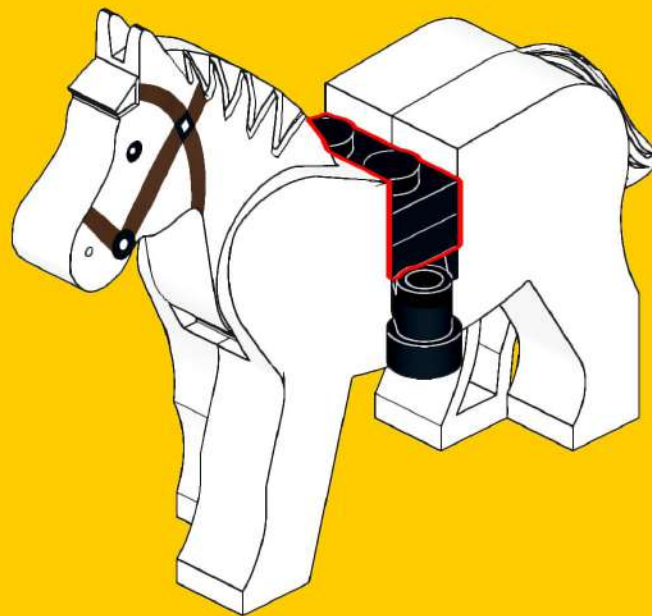
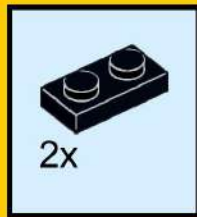

# 21

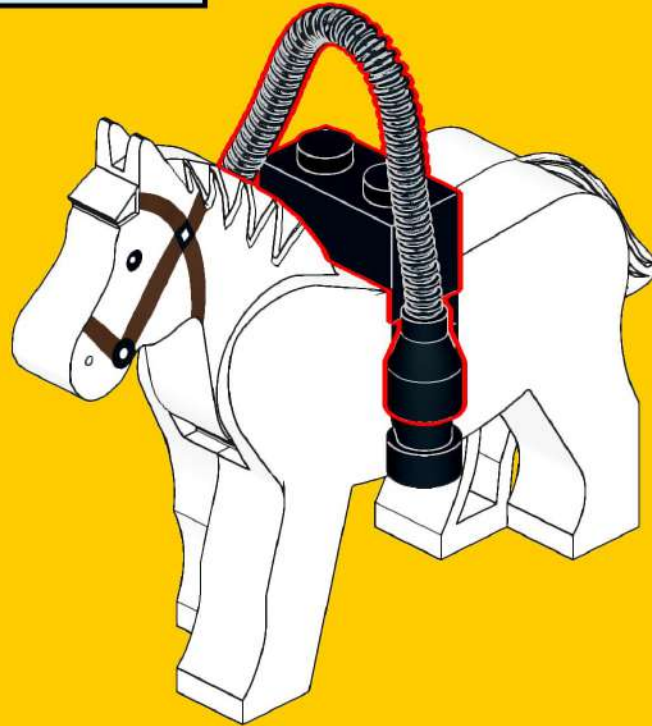
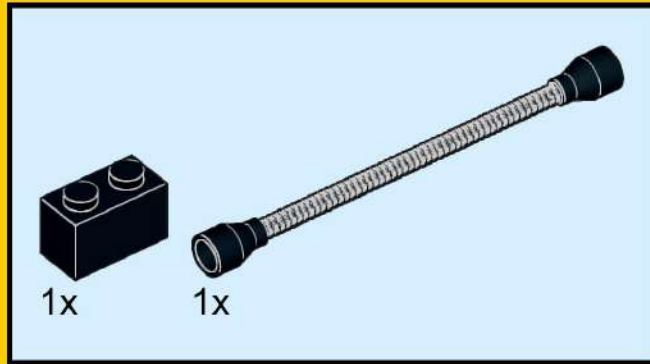

22

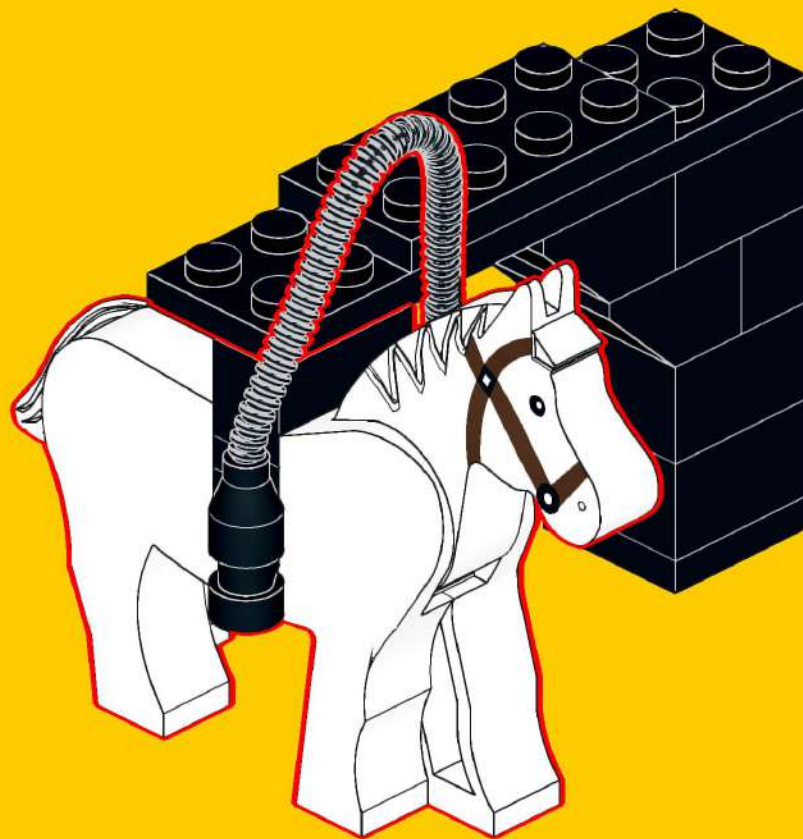

# 23

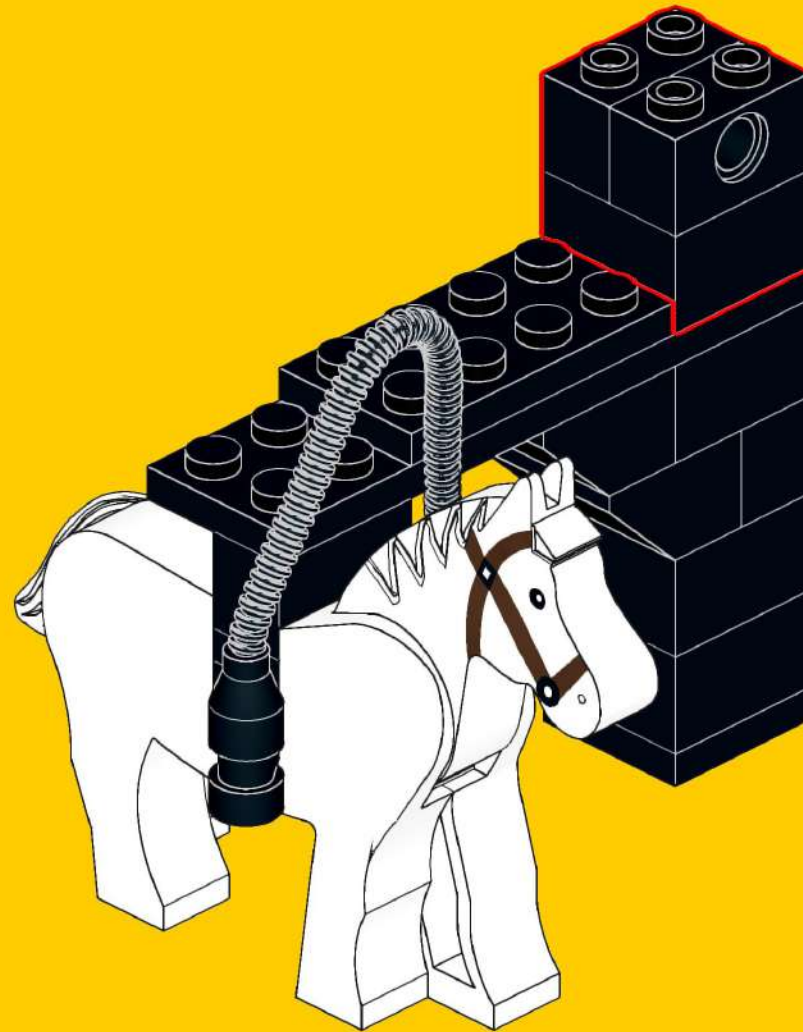
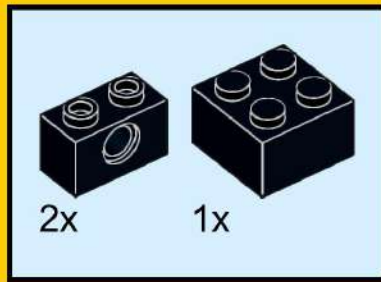



# 24

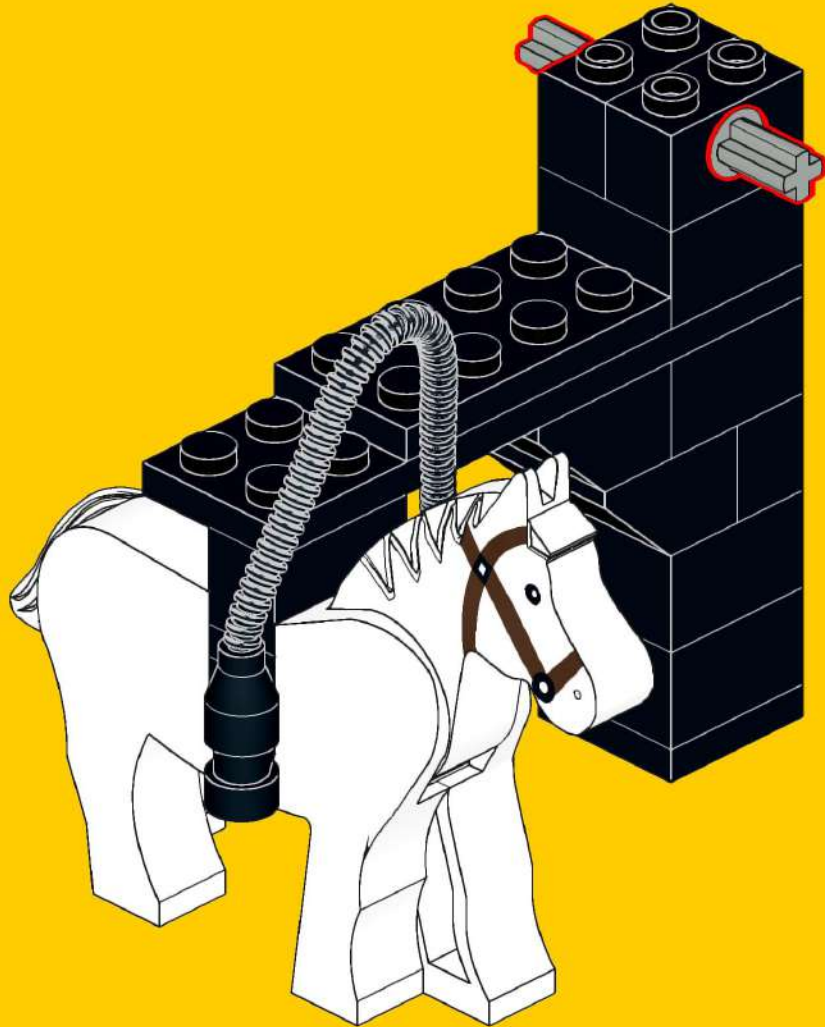
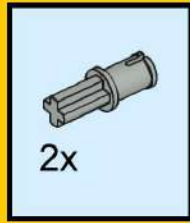

# 25

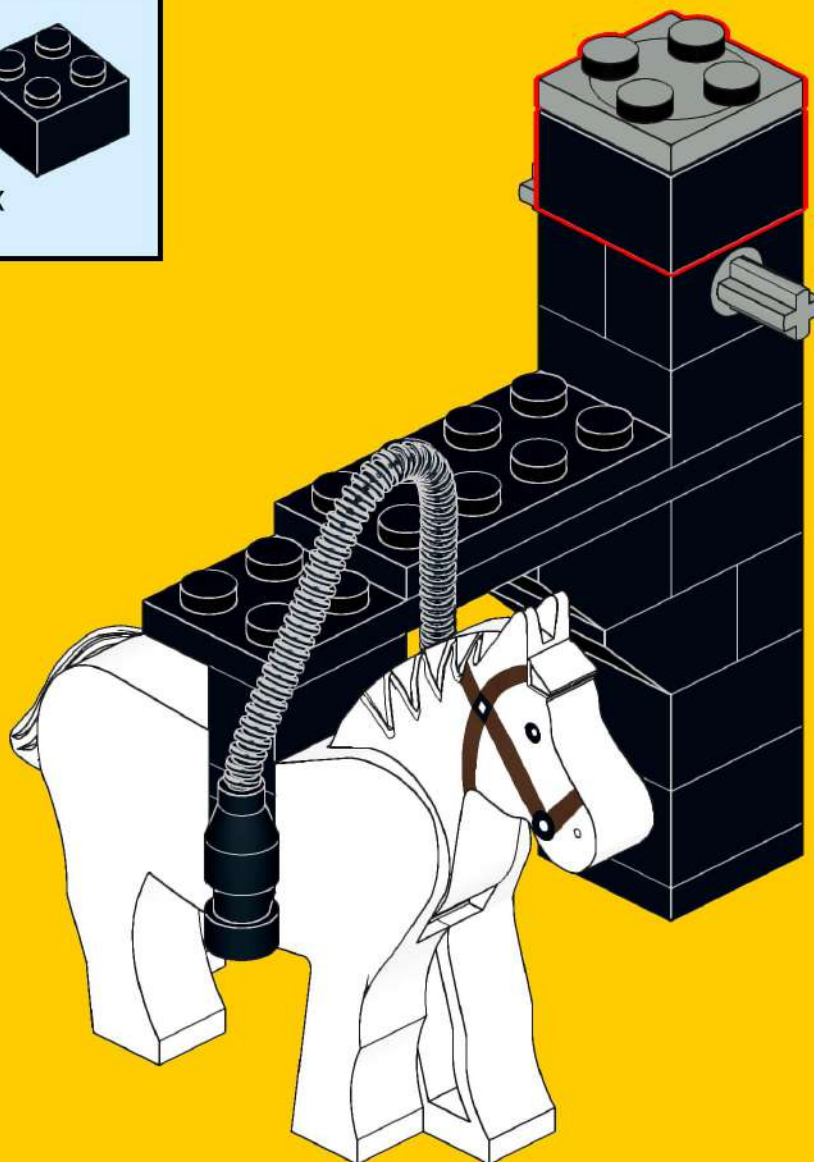
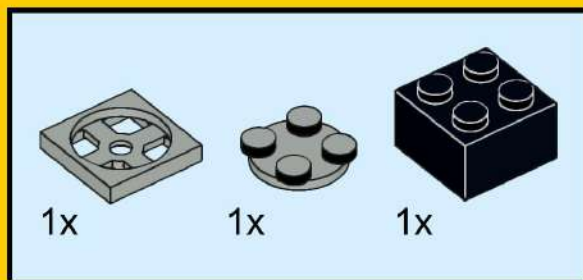

# 26



Tie the rope to the Pin with Axle

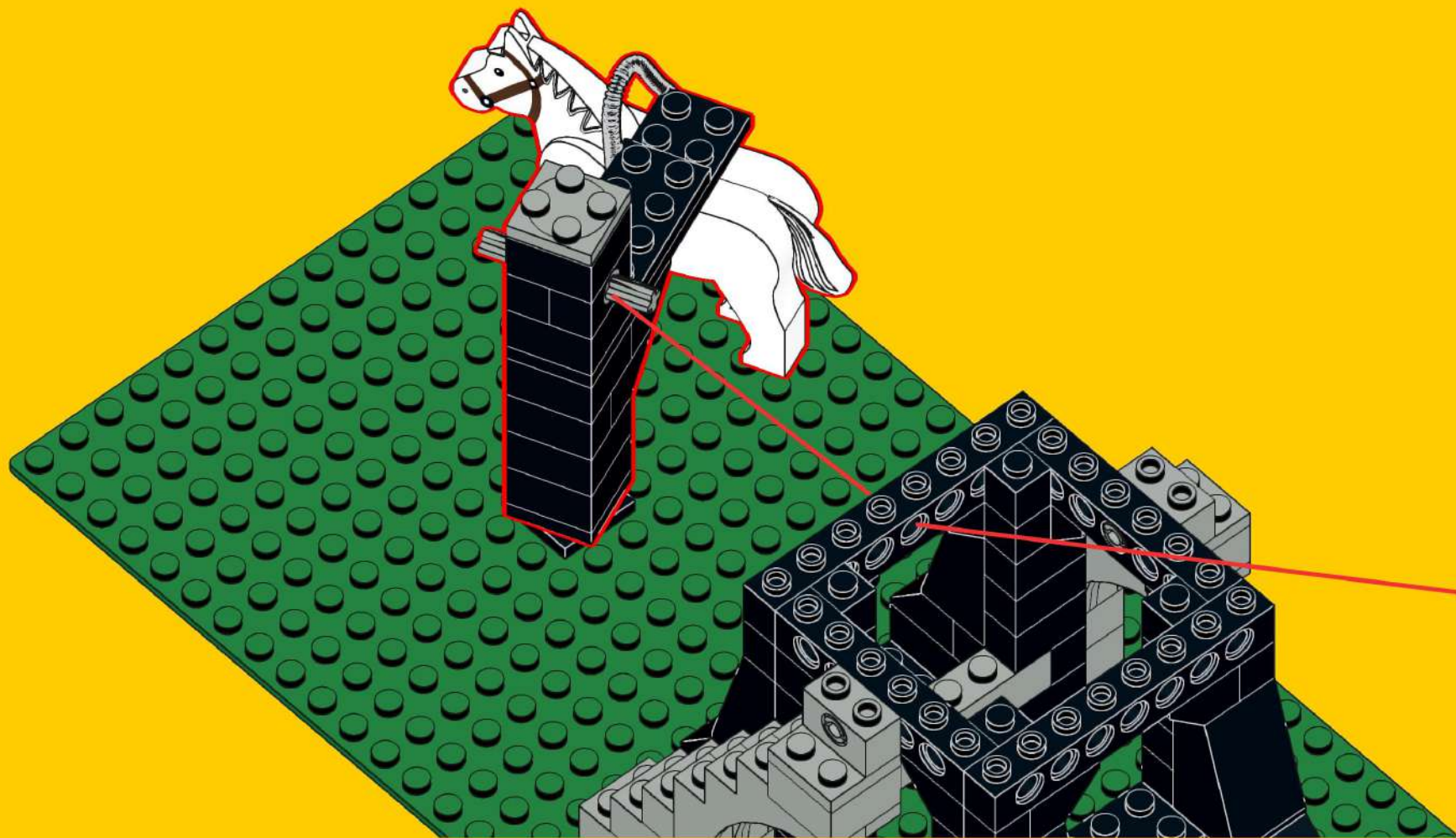

# 27



Block the Rope with the Technic Bush to keep it from slipping



# 28

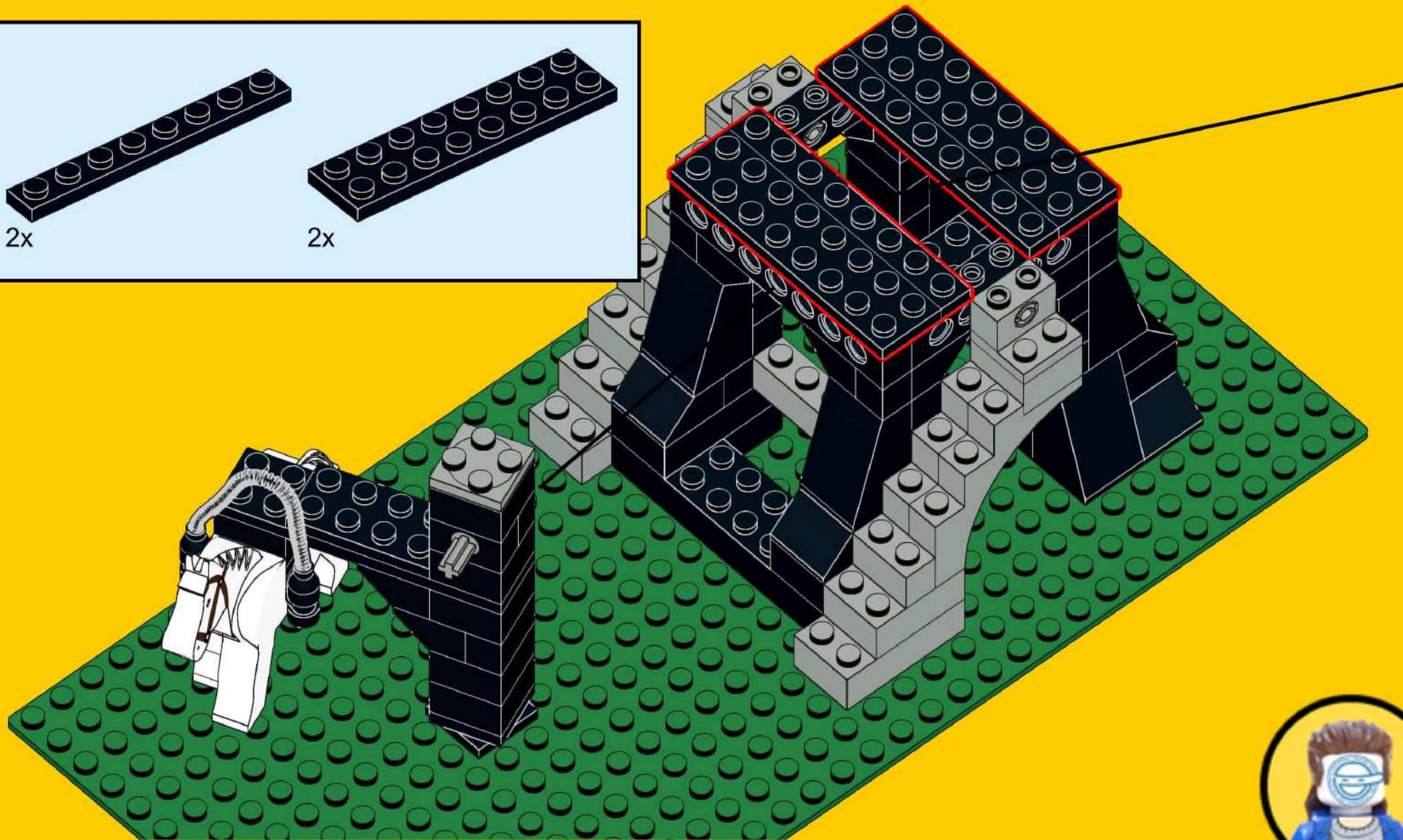
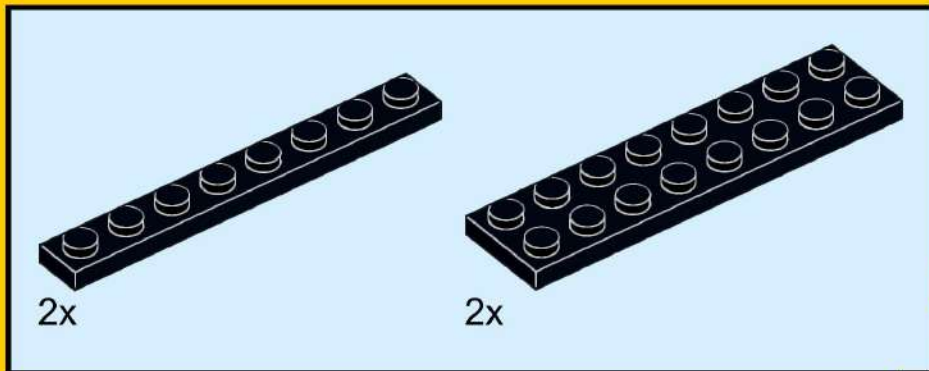

# 29

Pass the rope in the middle hole of the technic plates

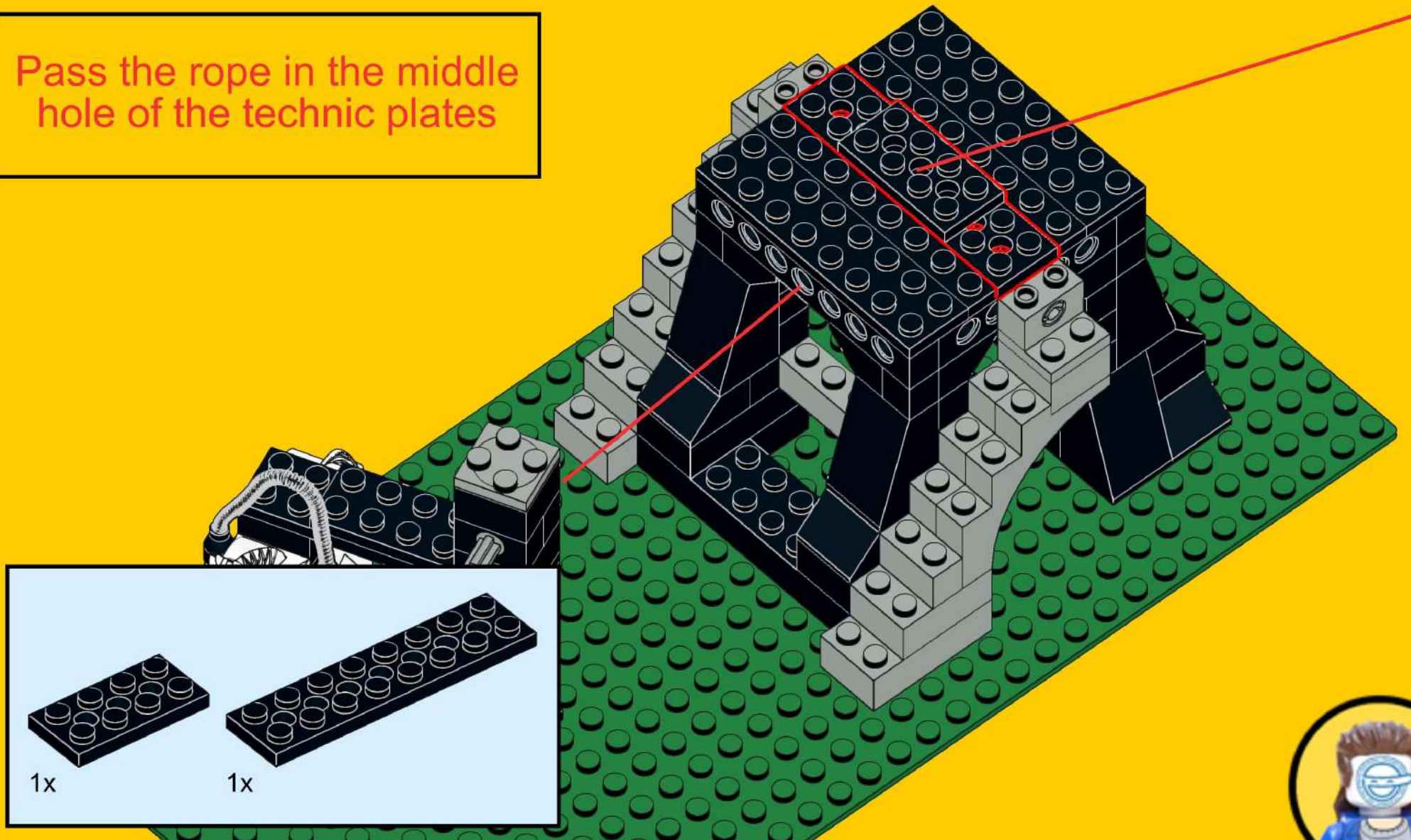

# 30

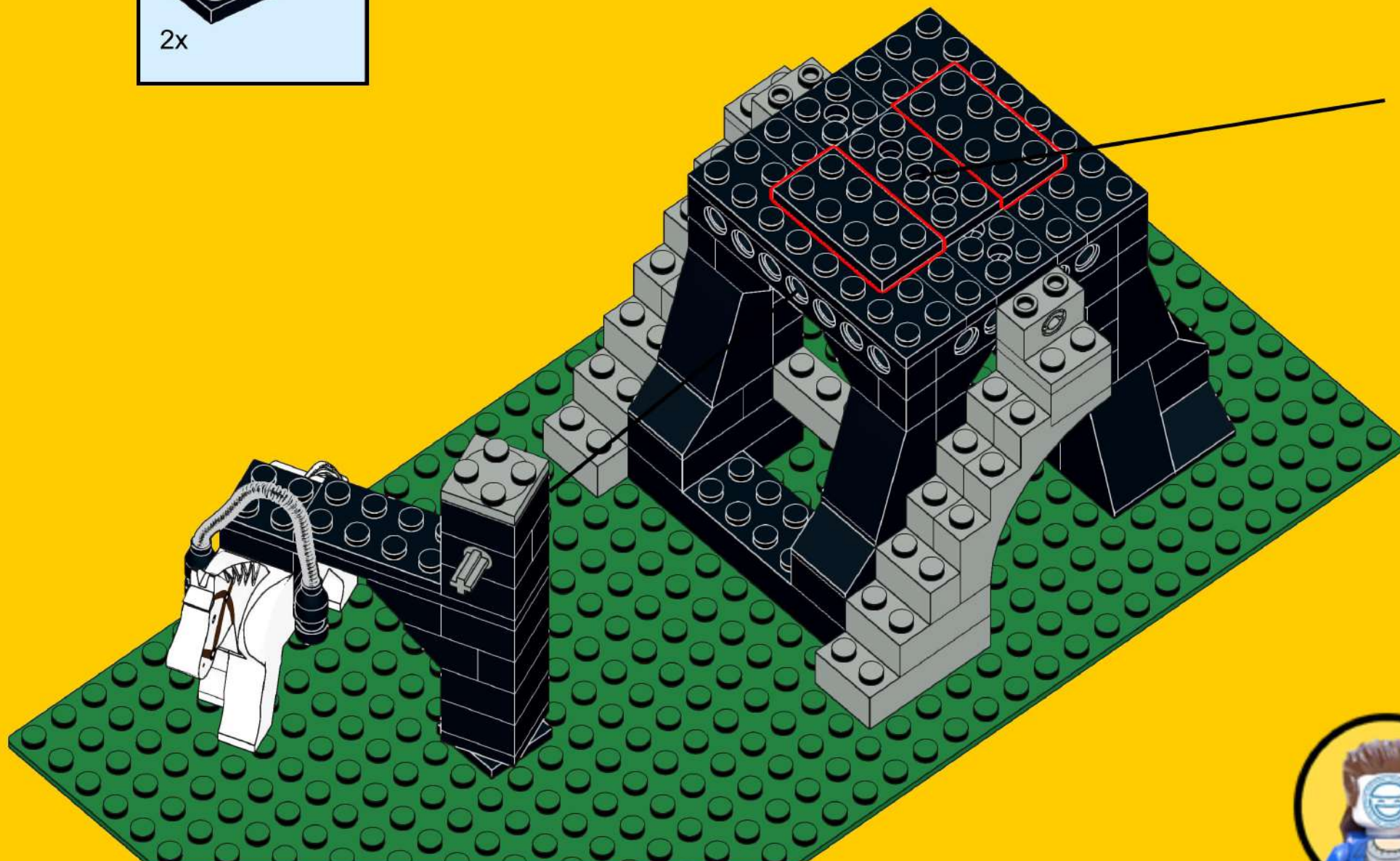
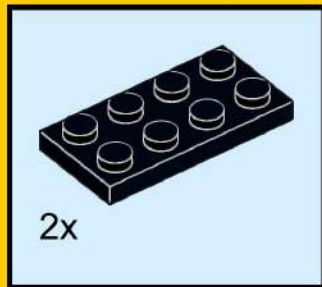

# 31

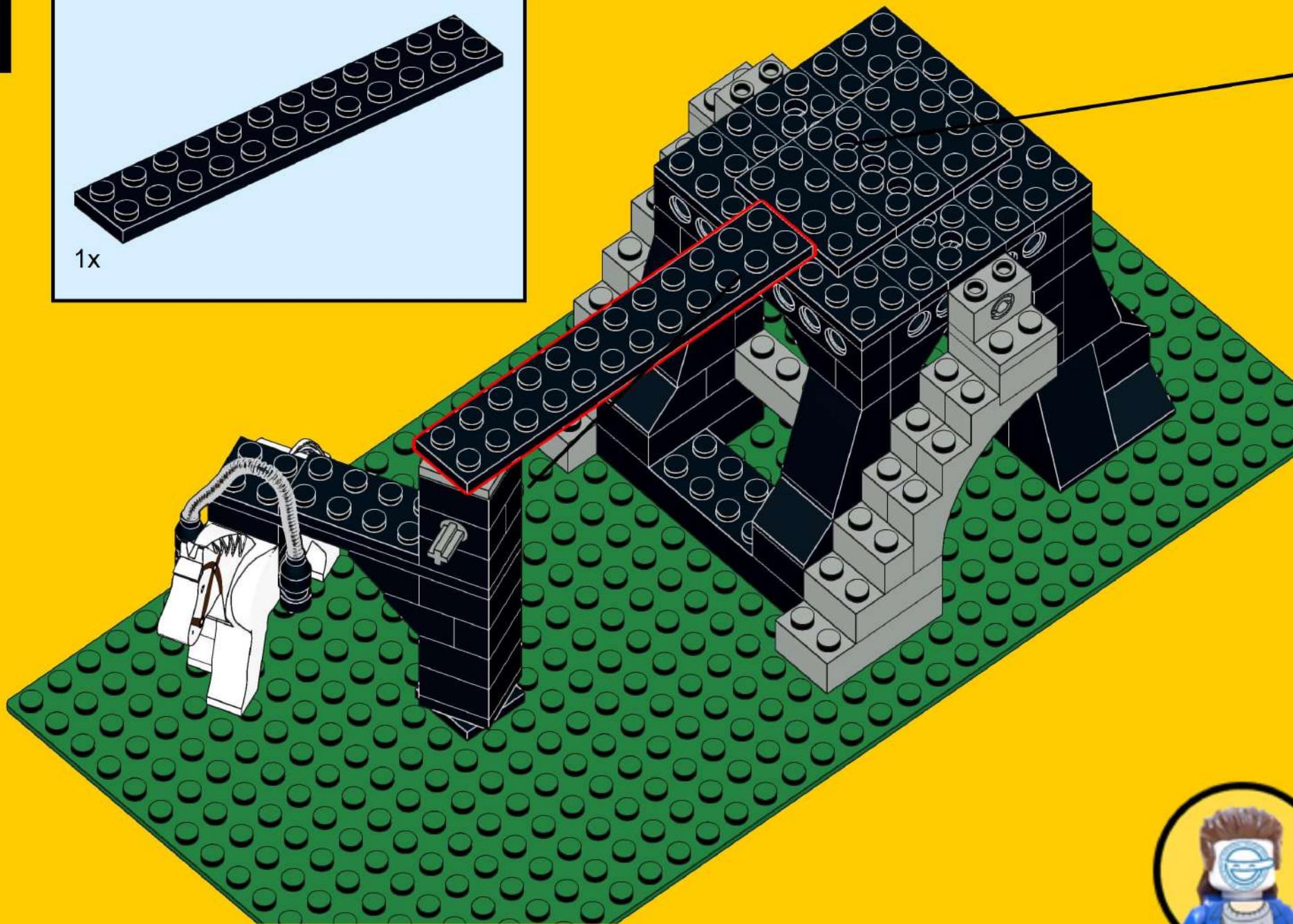
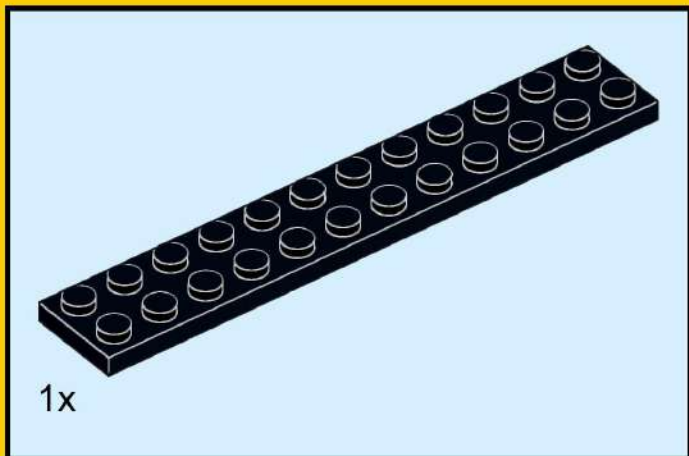



# 32

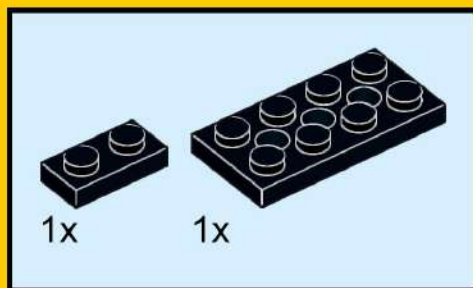

Pass the rope in the middle hole of the technic plate

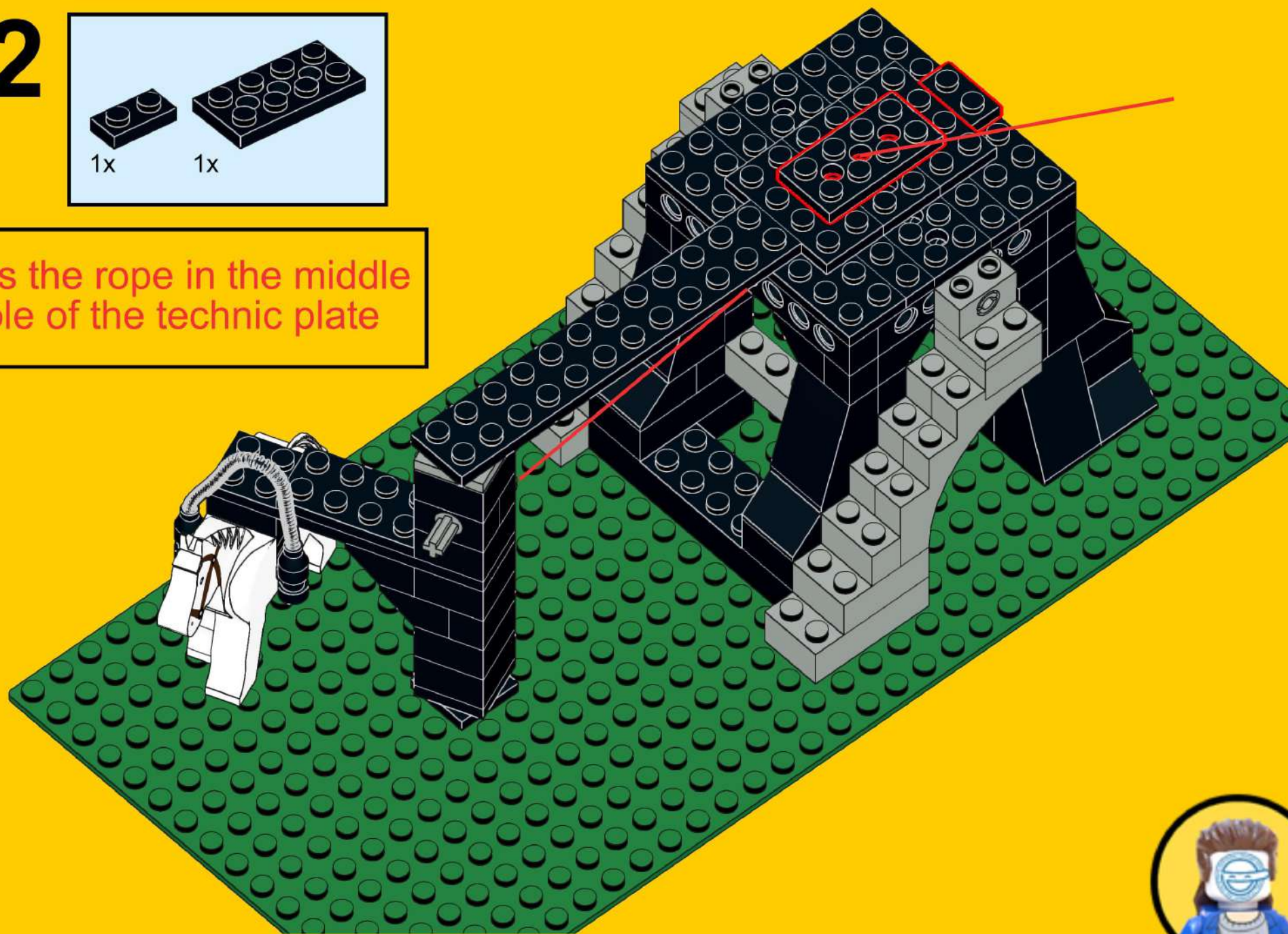

# 33

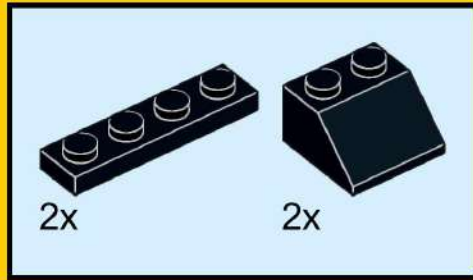

Pass the rope in the middle hole of the technic plate

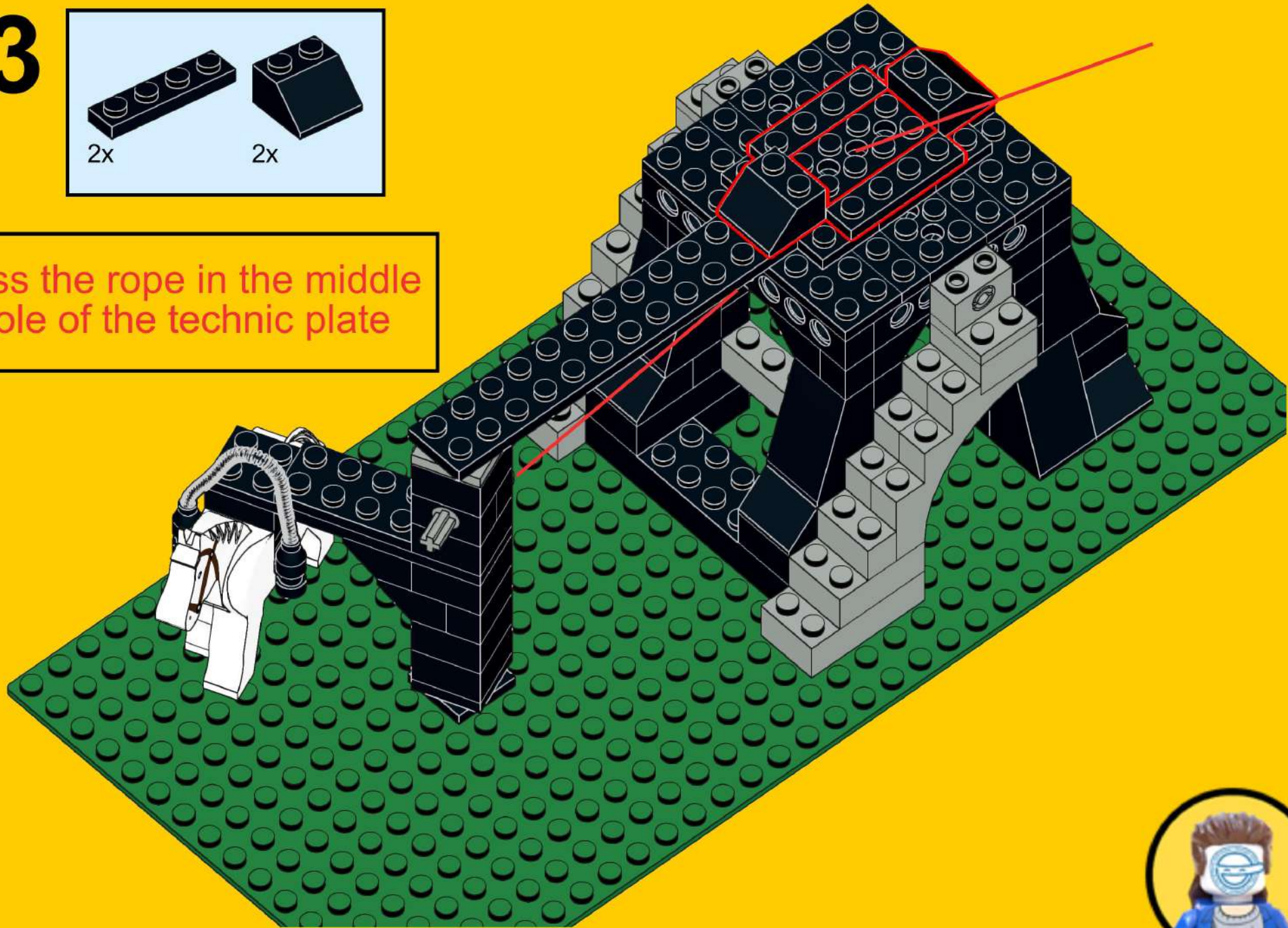

# 34

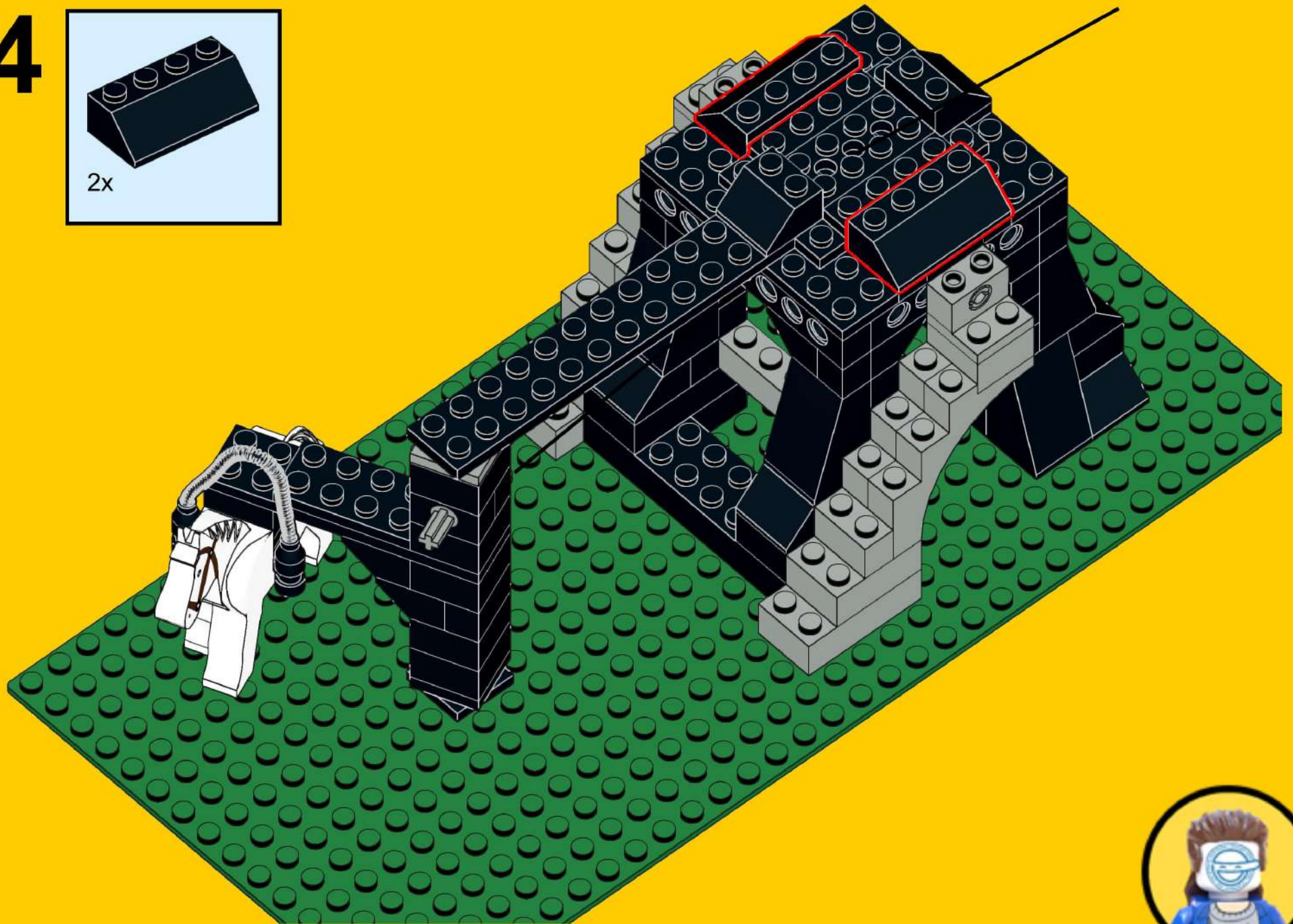
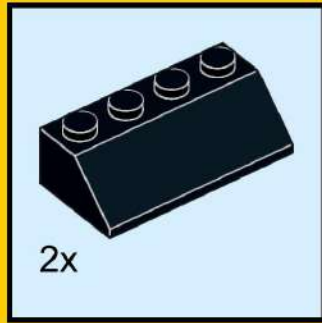

# 35

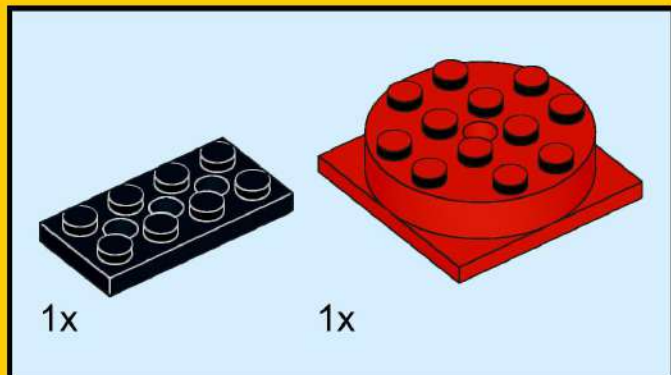

Pass the rope through the turntable and the technic plate

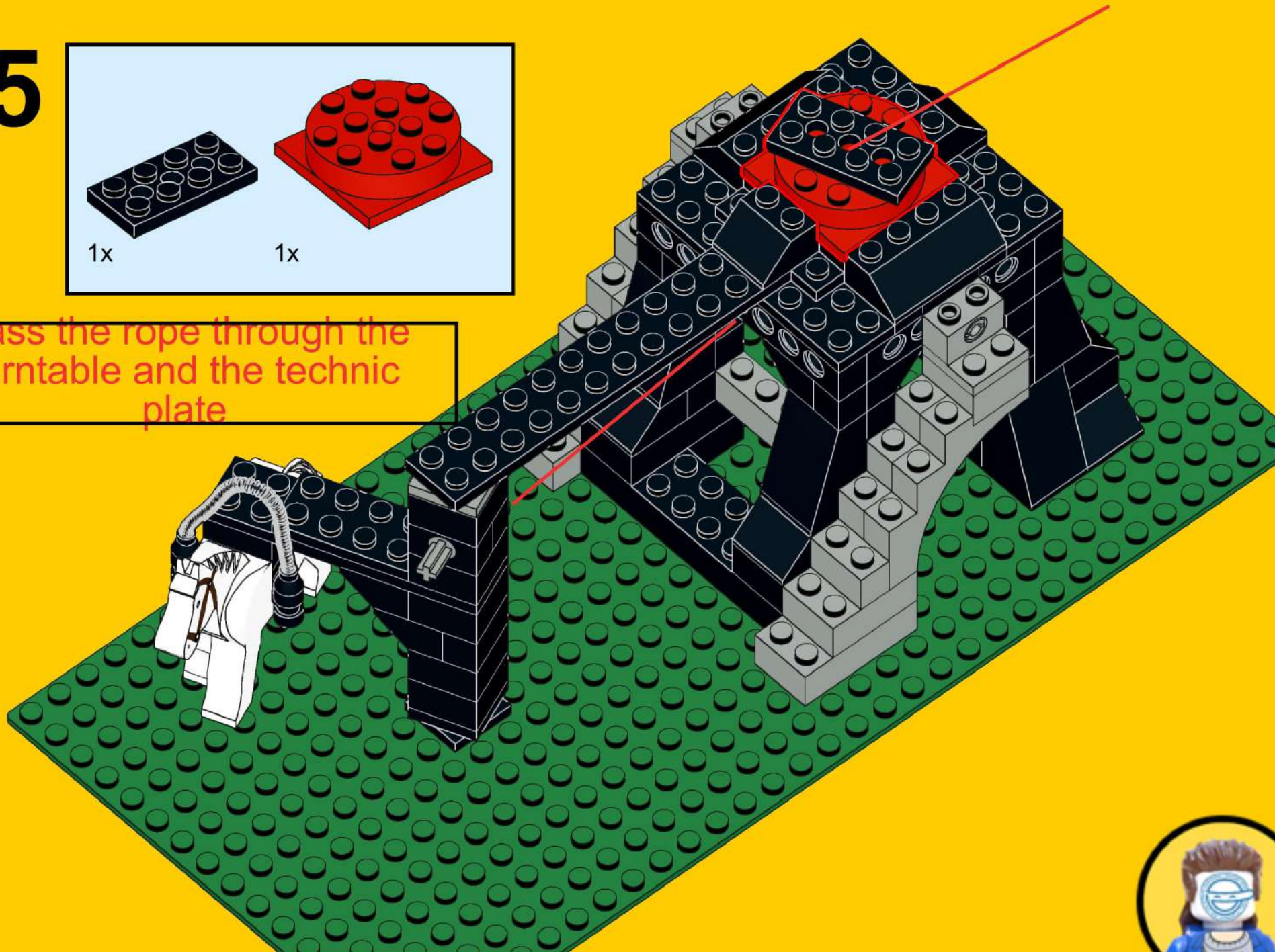

# 36

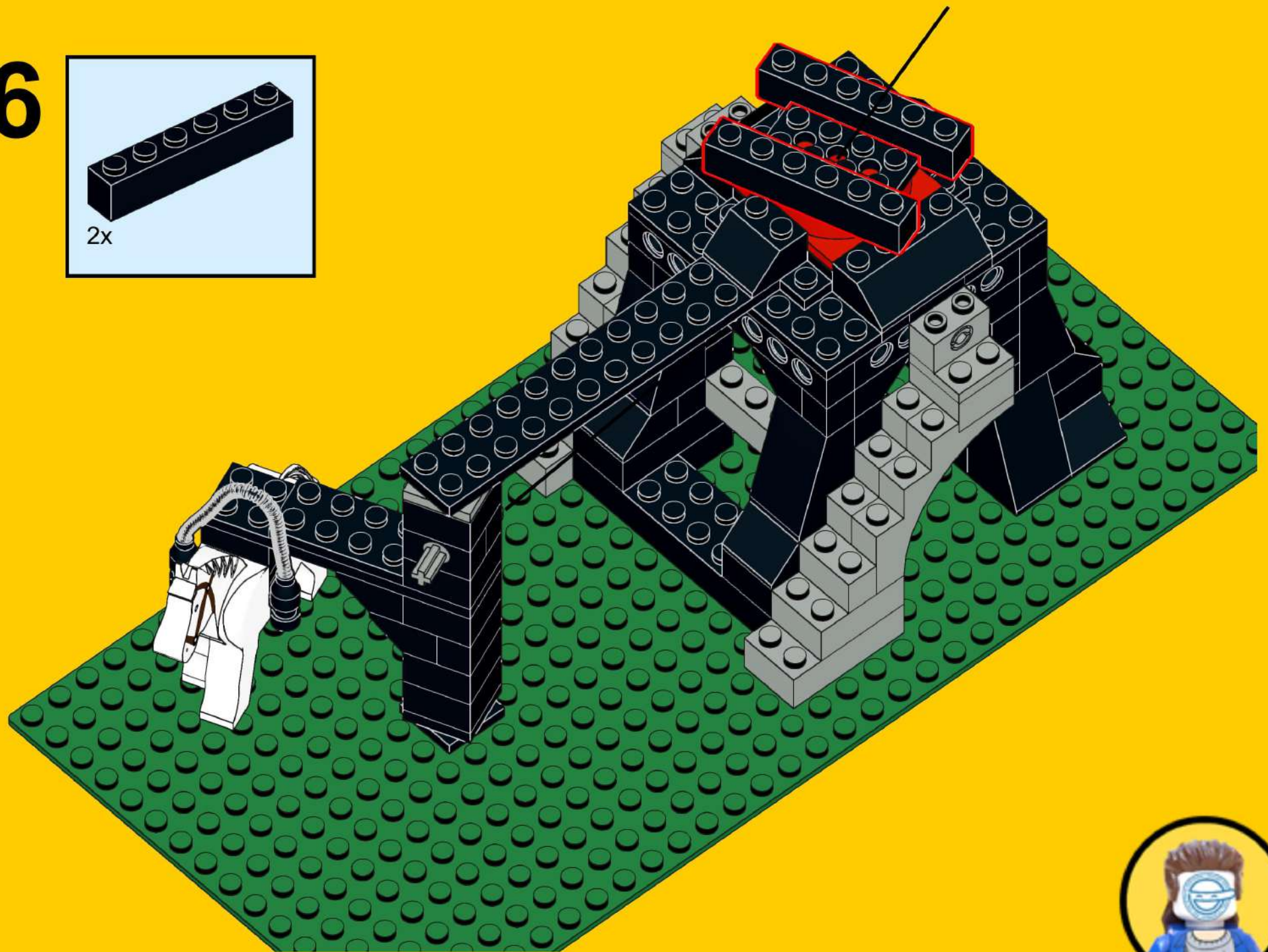
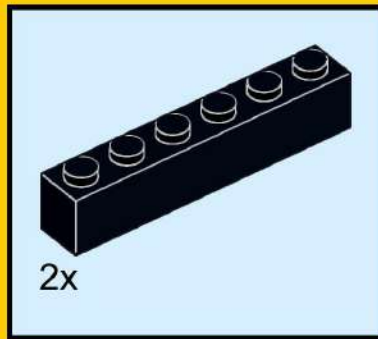

# 37

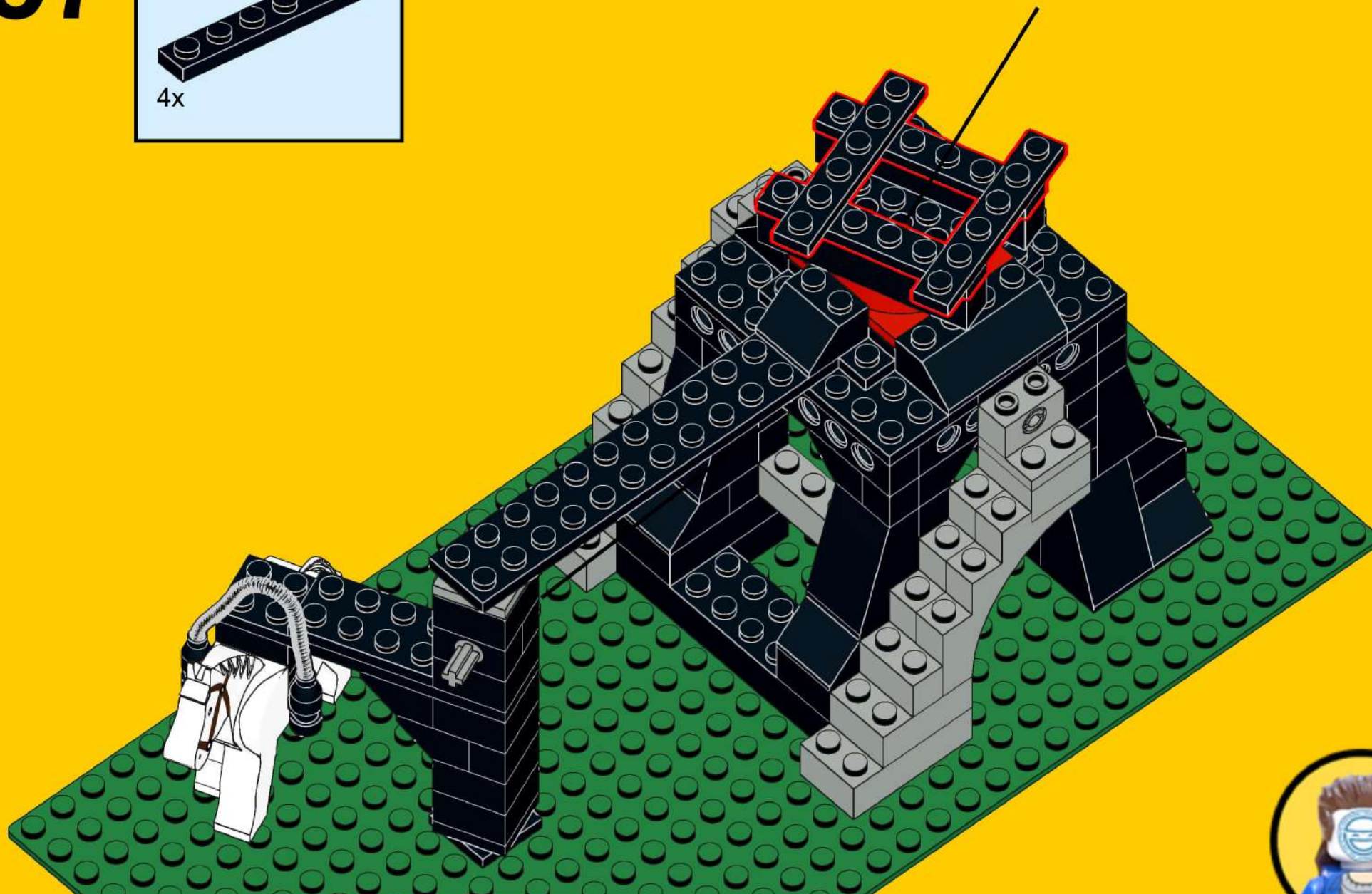
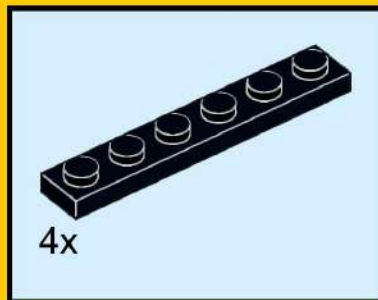

# 38

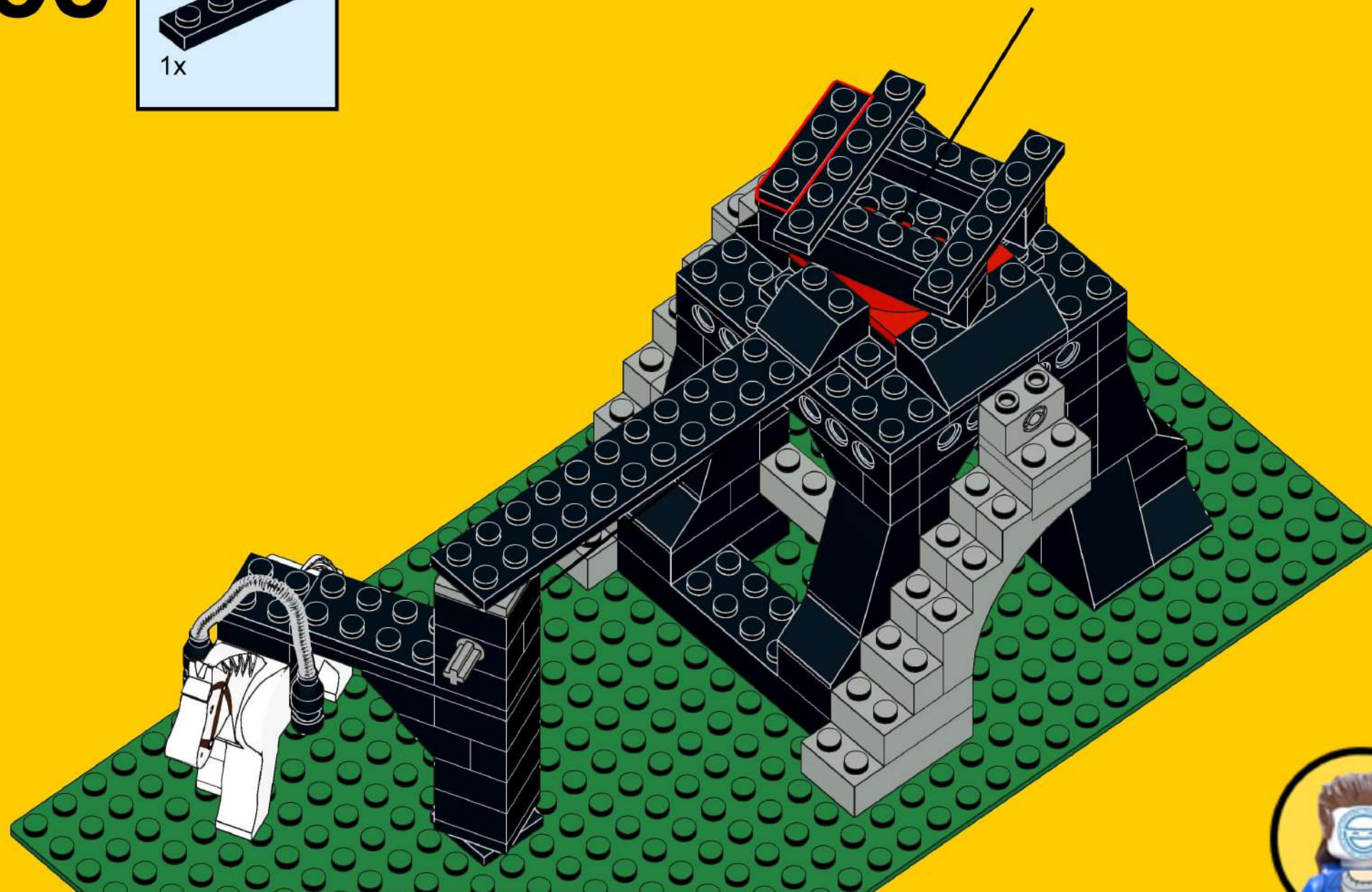
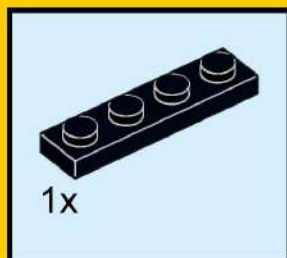

39

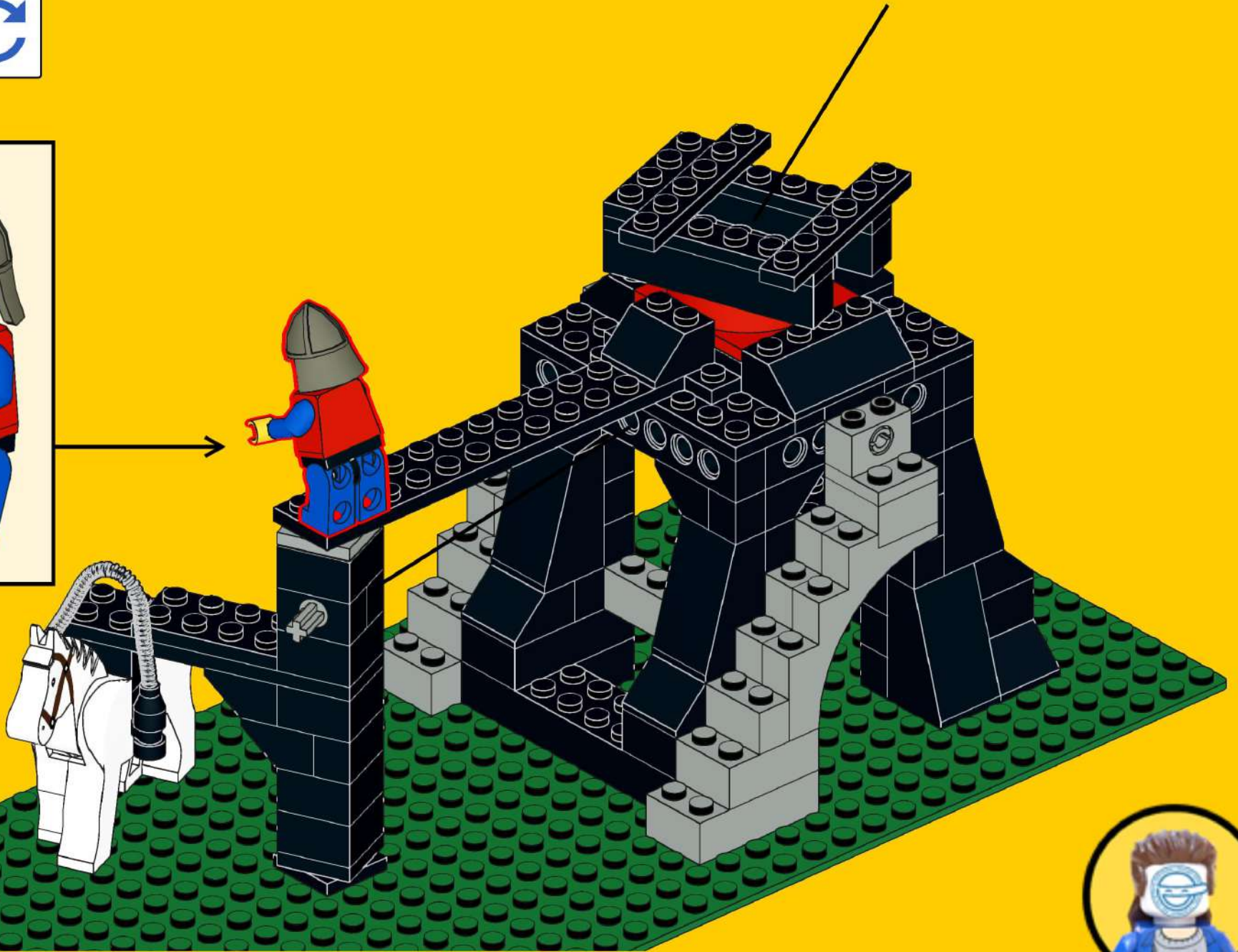



# 40

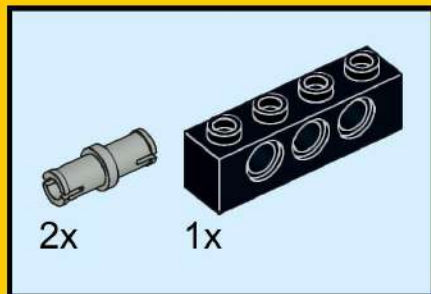

Use this to keep the rope from moving if you don't want to

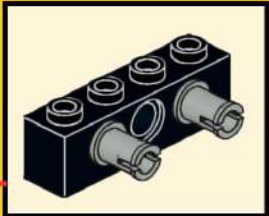
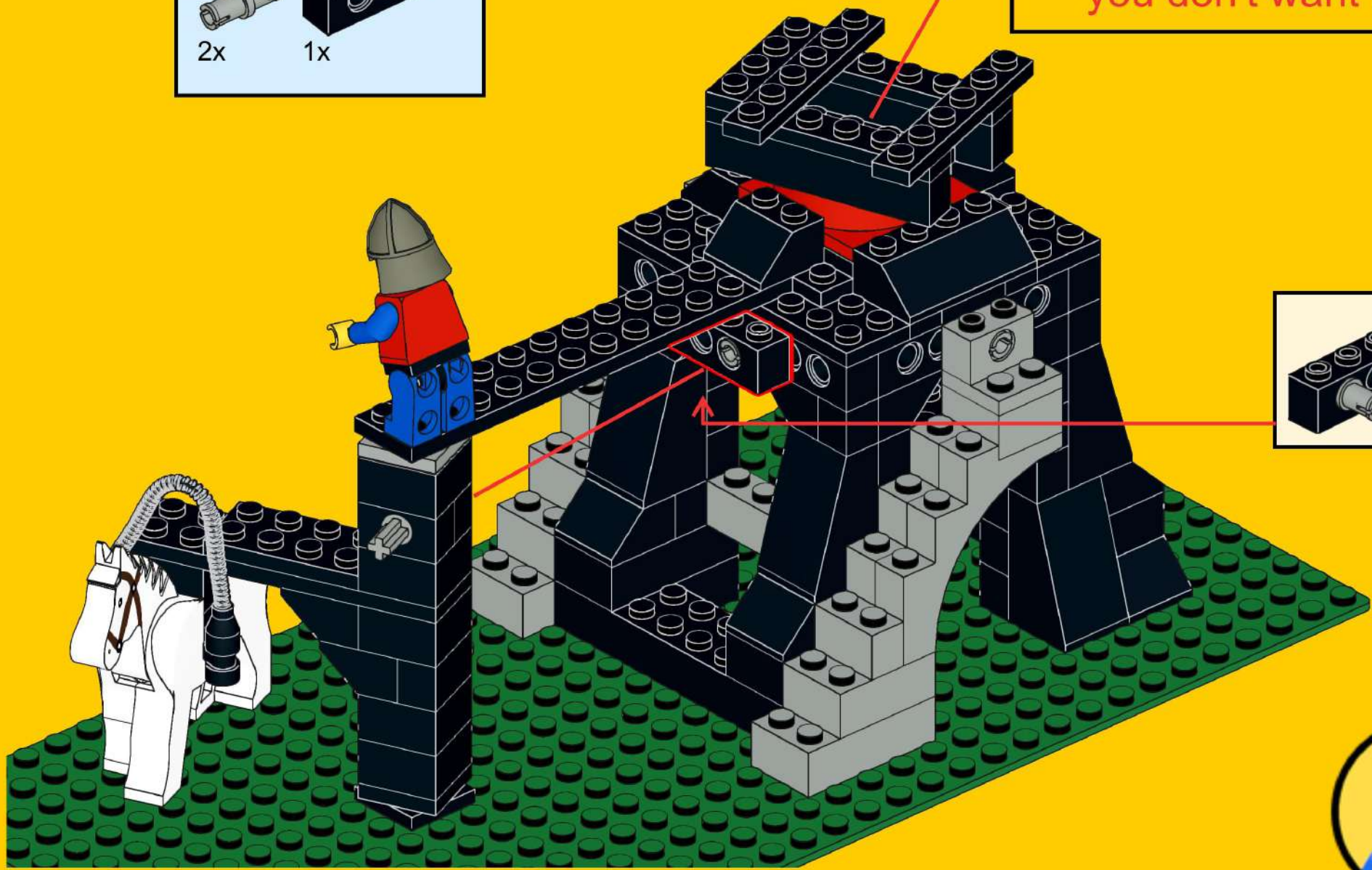

# 41

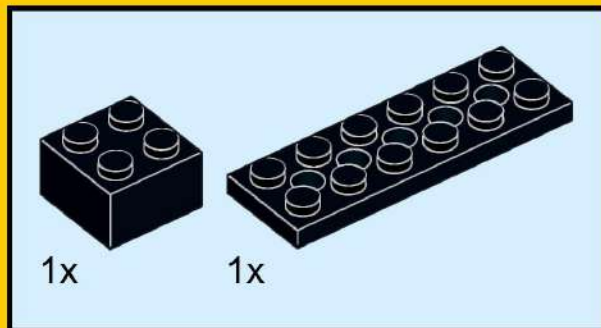

Pass the rope in the middle hole of the technic plate

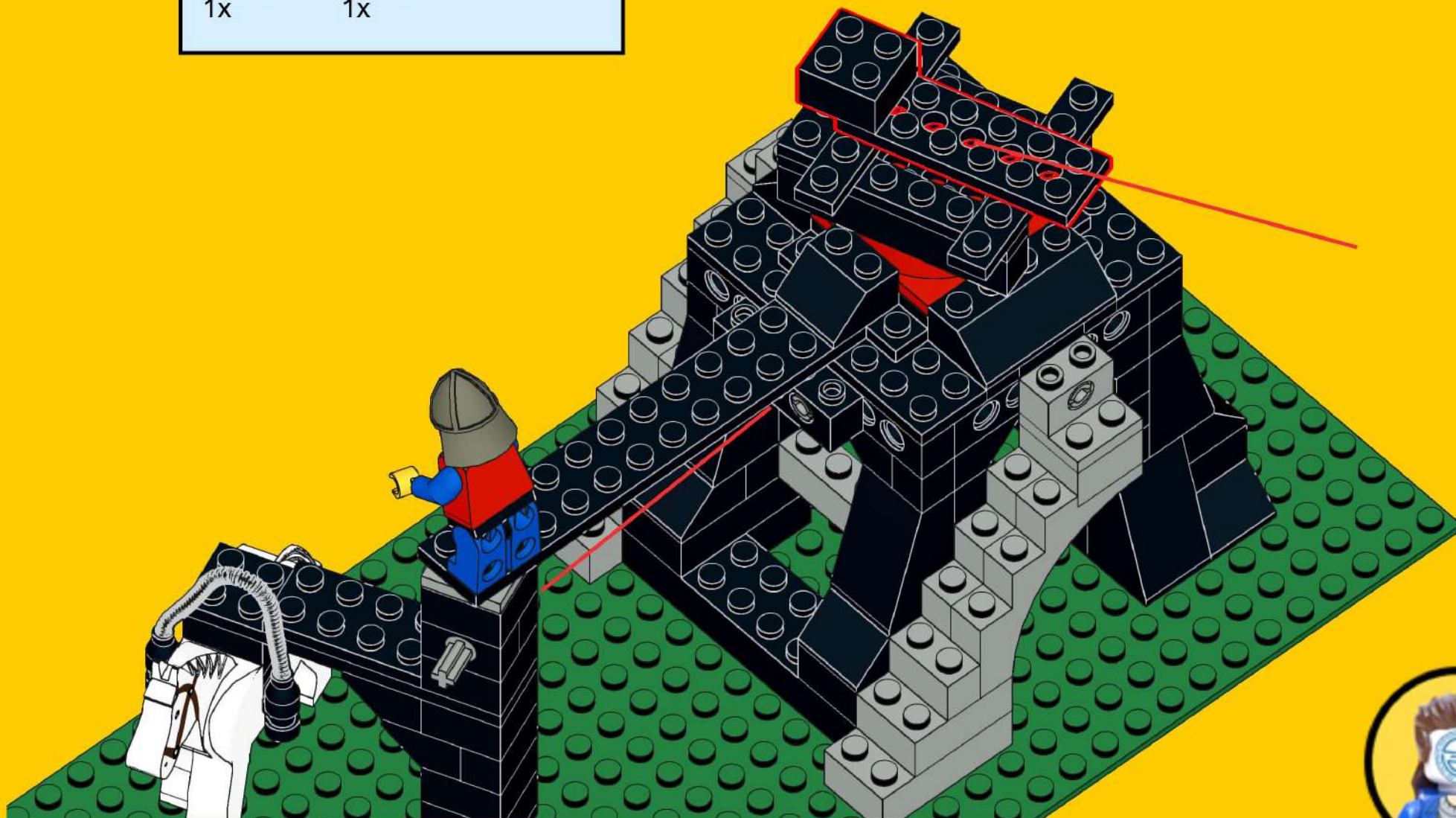

# 42

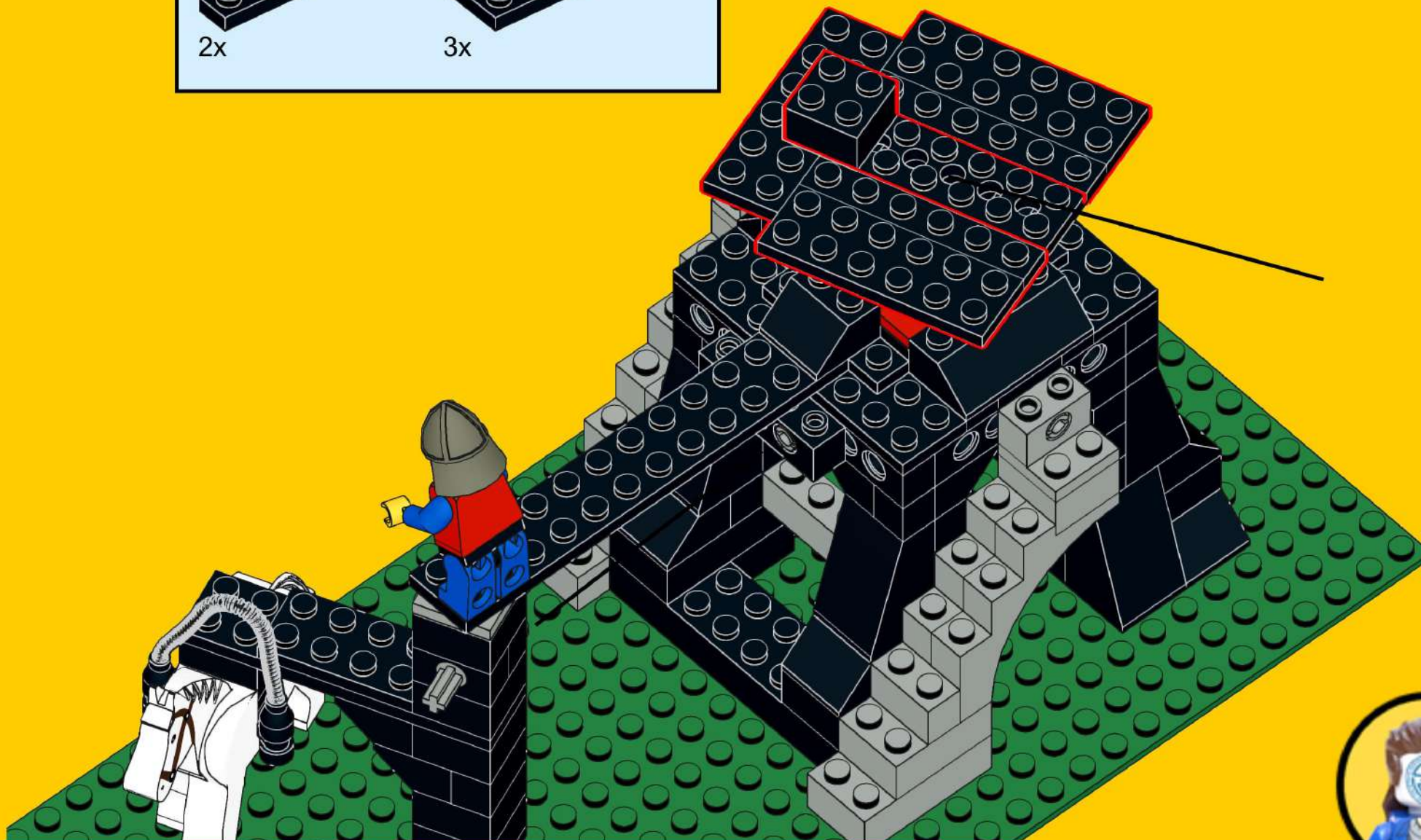
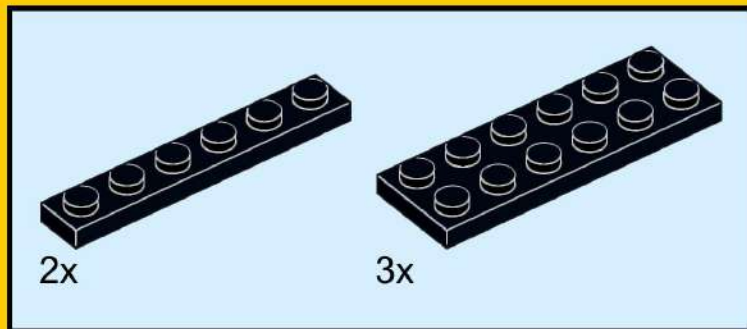

# 43

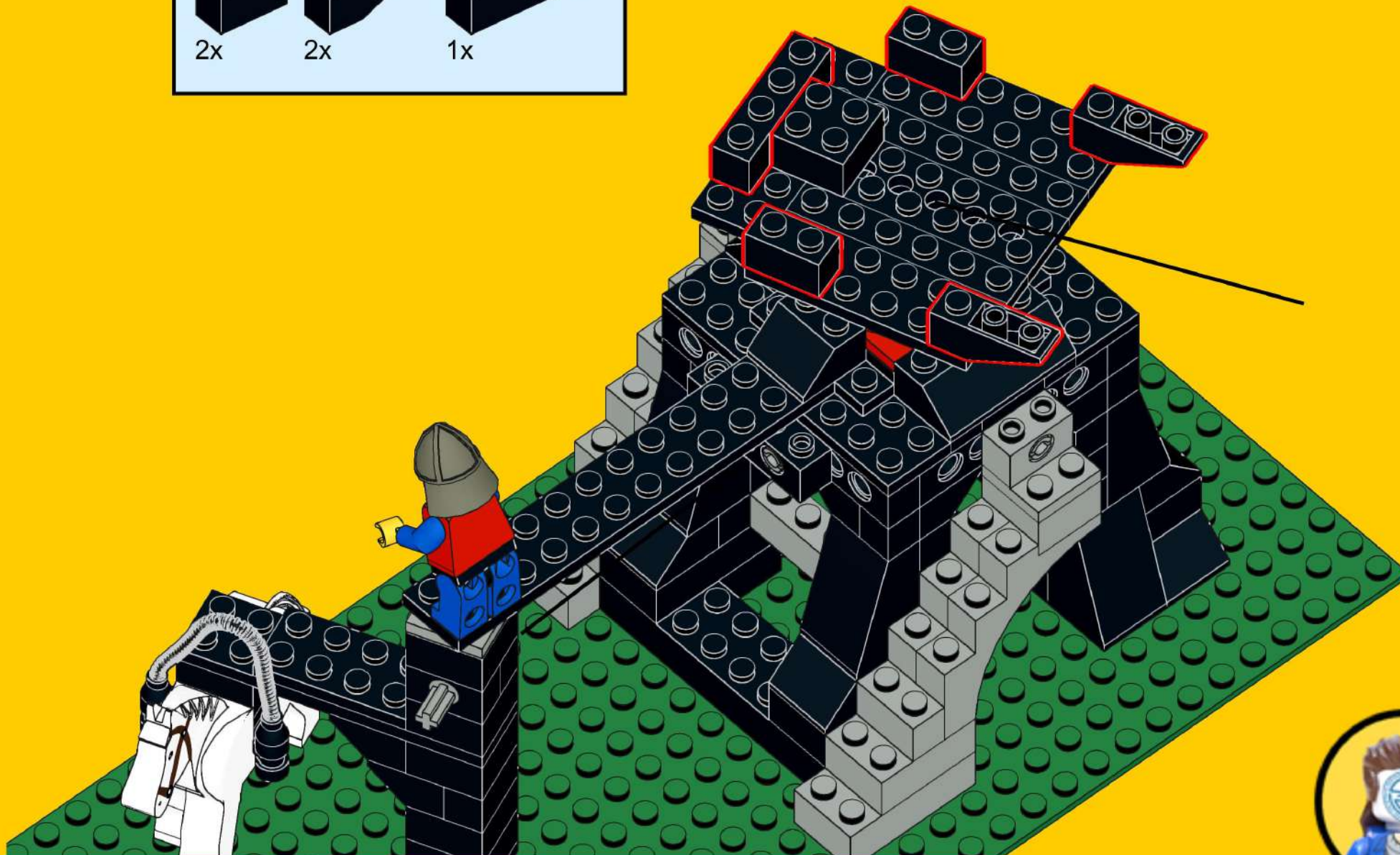
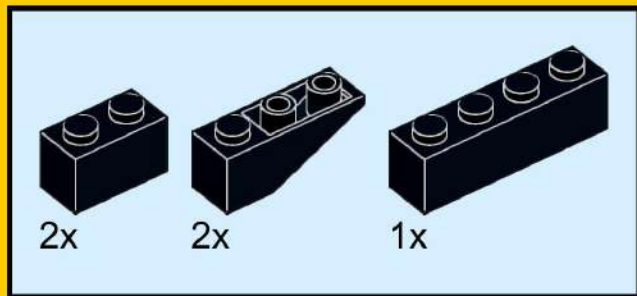

# 44

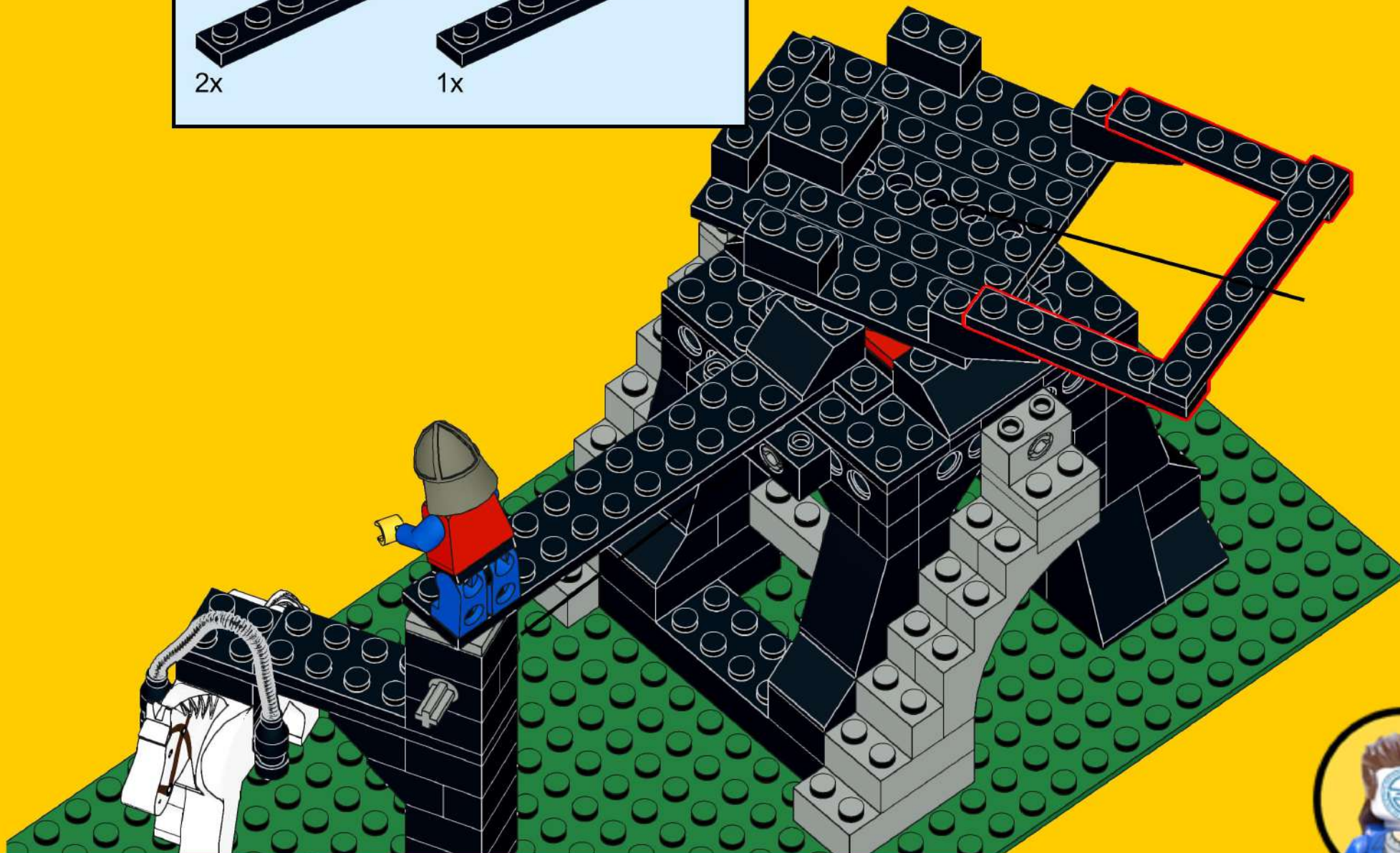
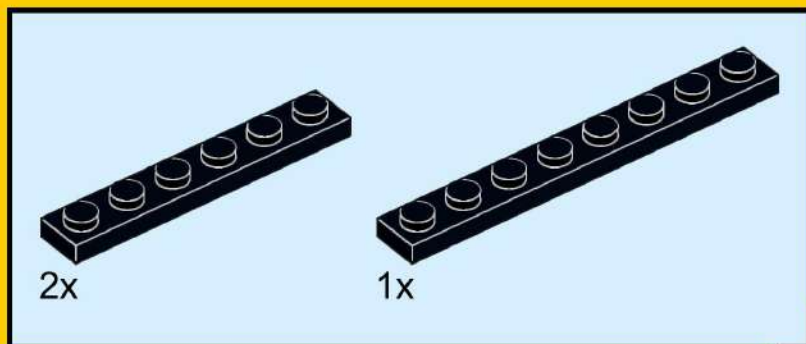

# 45

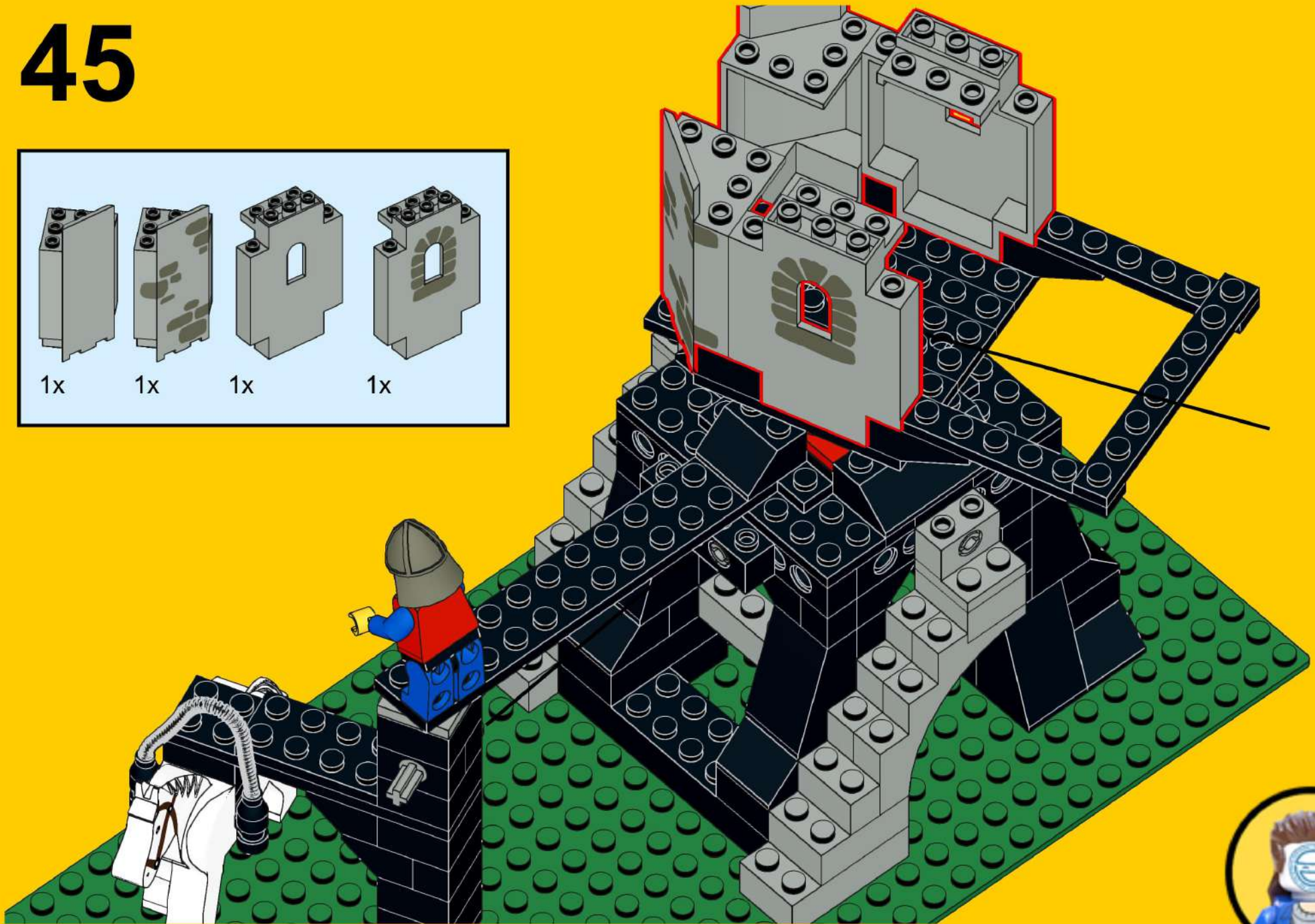
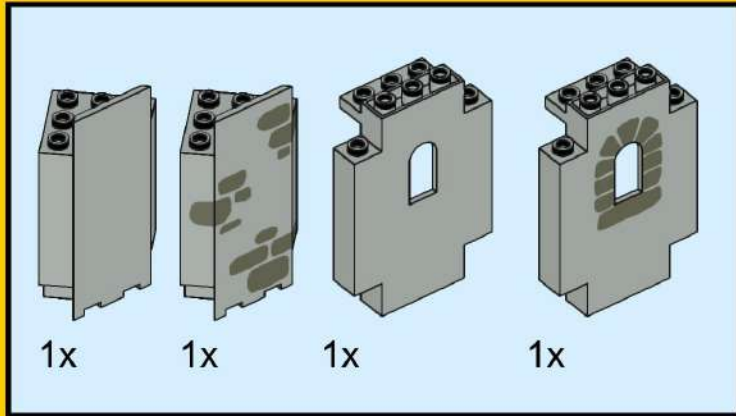

# 46

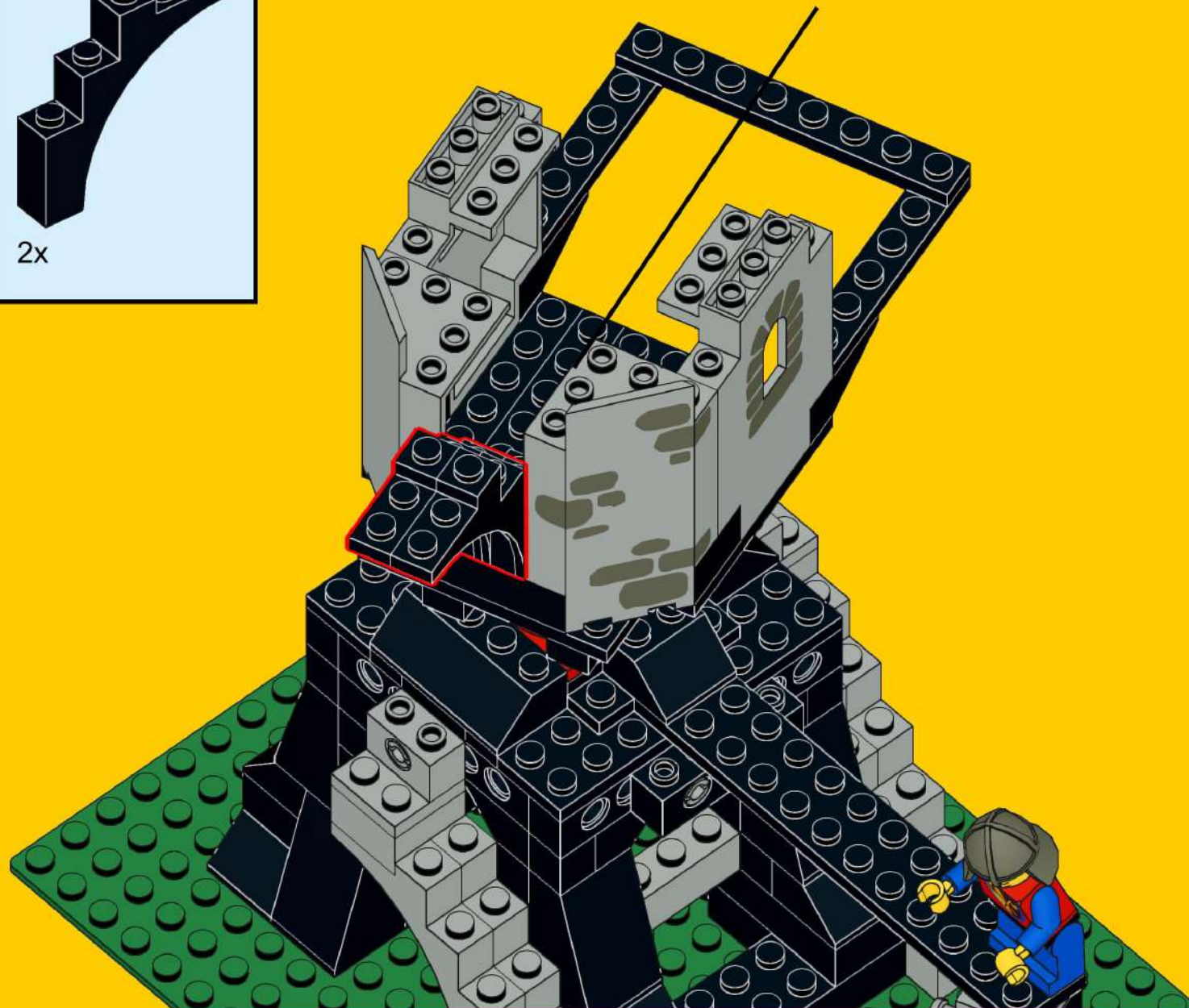
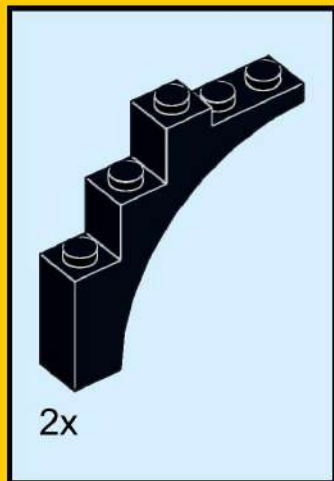

# 47

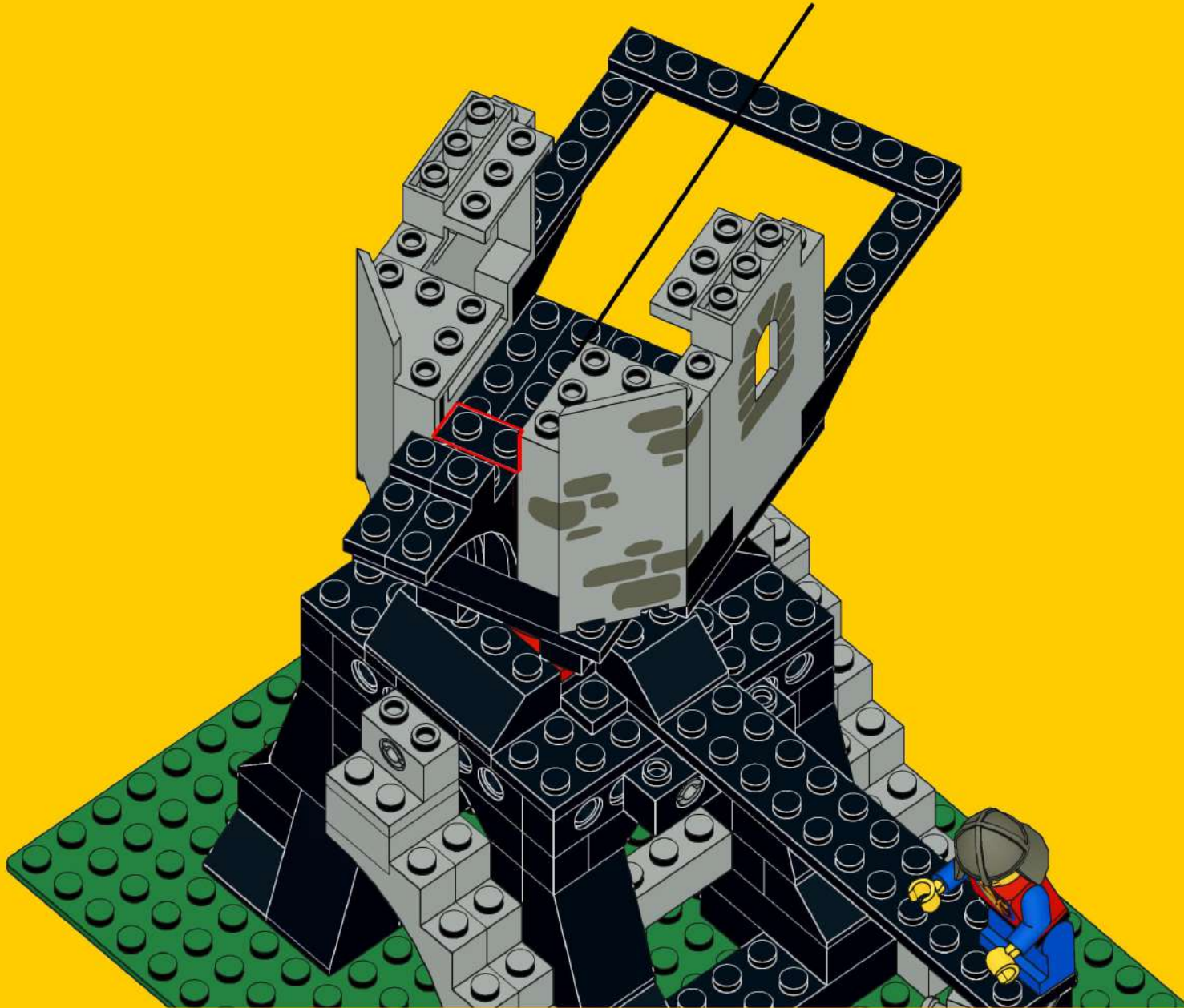
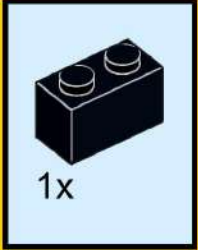



# 48

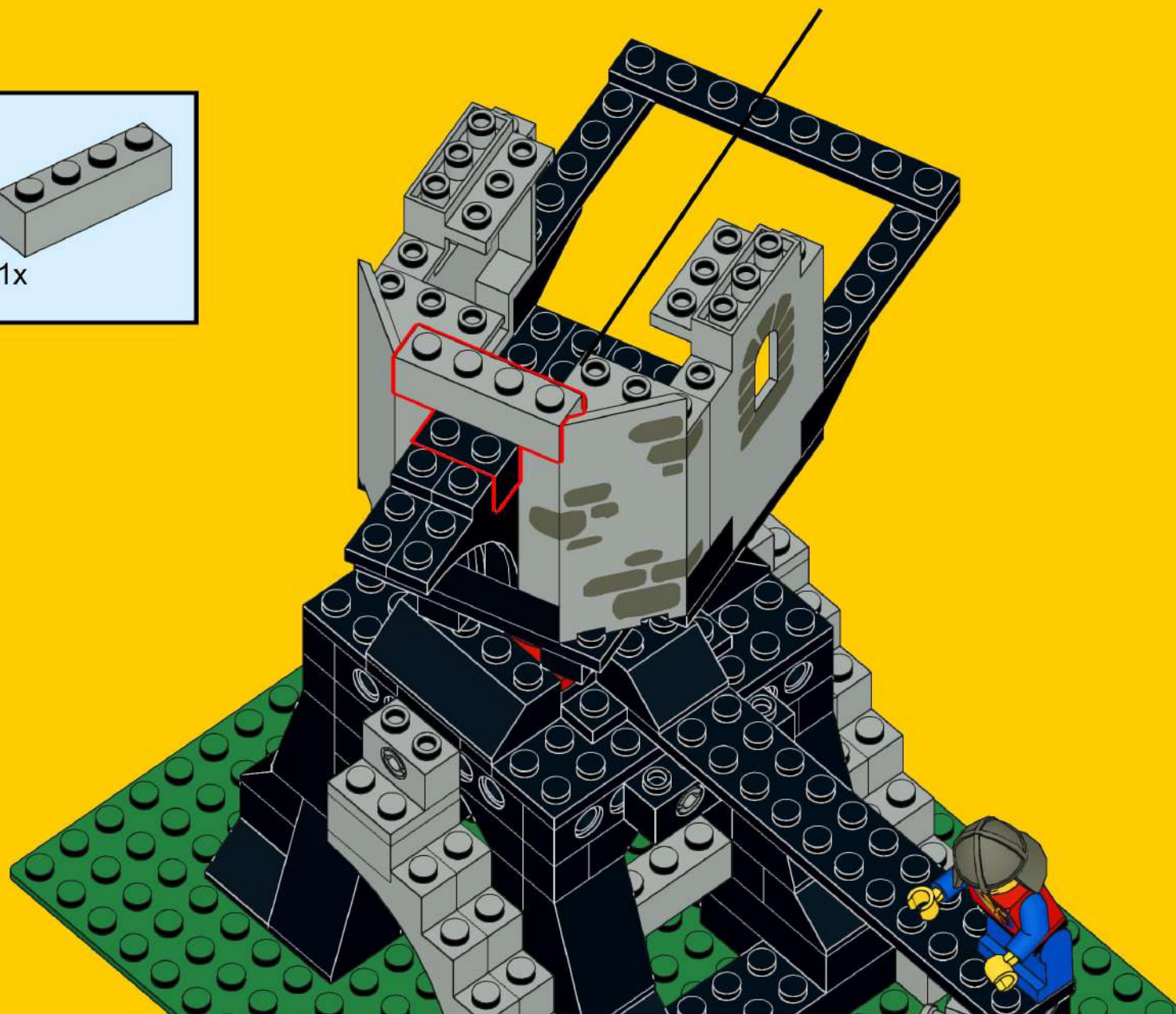
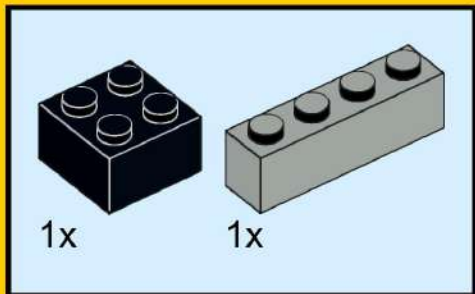

# 49

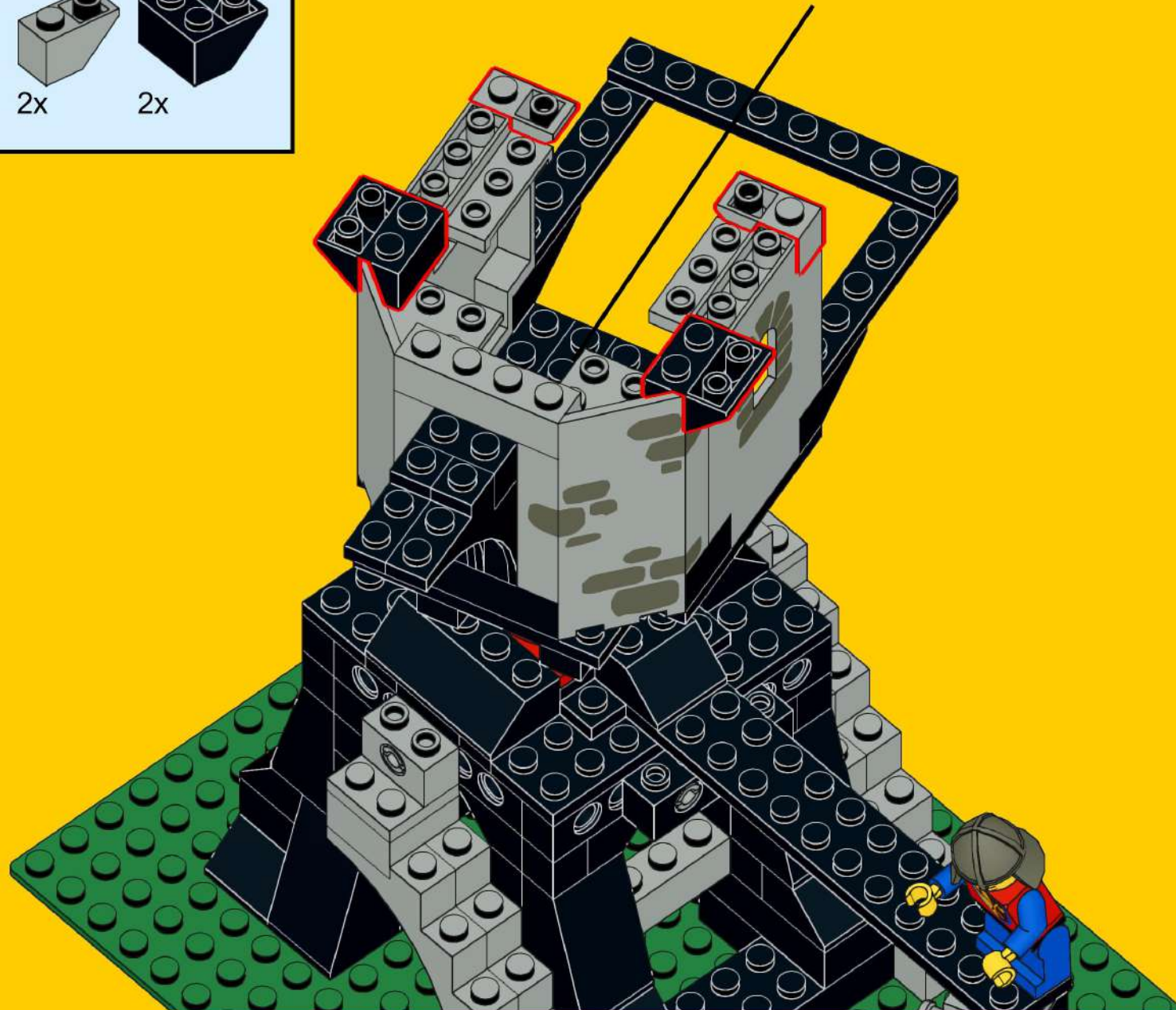
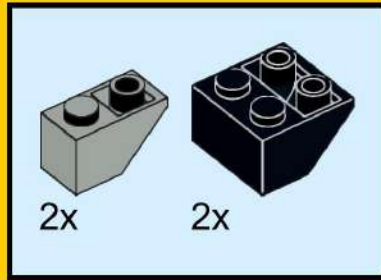

# 50

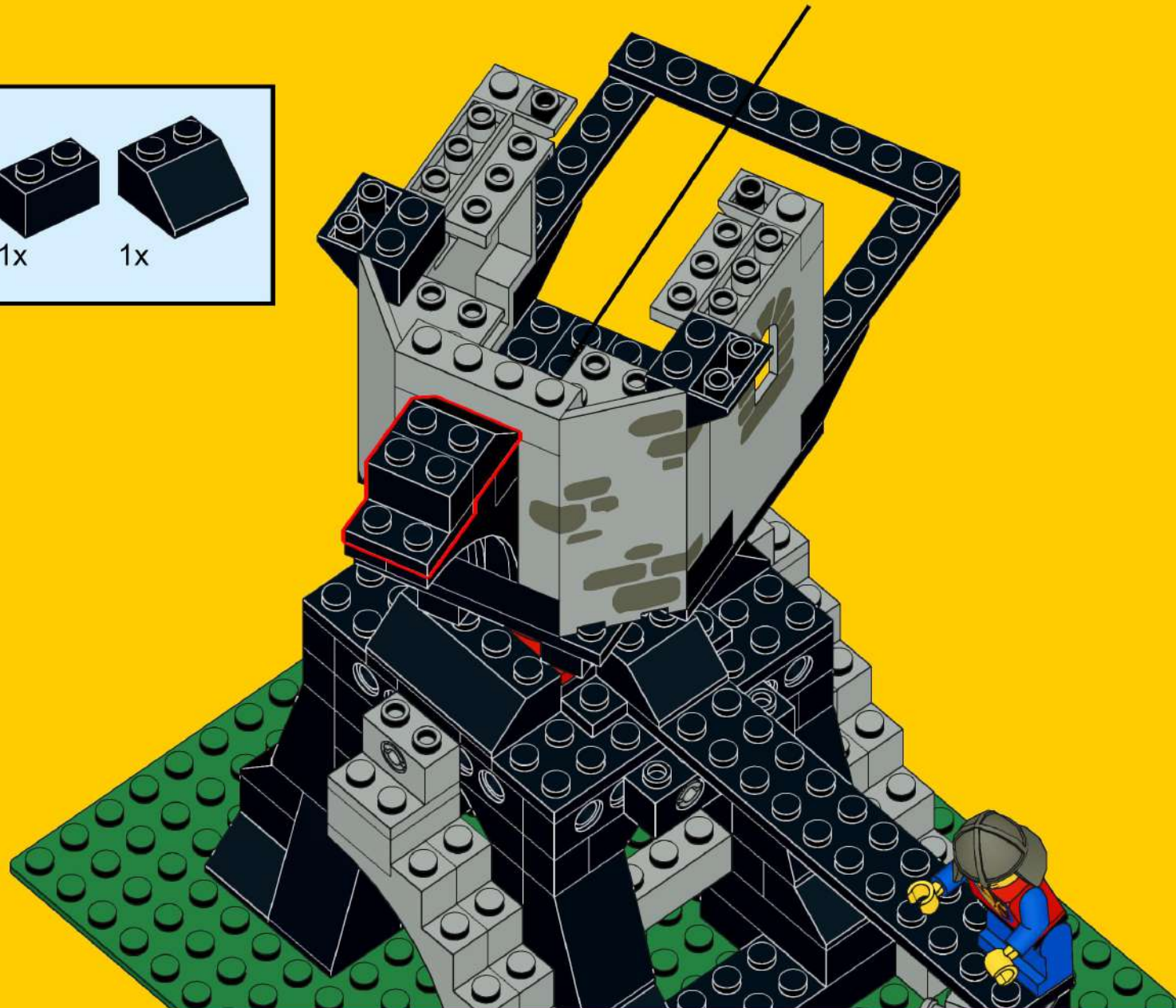
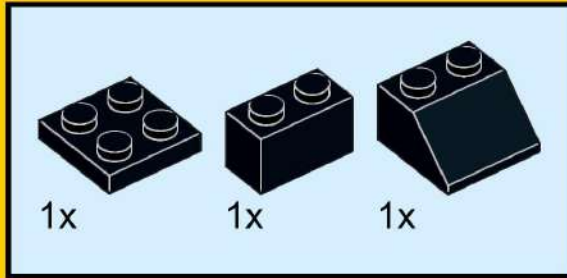

# 51

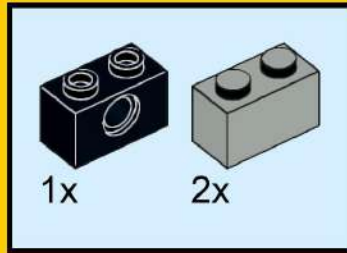

Pass the rope through the technic brick

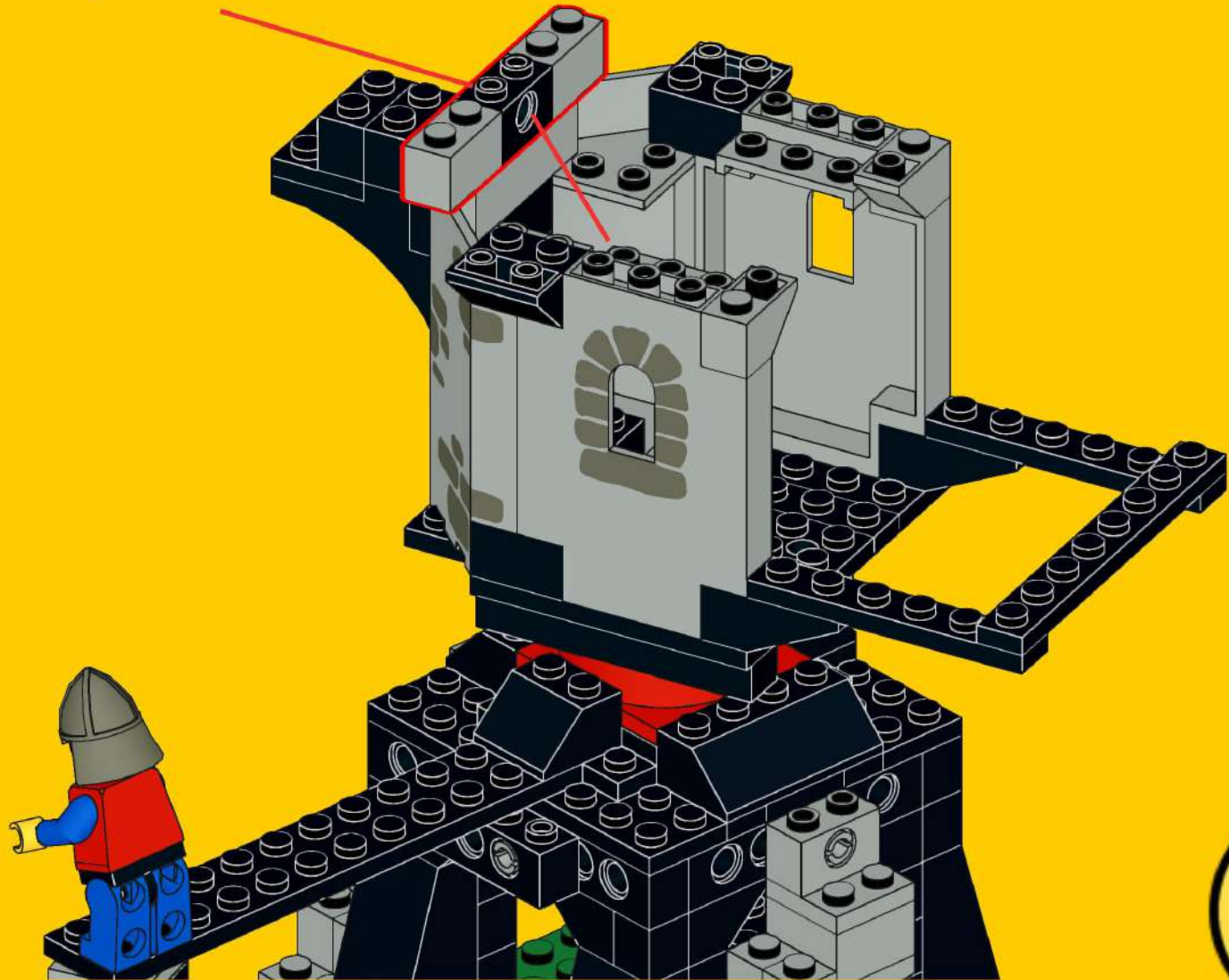

# 52

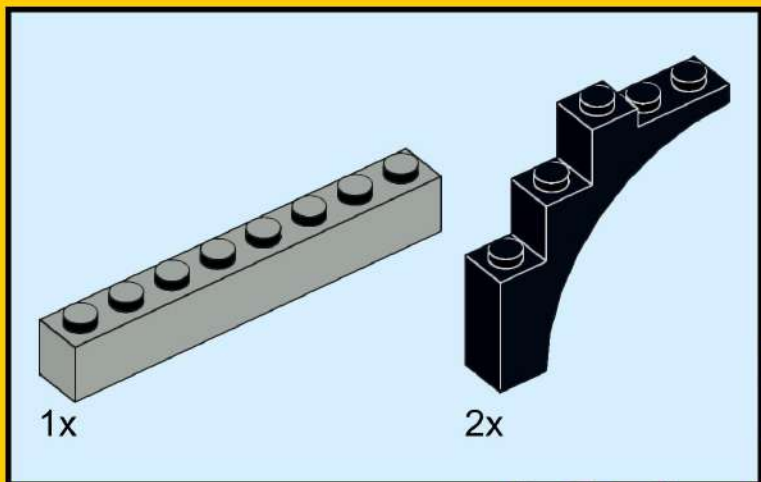
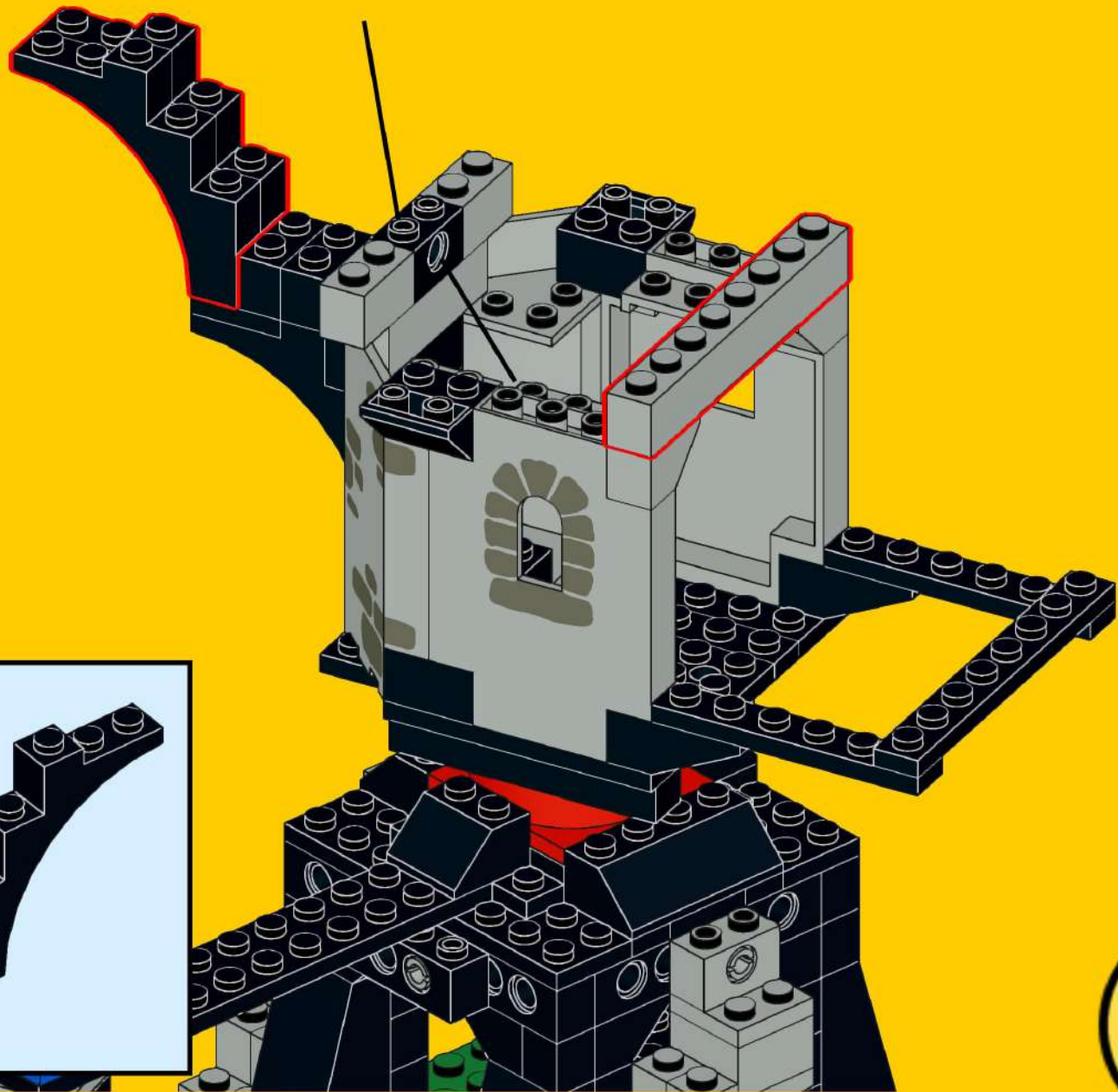

# 53

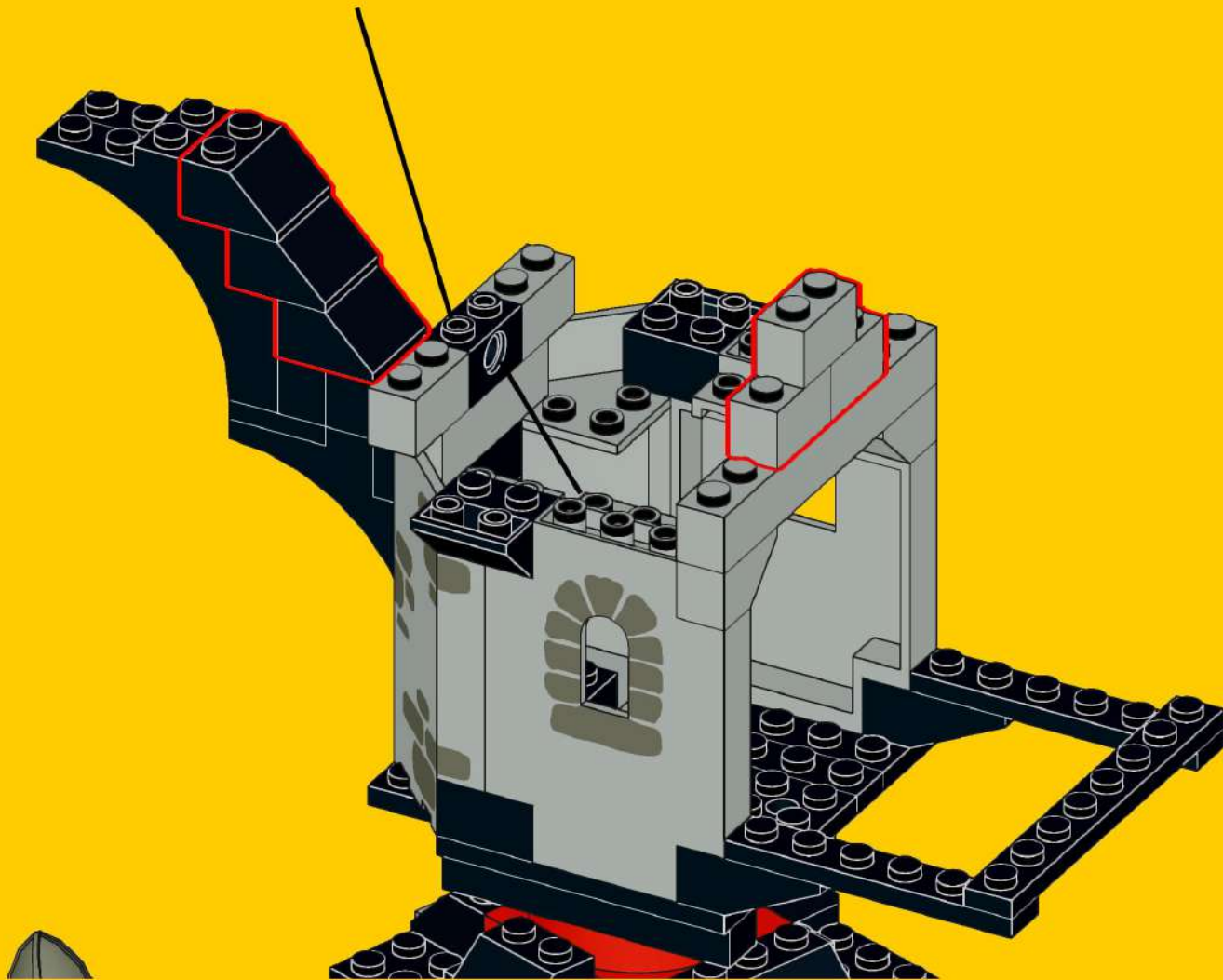
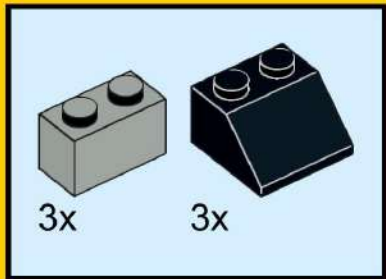

# 54

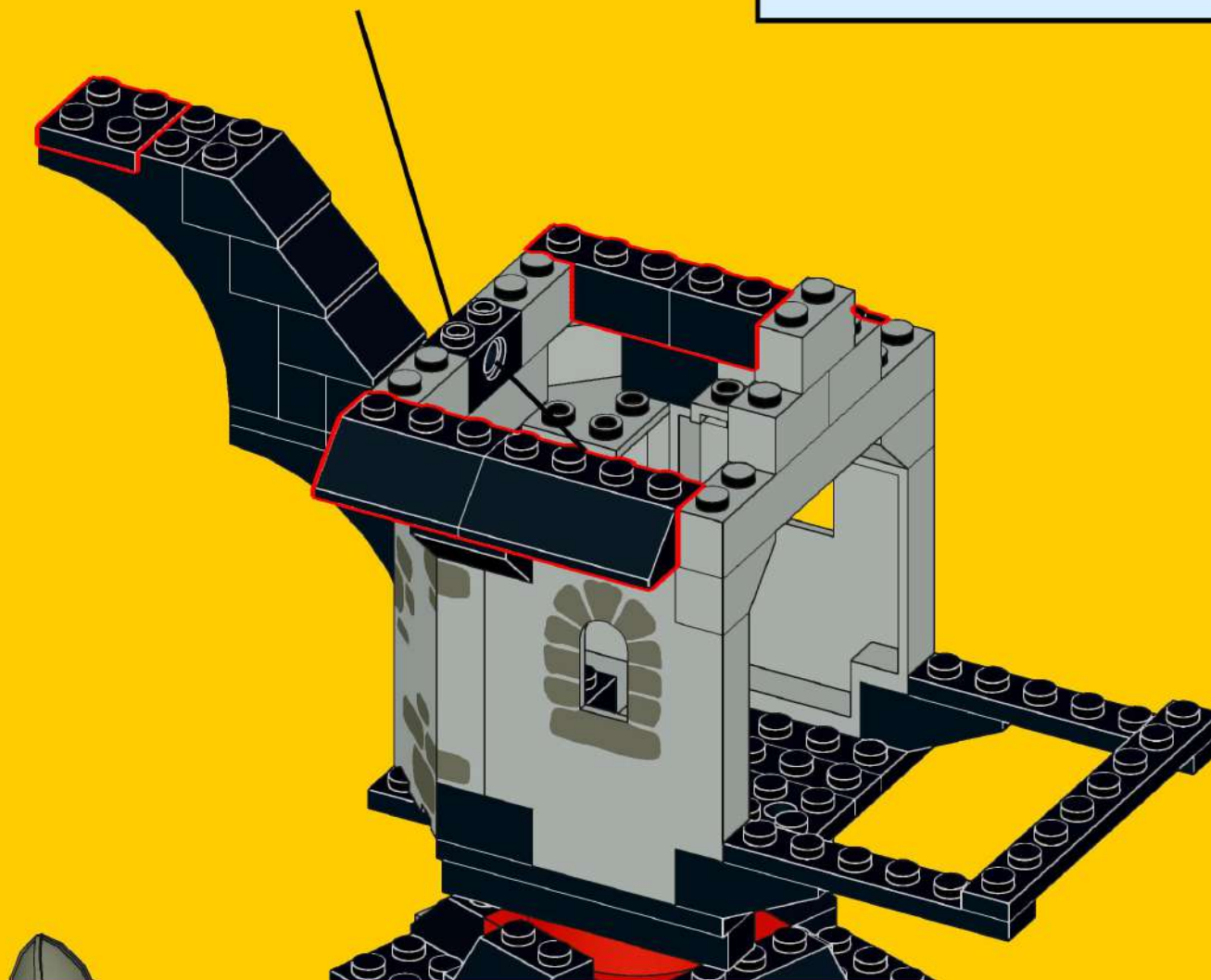
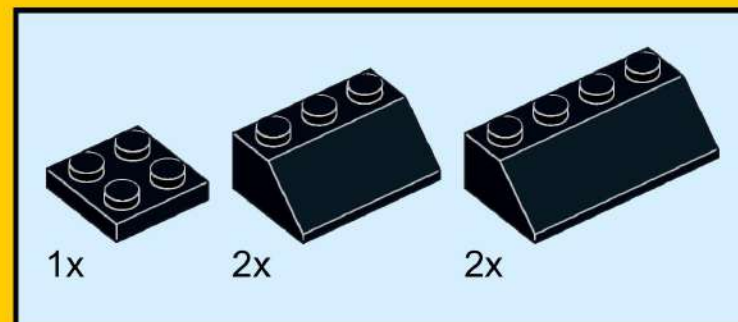

# 55

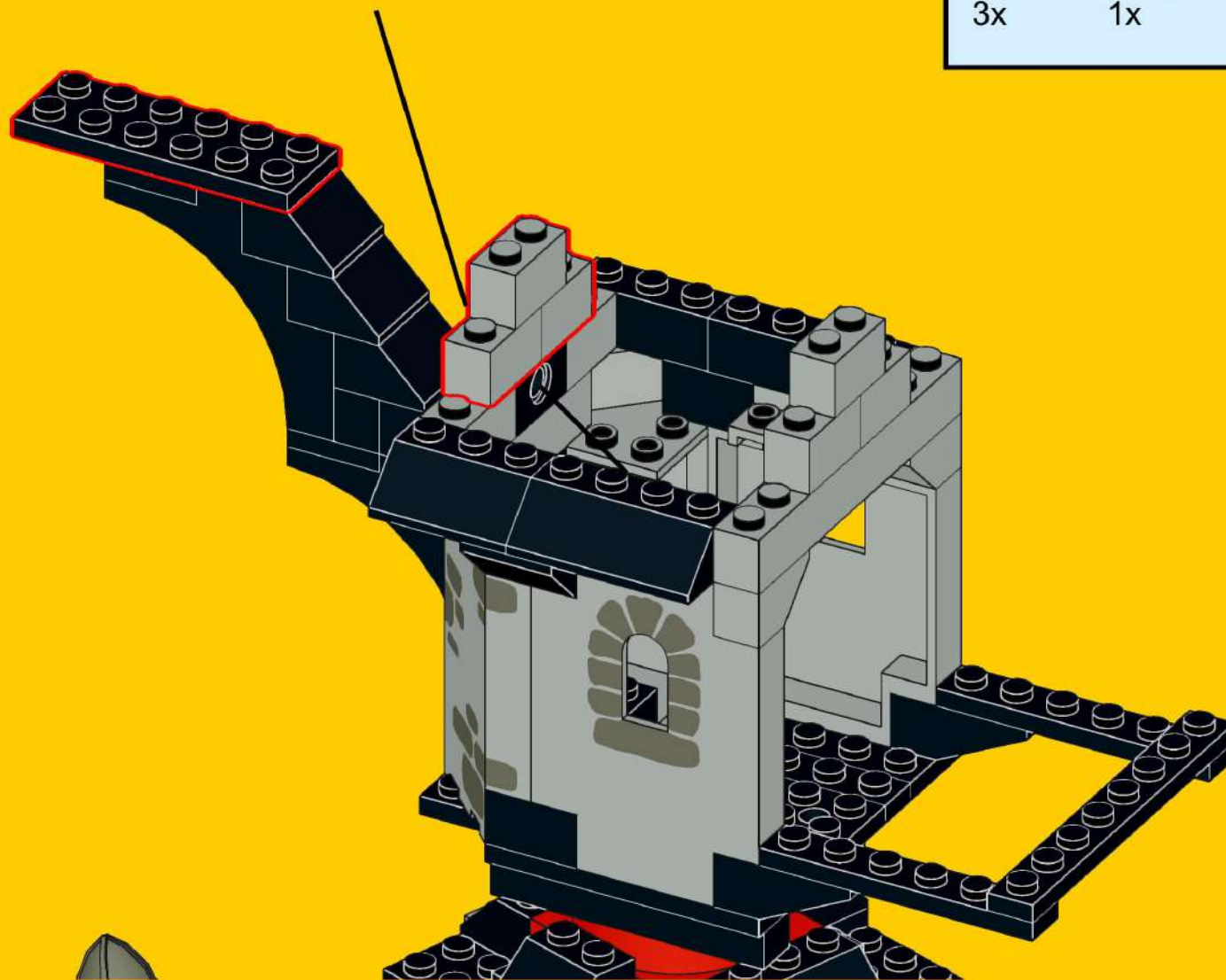
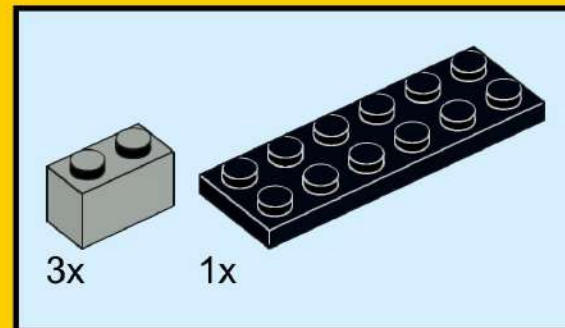



# 56

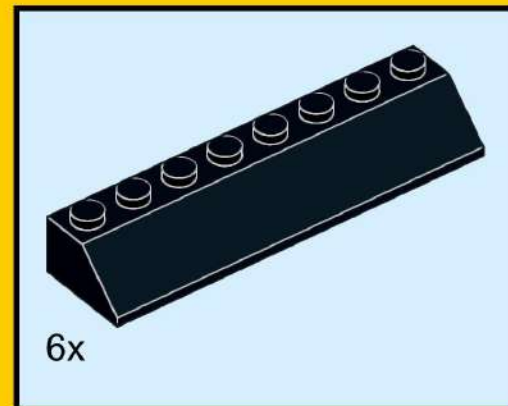
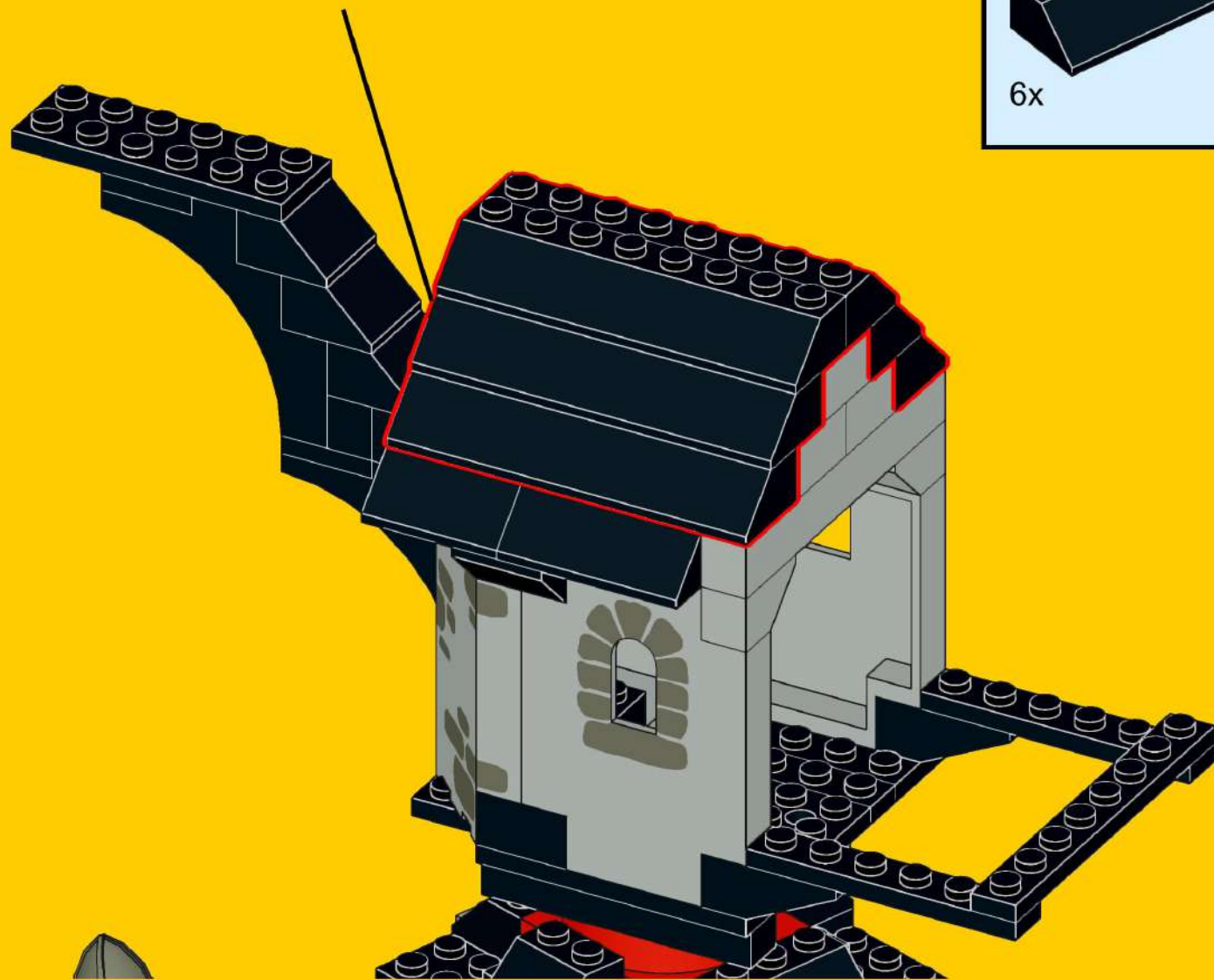

# 57

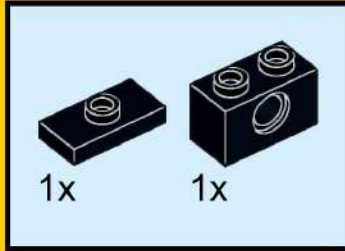

Pass the rope through  
the technic brick

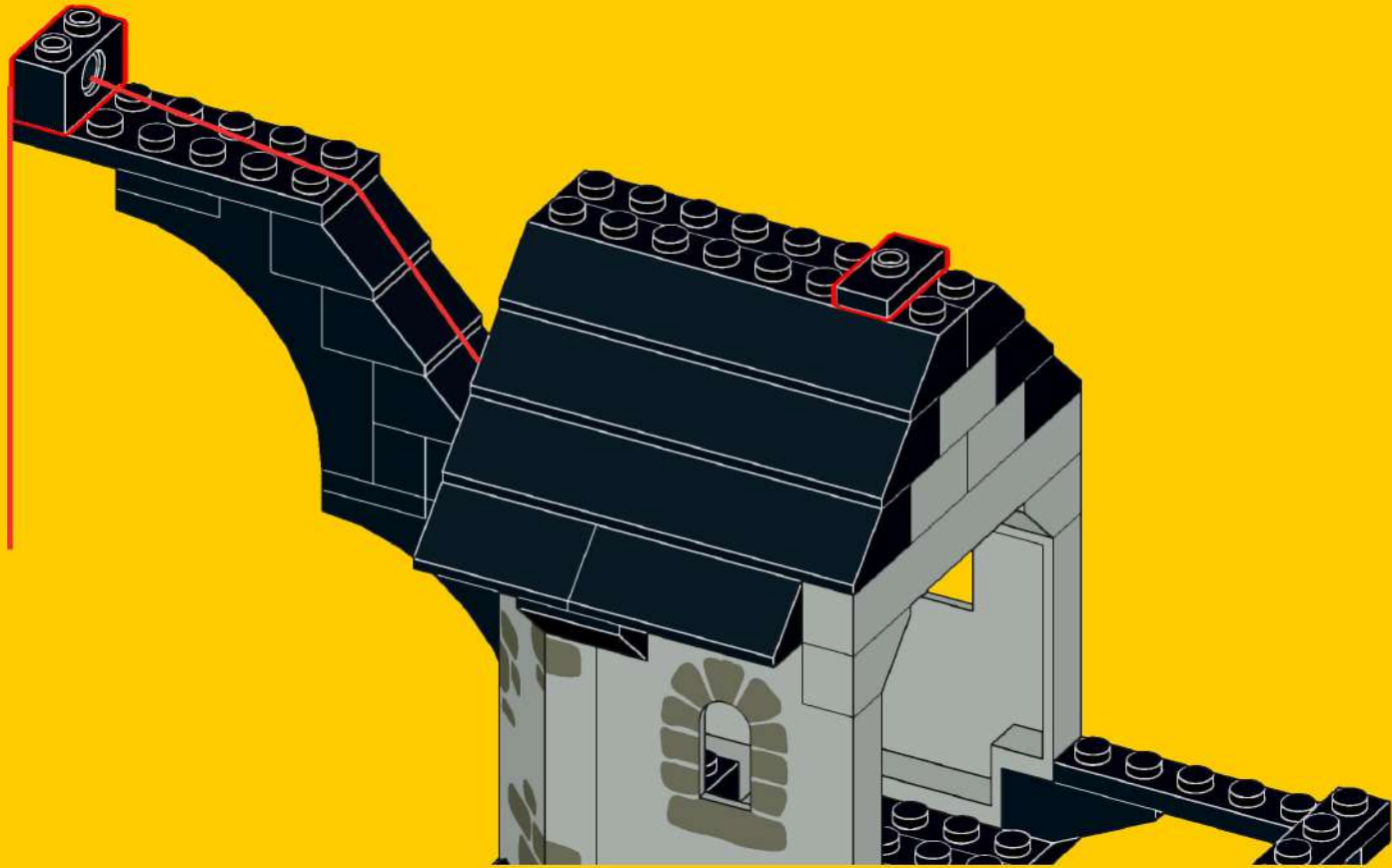

# 58

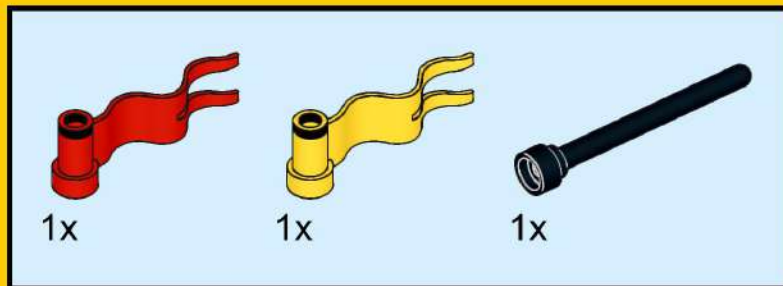

# 59

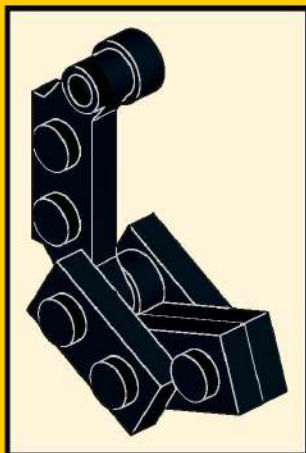

# 60

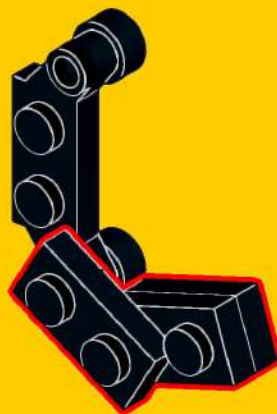
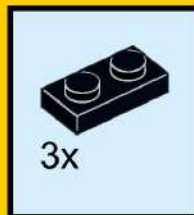

# 61

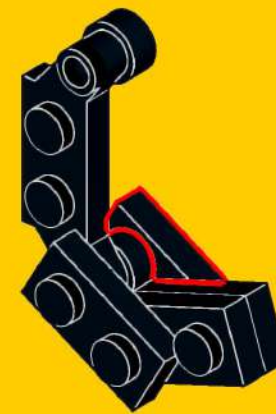
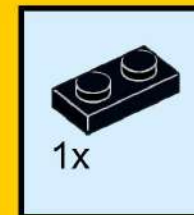

# 62

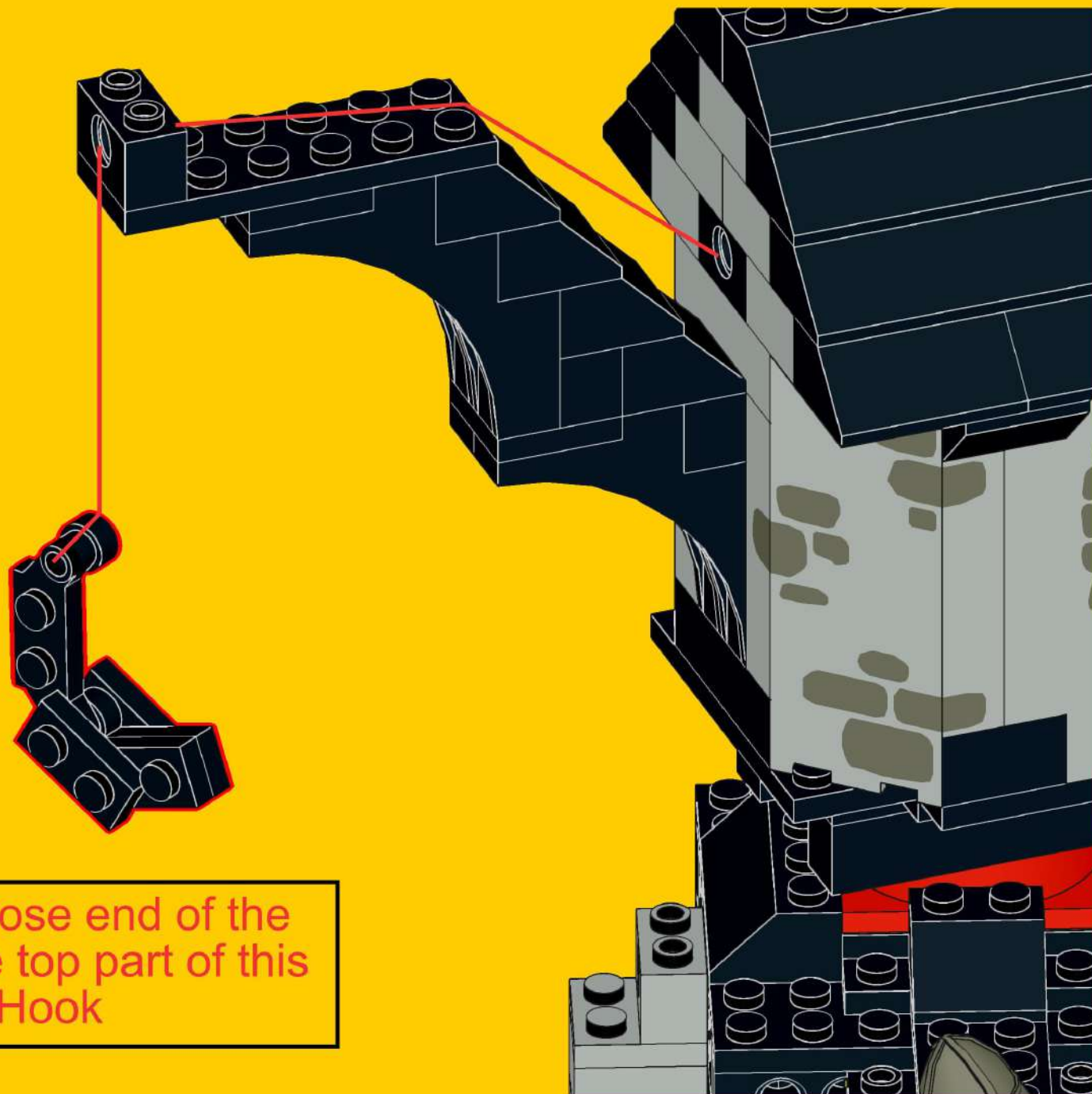

Tie the loose end of the knot to the top part of this Hook



# 63

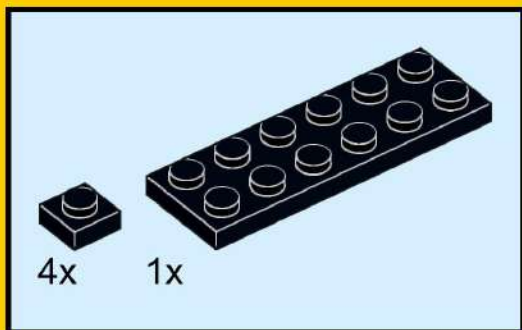
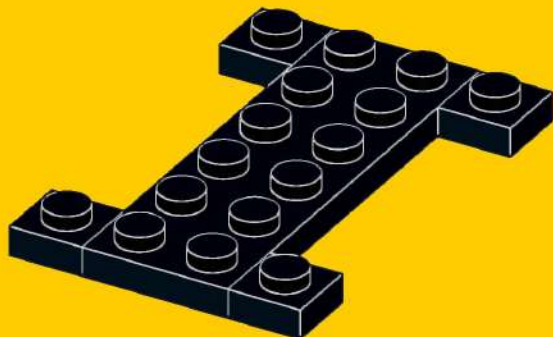
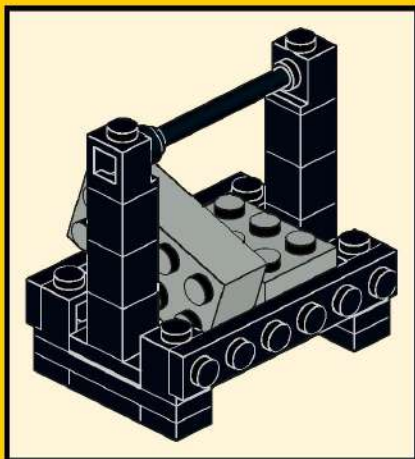

# 64

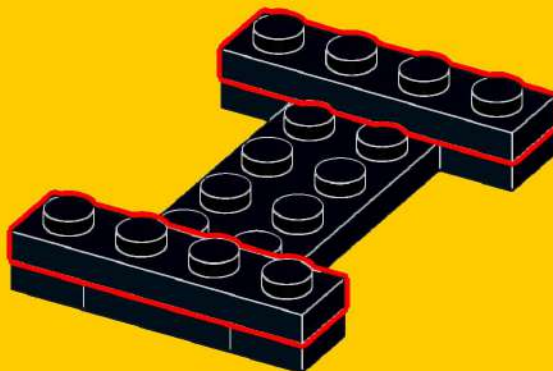
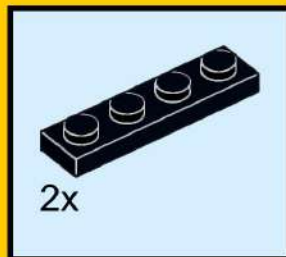

# 65

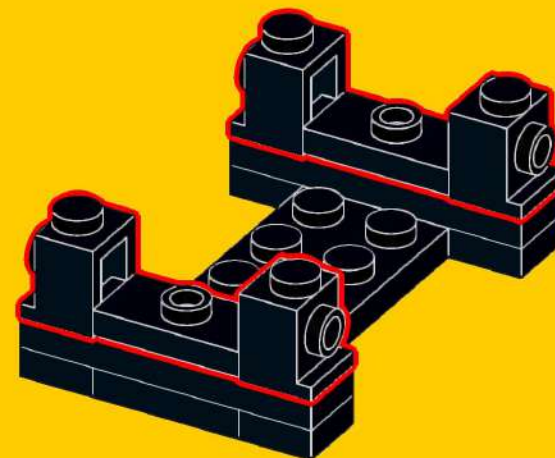
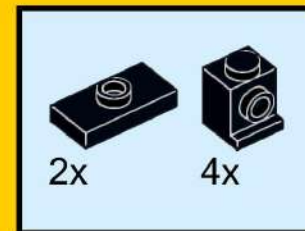

# 66

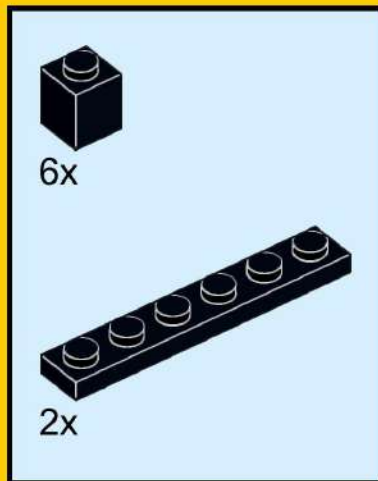

# 67

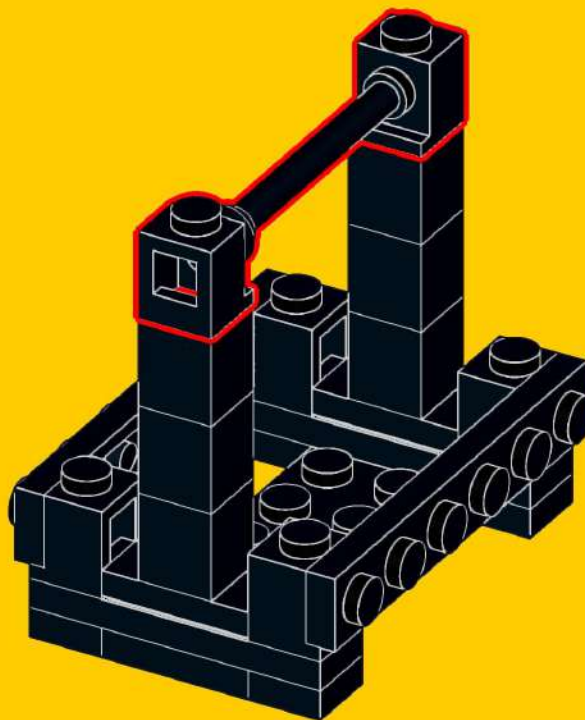
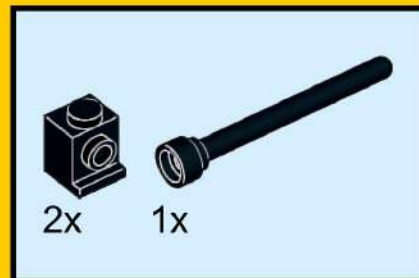

# 68

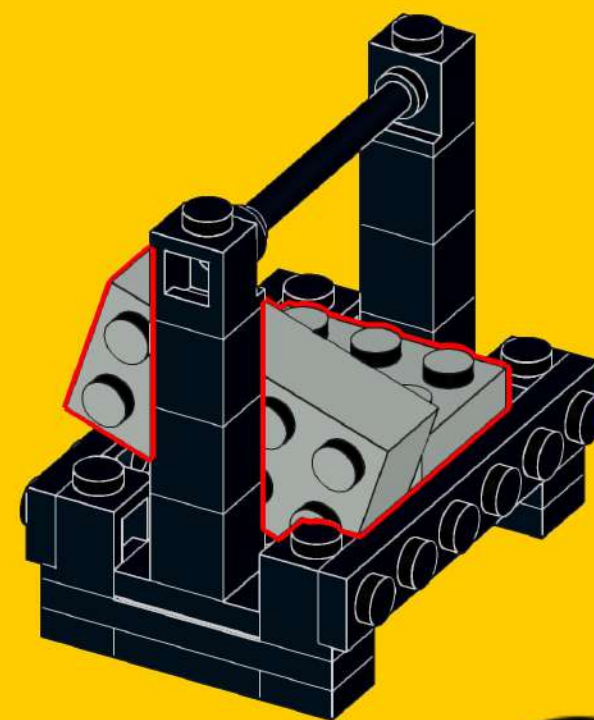
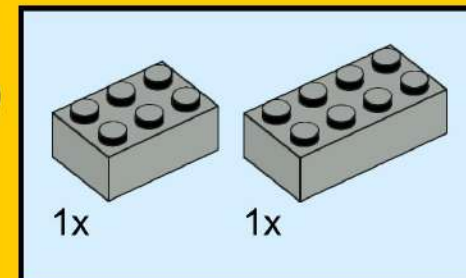

69

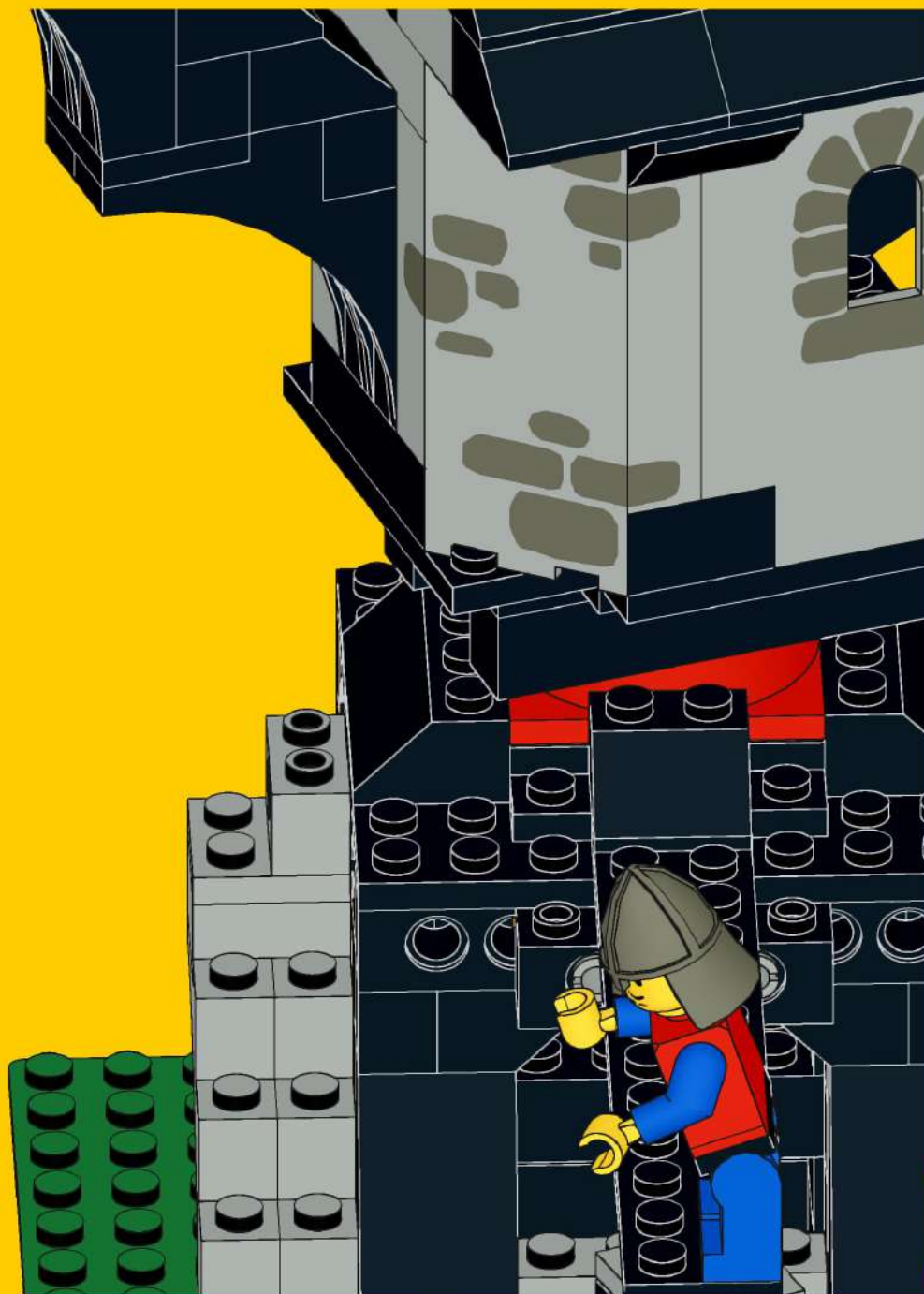
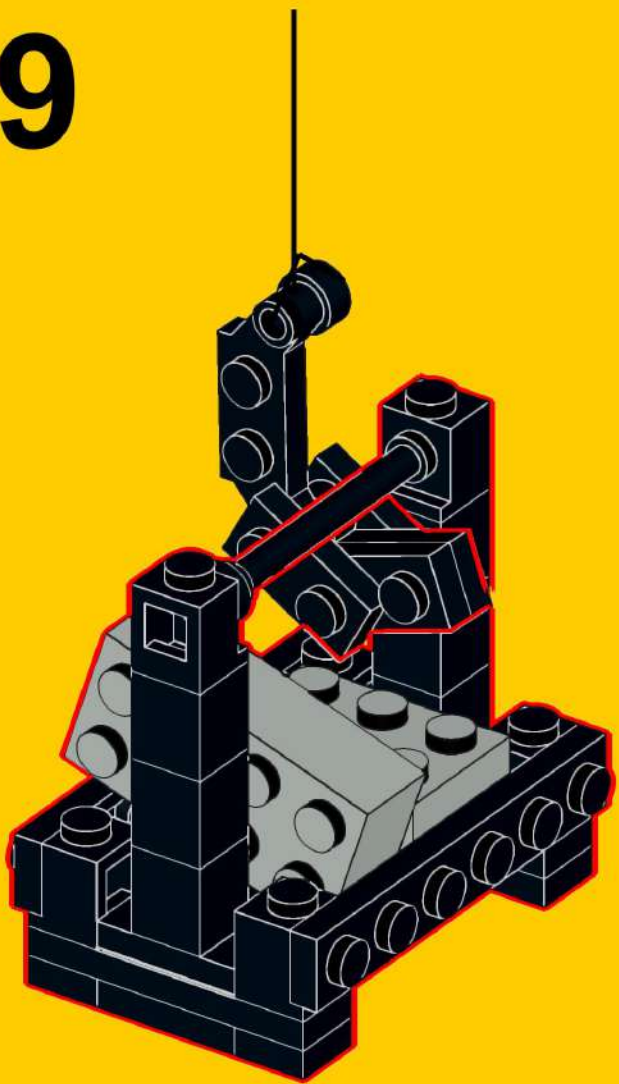



4x  
3024, 11

6x  
4070, 11

20x  
3005, 11

7x  
3023, 11

3x  
3794b, 11

4x  
3700, 11

1x  
970, 11

8x  
3665, 11

24x  
3004, 11

1x  
3680, 11

3x  
3022, 11

4x  
3660, 11

11x  
3003, 11

12x  
3039, 11

2x  
4287, 11

2x  
3038, 11

2x  
4590, 11

5x  
3710, 11

1x  
3010, 11

1x  
3701, 11

3x  
3709b, 11

3x  
3020, 11

2x  
3001, 11

4x  
3037, 11

6x  
3684a, 11

2x  
3957, 11

1x  
73590c03a, 11

10x  
3666, 11

2x  
3894, 11

2x  
3009, 11

5x  
3795, 11

1x  
32001, 11

2x  
2456, 11



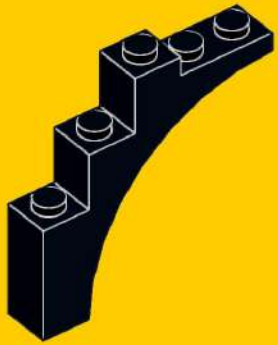

4x  
2339, 11



1x  
3738, 11

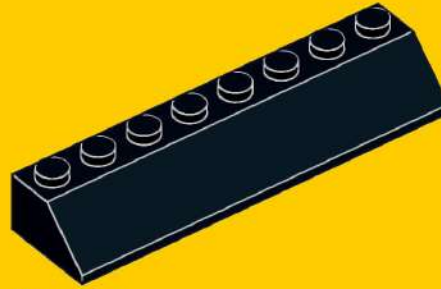

6x  
4445, 11



2x  
3749, 9



2x  
3022, 9



4x  
3673, 9



1x  
3680, 9

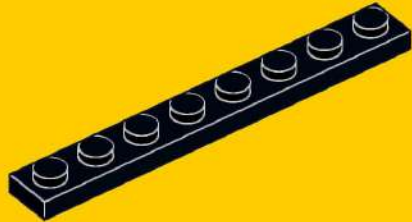

3x  
3460, 11



3x  
3034, 11



1x  
2445, 11



2x  
3679, 9

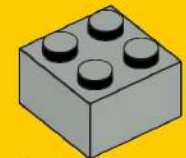

2x  
3003, 9



2x  
3702, 11



1x  
3007, 11



1x  
3844, 10



2x  
3700, 9



3x  
3002, 9

2x  
3702, 11

1x  
3007, 11

1x  
3844, 10



2x  
3665, 9



1x  
3010, 9



1x  
3713, 9

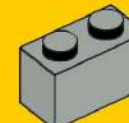

10x  
3004, 9





3x  
3001, 9

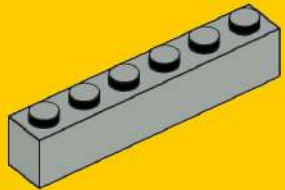

1x  
3009, 9

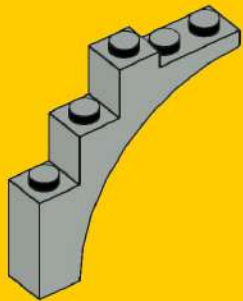

4x  
2339, 9

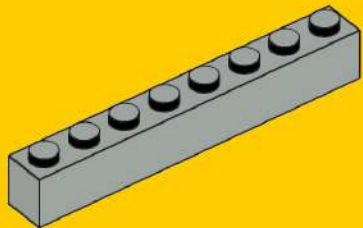

1x  
3008, 9

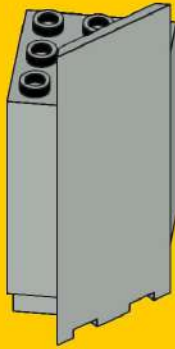

1x  
2345, 9

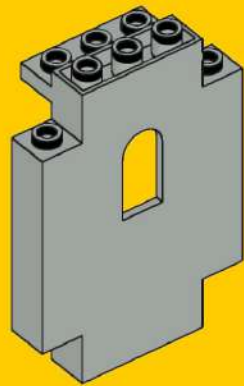

1x  
4444, 9



1x  
2345pb05, 9

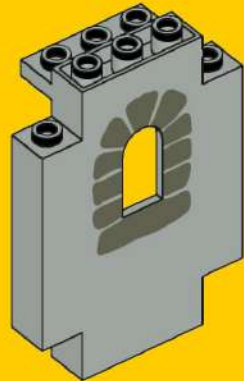

1x  
4444p01, 9

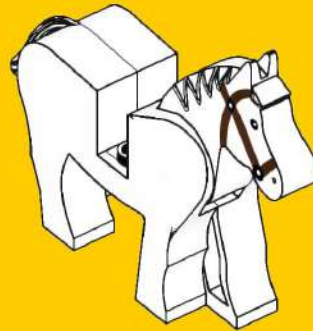

1x  
4493c01pb04, 1



1x  
973p42, 5



1x  
4495a, 5

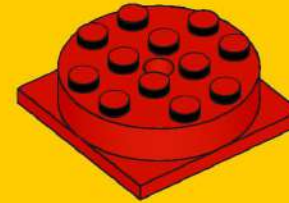

1x  
3403c01, 5



2x  
983, 3



1x  
3626ap01, 3



1x  
4495a, 3



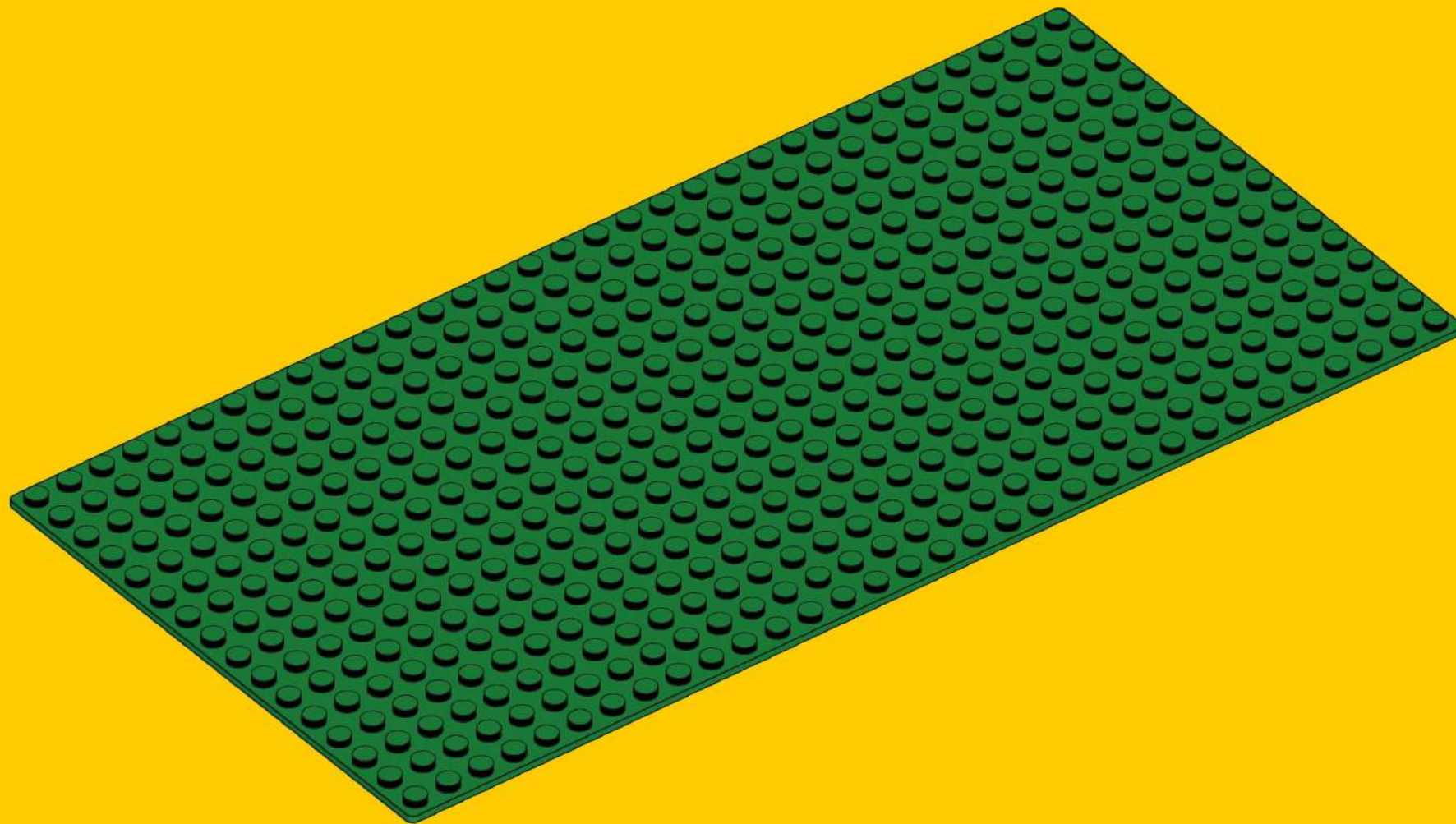

1x  
3857, 6



1x  
981, 7



1x  
982, 7



1x  
972, 7



1x  
971, 7

