

# IDEAS 260: Crossroad Fortress - Main Keep

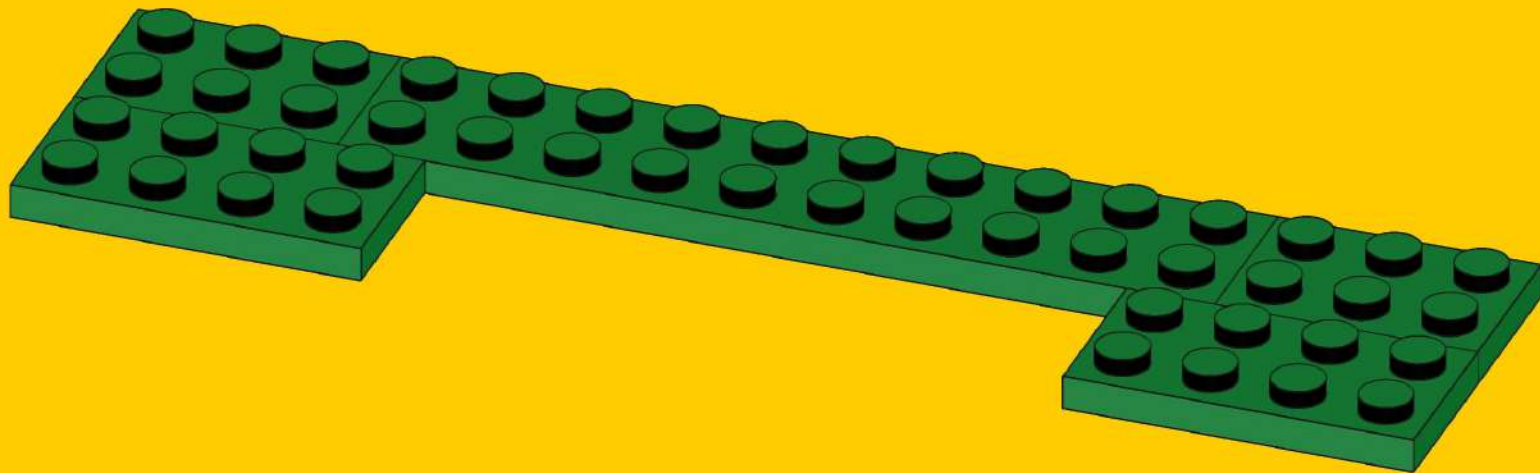

# 1

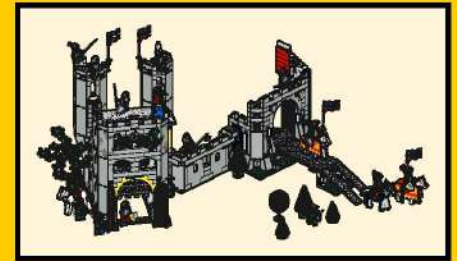
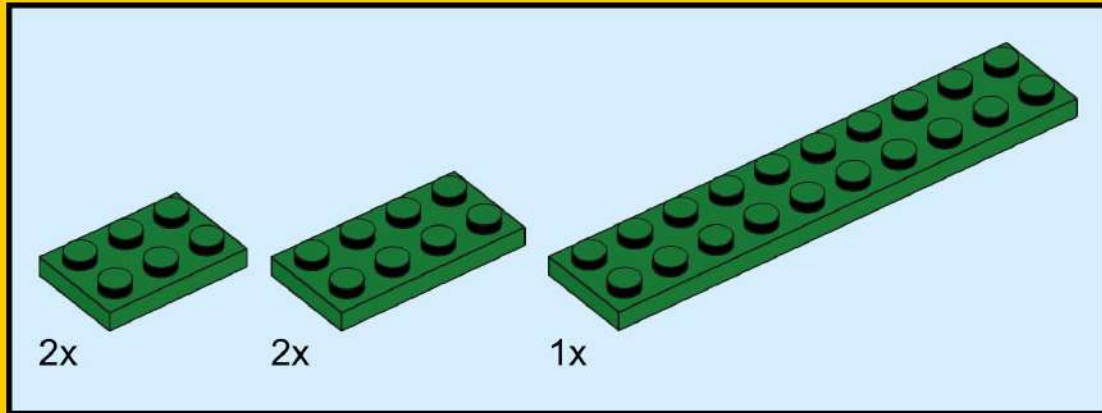

# 2

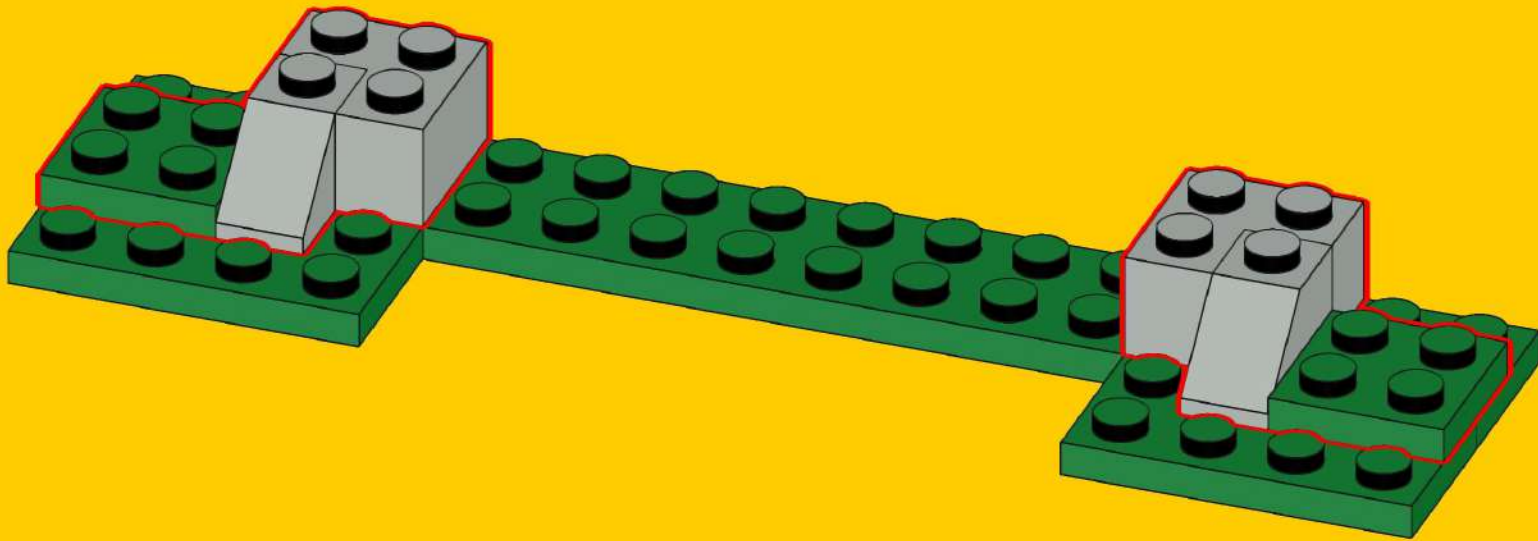
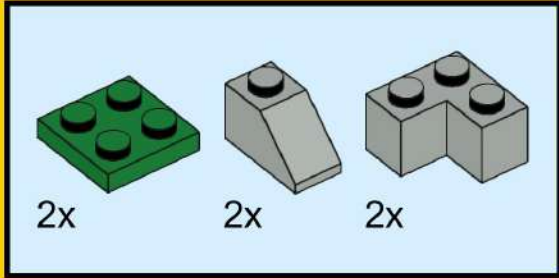

3

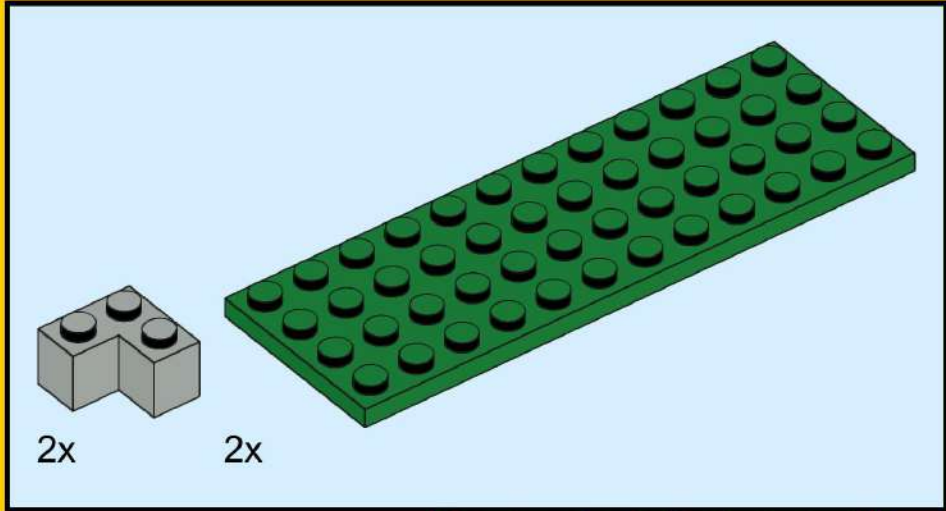
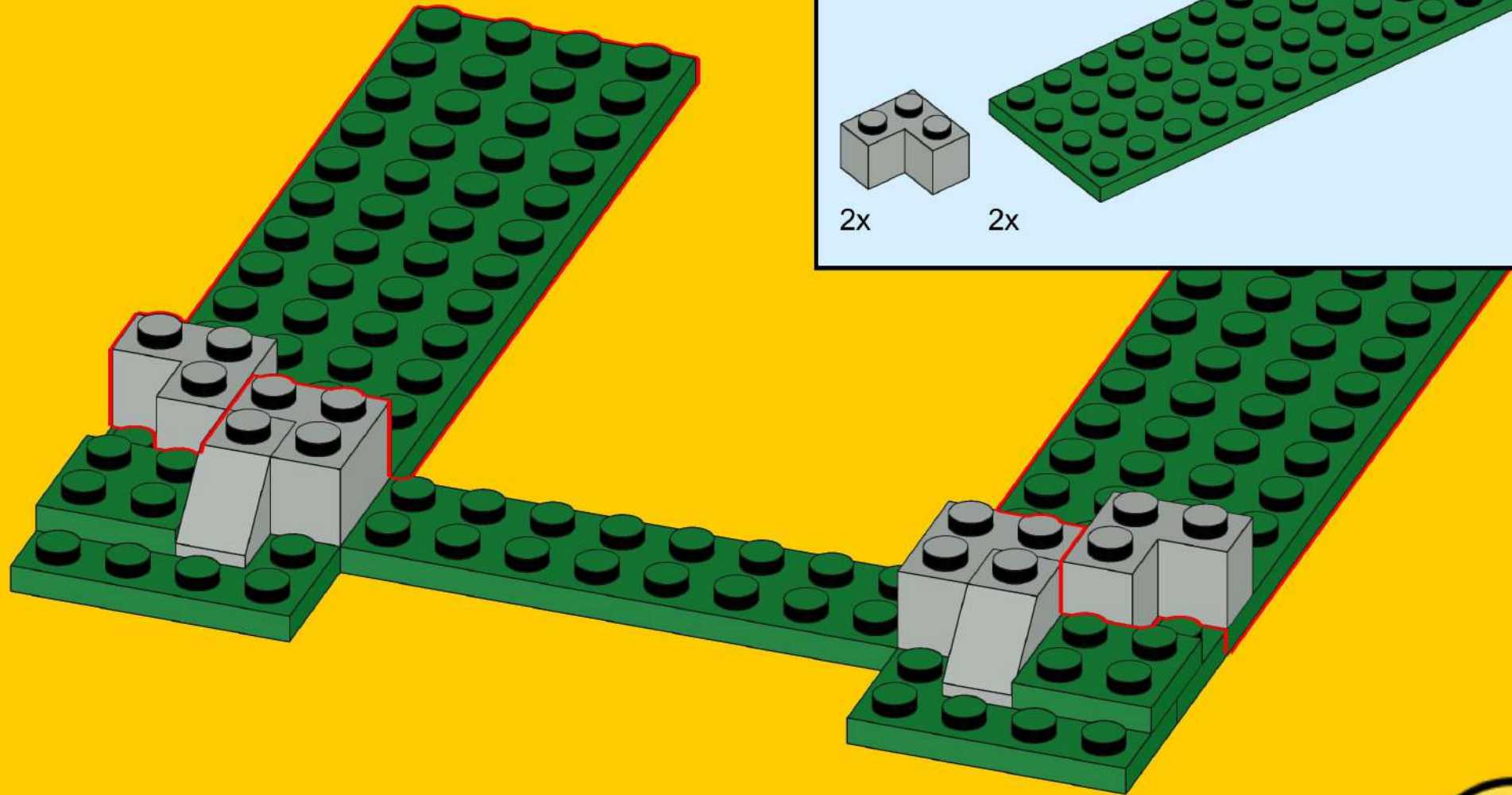

4

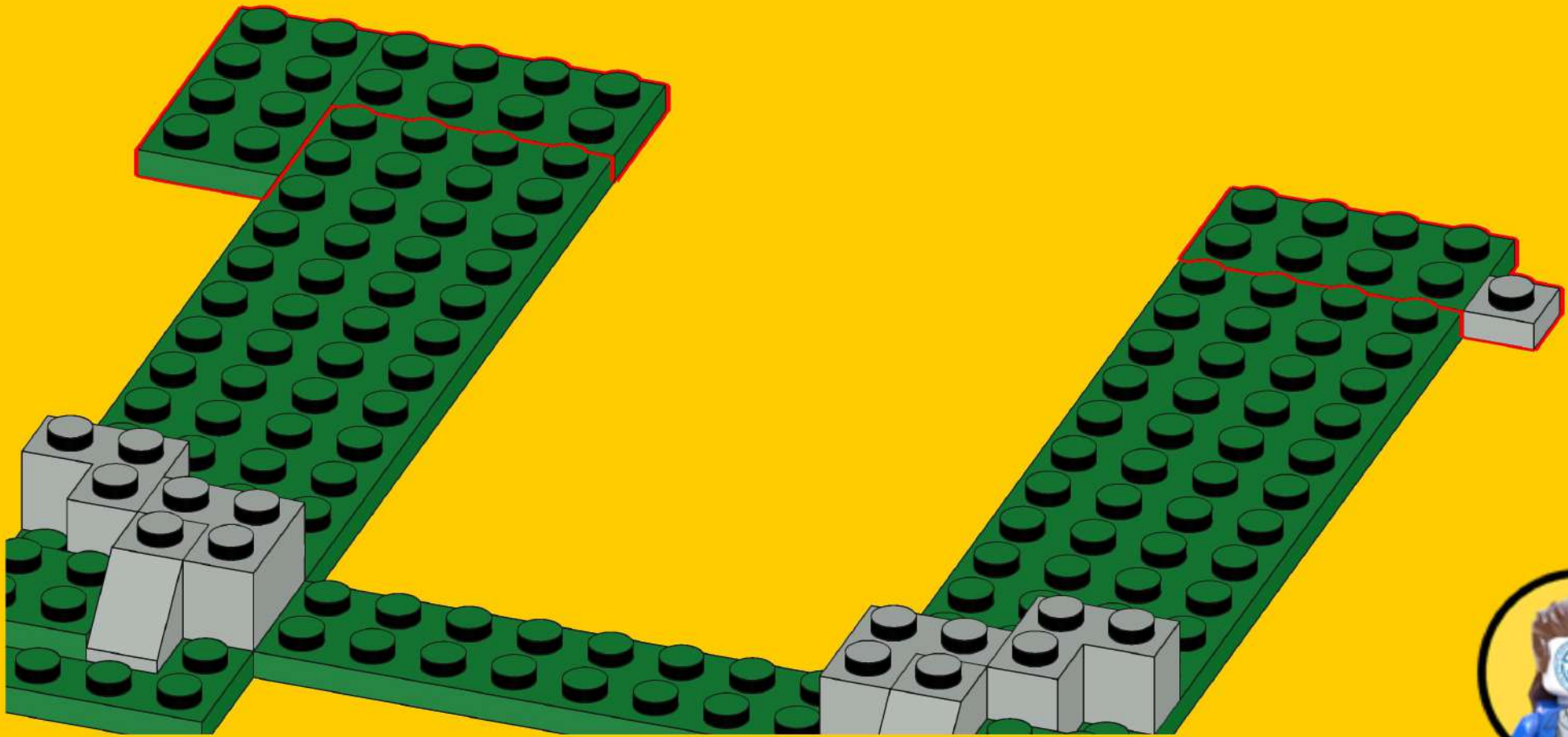
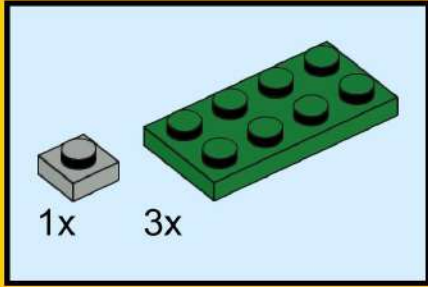

5

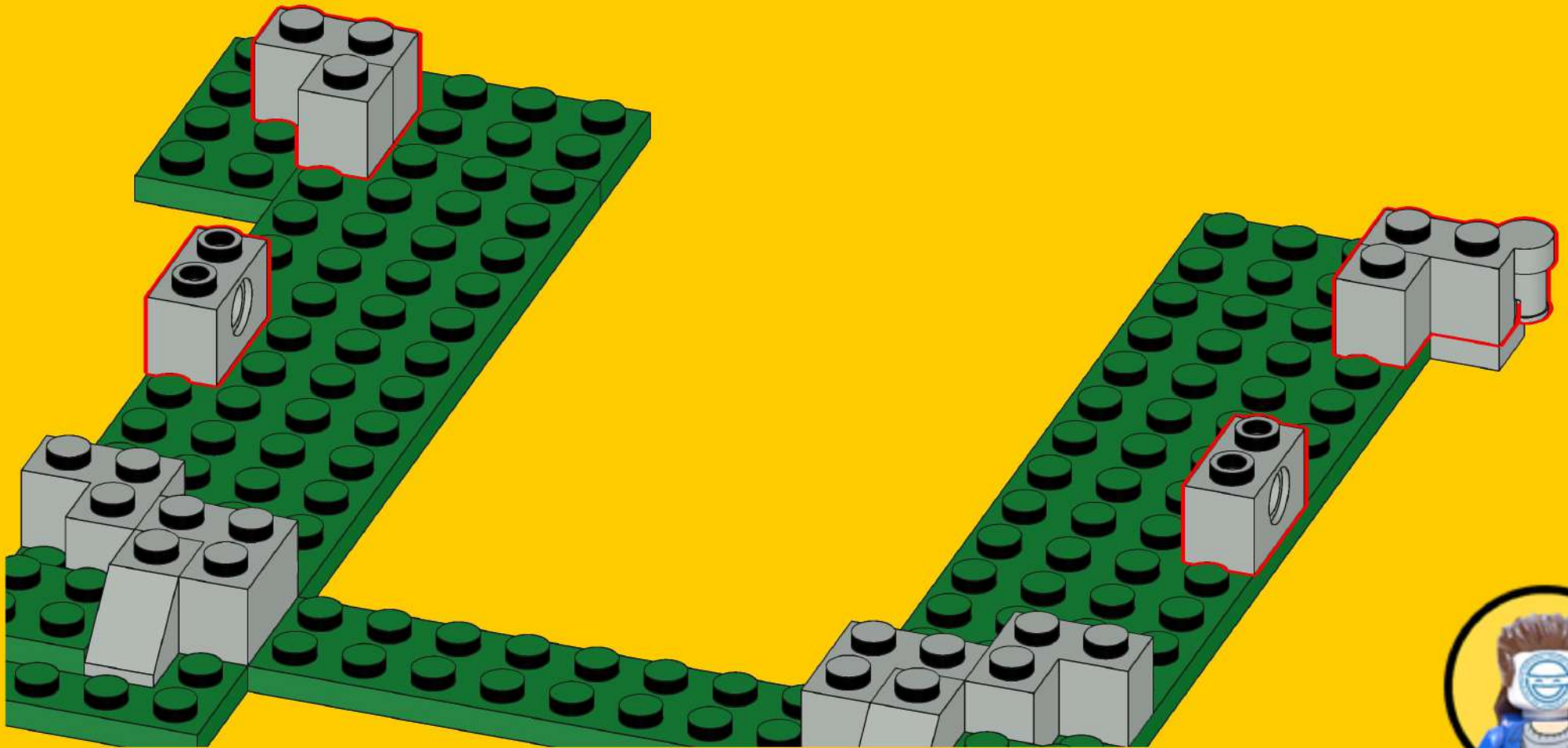
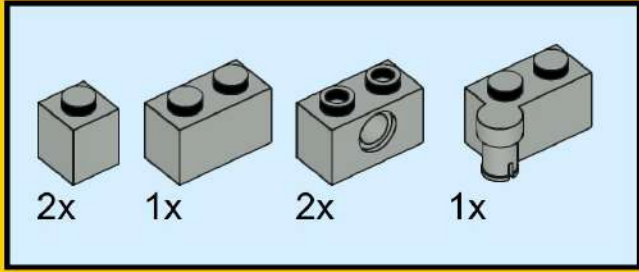

6

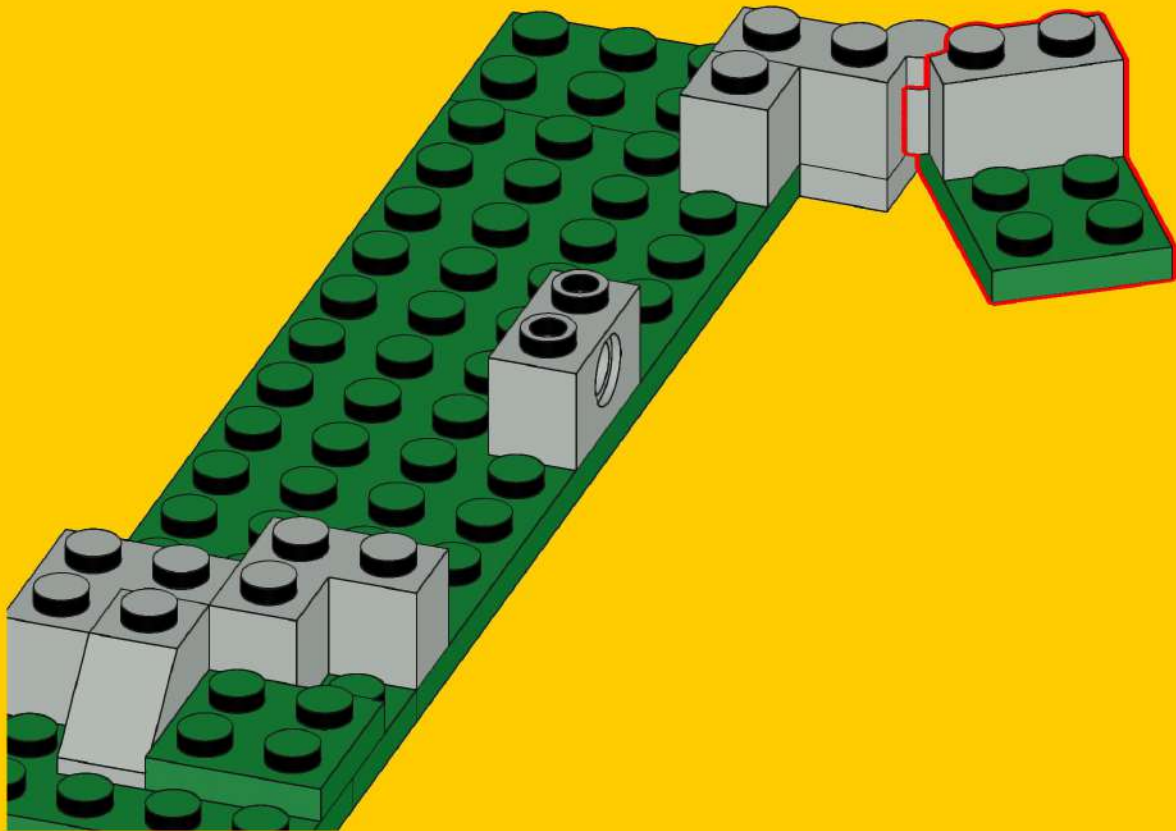
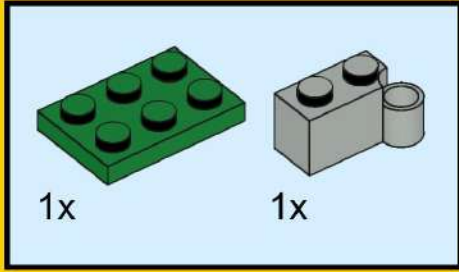

7

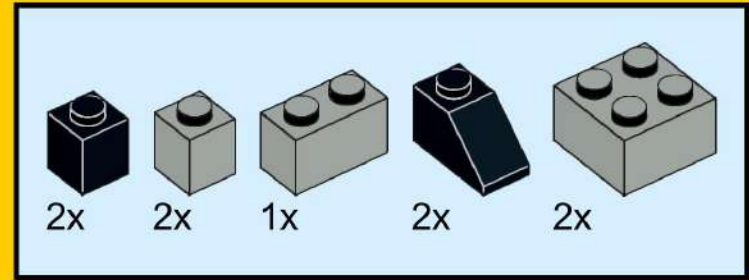
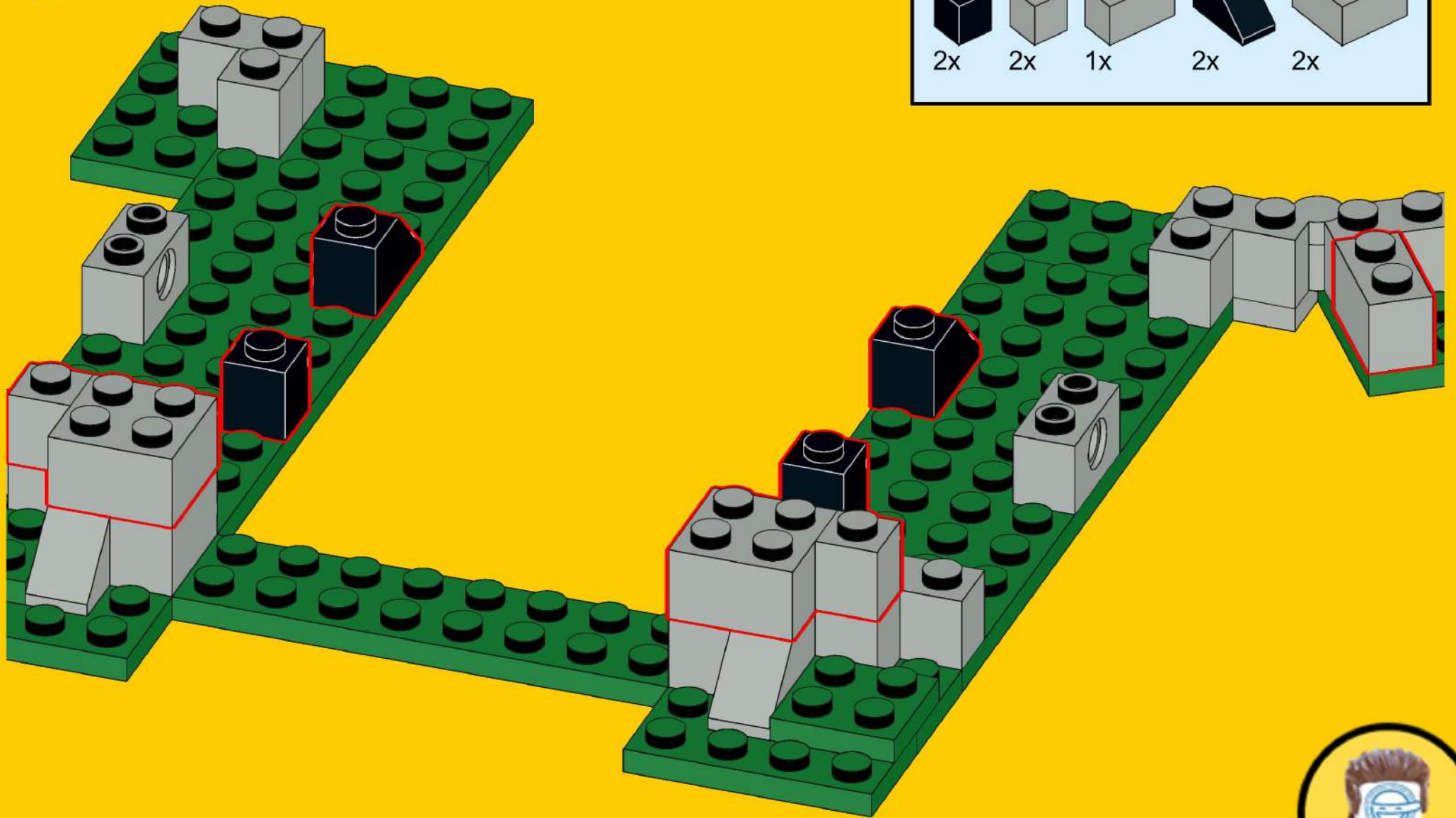



8

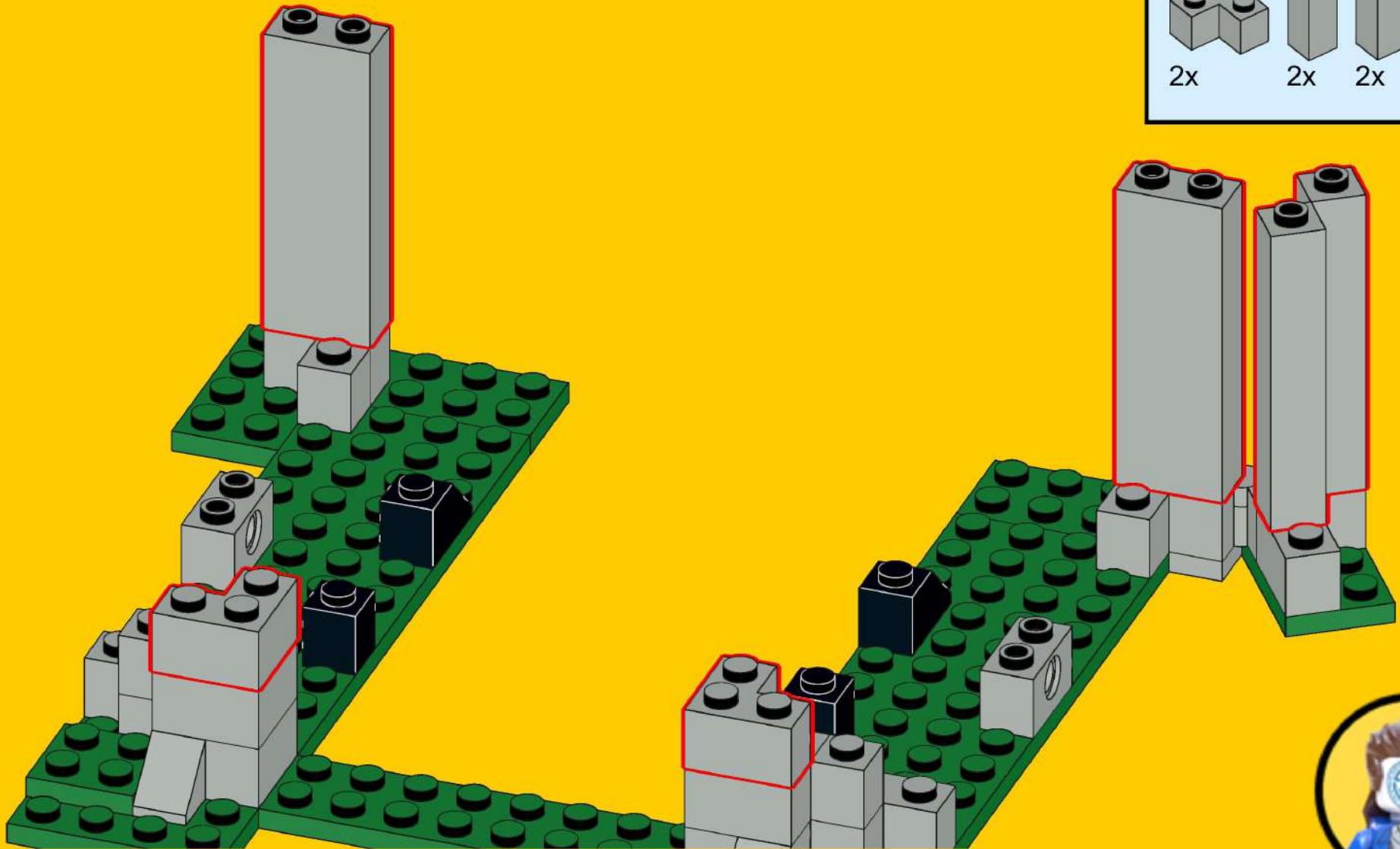
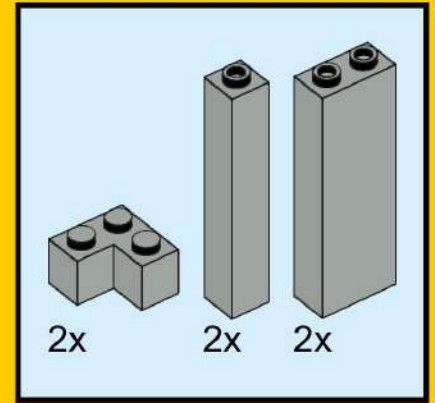

9

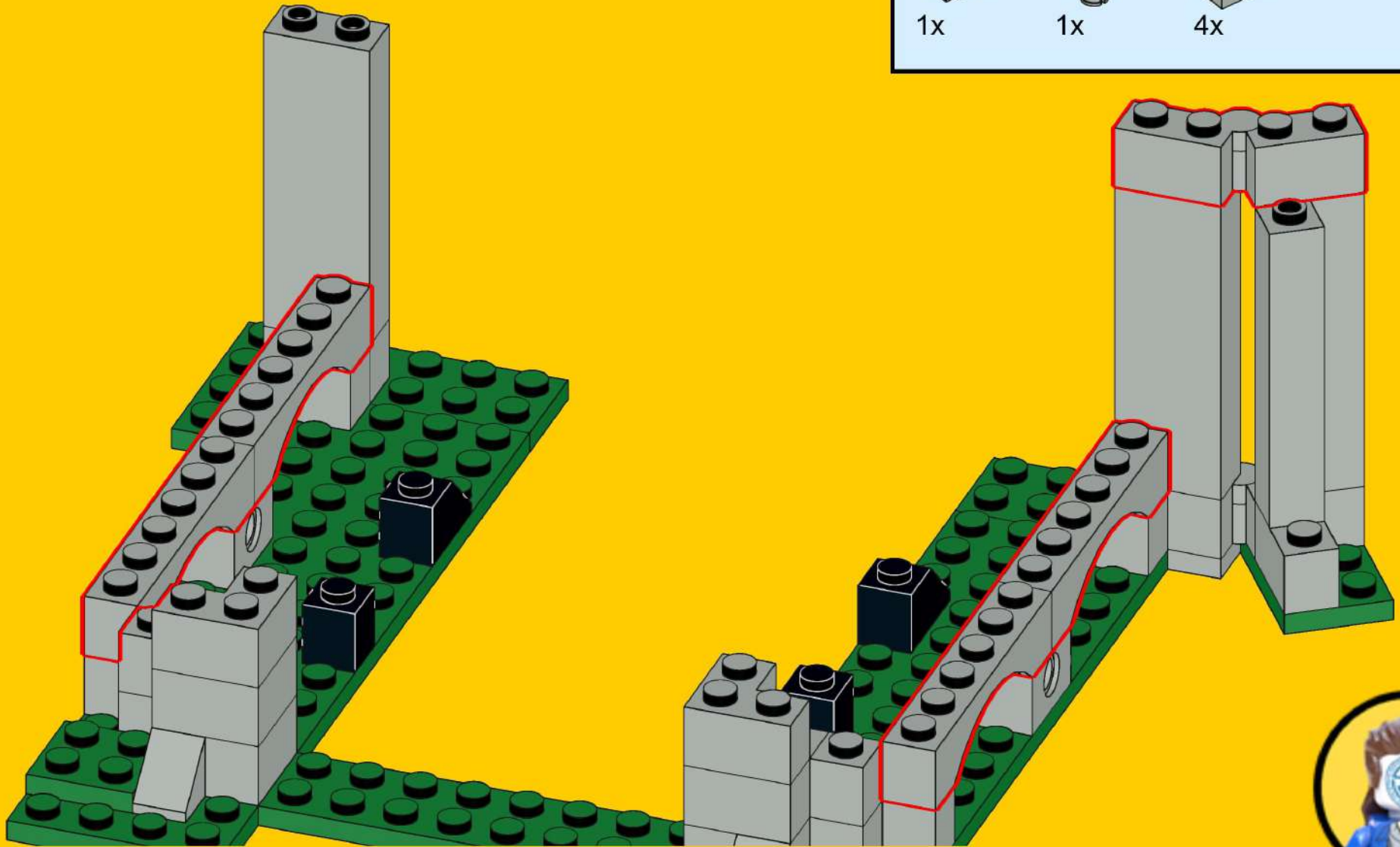
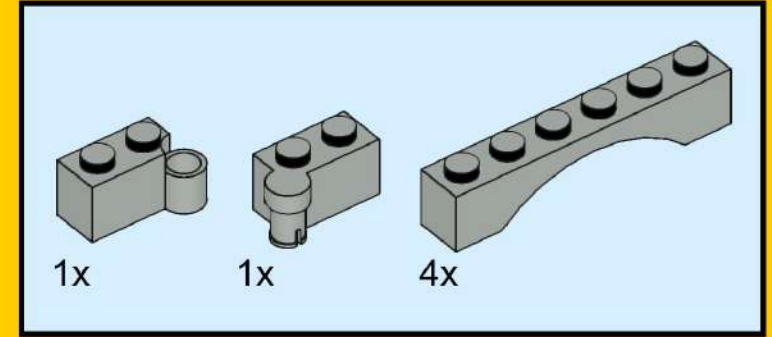

# 10

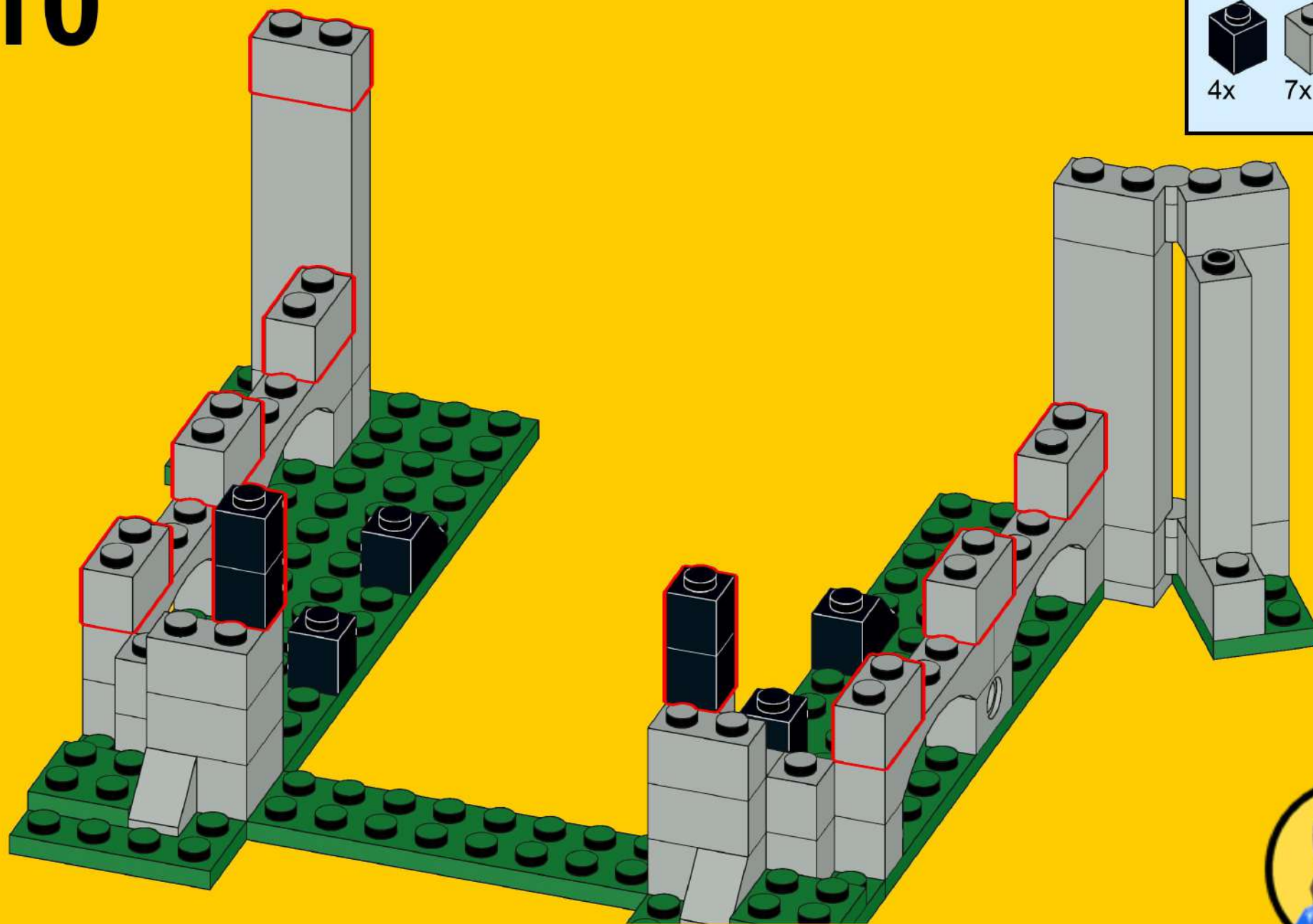
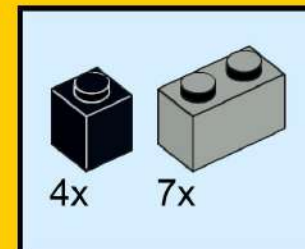

# 11

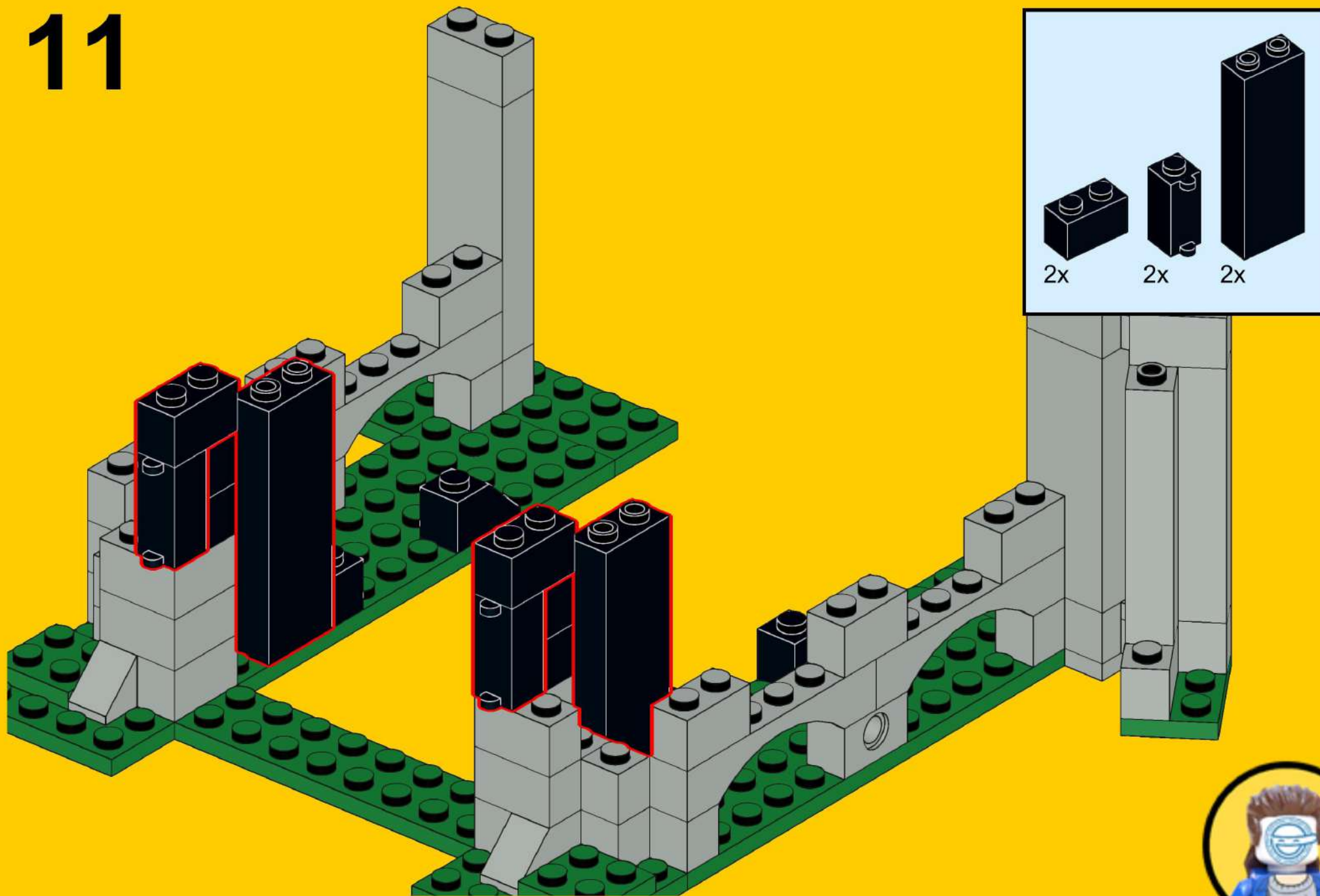

# 12

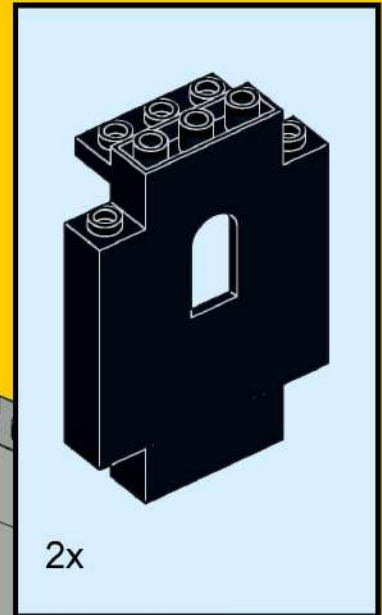
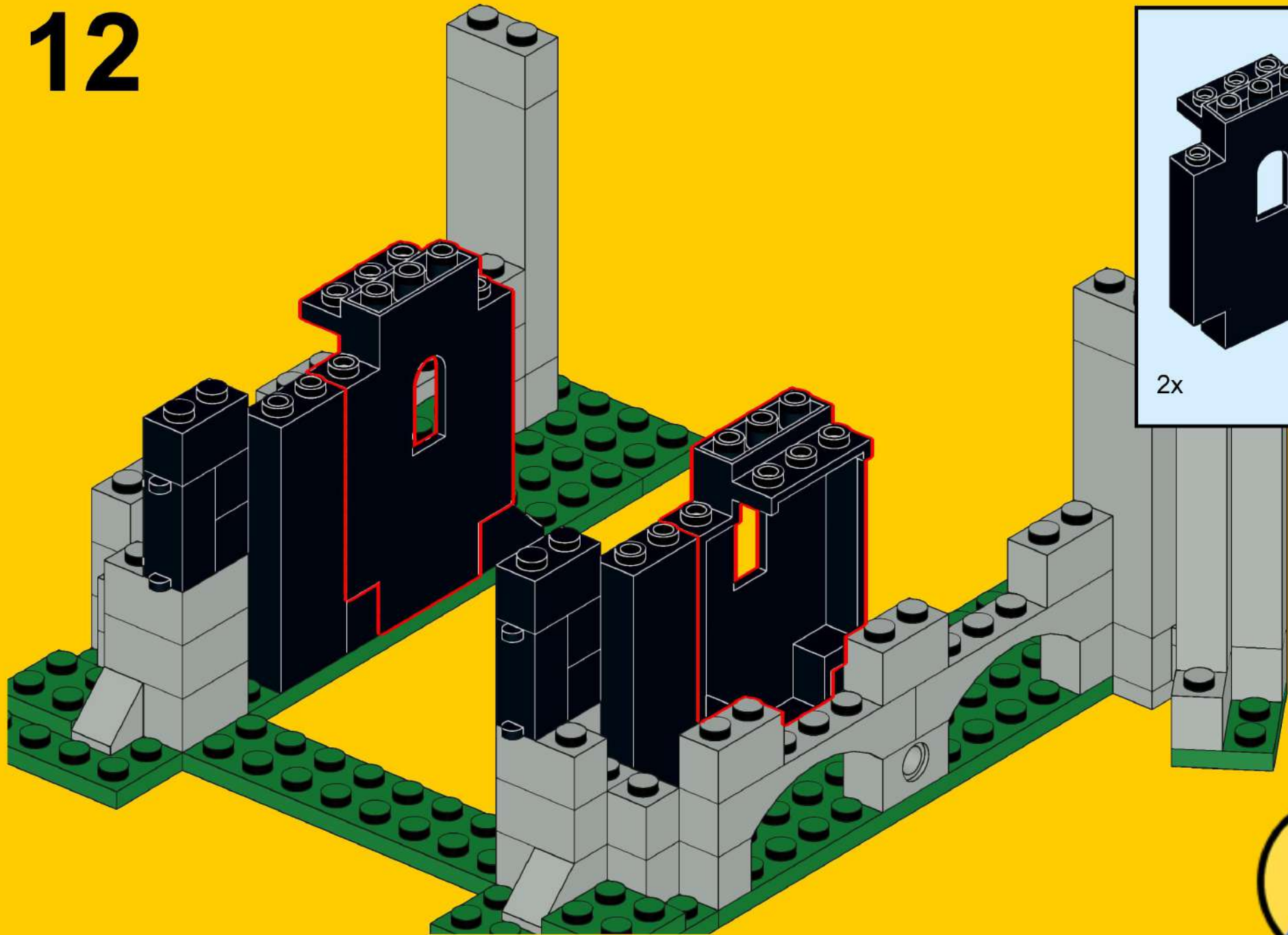

# 13

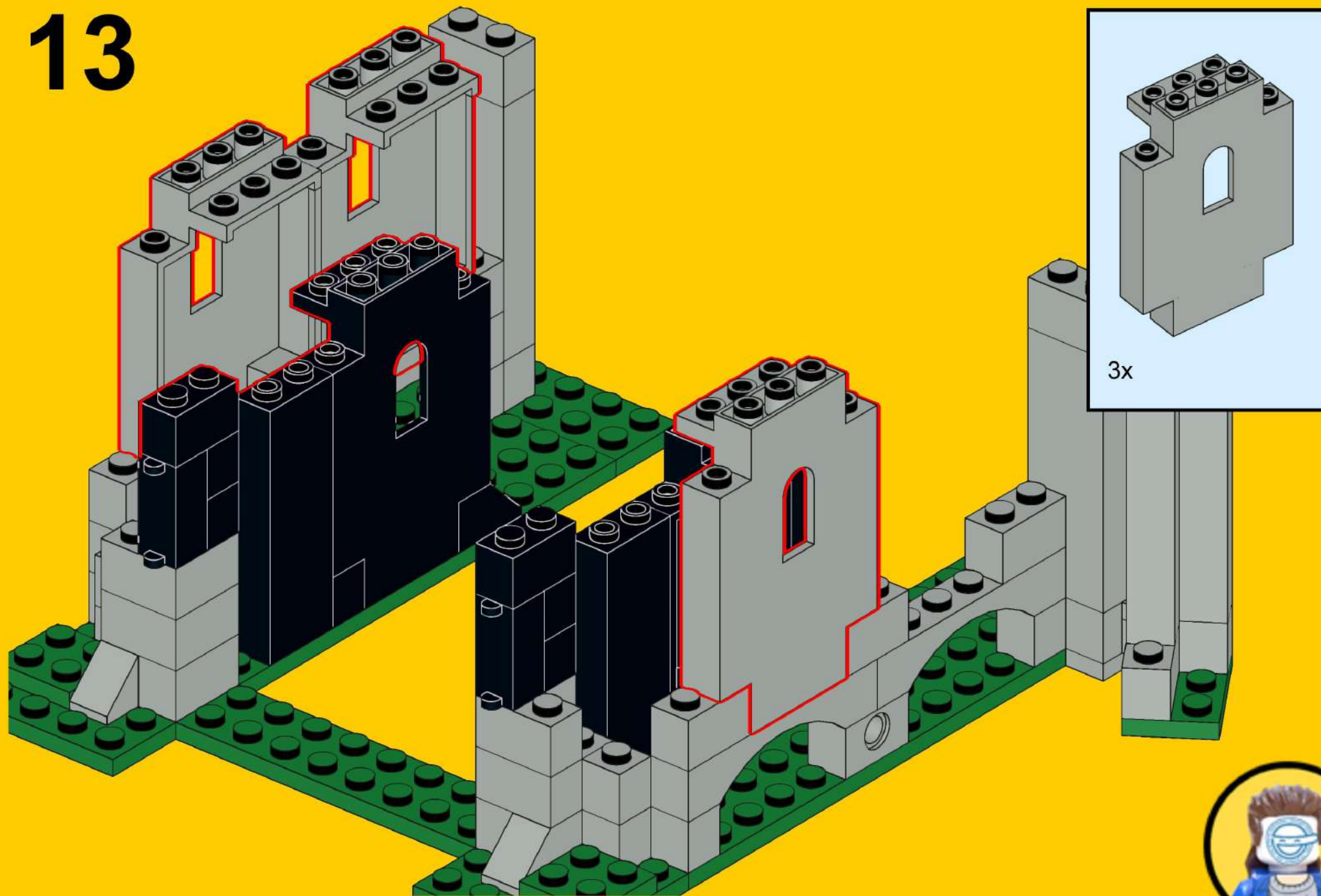

# 14

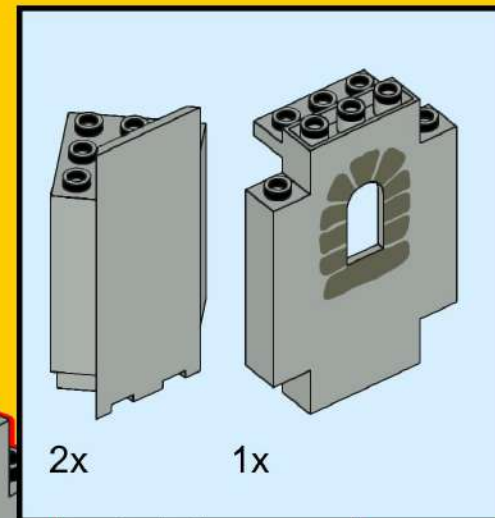
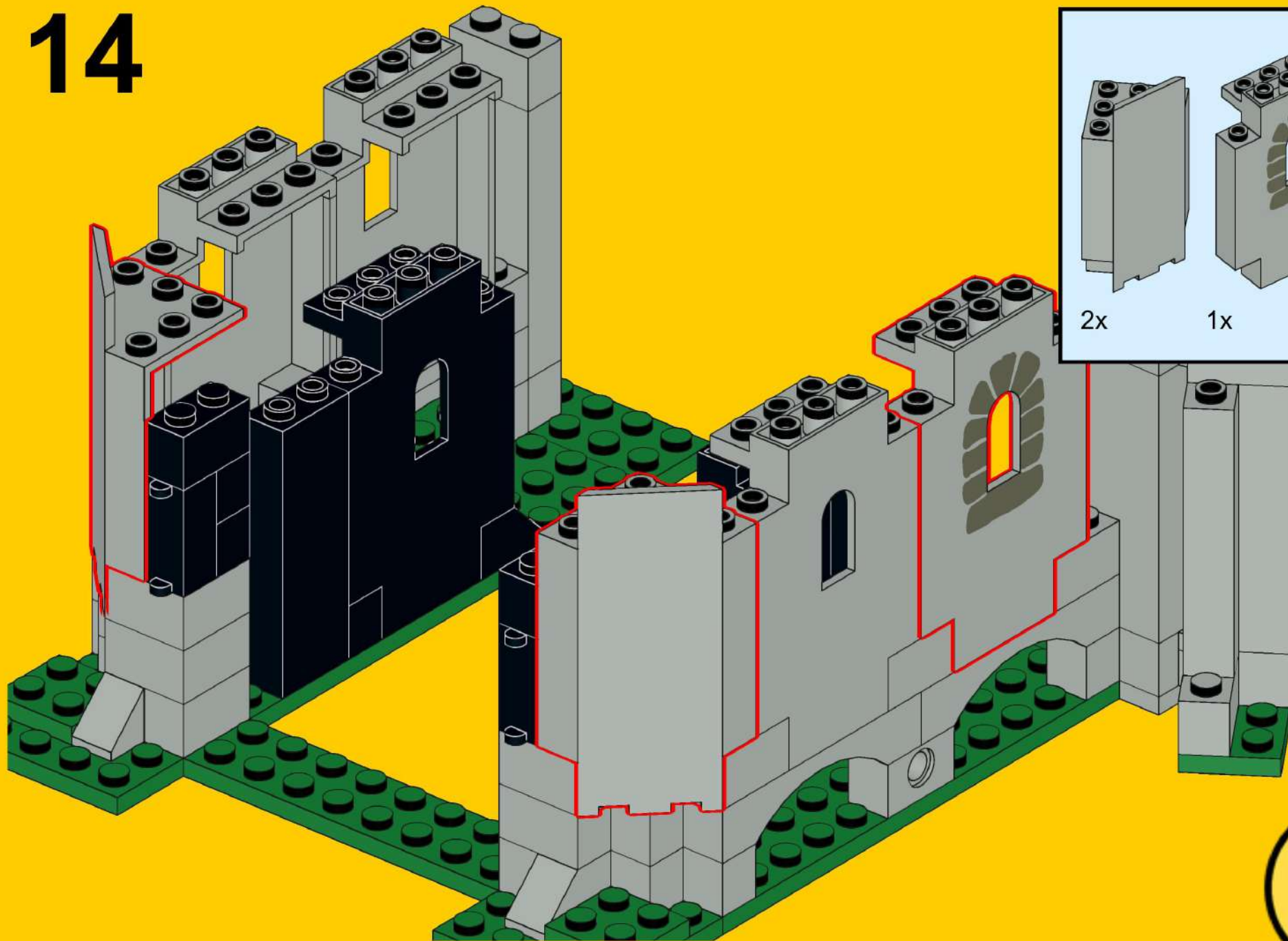

# 15

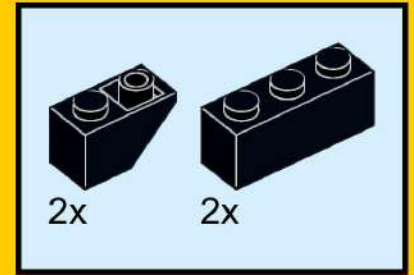
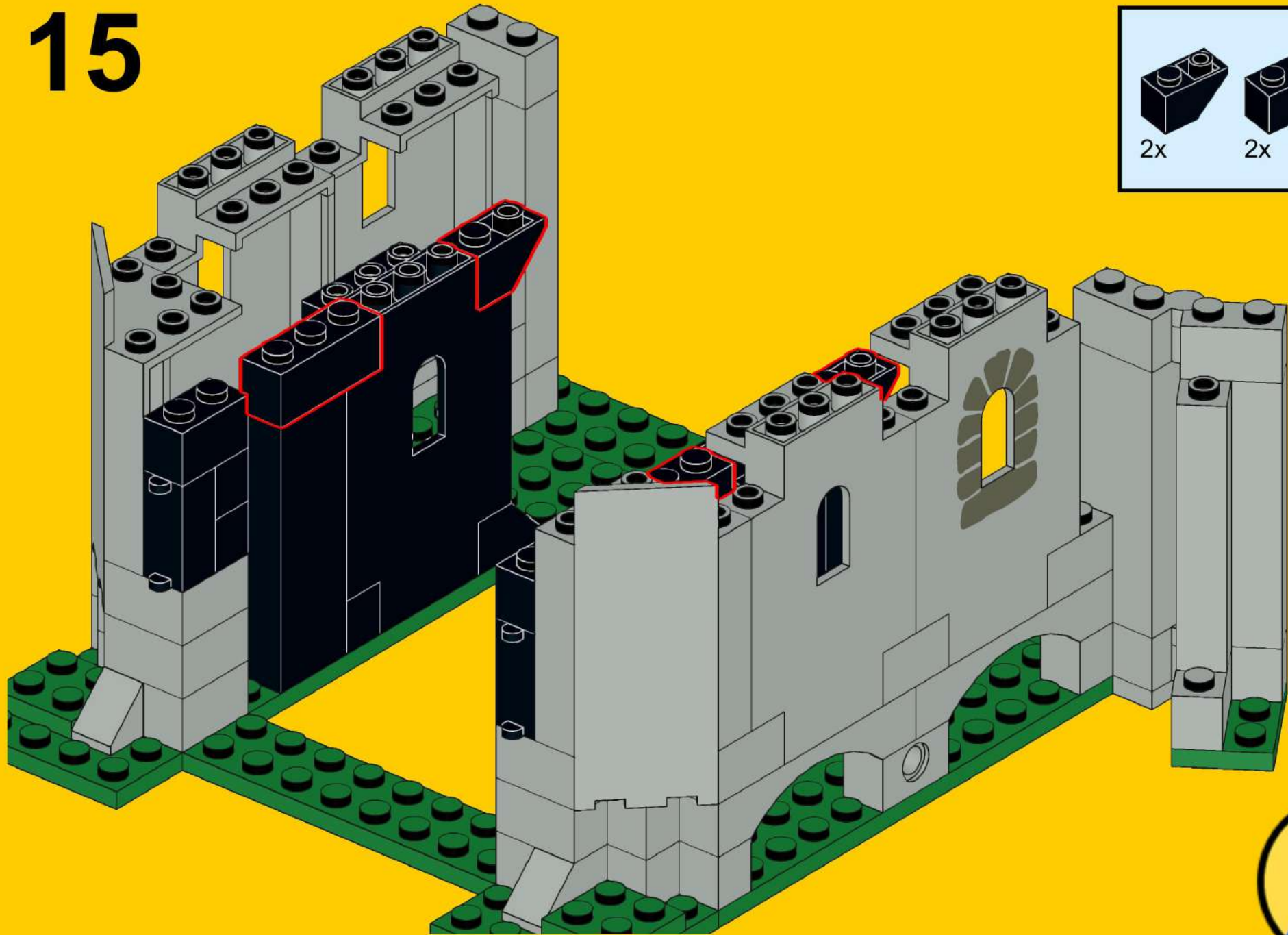



# 16

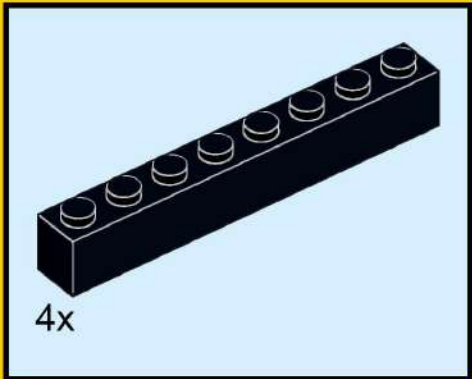
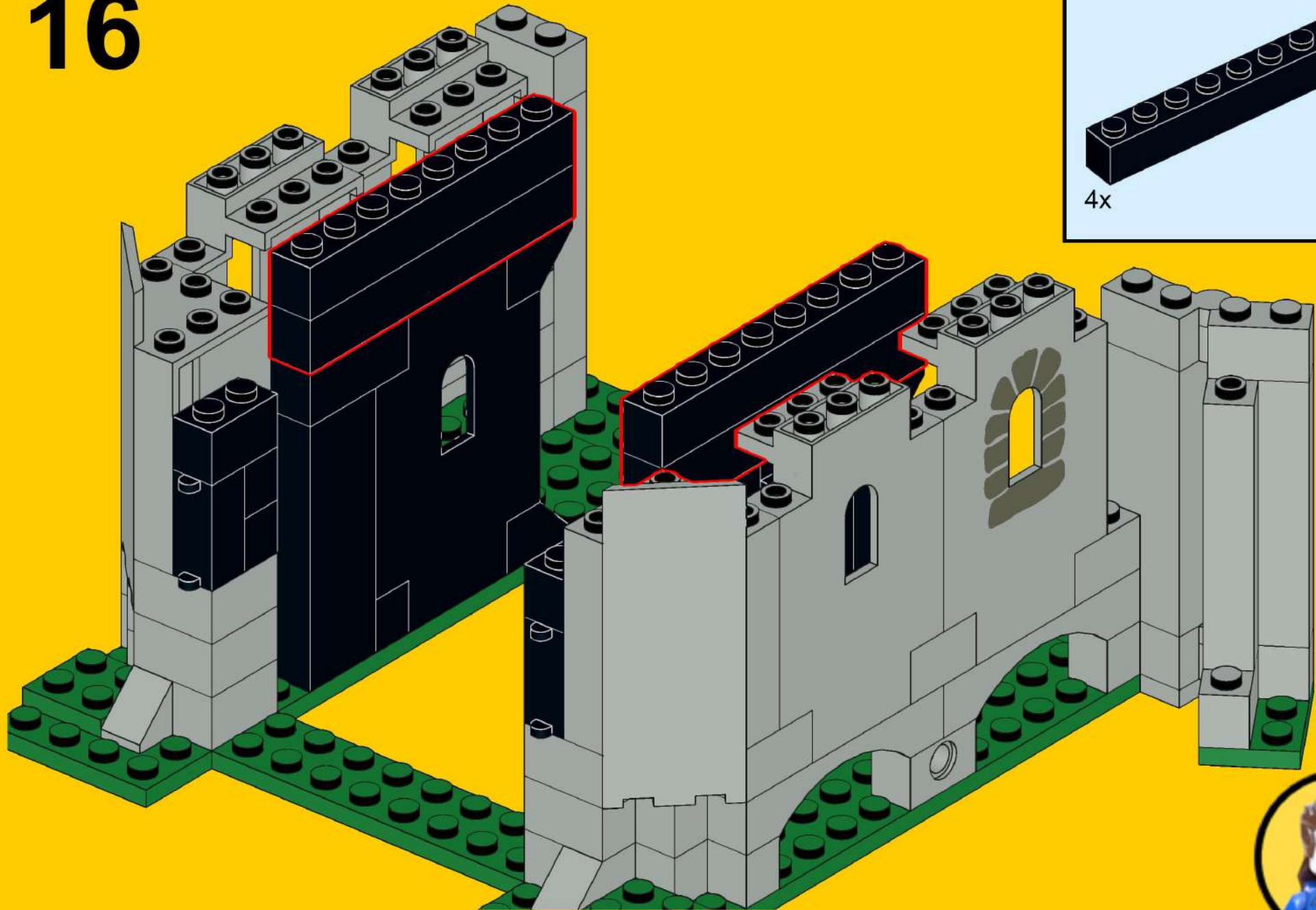

# 17

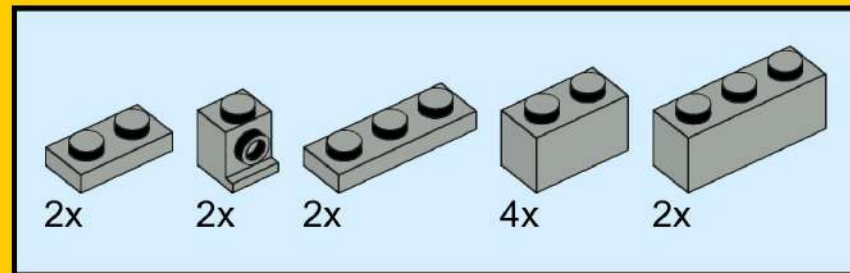
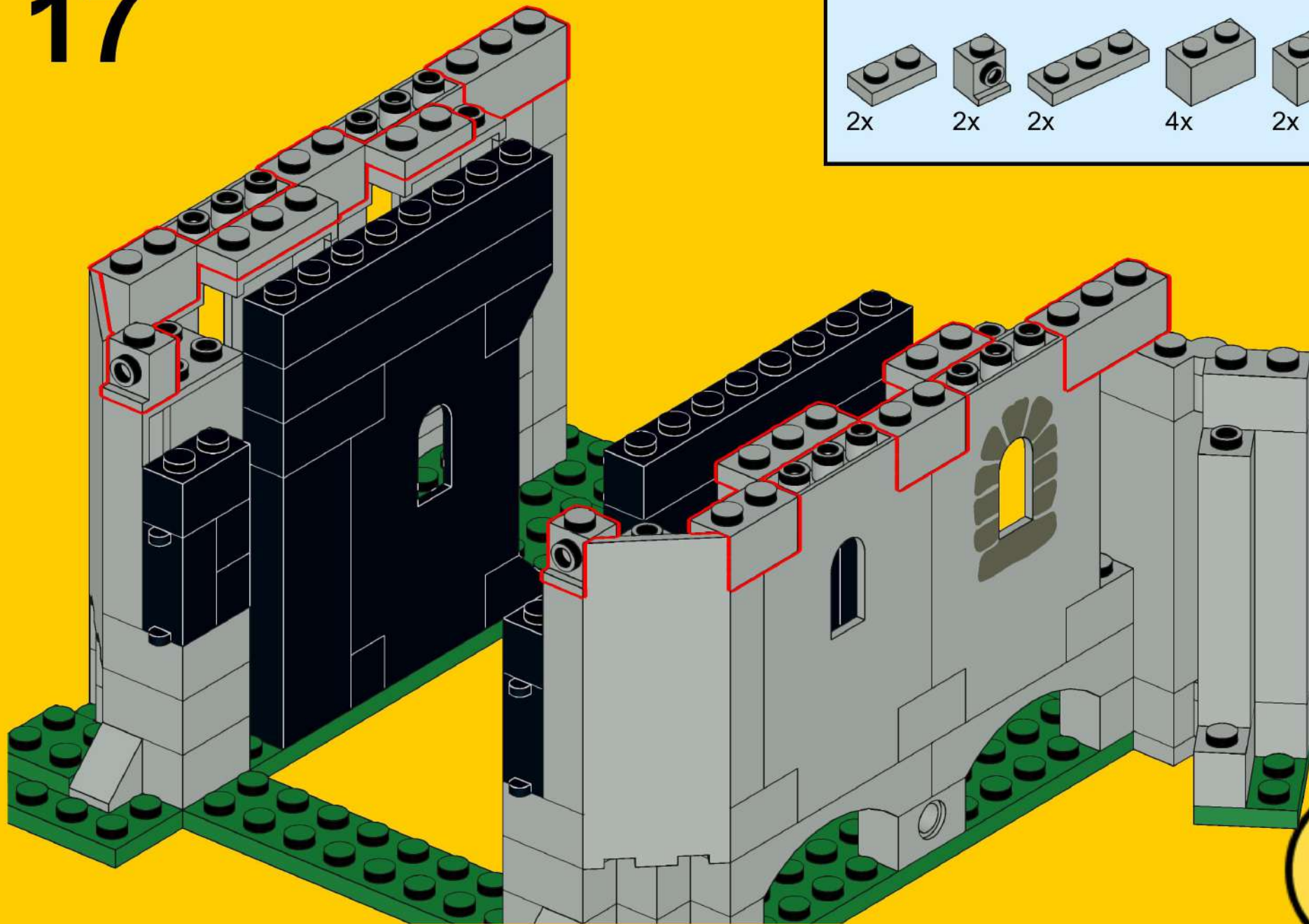

# 18

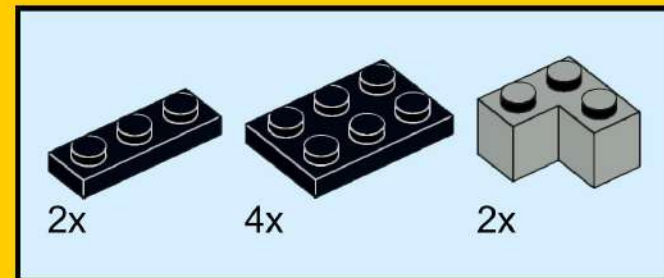
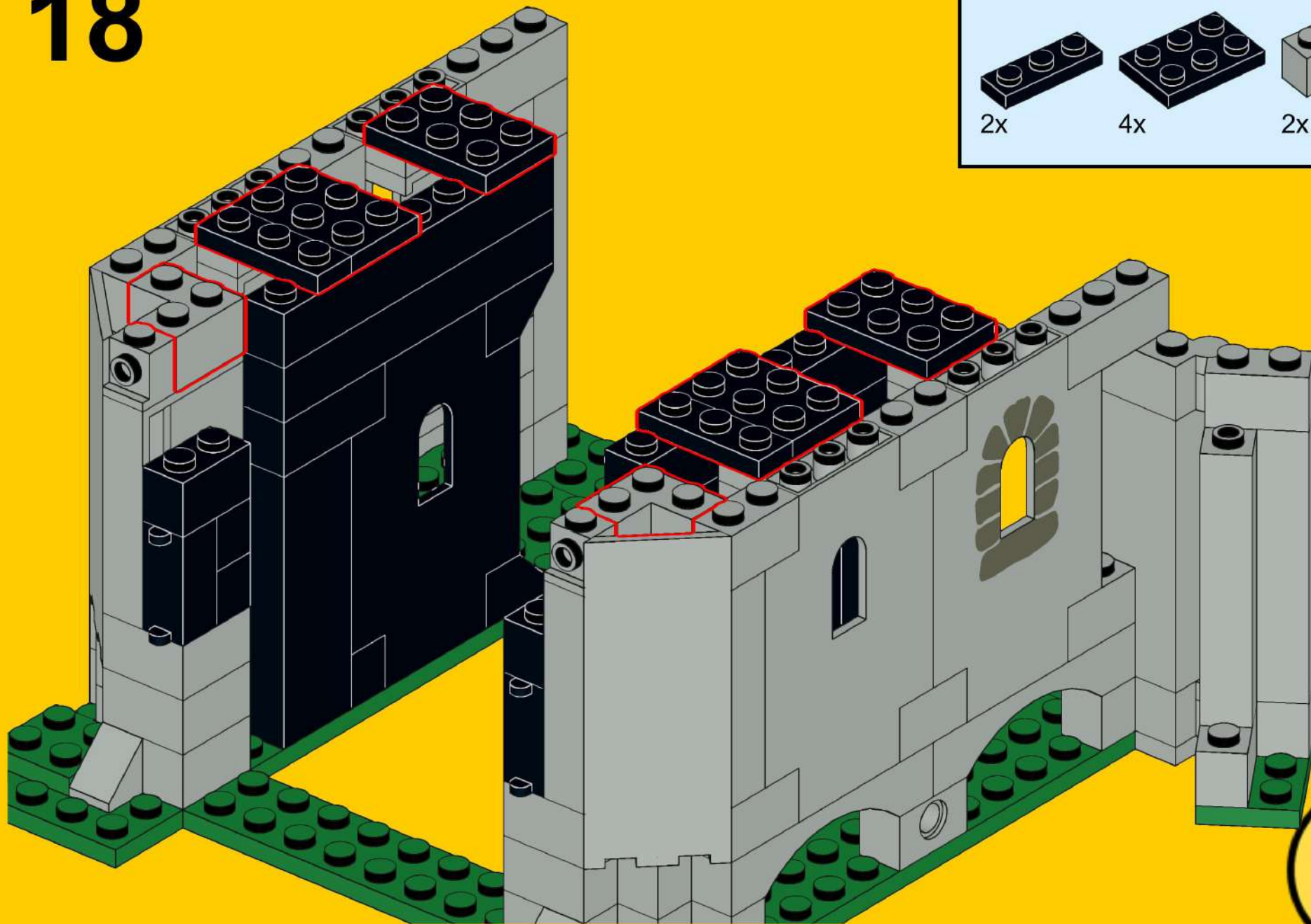

# 19

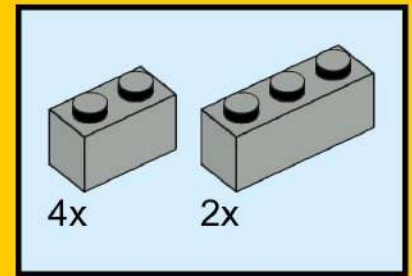
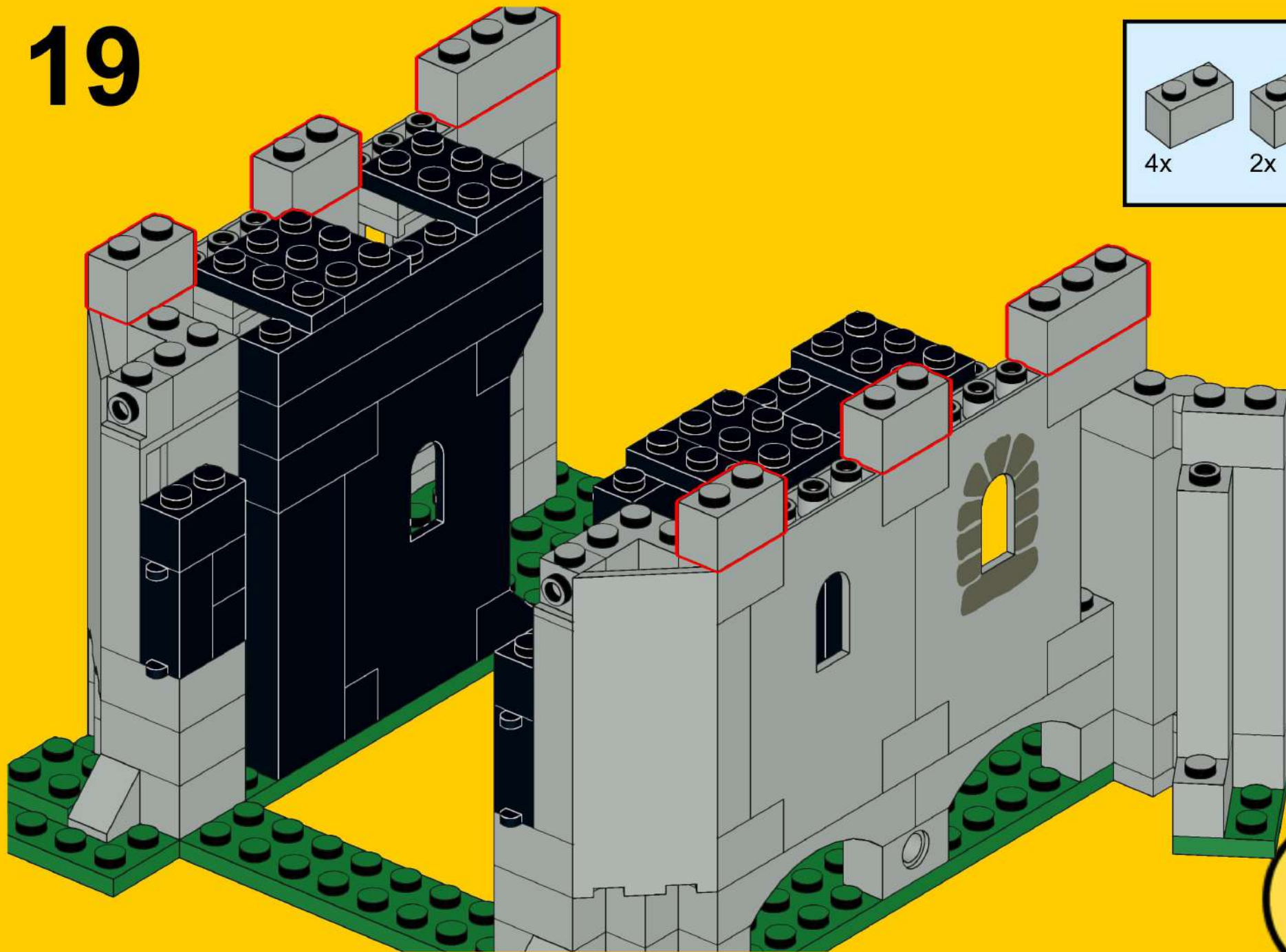

# 20

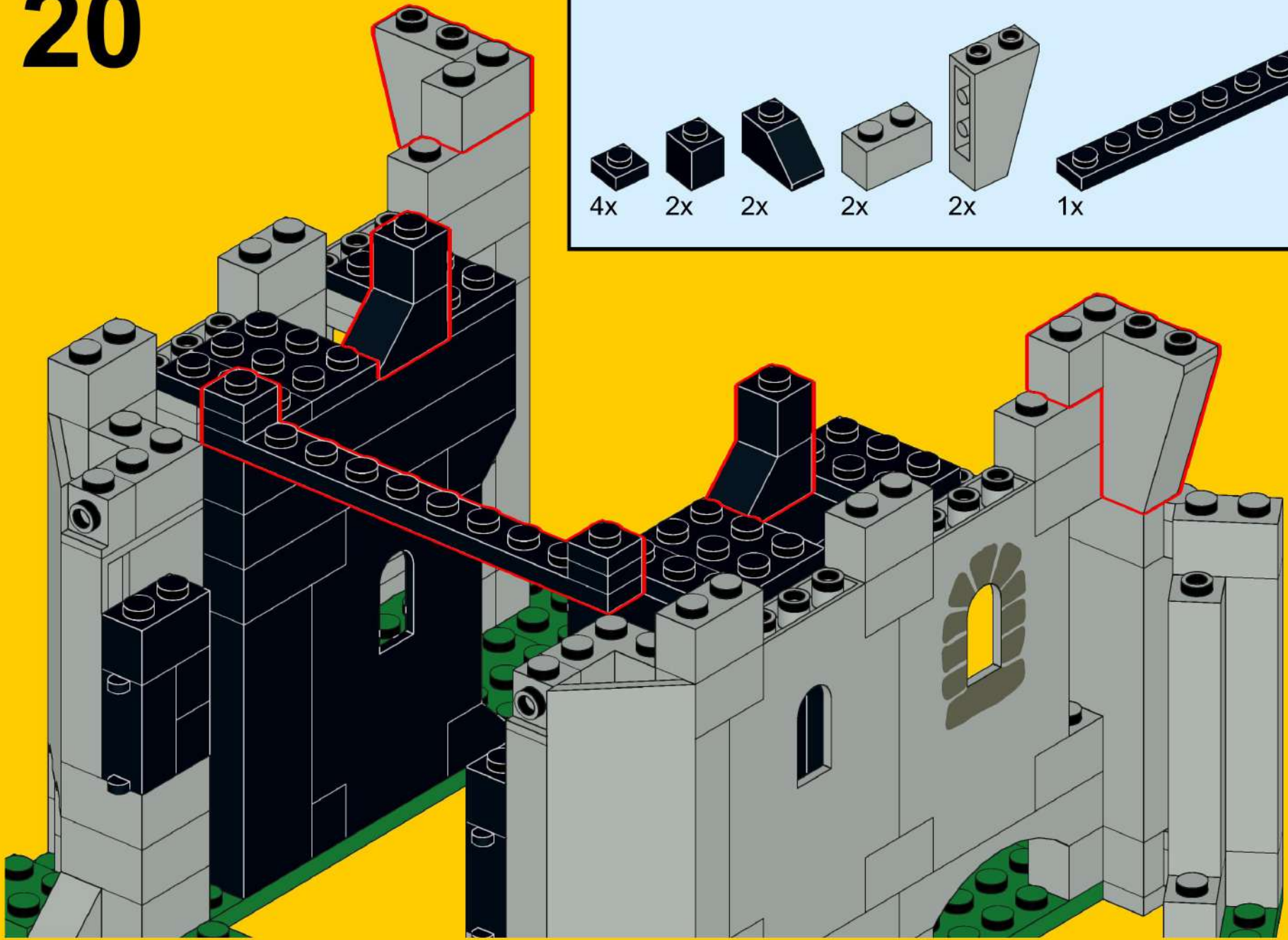
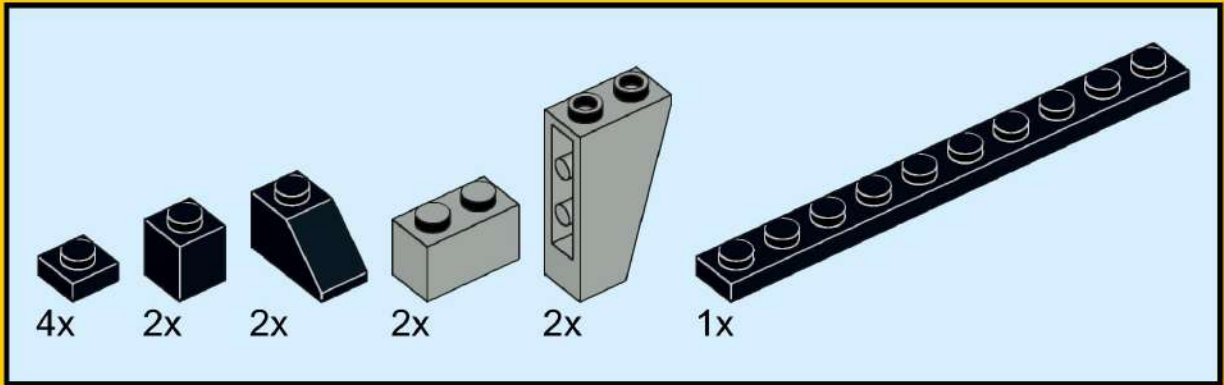

# 21

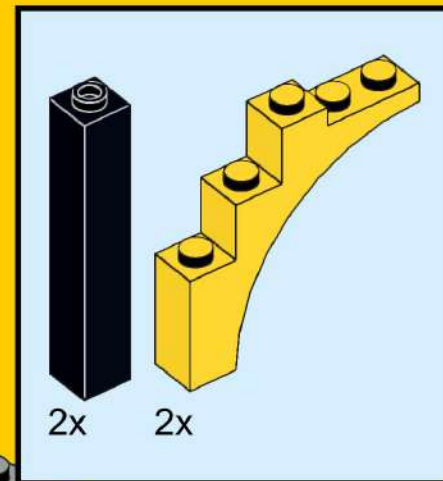

# 22

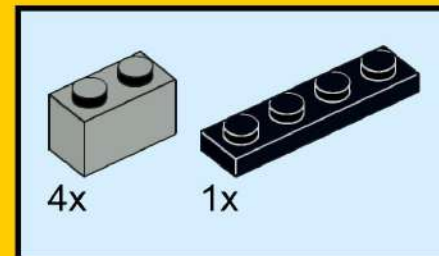

# 23

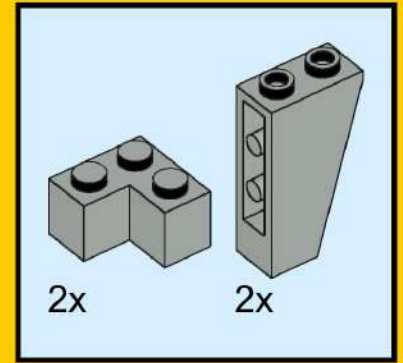
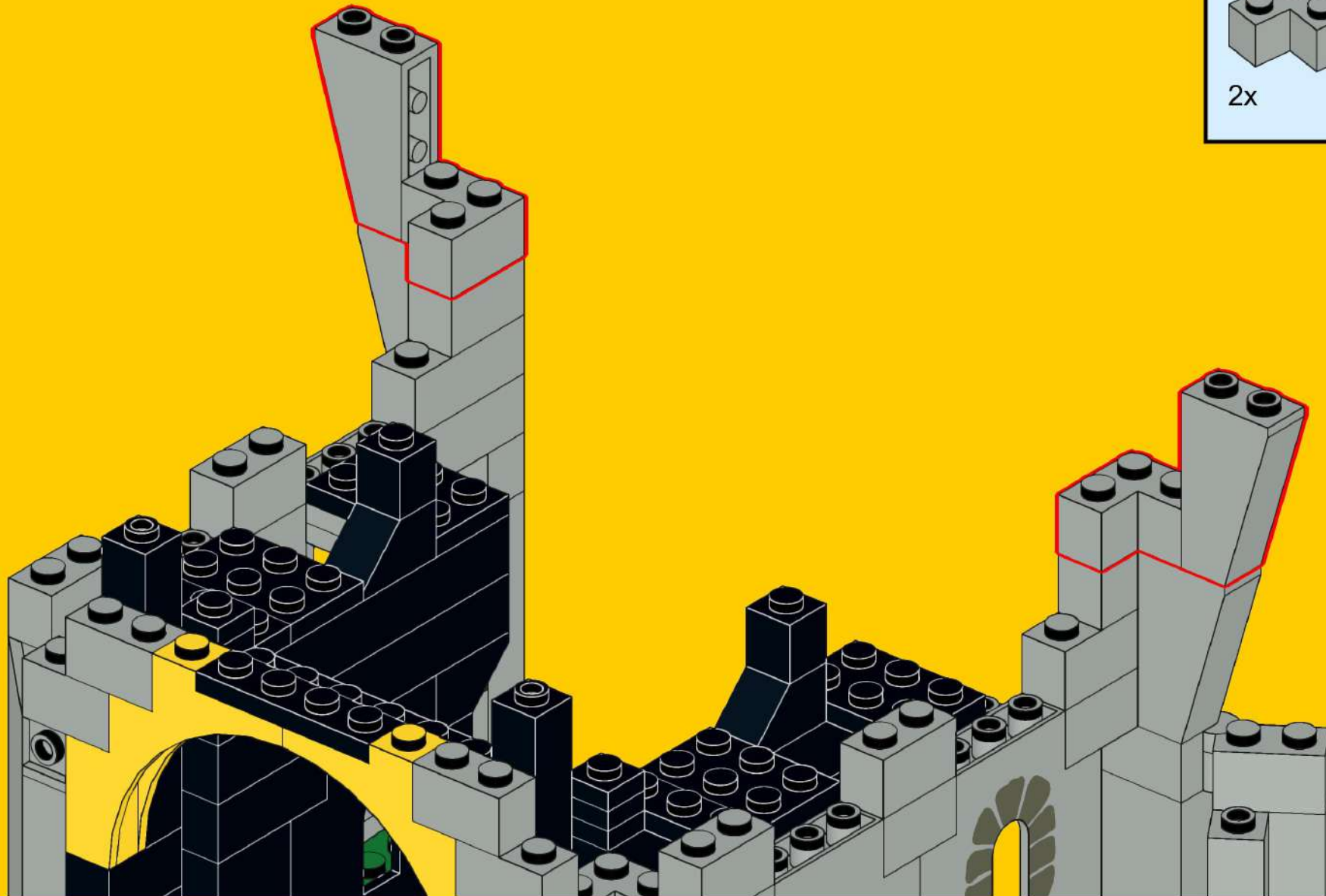



# 24

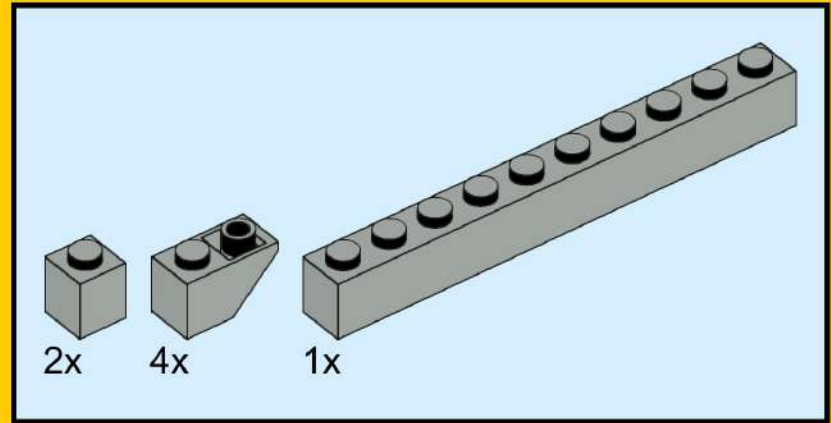
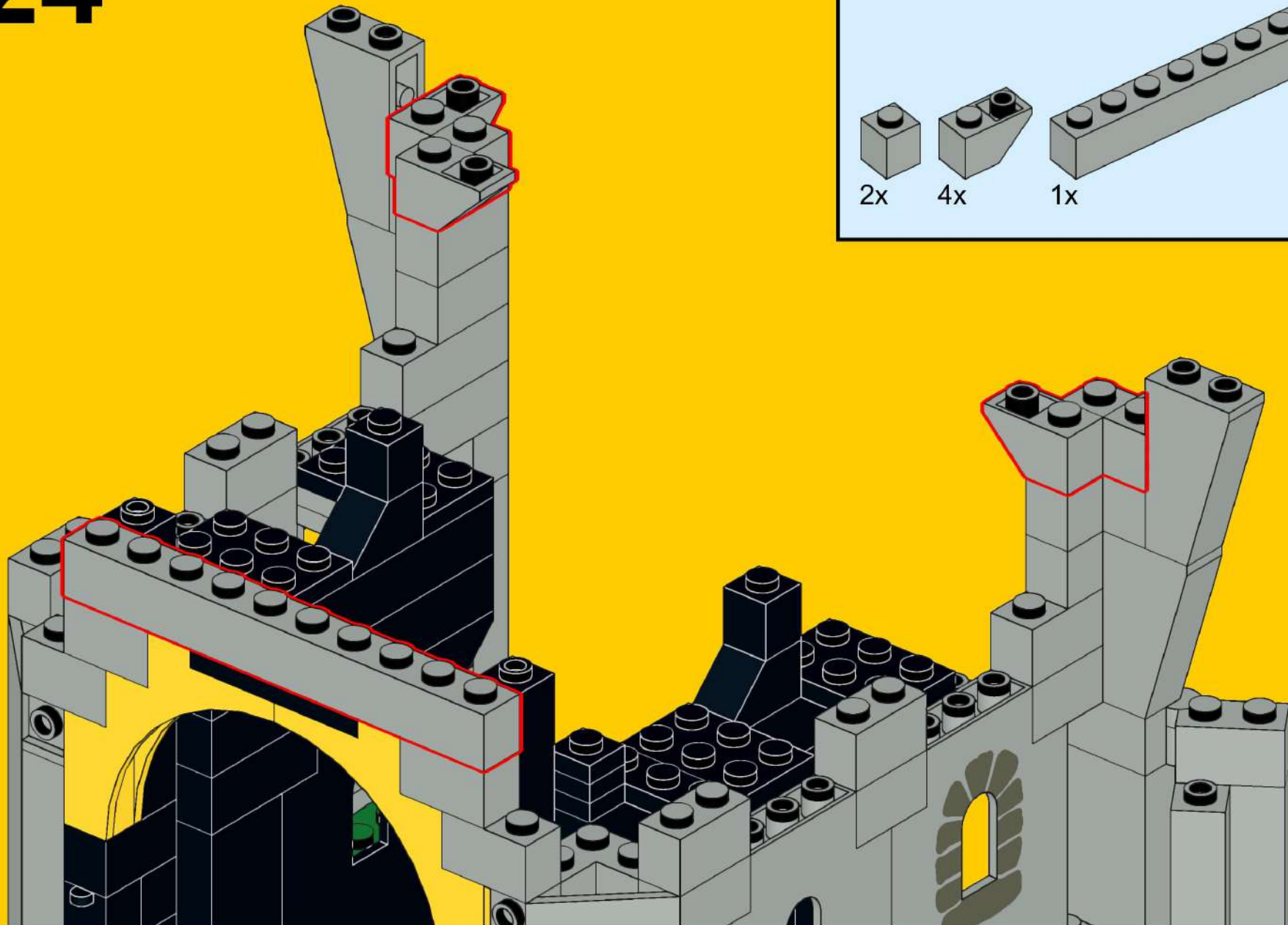

# 25

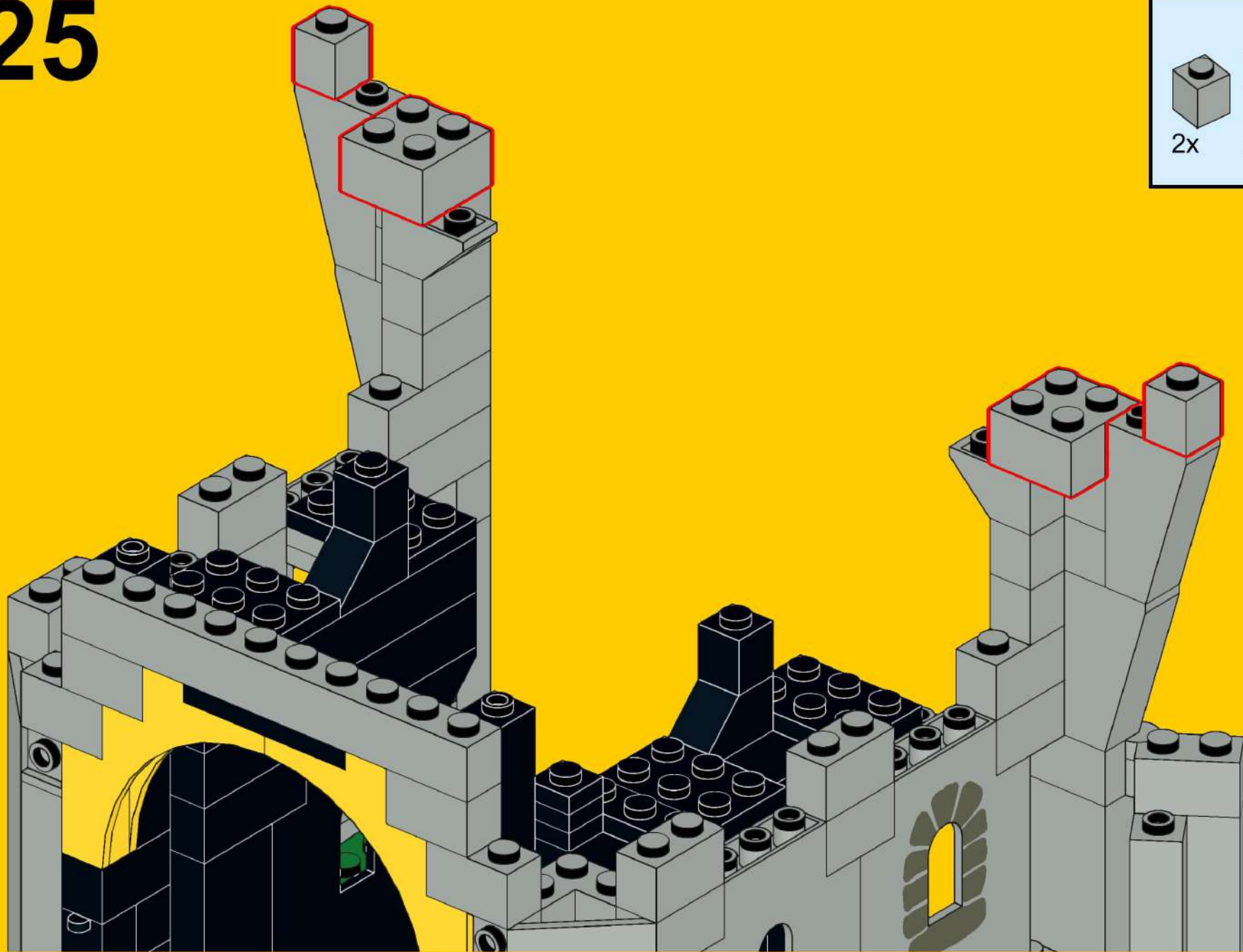
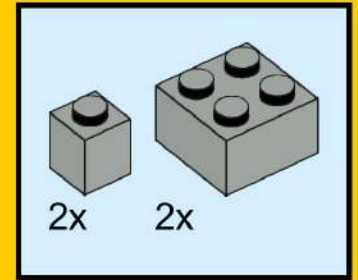

# 26

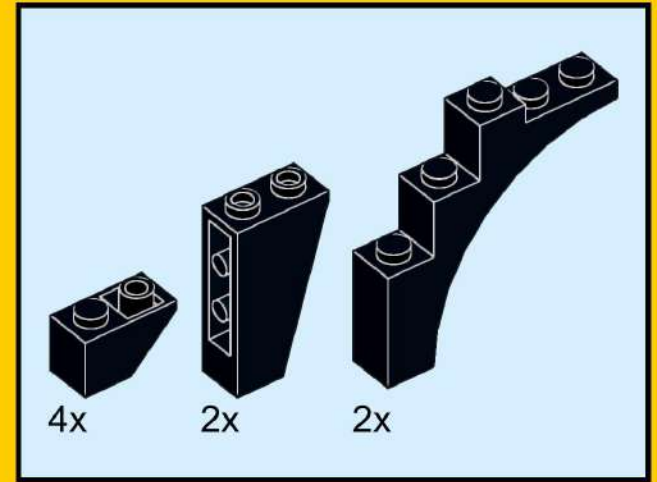
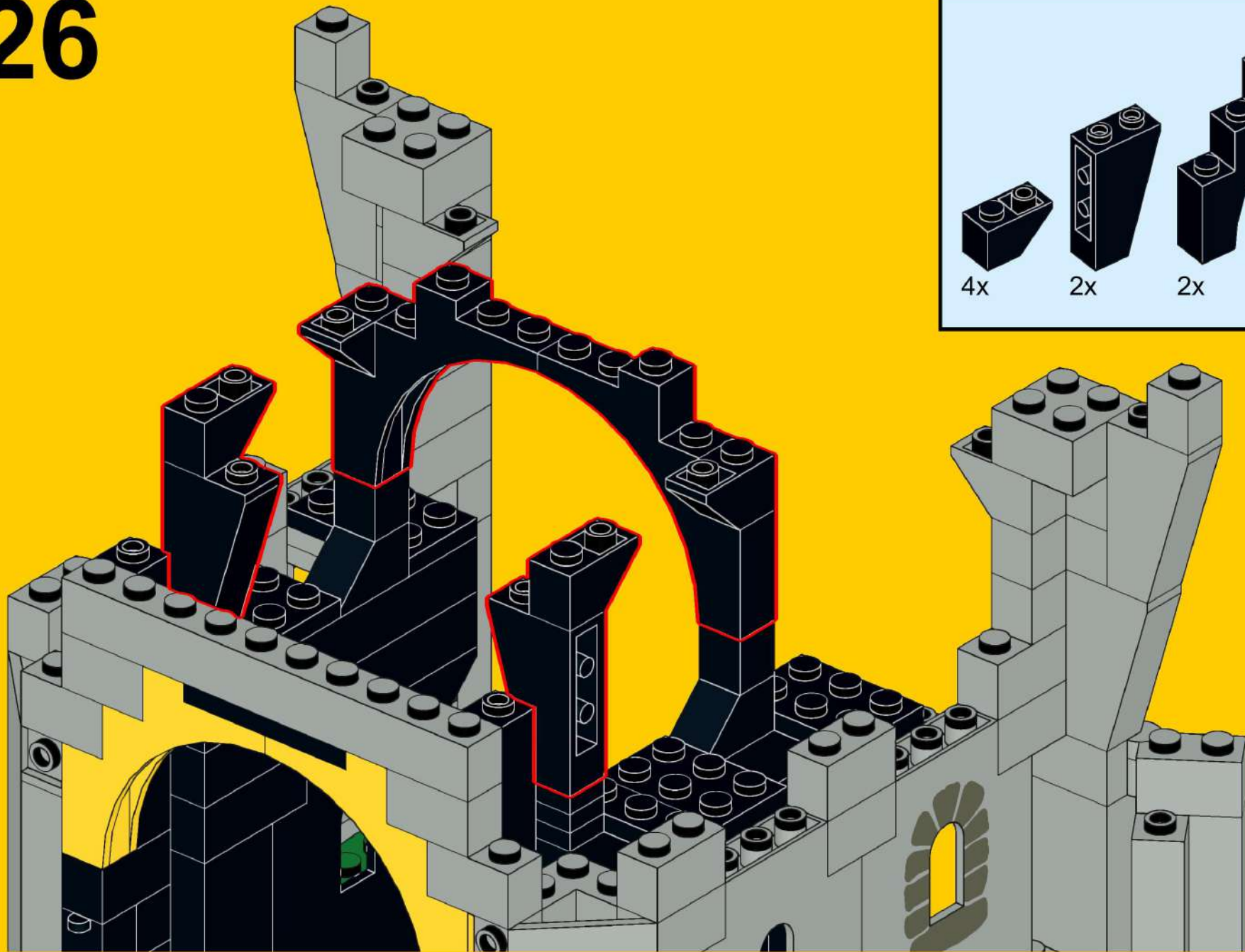

# 27

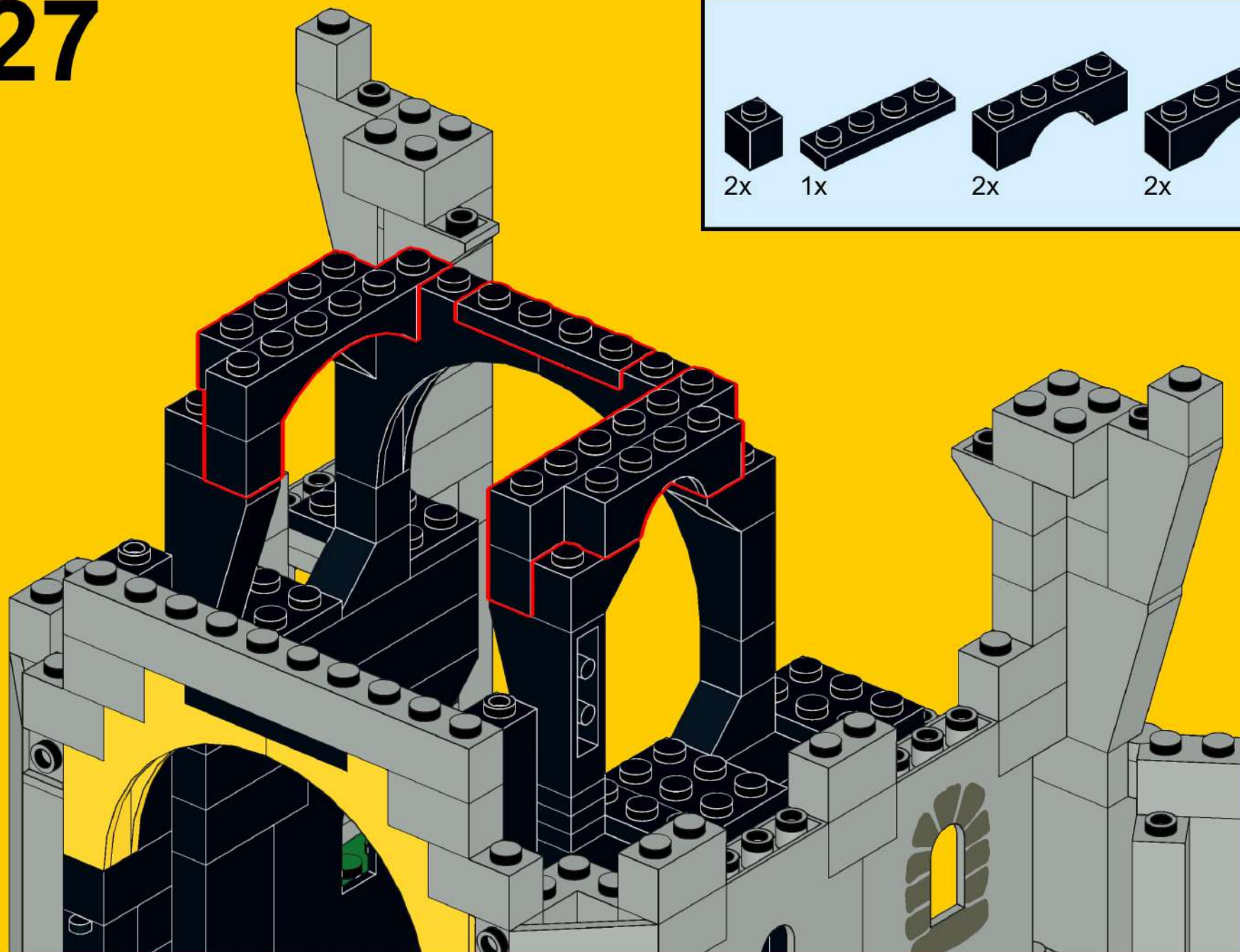
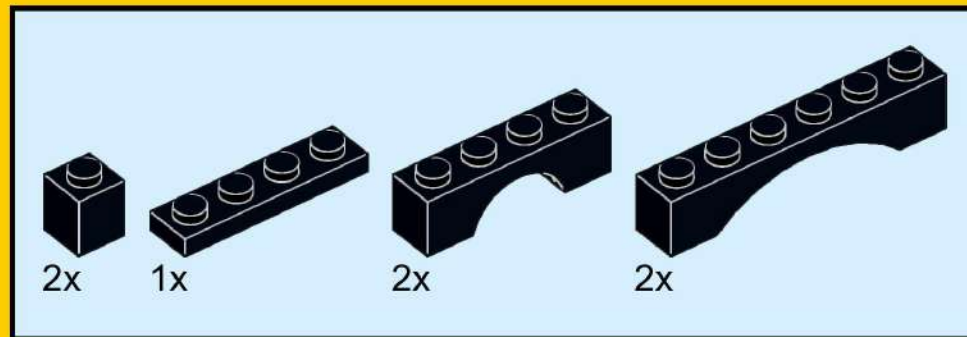

# 28

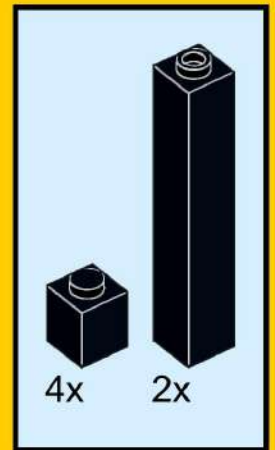
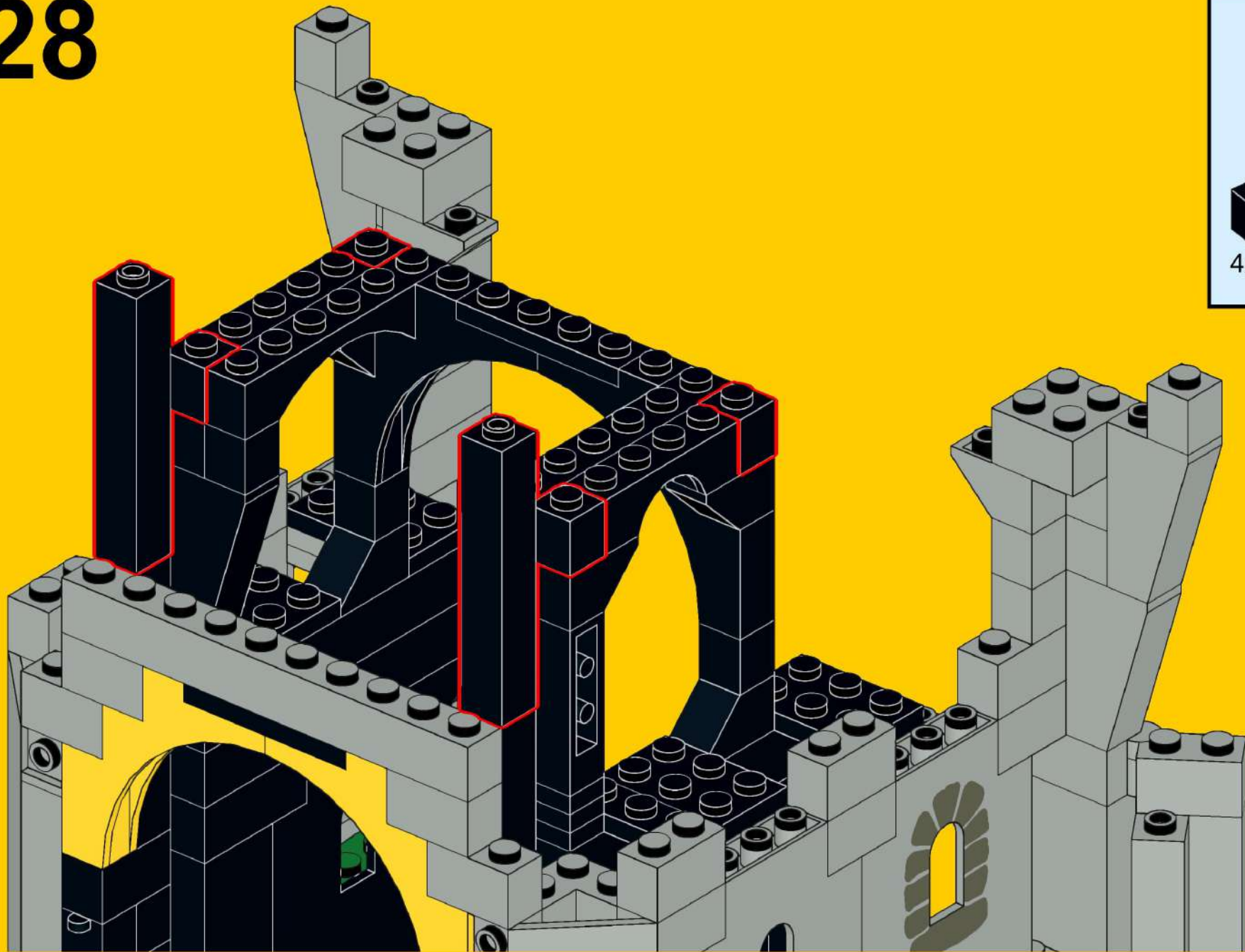

# 29

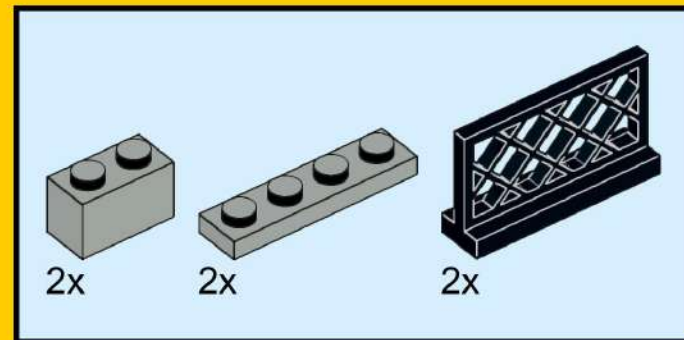
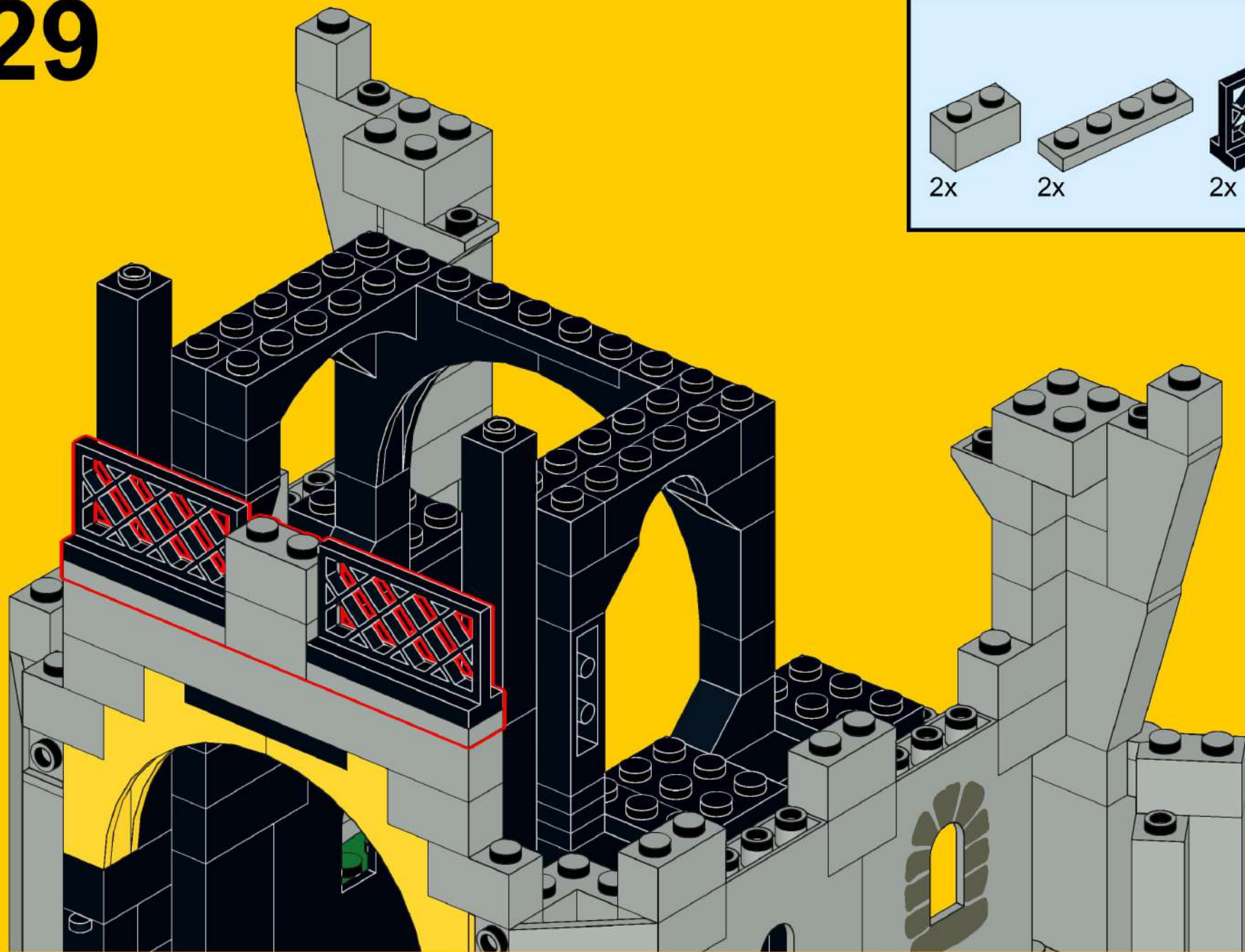

# 30

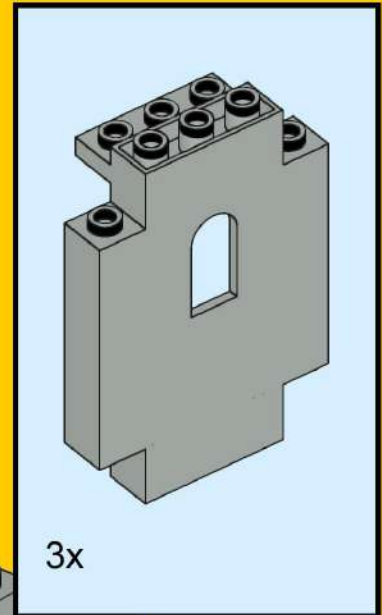
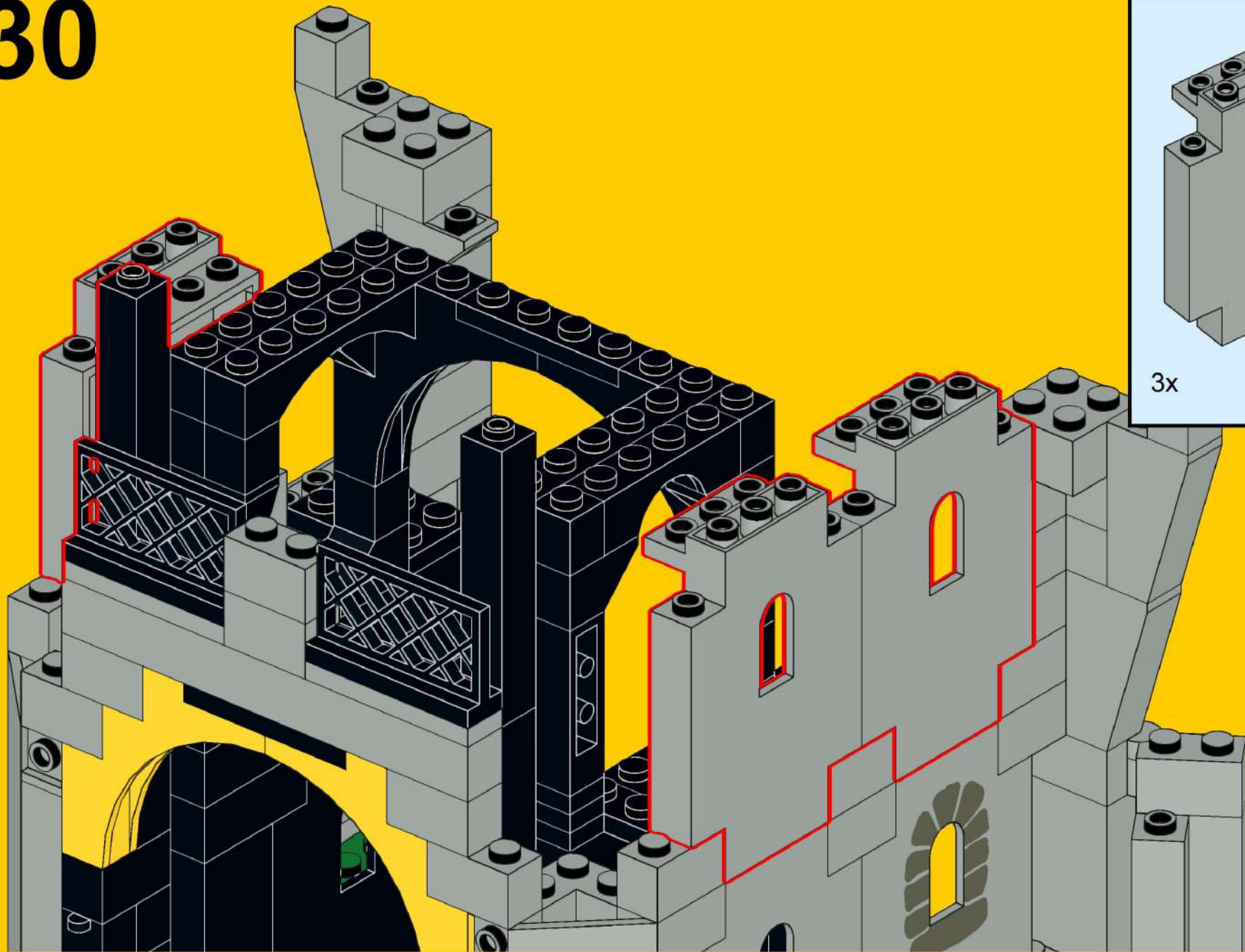

# 31

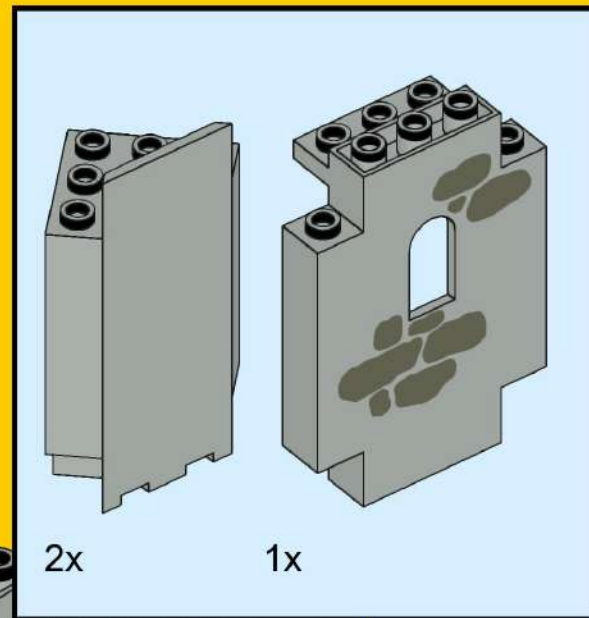
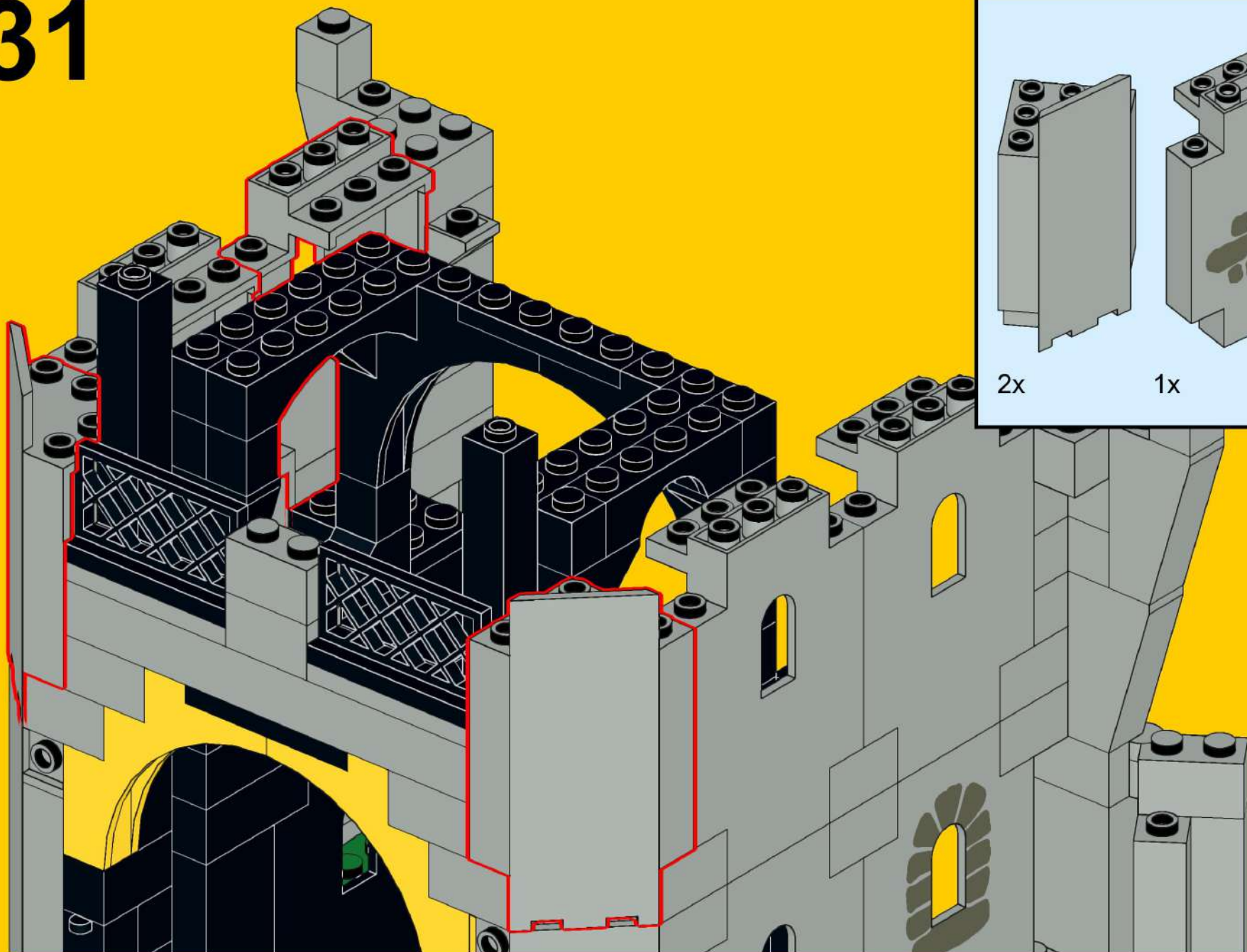



# 32

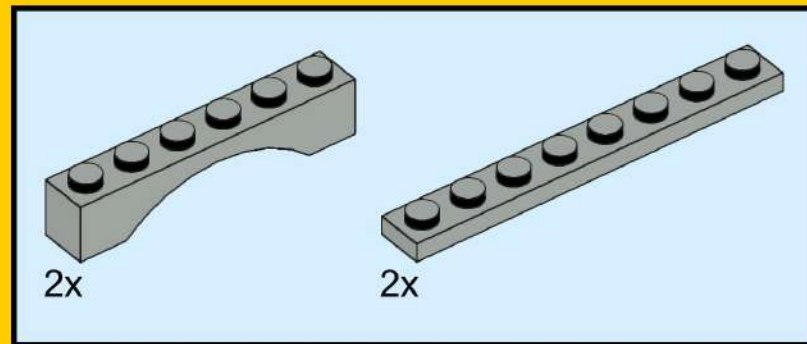
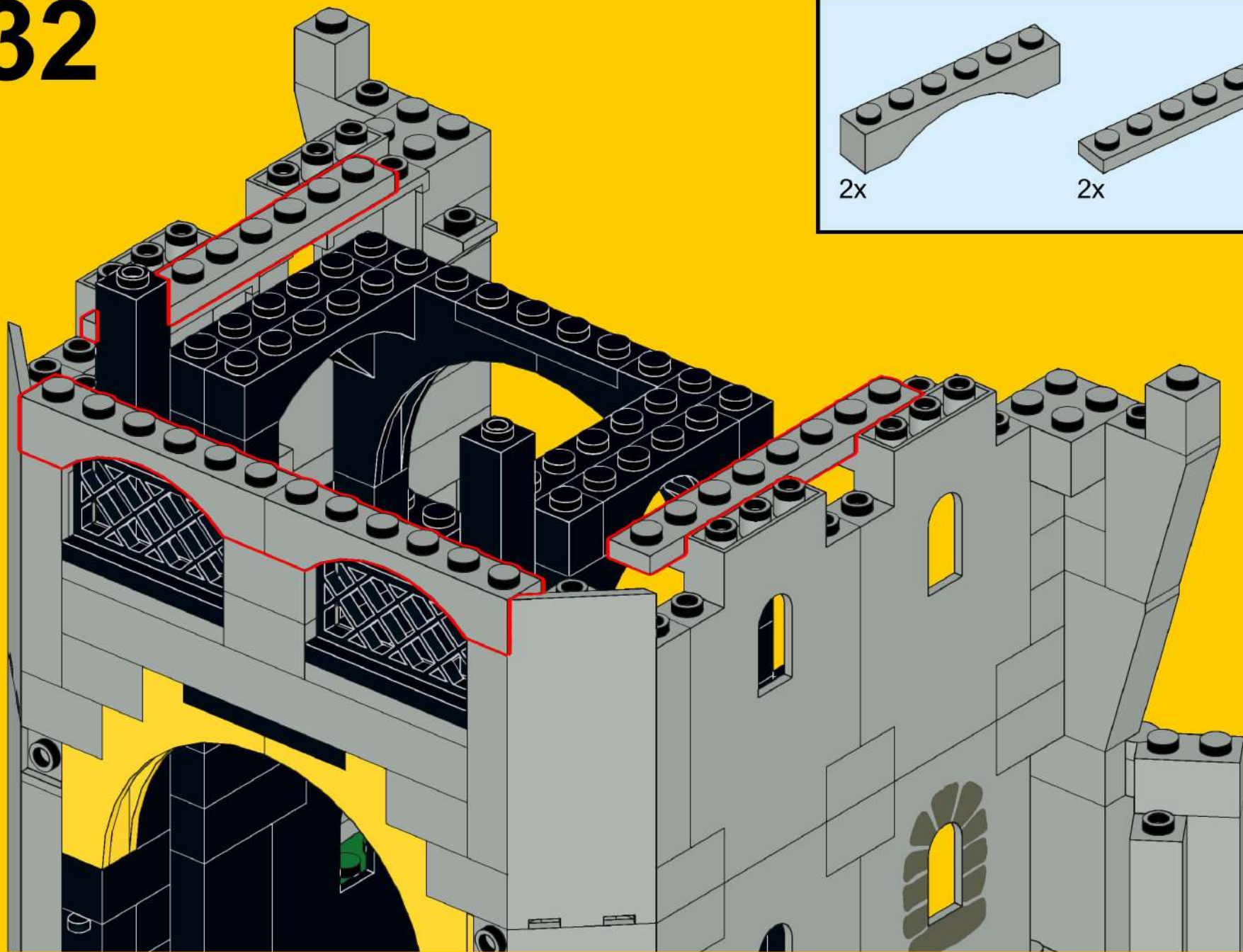

# 33

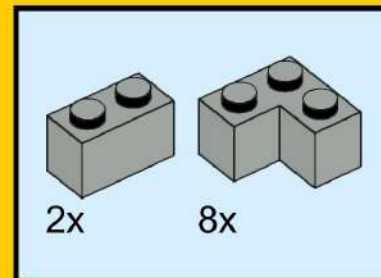

# 34

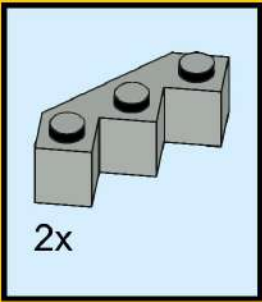

# 35

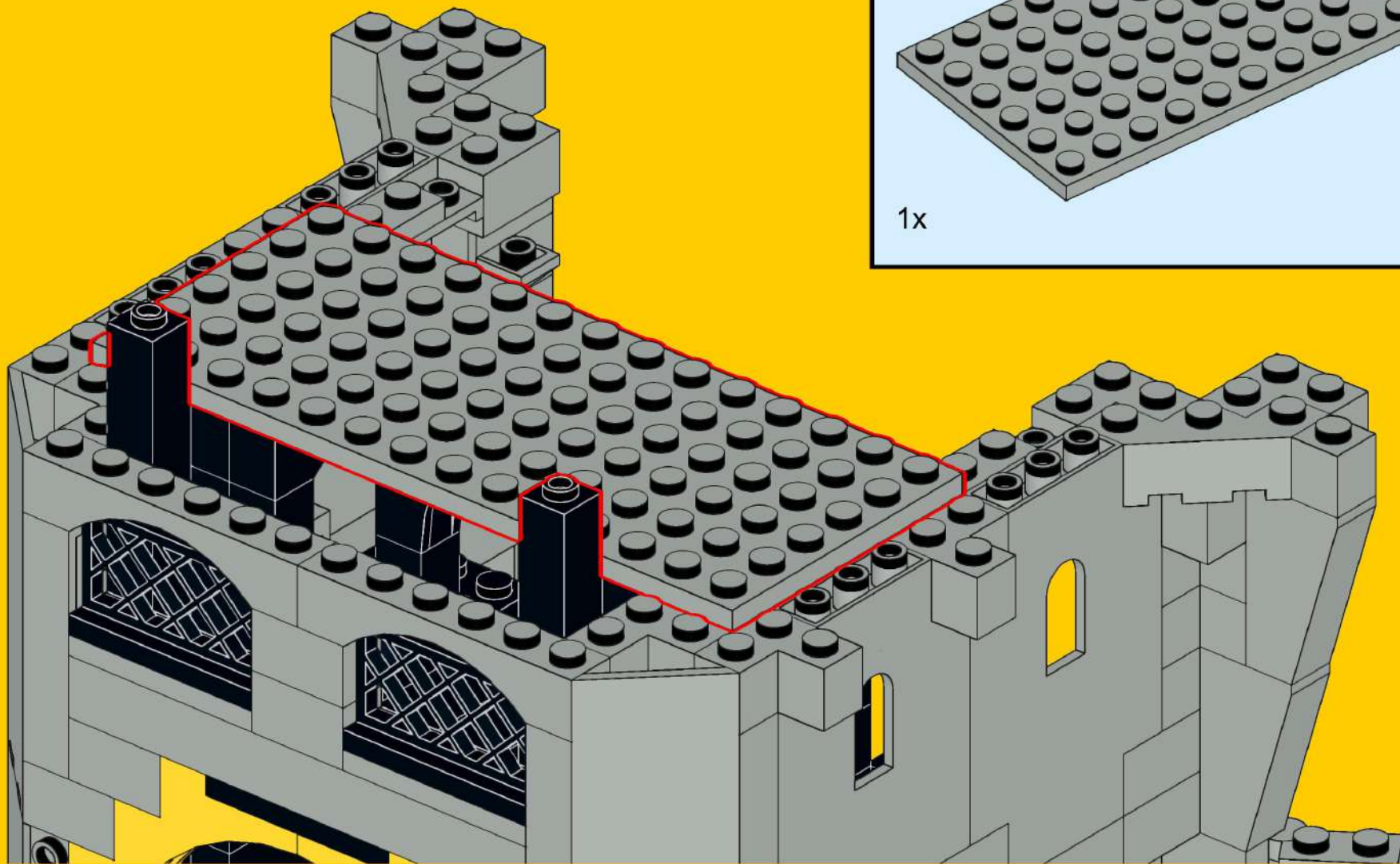
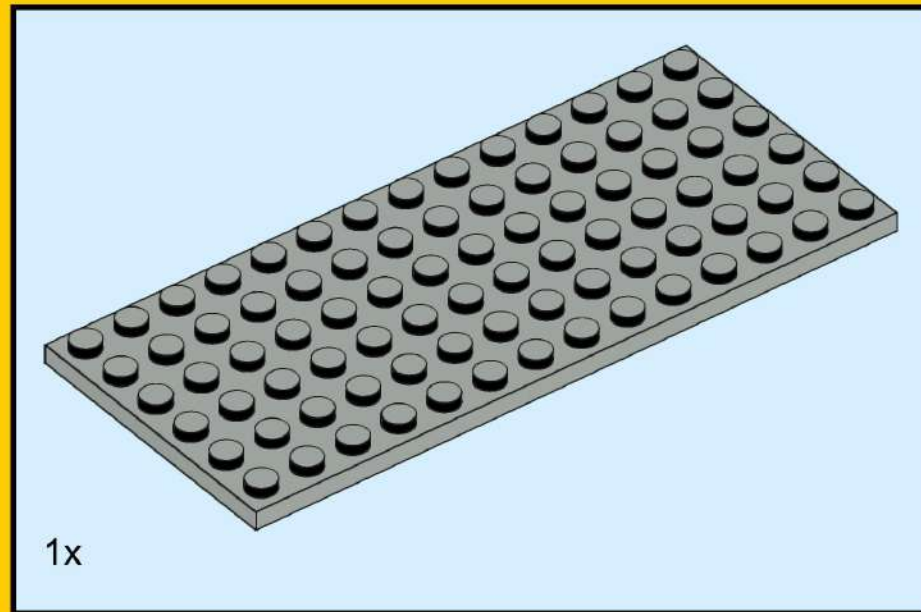

# 36

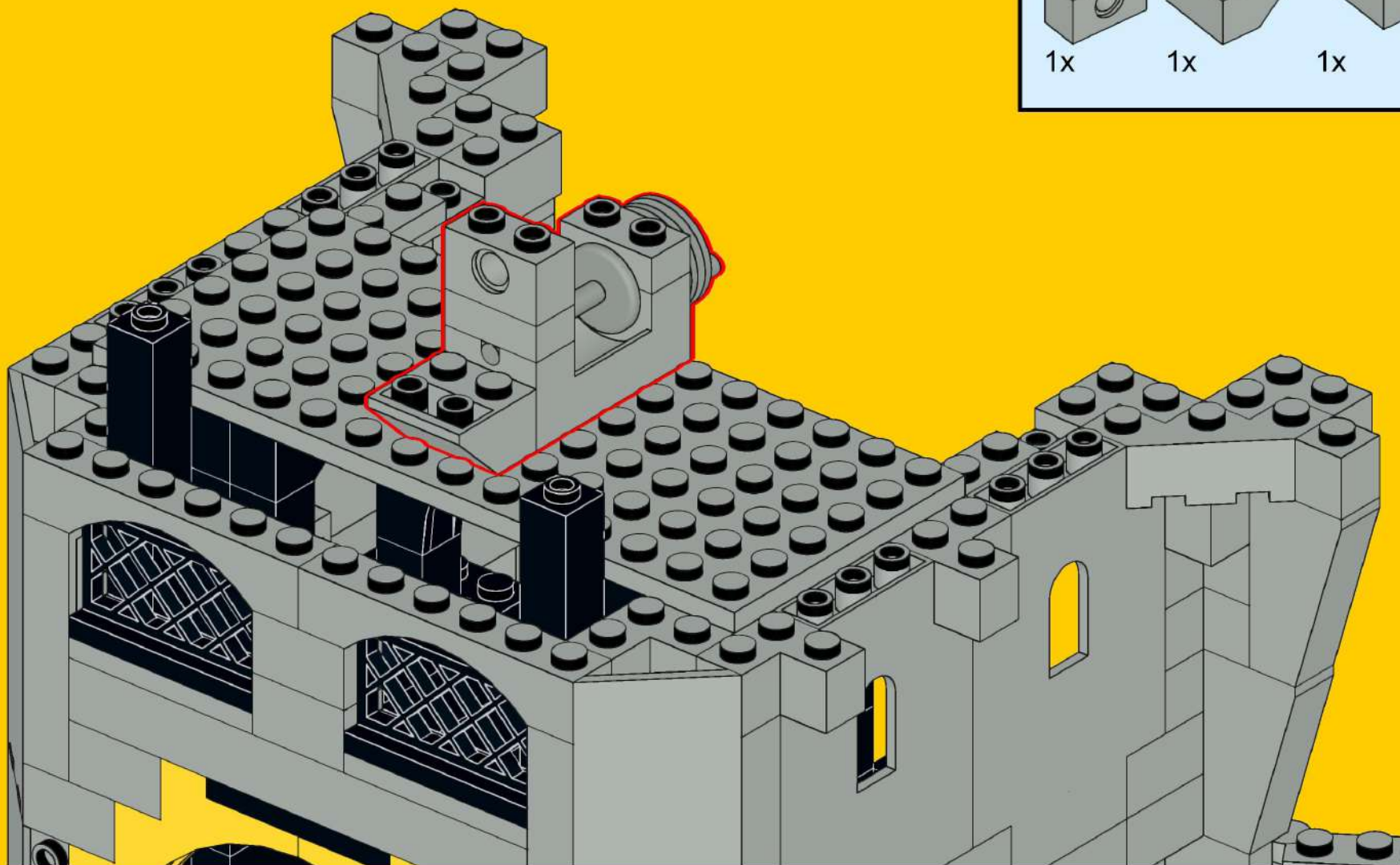
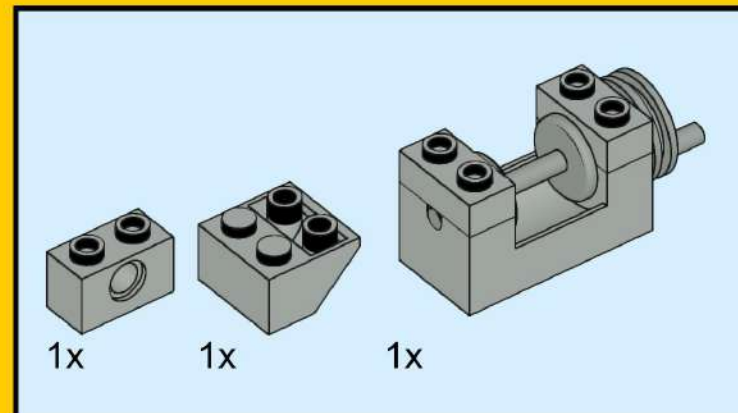

# 37

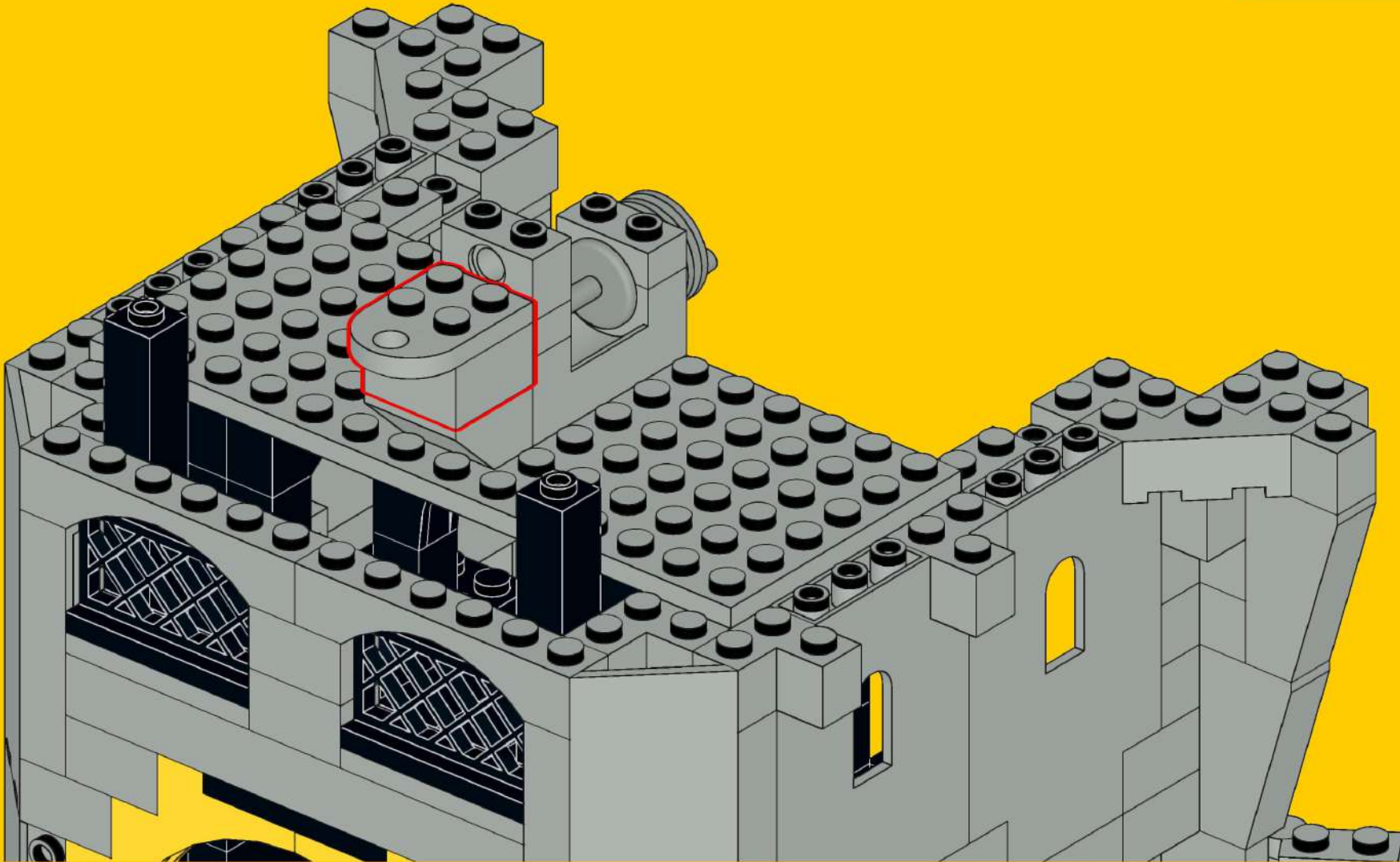
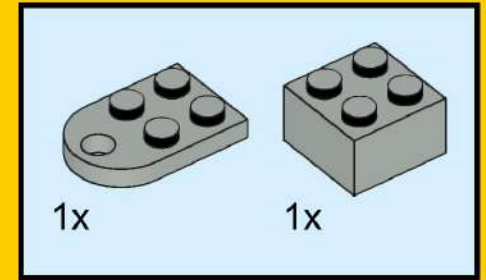

# 38

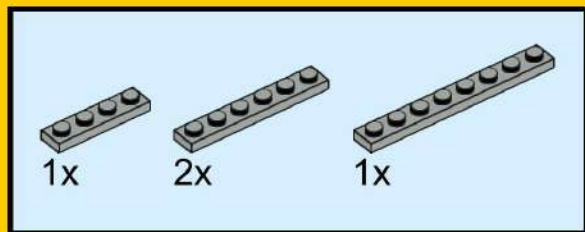
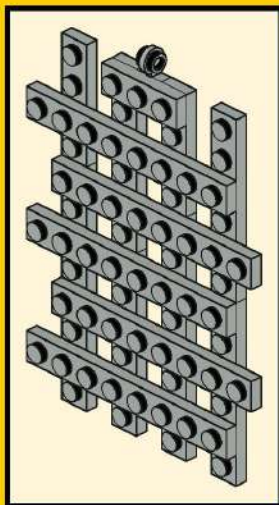
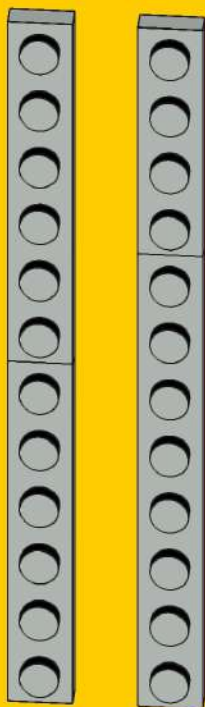

# 39

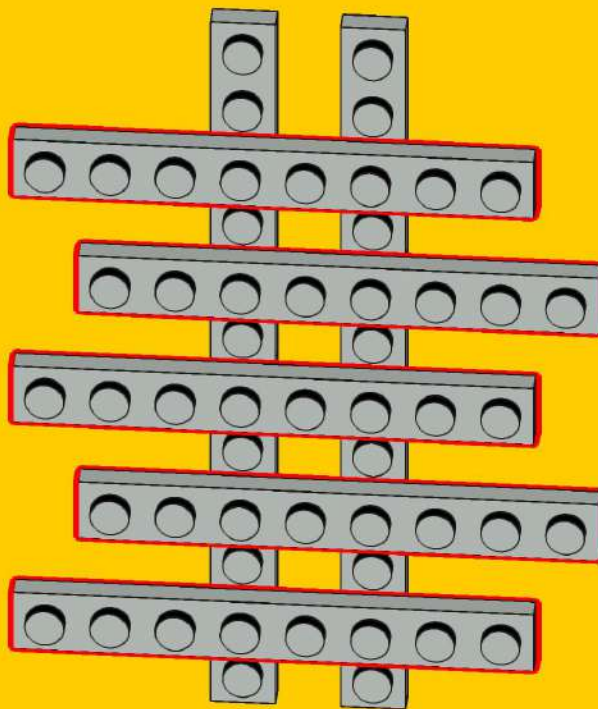
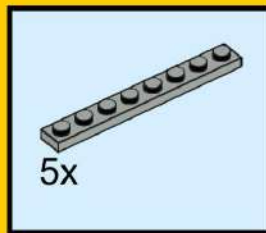

# 40

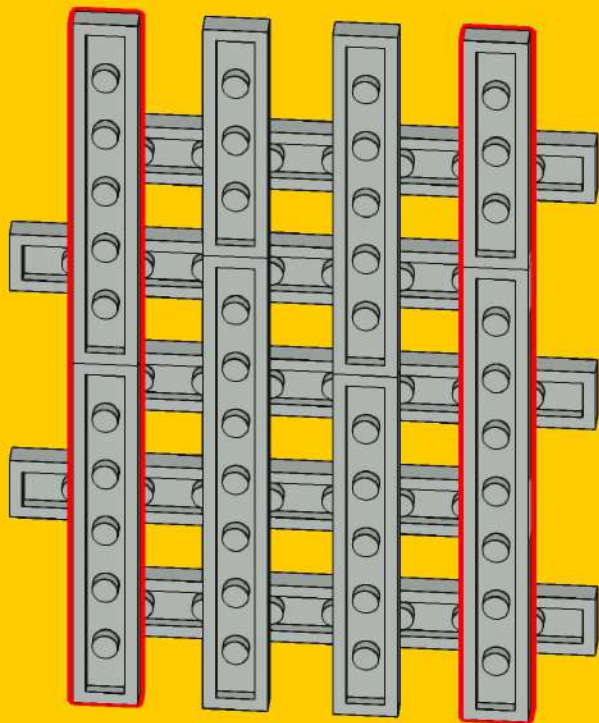
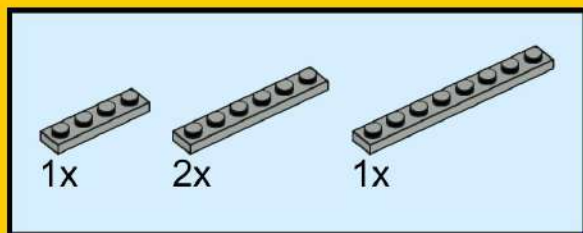

# 41

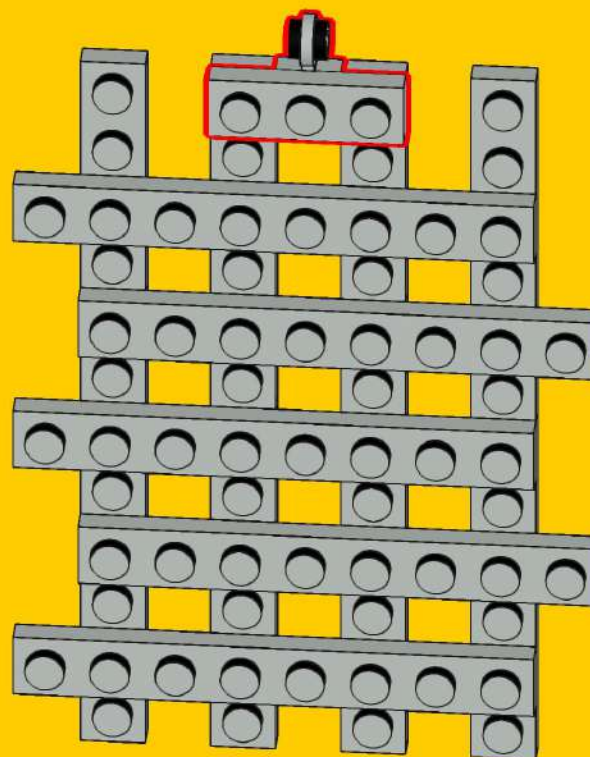
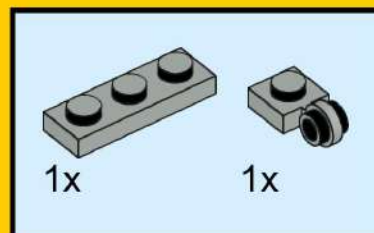



# 42

Tie the rope to the portcullis and the reel passing through the techinc plate and brick



# 43

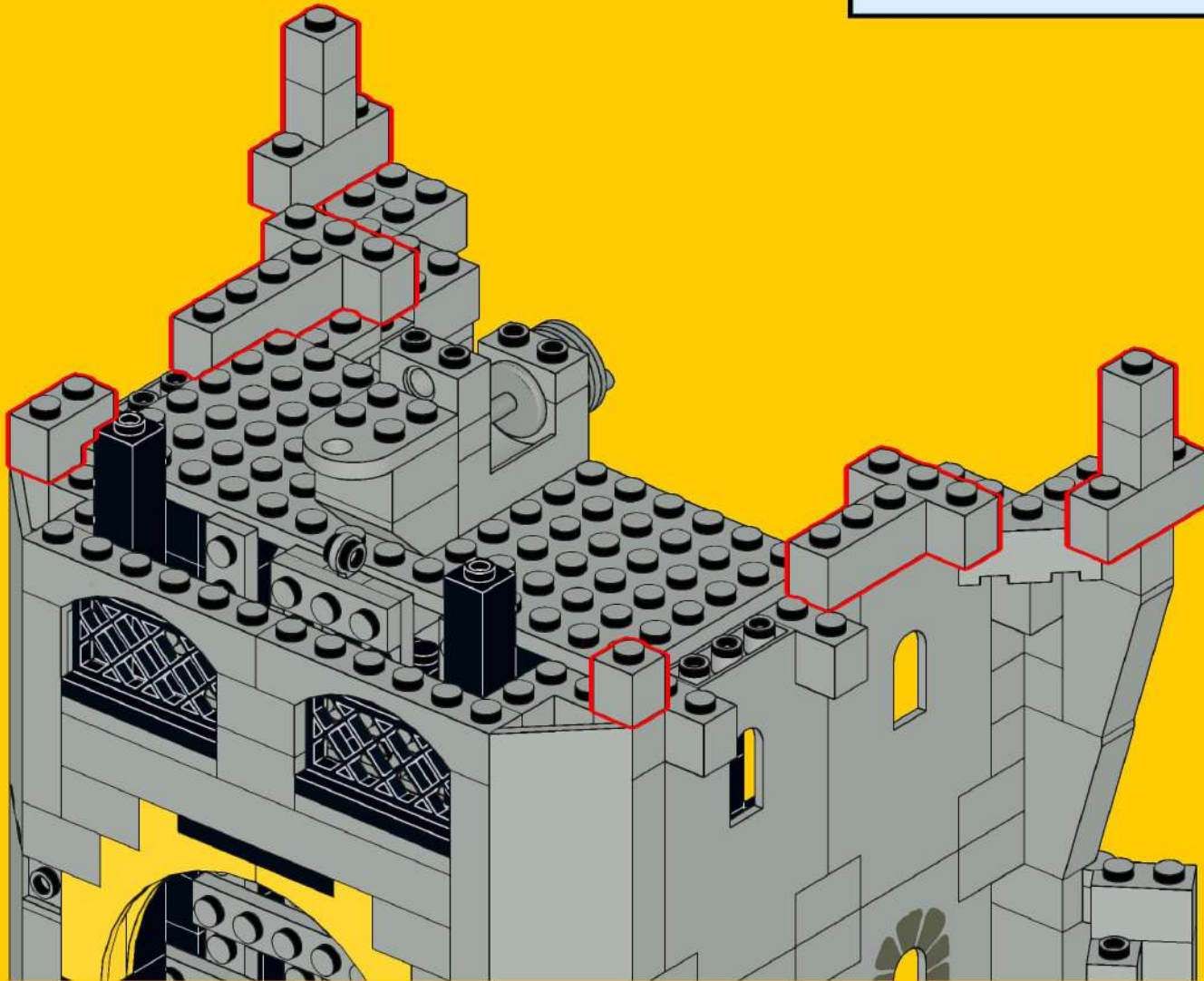
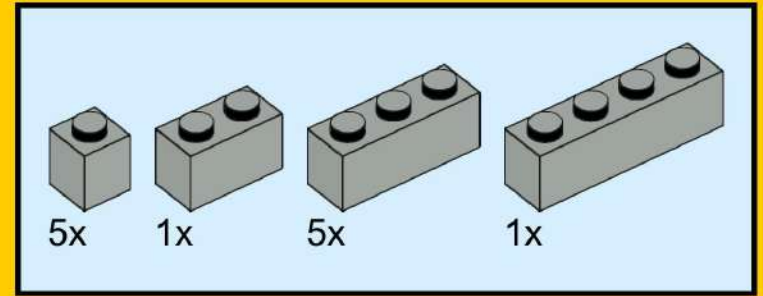

# 44

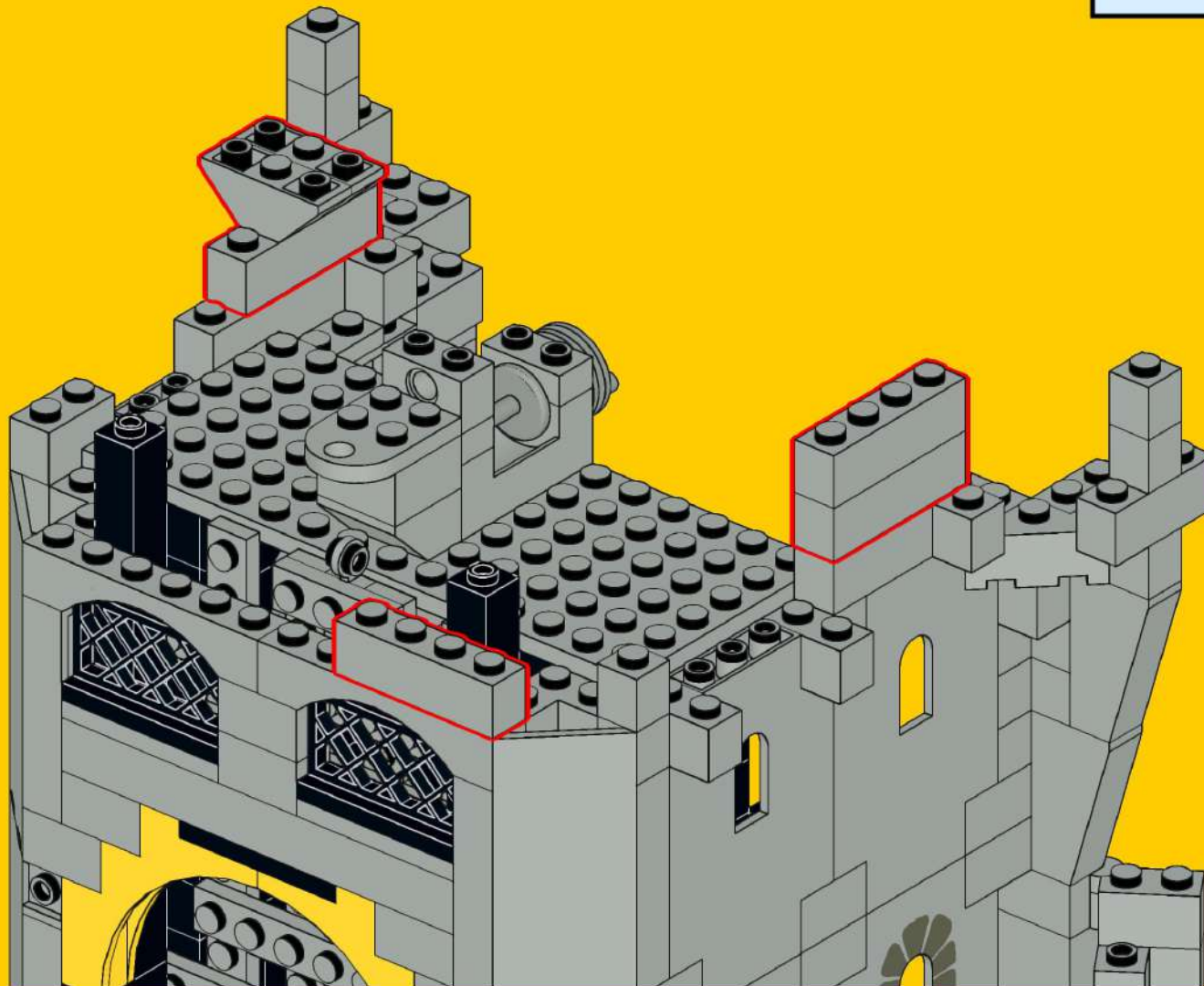
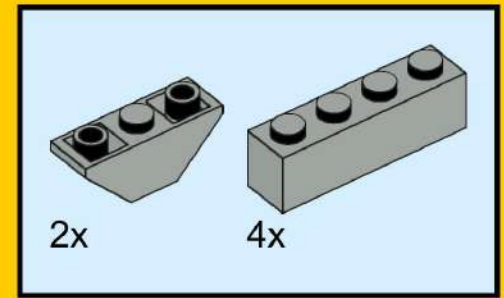

# 45

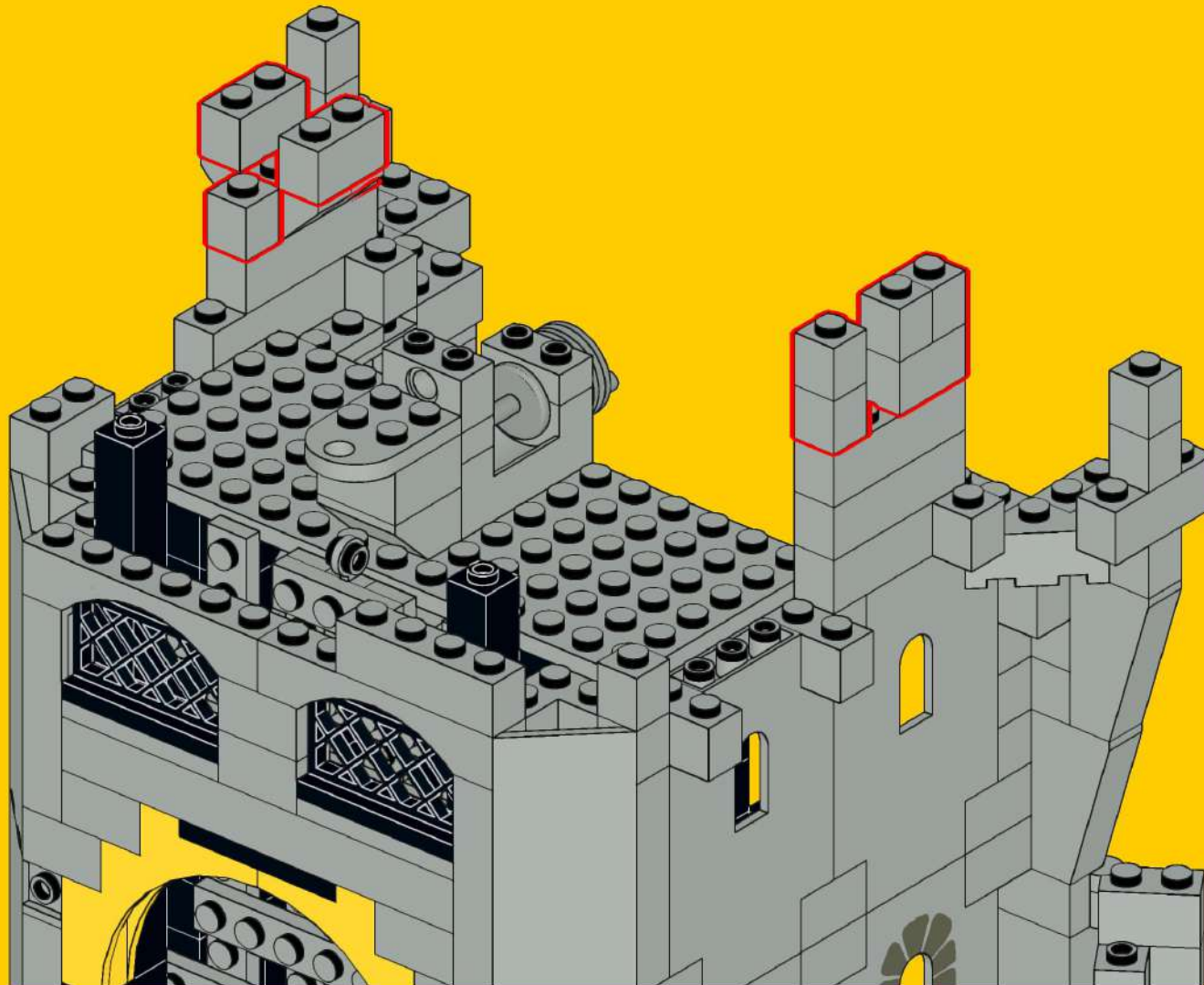
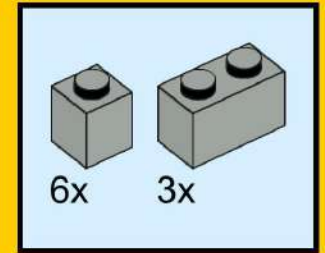

# 46

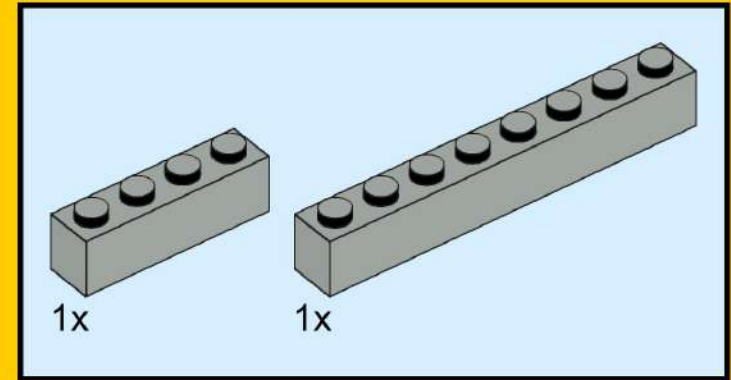
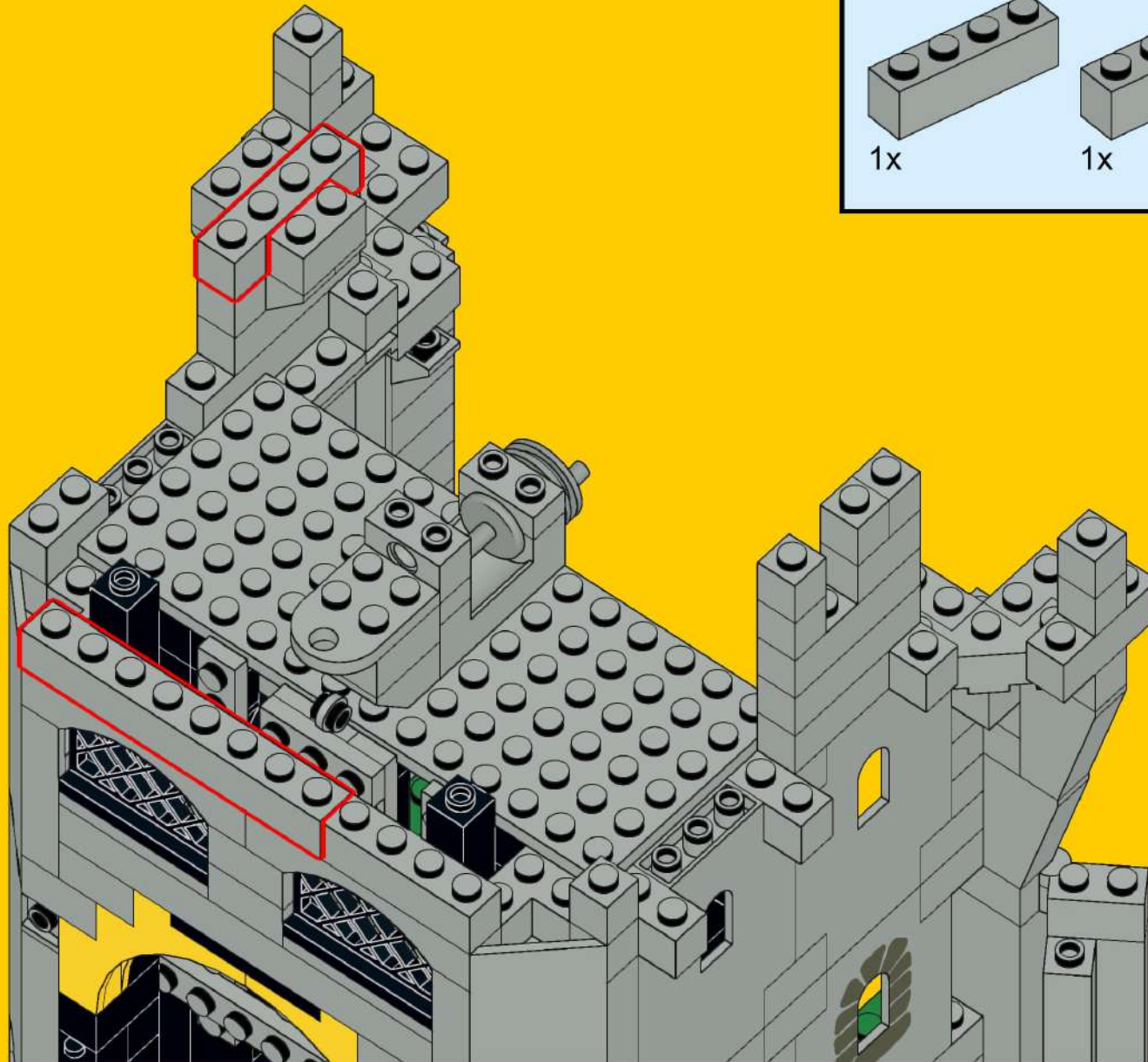

# 47

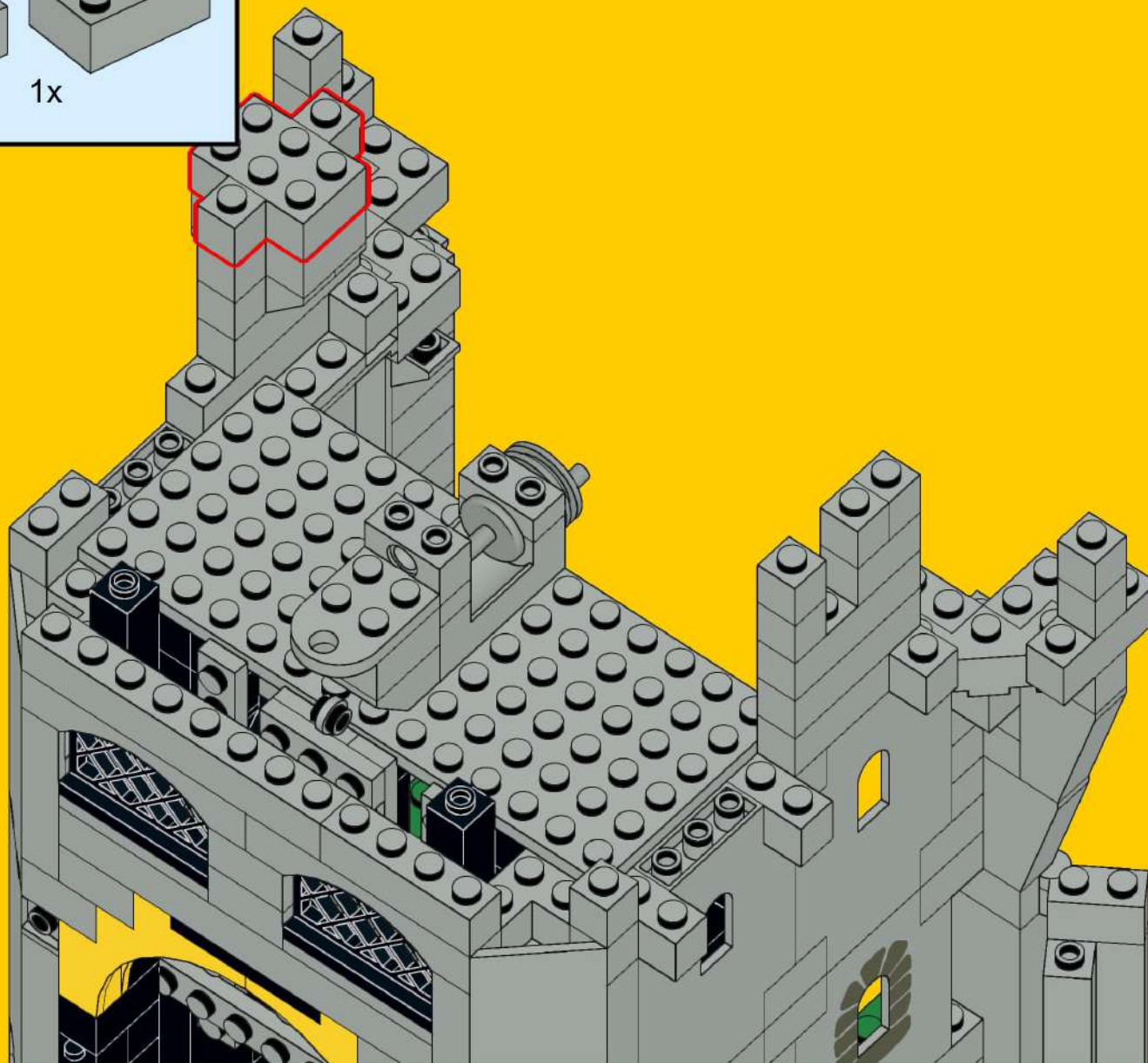
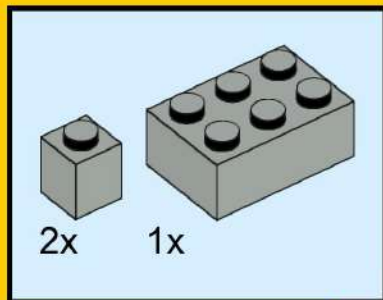

# 48

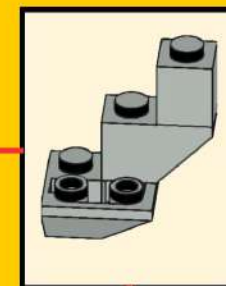

2x

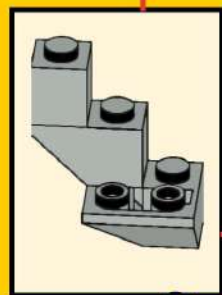

2x

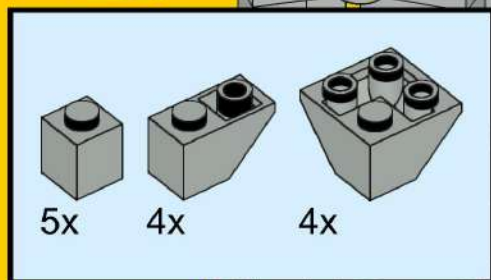

5x

4x

4x

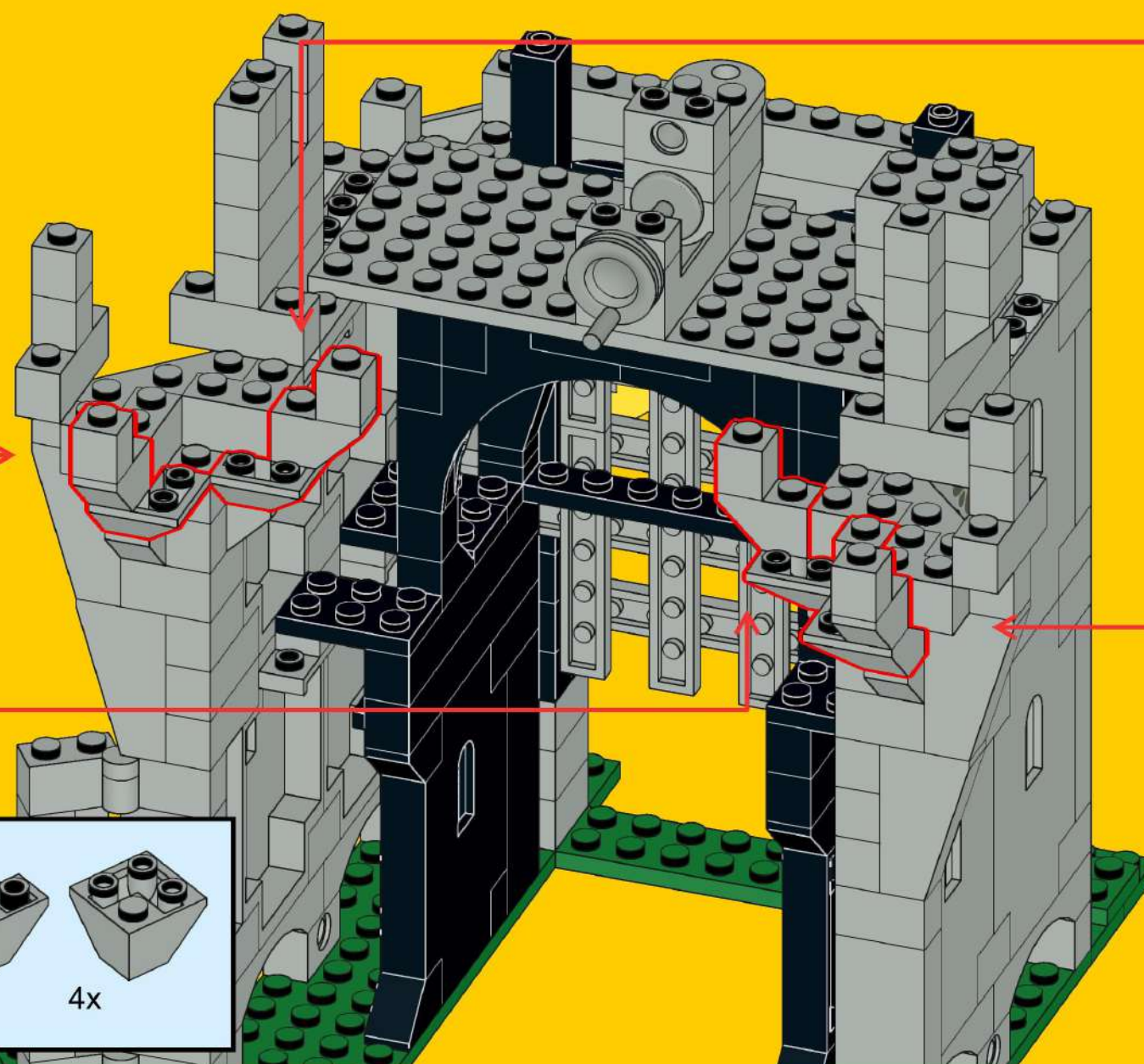

# 49

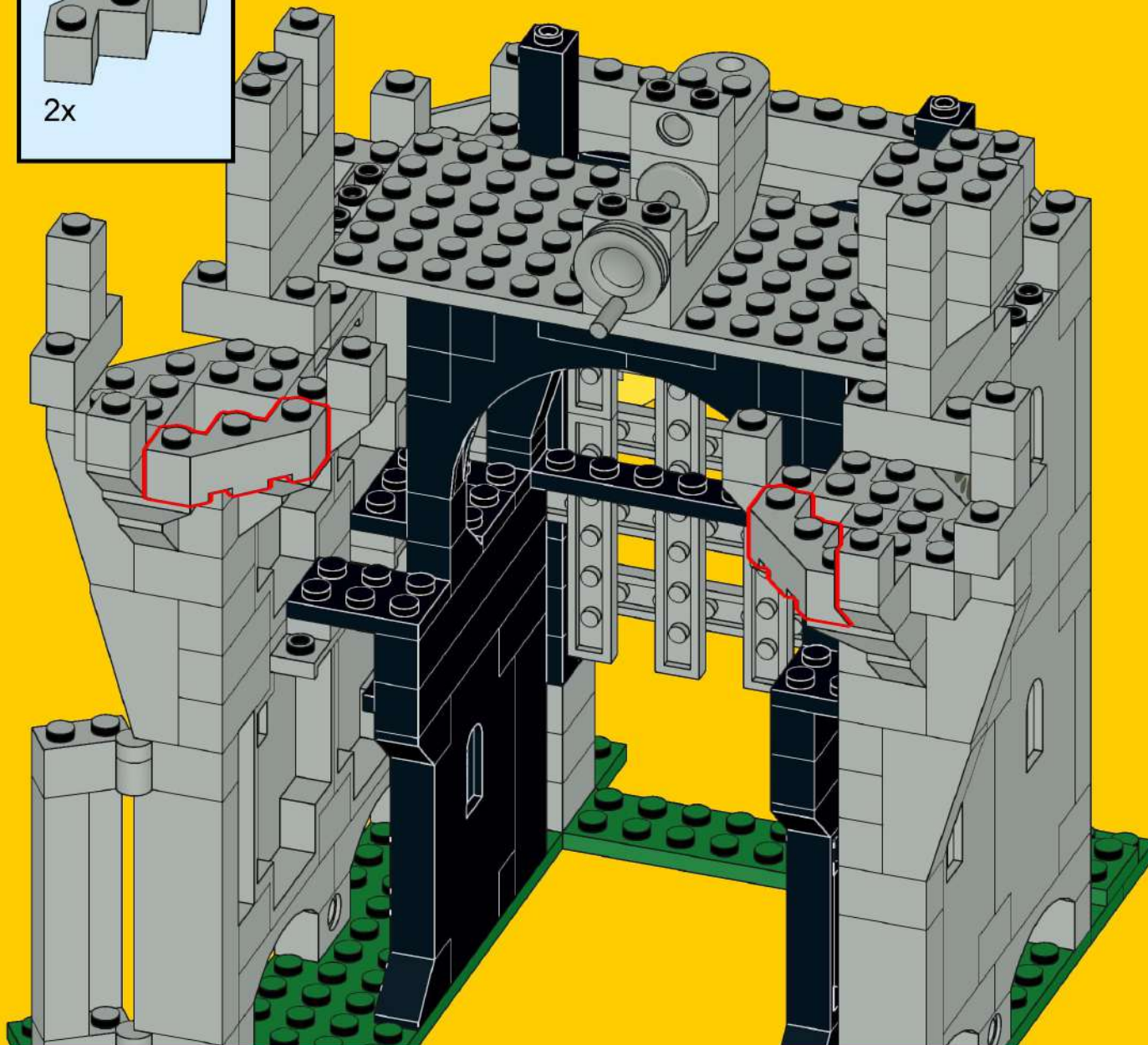
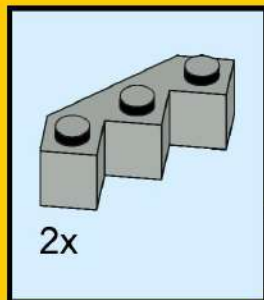



# 50

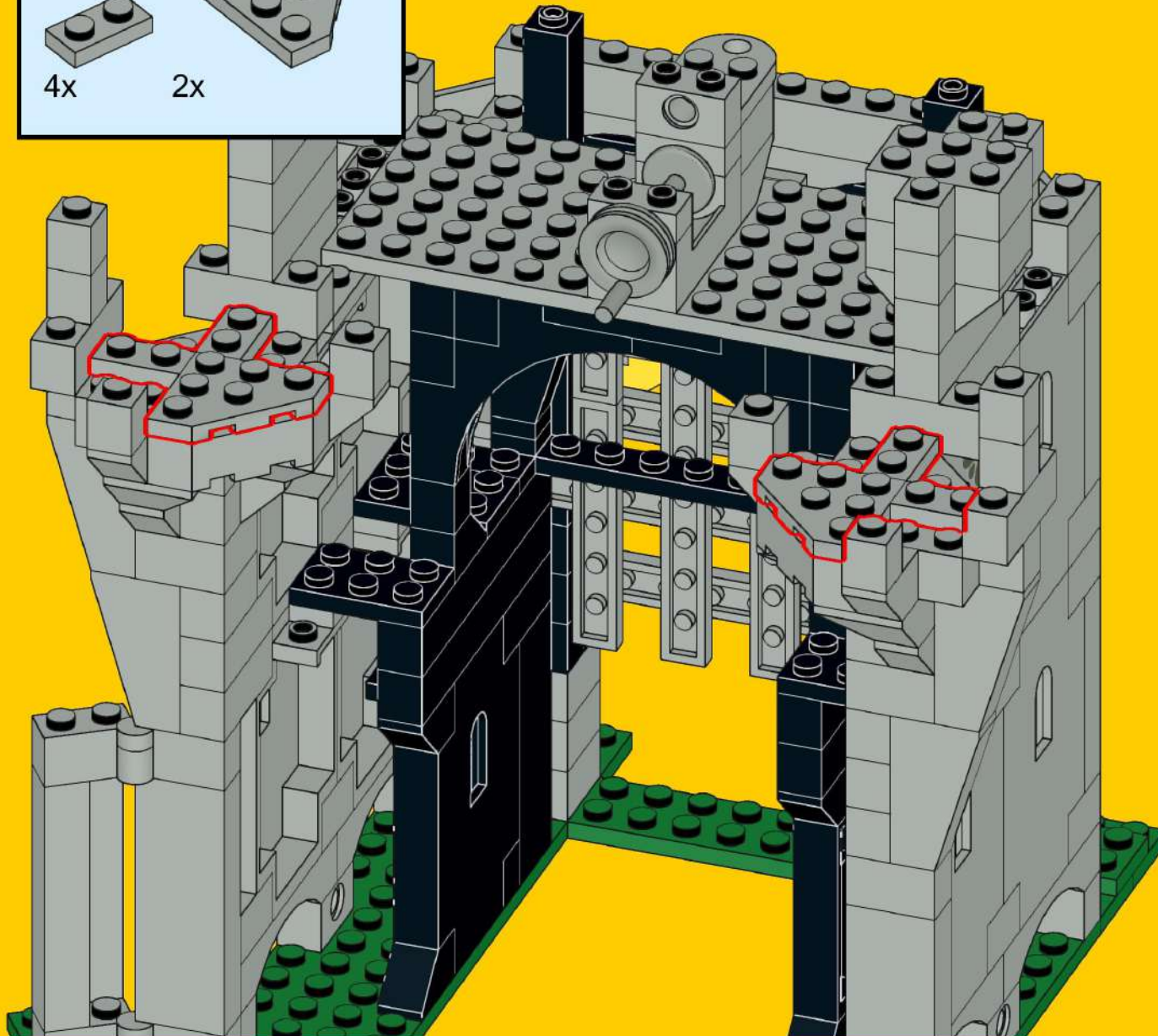
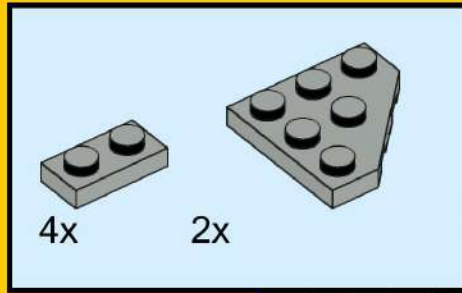

# 51

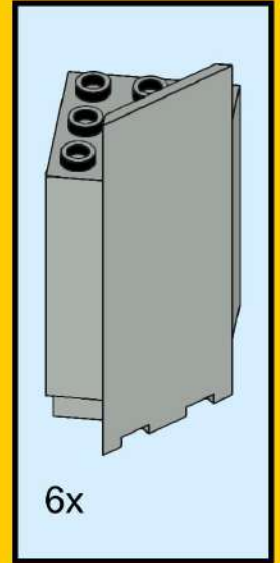
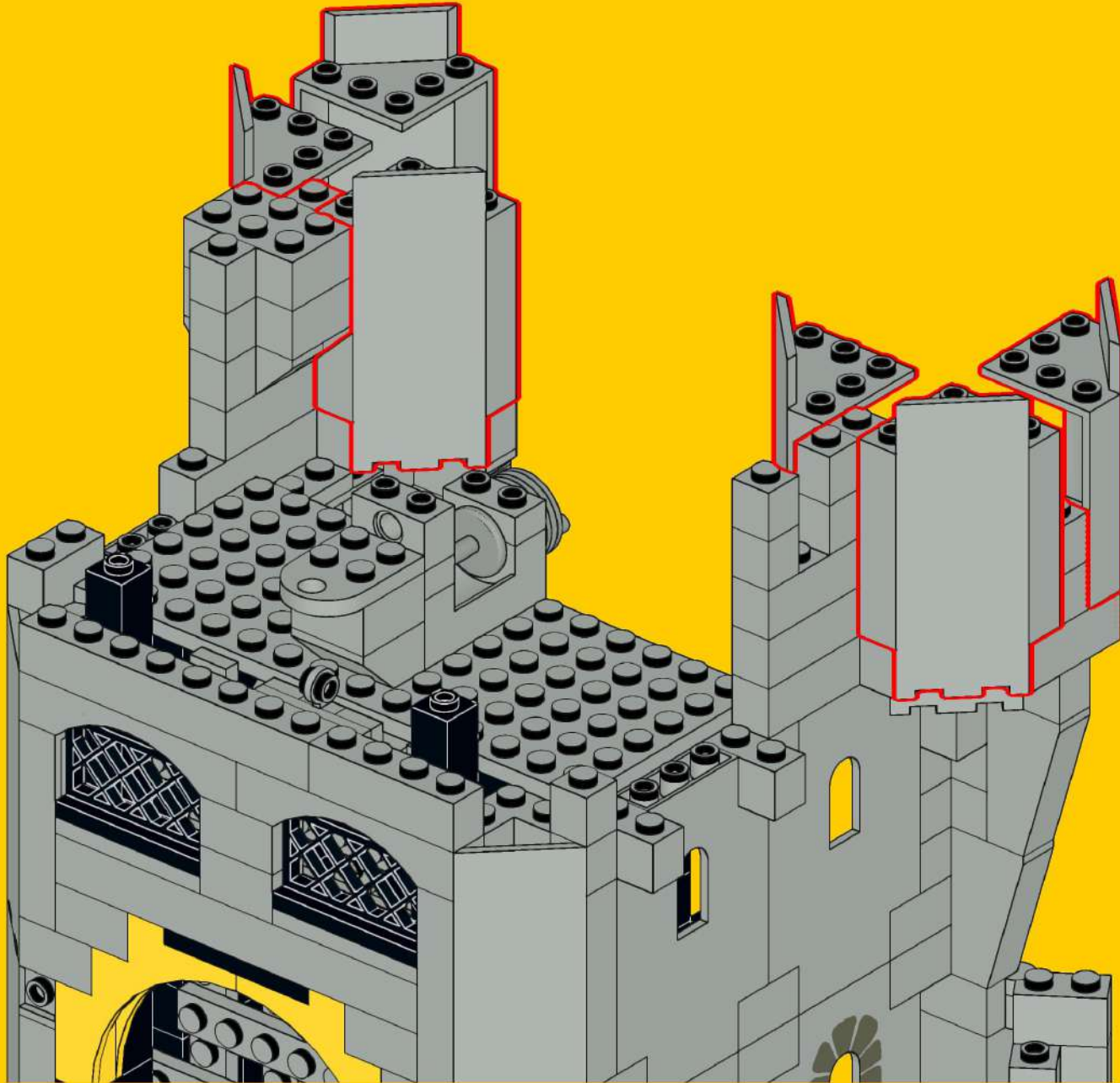

# 52

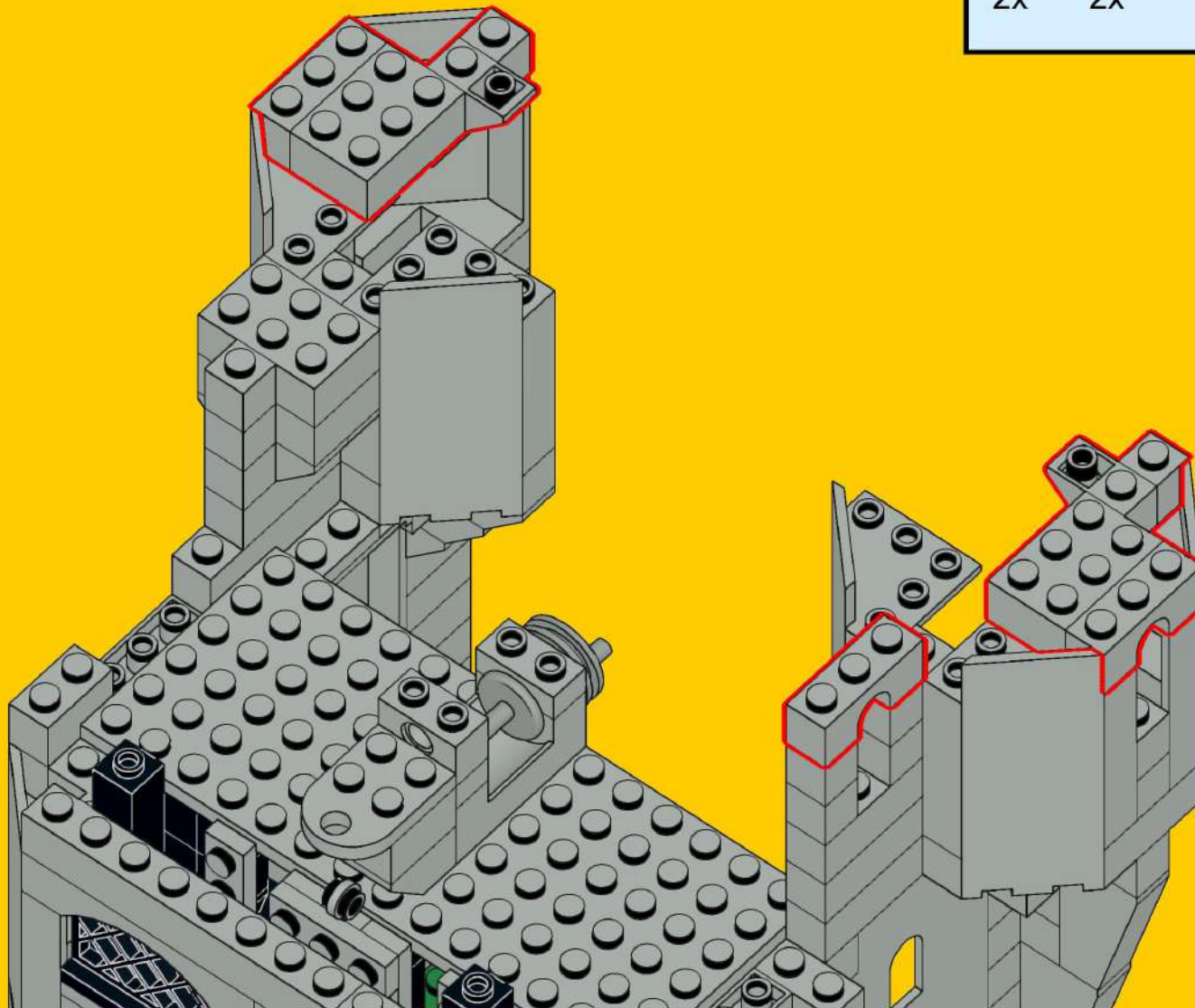
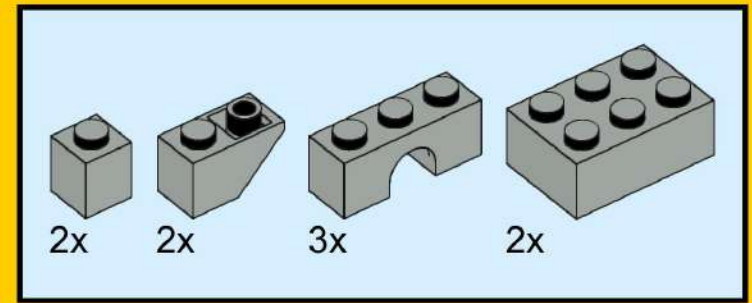

# 53

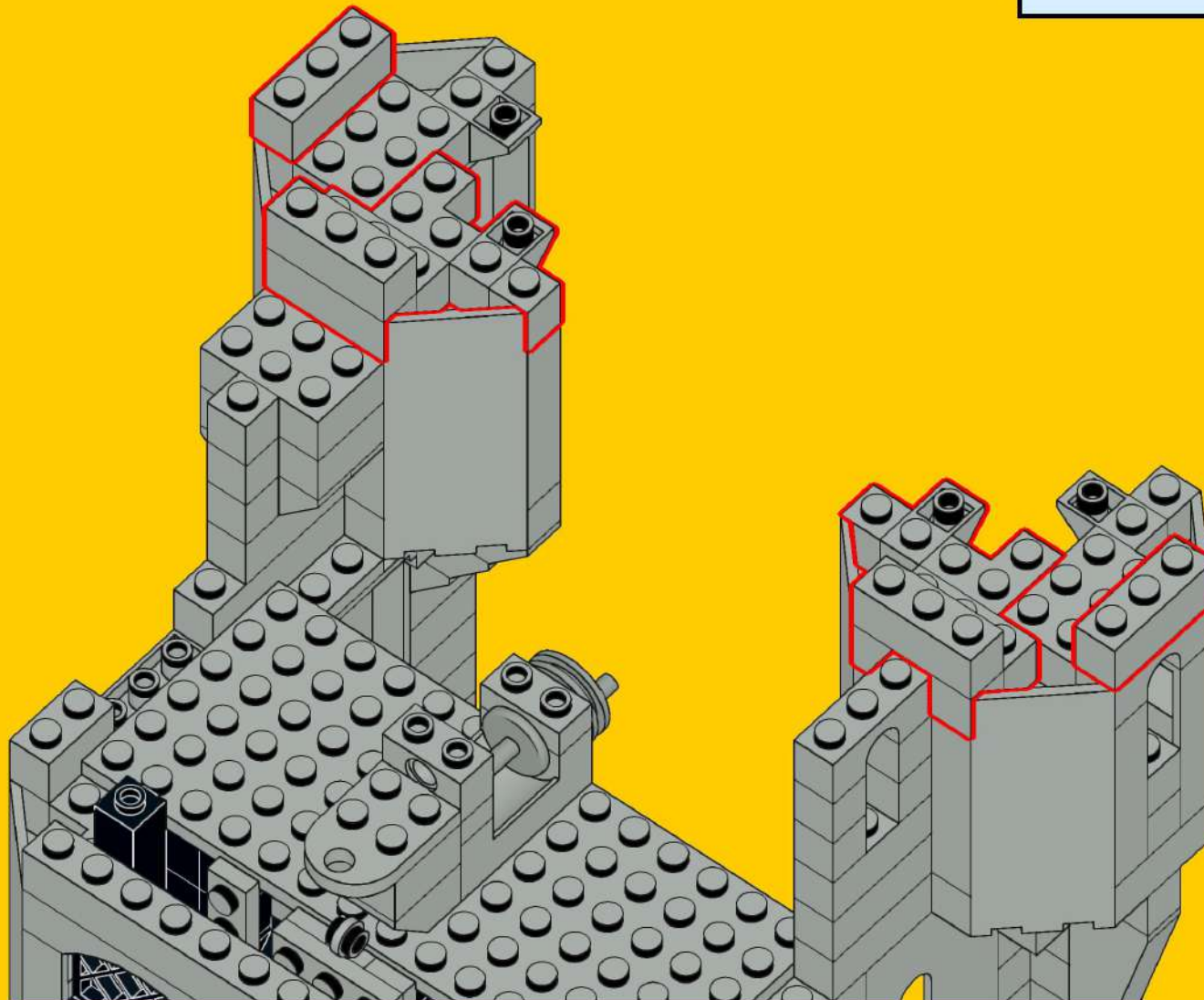
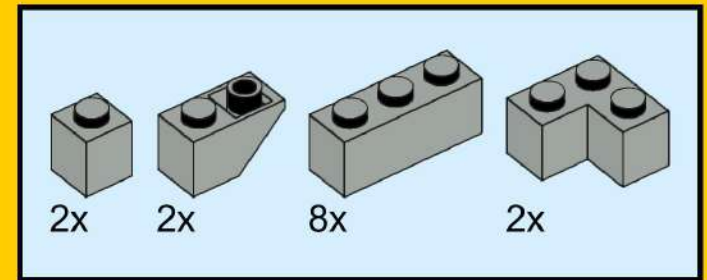

# 54

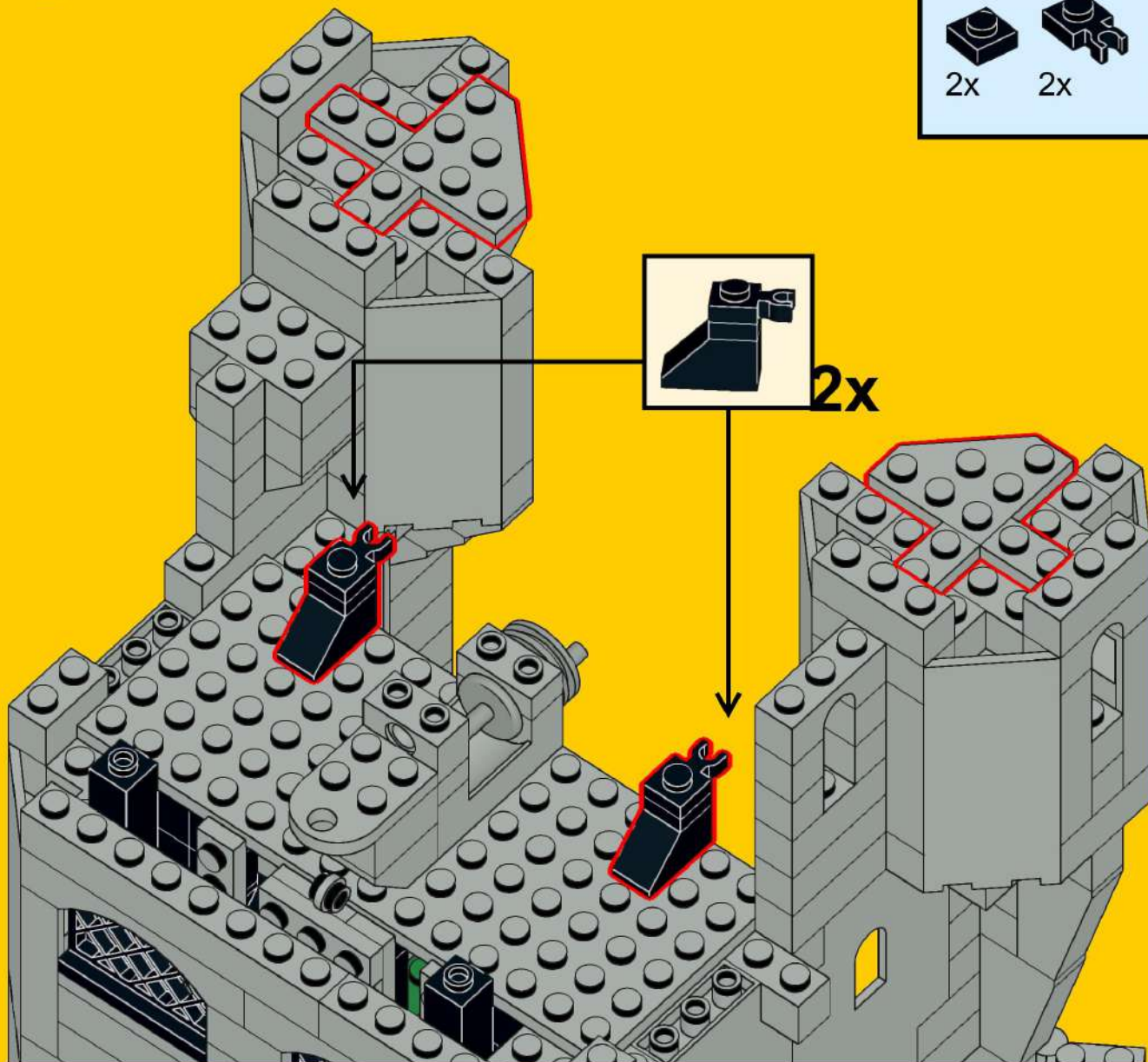
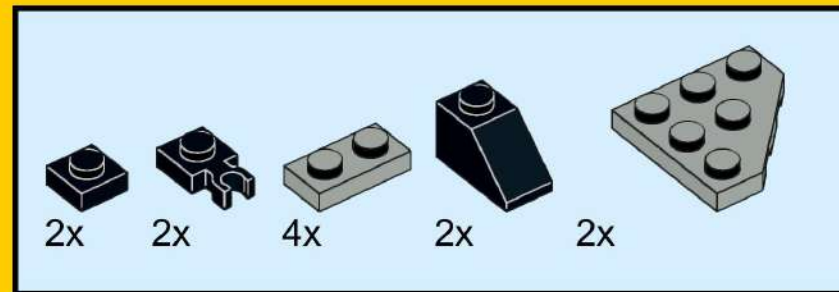

# 55

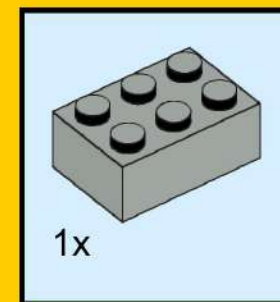
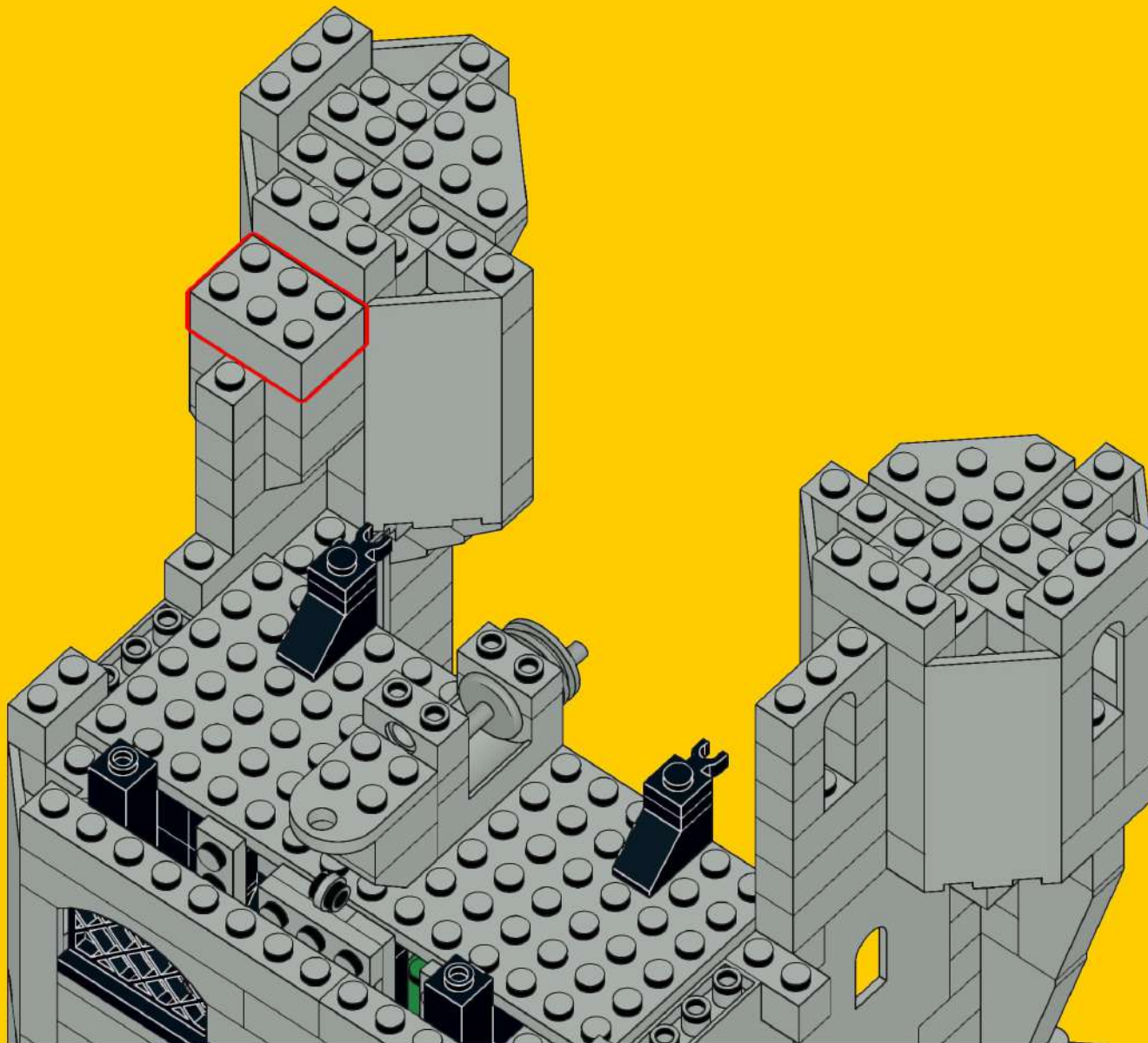

# 56

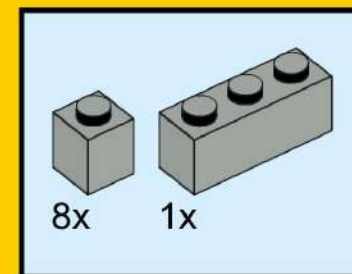
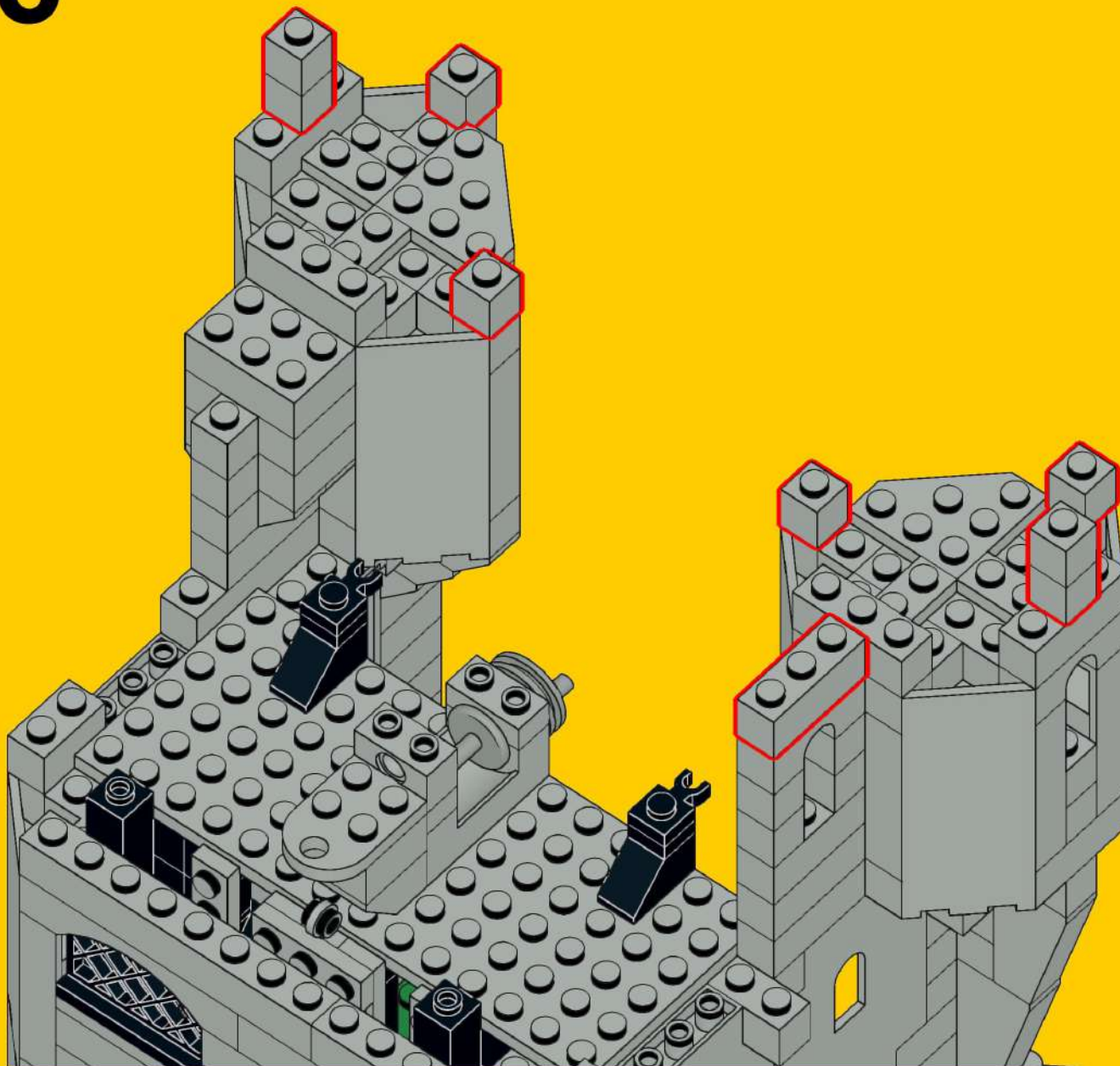

# 57

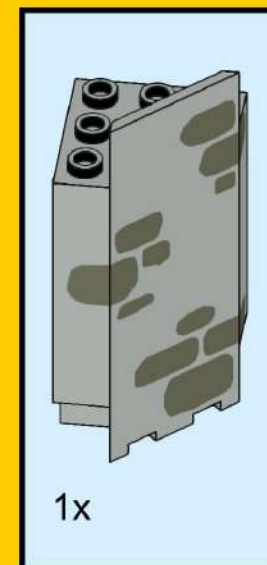
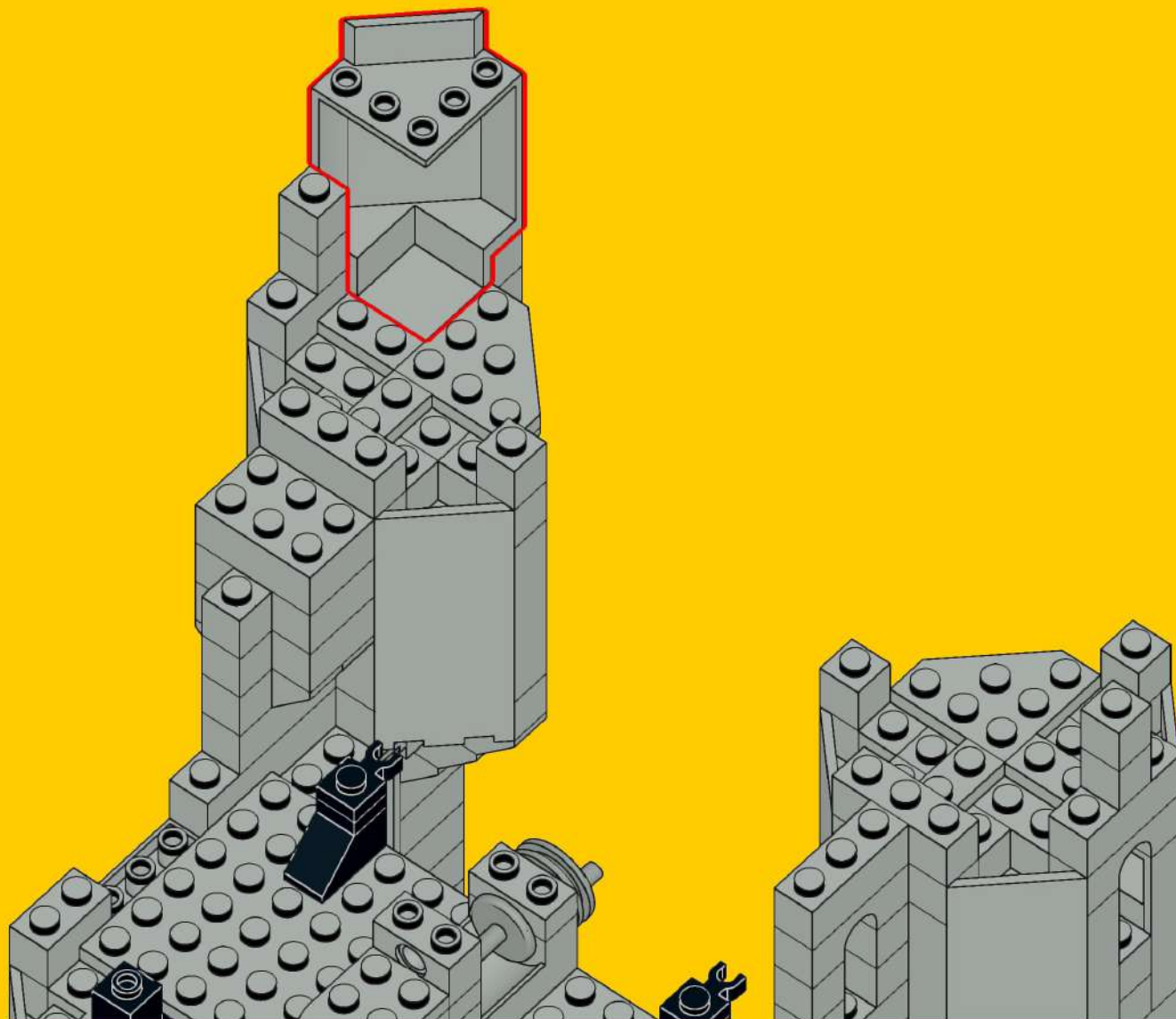



# 58

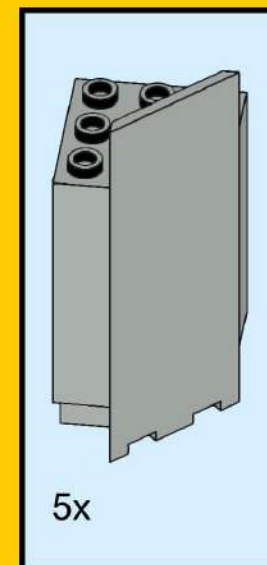
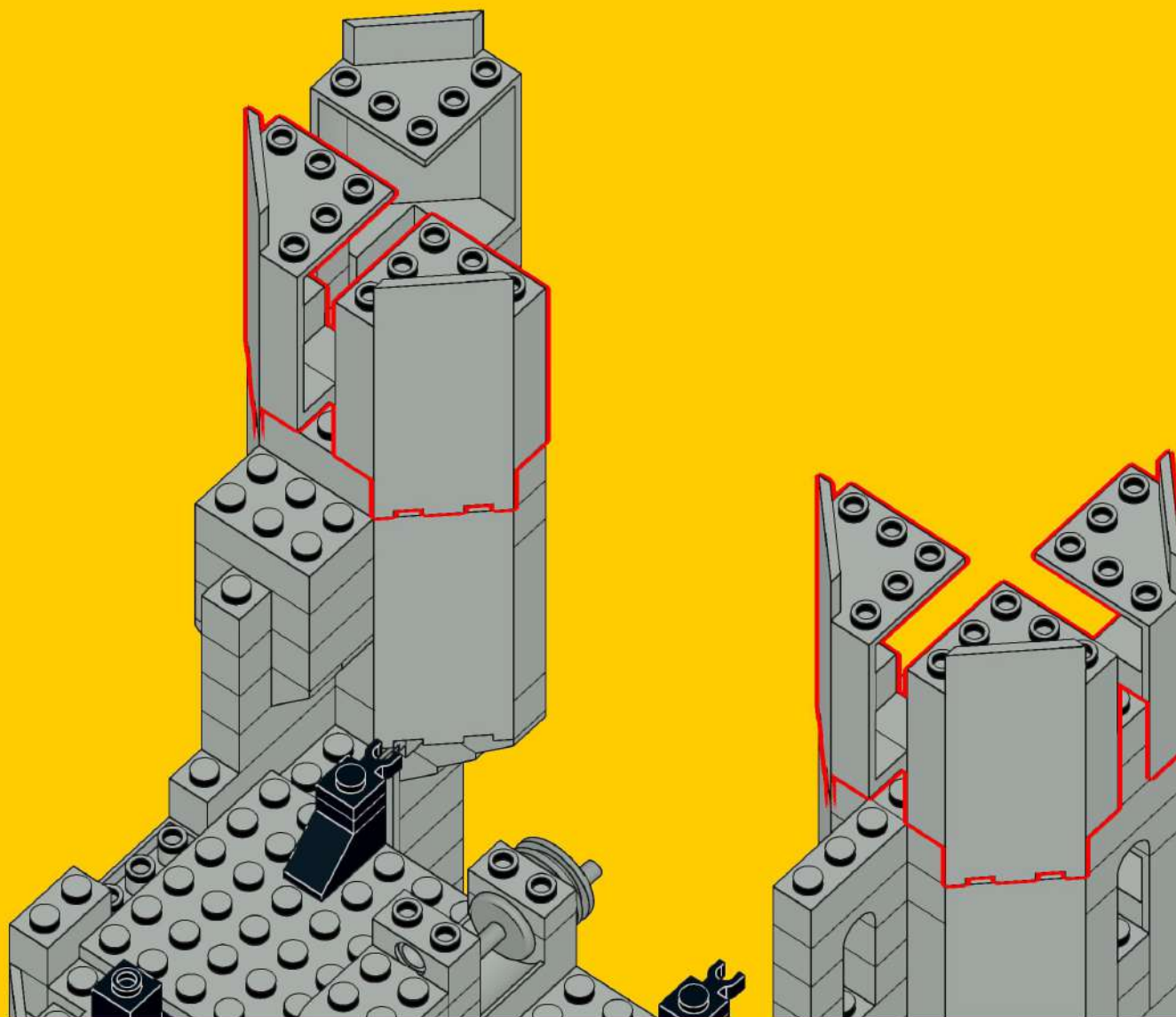

# 59

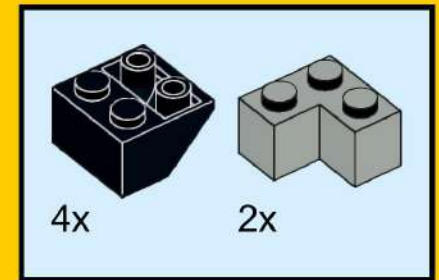
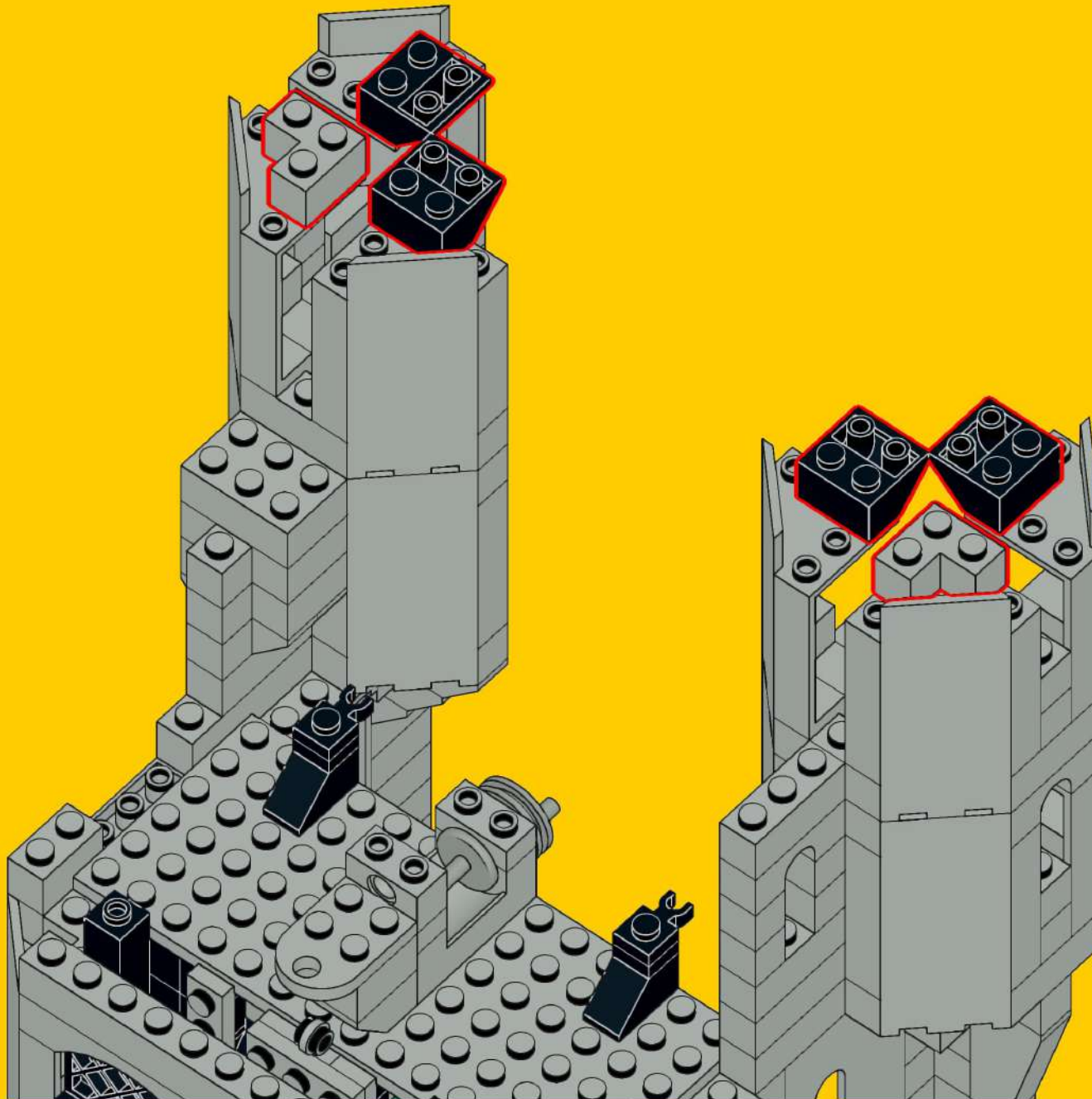

# 60

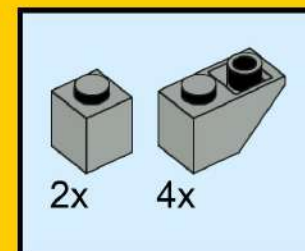
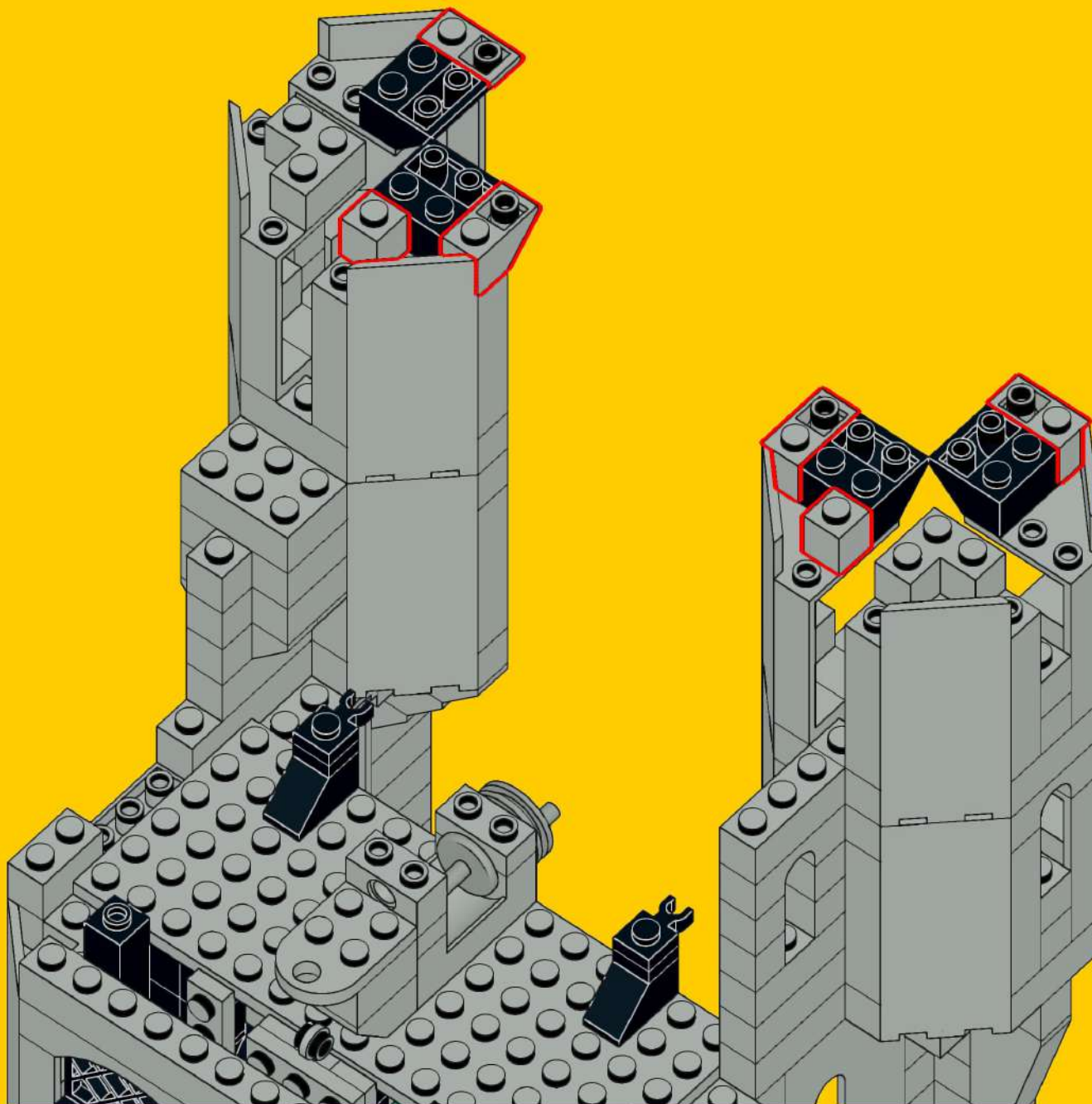

# 61

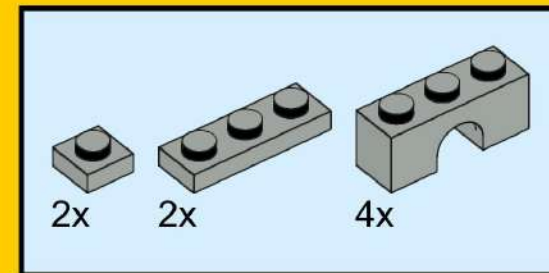
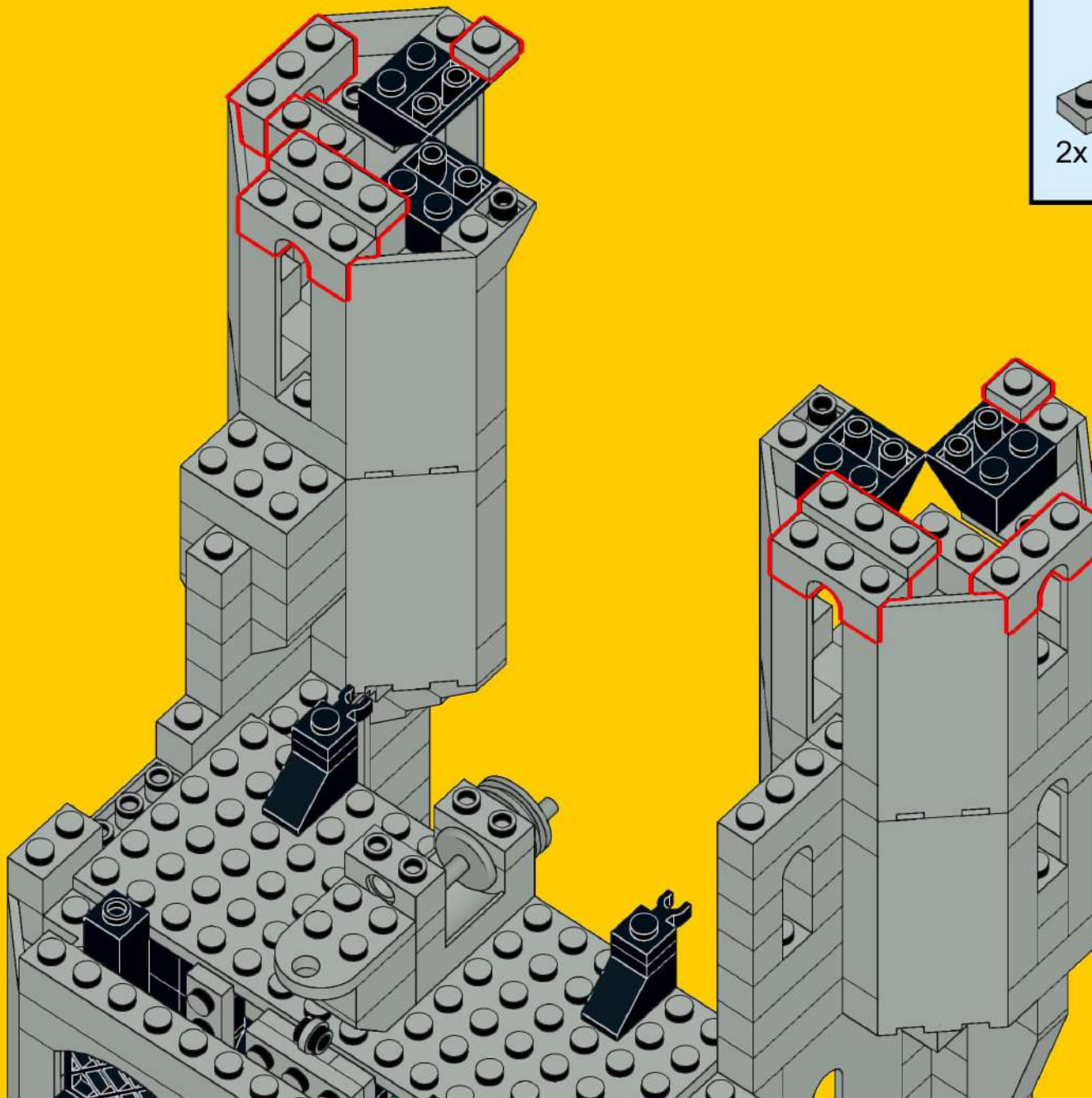

# 62

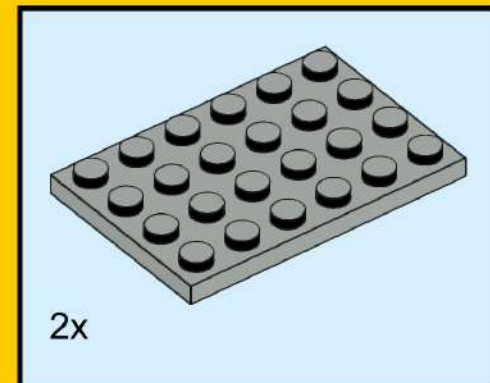
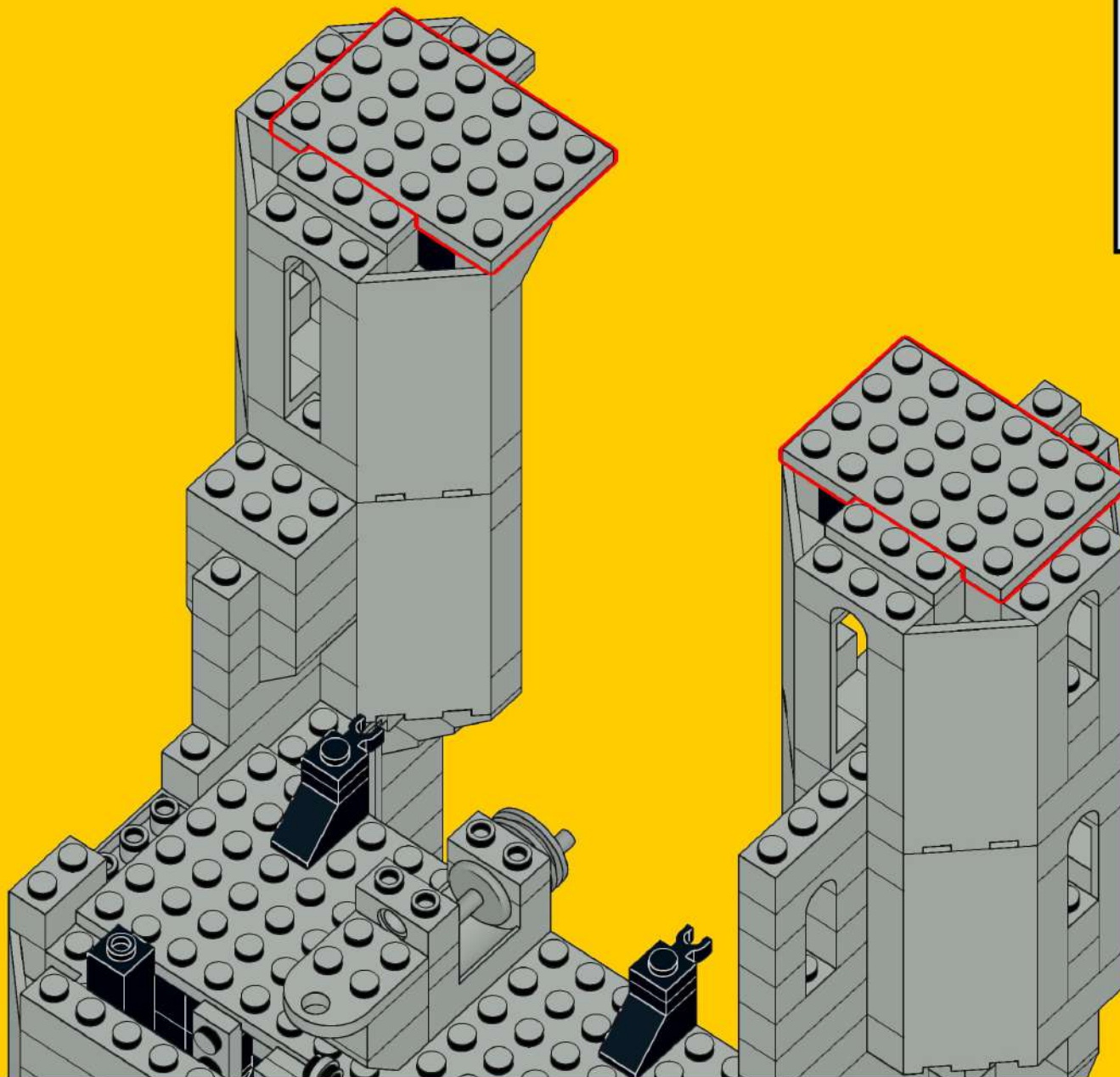

# 63

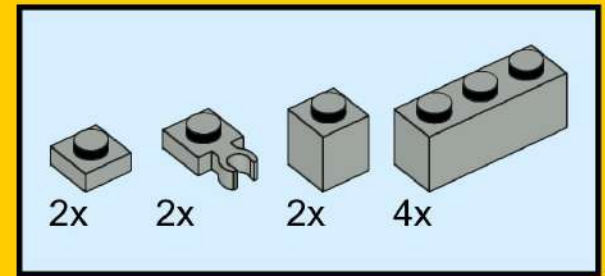
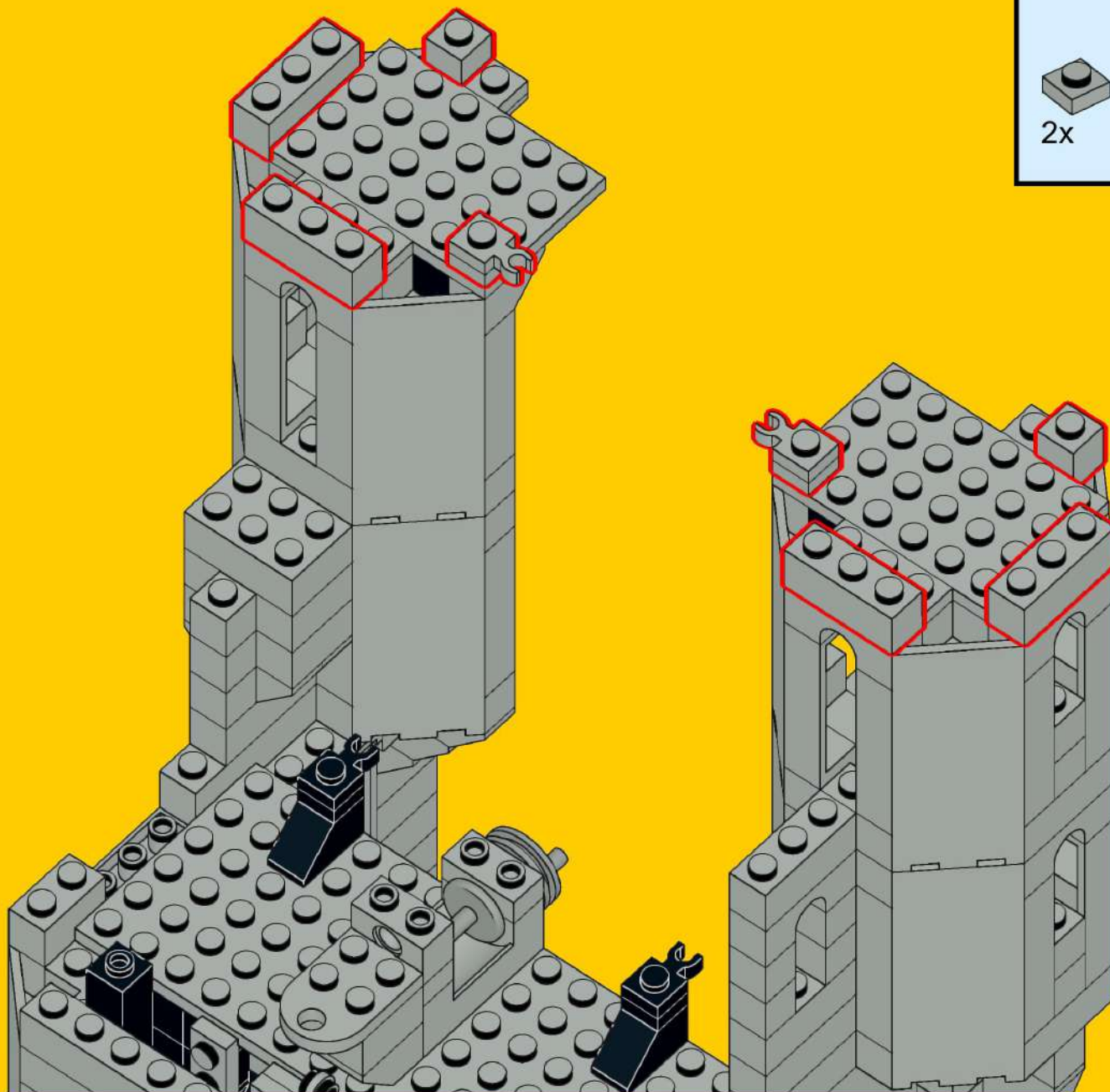

# 64

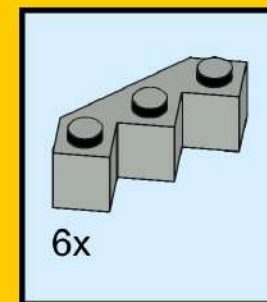
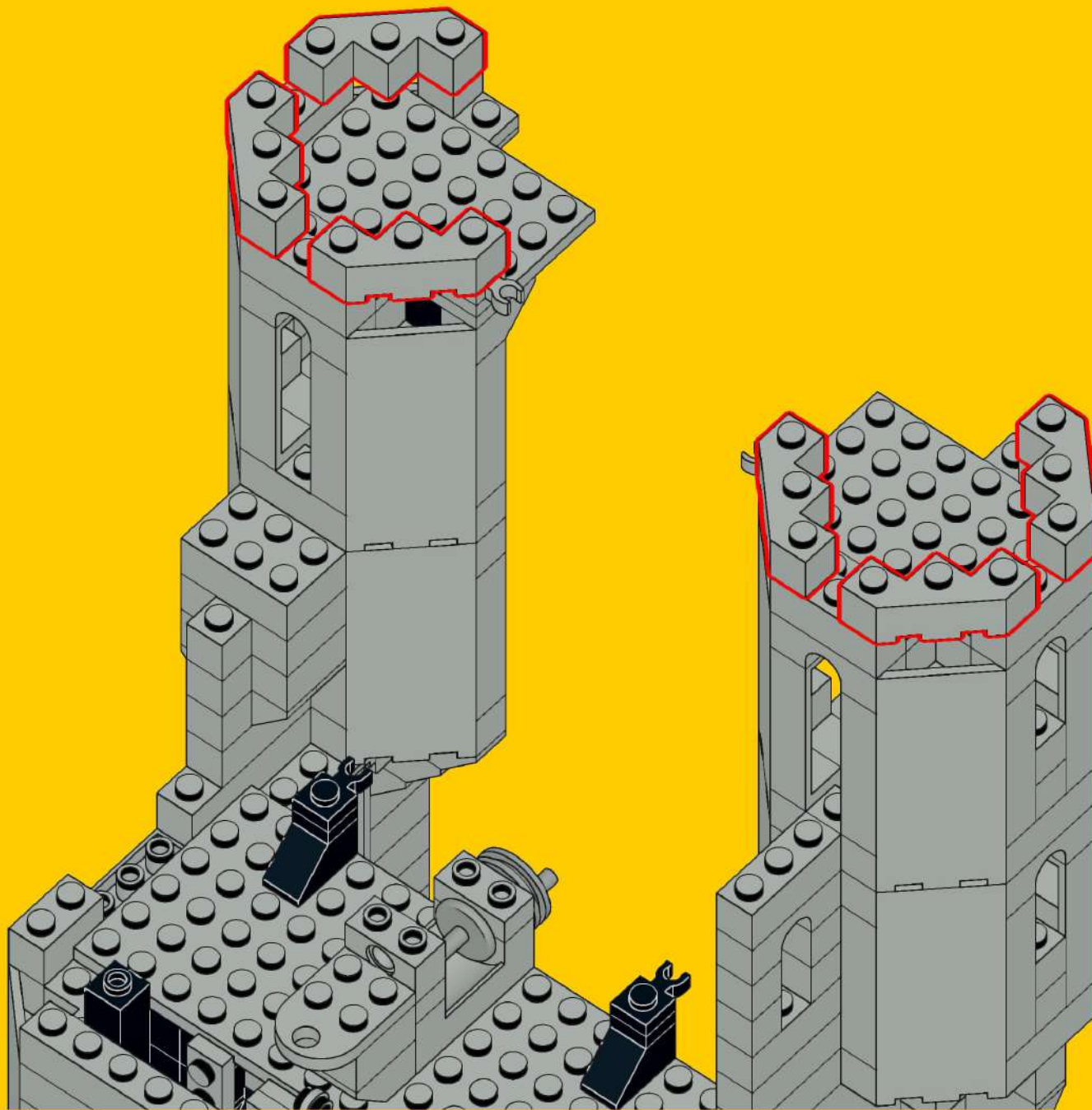

# 65

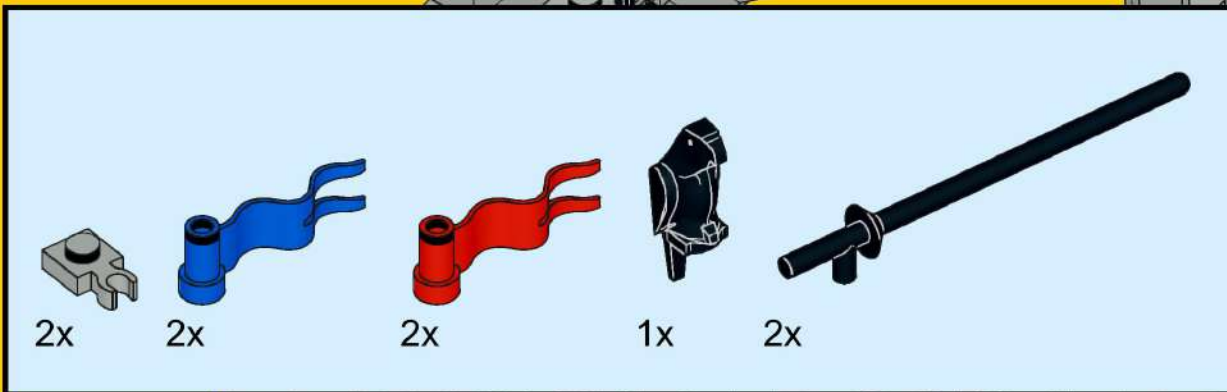
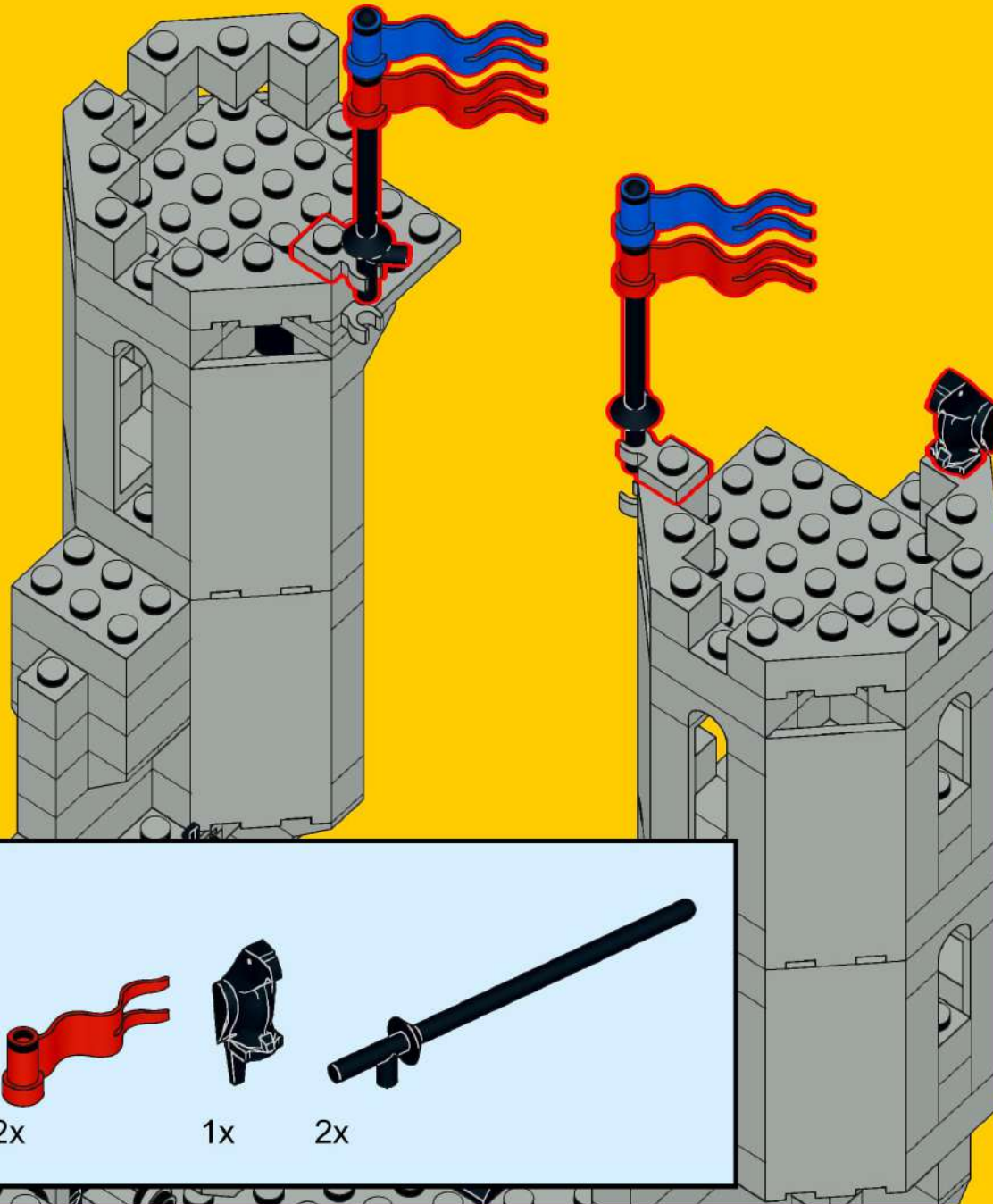



# 66

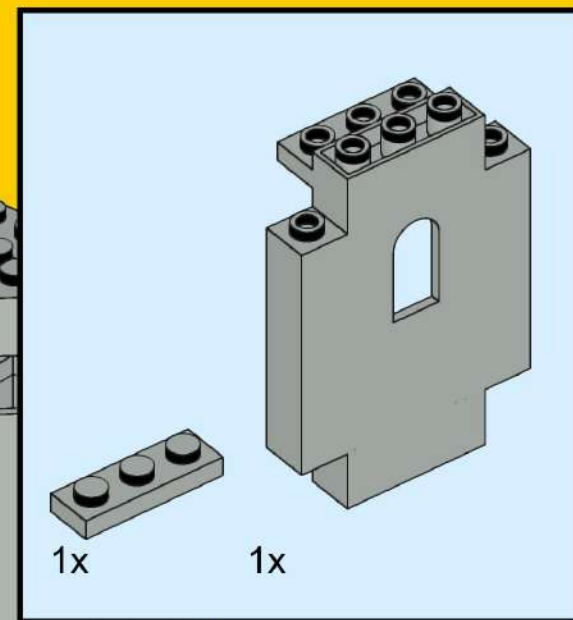
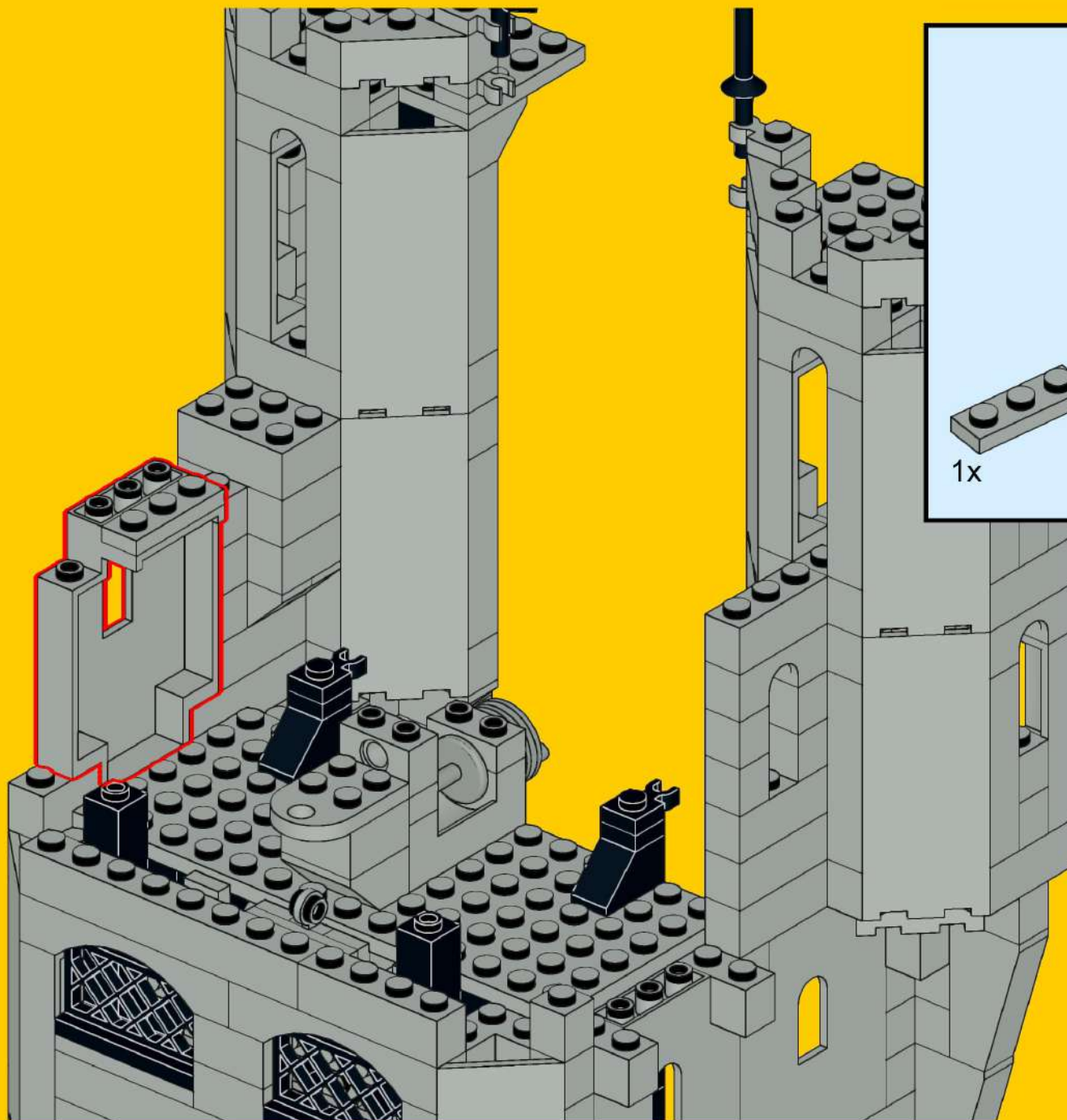

67

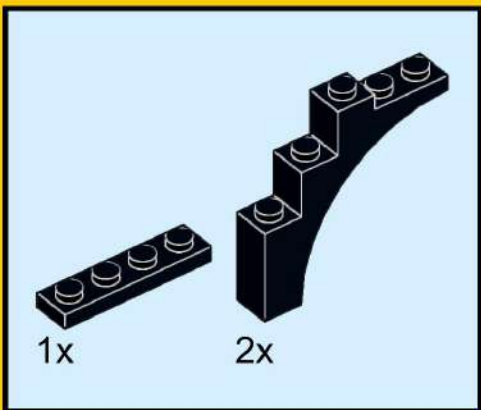
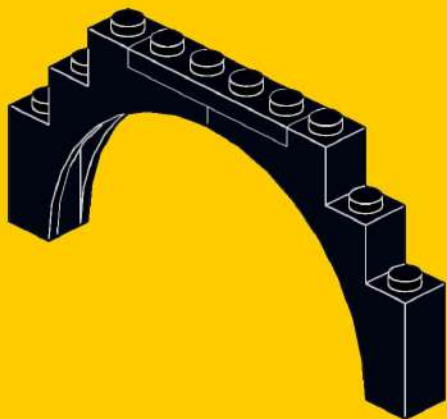
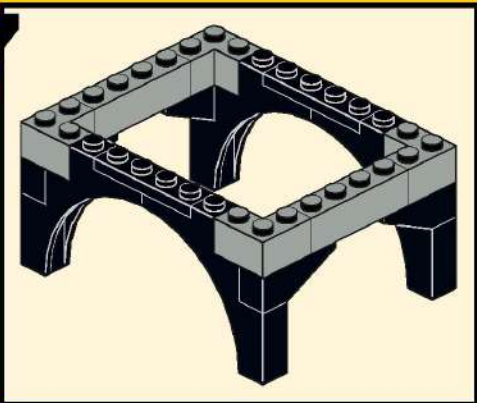

68

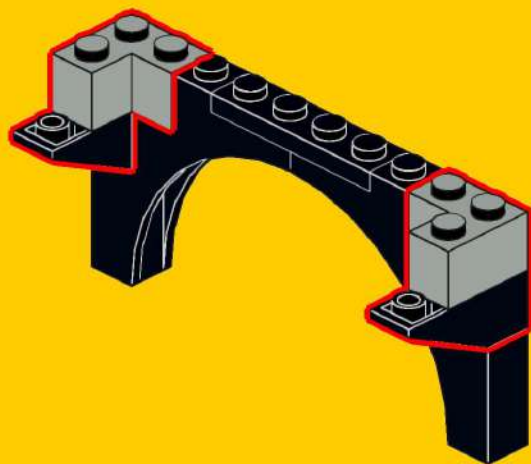
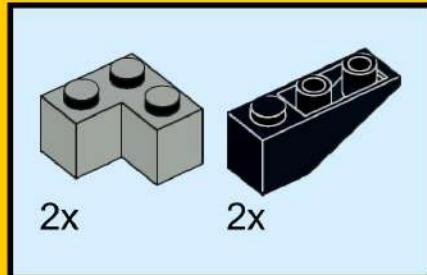

69

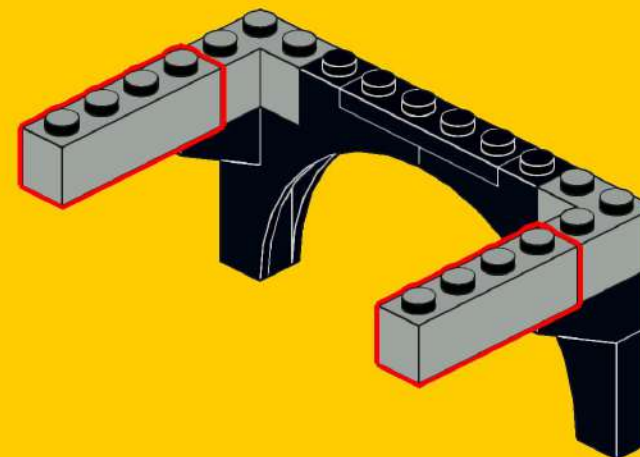
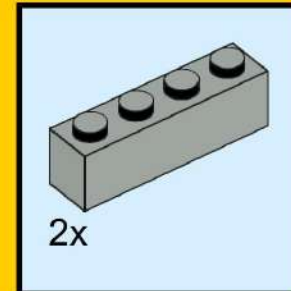

# 70

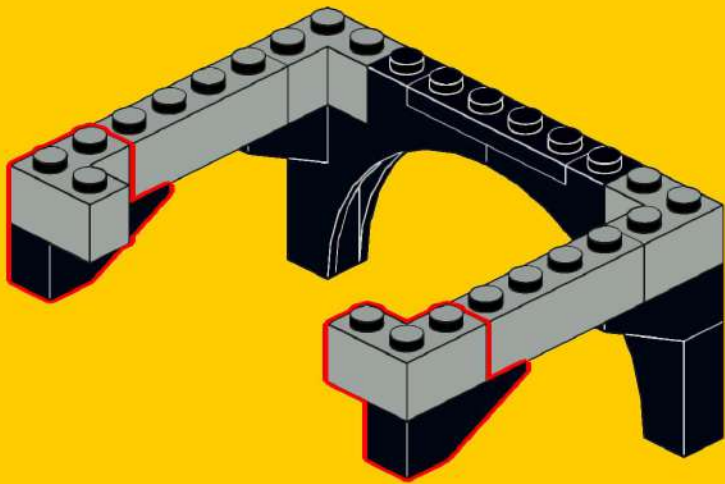
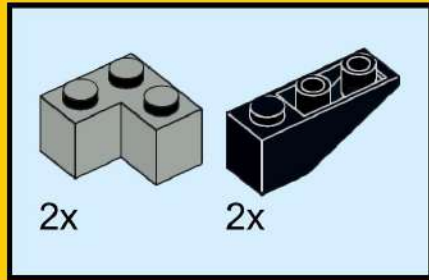

# 71

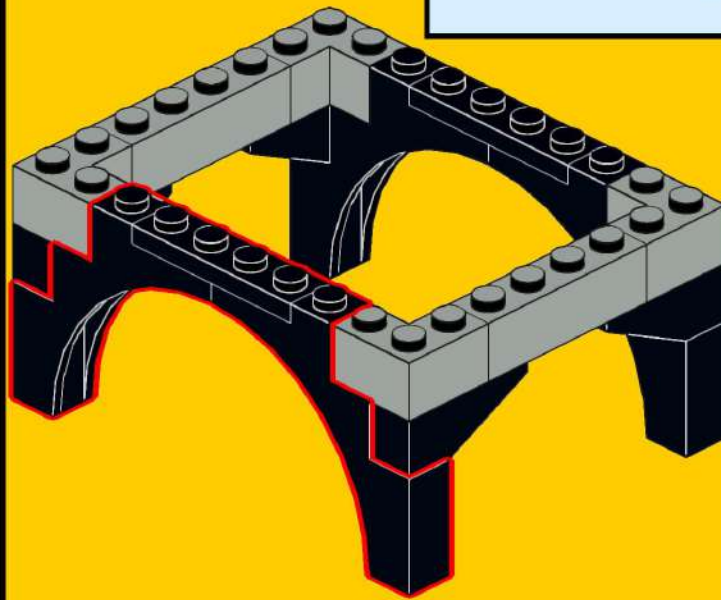
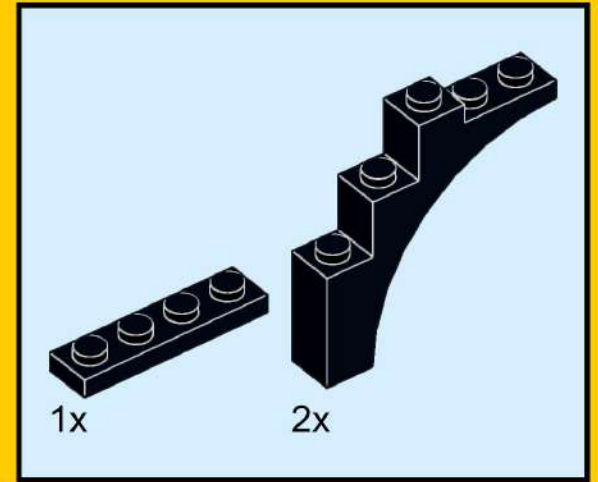

# 72

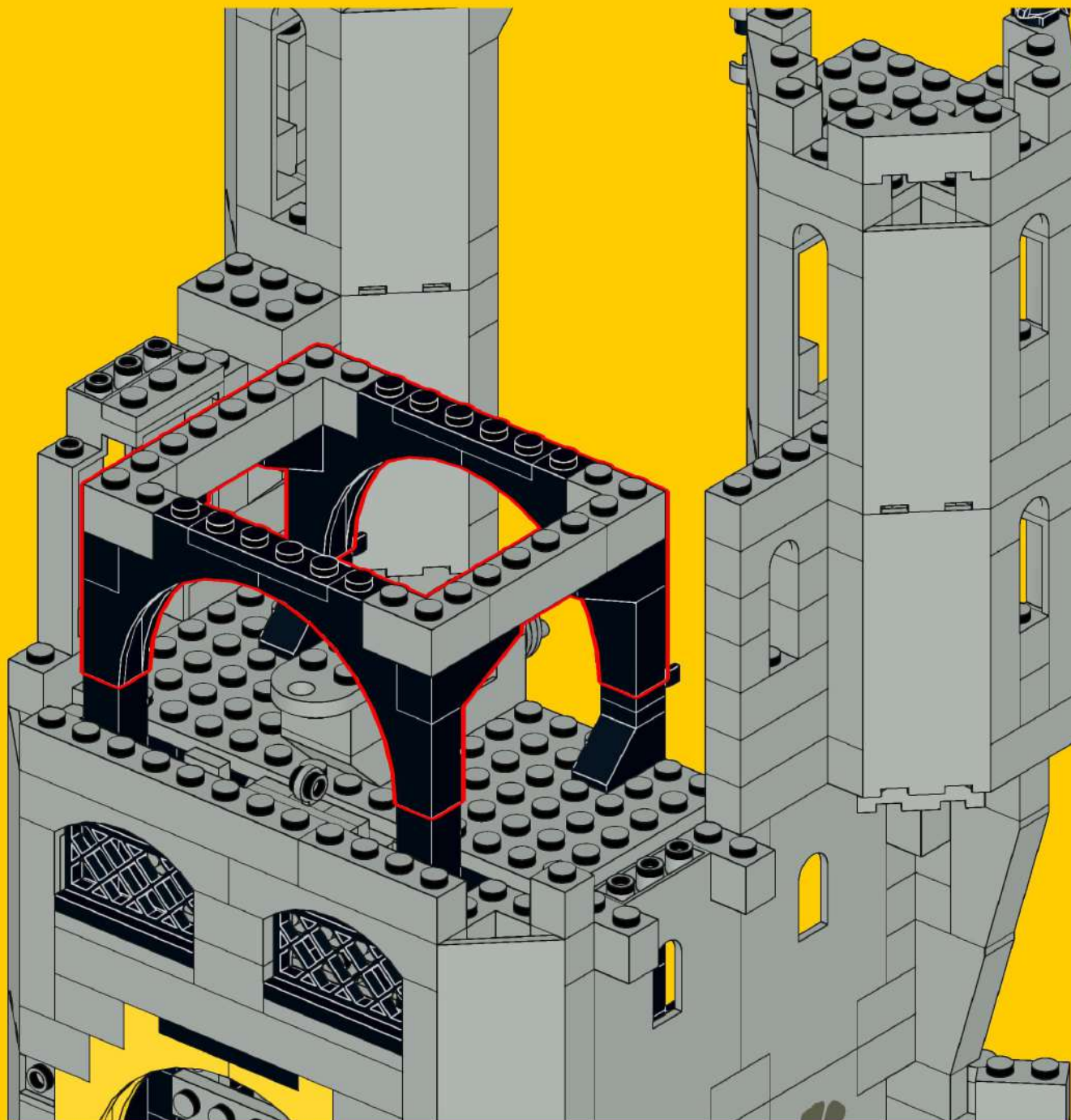

# 73

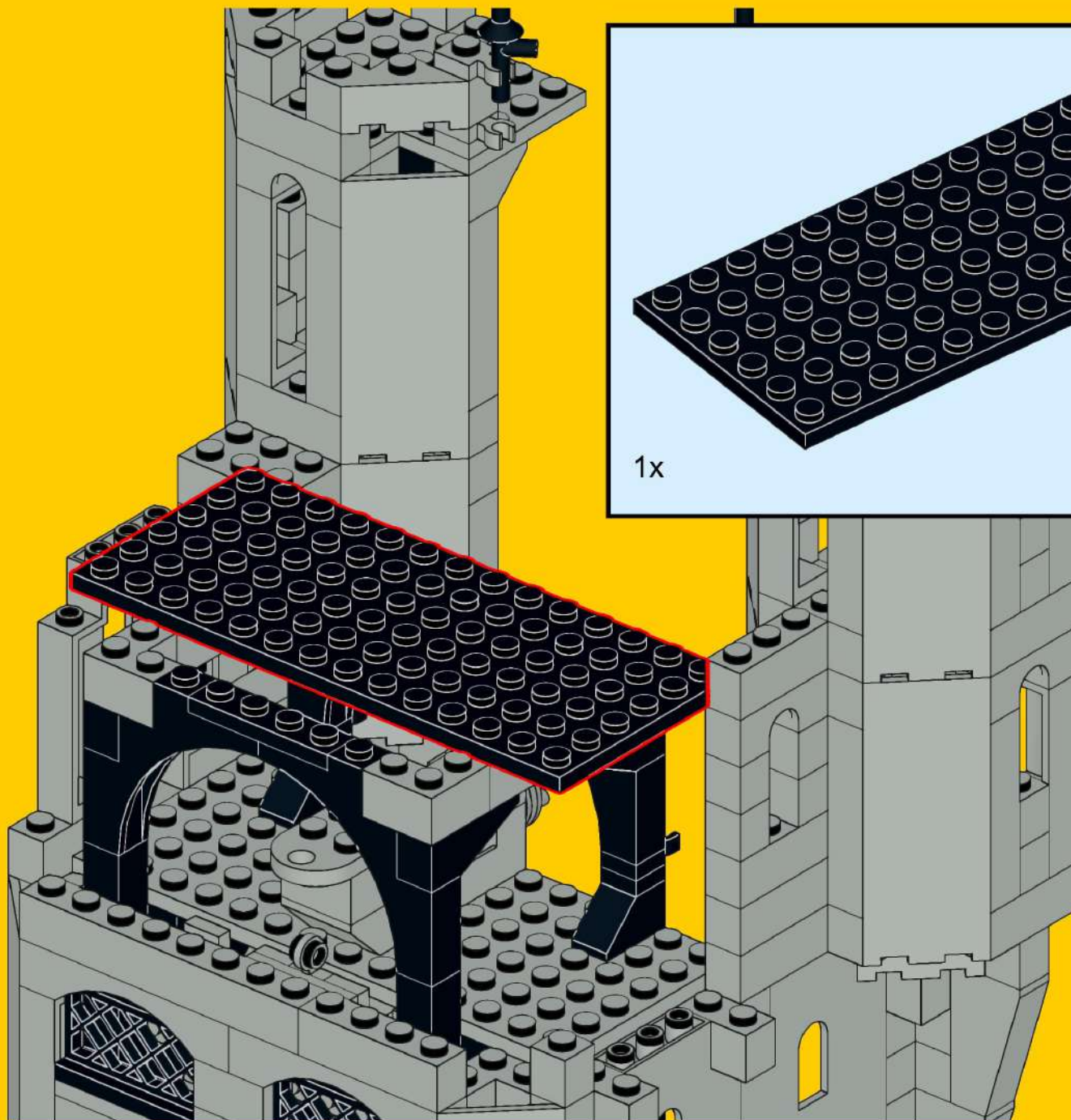

74

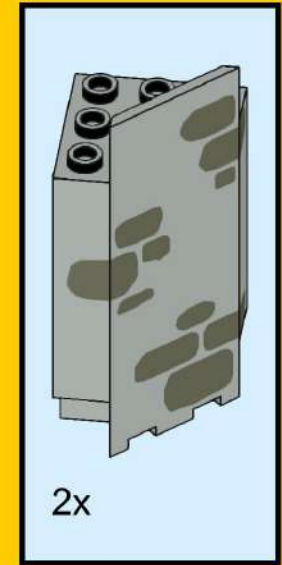
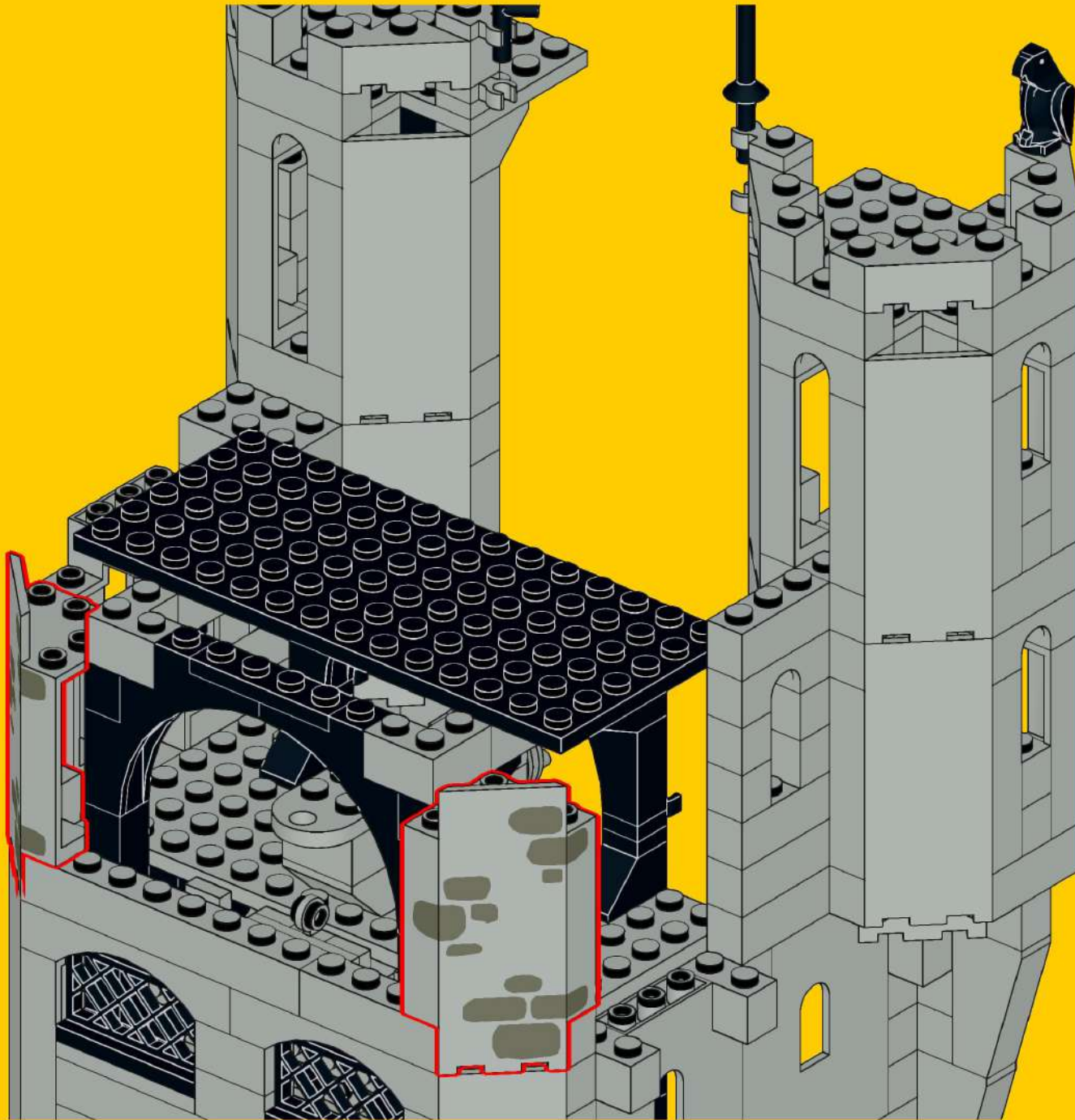

# 75

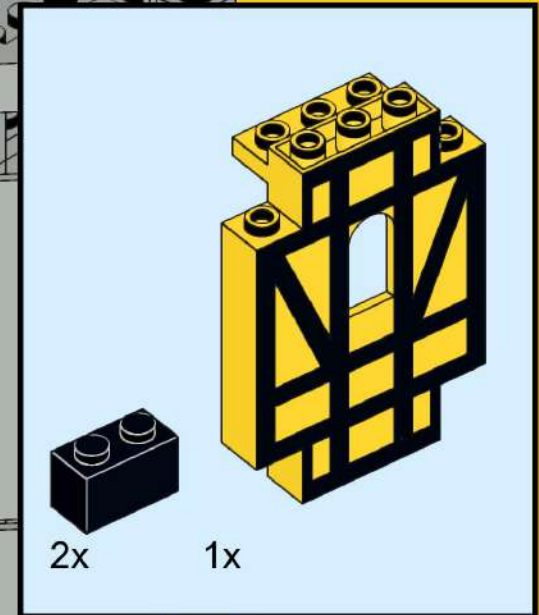
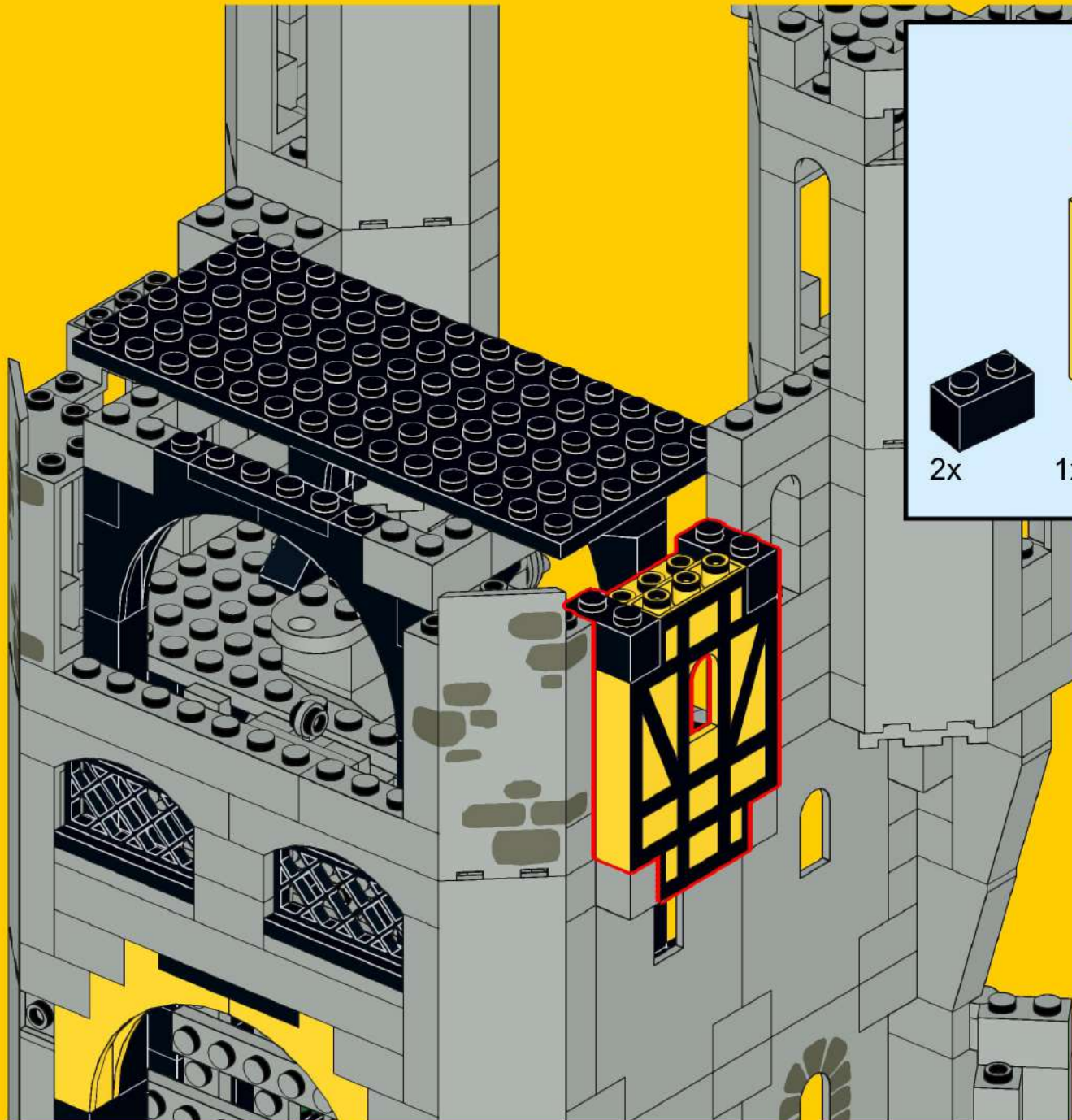

# 76

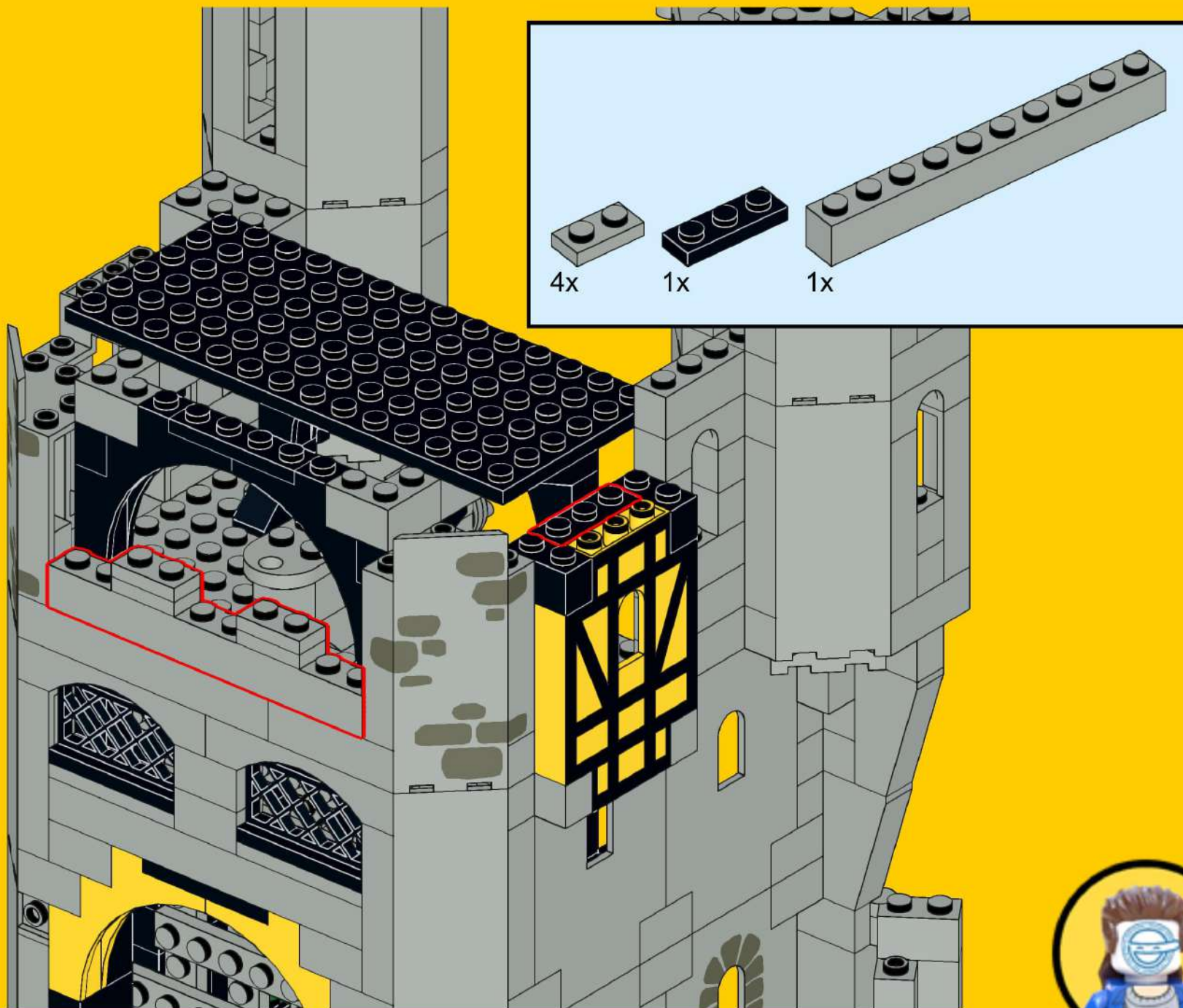





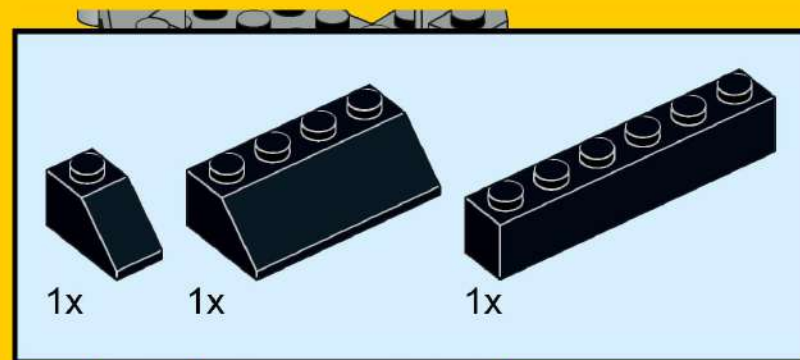
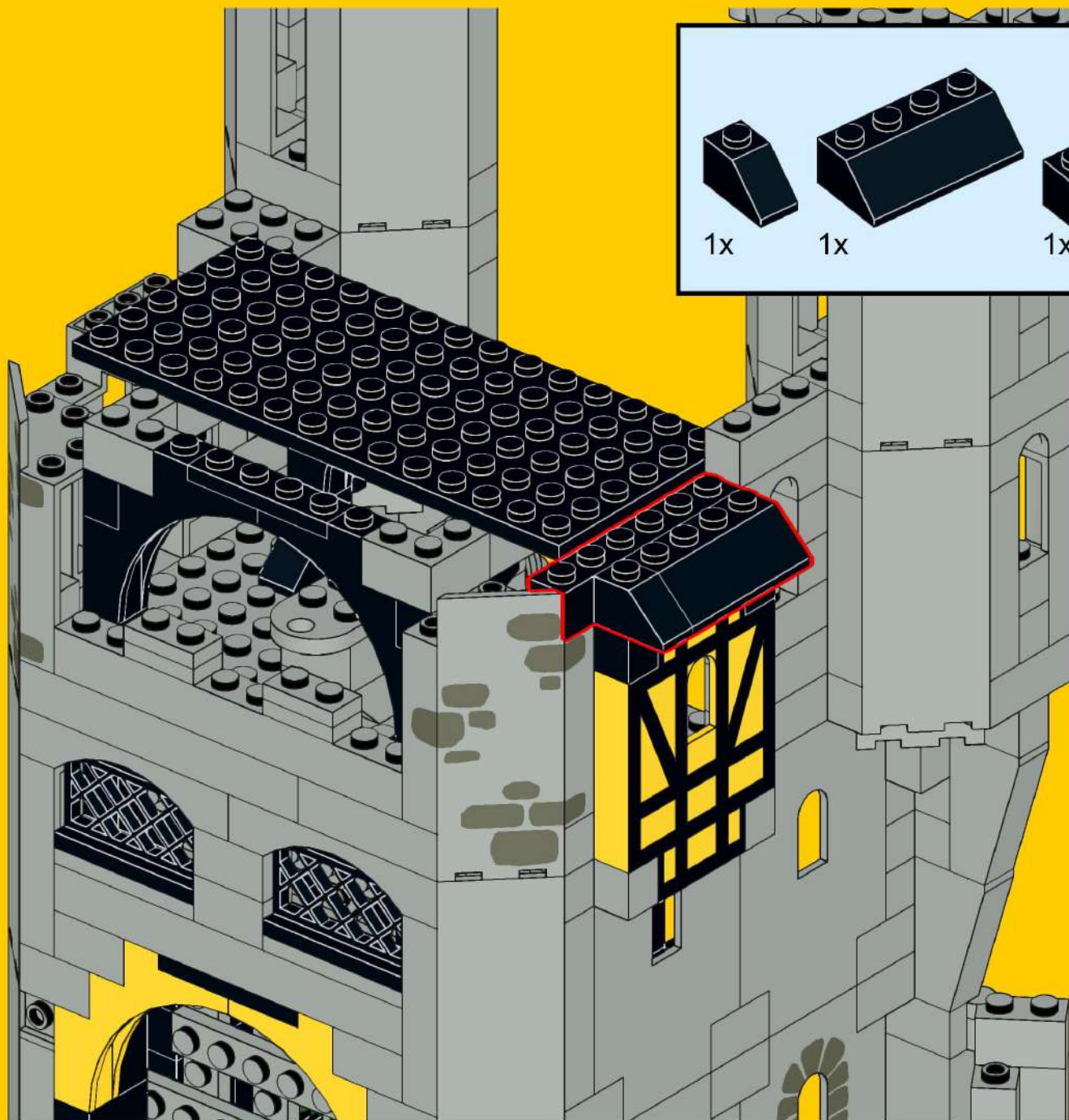

# 77

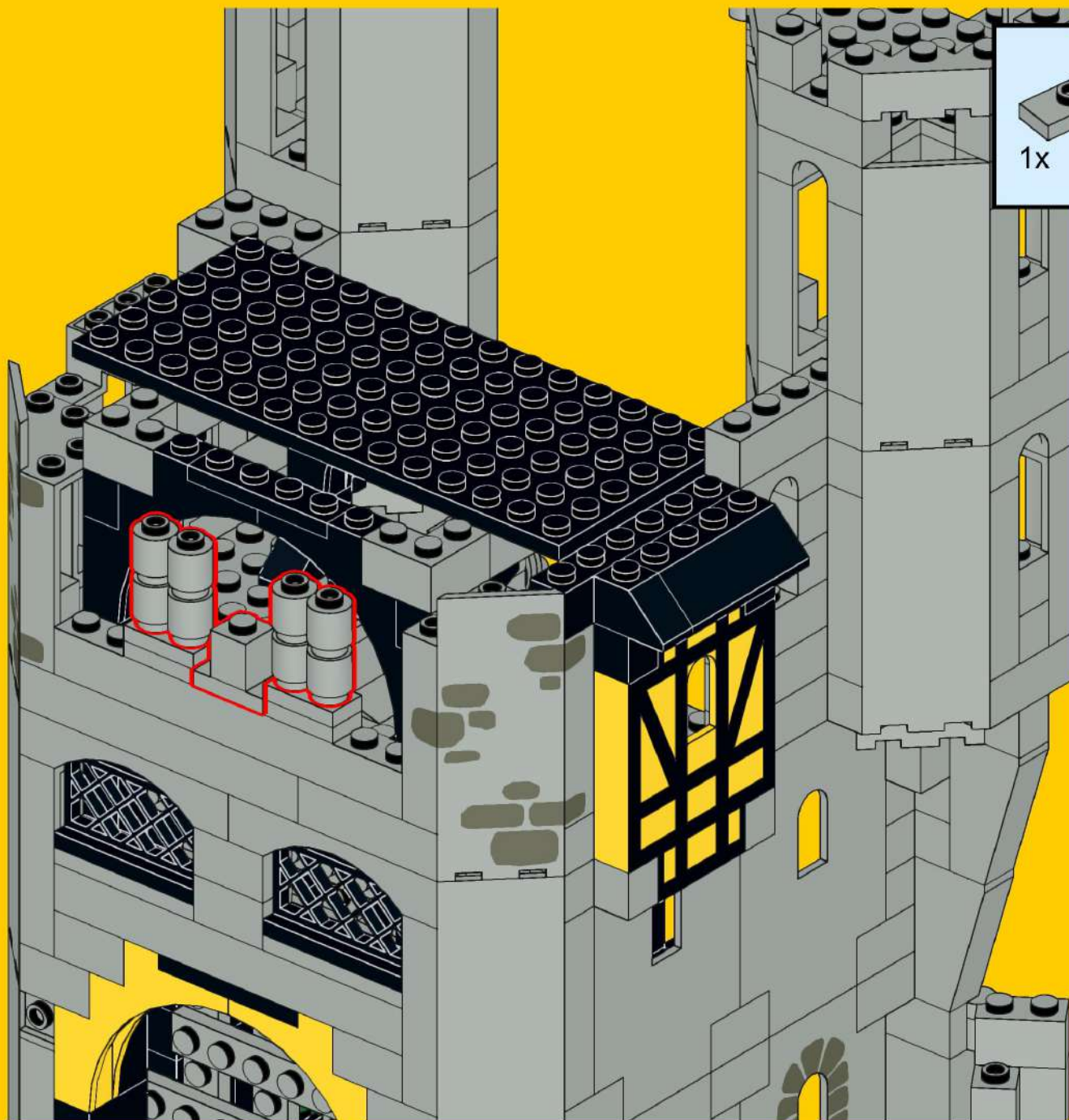

# 78



		
1x	1x	8x



# 79

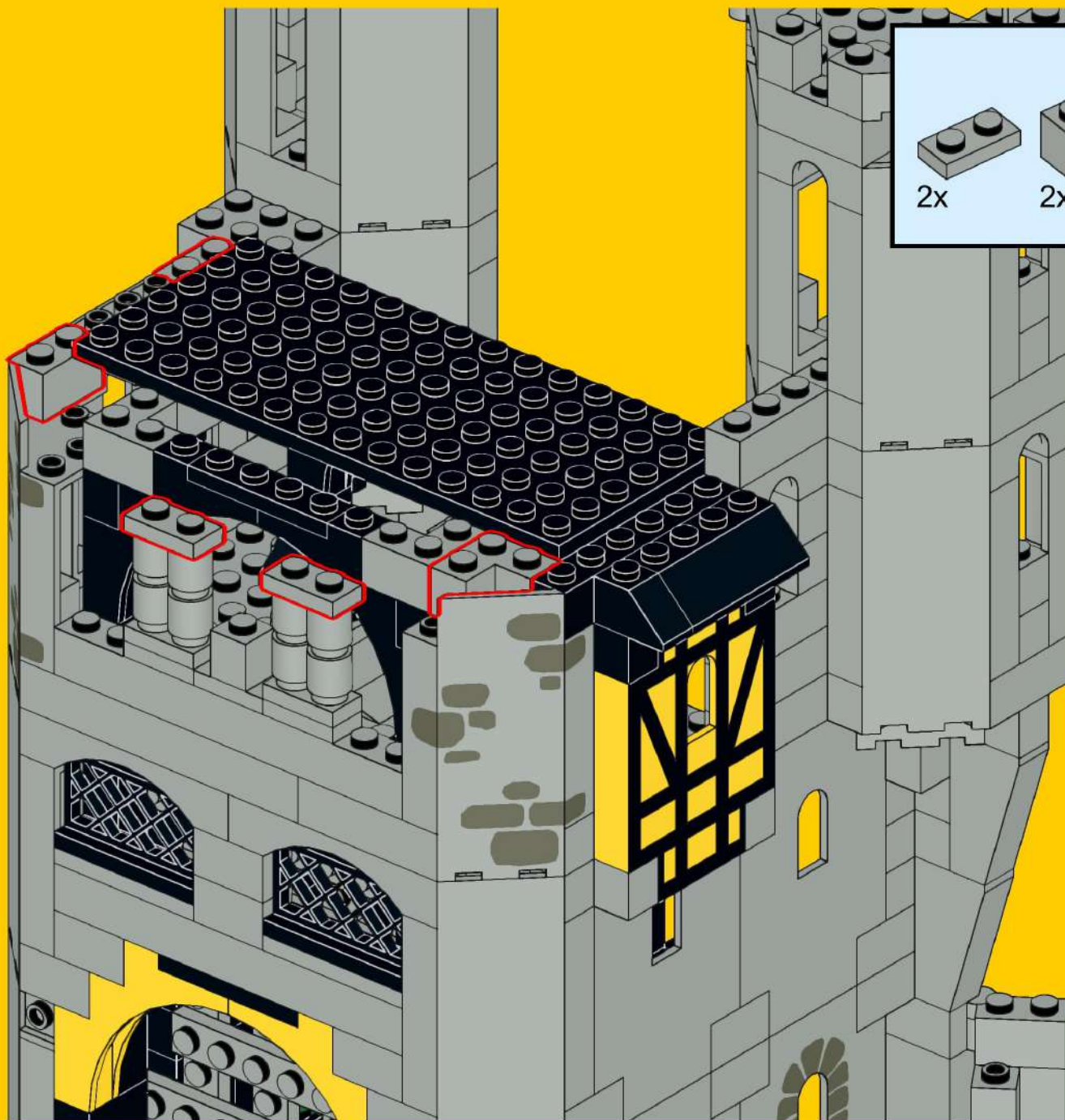

2x      2x      1x



# 80

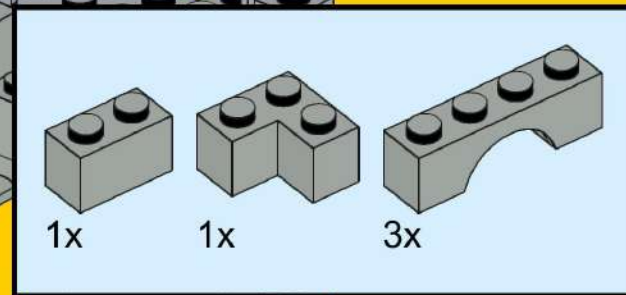
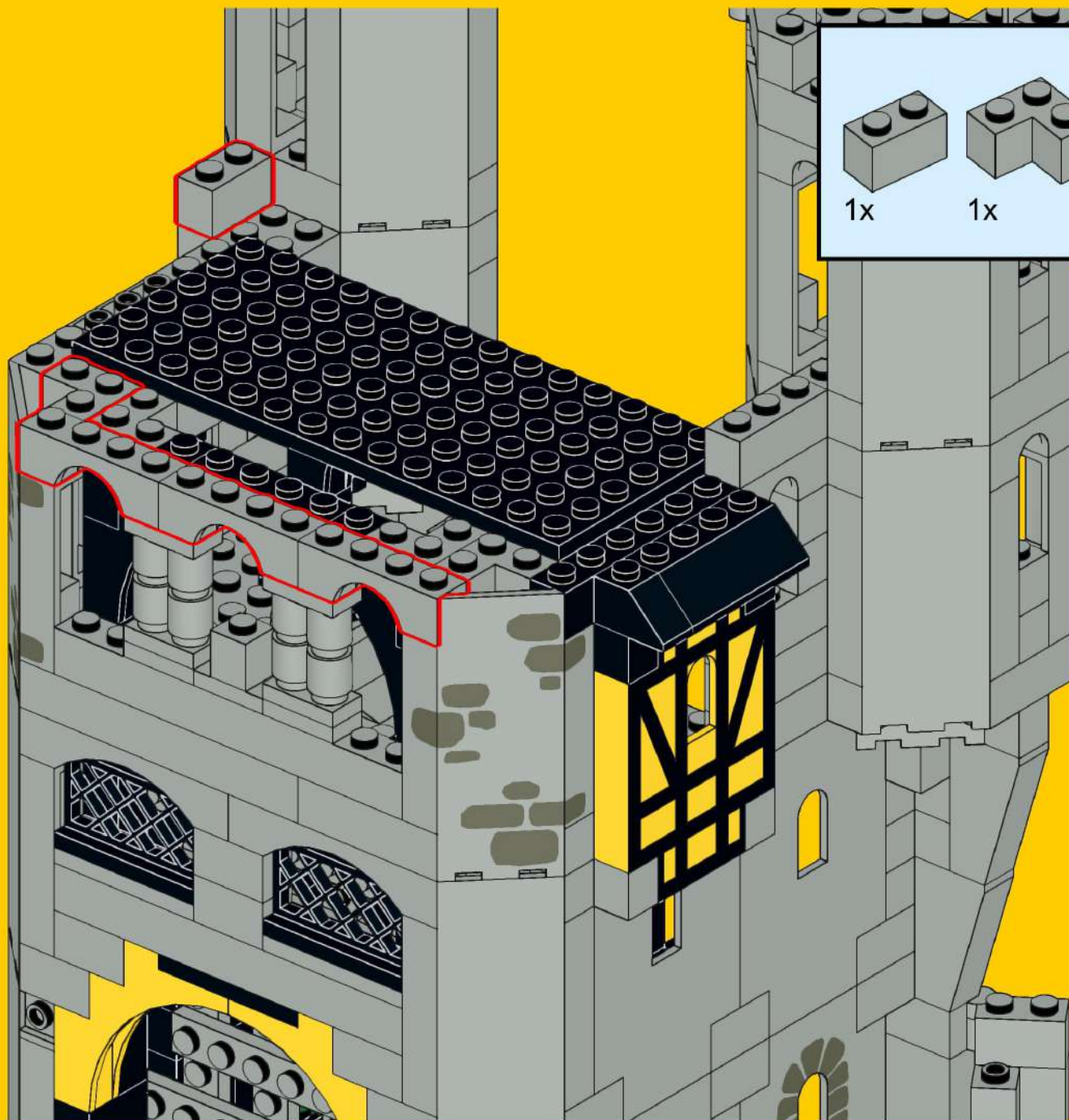

# 81

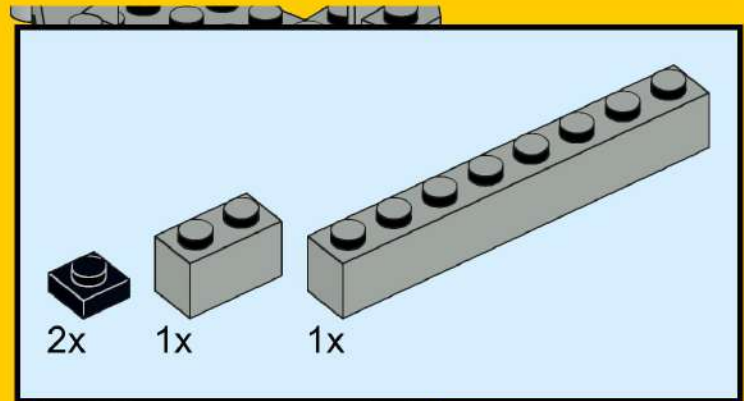
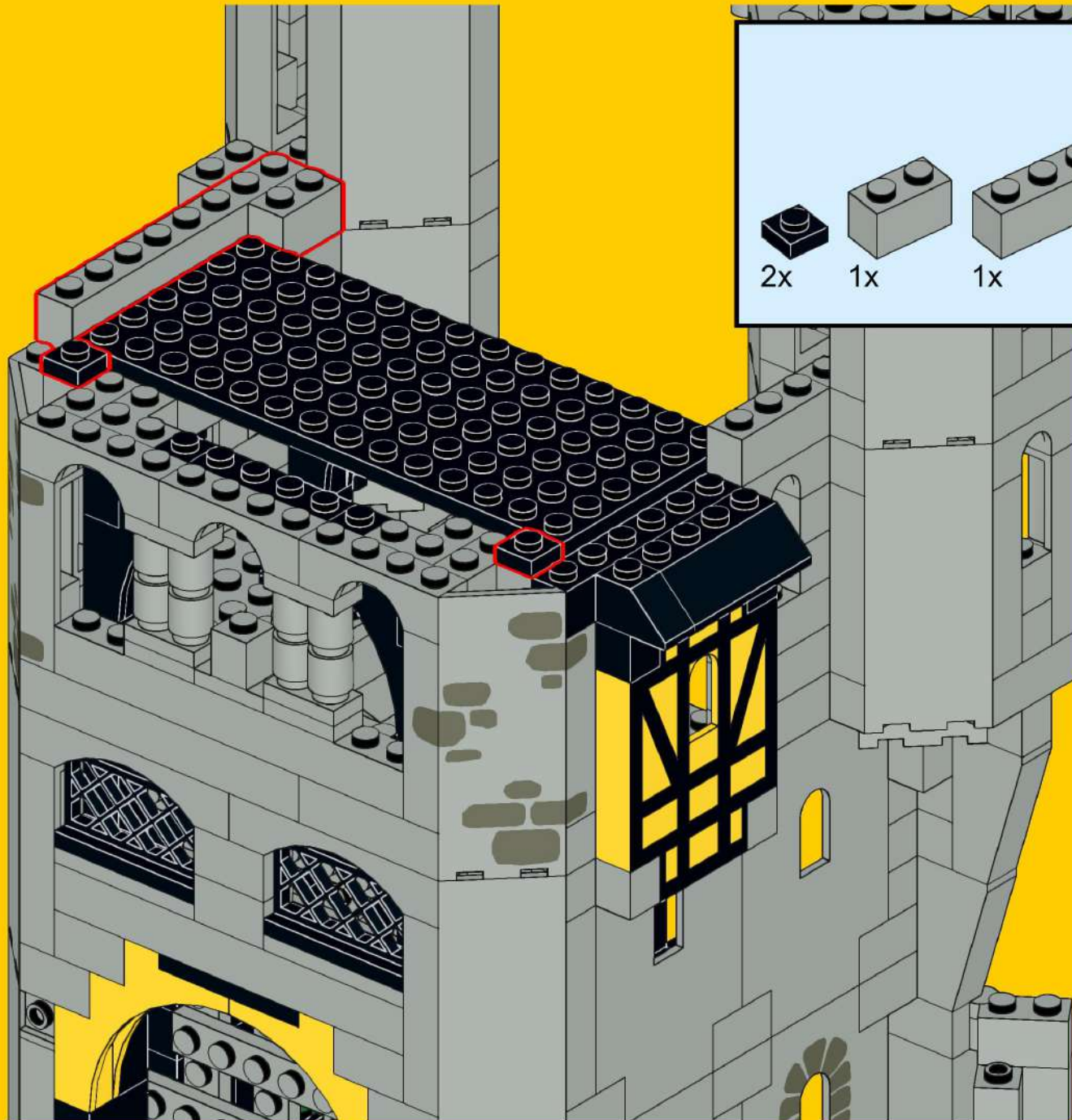

# 82

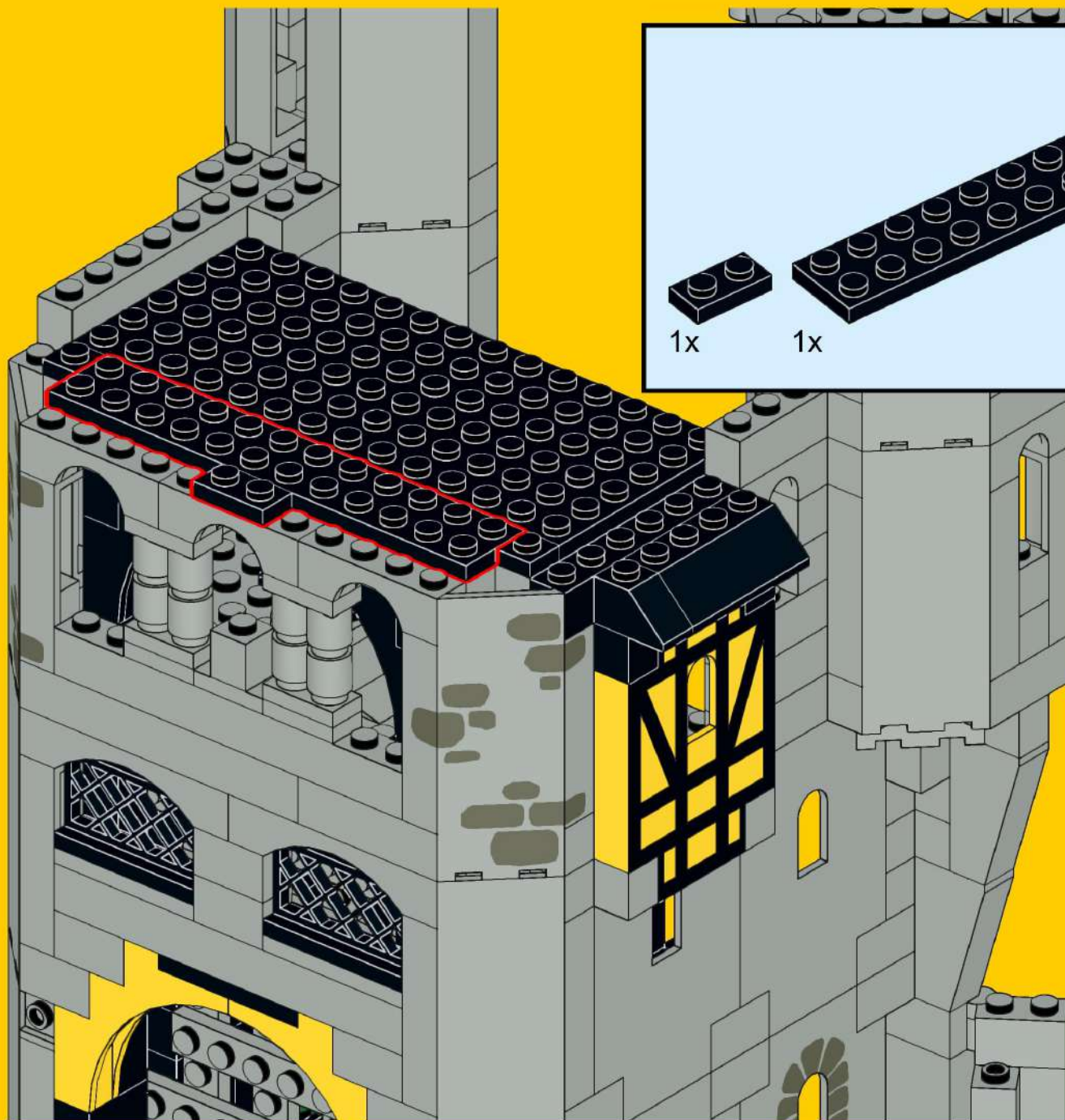

# 83

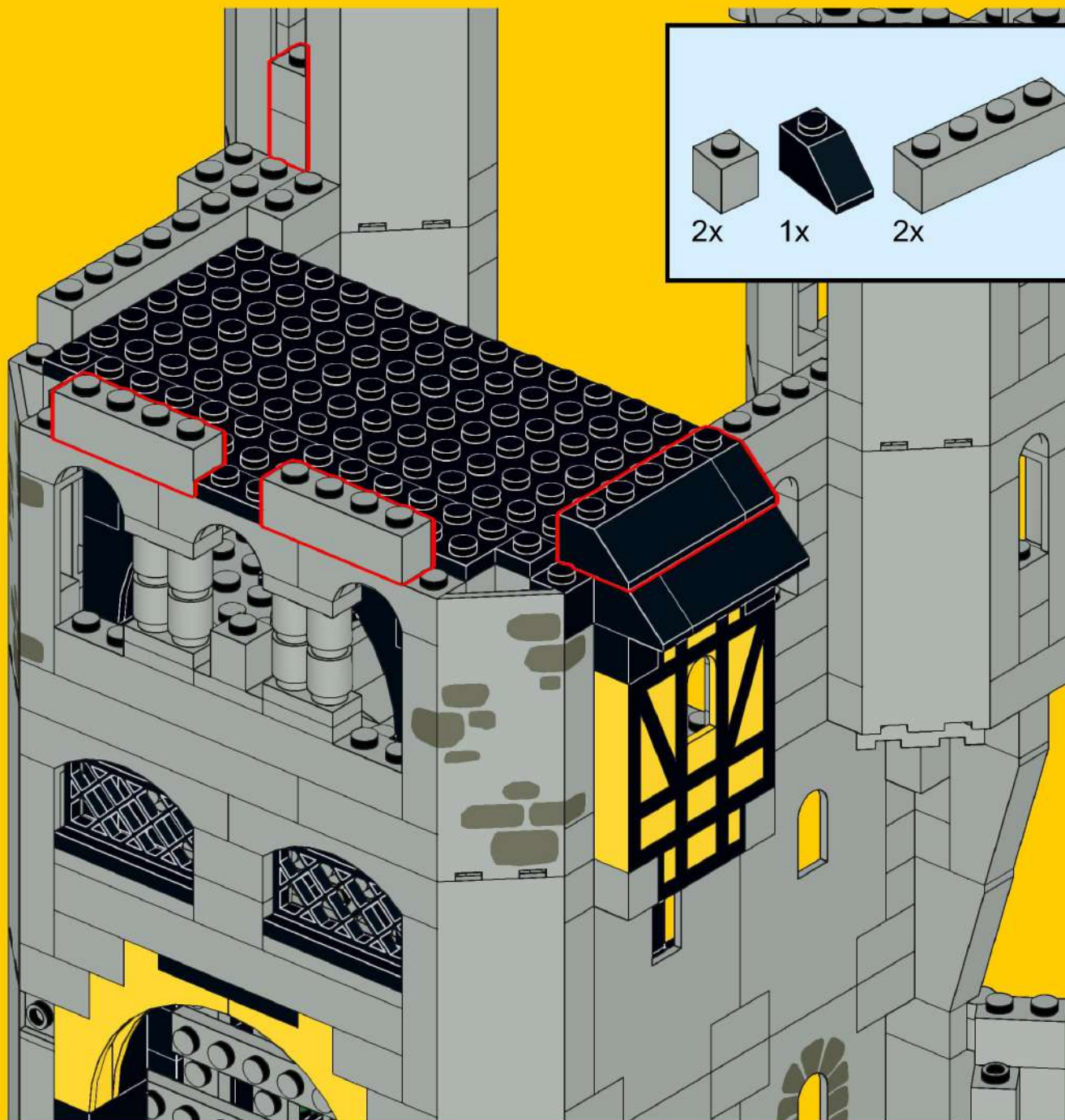

# 84

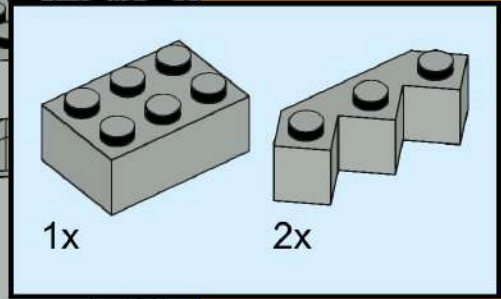
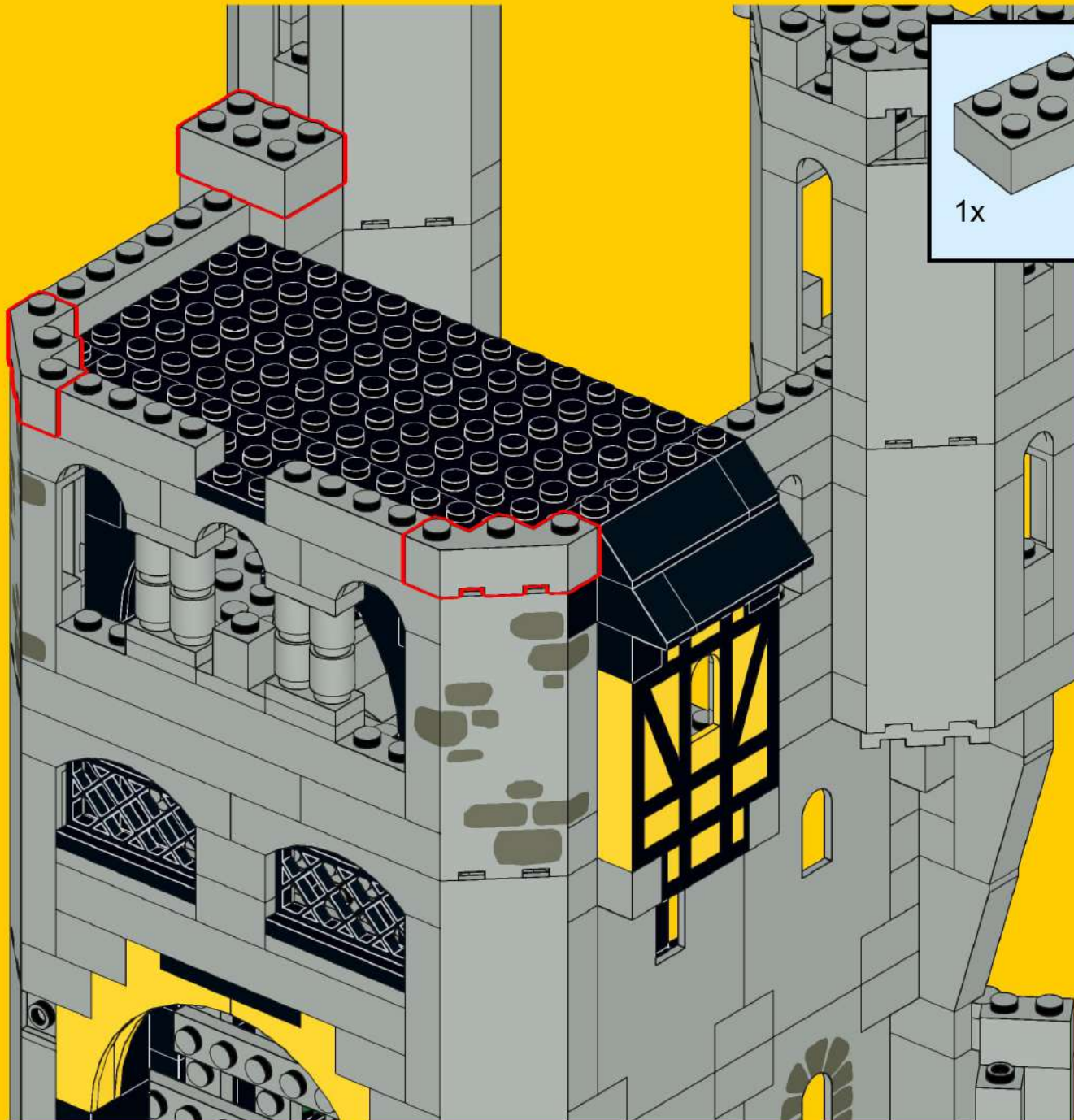



# 85

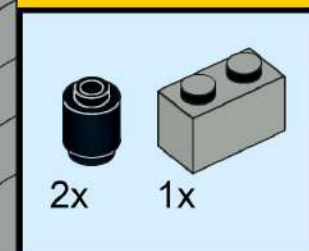
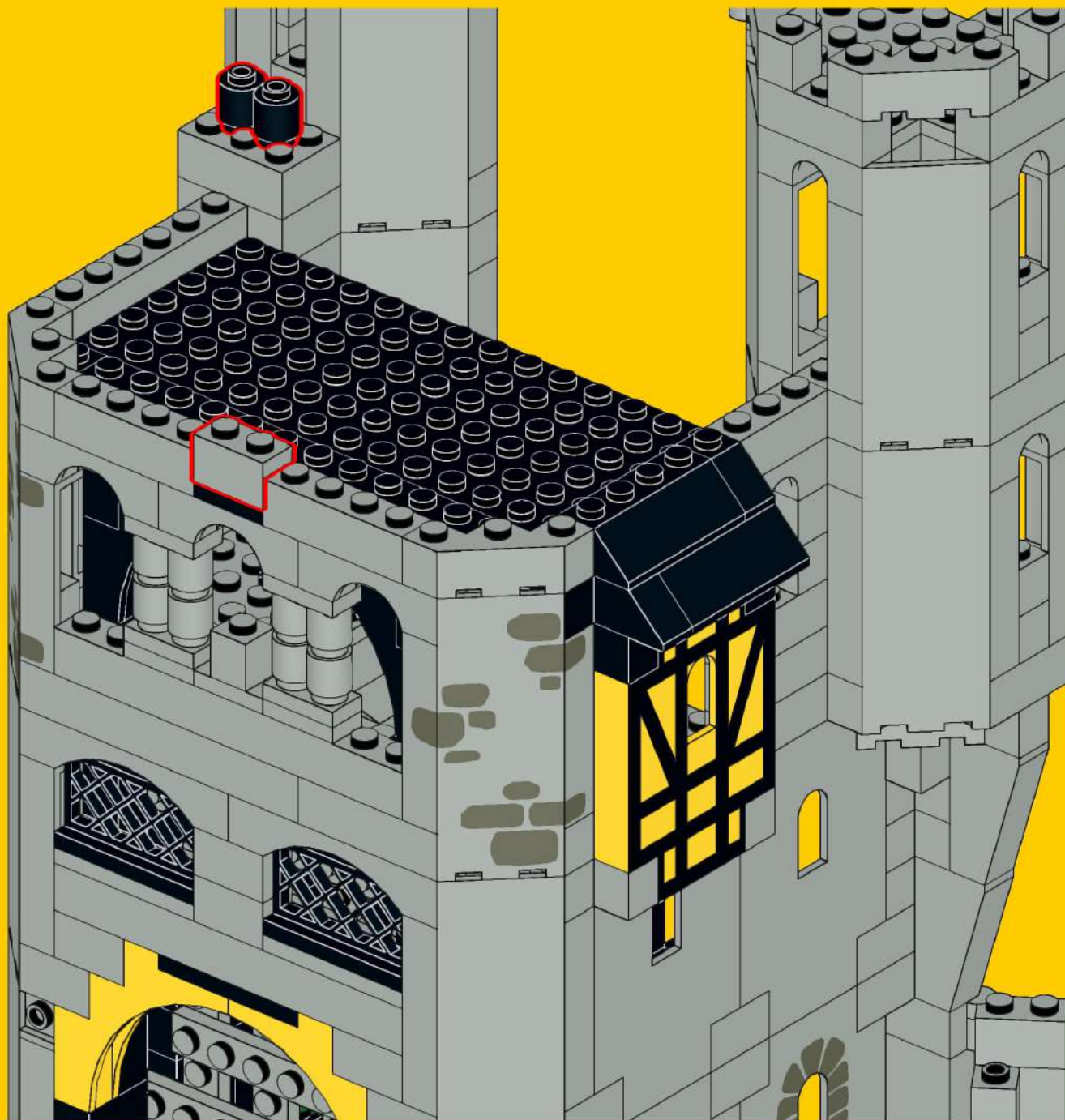

# 86

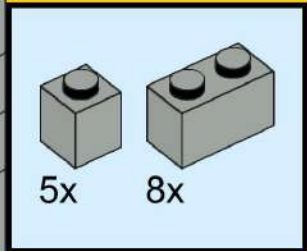
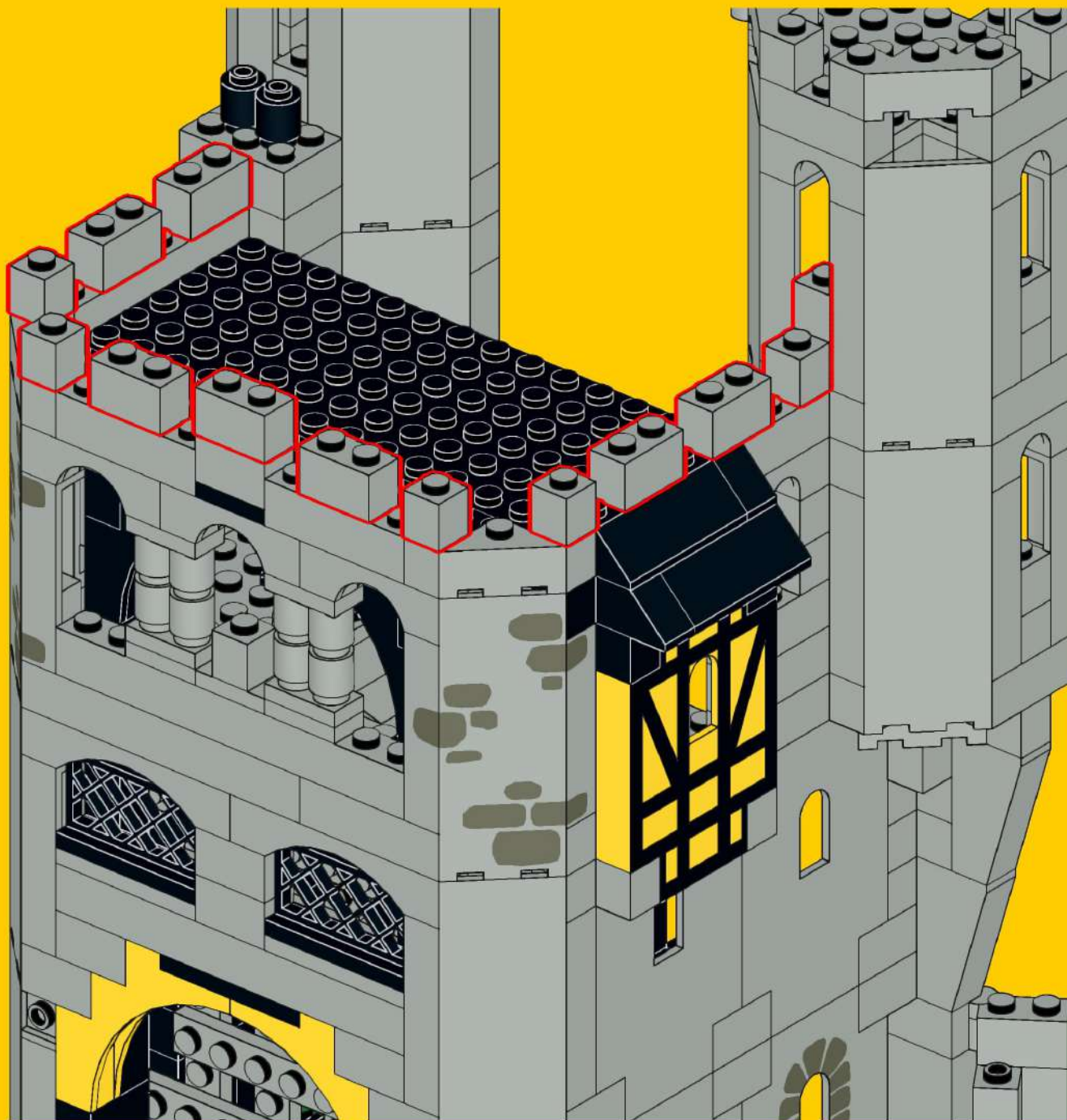

87

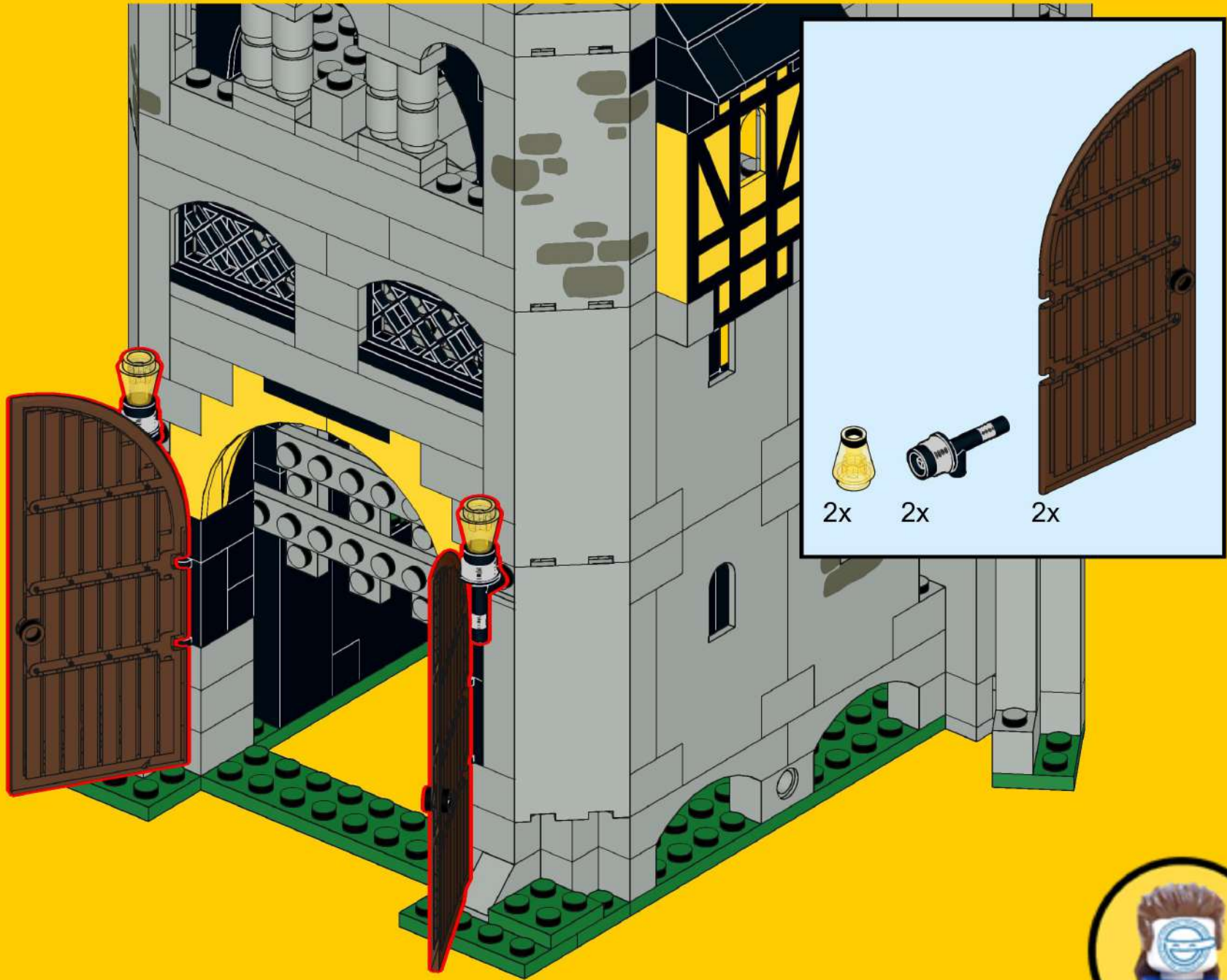

# 88

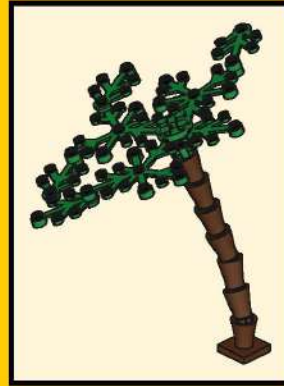
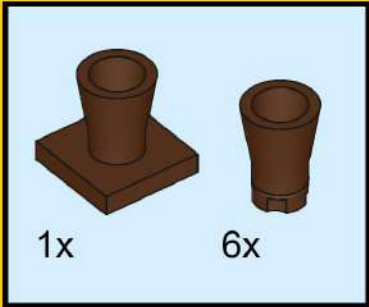

# 89

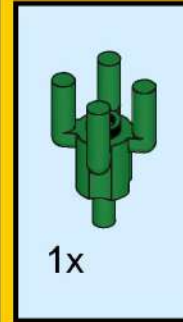

# 90

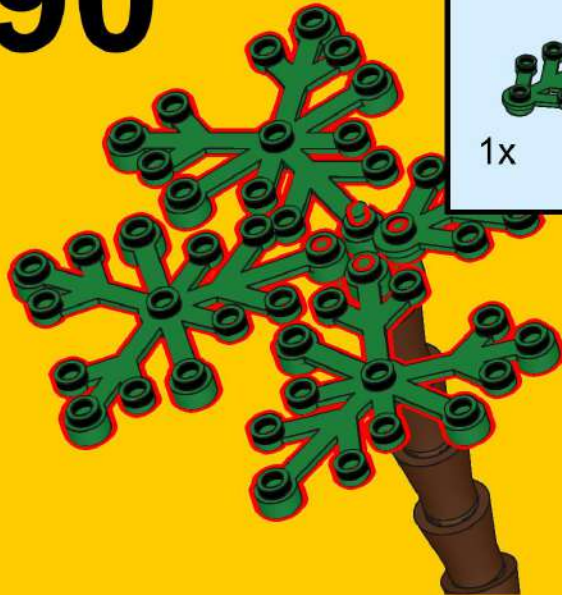
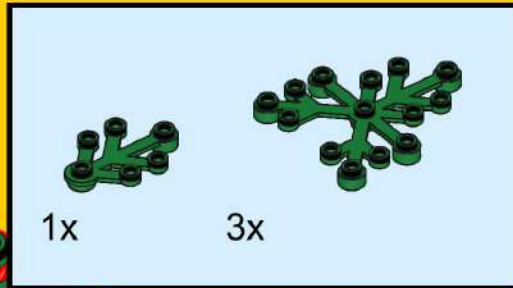

# 91

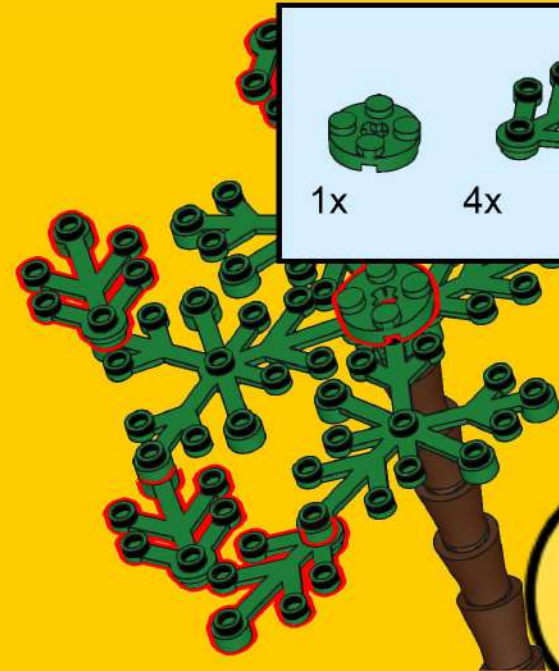
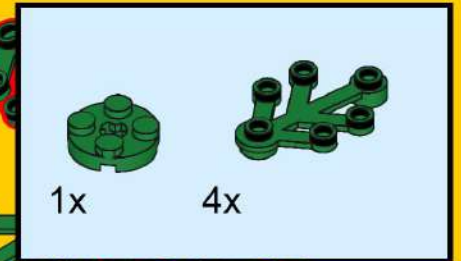

92

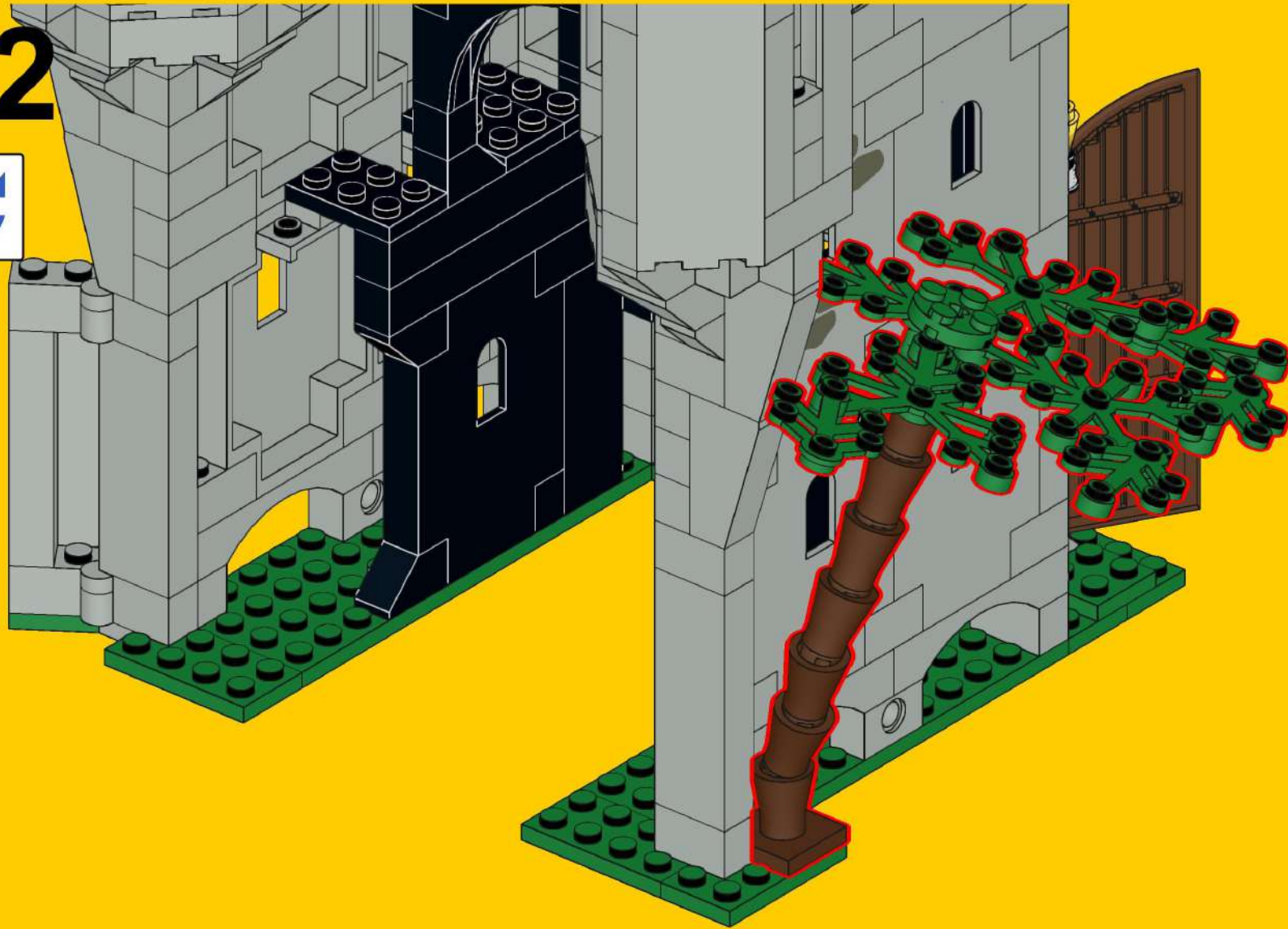

# 93

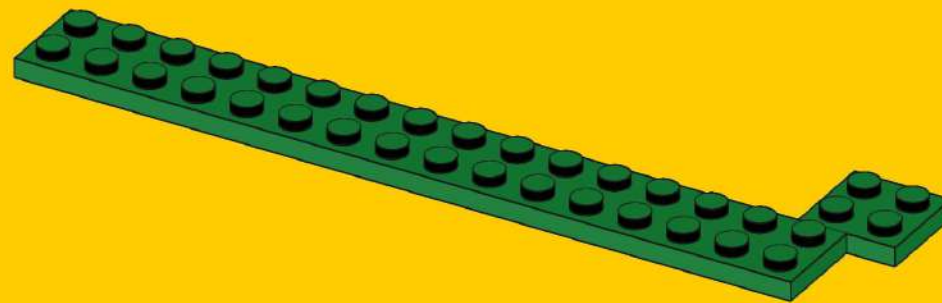
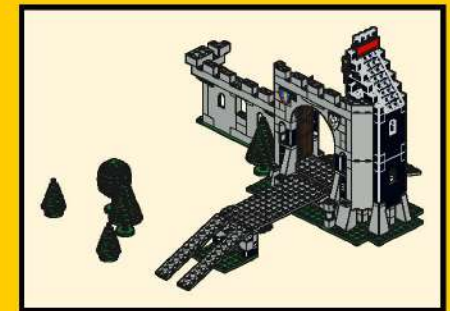
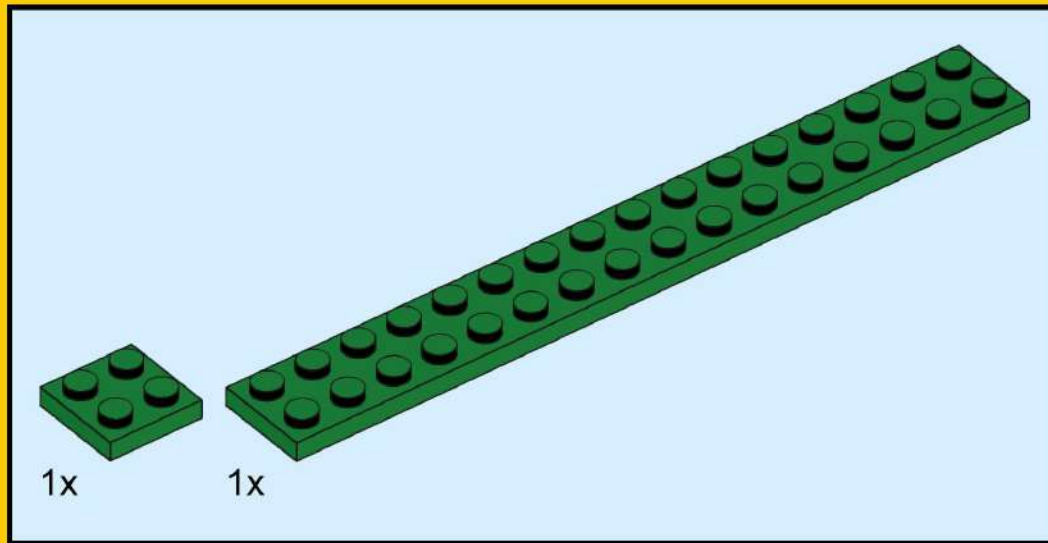

# 94

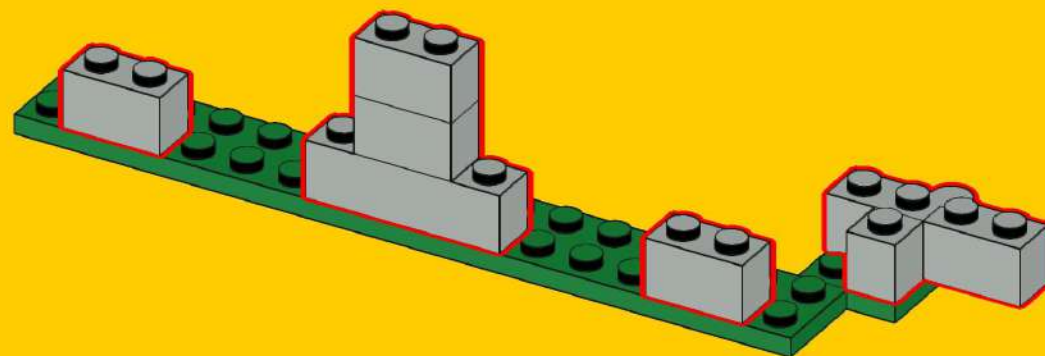
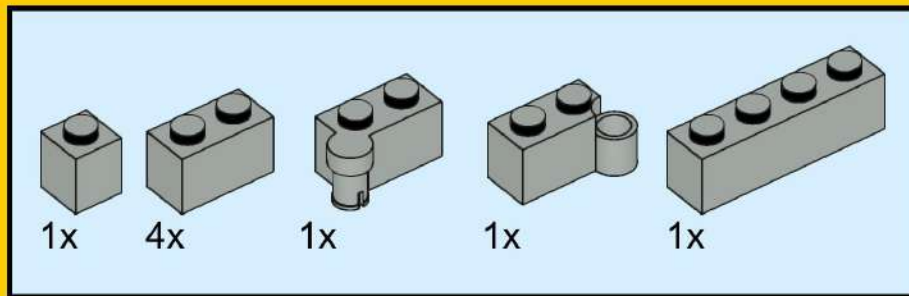

# 95

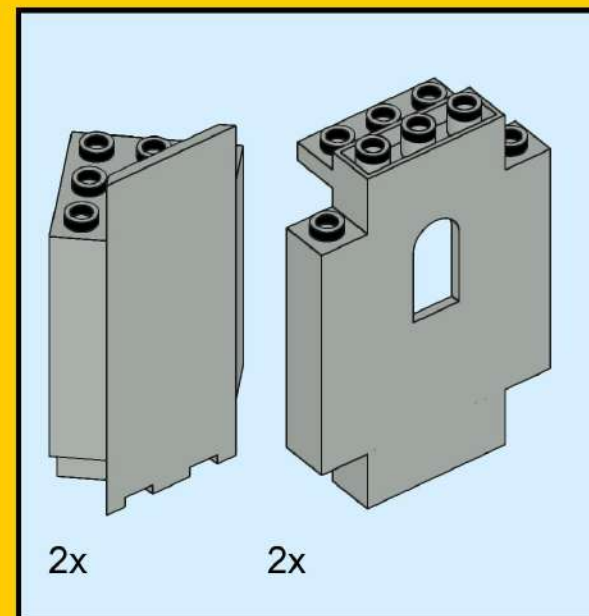
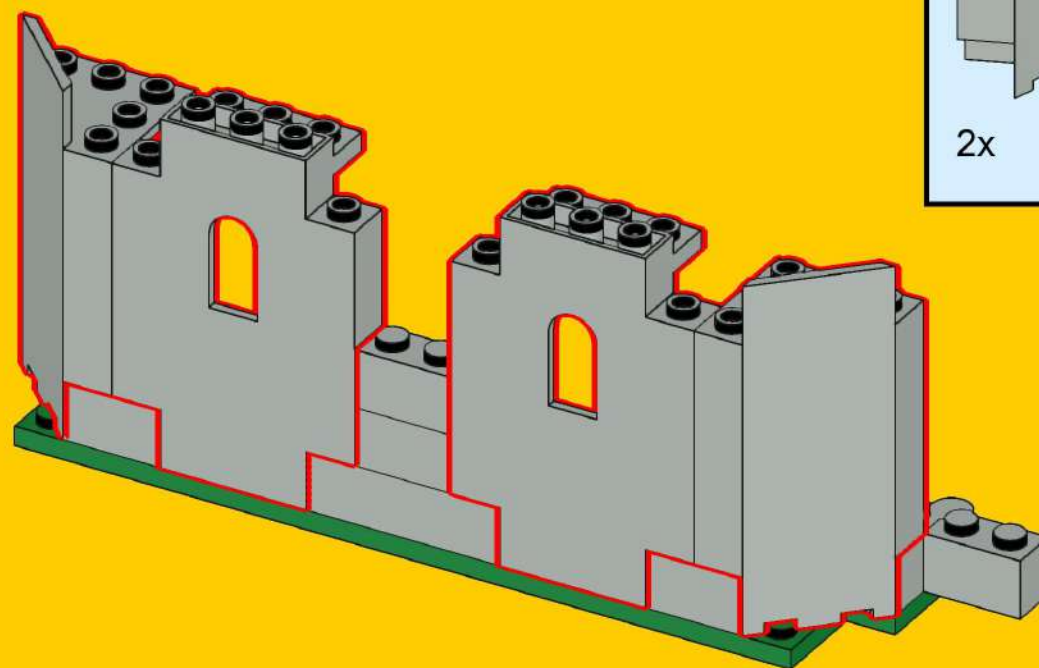



# 96

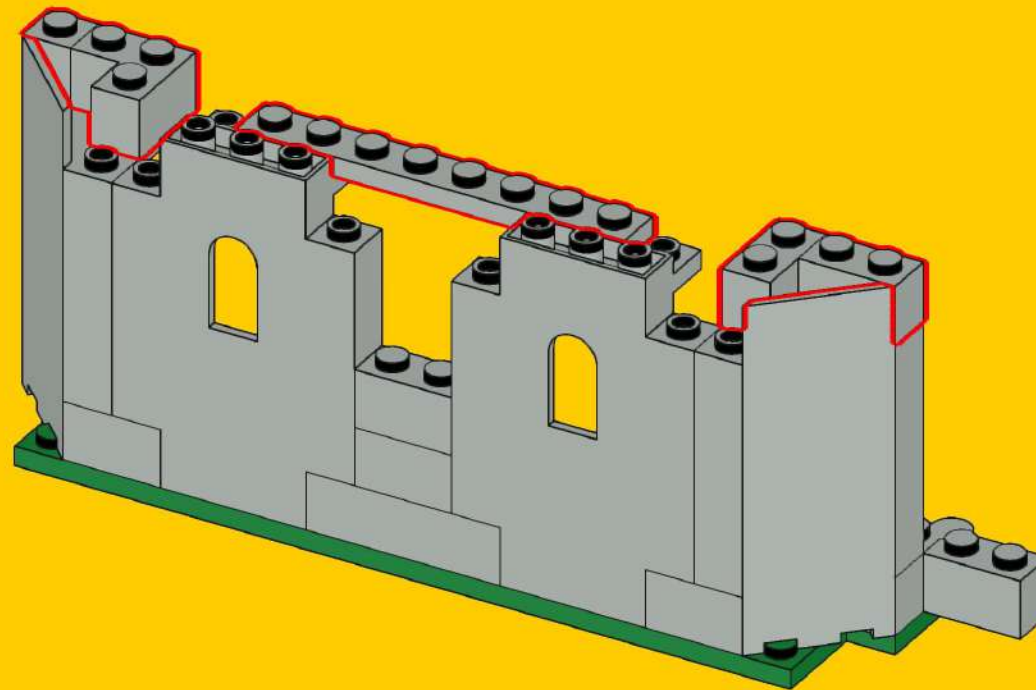
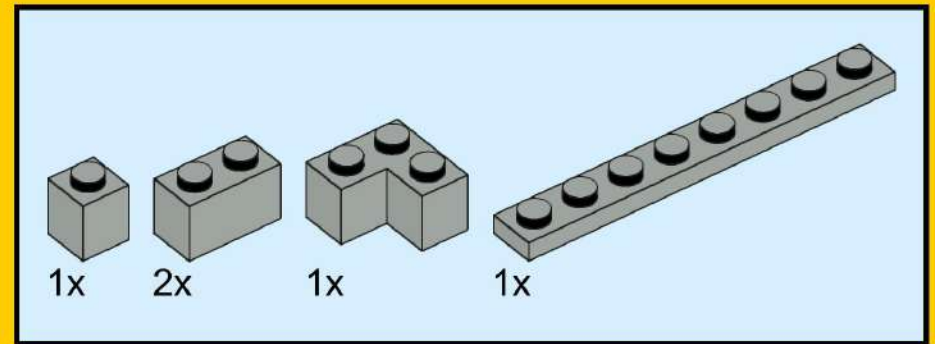

# 97

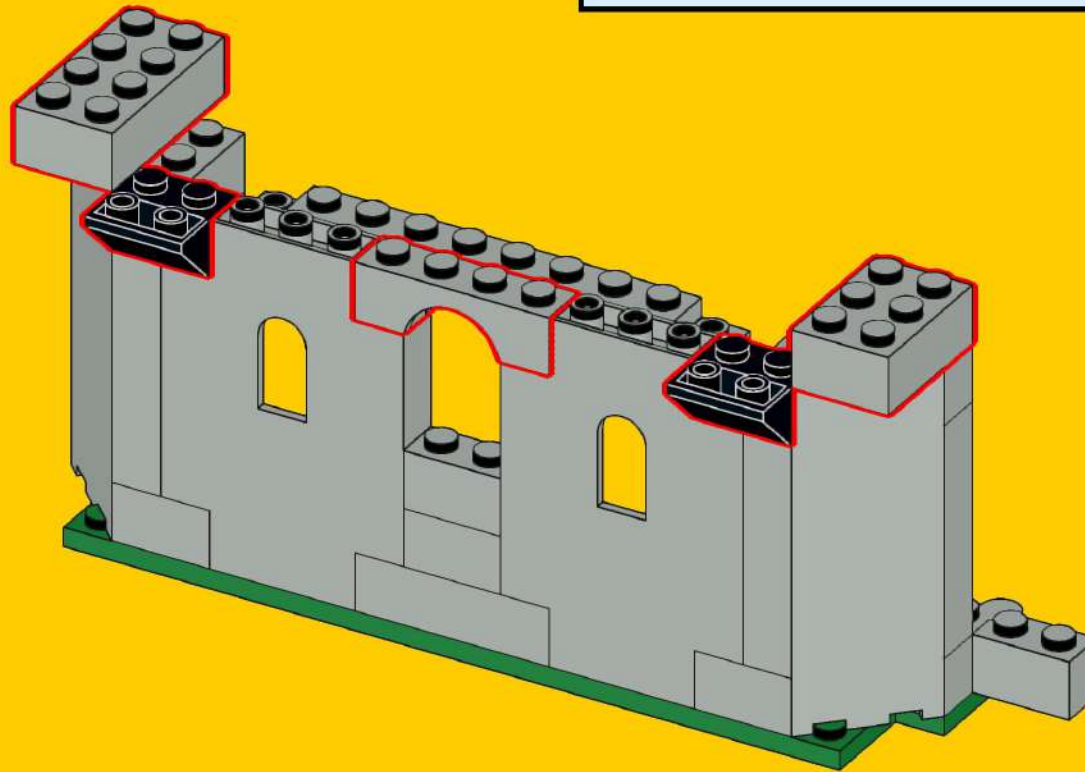
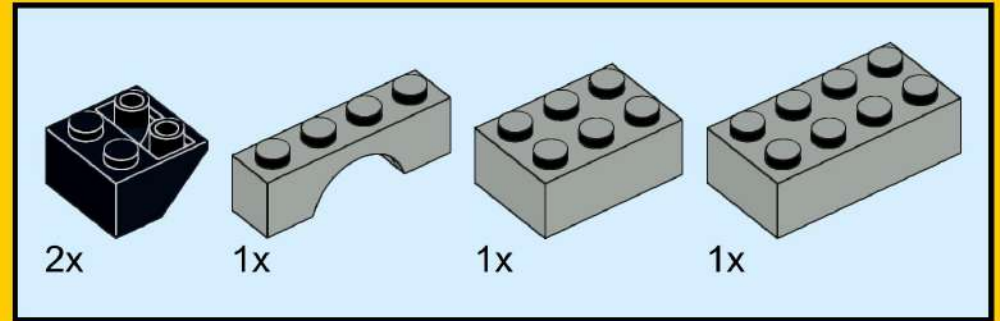

# 98

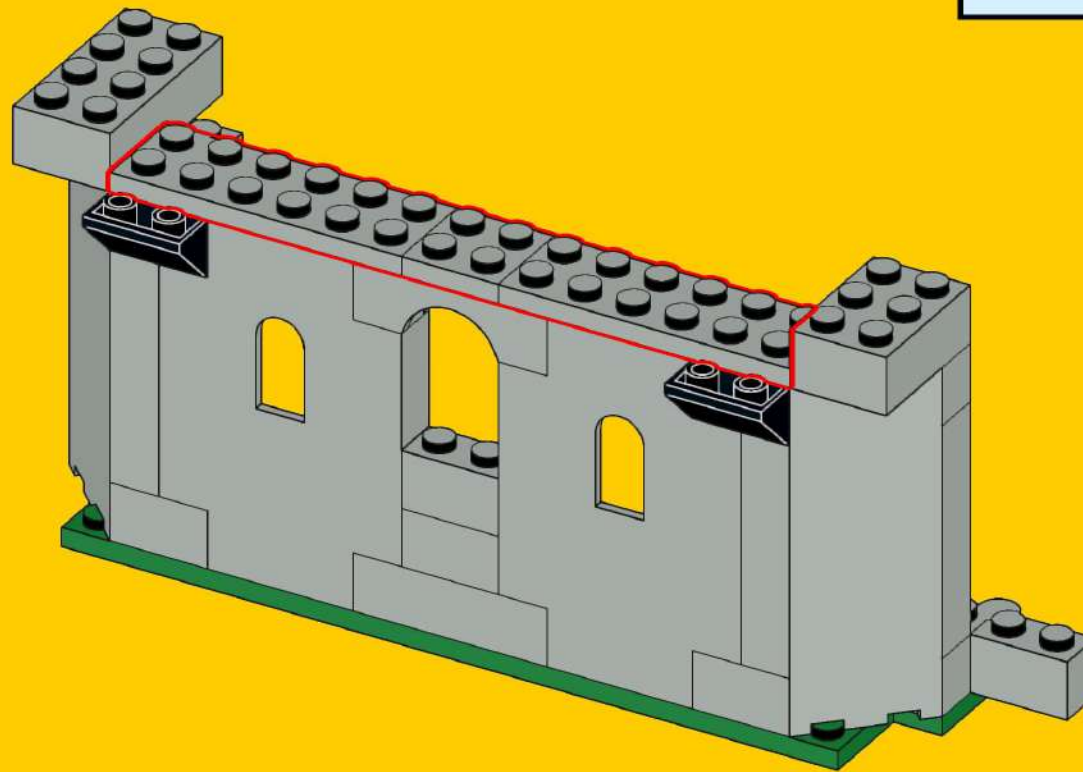
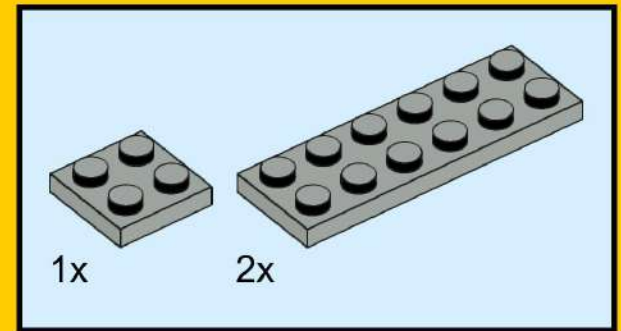

# 99

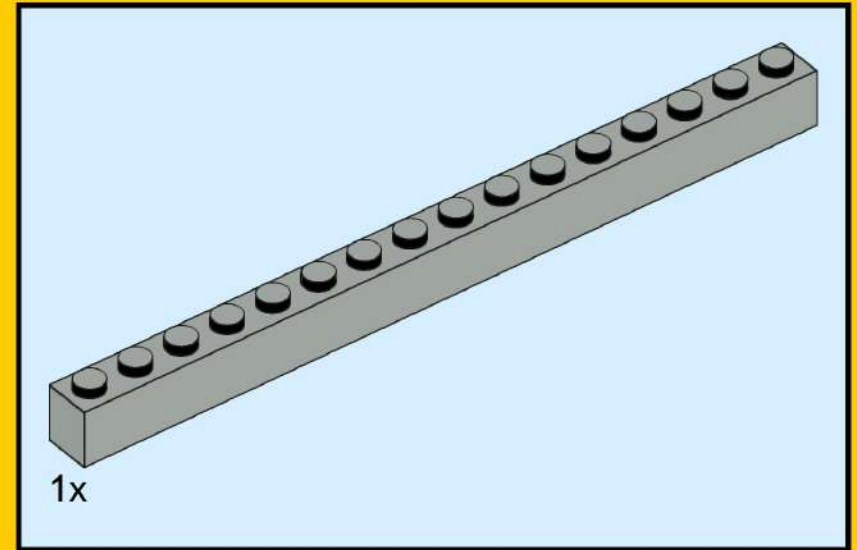
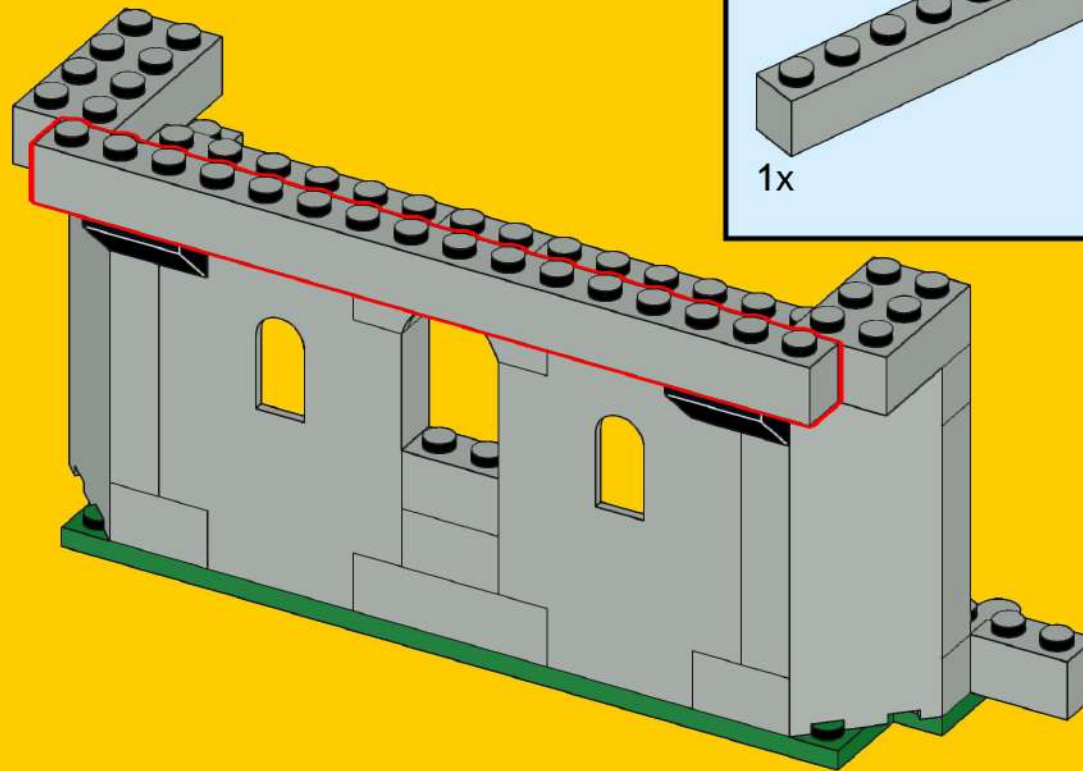

# 100

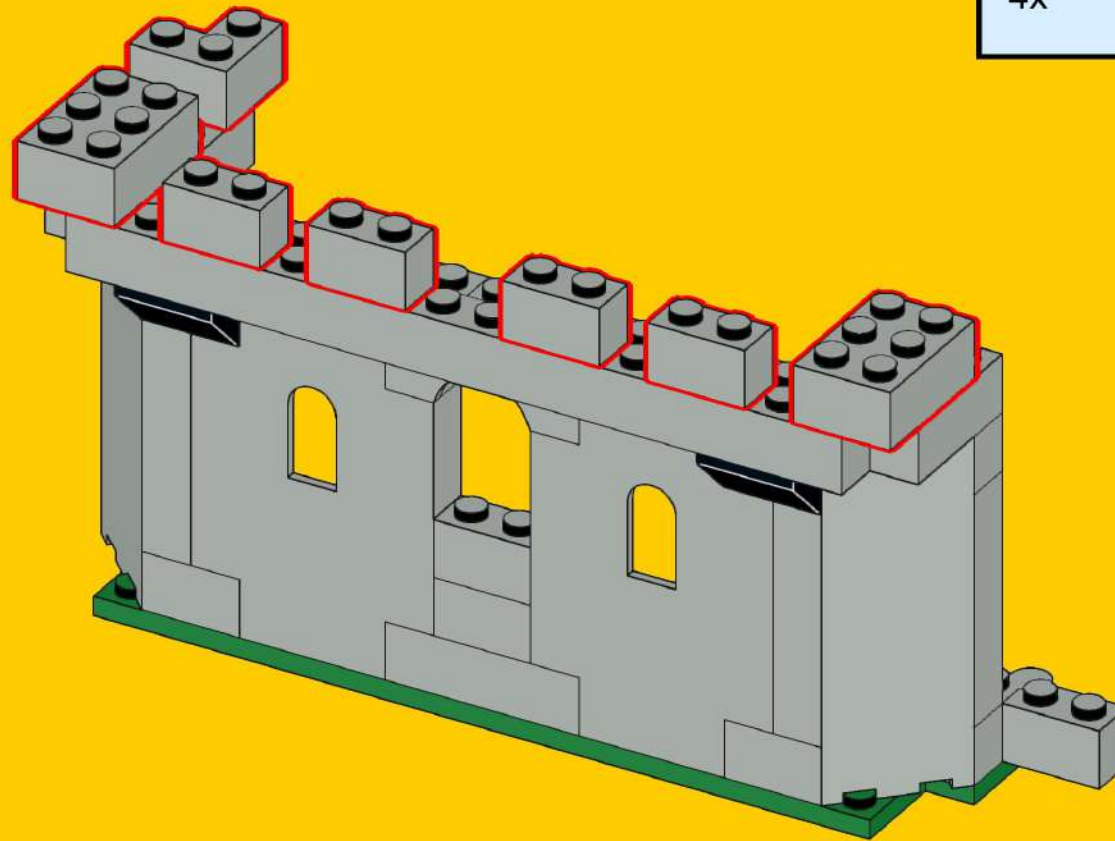
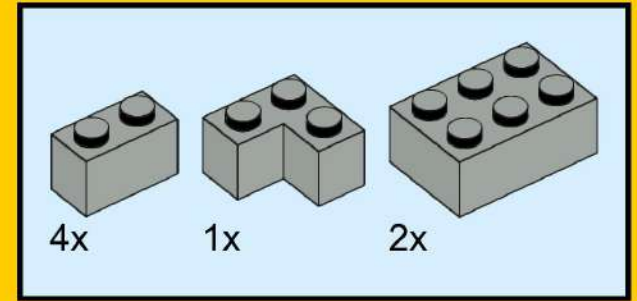

# 101

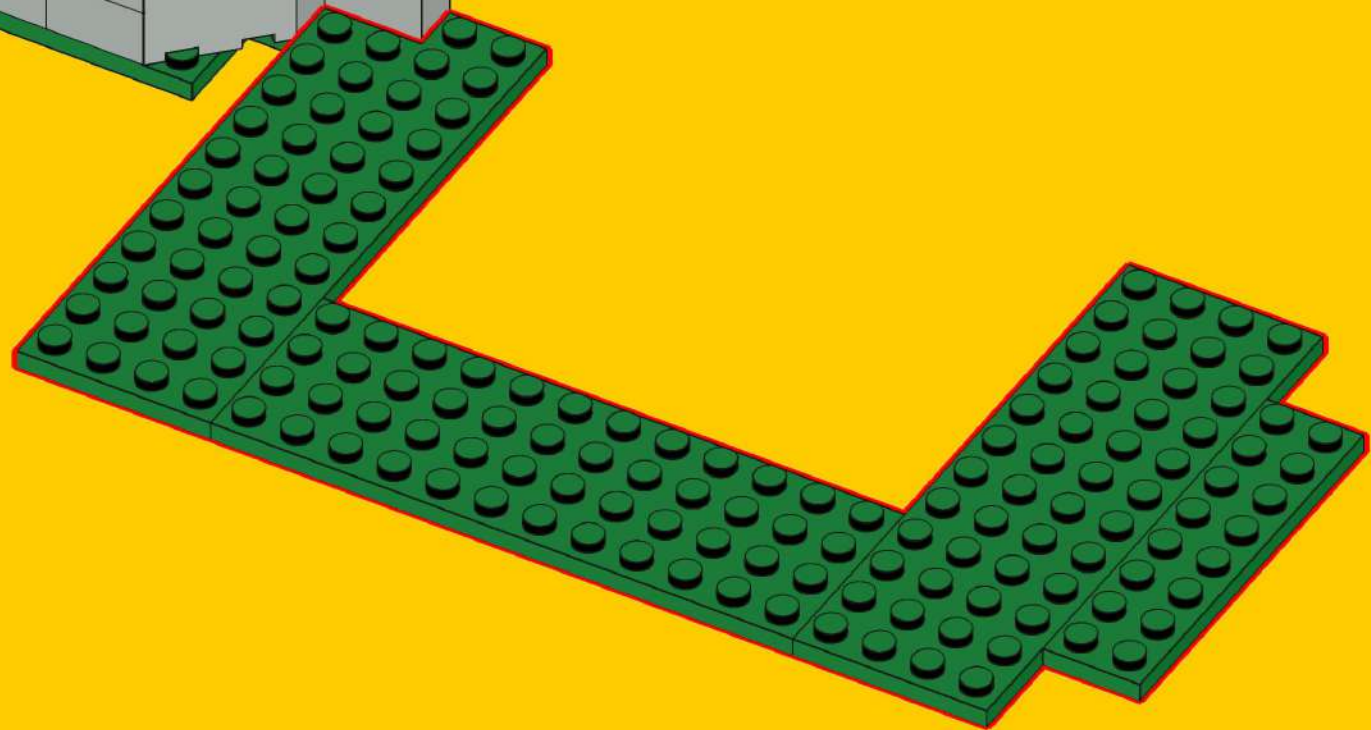
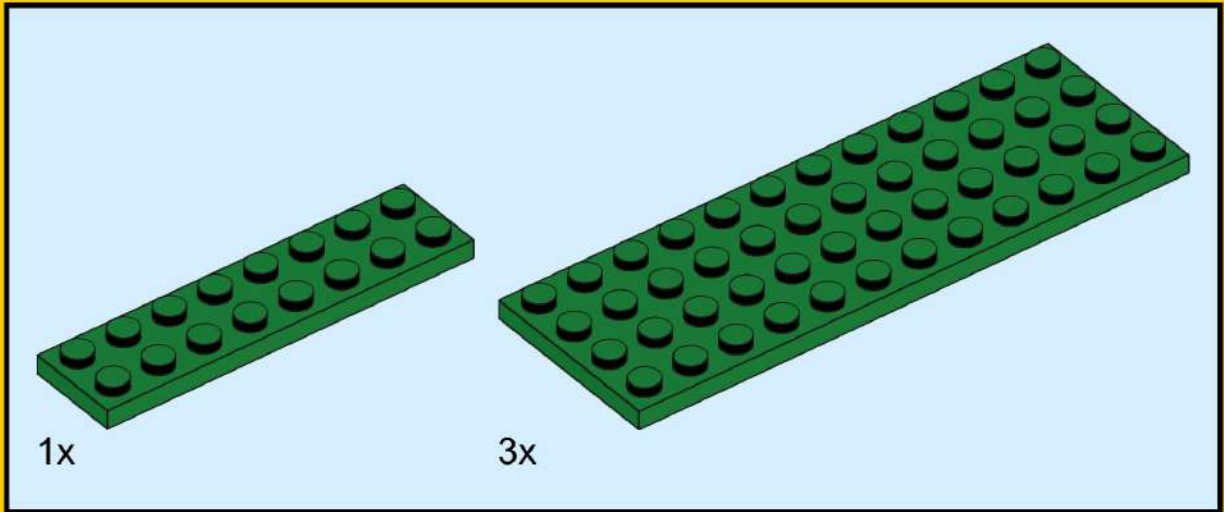
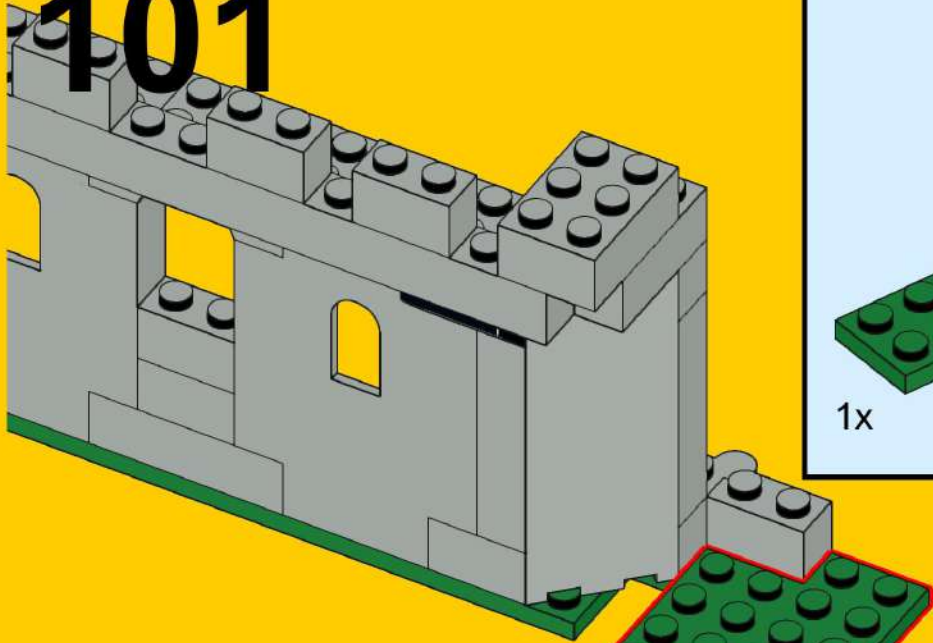

# 102

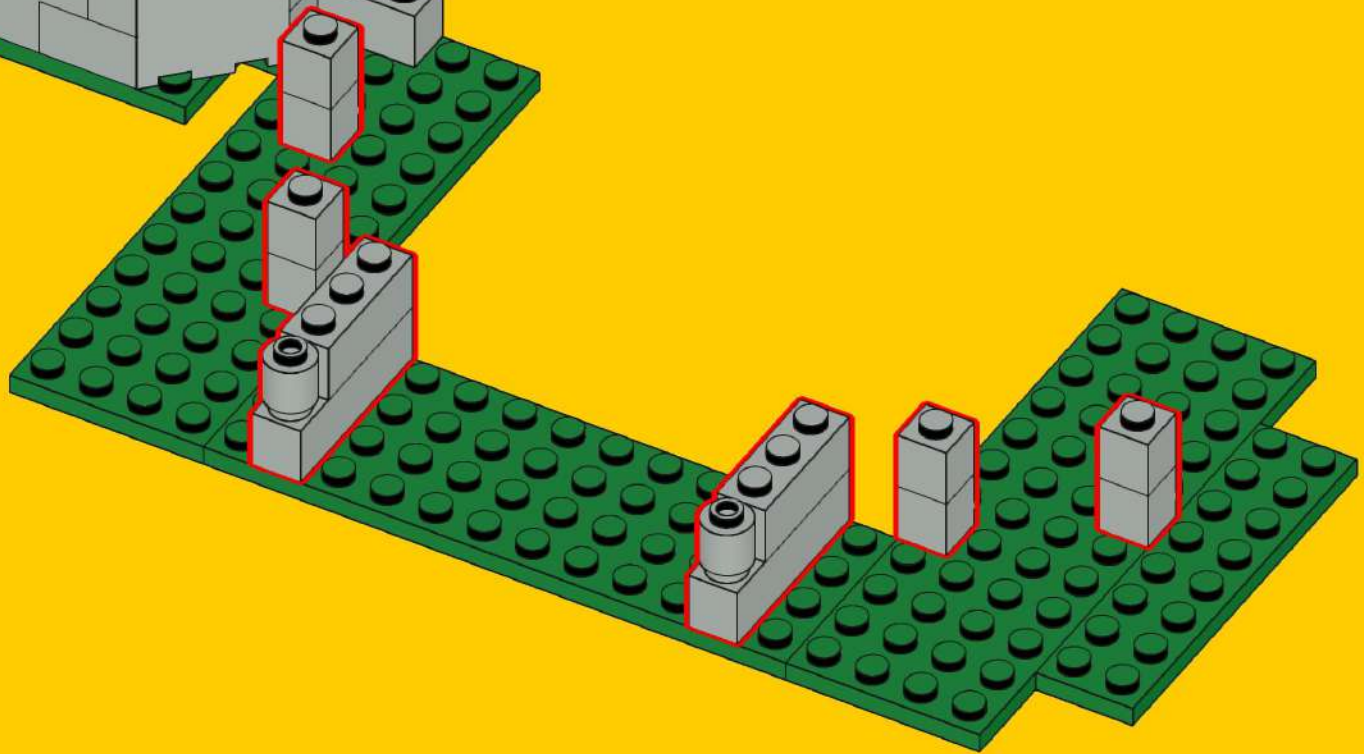
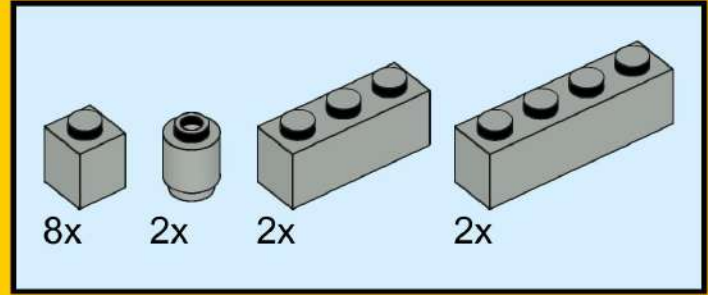
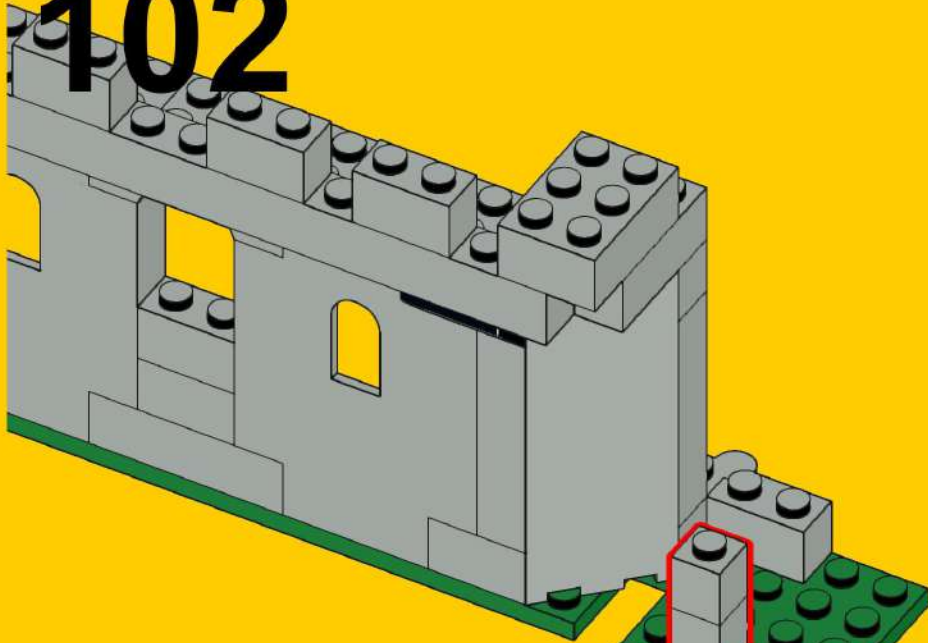

# 103

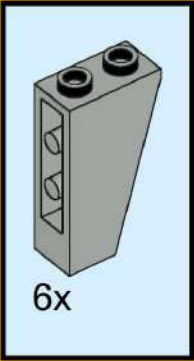
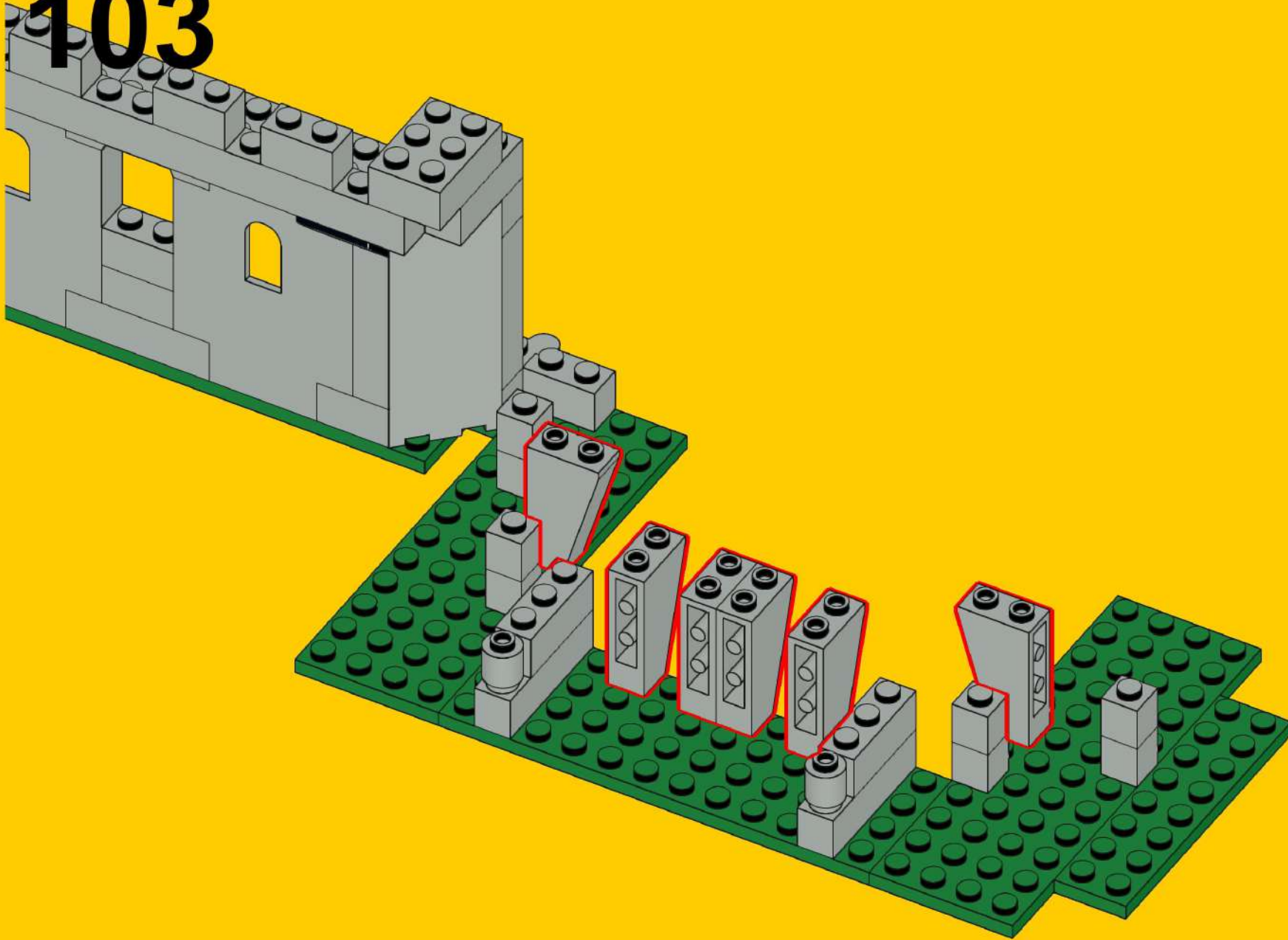





# 105

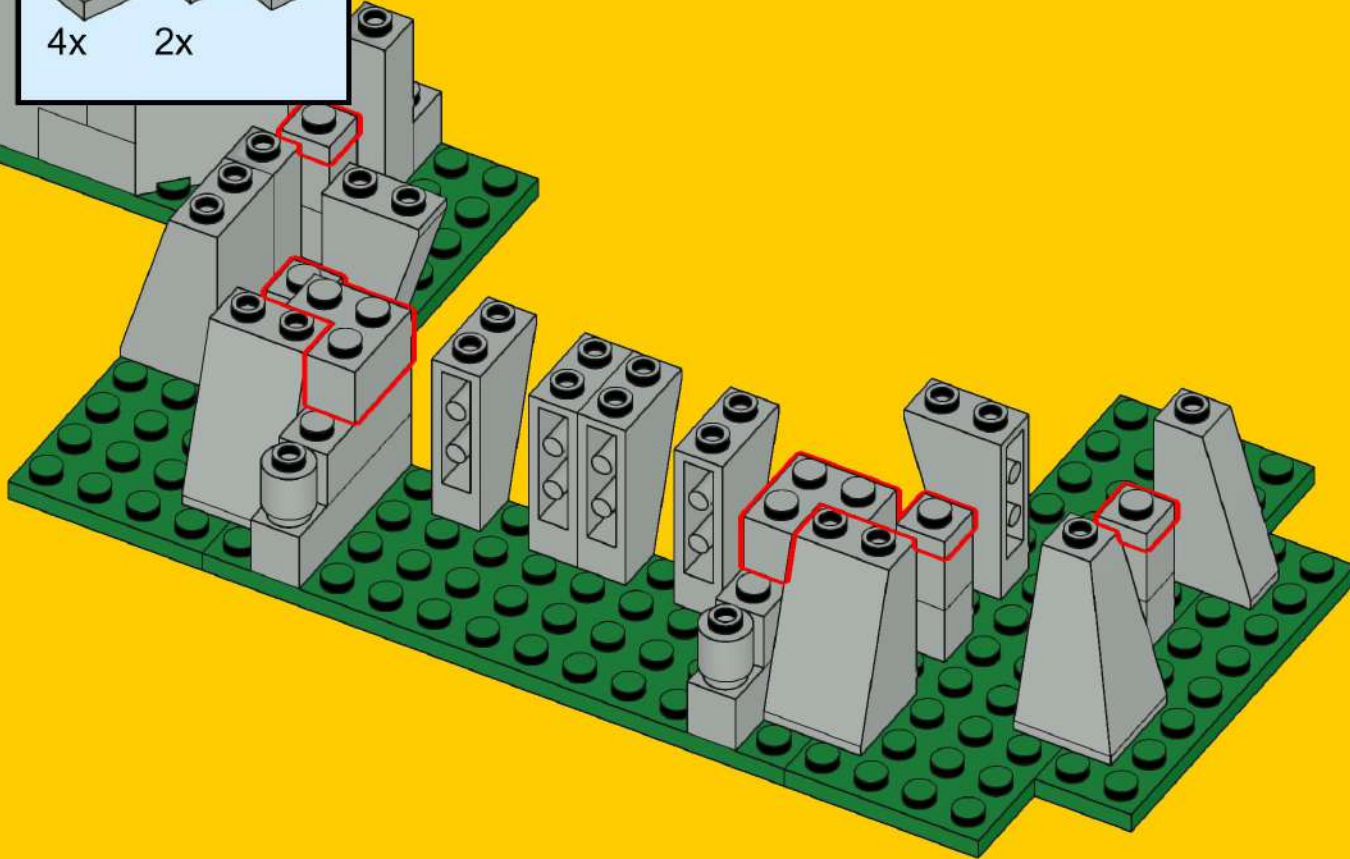
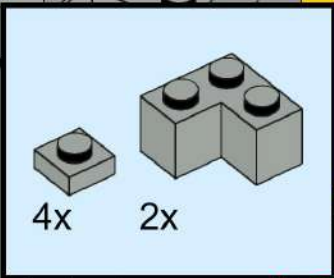

# 106

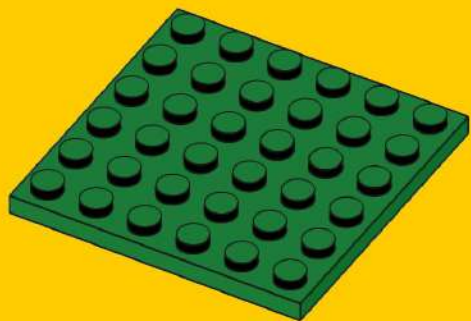
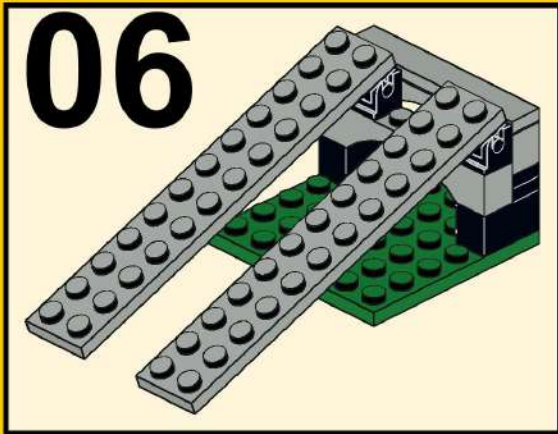

# 107

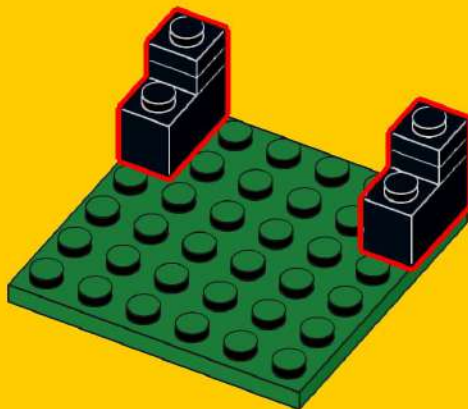
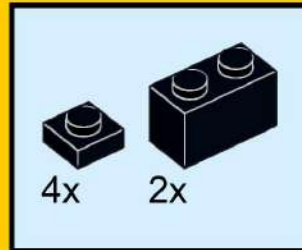

# 108

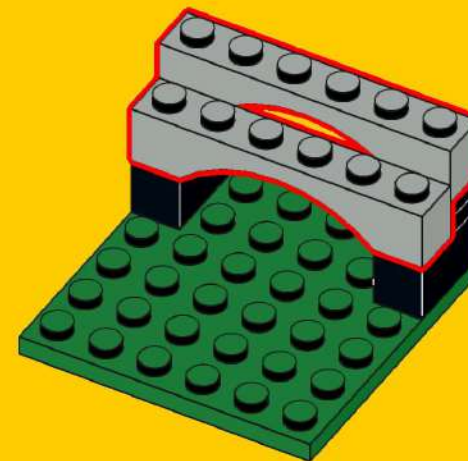
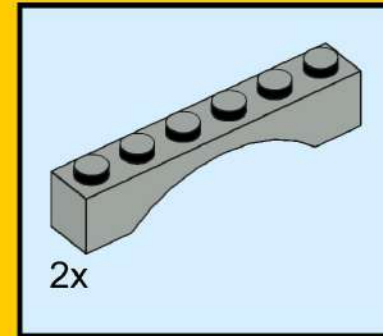

# 109

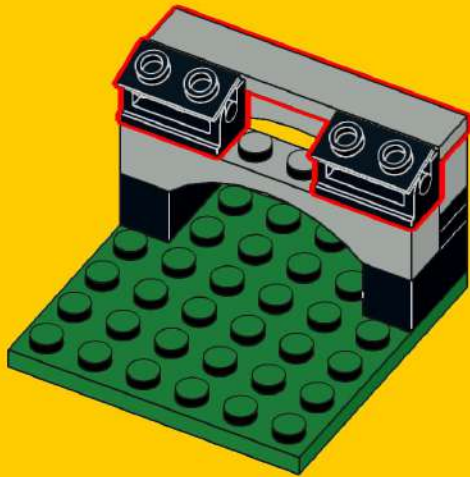
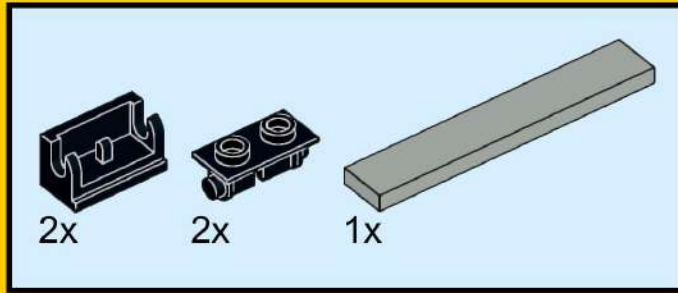

# 110

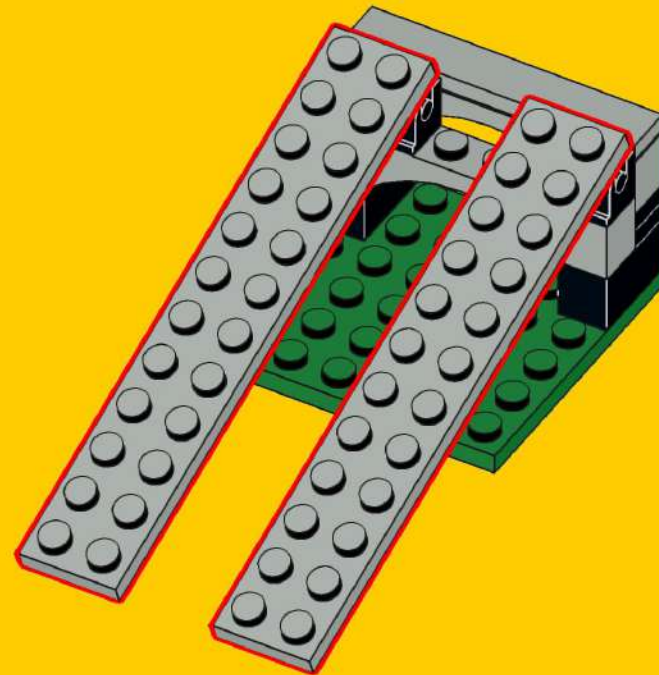
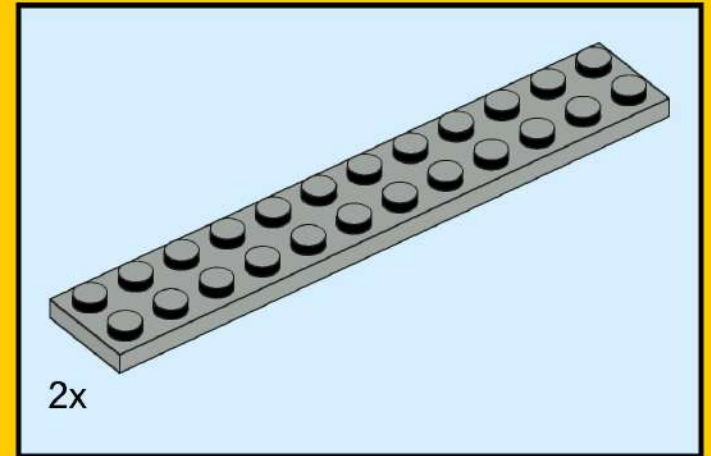

# 111

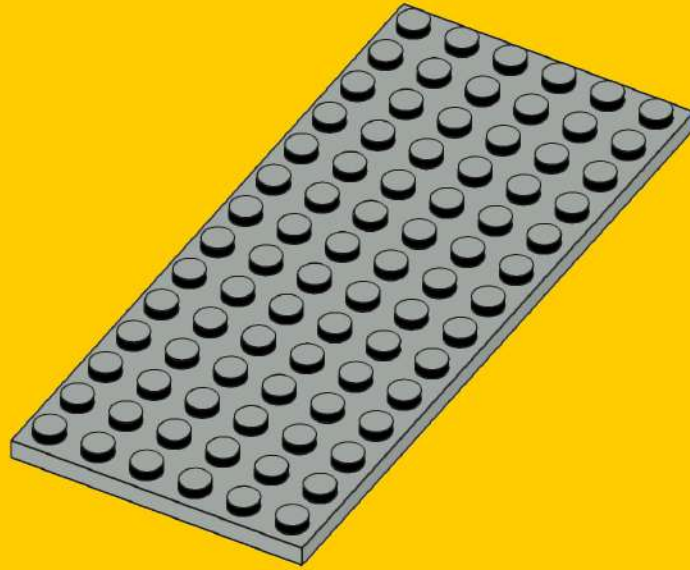
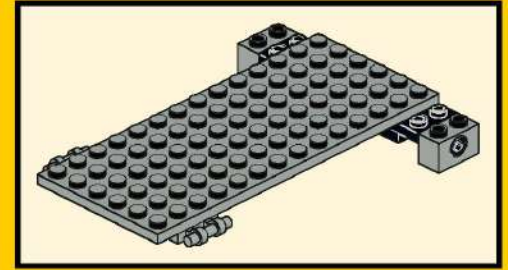

# 112

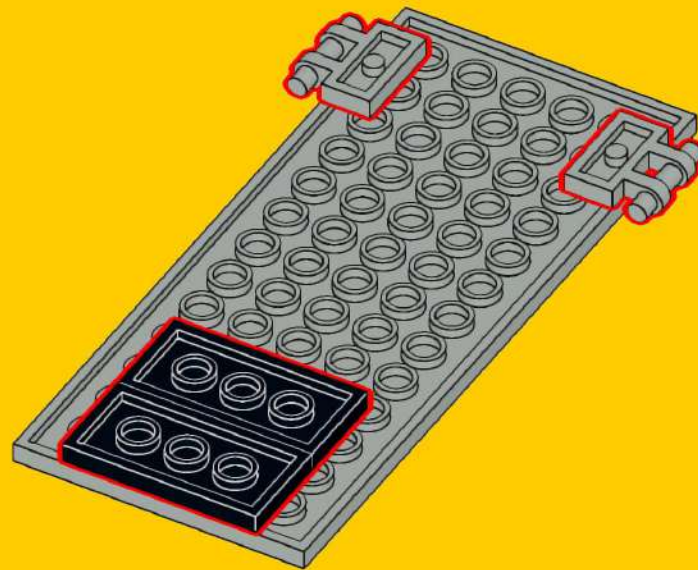
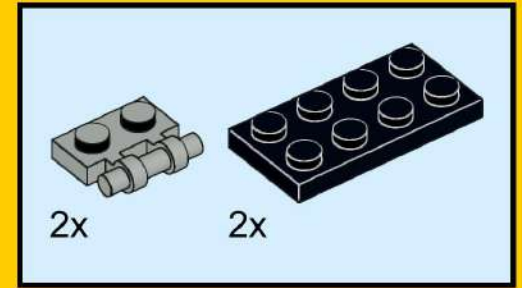

# 113

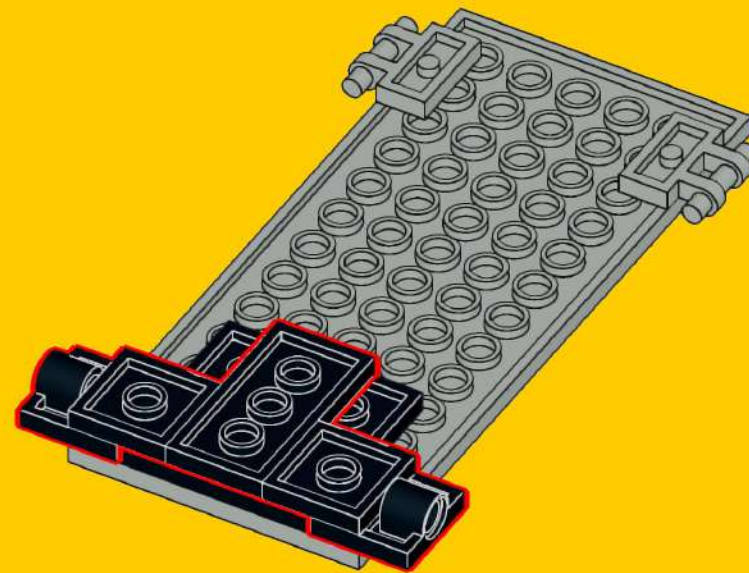
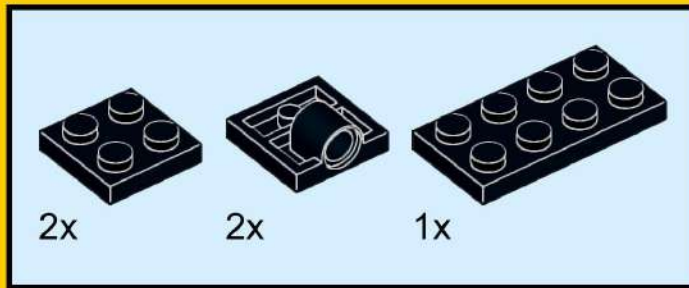

# 114

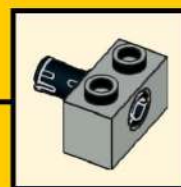
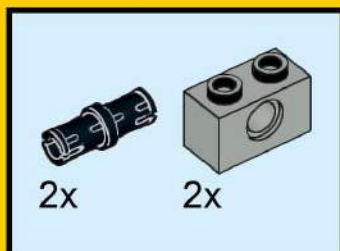

2x

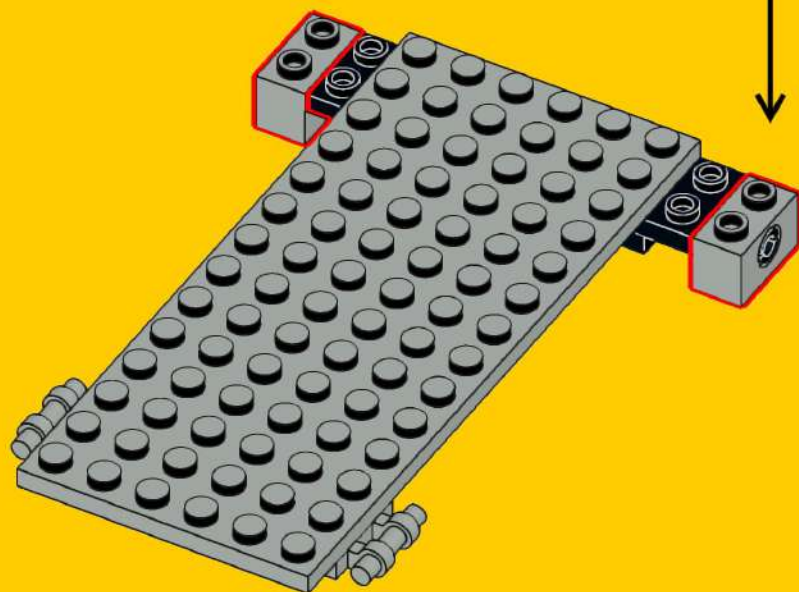



# 115

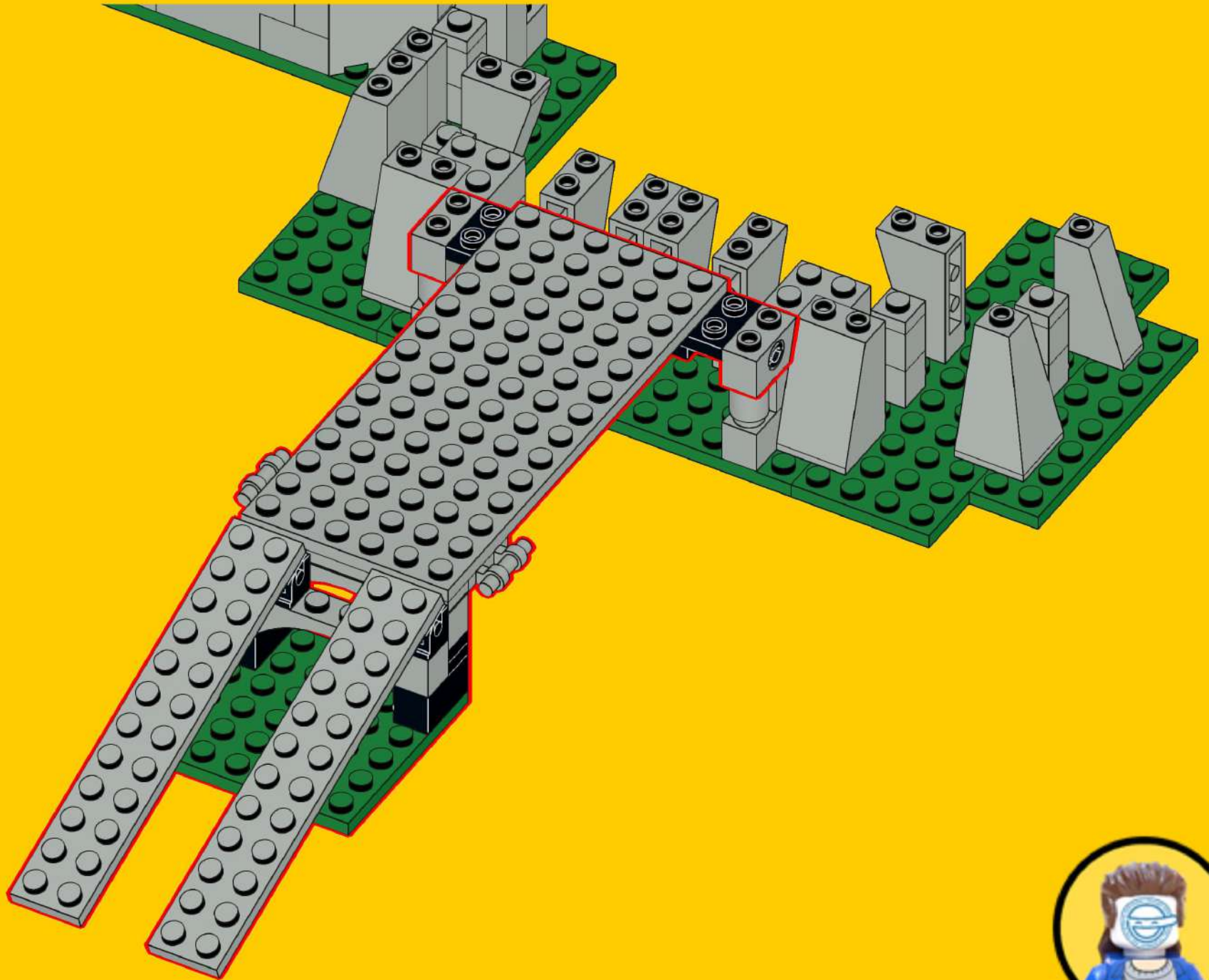

116

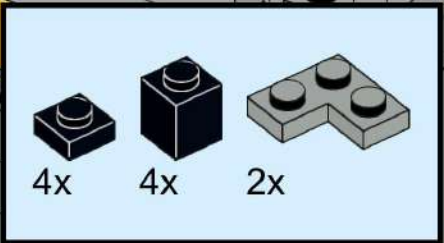

4x 4x 2x

This inset box lists the required parts for step 116: 4x 1x1 black Technic pins, 4x 1x1 black Technic bricks with holes, and 2x 1x2 black Technic Technic connectors.



2x

This inset box shows a 1x4 black Technic Technic connector, with the quantity '2x' written below it.

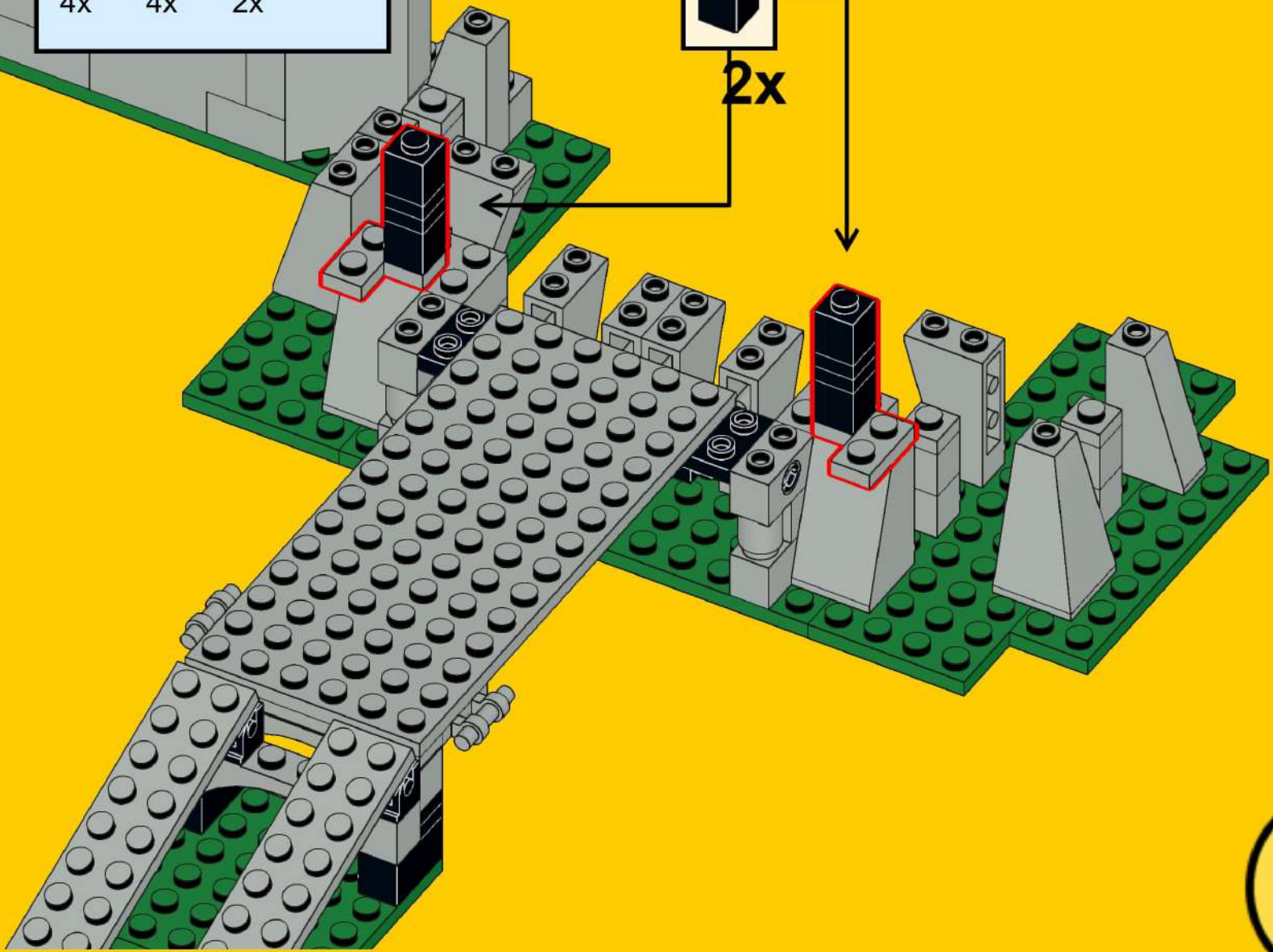

117

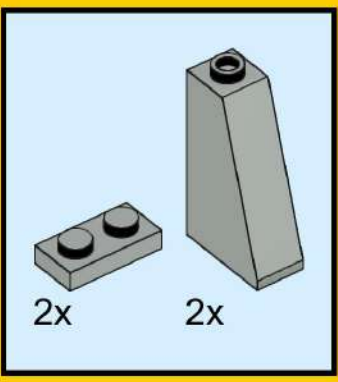
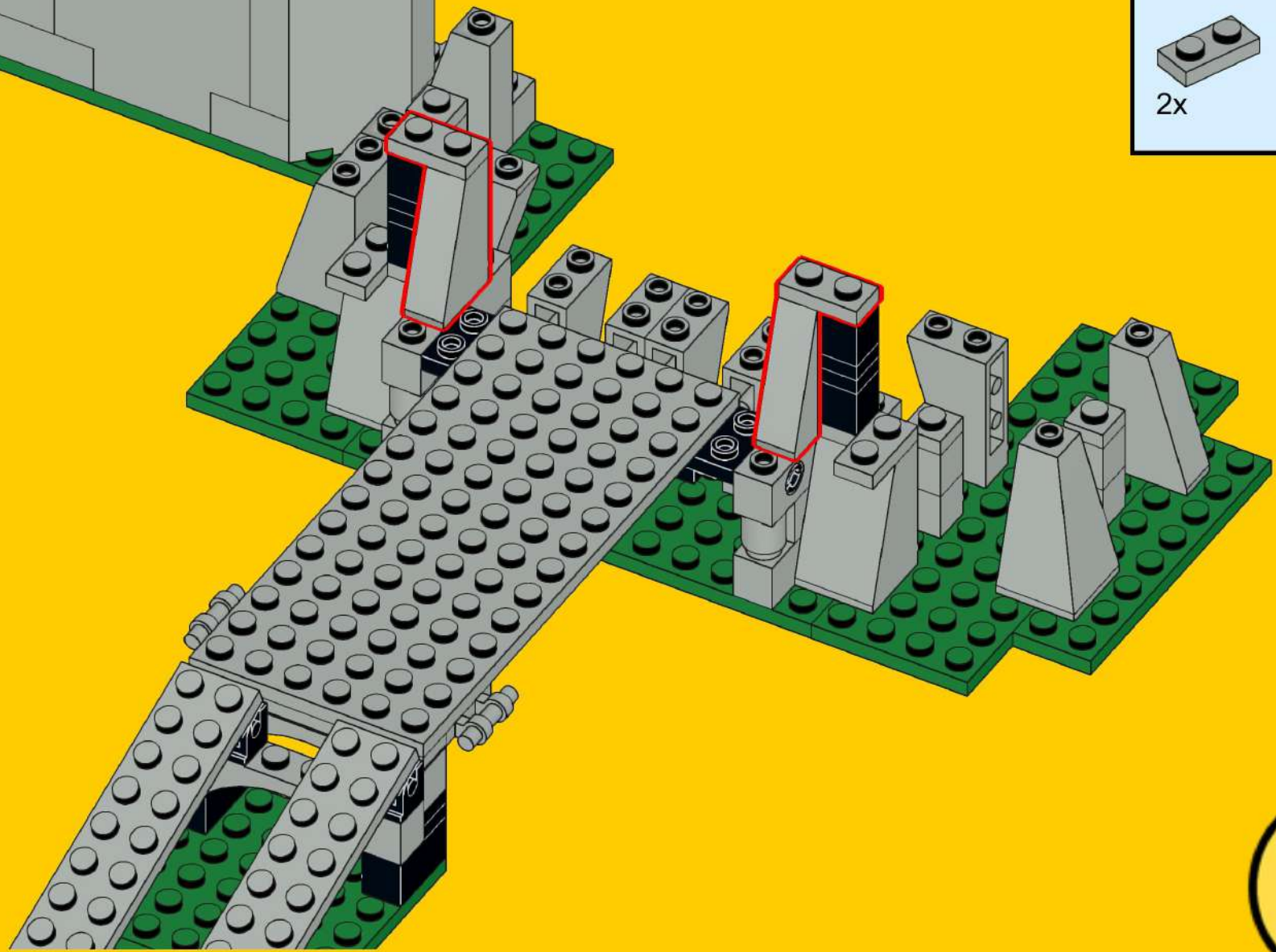

# 118

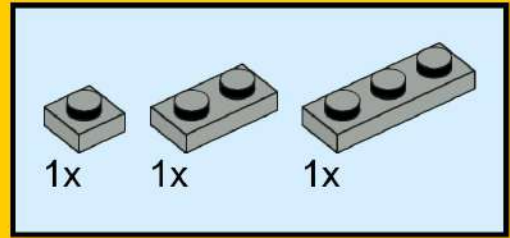
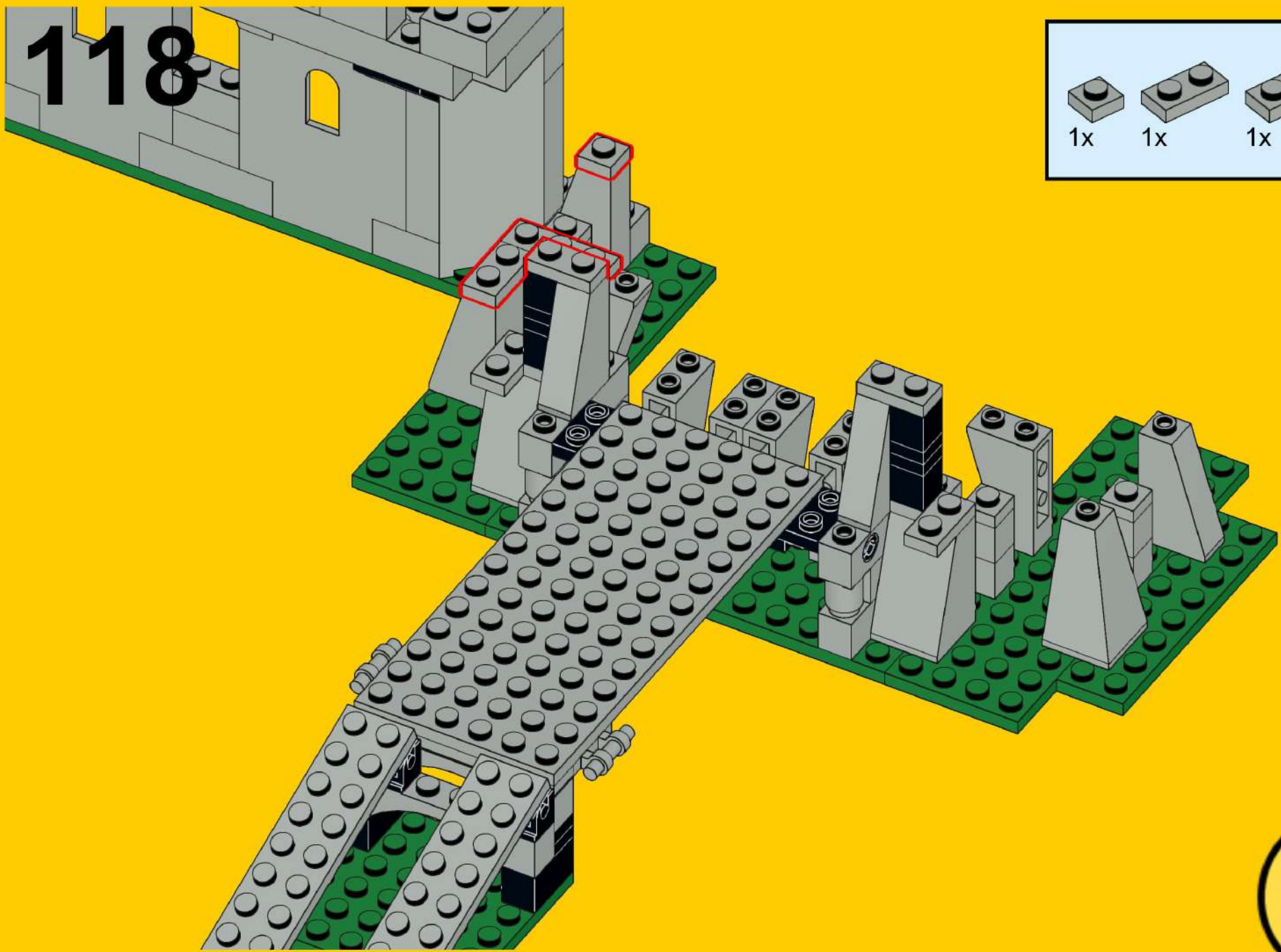

# 119

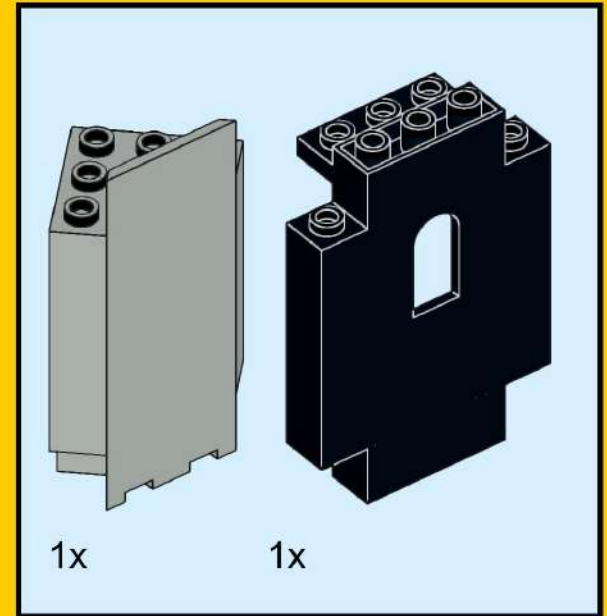
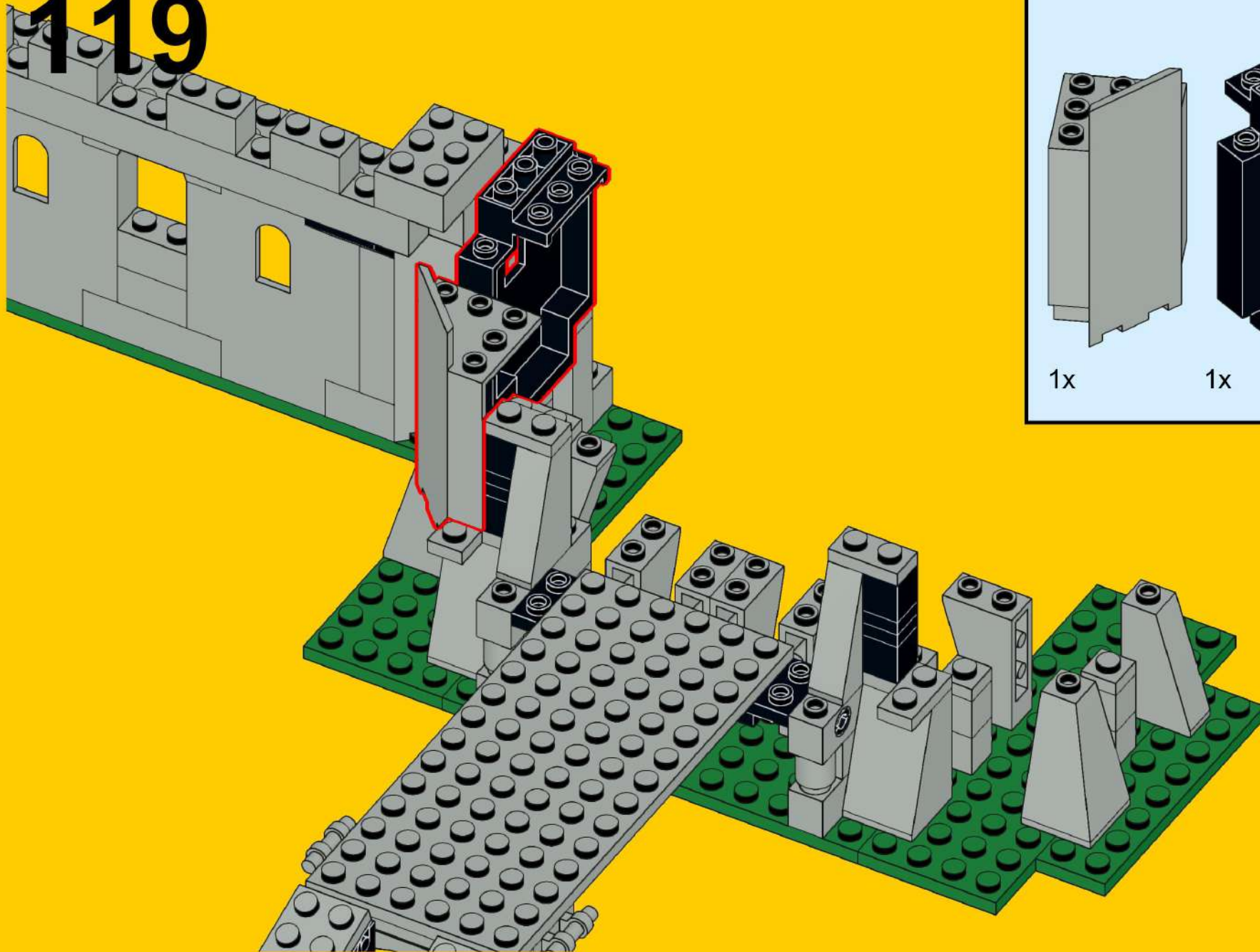

# 120

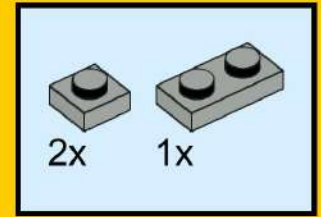
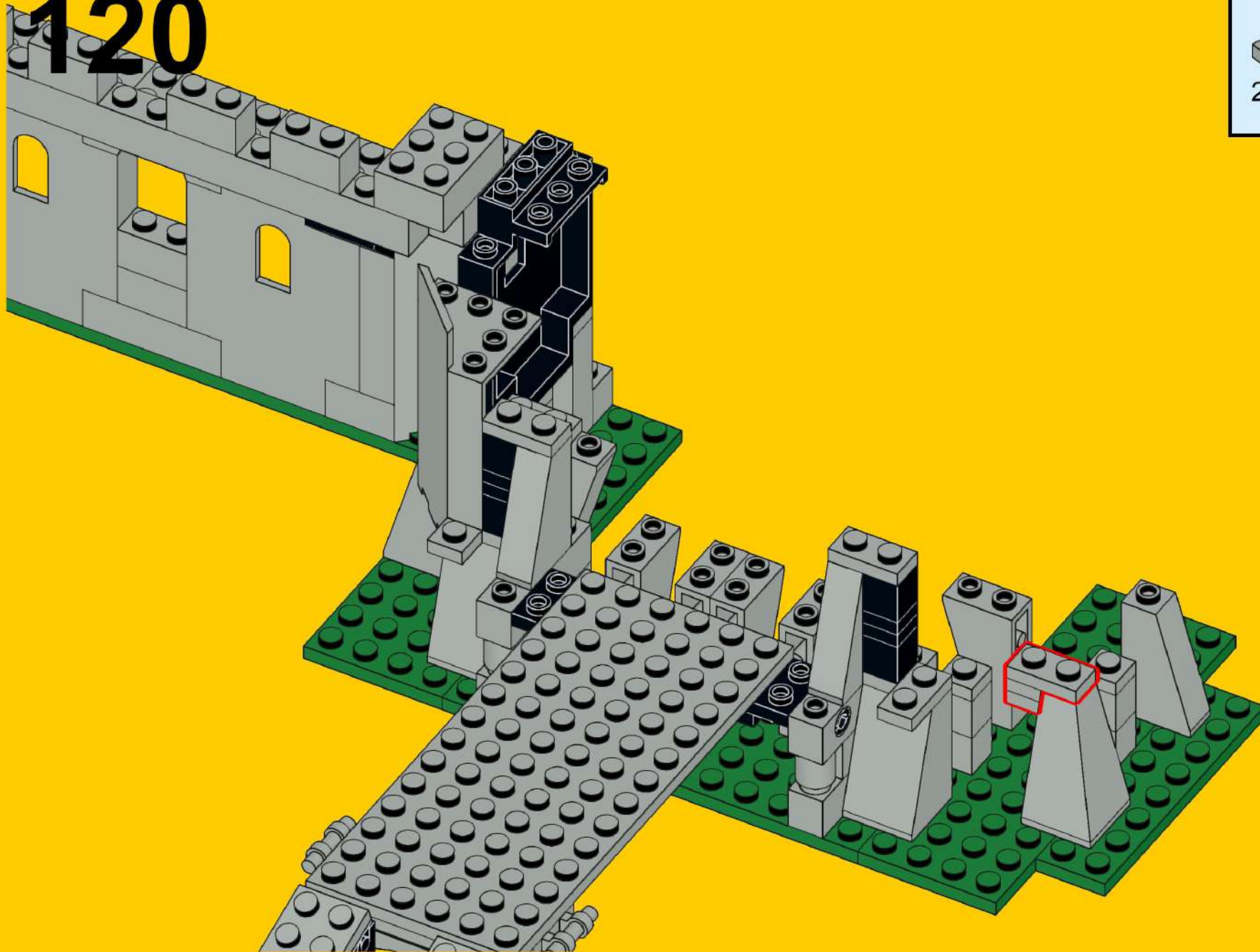

# 121

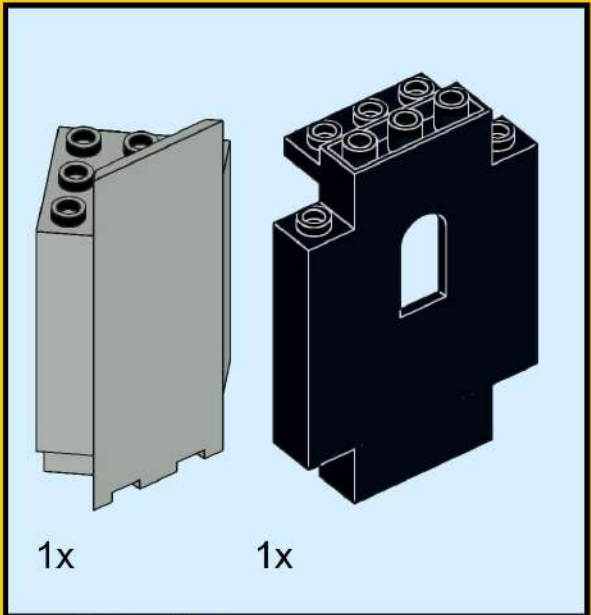
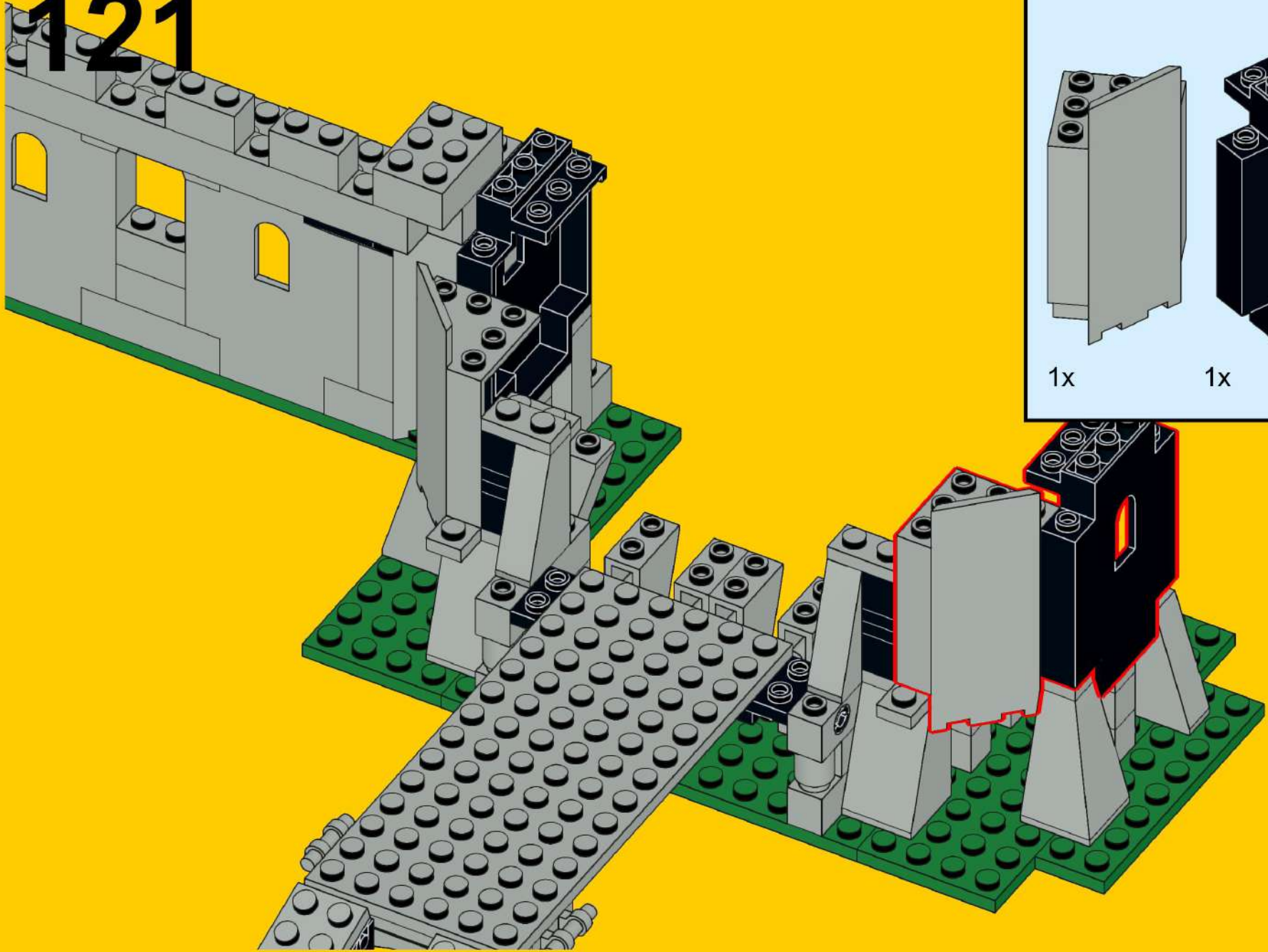

# 122

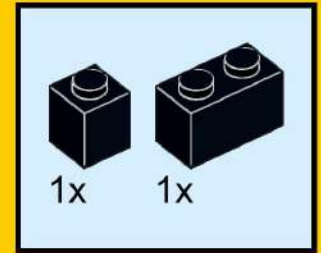
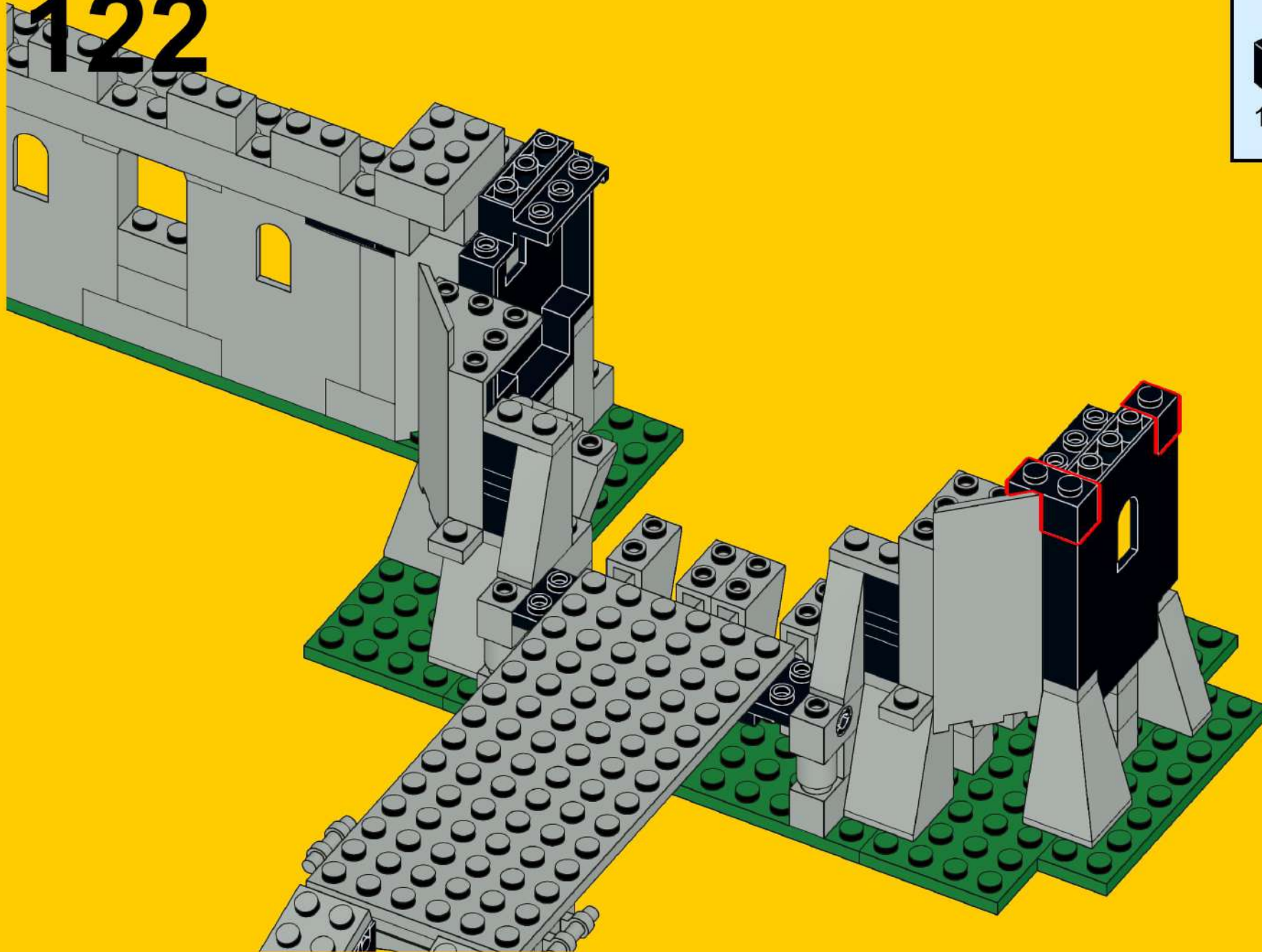



# 123

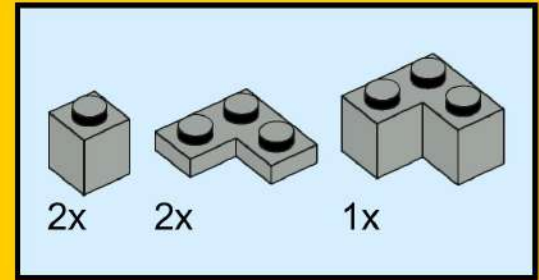
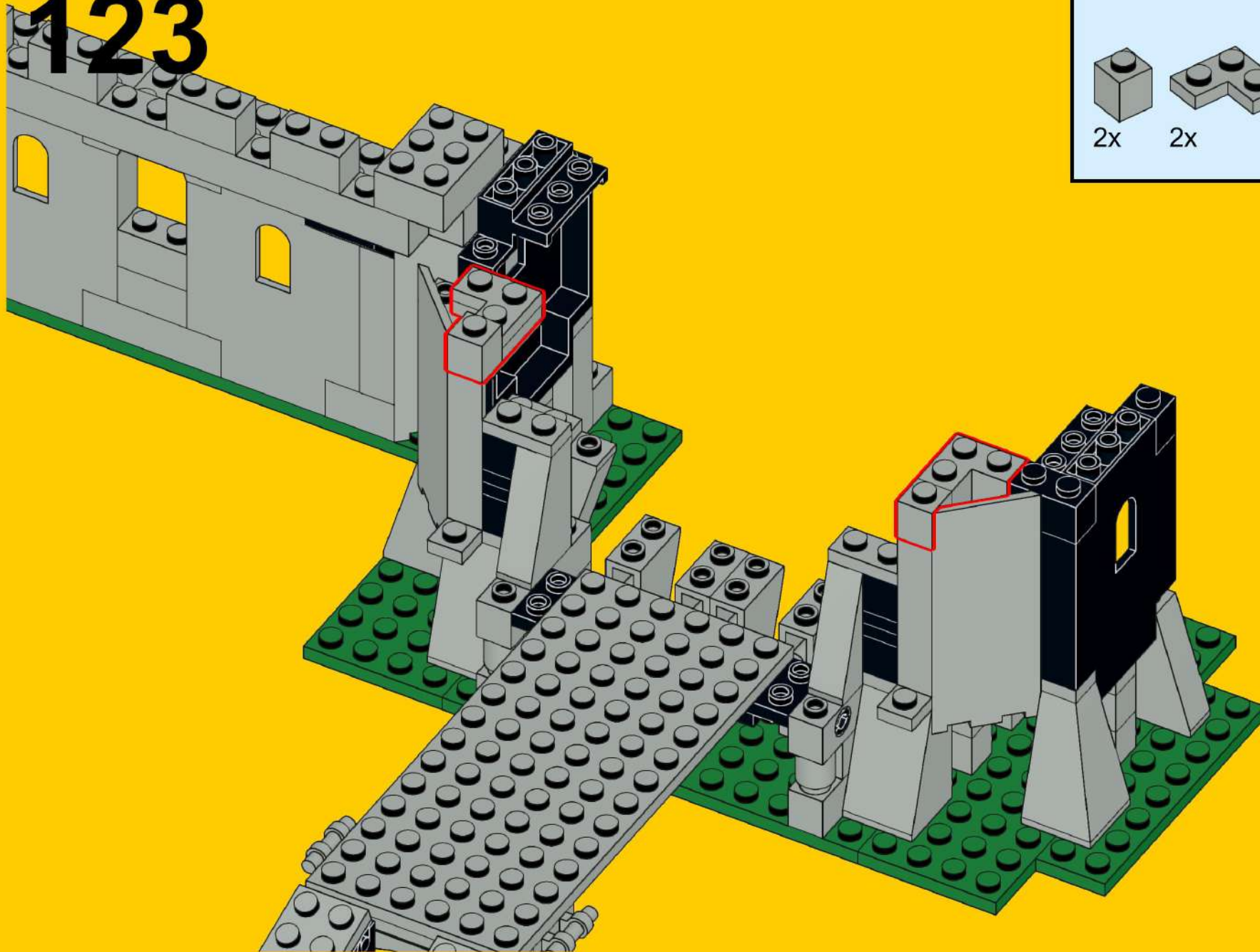

# 124

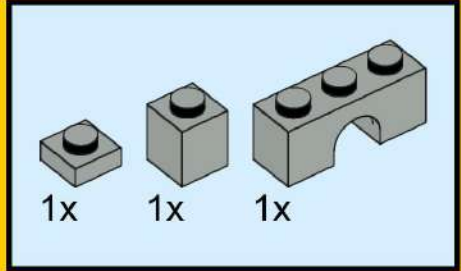
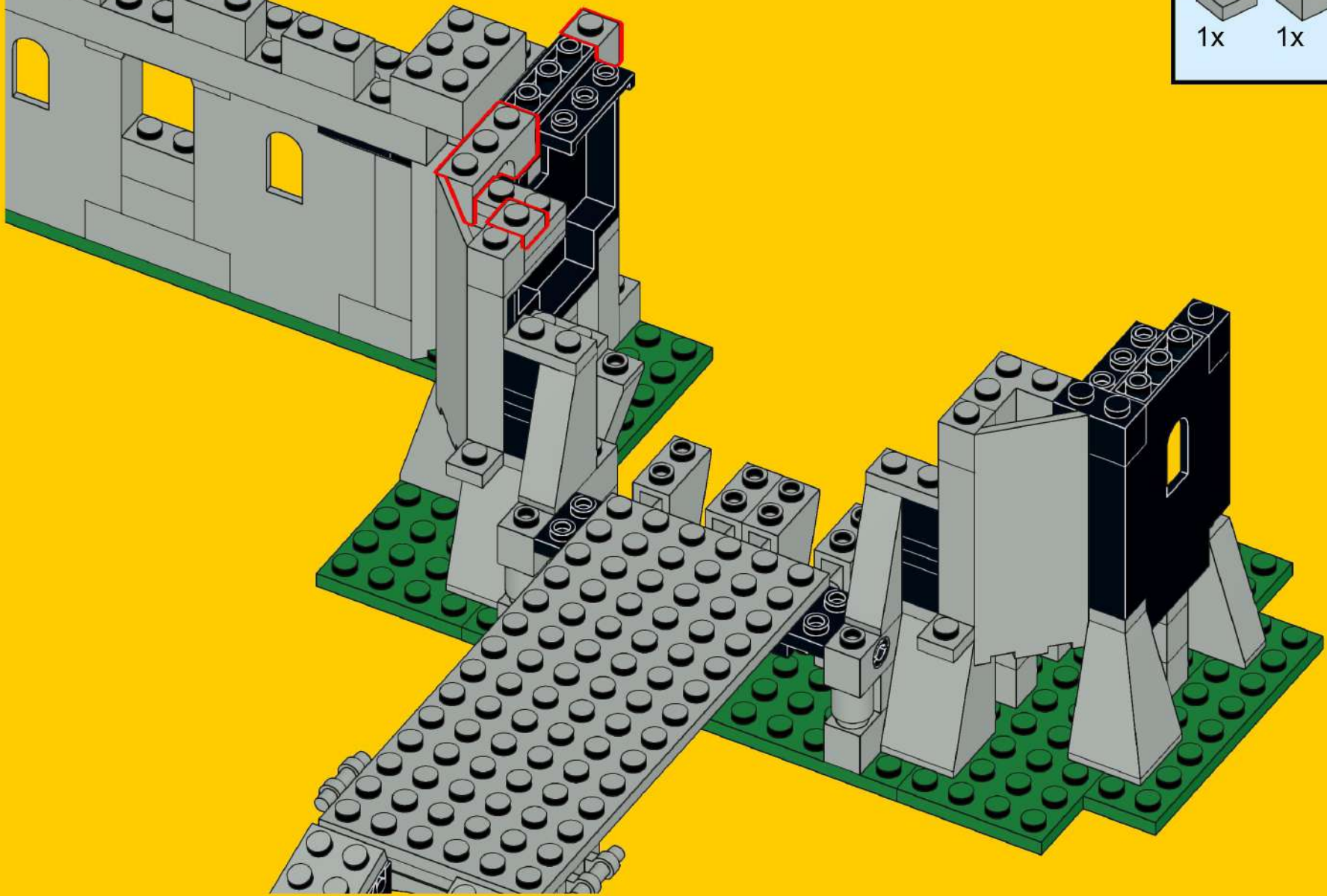

# 125

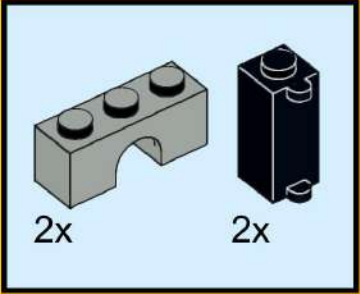
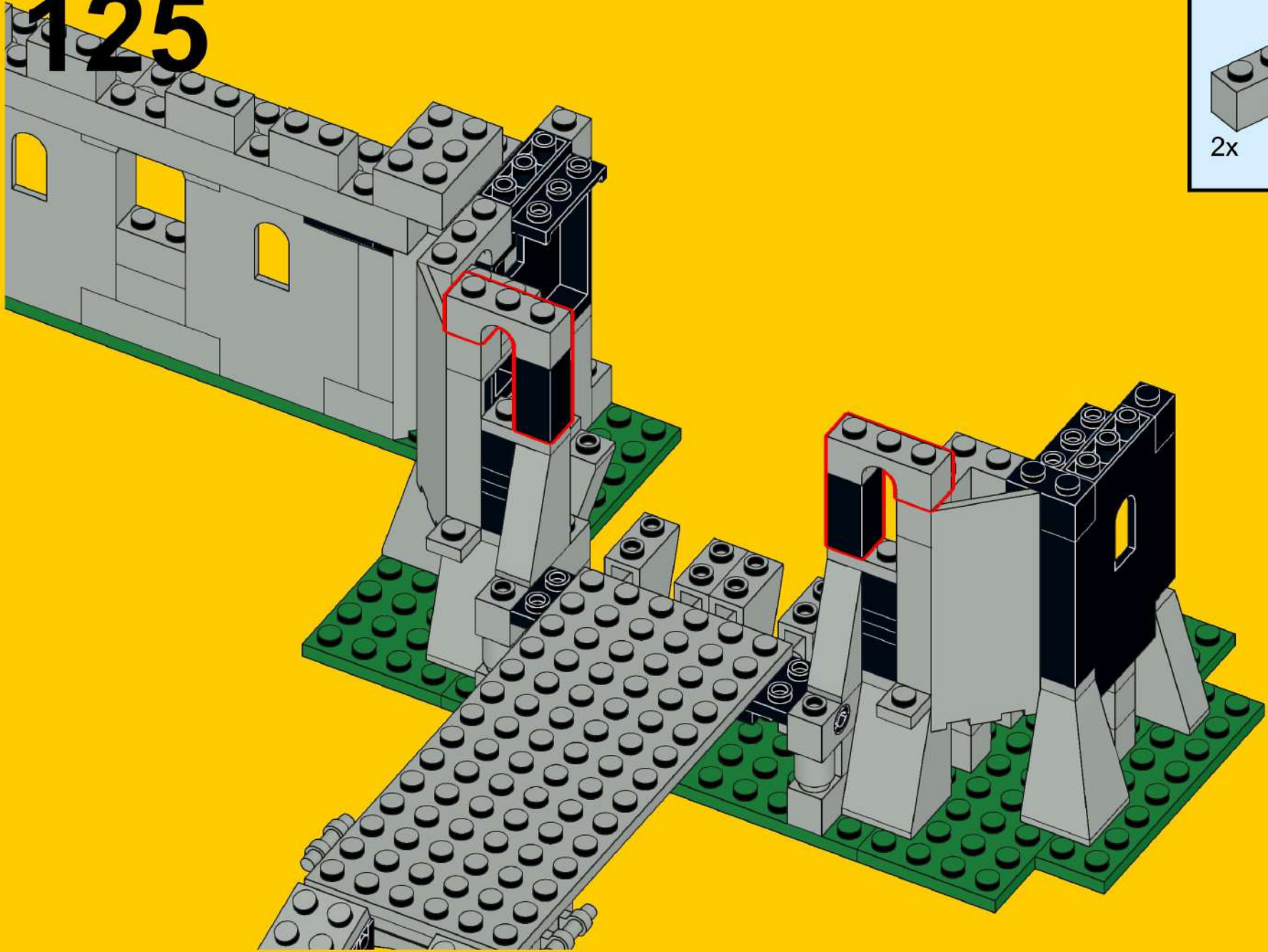

# 126

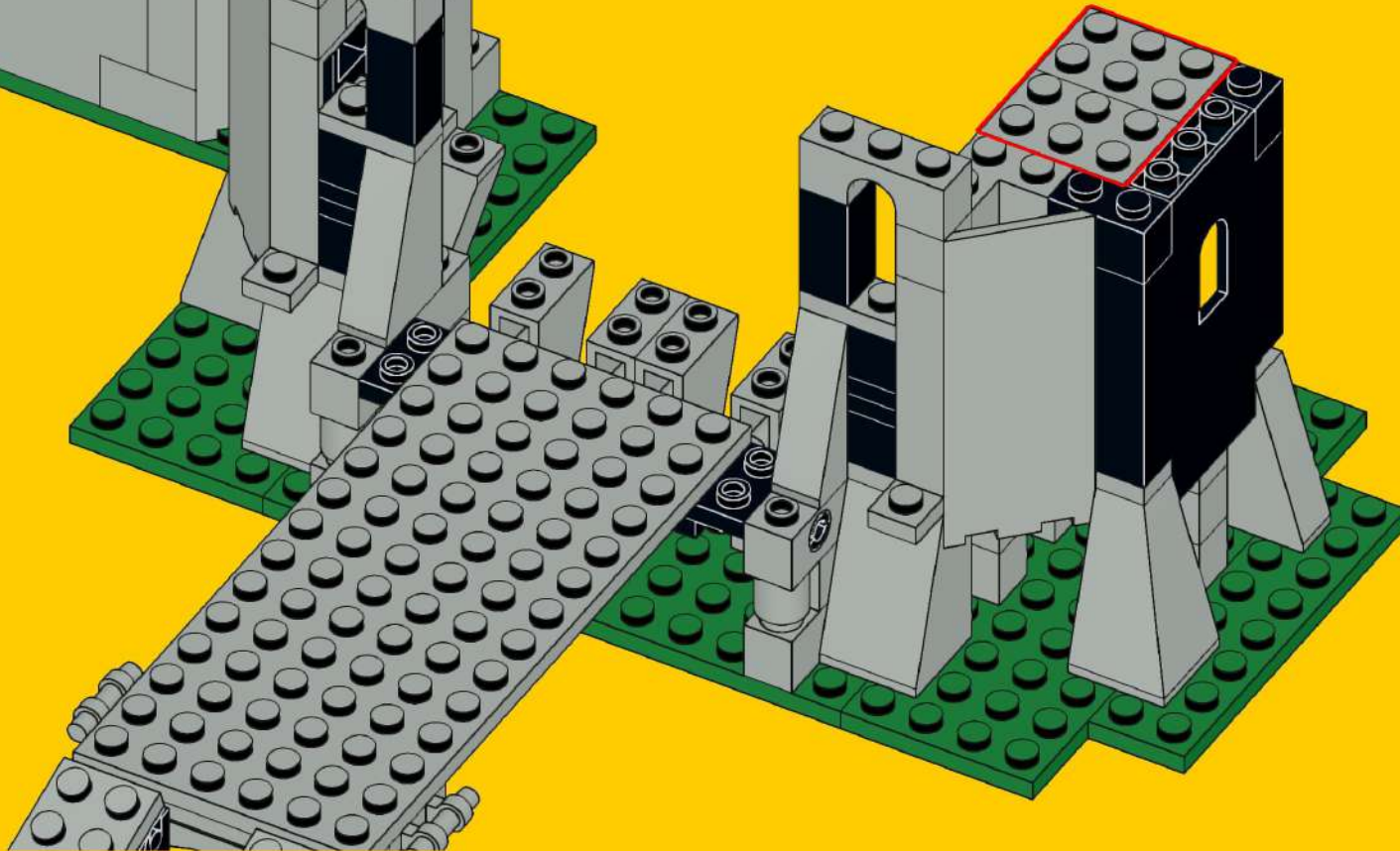
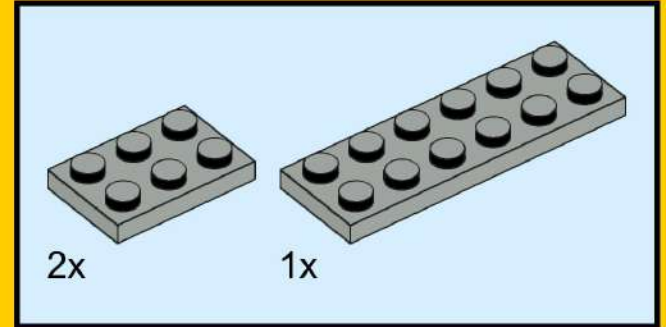
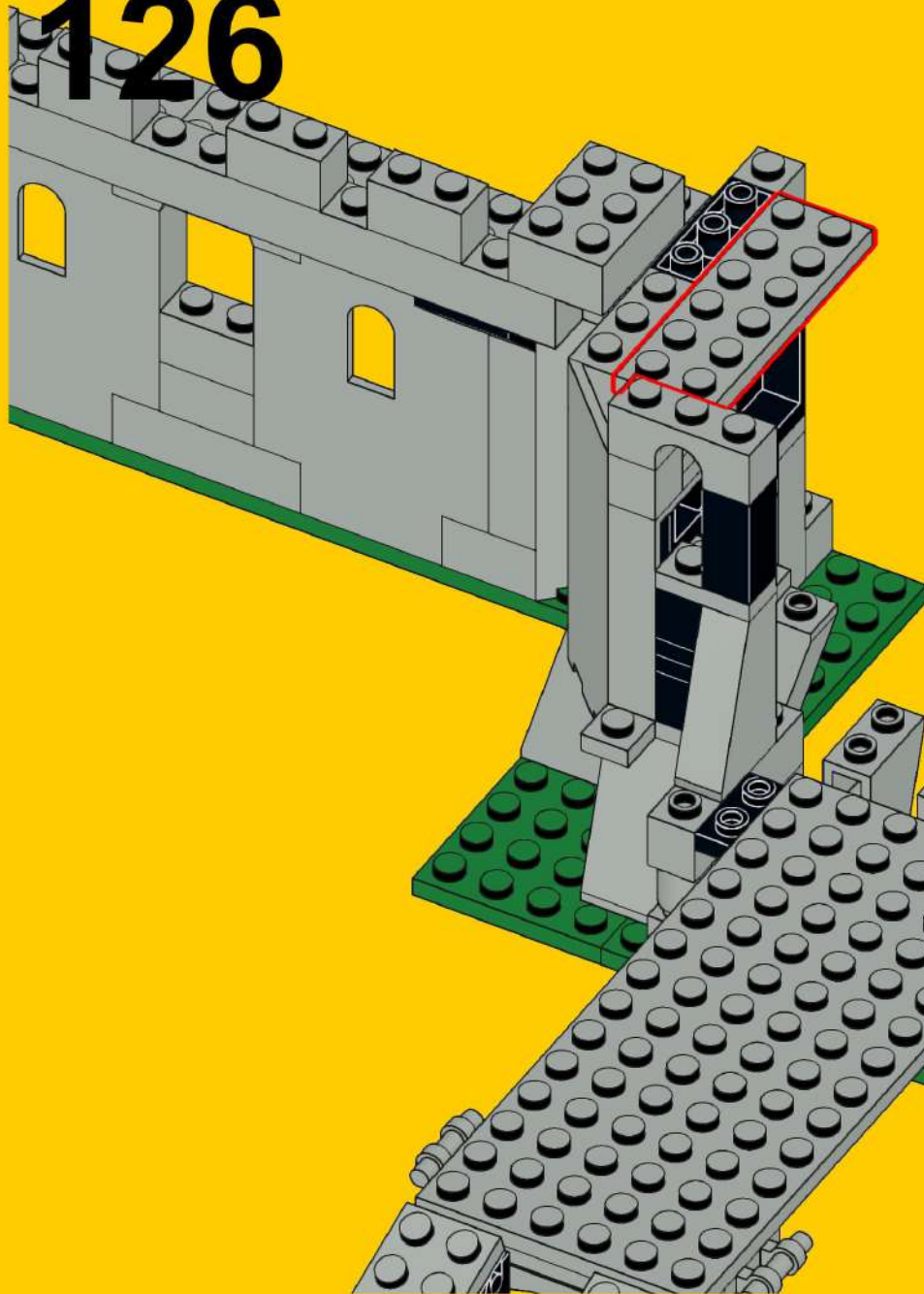

# 127

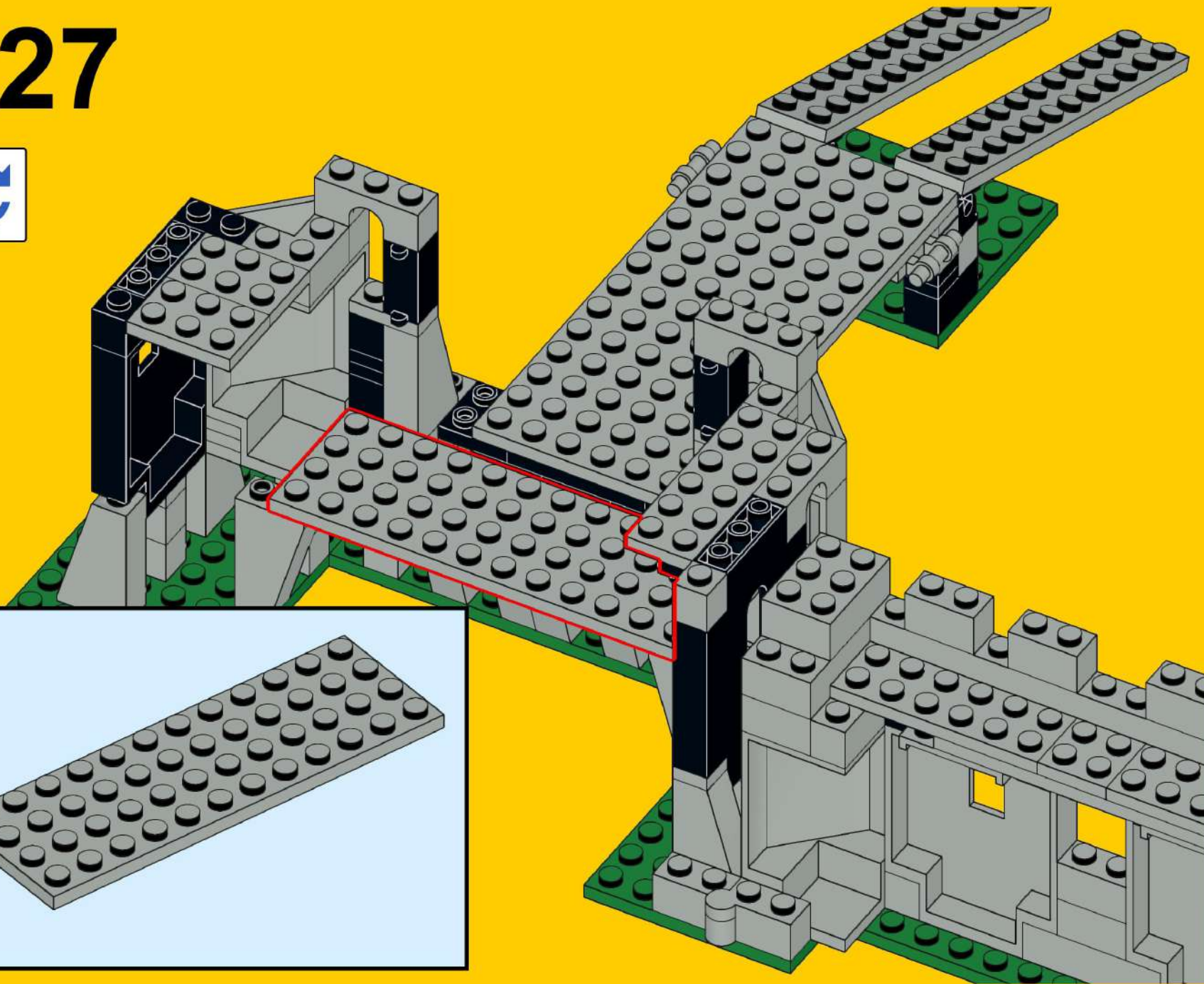
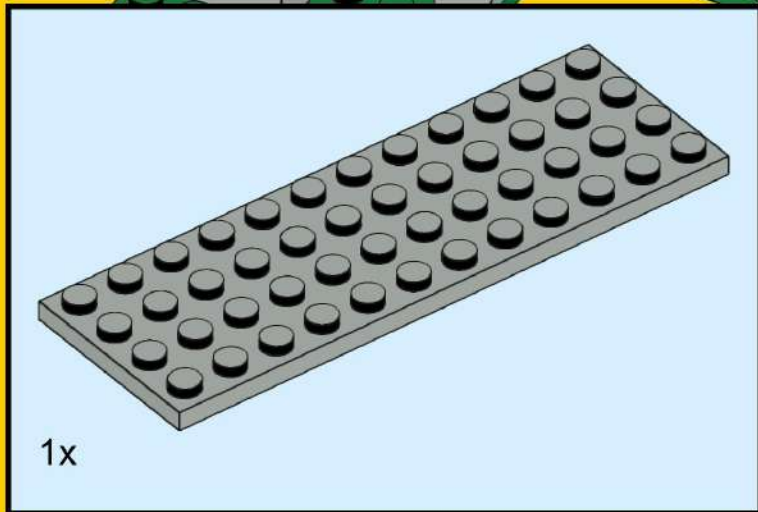

# 128

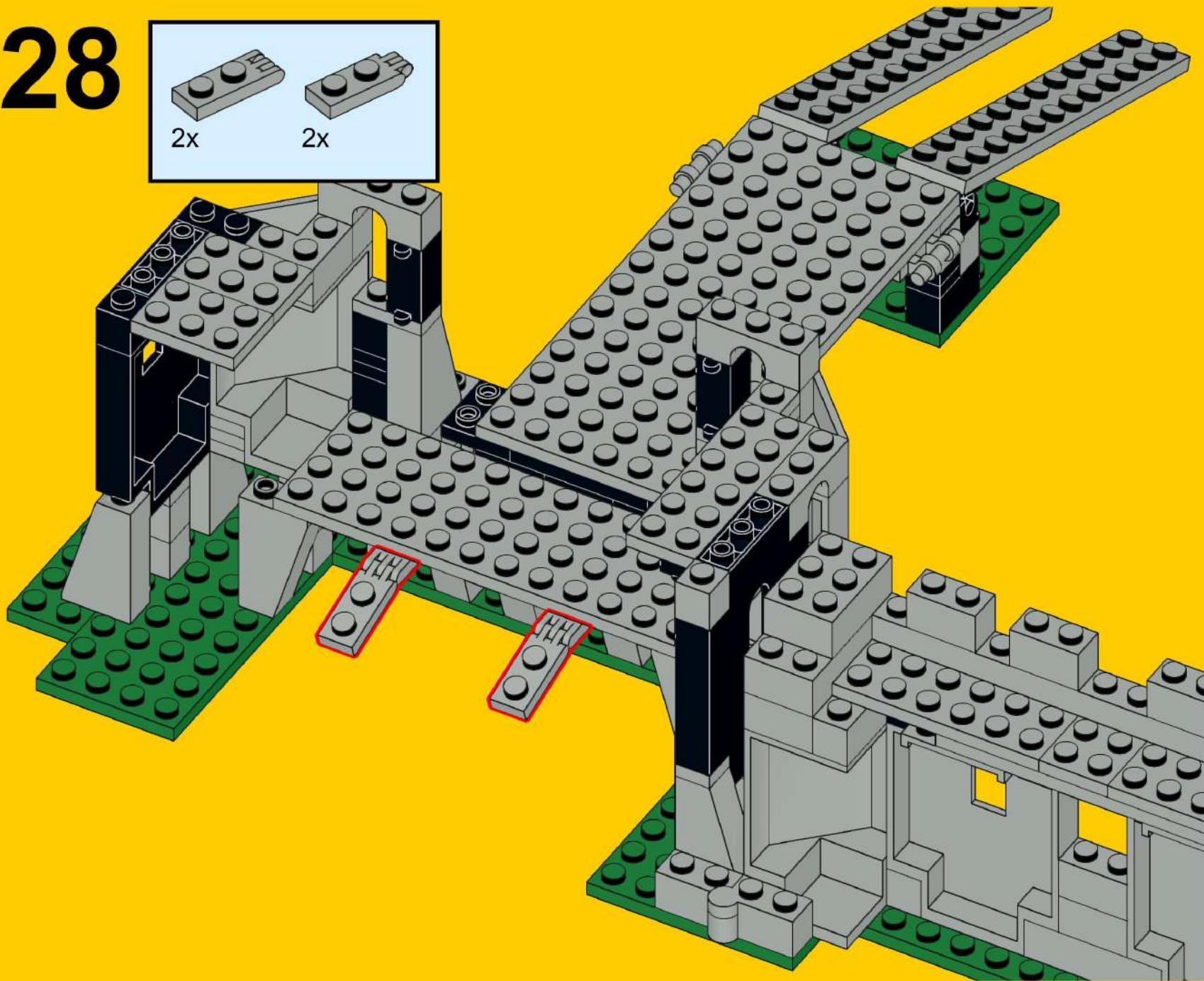
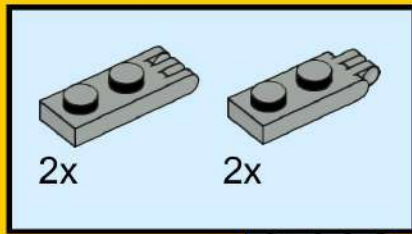

# 129

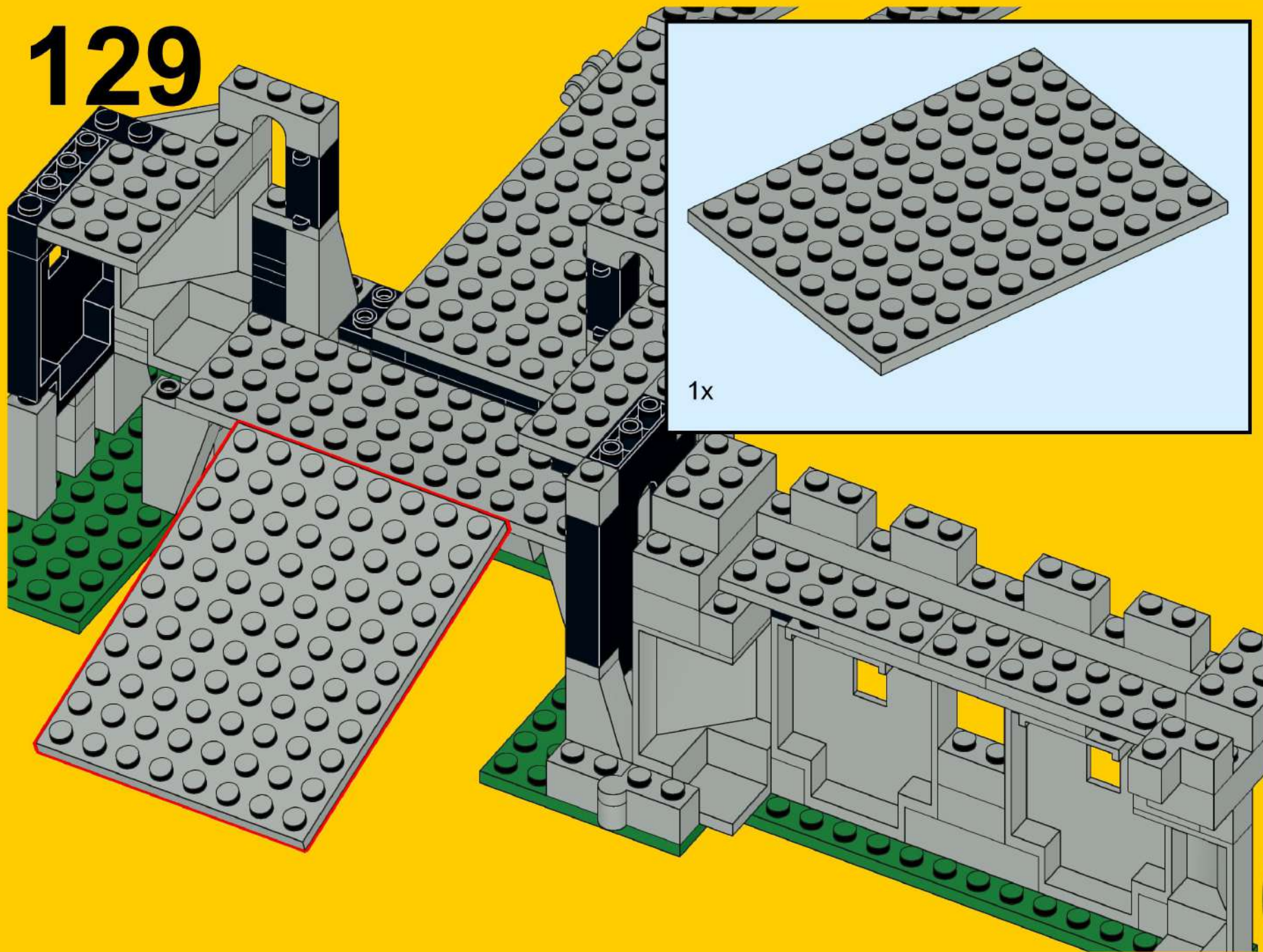

# 130

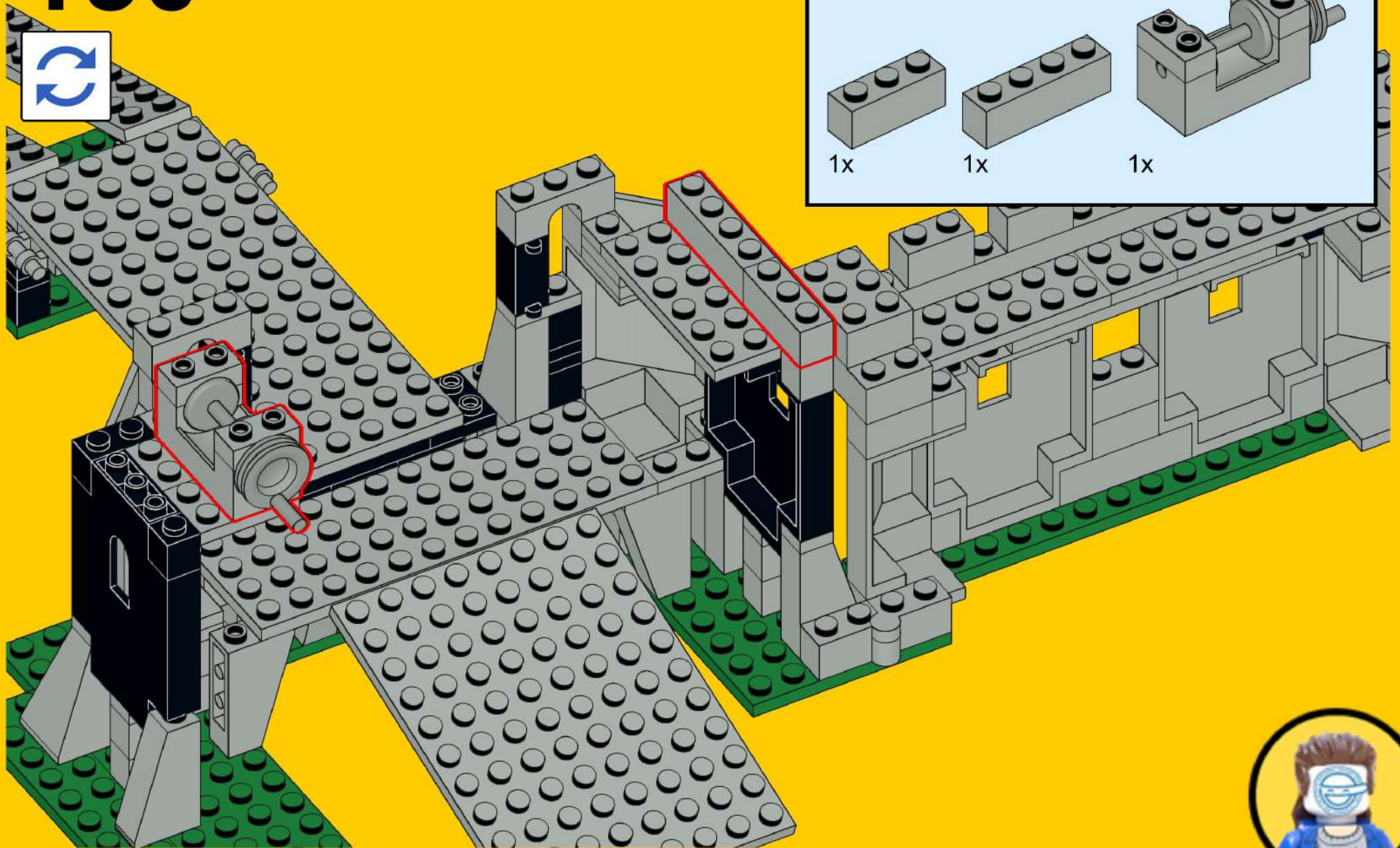



# 131

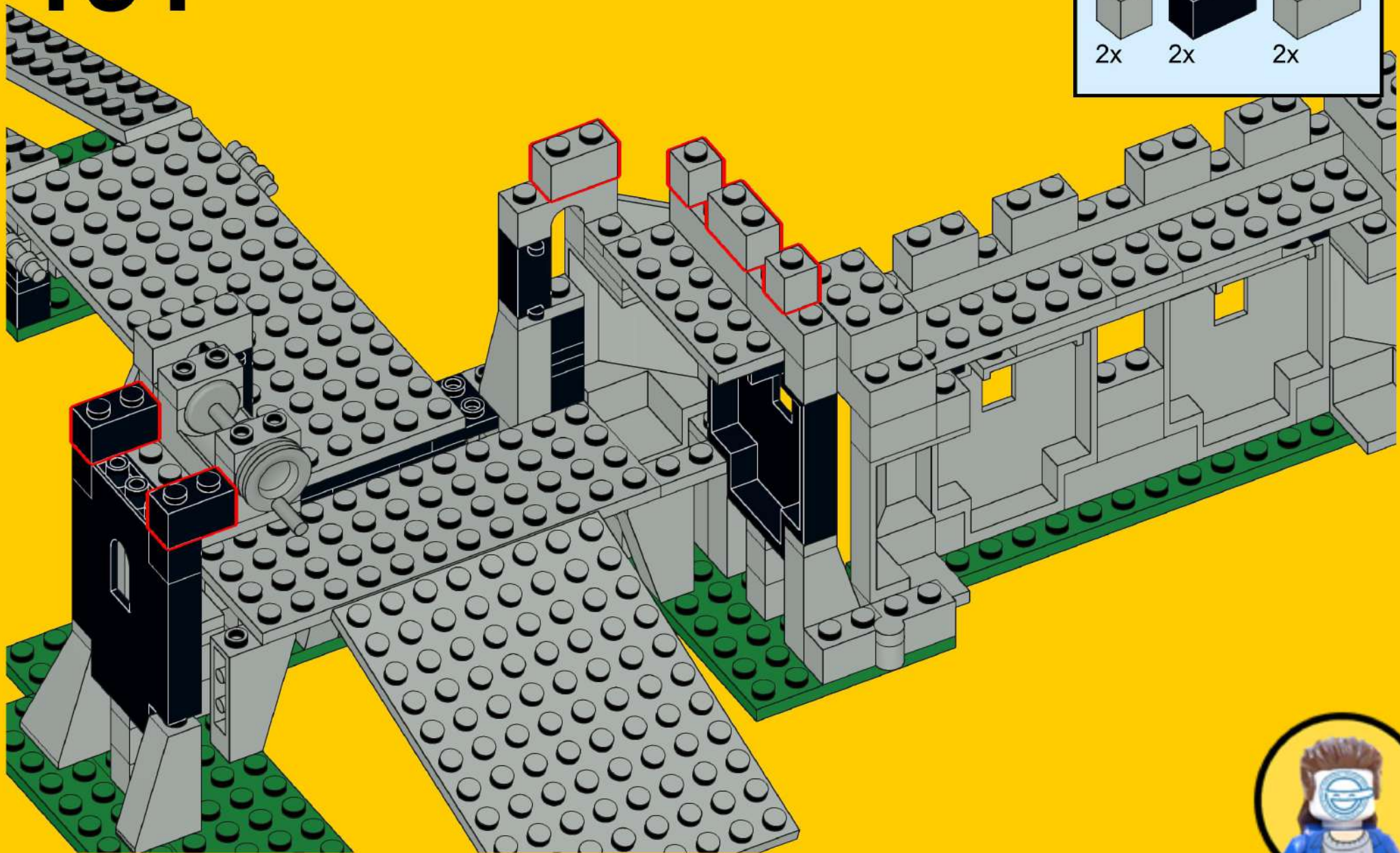
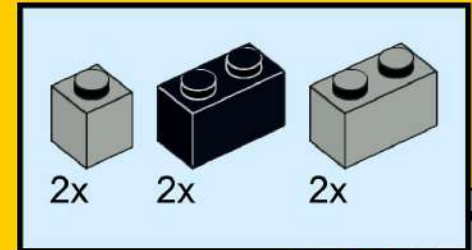

# 132

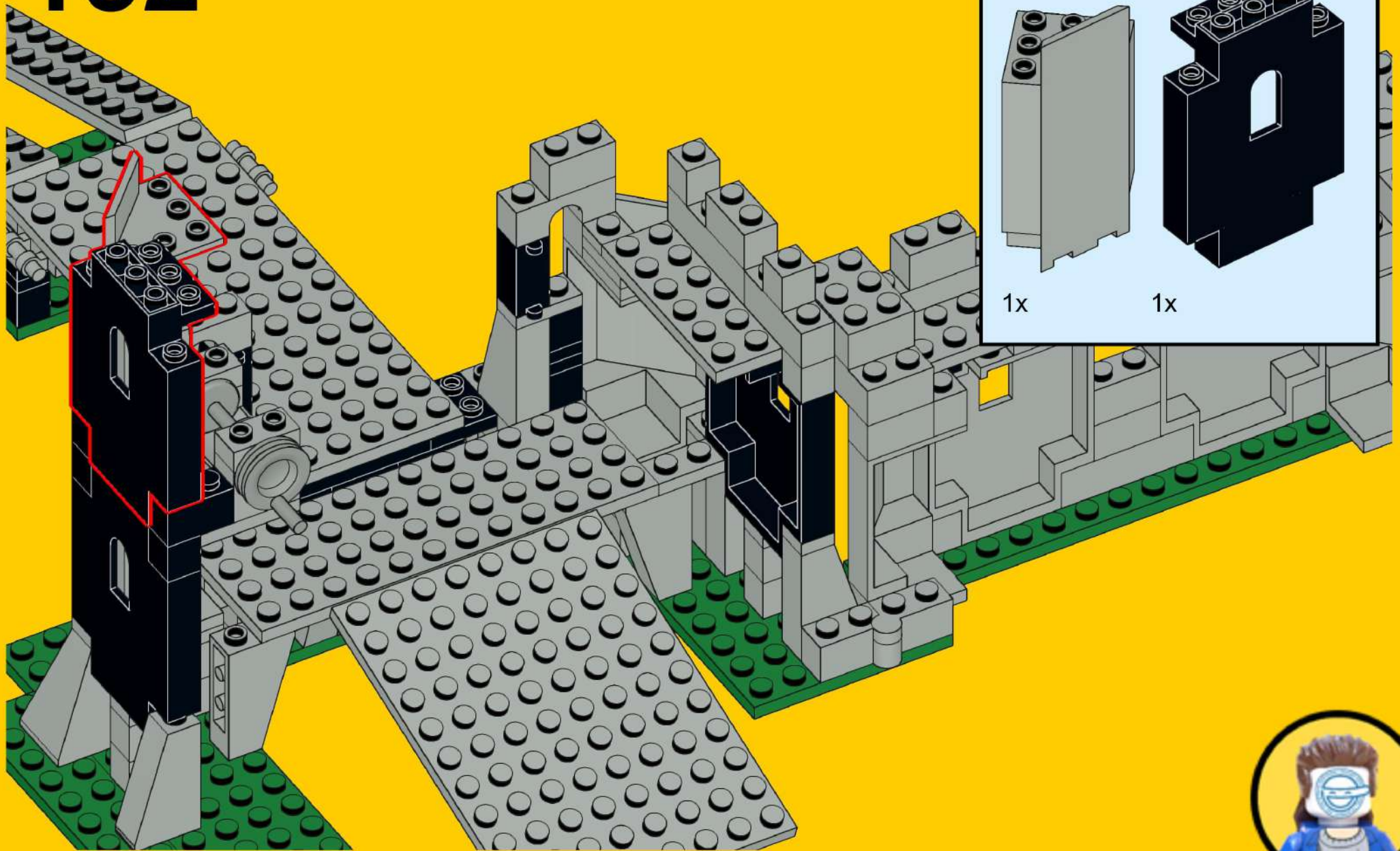

# 133

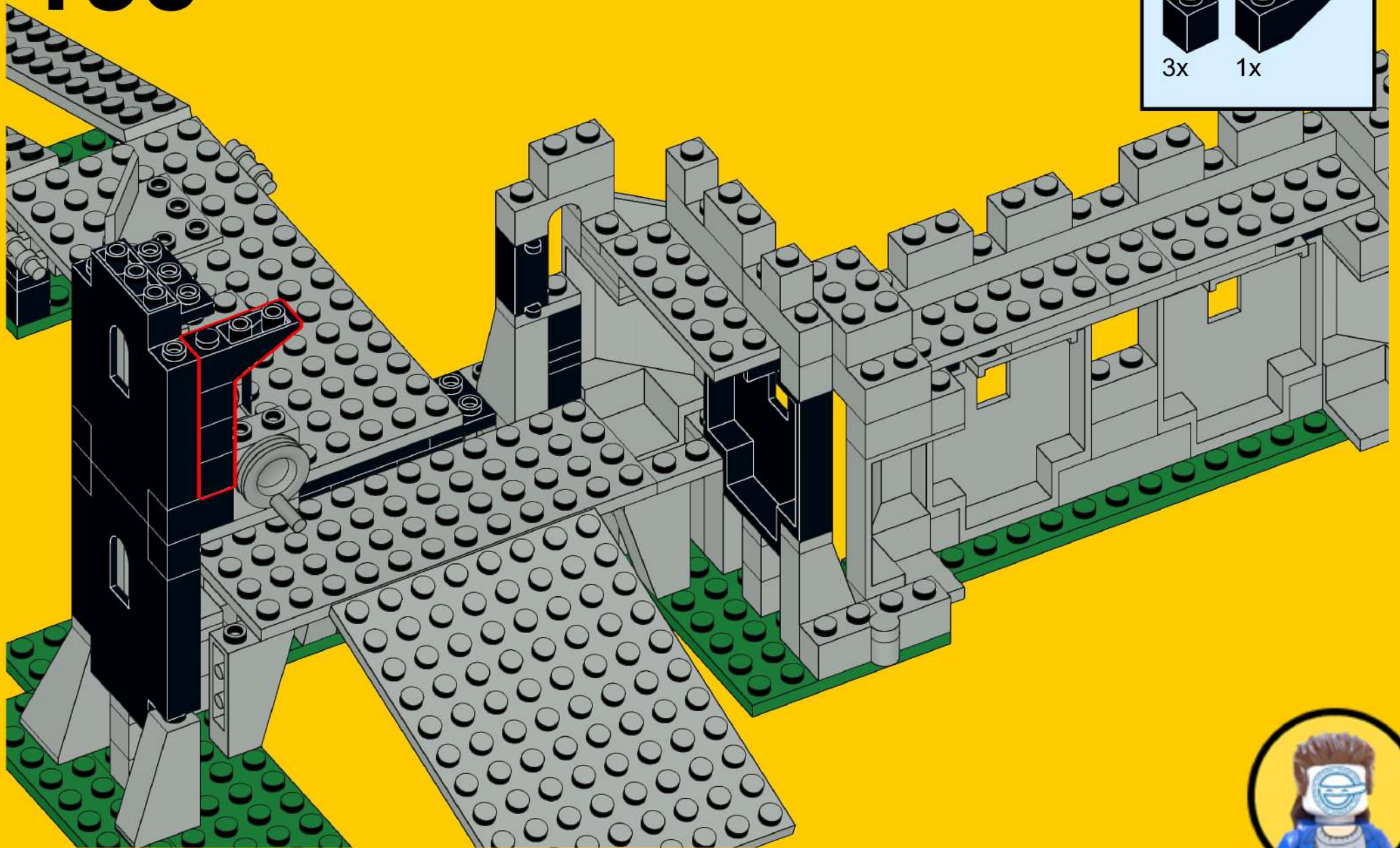
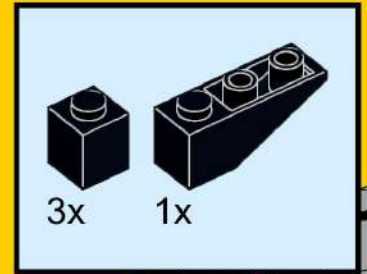

# 134

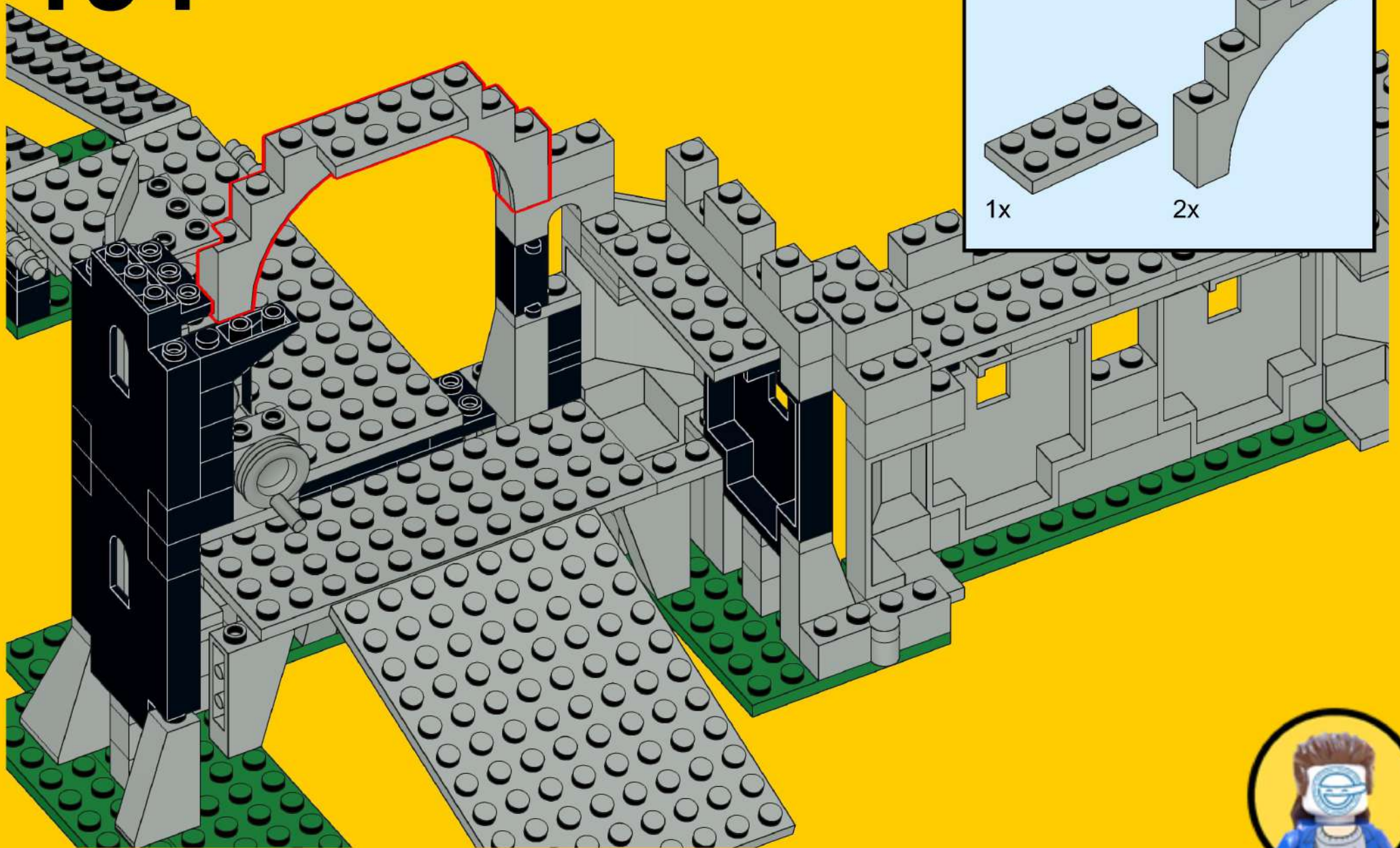

# 135

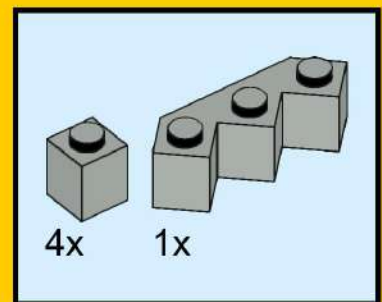
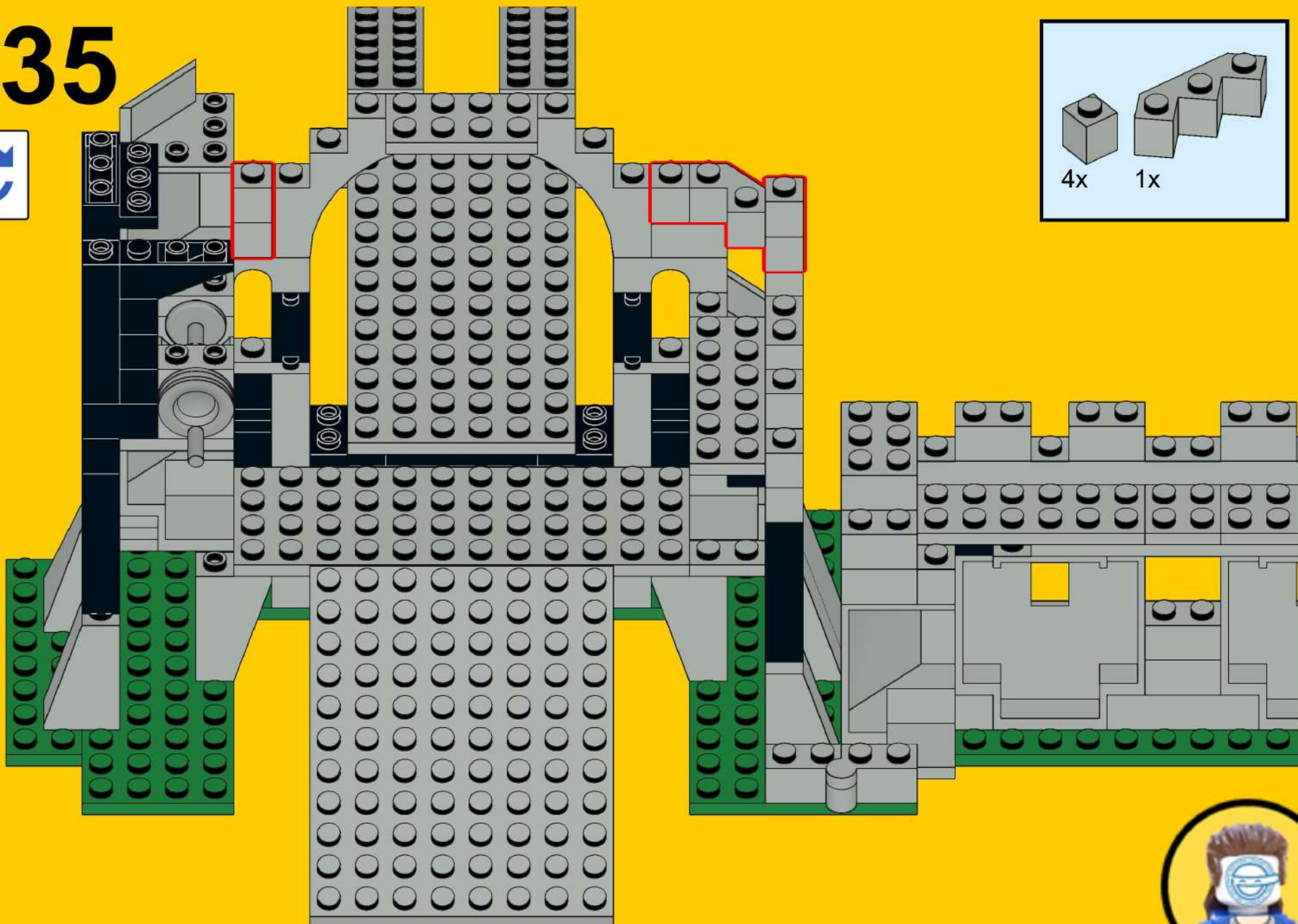

# 136

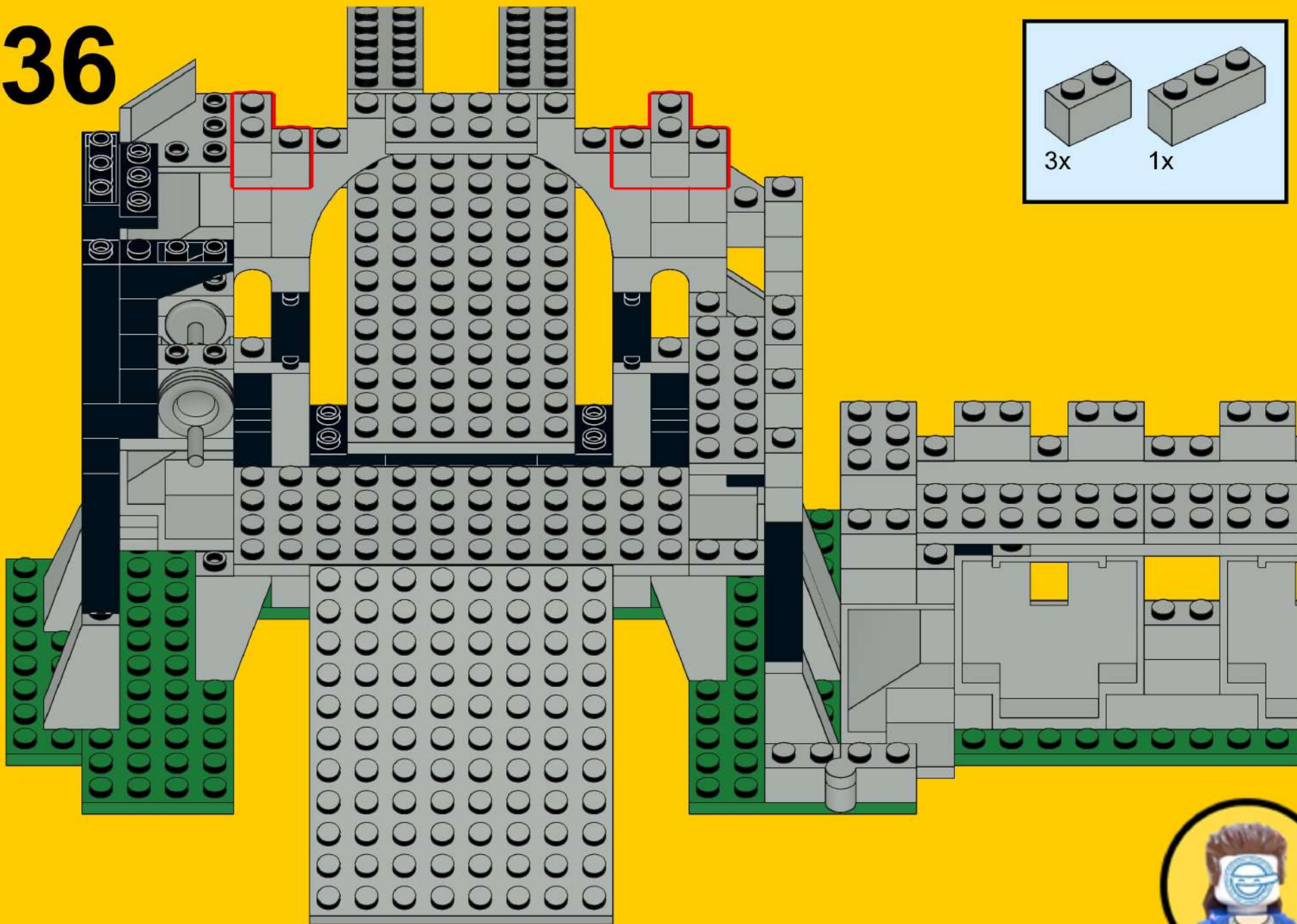

# 137

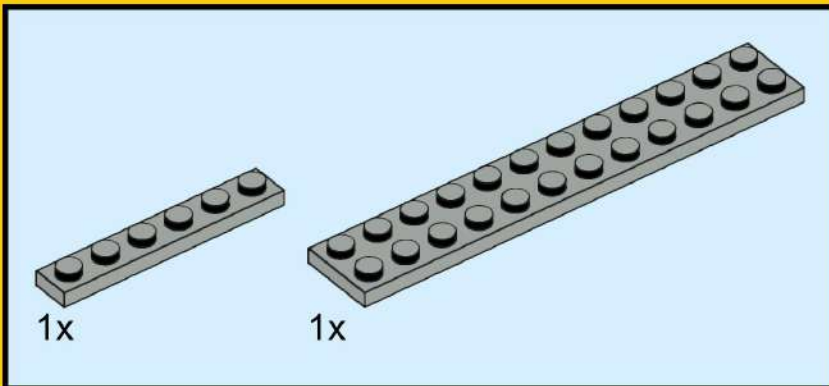
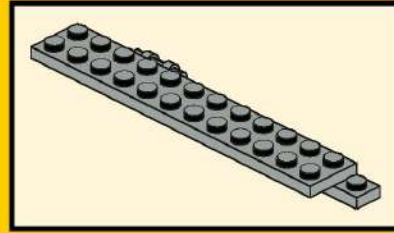

# 138

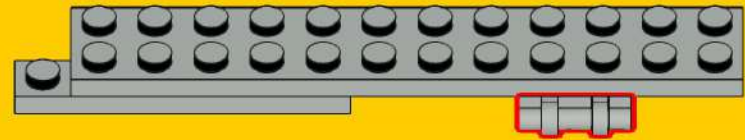
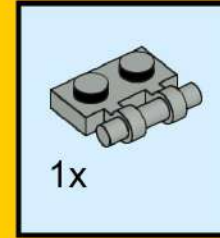

# 139

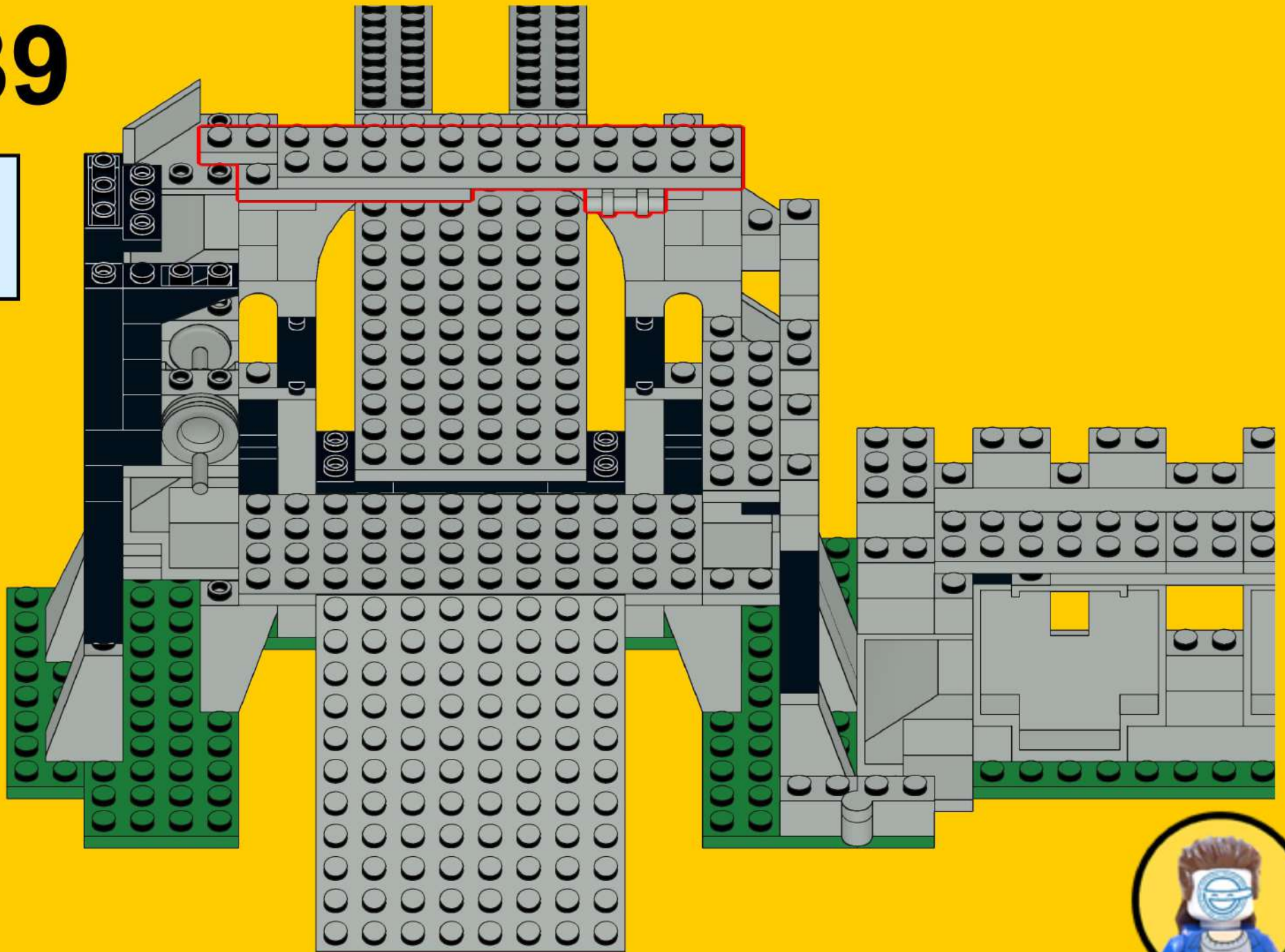
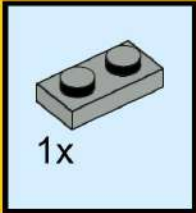



# 140

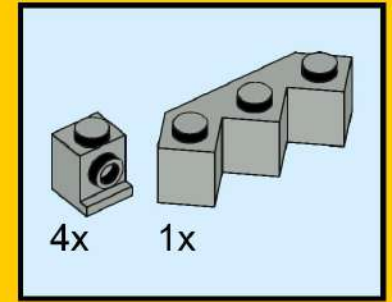
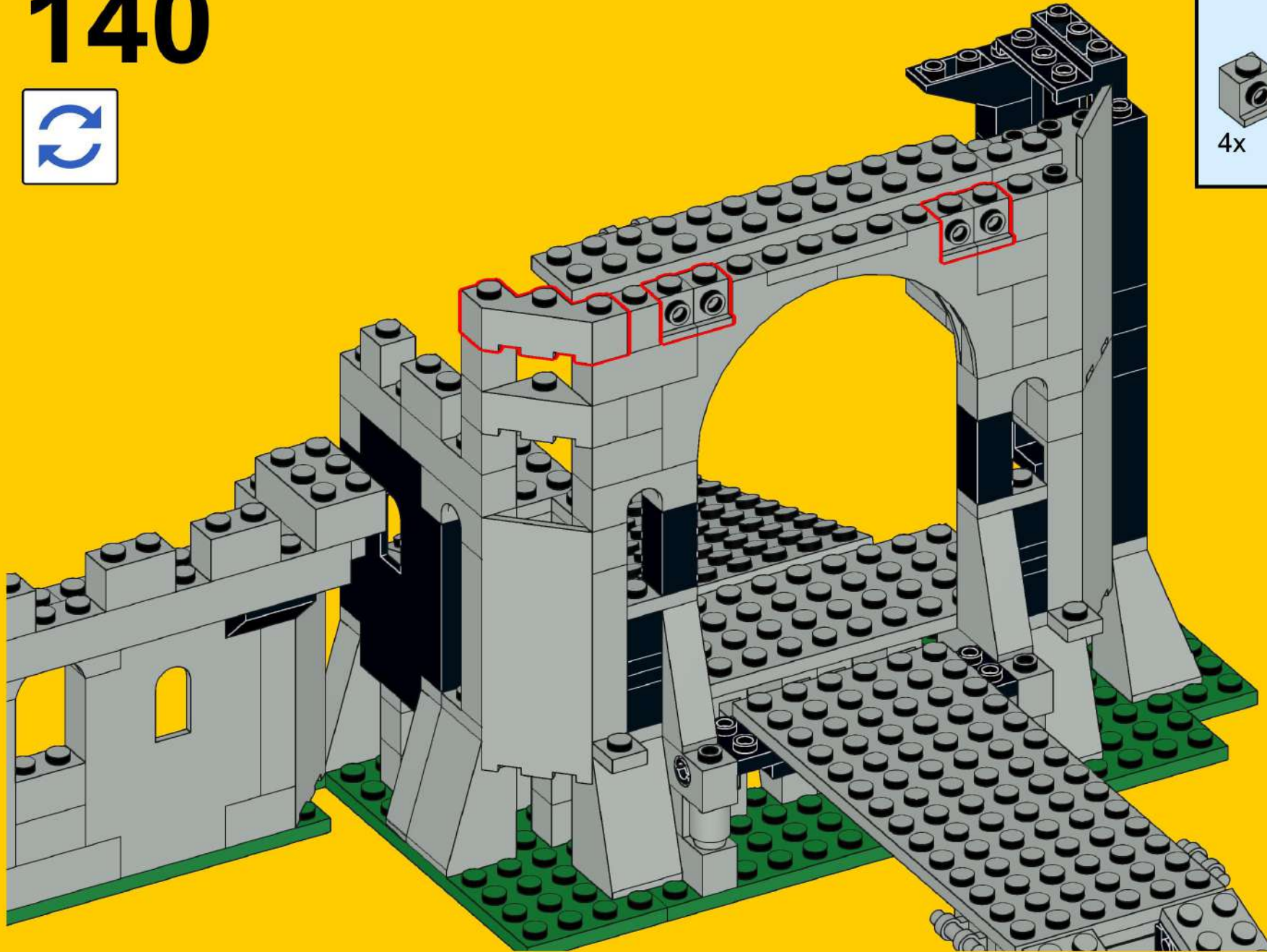

# 141

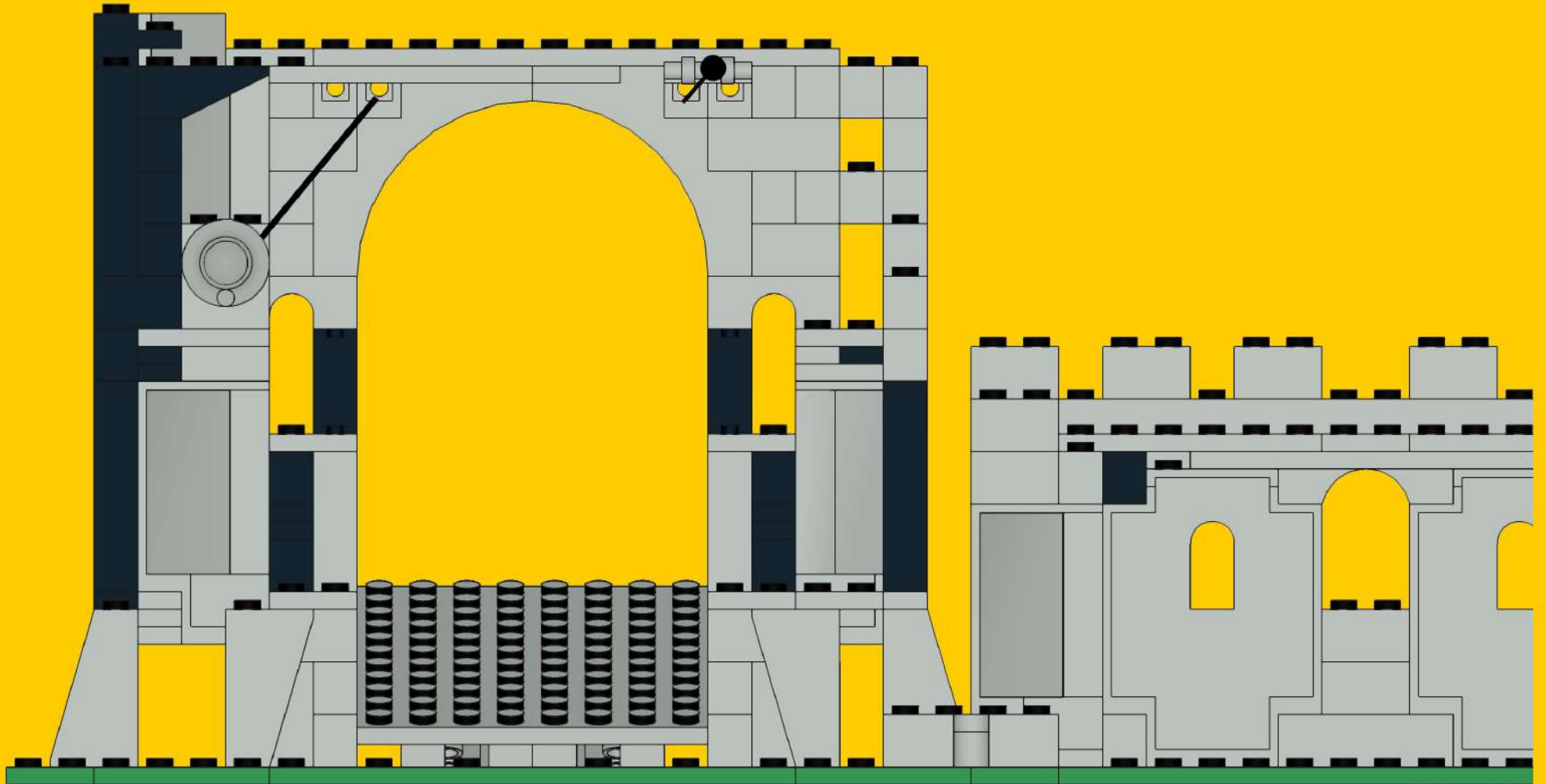

# 142

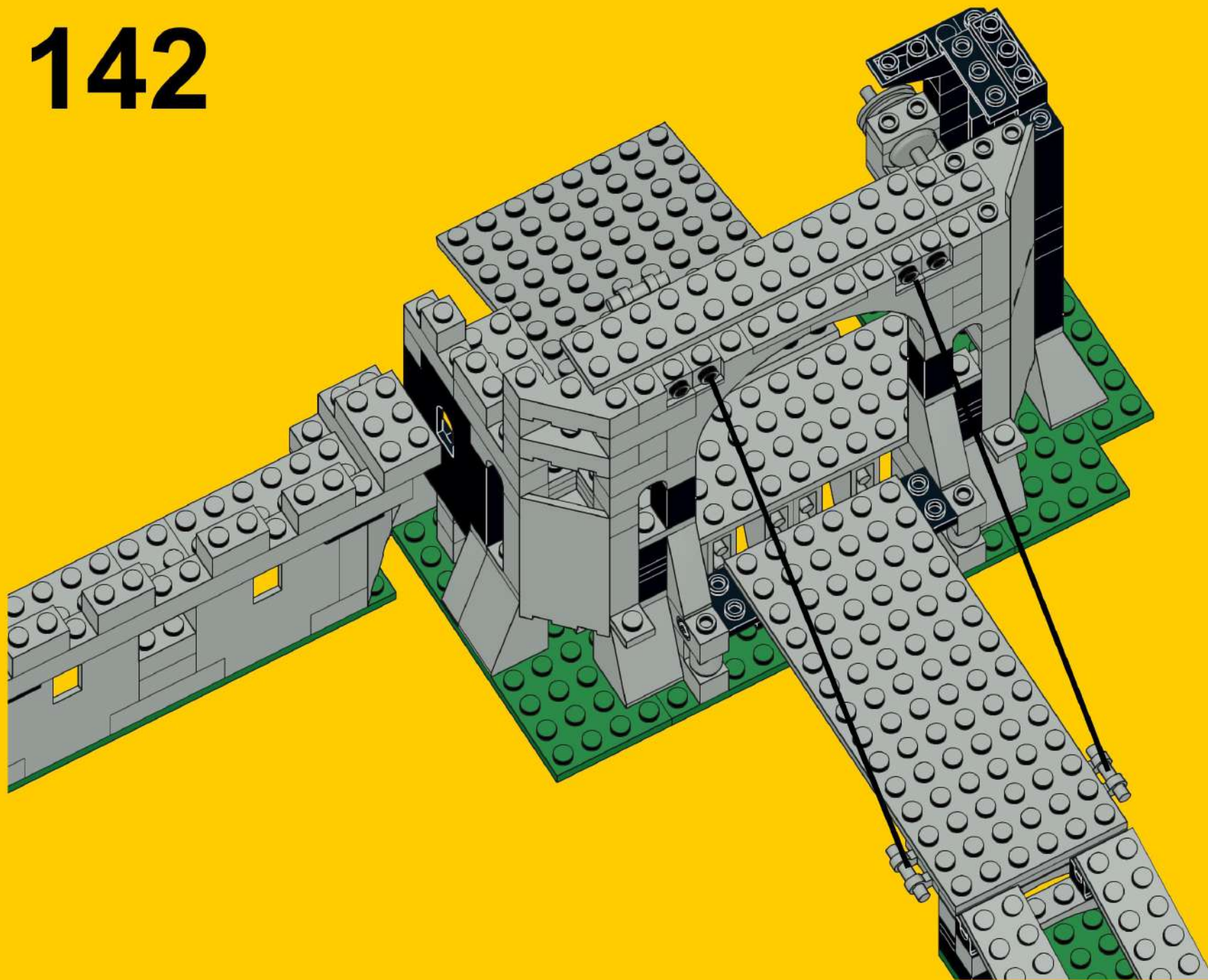

# 143

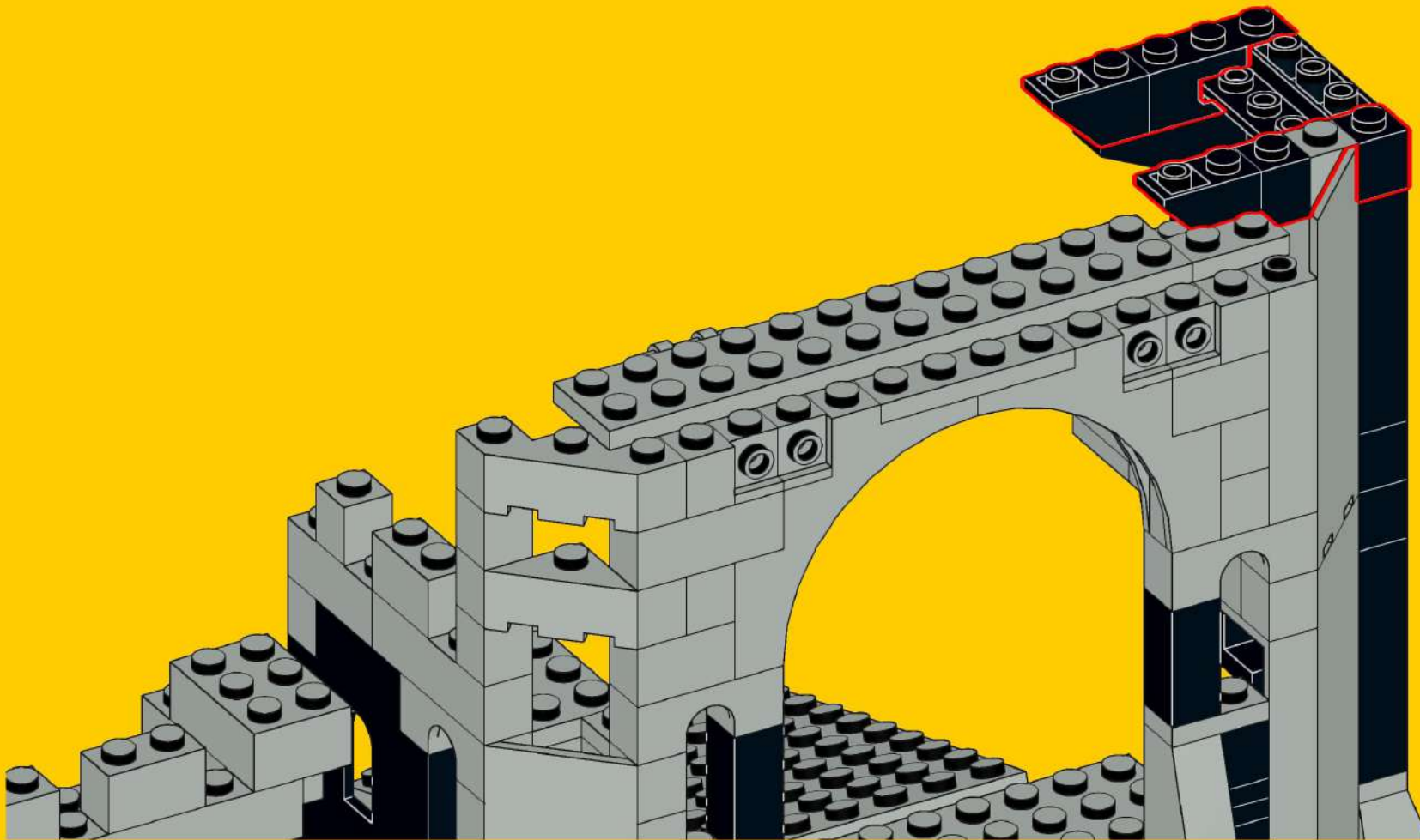
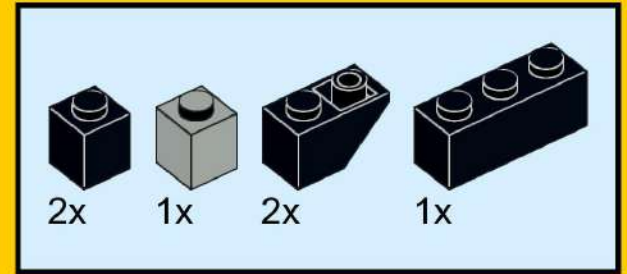

# 144

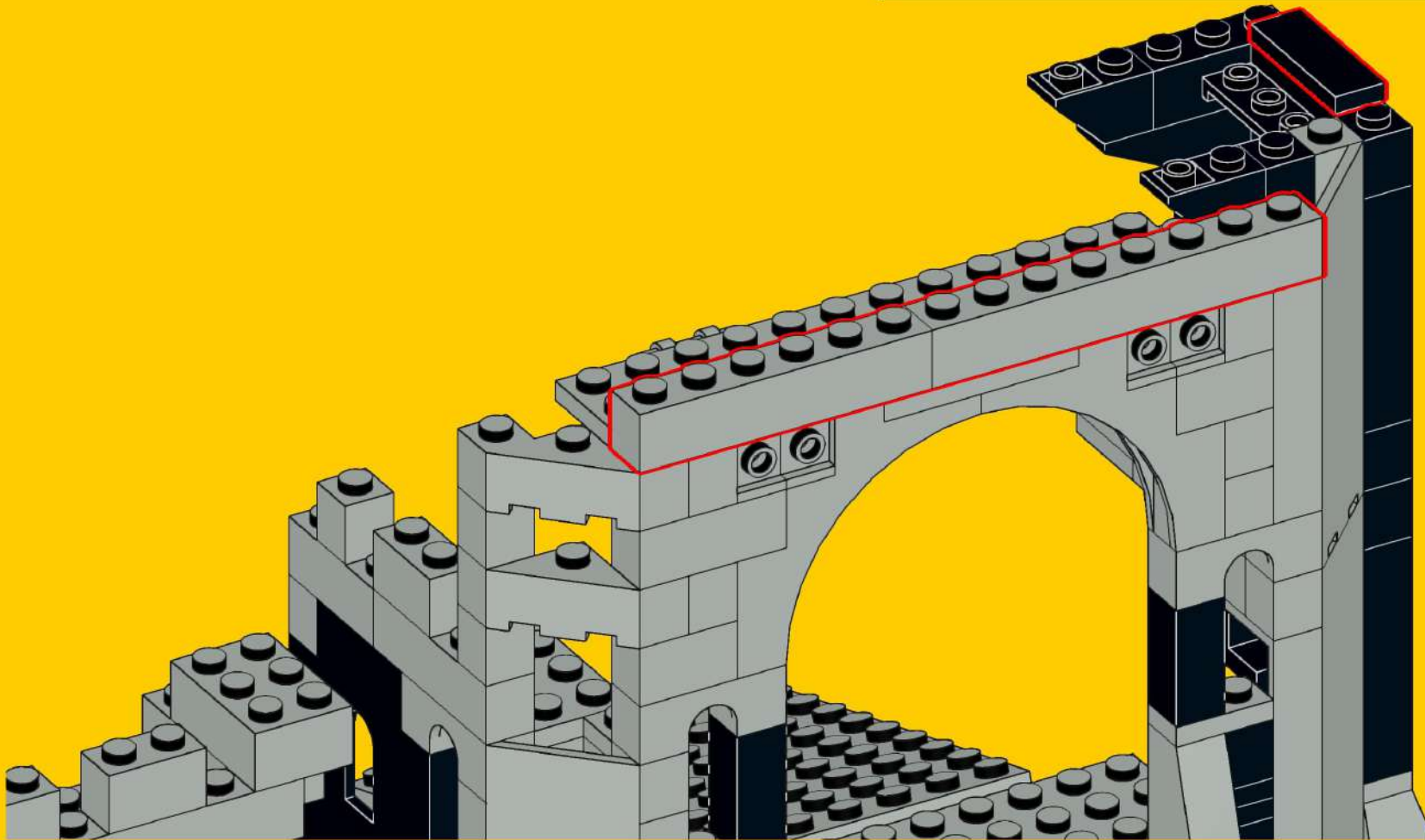
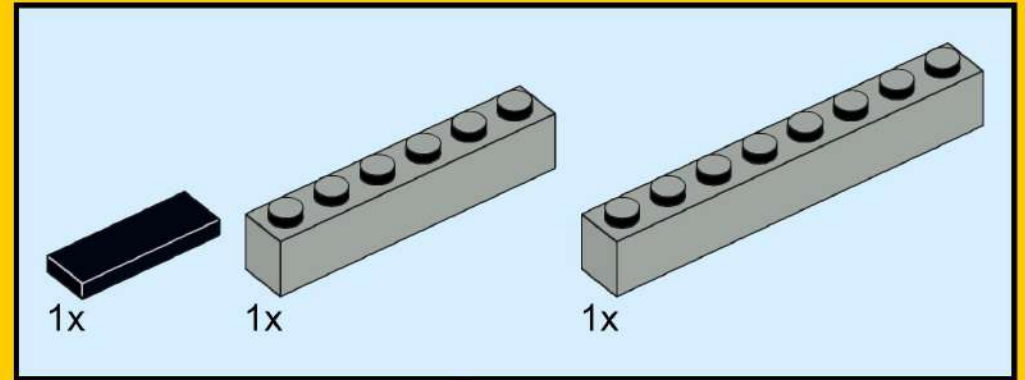

# 145

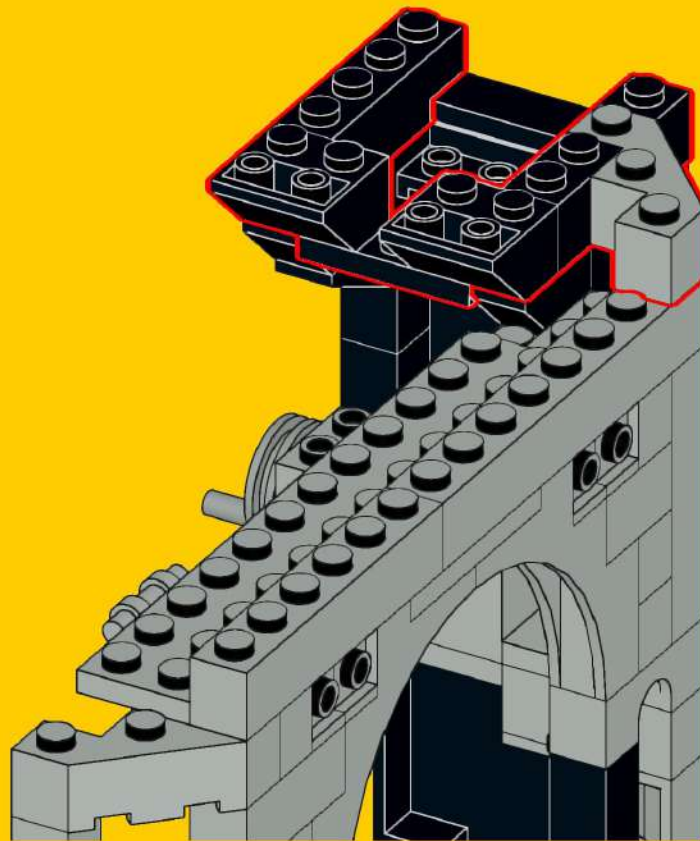
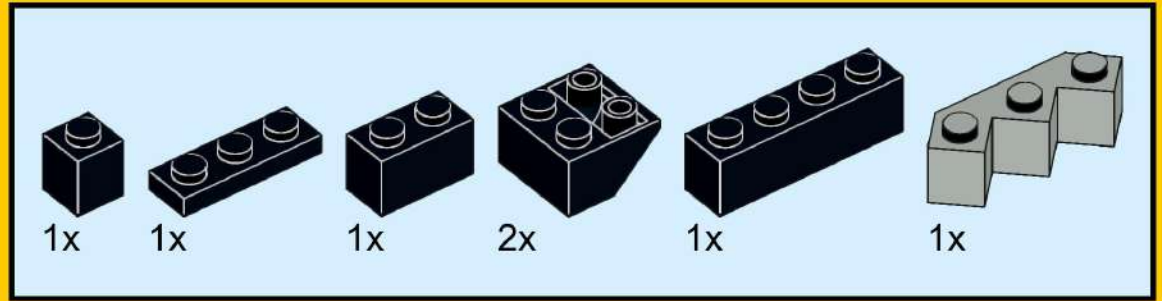

# 146

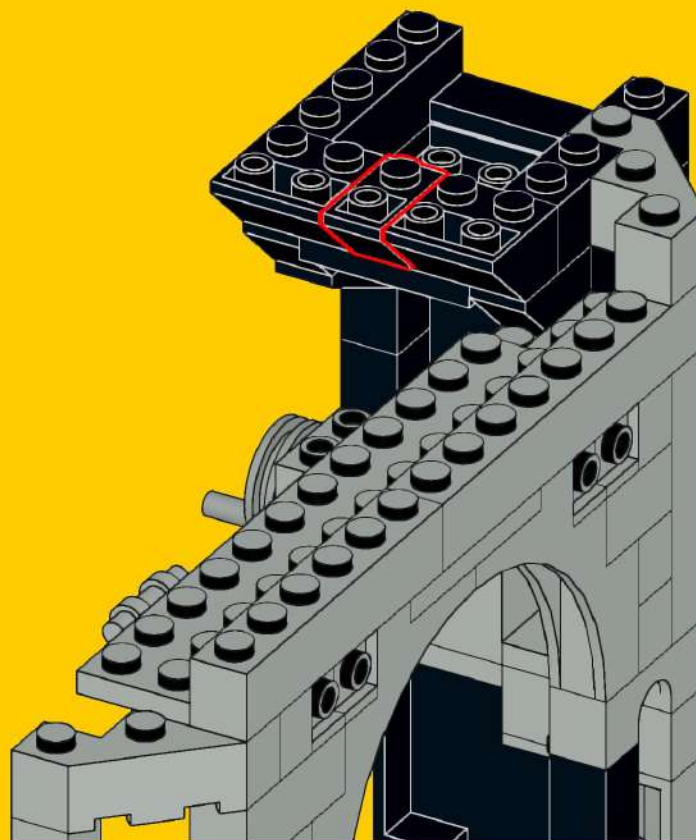
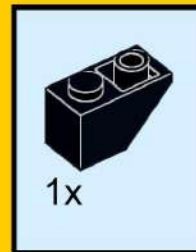

# 147

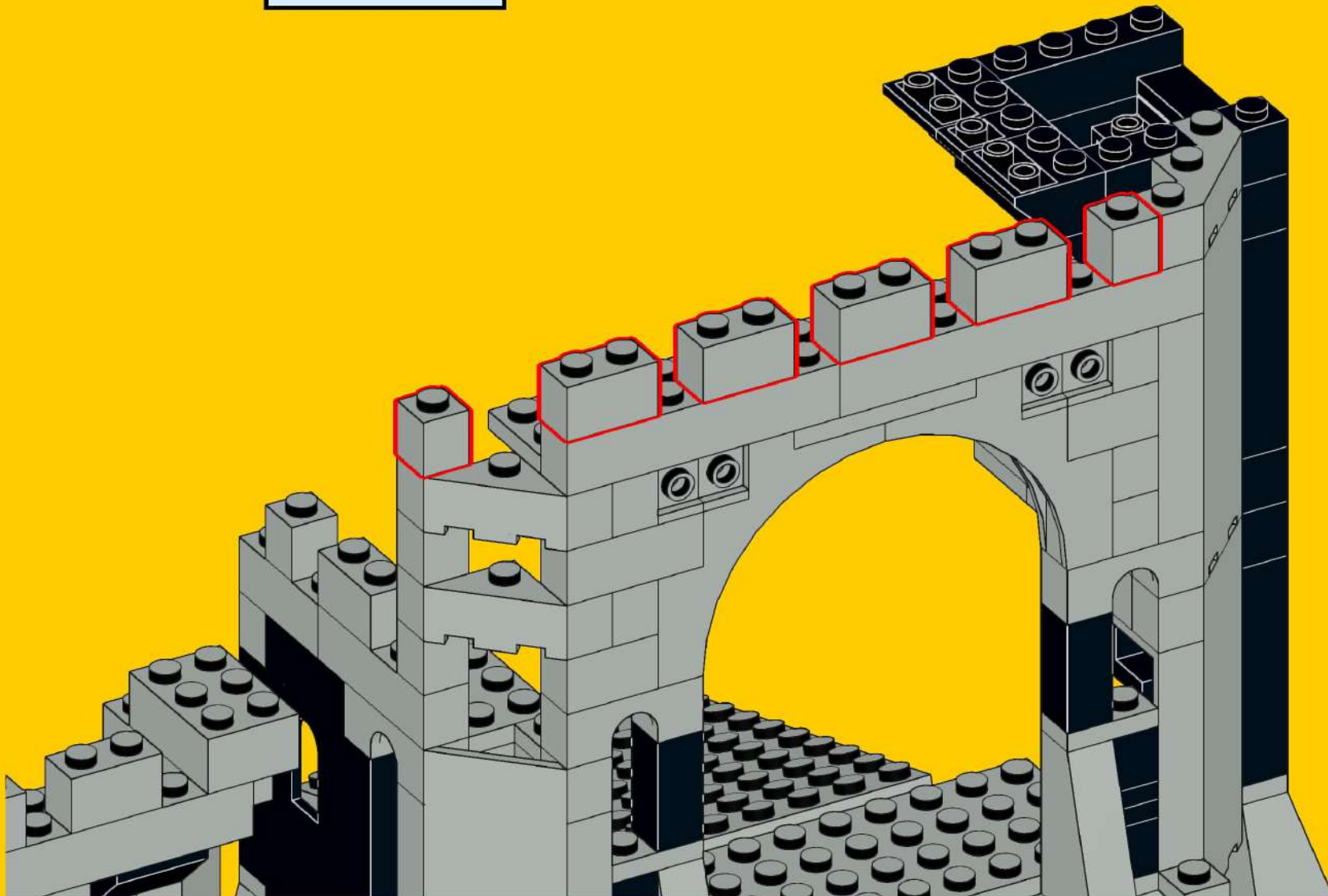
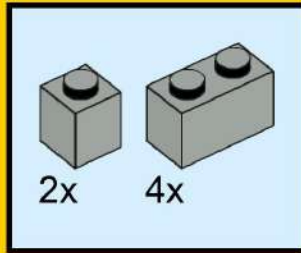



# 148

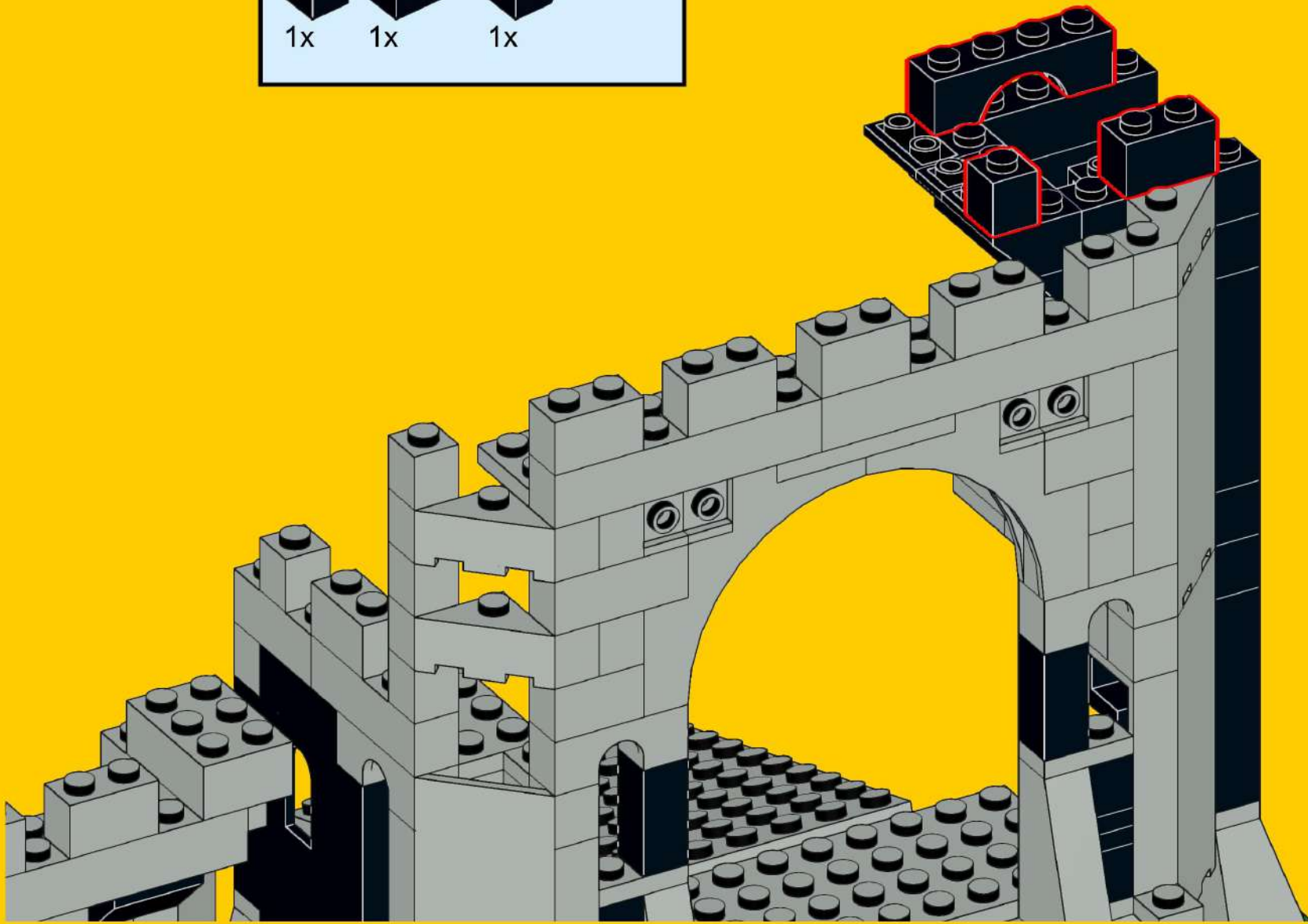
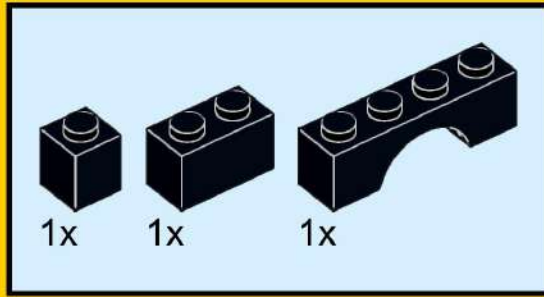

# 149

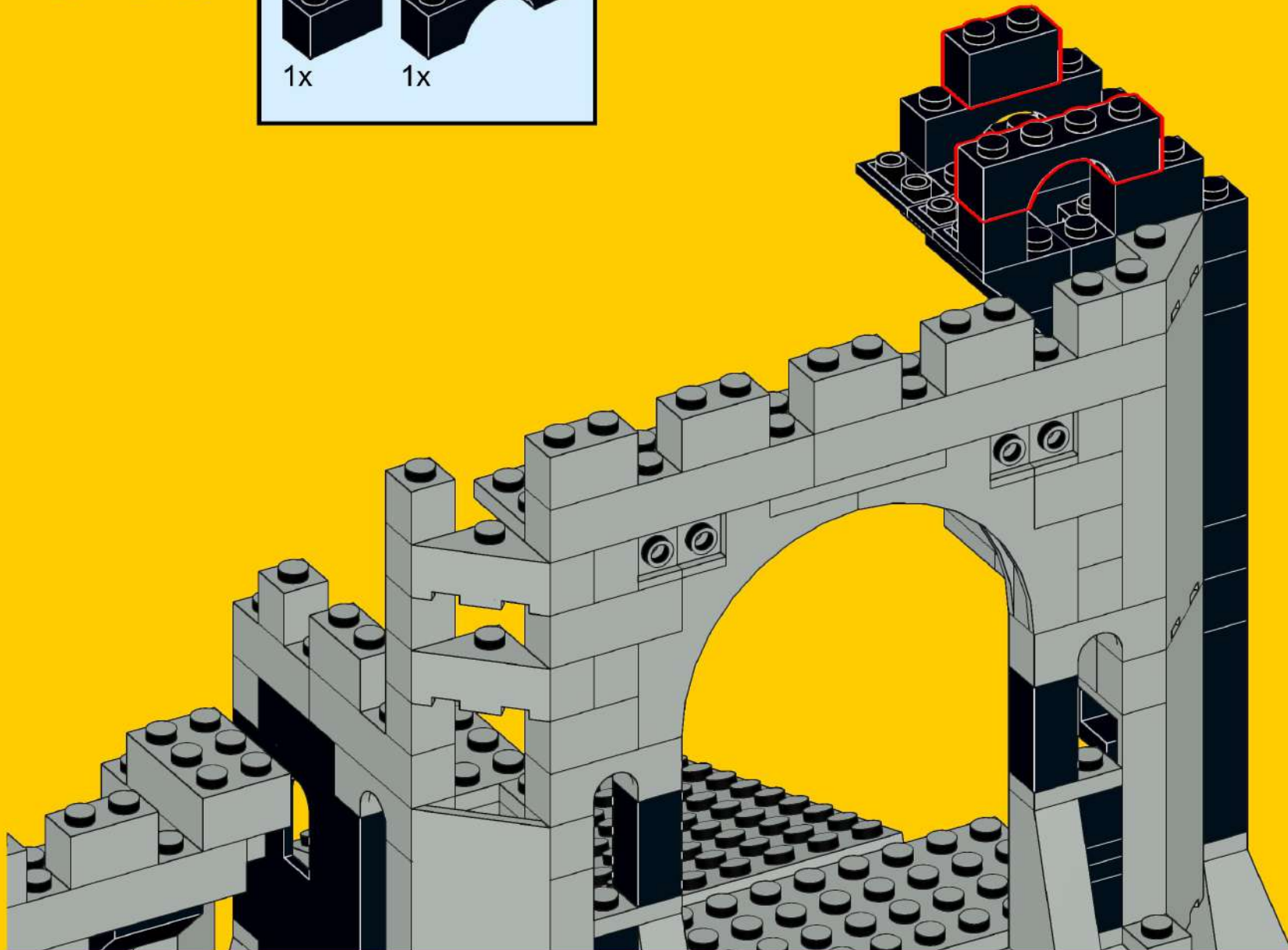
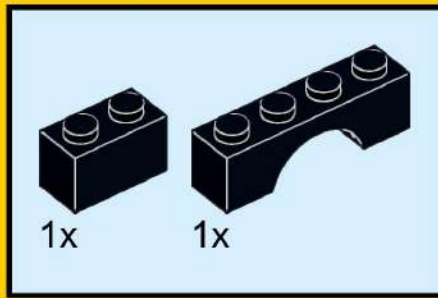

# 150

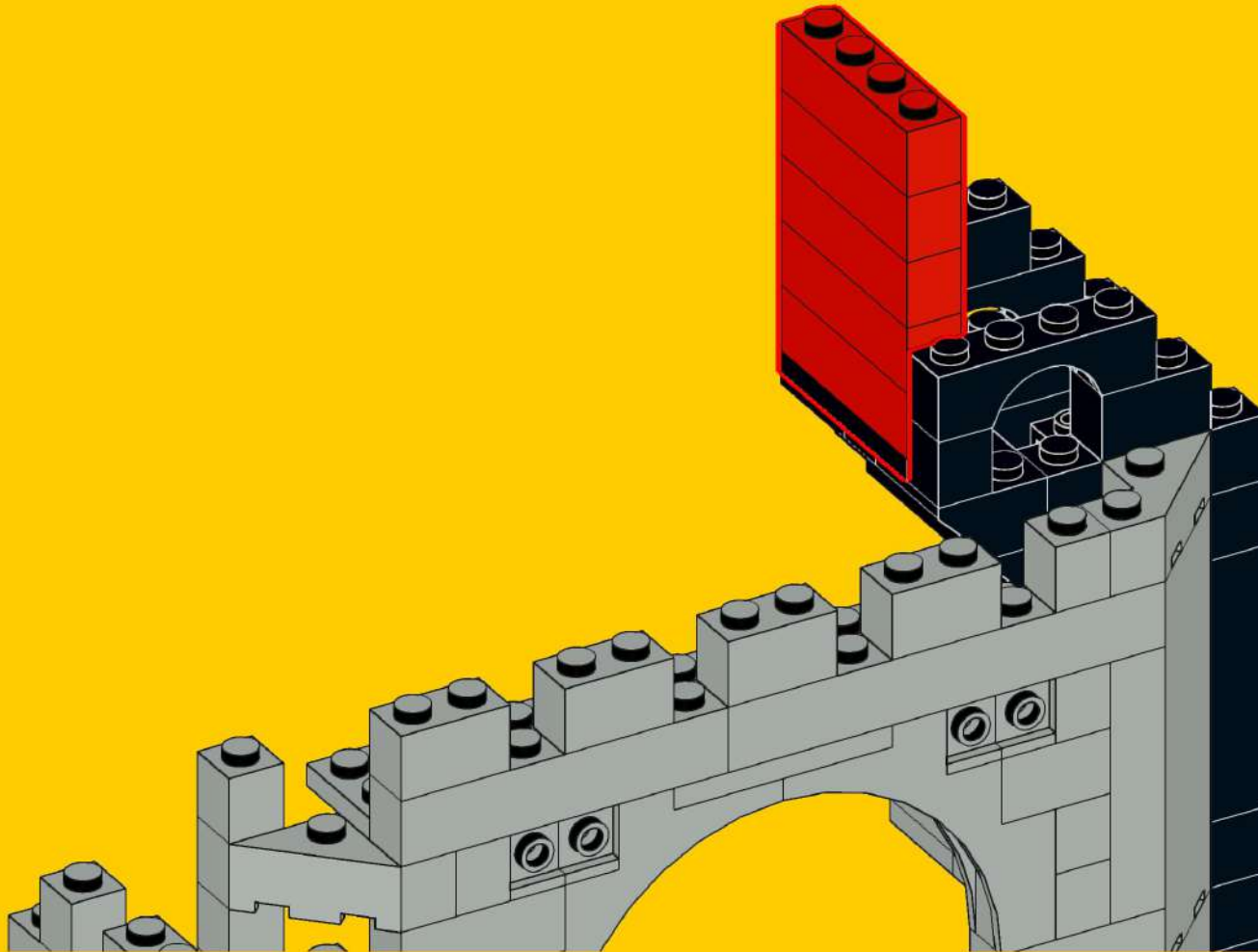
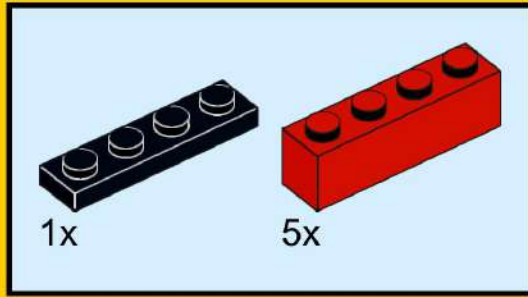

# 151

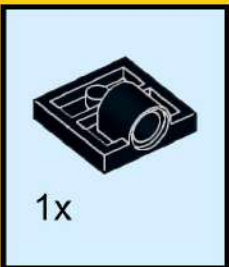

# 152

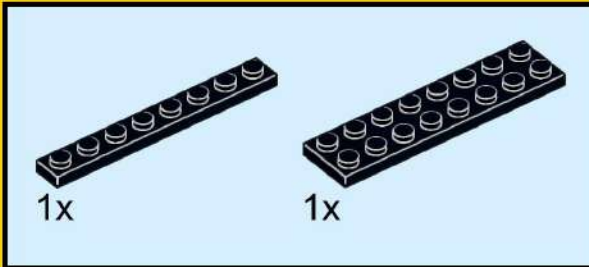

# 153

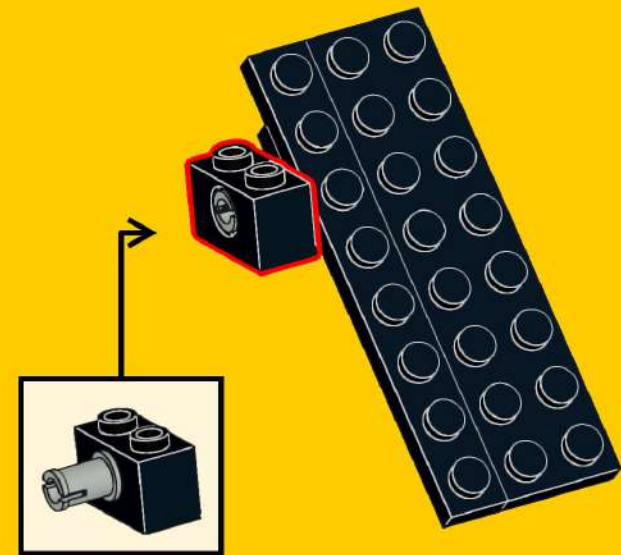
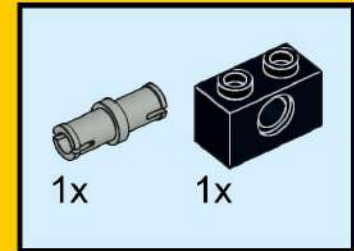

# 154

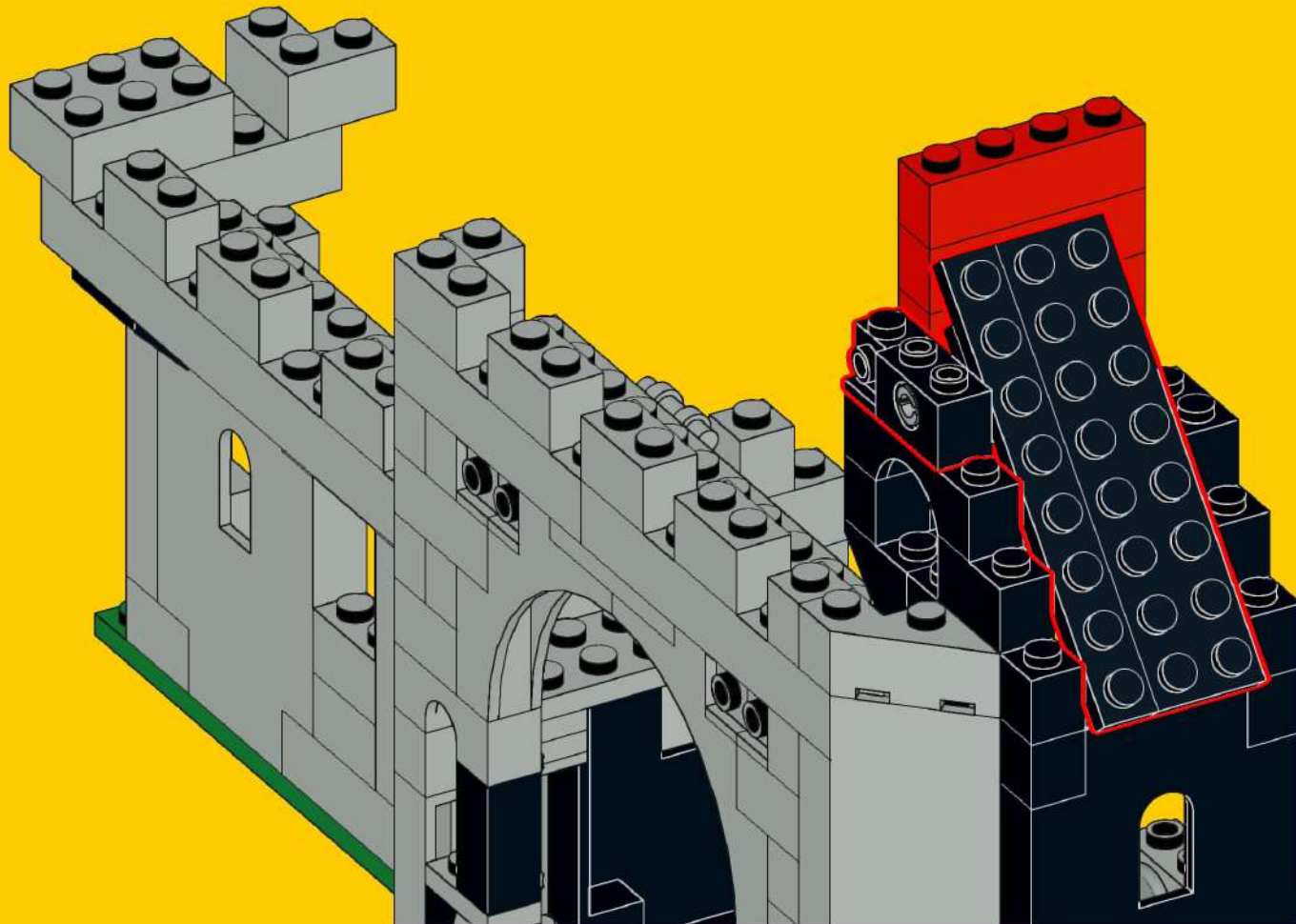

# 155

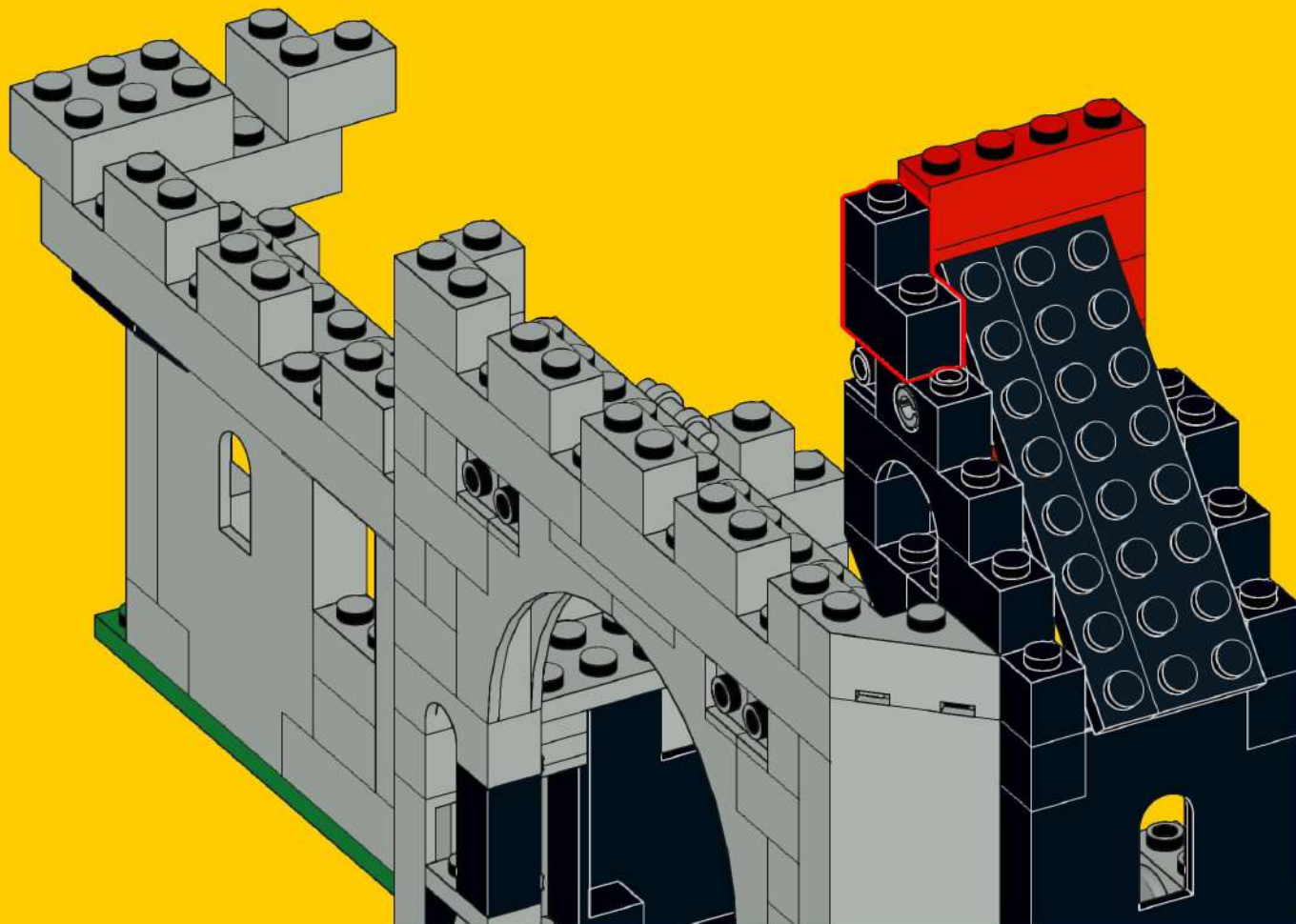
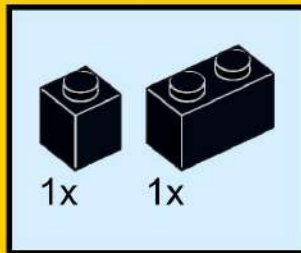

# 156

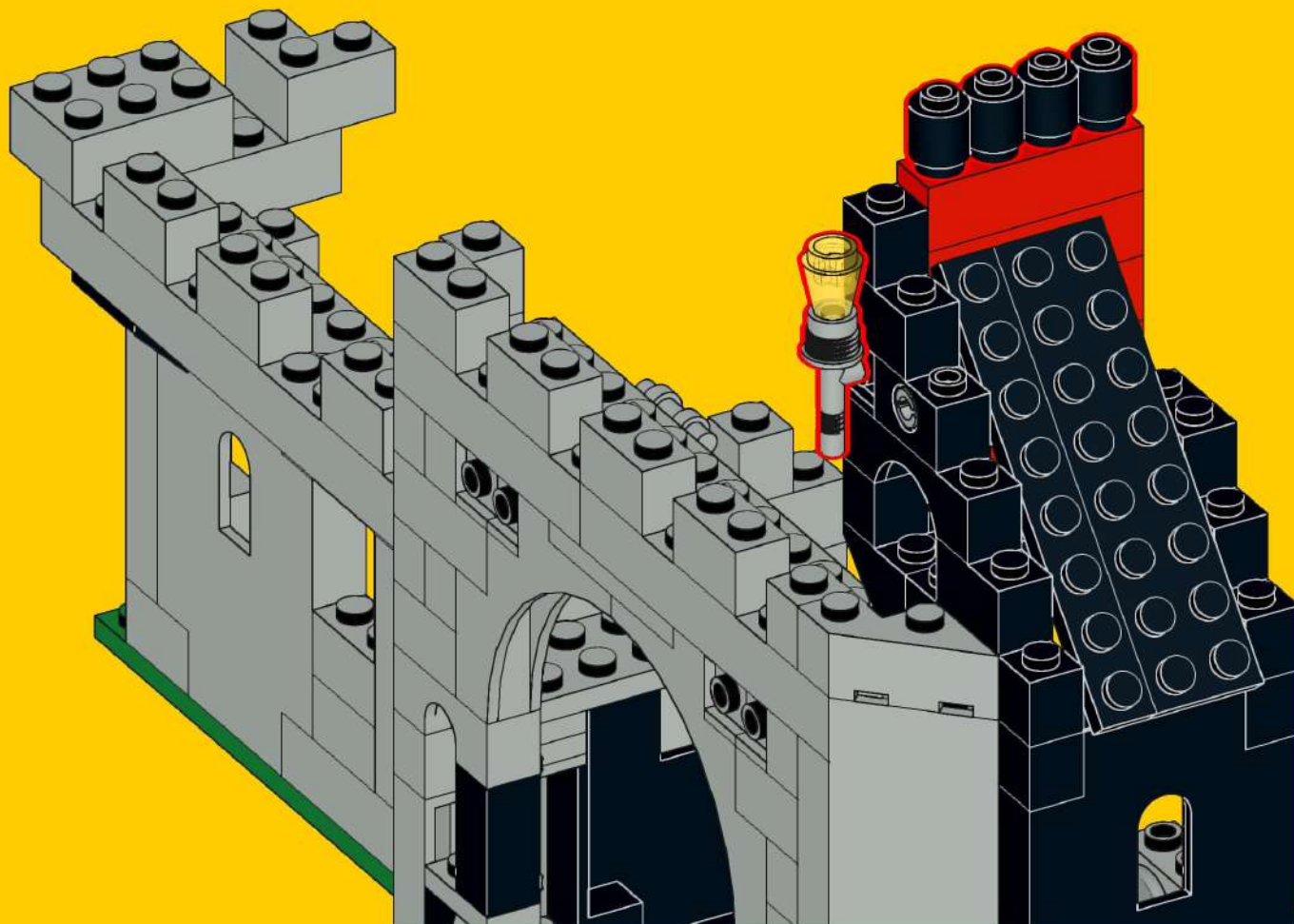

# 157

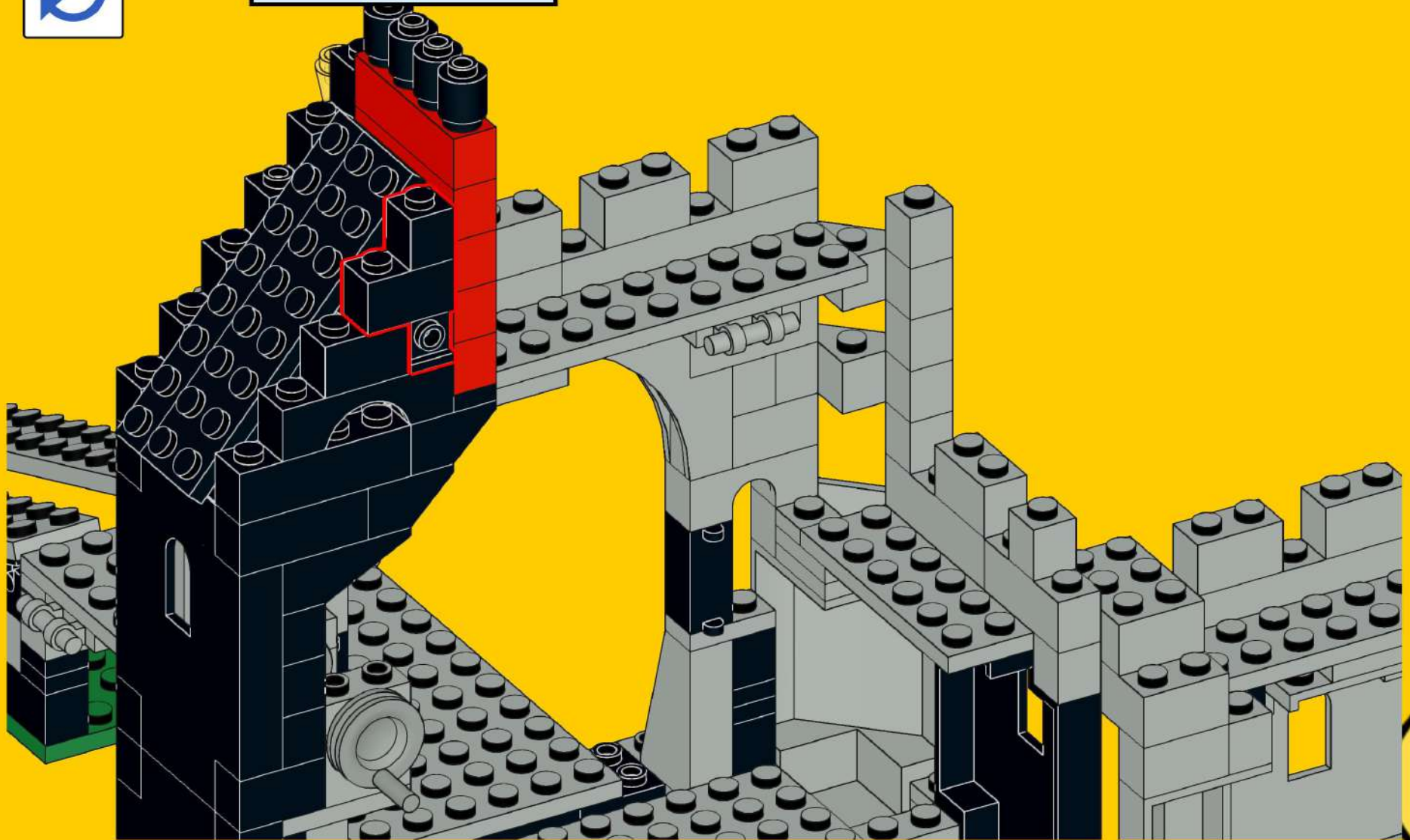
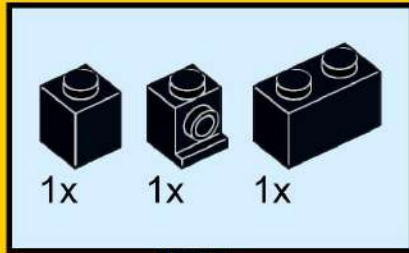



# 158

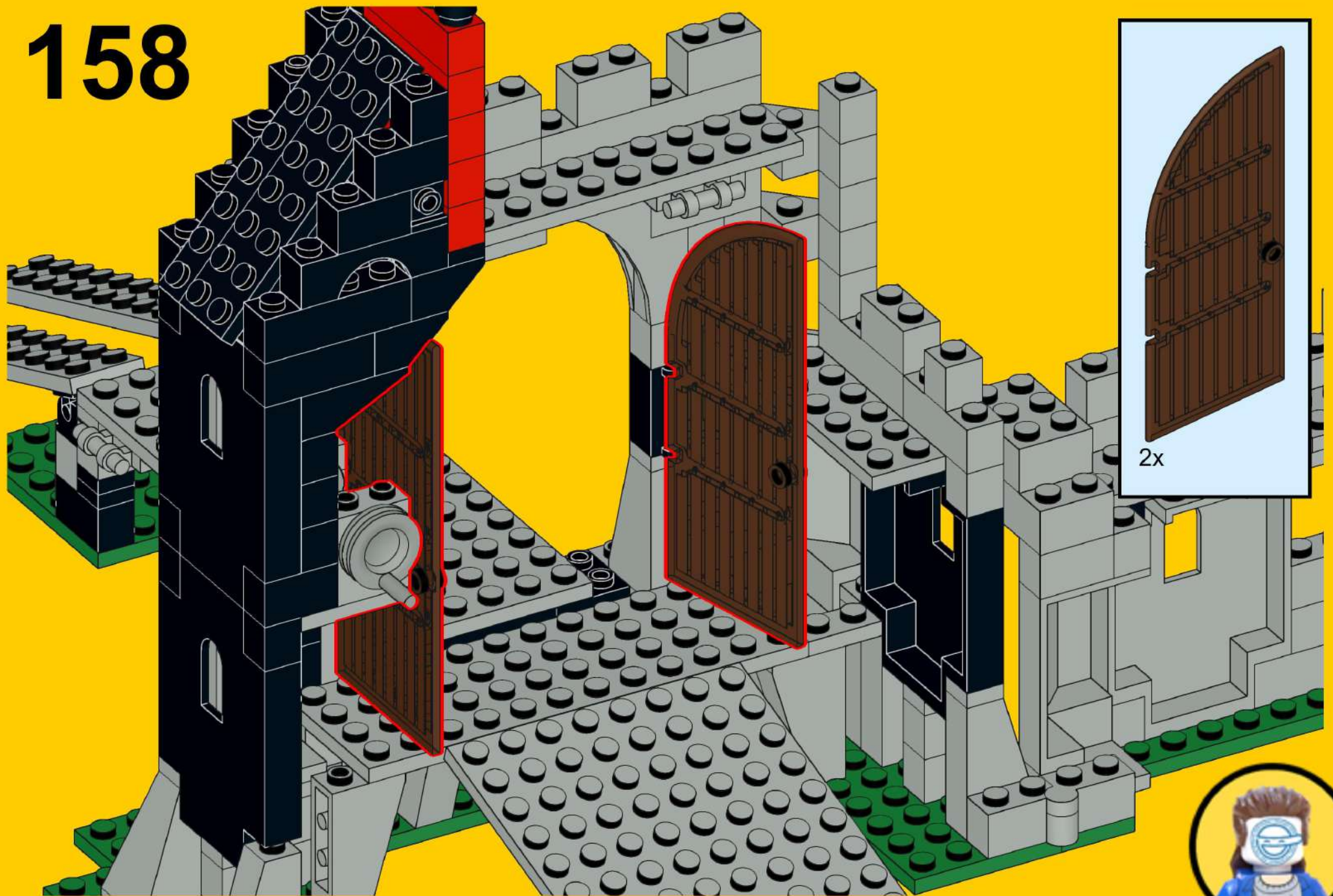

# 159



# 160

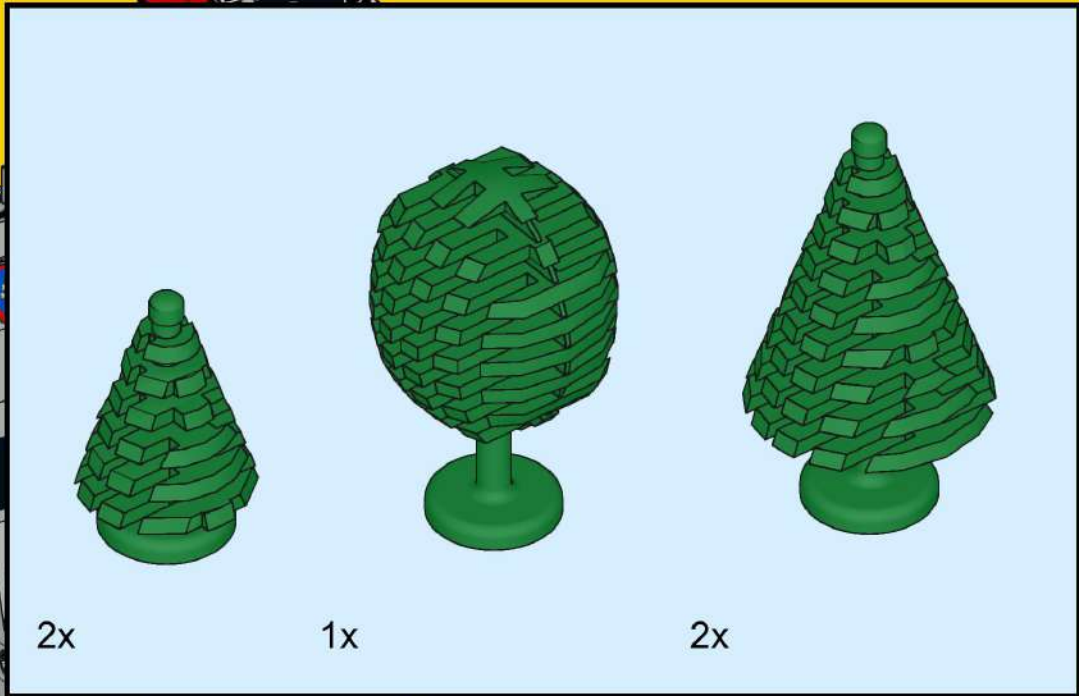
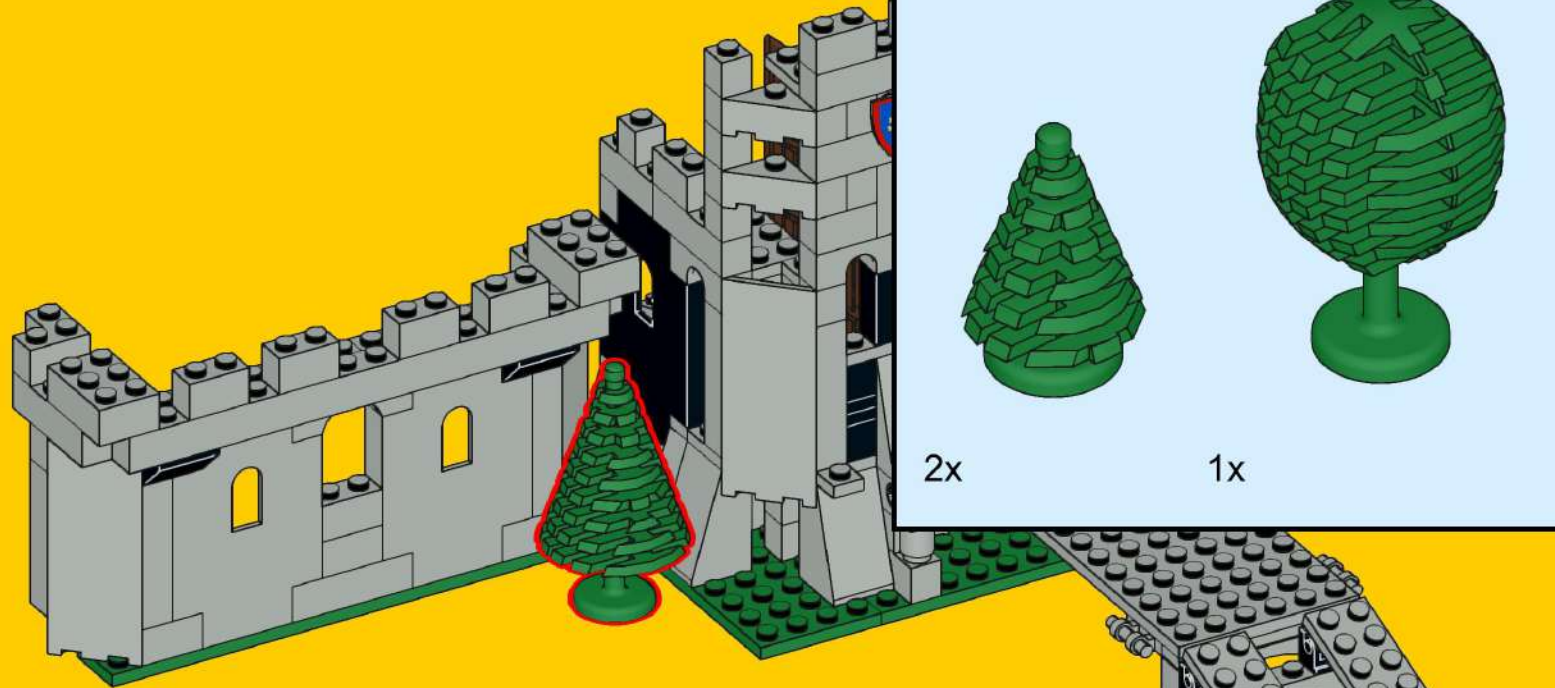

161

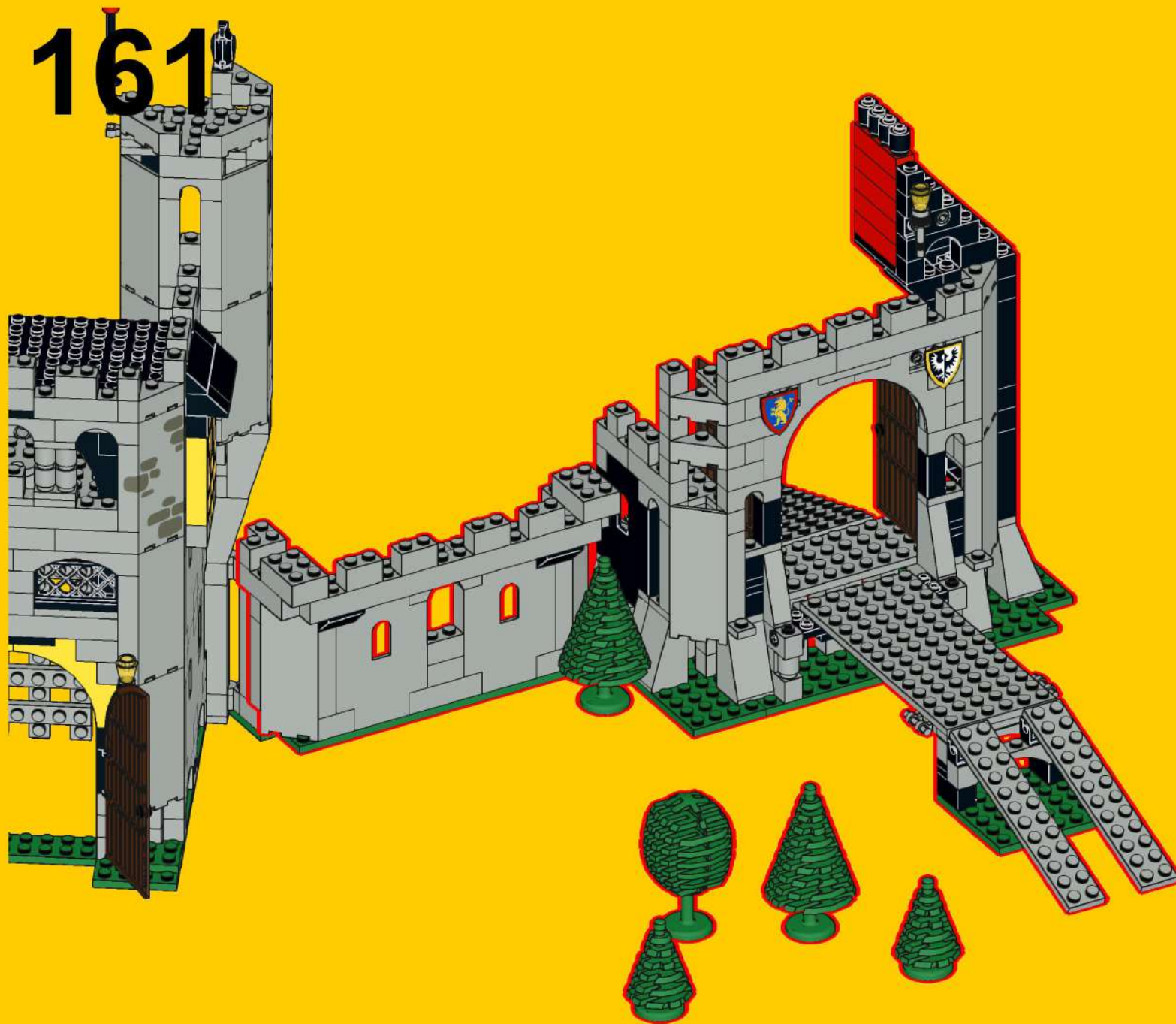

162

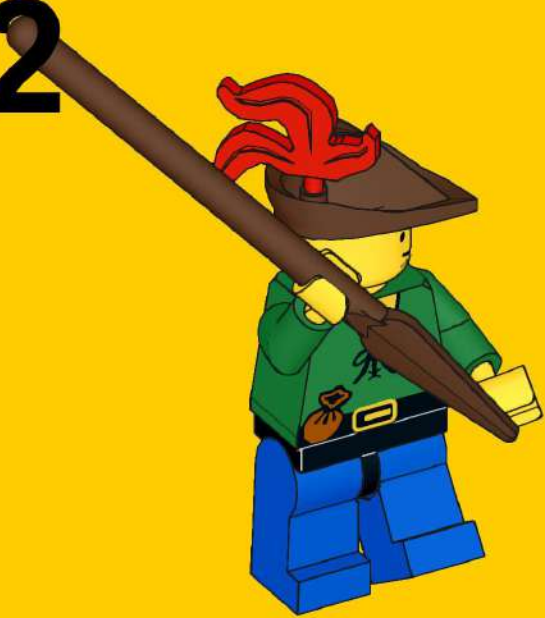

163



164



165



166



167



168

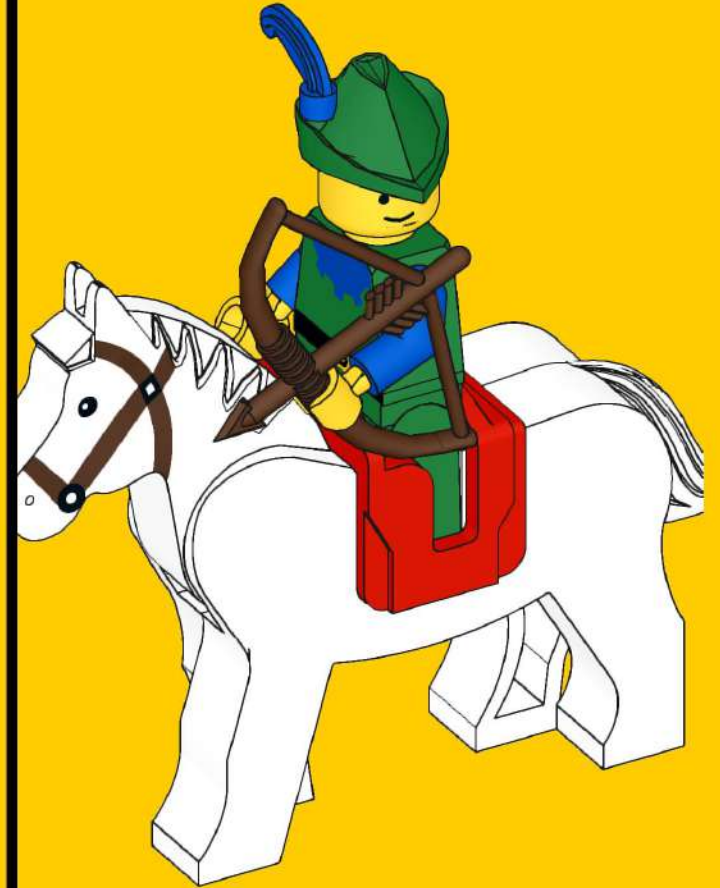

169



170



171



172



173



174



175





176



177



178



179



# 180

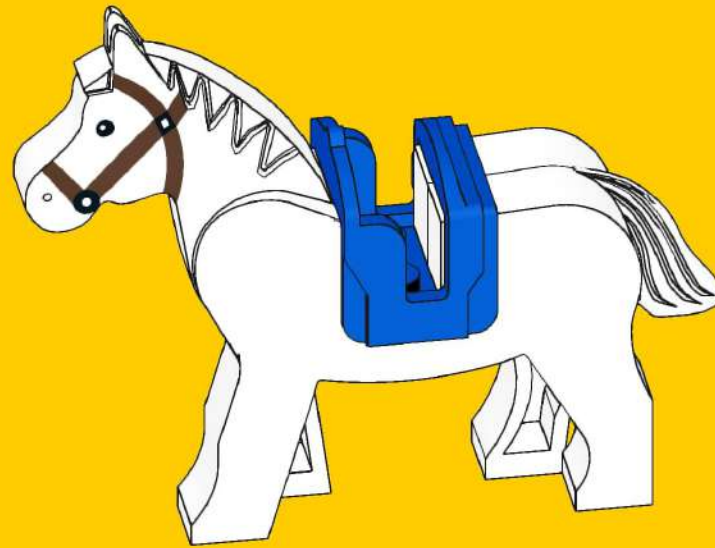

# 181



# 182







2x  
3037, 11

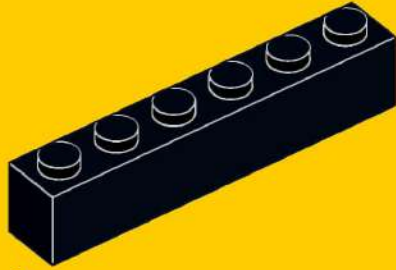

1x  
3009, 11



2x  
2454, 11

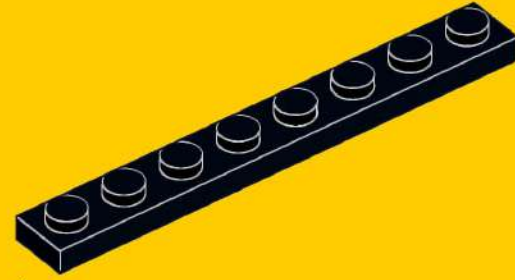

1x  
3460, 11

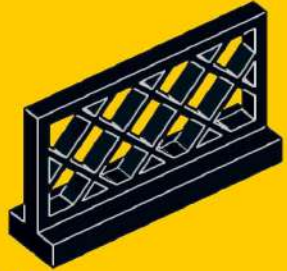

2x  
3185, 11



4x  
2453a, 11

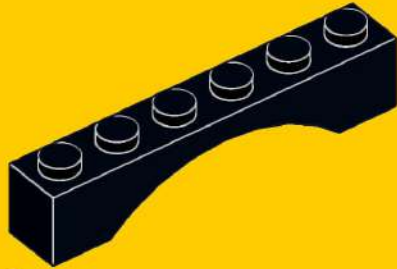

2x  
3455, 11

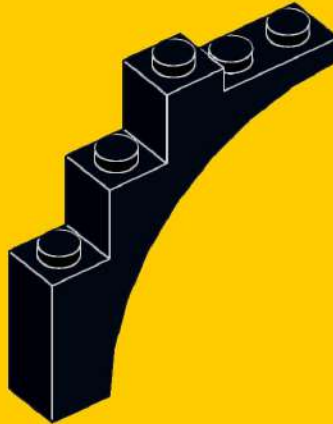

6x  
2339, 11

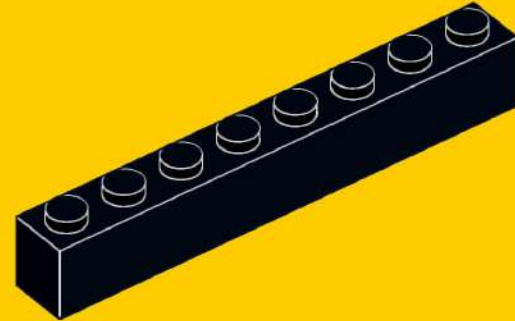

4x  
crssprt01, 11



1x  
3034, 11





3x  
3849, 11

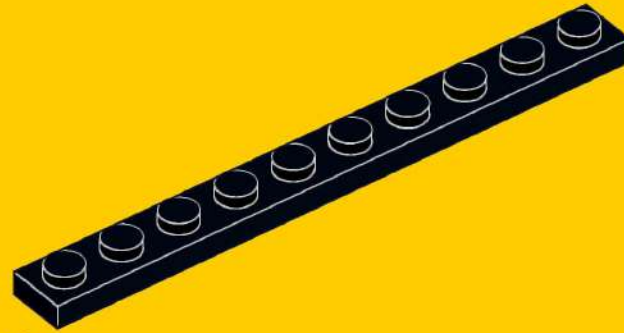

1x  
4477, 11



5x  
4444, 11



1x  
4493c01pb02, 11





1x  
2445, 11



1x  
3456, 11



2x  
2446, 10



3x  
2594, 10



1x  
3896, 10

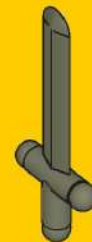

2x  
3847, 10



3x  
2587, 10



3x  
3844, 10

3x  
2570, 10





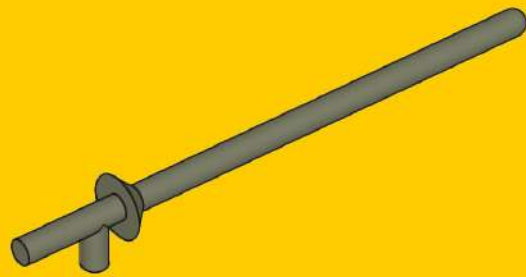

1x  
3849, 10

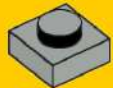

13x  
3024, 9

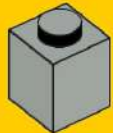

72x  
3005, 9



6x  
4070, 9



10x  
3062b, 9



4x  
4085a, 9



1x  
3794a, 9



1x  
4081a, 9



1x  
3673, 9



21x  
3023, 9



5x  
3700, 9

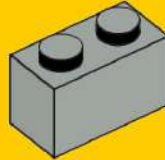

63x  
3004, 9

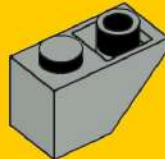

16x  
3665, 9



2x  
3040, 9



3x  
2540, 9

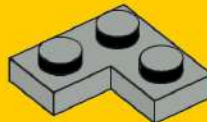

4x  
2420, 9



2x  
4275a, 9

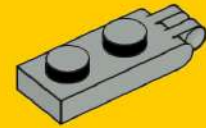

2x  
4276a, 9

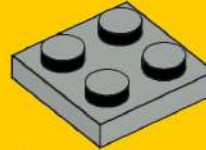

1x  
3022, 9

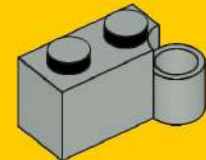

3x  
3831, 9



1x  
3959, 9

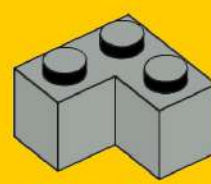

33x  
2357, 9

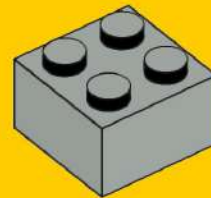

5x  
3003, 9

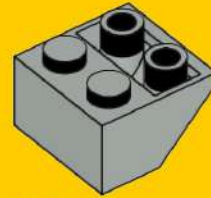

1x  
3660, 9

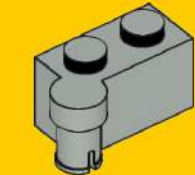

3x  
3830, 9

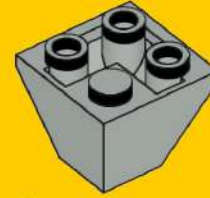

4x  
3676, 9

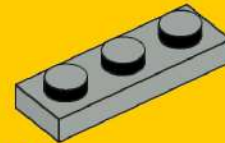

7x  
3623, 9



3x  
3846p4h, 9



6x  
3846p4g, 9



2x  
3846p46, 9



2x  
2341, 9

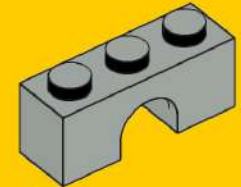

10x  
4490, 9

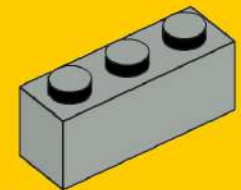

26x  
3622, 9





1x  
3176, 9

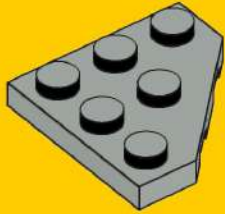

4x  
2450, 9

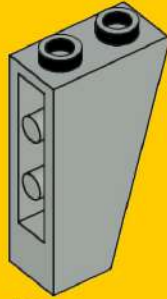

10x  
2449, 9

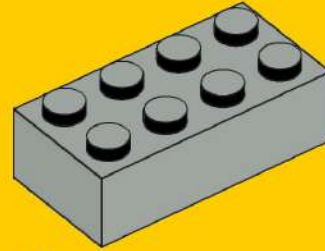

1x  
3001, 9

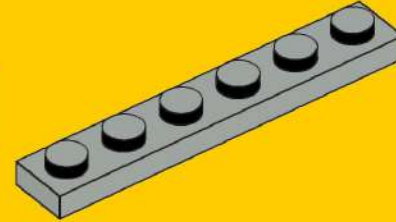

5x  
3666, 9



2x  
3021, 9

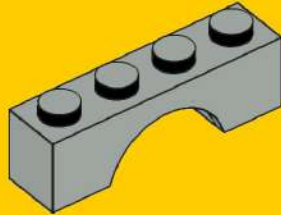

4x  
3659, 9

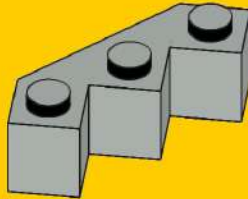

15x  
2462, 9

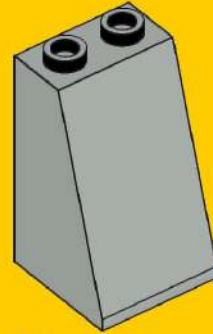

3x  
3684a, 9

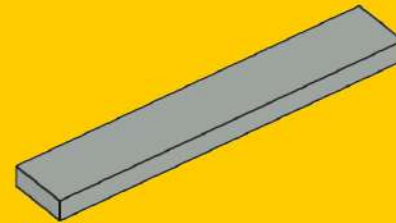

1x  
6636, 9

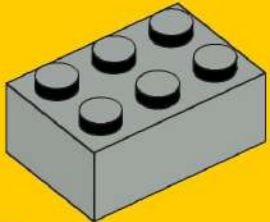

8x  
3002, 9

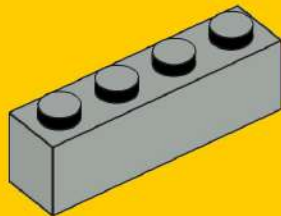

14x  
3010, 9



1x  
3020, 9

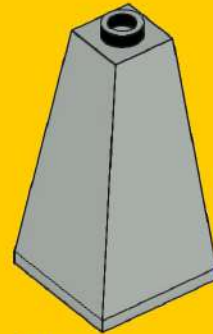

1x  
3685, 9

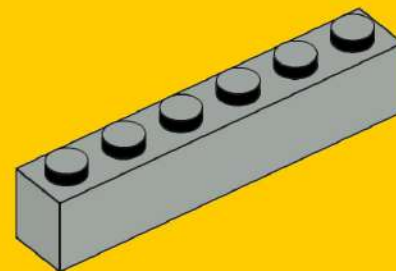

1x  
3009, 9

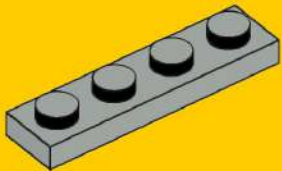

4x  
3710, 9

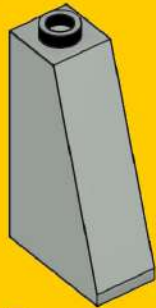

5x  
4460a, 9





8x  
3455, 9

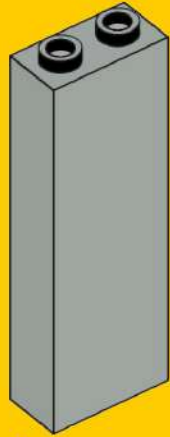

2x  
2454, 9

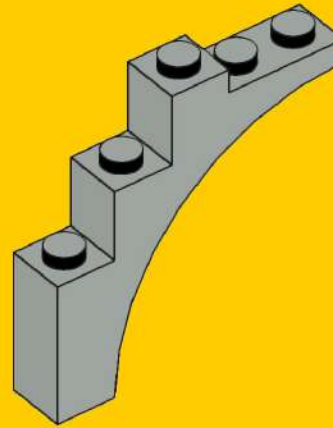

2x  
2339, 9

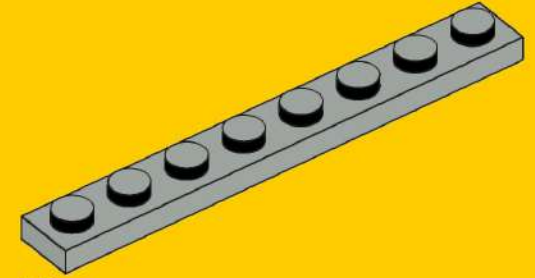

10x  
3460, 9

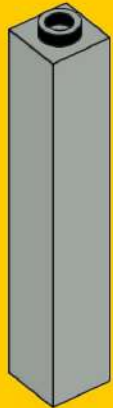

2x  
2453a, 9

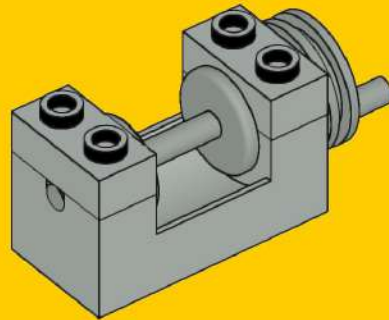

2x  
73037, 9

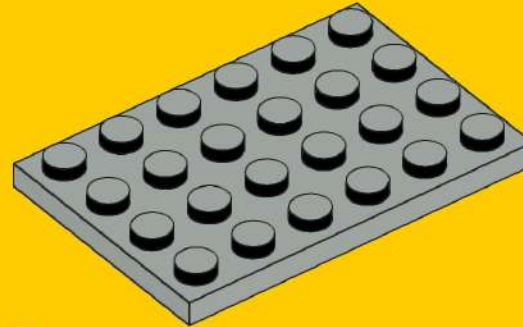

2x  
3032, 9

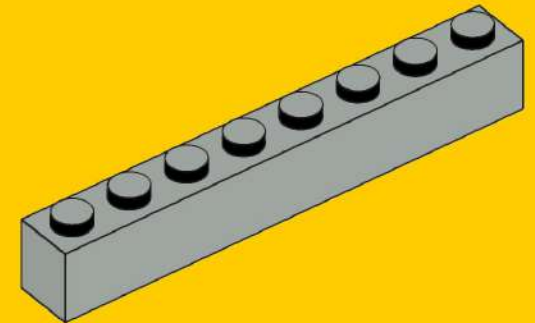

3x  
3008, 9

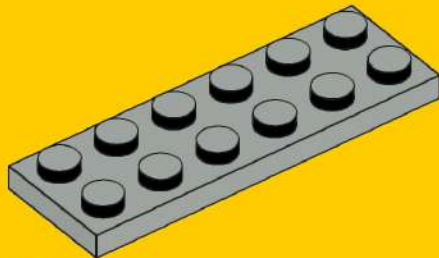

3x  
3795, 9



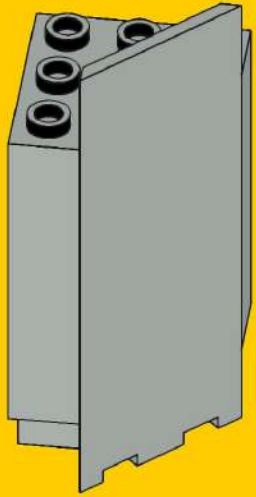

20x  
2345, 9

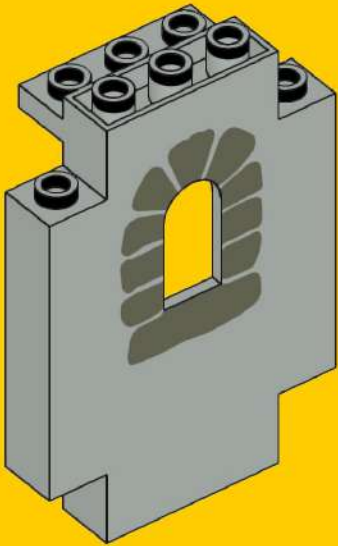

1x  
4444p01, 9

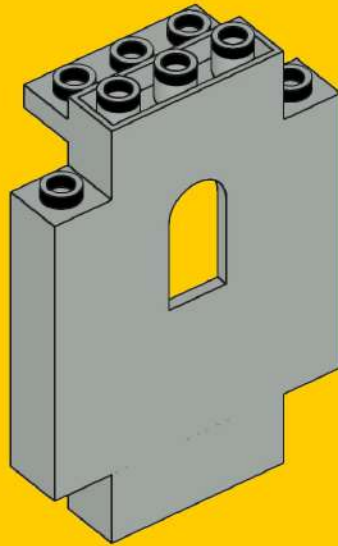

9x  
4444, 9

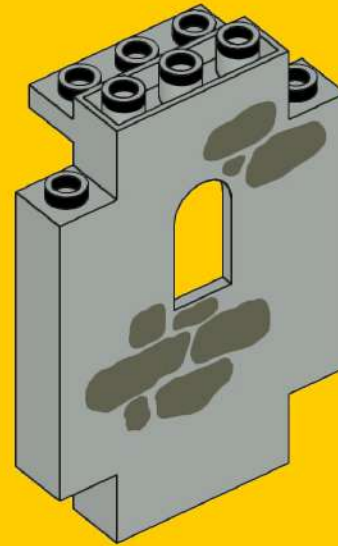

1x  
4444p02, 9



3x  
2345pb05, 9

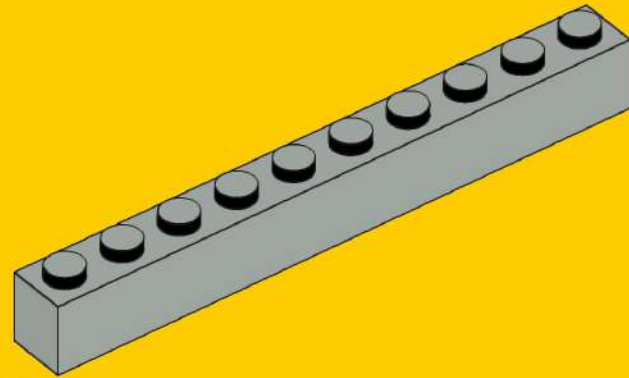

2x  
6111, 9



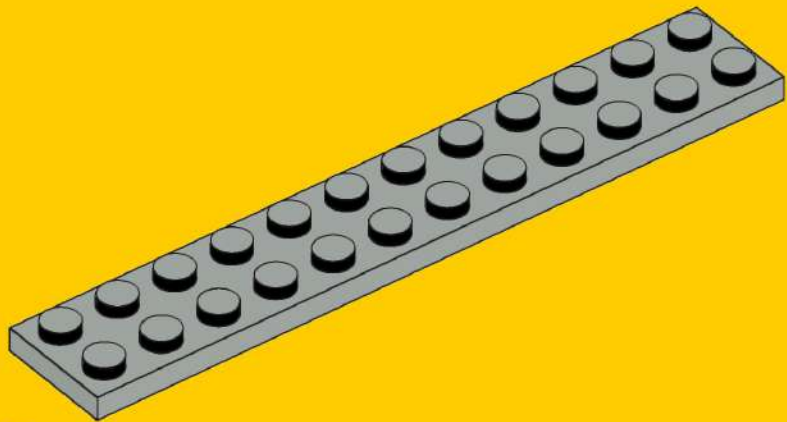

3x  
2445, 9

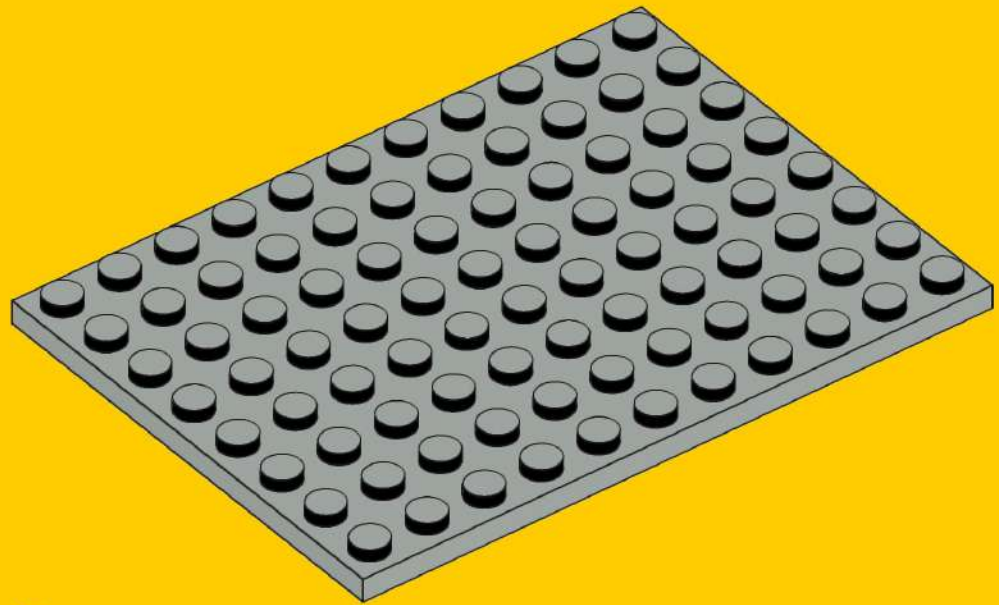

1x  
728, 9

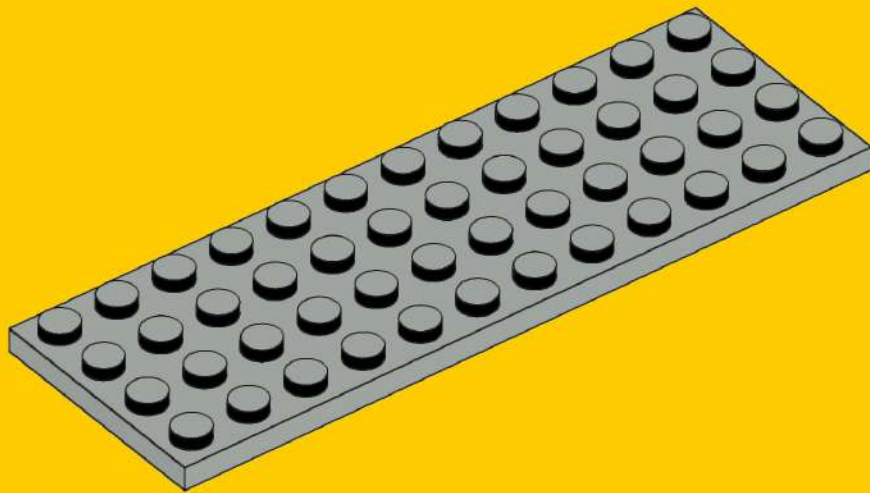

1x  
3029, 9



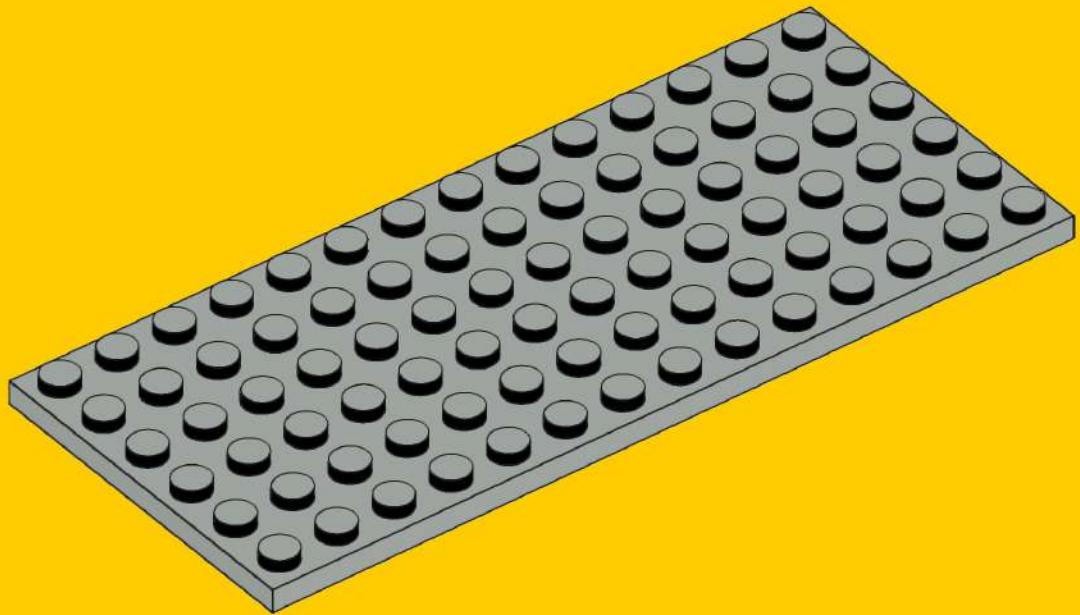

2x  
3456, 9



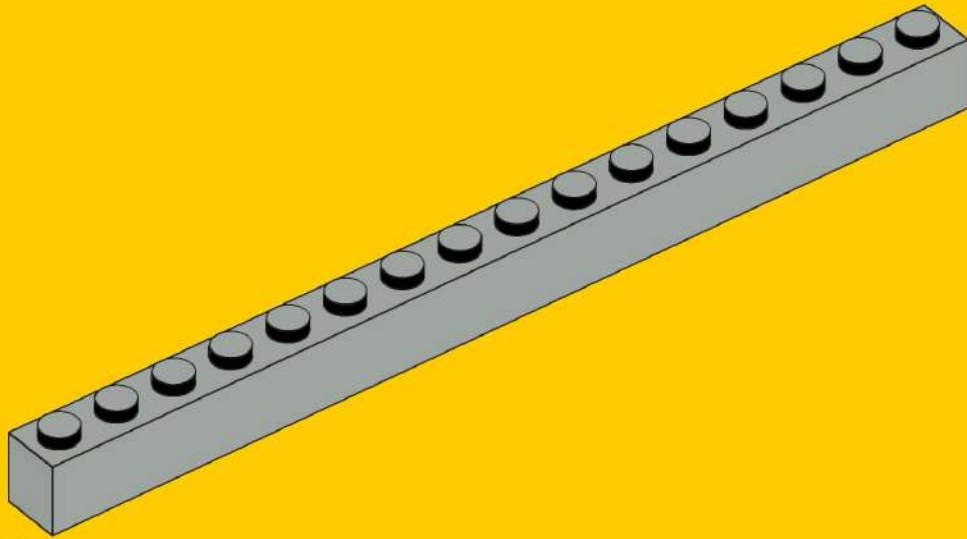

1x  
2465, 9



1x  
981, 1



1x  
982, 1



1x  
973p4n, 1



1x  
973p4q, 1

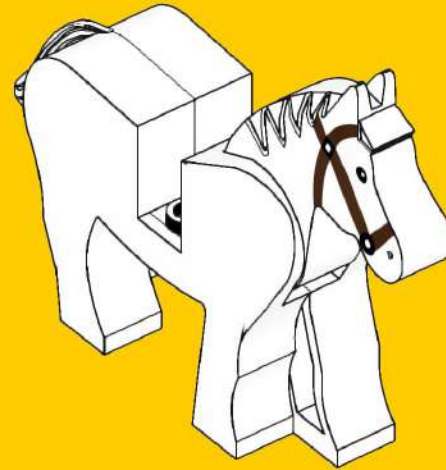

3x  
971, 5



3x  
972, 5



3x  
4502b, 5

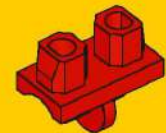

1x  
970, 5

4x  
4493c01pb04, 1



1x  
981, 5



1x  
982, 5



3x  
973p4, 5





3x  
973px138, 5

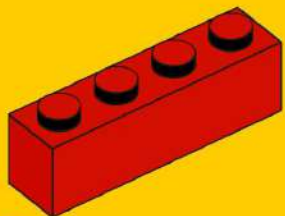

5x  
3010, 5



2x



1x  
2563, 8



3x  
3848, 8



10x  
3626bp01, 3



3x  
973p41, 5

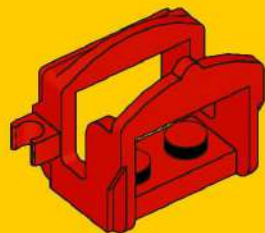

1x  
4491a, 5



4x  
4498, 8



6x  
3626ap01, 3



1x  
x107, 5

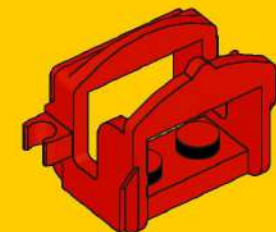

1x  
4491b, 5



6x  
2536d, 8



2x  
3626bp40, 3



4x  
4495a, 5



2x  
775, 8



6x  
4499, 8



3x  
4497, 8

4x  
2400, 8



36x  
983, 3



1x  
2343, 3



1x  
4502a, 3



1x  
4502b, 3





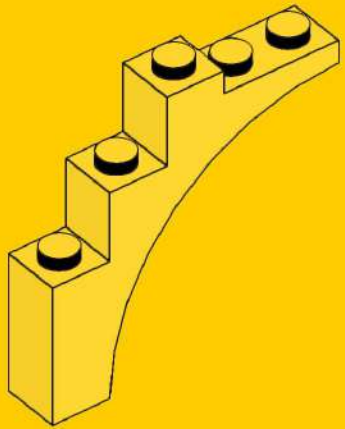

2x  
2339, 3

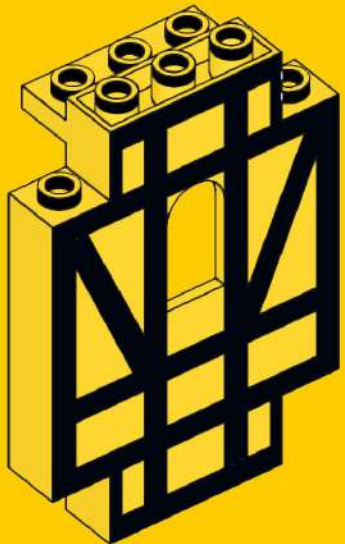

1x  
4444p03, 3



2x  
981, 6



2x  
982, 6



3x  
972, 6



3x  
971, 6

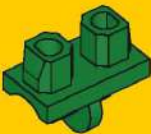

3x  
970, 6



3x  
3022, 6



1x  
4032b, 6



4x  
775, 6



3x  
973p49, 6



1x  
973p46, 6



1x  
x70, 6



2x  
973p50, 6

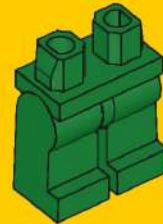

3x  
970c00, 6

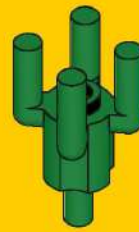

1x  
2566, 6



3x  
3021, 6

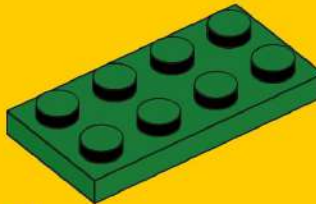

5x  
3020, 6



5x  
2423, 6

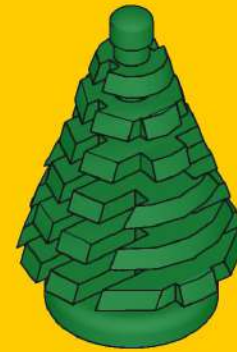

2x  
2435, 6

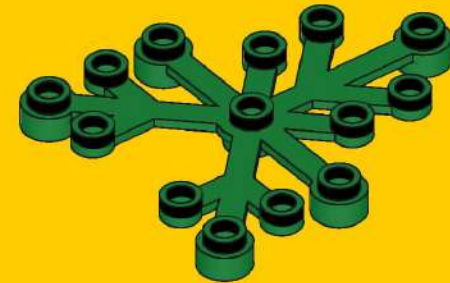

3x  
2417, 6



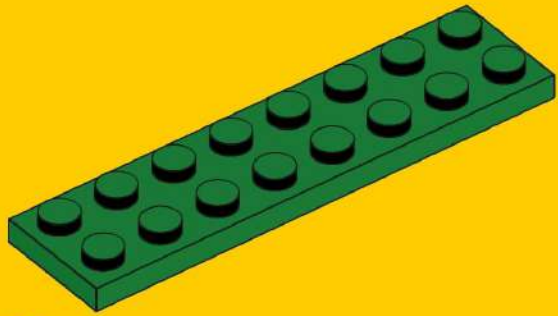

1x  
3034, 6

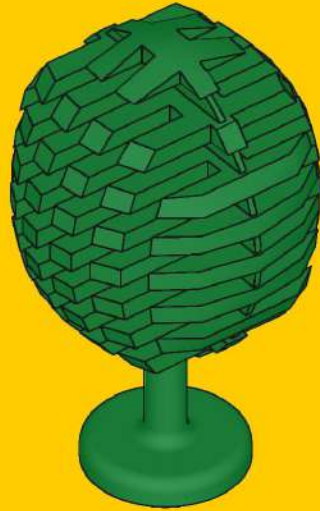

1x  
3470, 6

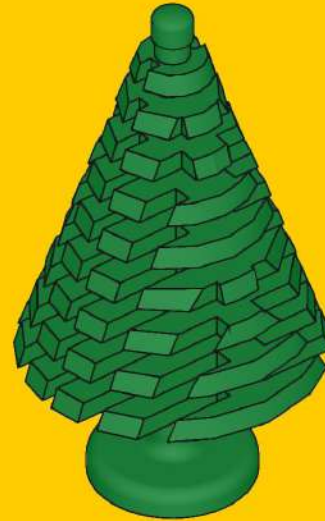

2x  
3471, 6

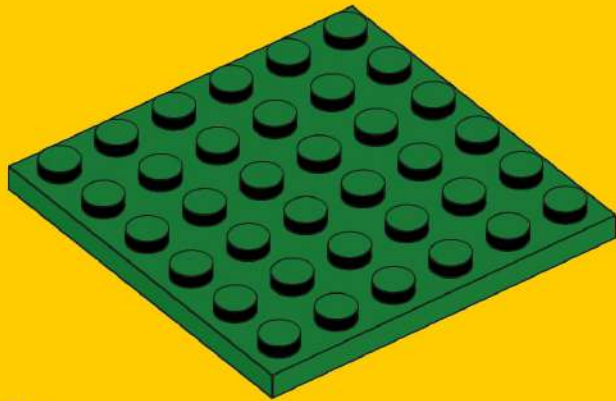

1x  
3958, 6

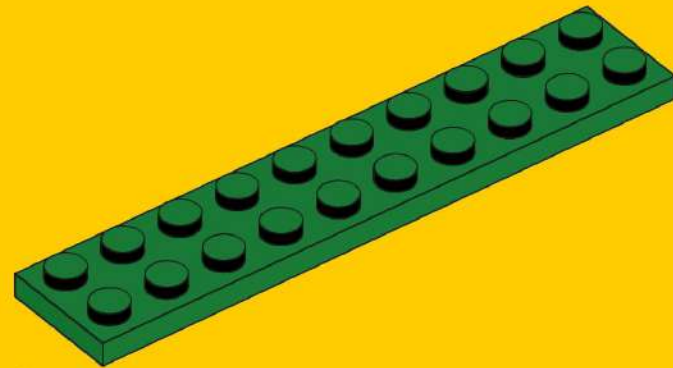

1x  
3832, 6



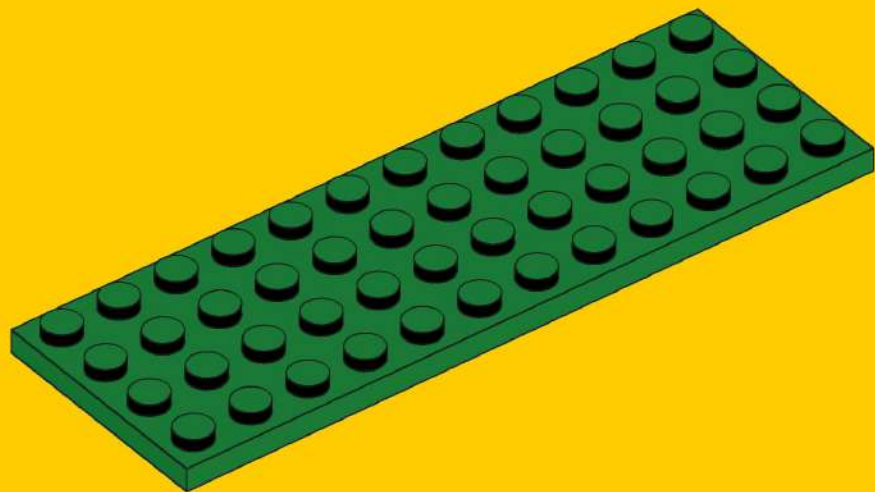

5x  
3029, 6

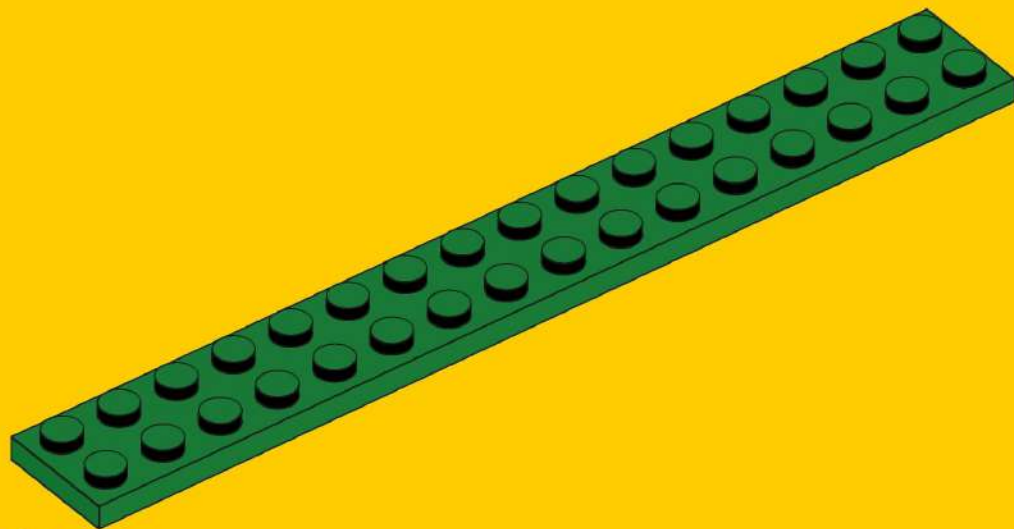

1x  
4282, 6

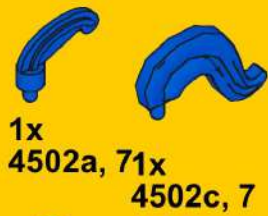

1x  
4502a, 71x  
4502c, 7



11x  
981, 7



1x  
973p43, 7

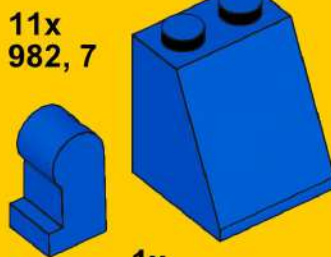

11x  
982, 7

2x  
972, 7

1x  
3678a, 7

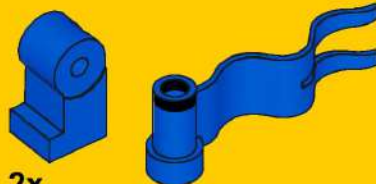

2x  
971, 7

4x  
4495a, 7

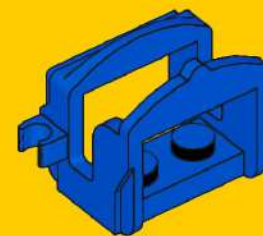

1x  
4491a, 7



3x  
4589, 19

