

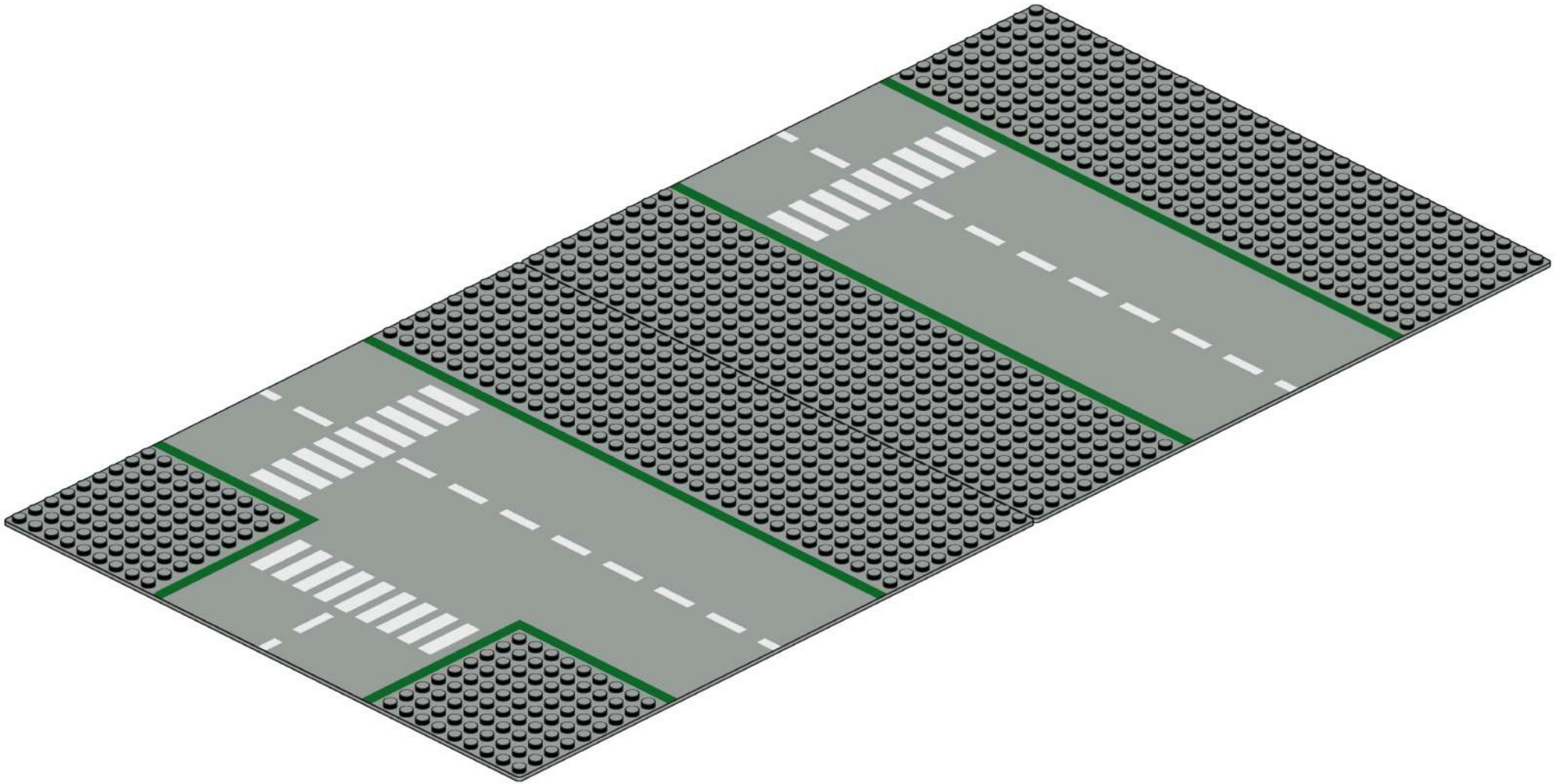

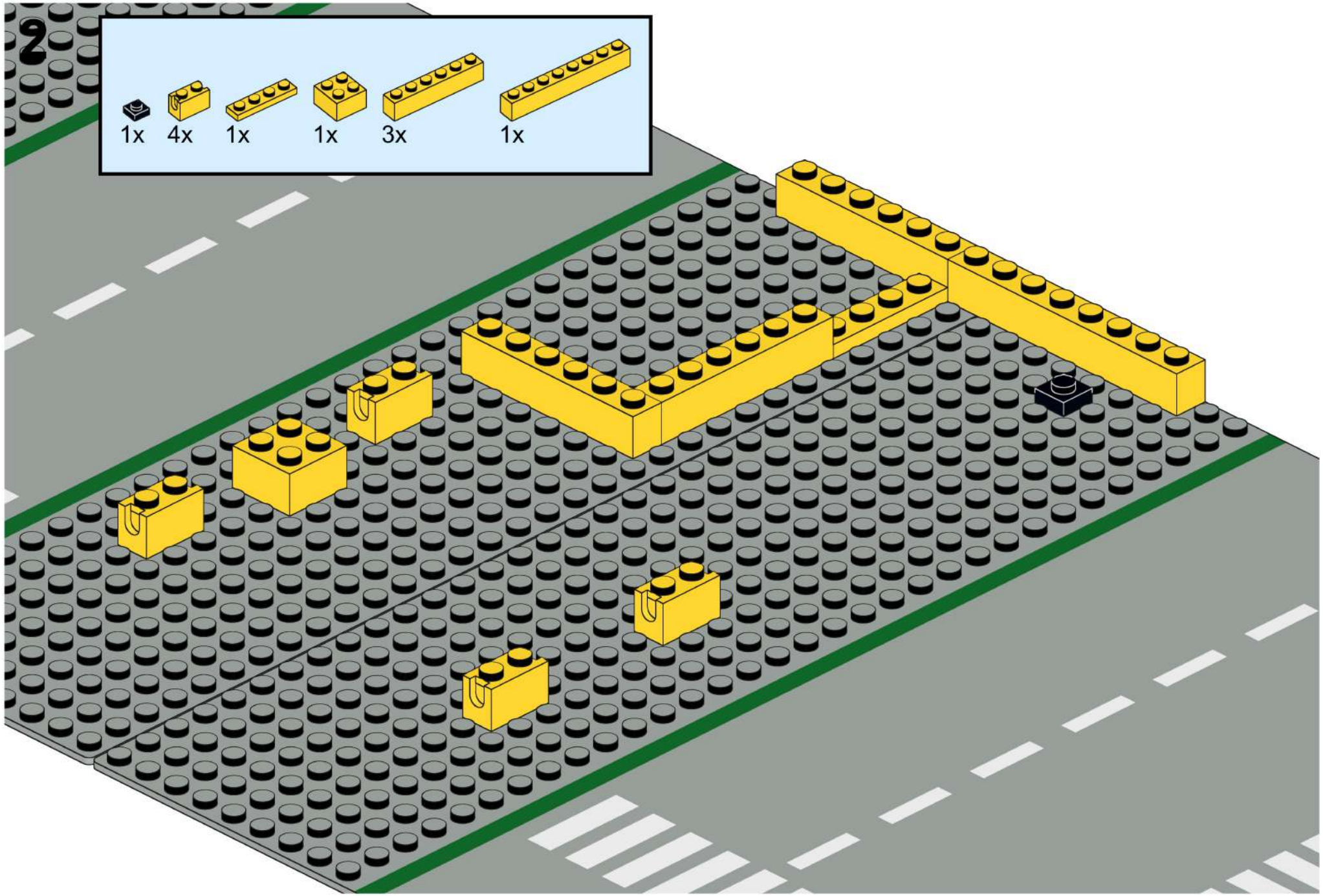

1



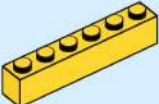
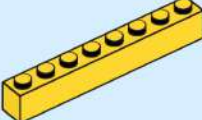

- 1x 
- 4x 
- 1x 
- 1x 
- 3x 
- 1x 

1x 5x 4x 1x 1x 1x

This inset box lists the parts required for step 3: 1x black square, 5x red 1x2 Technic bricks, 4x red 1x3 Technic bricks, 1x red 1x4 Technic brick, 1x red 1x5 Technic brick, and 1x red 1x7 Technic brick.

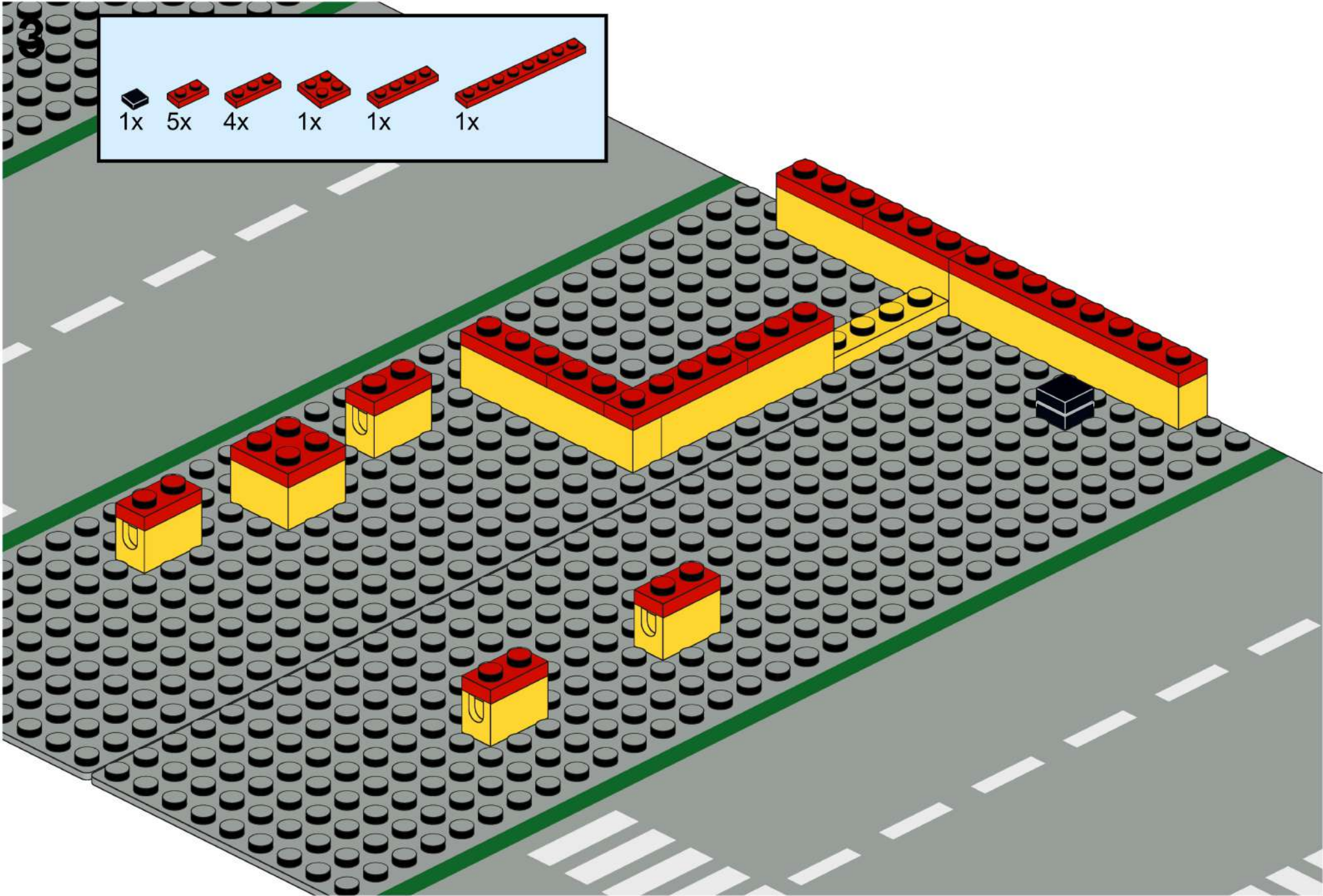

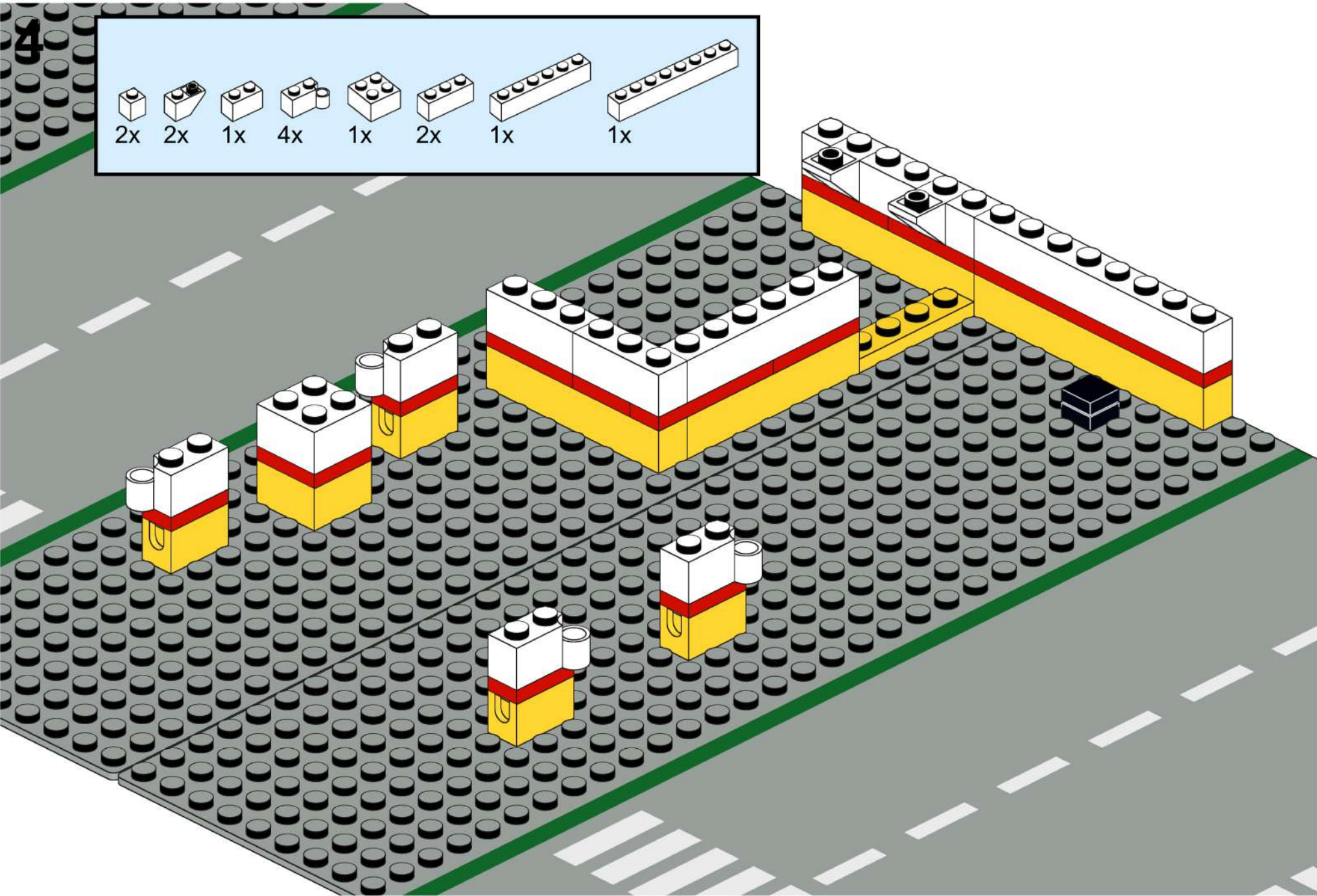

1x 2x 1x 1x 1x 1x 4x 2x 1x

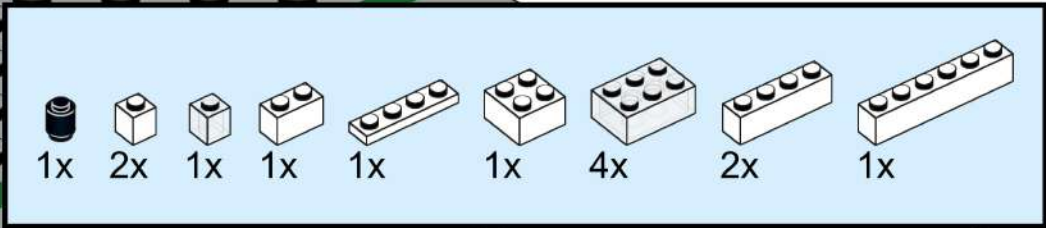
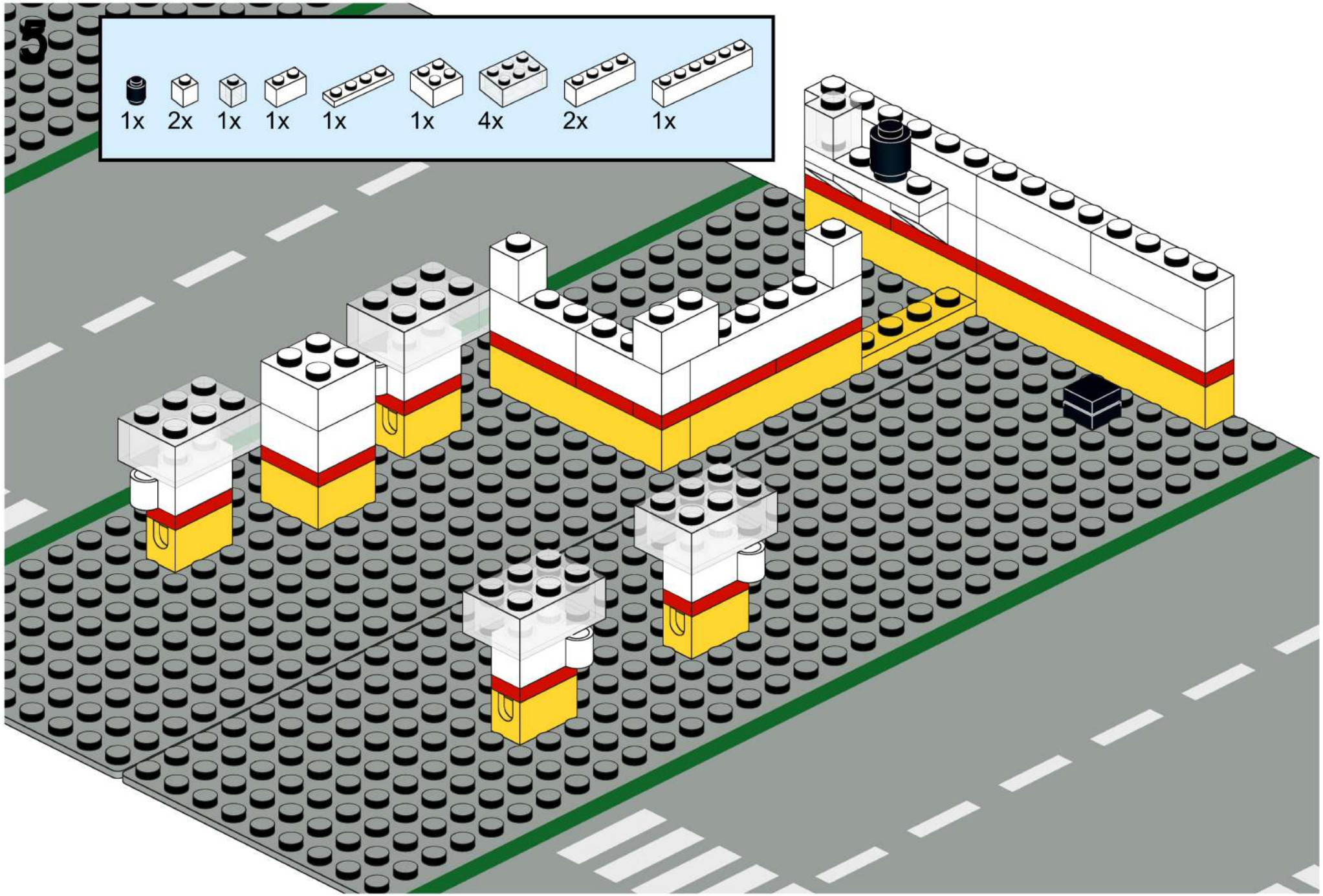
A light blue rectangular box containing a list of LEGO parts with their quantities. From left to right: a black axle pin (1x), a white 1x1 brick (2x), a white 1x1 brick with a hole (1x), a white 1x2 brick (1x), a white 1x4 Technic beam (1x), a white 1x2 brick with four holes (1x), a white 1x4 Technic beam with four holes (4x), a white 1x4 Technic beam with two holes (2x), and a white 1x6 Technic beam with six holes (1x).

6

1x 2x 2x 4x 1x 1x

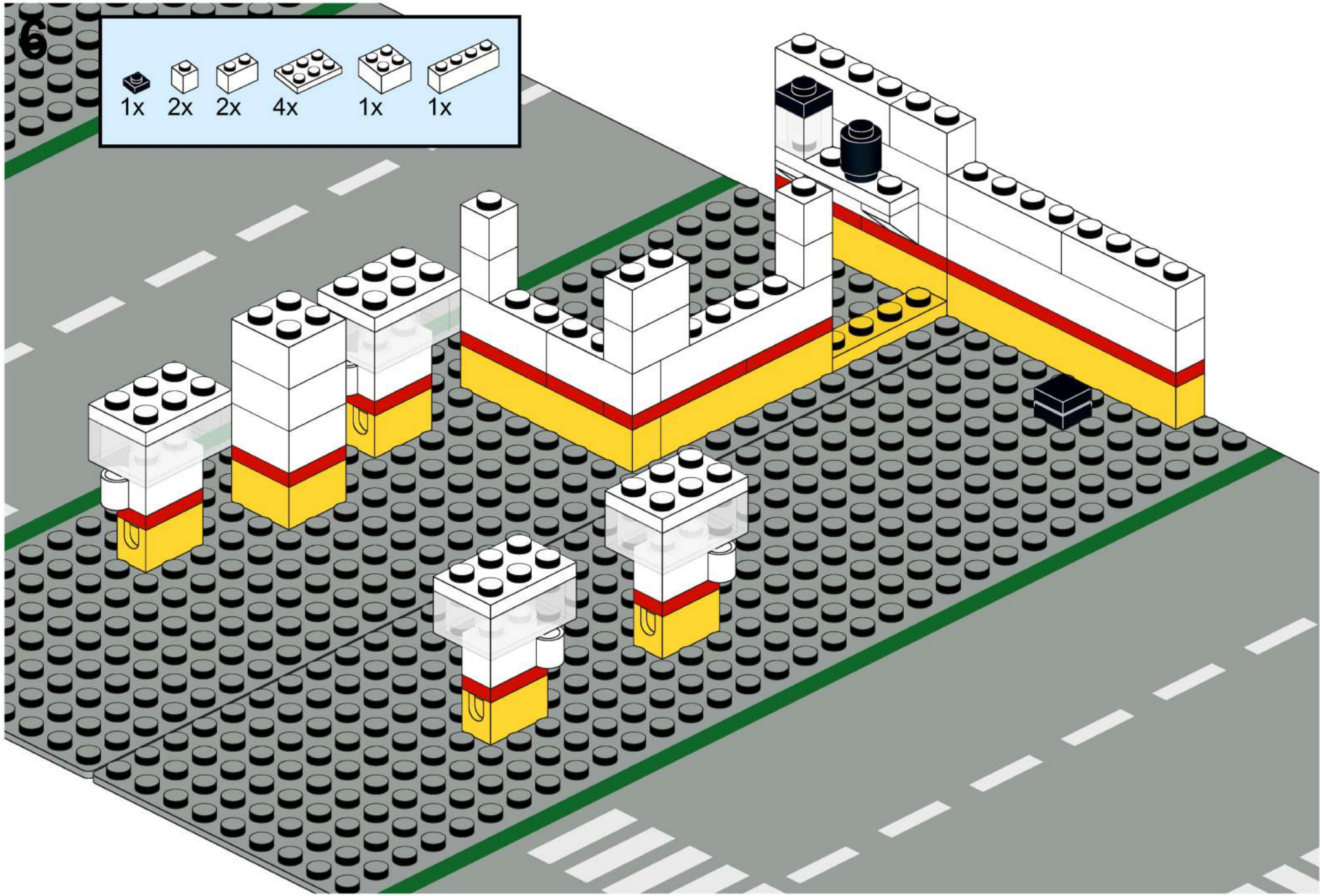
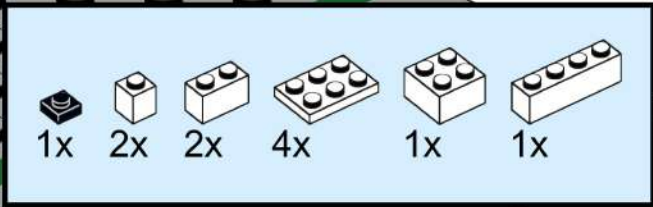

7

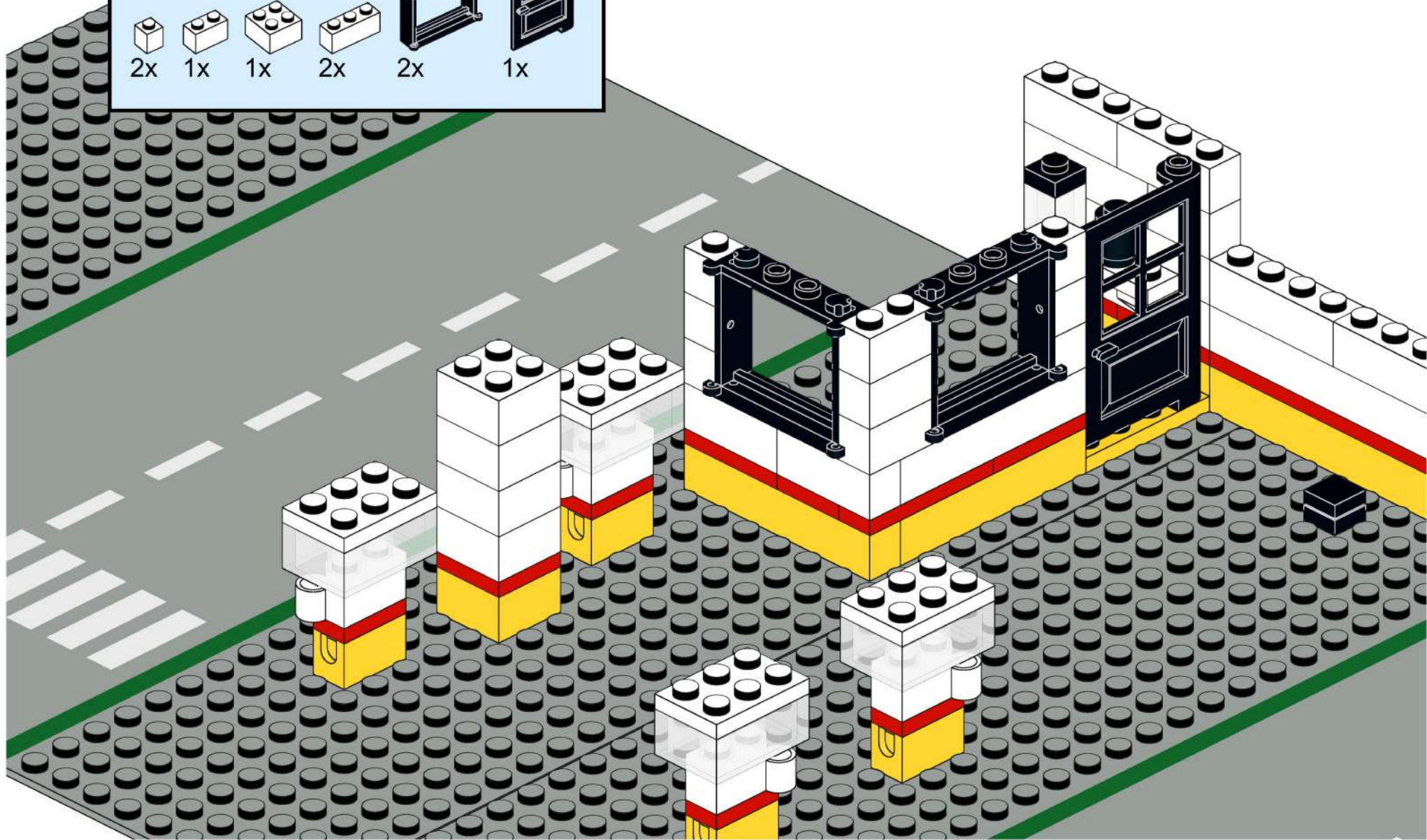
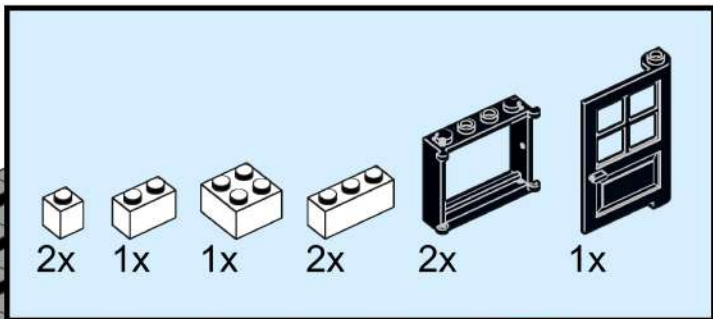

8

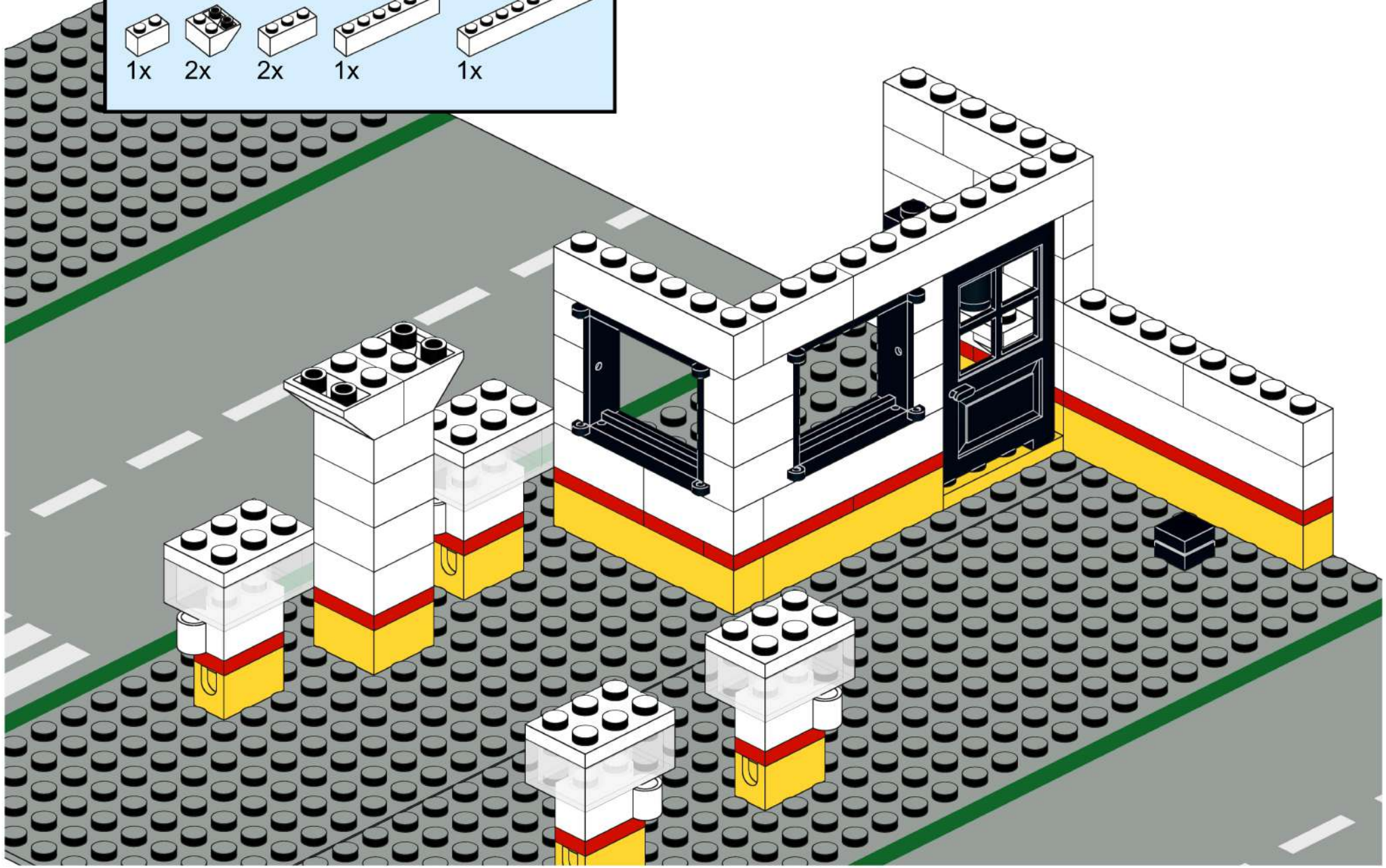
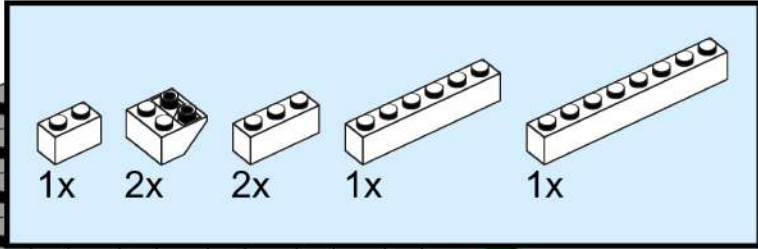

9

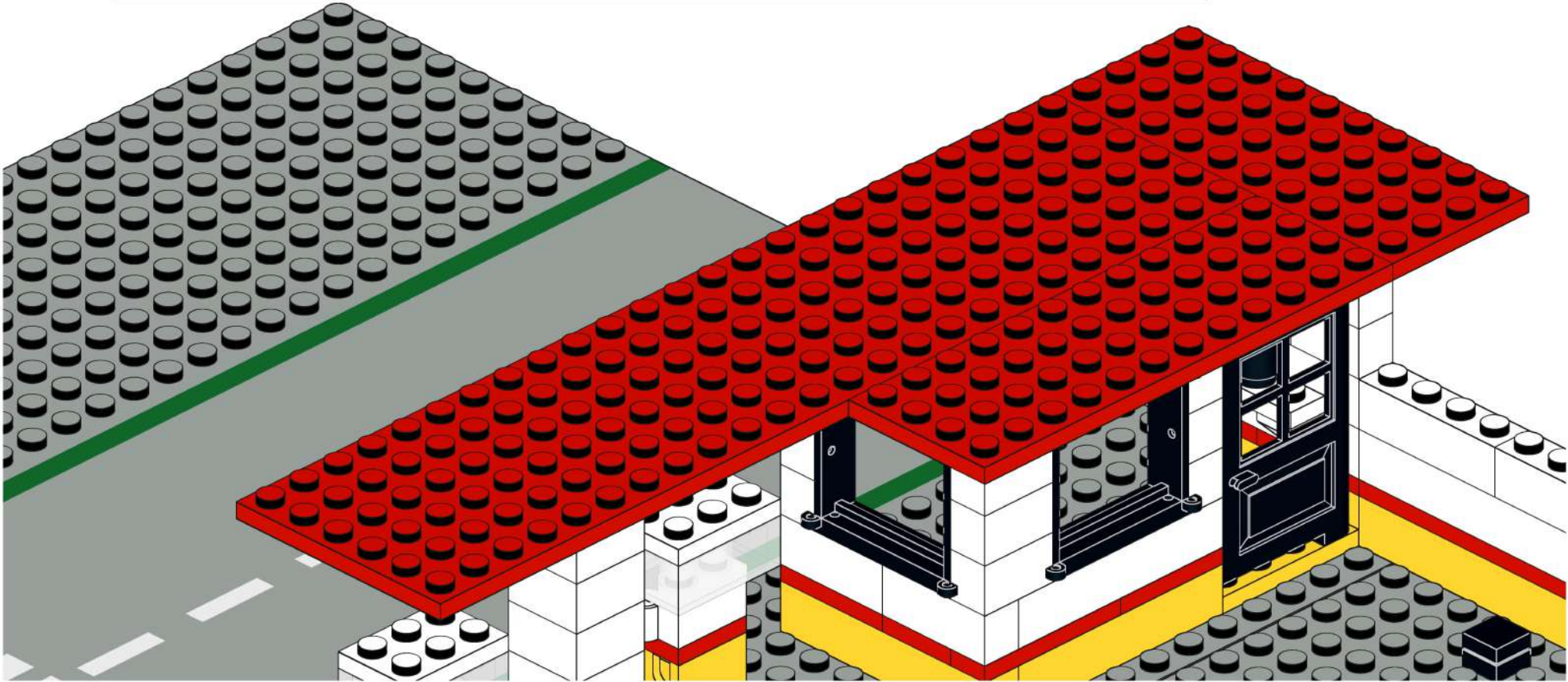
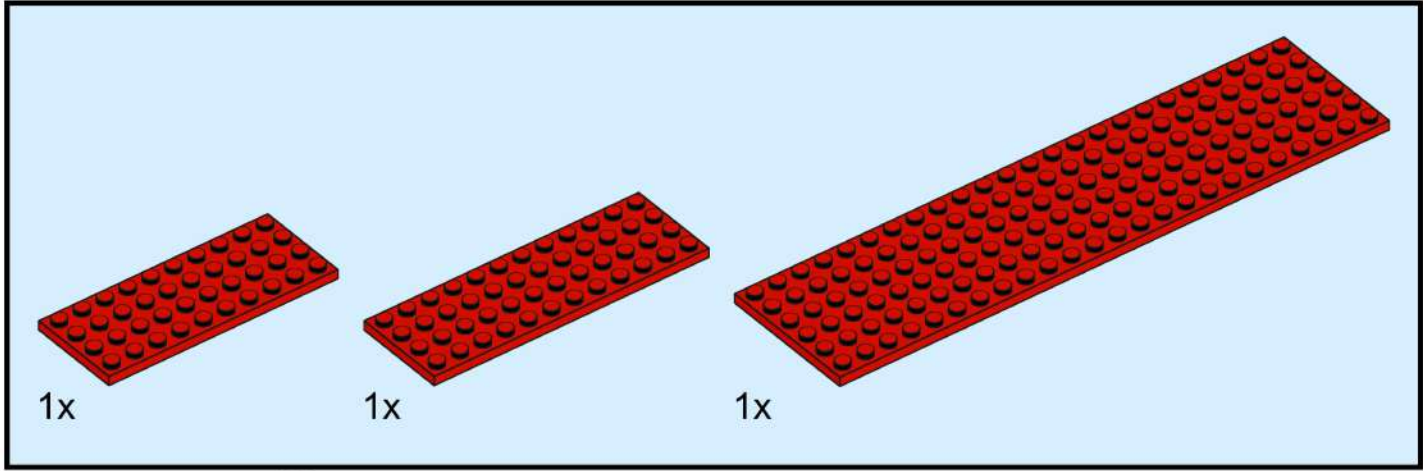

10

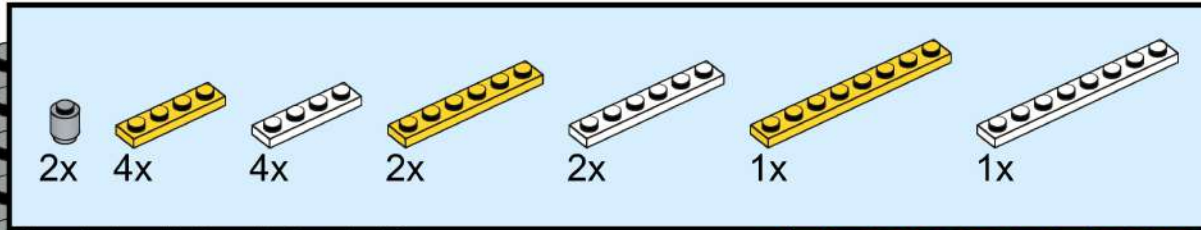

2x 4x 4x 2x 2x 1x 1x

This block contains a parts list for step 10. It includes a grey axle pin (2x), a yellow 4-hole Technic beam (4x), a white 4-hole Technic beam (4x), a yellow 6-hole Technic beam (2x), a white 6-hole Technic beam (2x), a yellow 8-hole Technic beam (1x), and a white 8-hole Technic beam (1x).

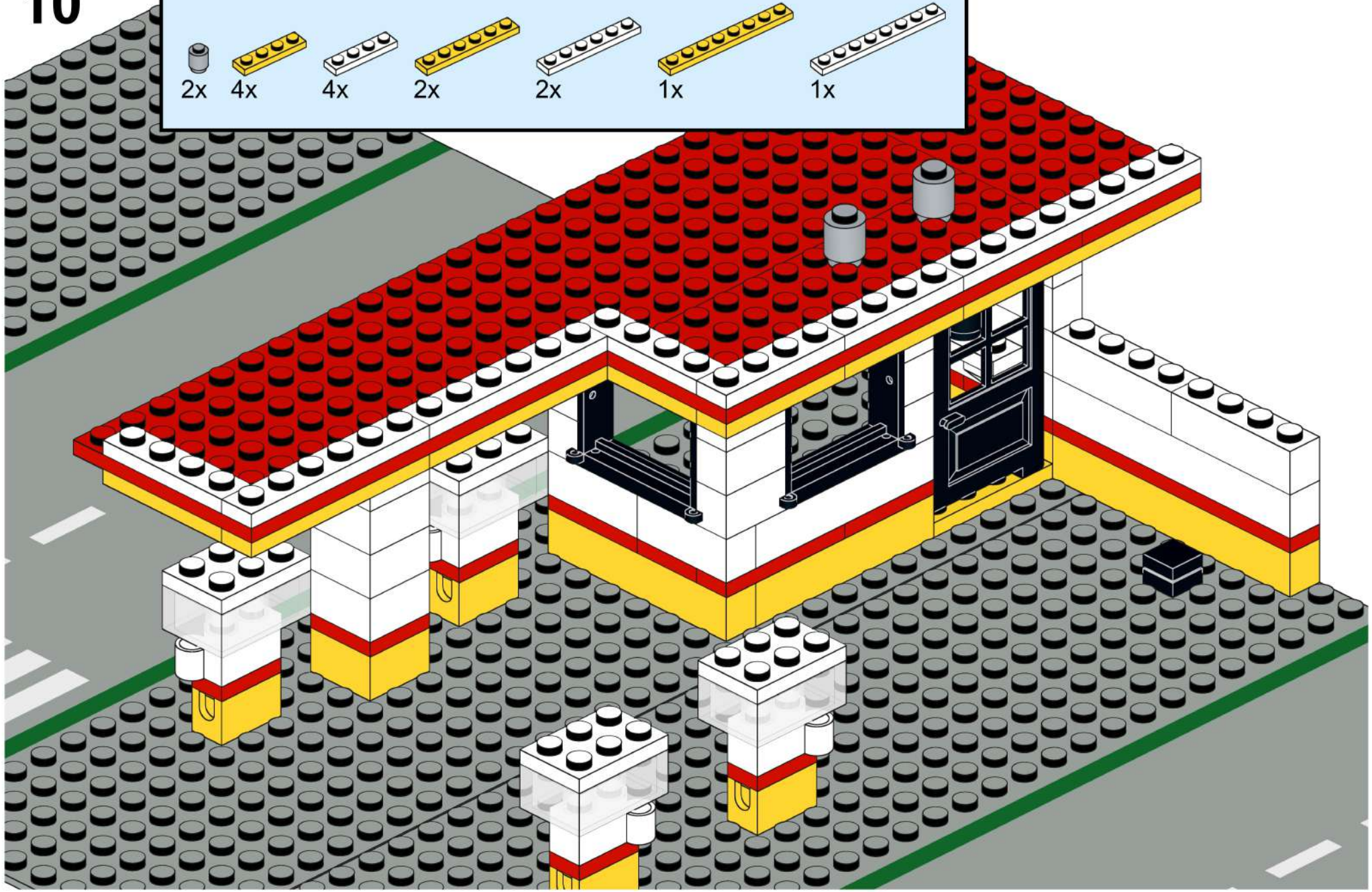

11

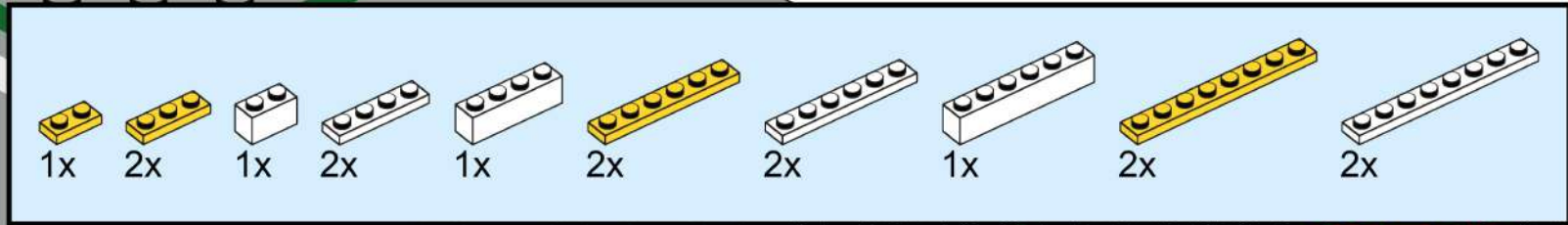

1x 2x 1x 2x 1x 2x 2x 1x 2x 2x

This block contains a list of LEGO parts with their respective quantities. From left to right: a yellow 1x2 Technic brick (1x), a yellow 1x3 Technic brick (2x), a white 1x2 Technic brick (1x), a white 1x4 Technic brick (2x), a white 1x5 Technic brick (1x), a yellow 1x6 Technic brick (2x), a white 1x6 Technic brick (2x), a white 1x8 Technic brick (1x), a yellow 1x8 Technic brick (2x), and a white 1x10 Technic brick (2x).

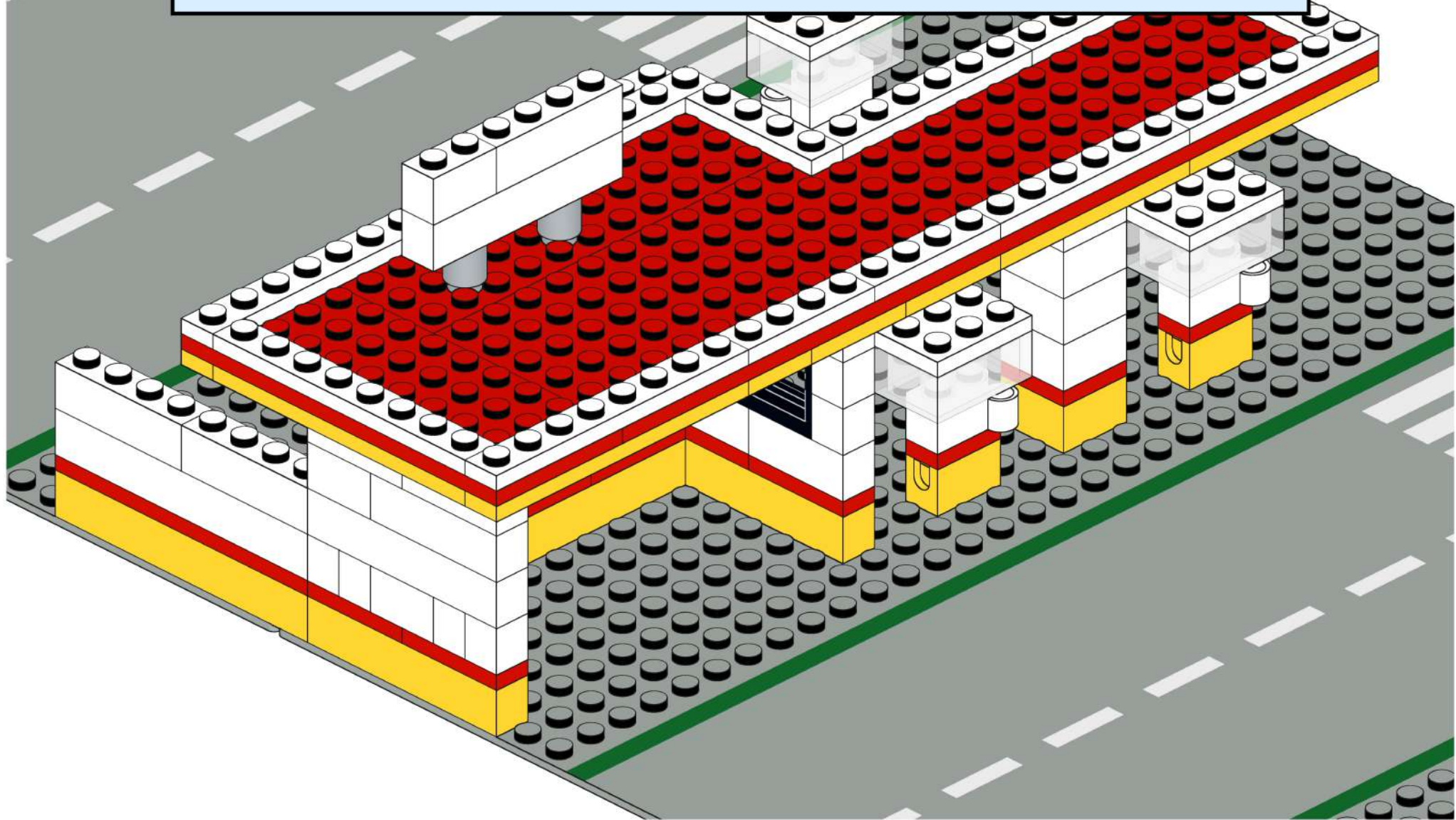

12

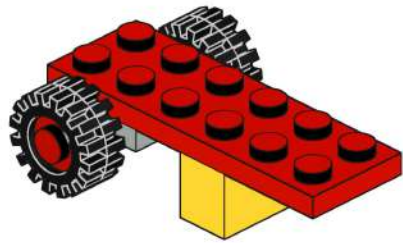
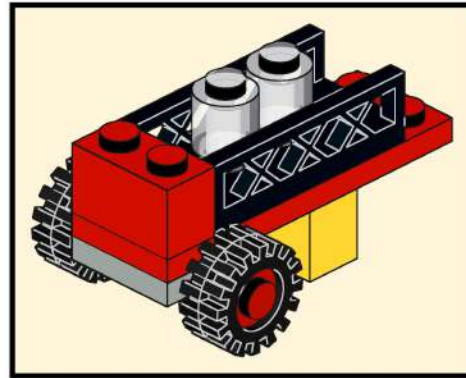
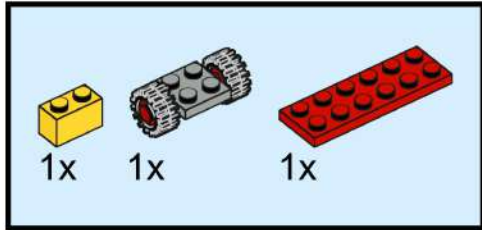

13

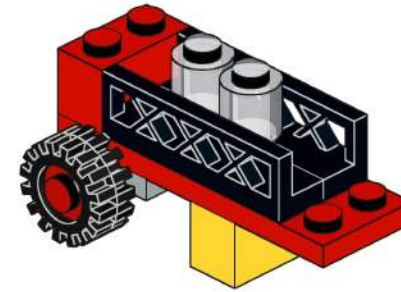
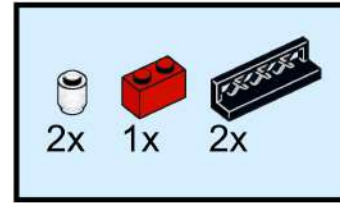

14

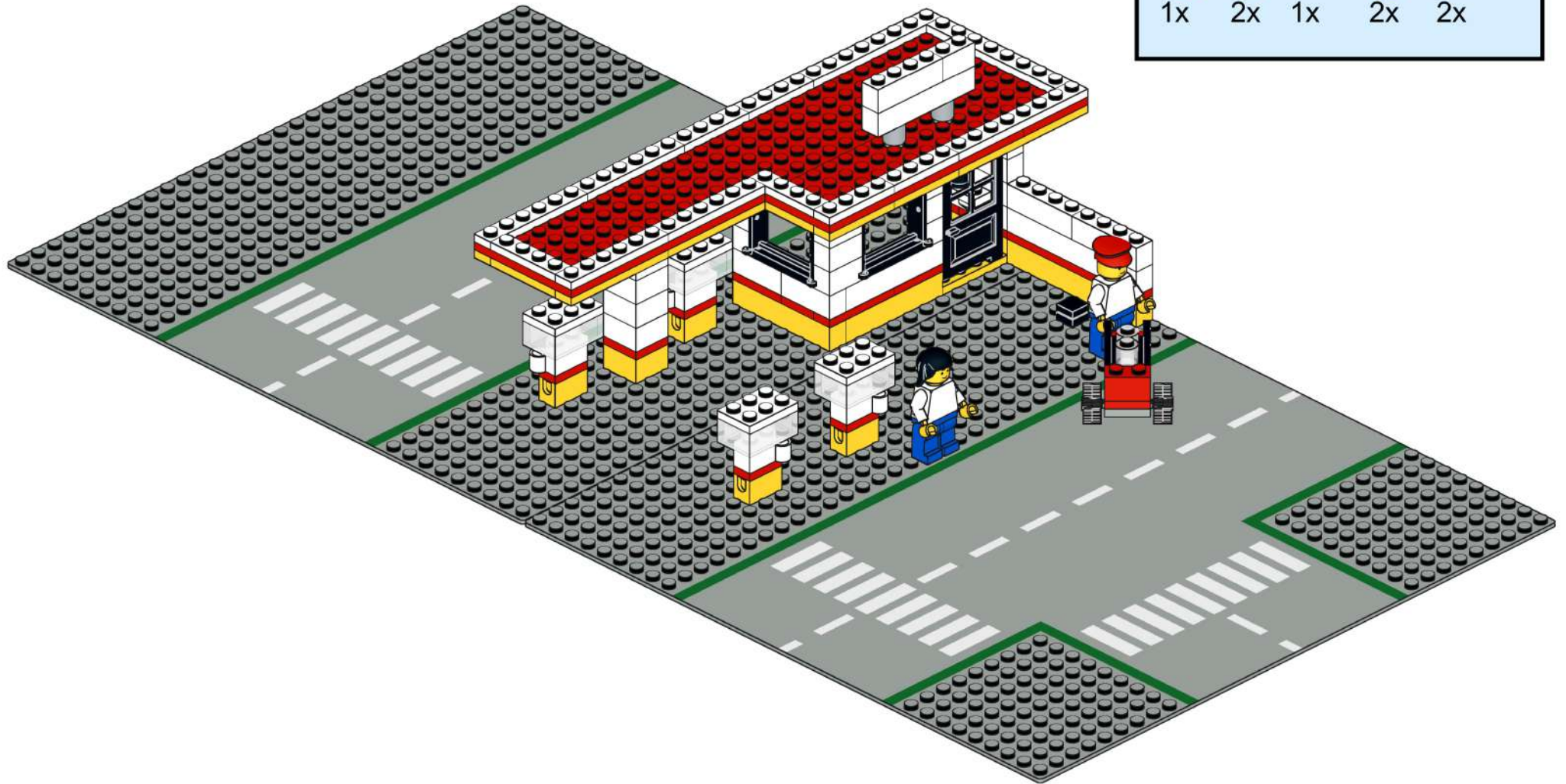

1x
3070b, 11

2x
3024, 11

1x
3062a, 11

1x
x103, 11

2x
3633, 11

1x
606p02, 9

2x
3853, 11

1x
3861, 11

1x
122c01assy2, 9

1x
608p01, 9

2x
3062a, 86

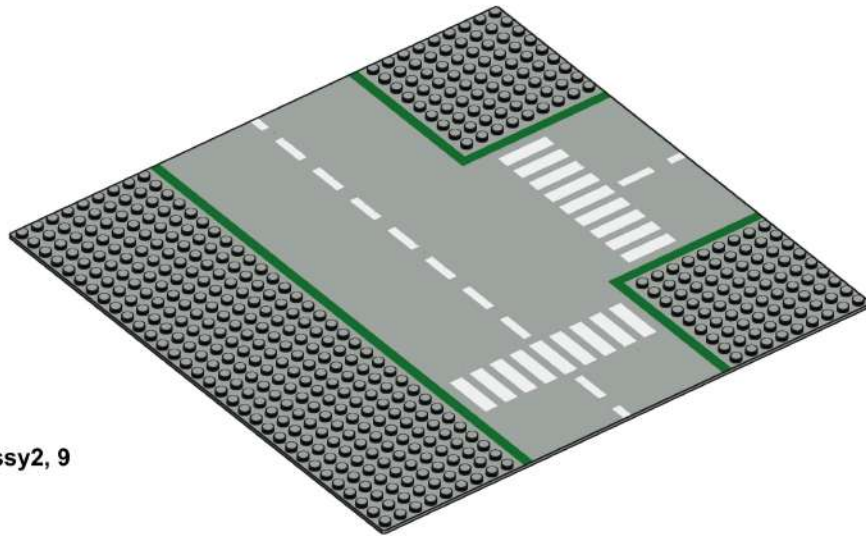
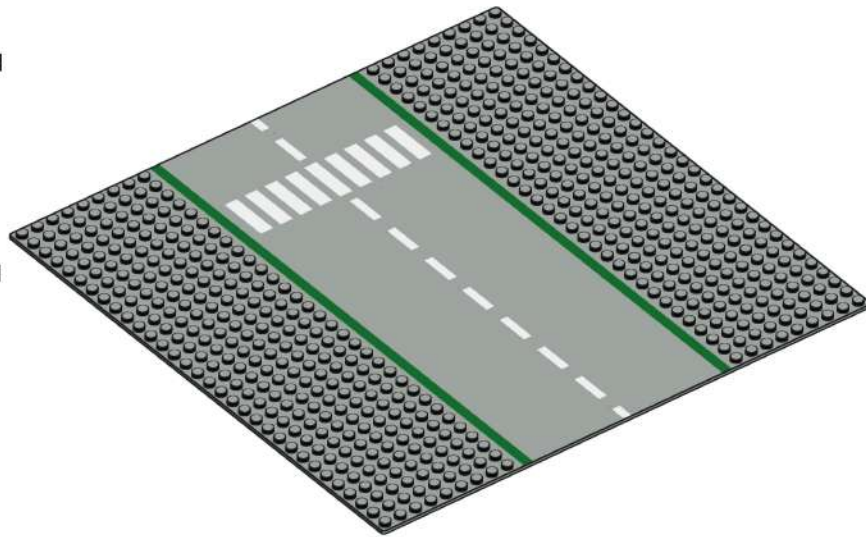

8x
3005, 1

2x
973c01, 1

7x
3004, 1

4x
3666, 1

2x
3665, 1

4x
3009, 1

4x
3003, 1

2x
3660, 1

3x
3460, 1

4x
3831, 1

2x
3008, 1

6x
3622, 1

5x
3023, 5

4x
3021, 1

1x
3624, 5

7x
3710, 1

1x
3004, 5

4x
3010, 1

1x
3022, 5

4x
3623, 5

1x
3710, 5

1x
3795, 5

1x
3460, 5

1x
3030, 5

1x
3029, 5

1x
3026, 5

1x
3023, 3

2x
3626ap01, 3

2x
970c00, 7

4x
3317, 3

1x
3005, 12

1x
3004, 3

2x
3062a, 12

1x
3003, 3

4x
3002, 12

2x
3623, 3

5x
3710, 3

4x
3666, 3

3x
3009, 3

3x
3460, 3

1x
3008, 3