

1

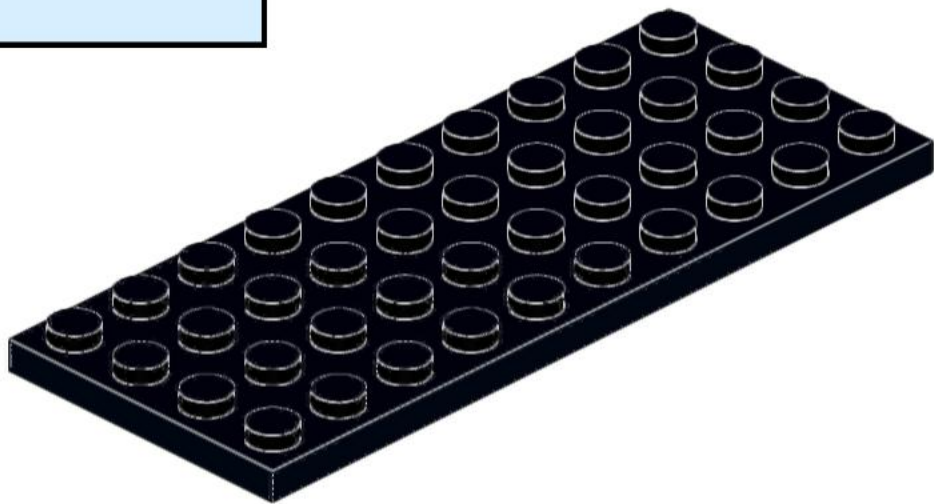

2

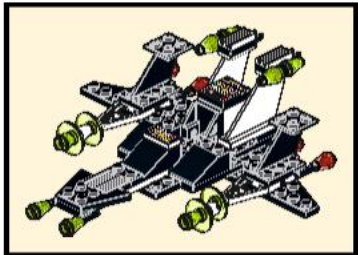
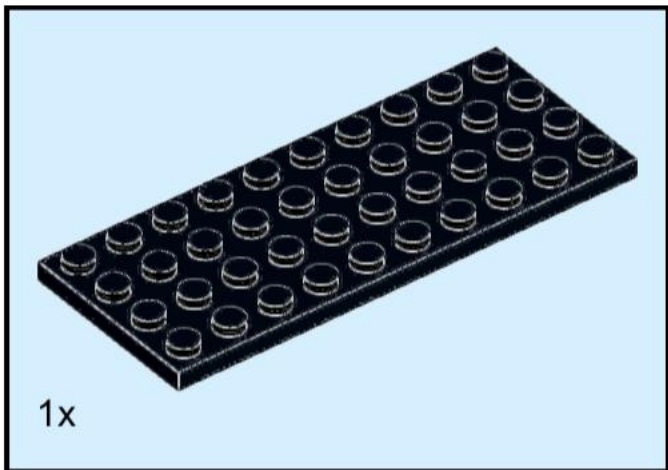
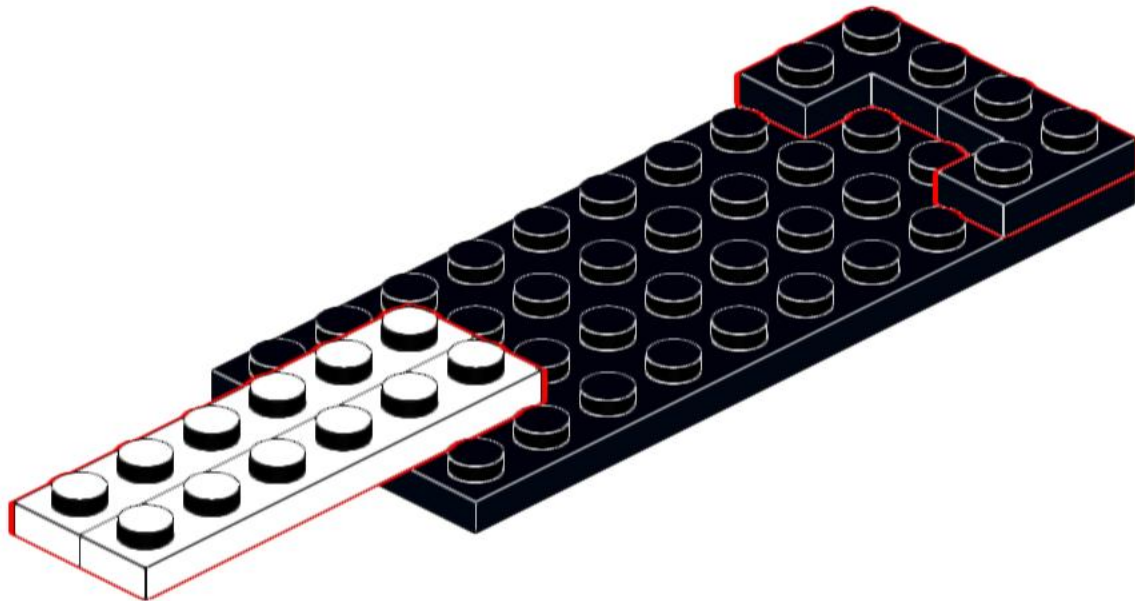
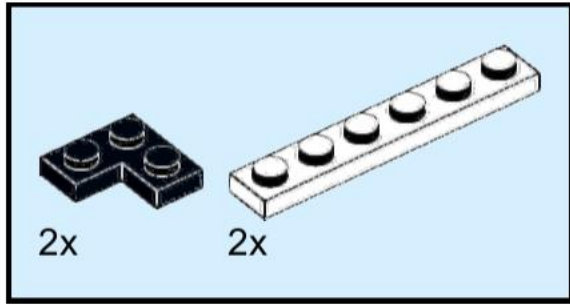

3

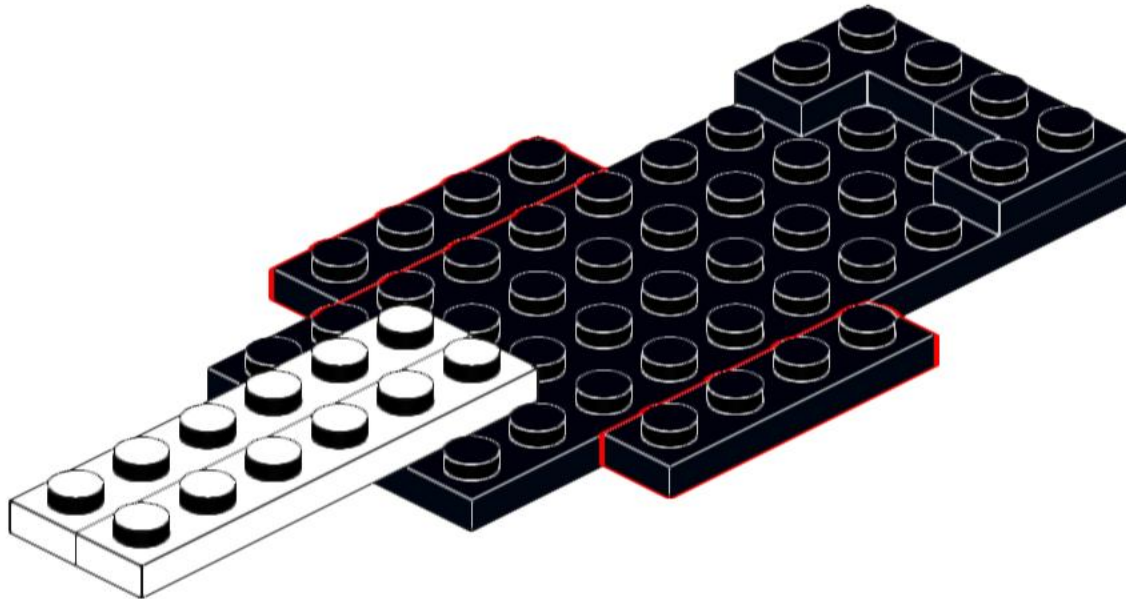
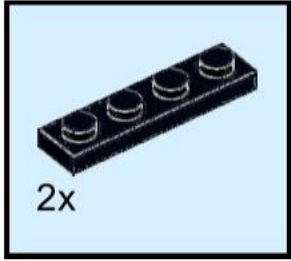

4

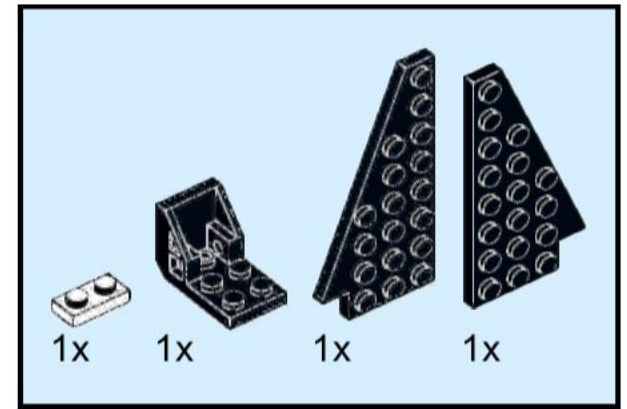
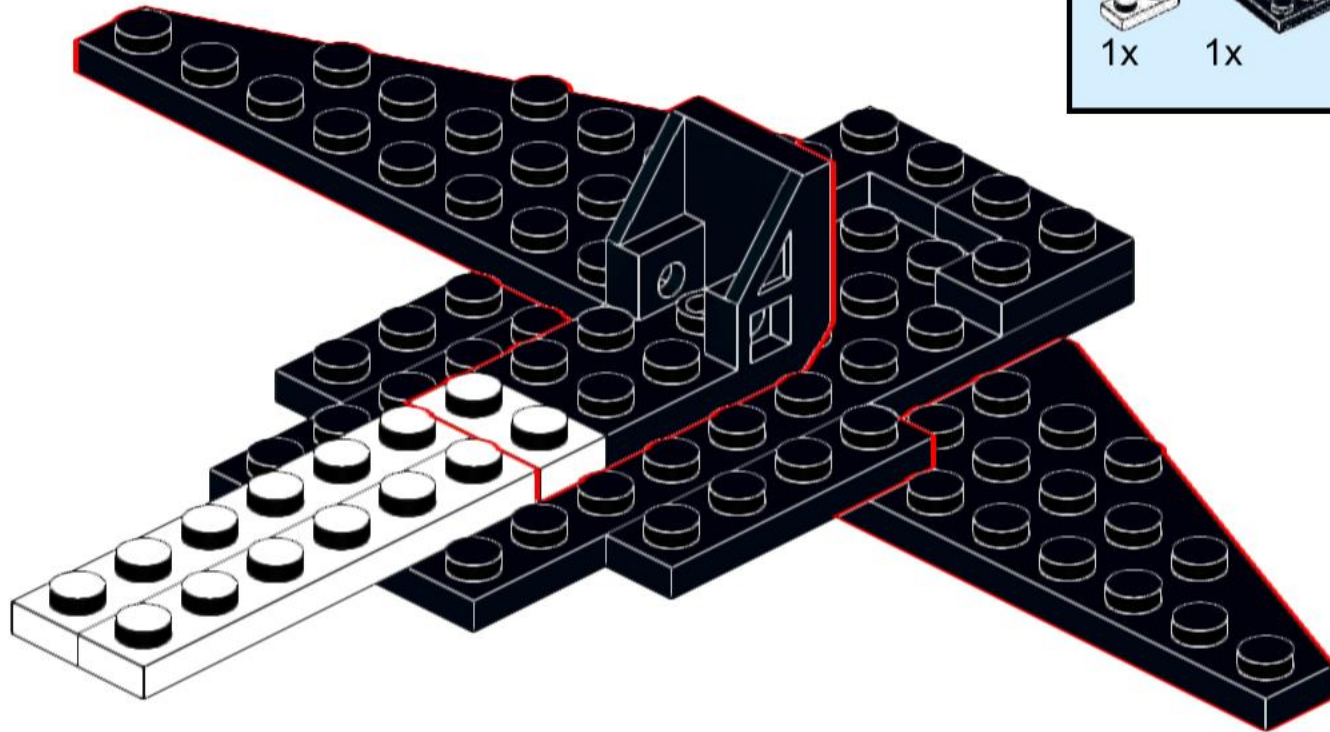

5

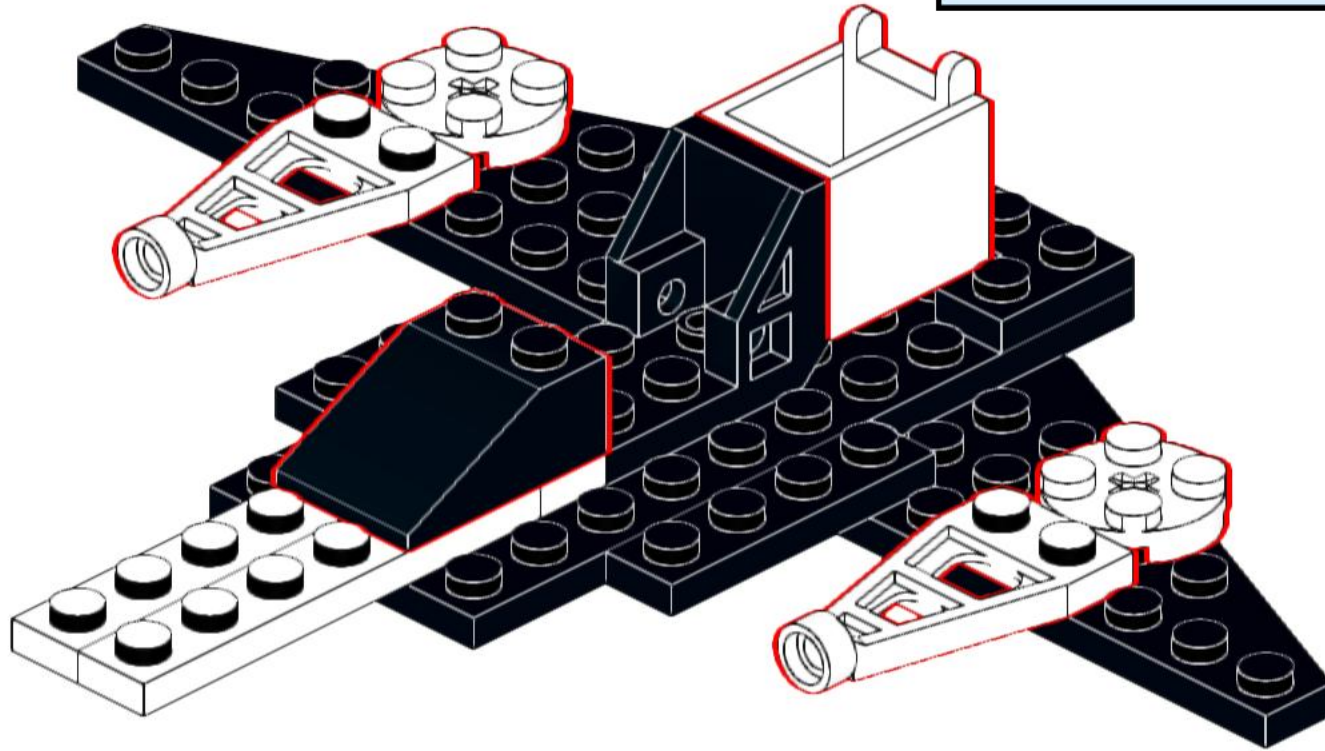
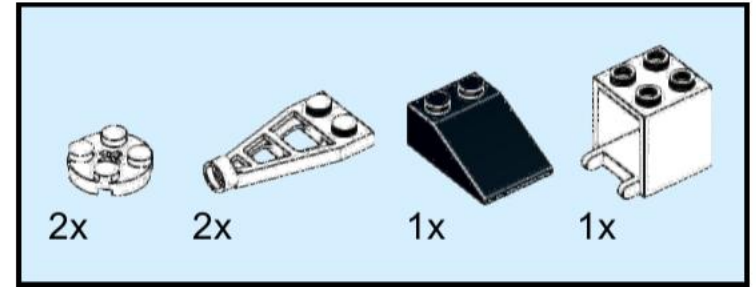

6

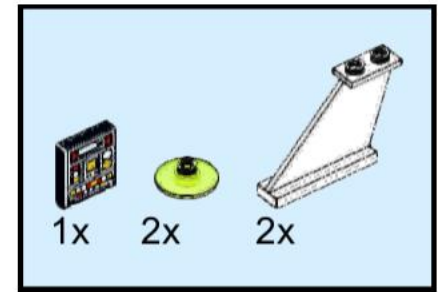
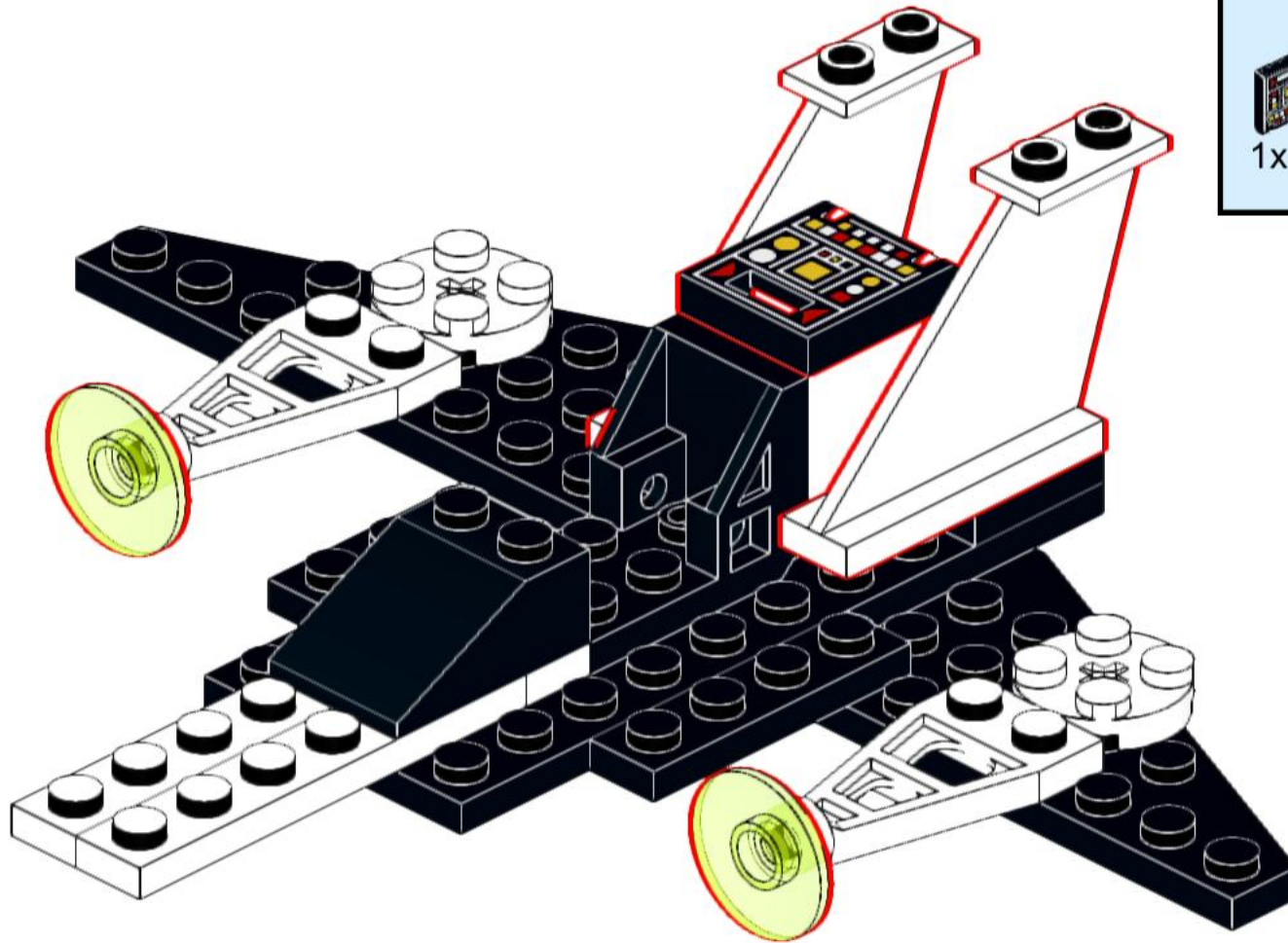

7

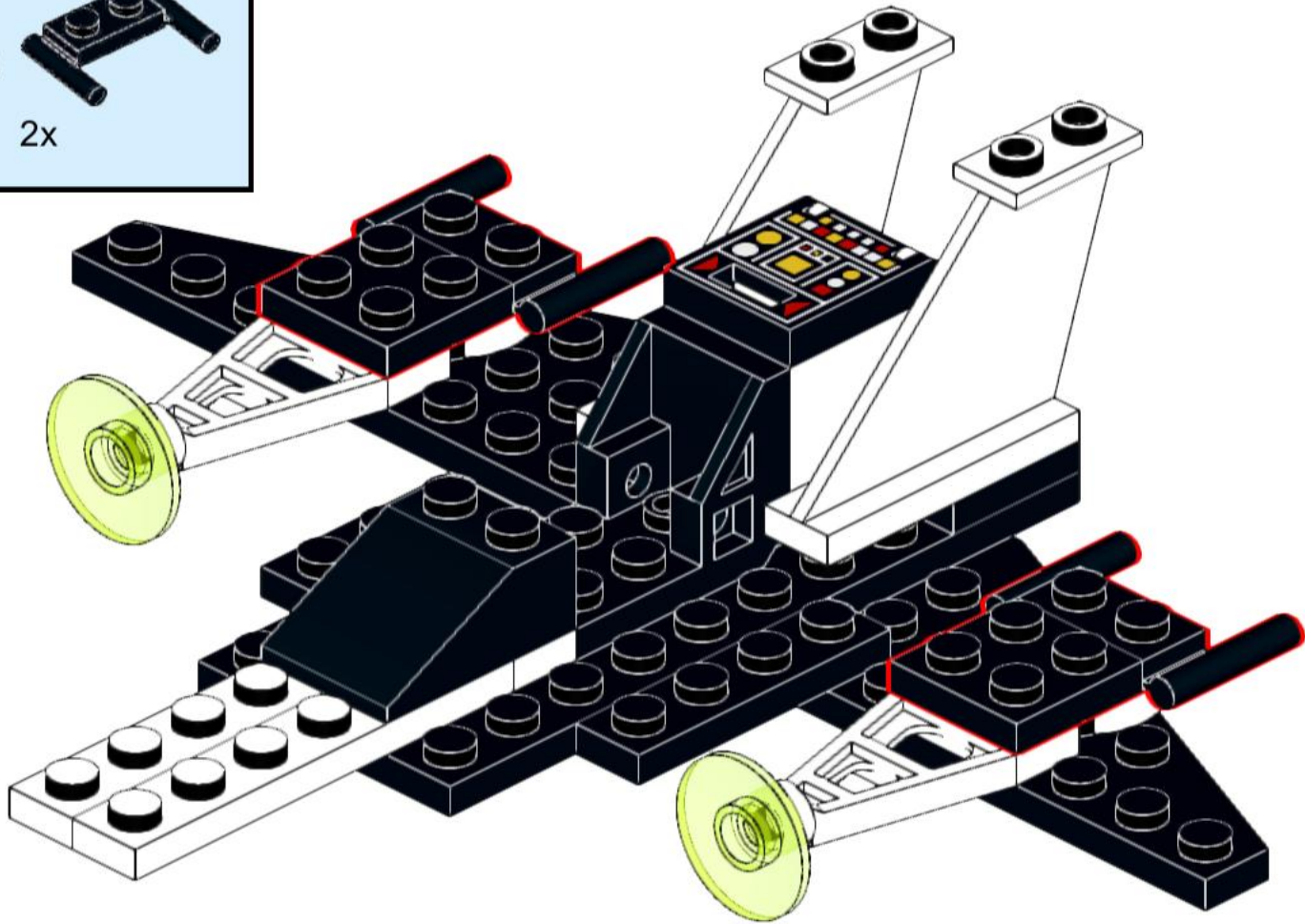
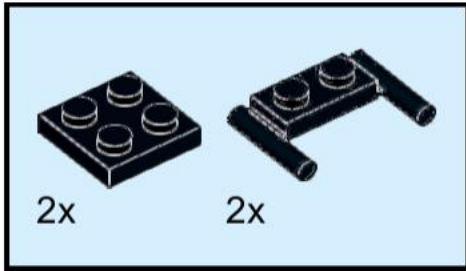



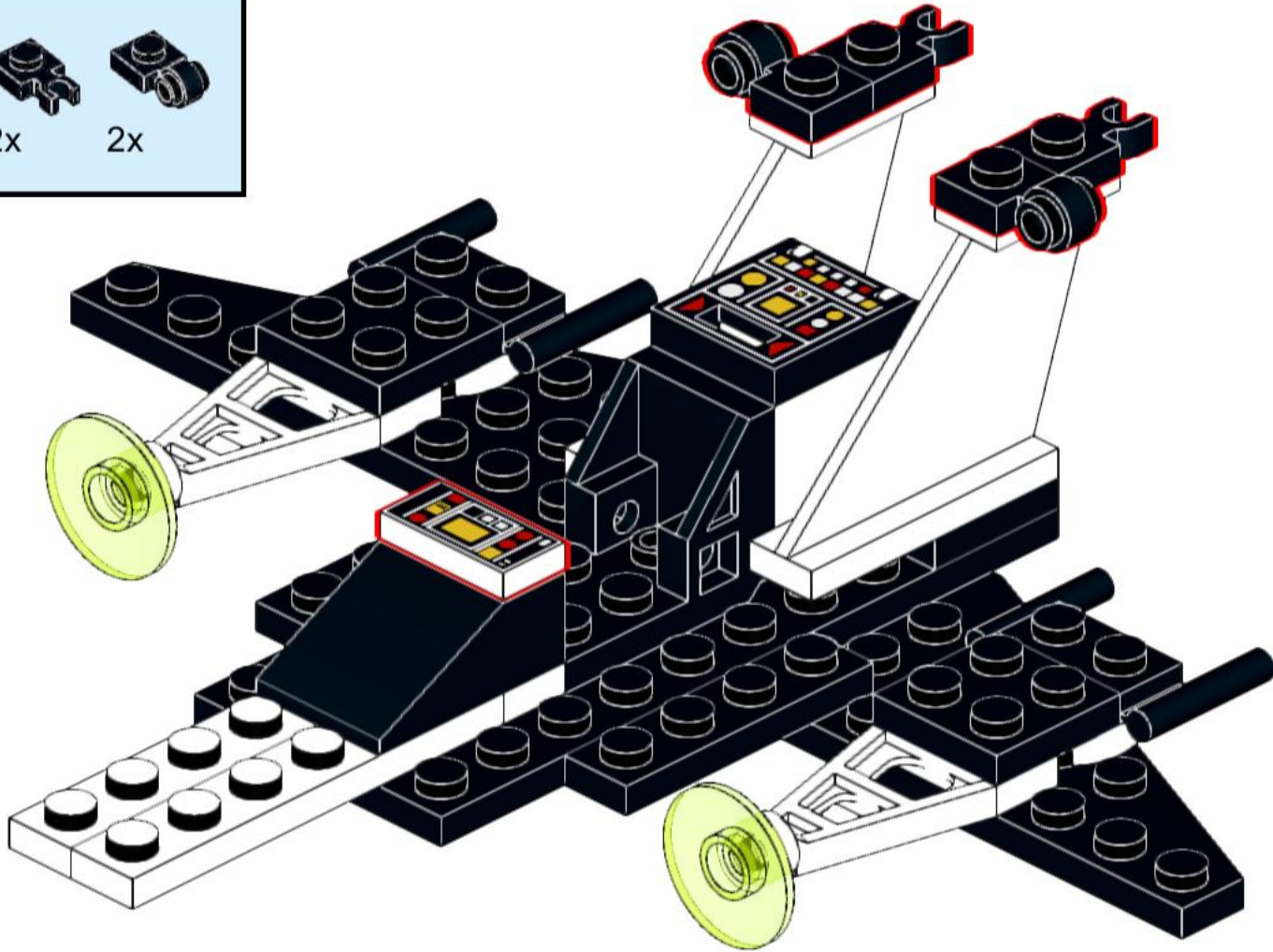
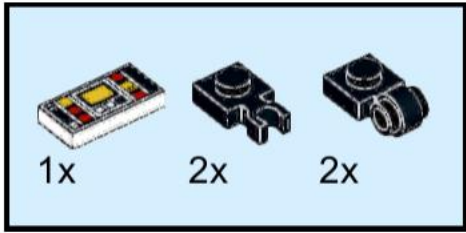

8

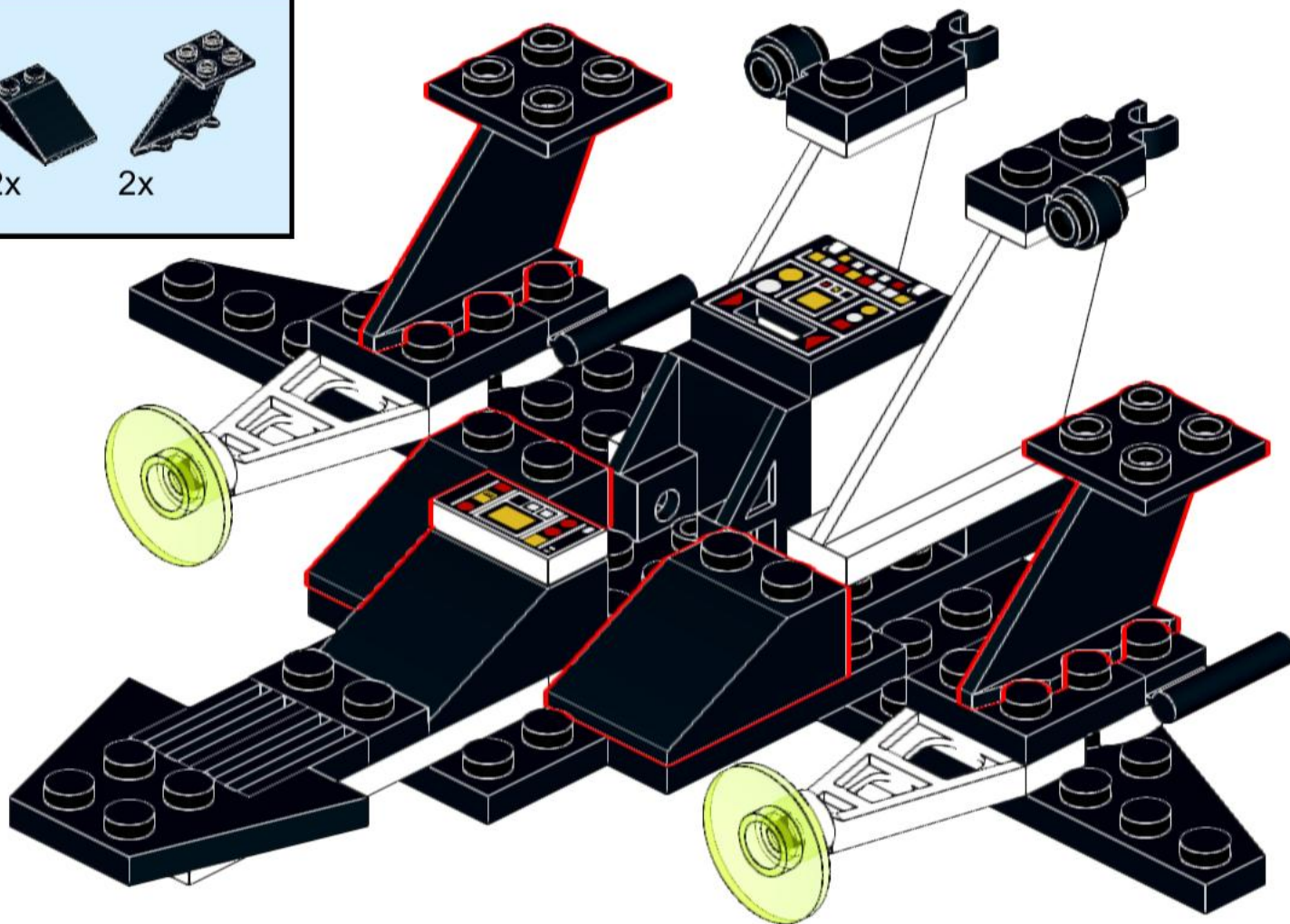
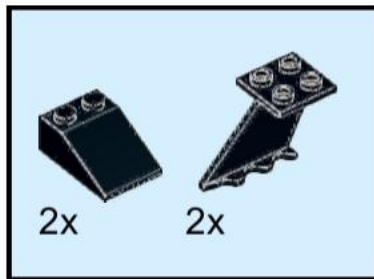

10



11

			
2x	2x	2x	1x

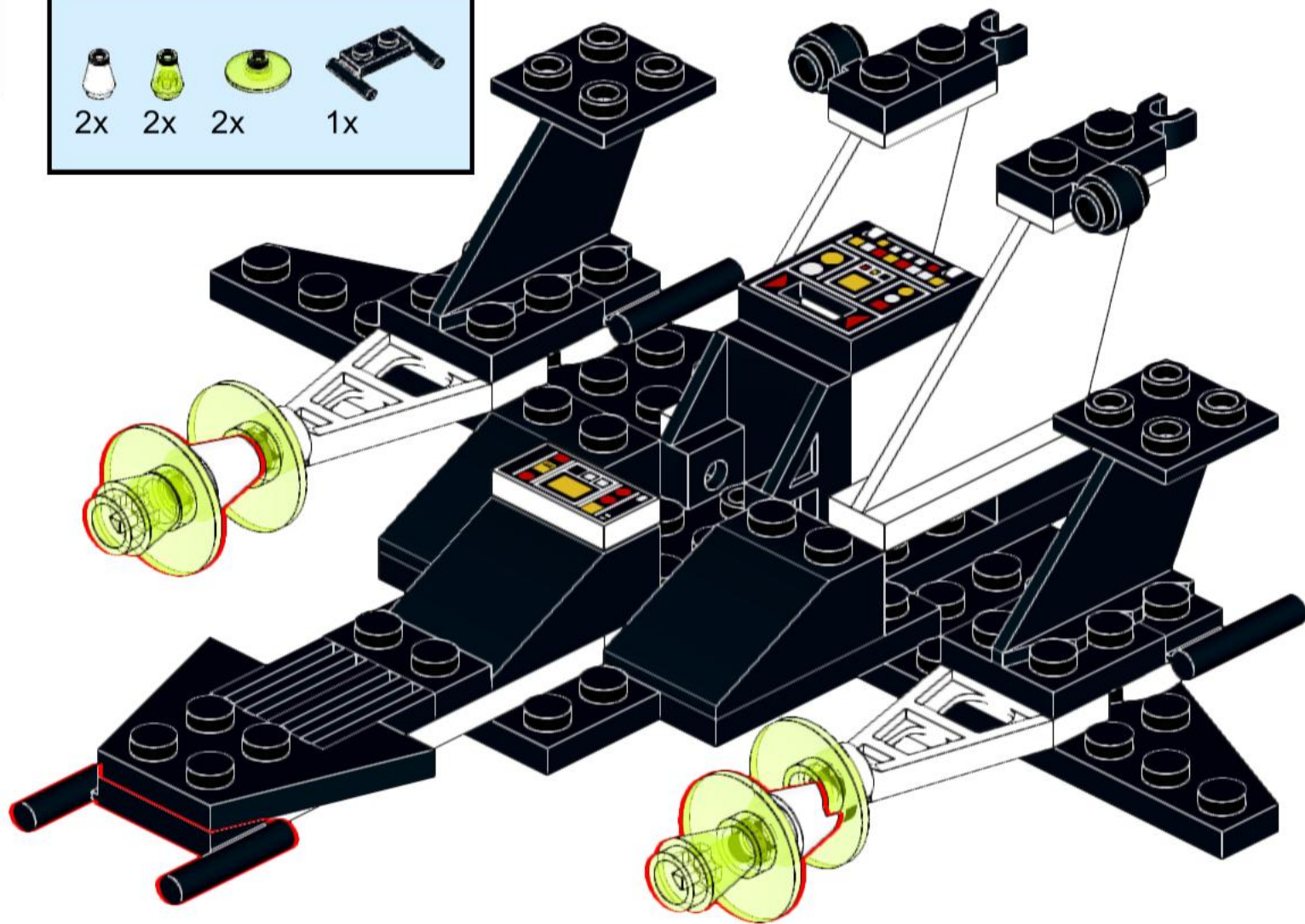

12

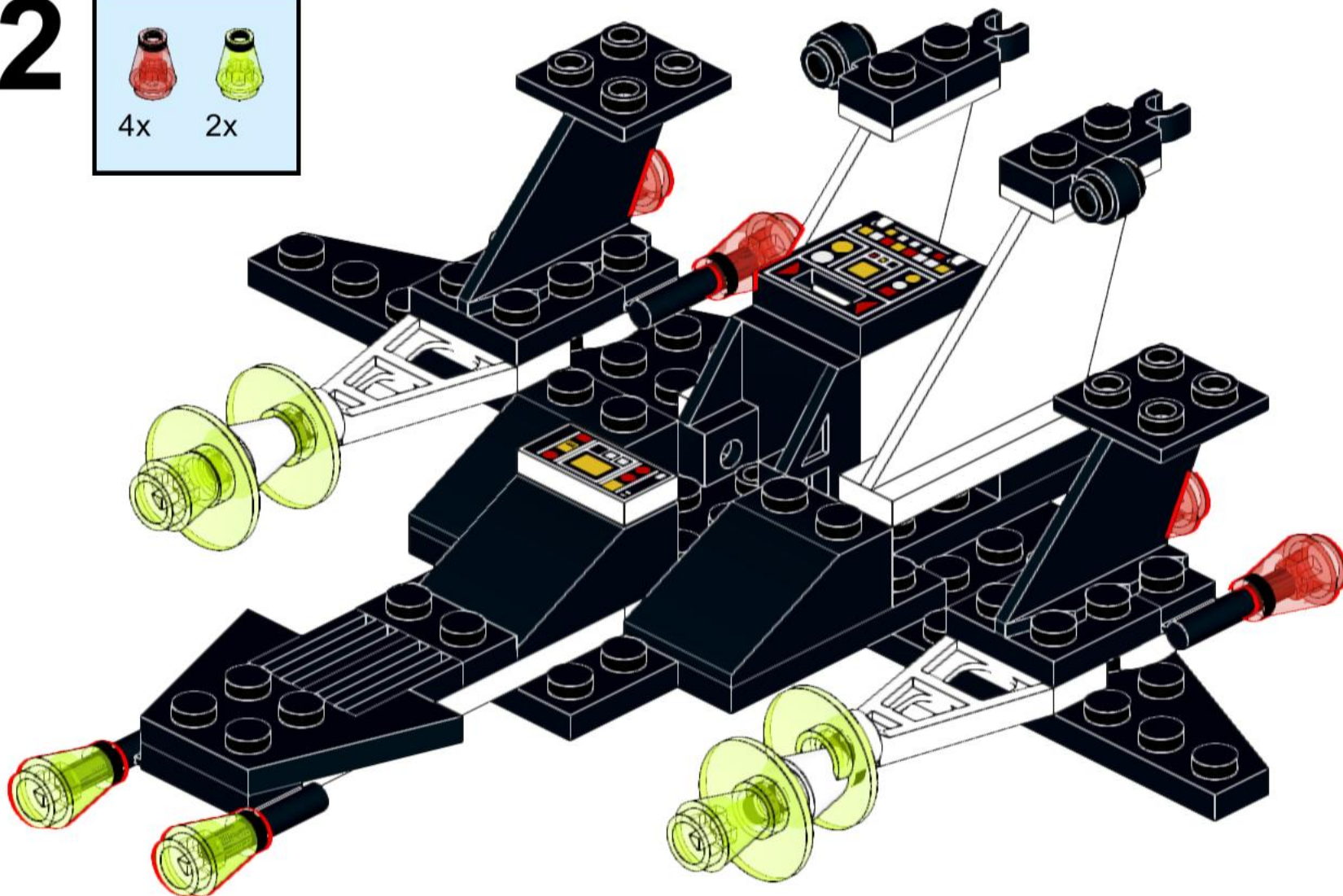
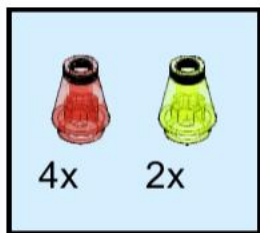

13

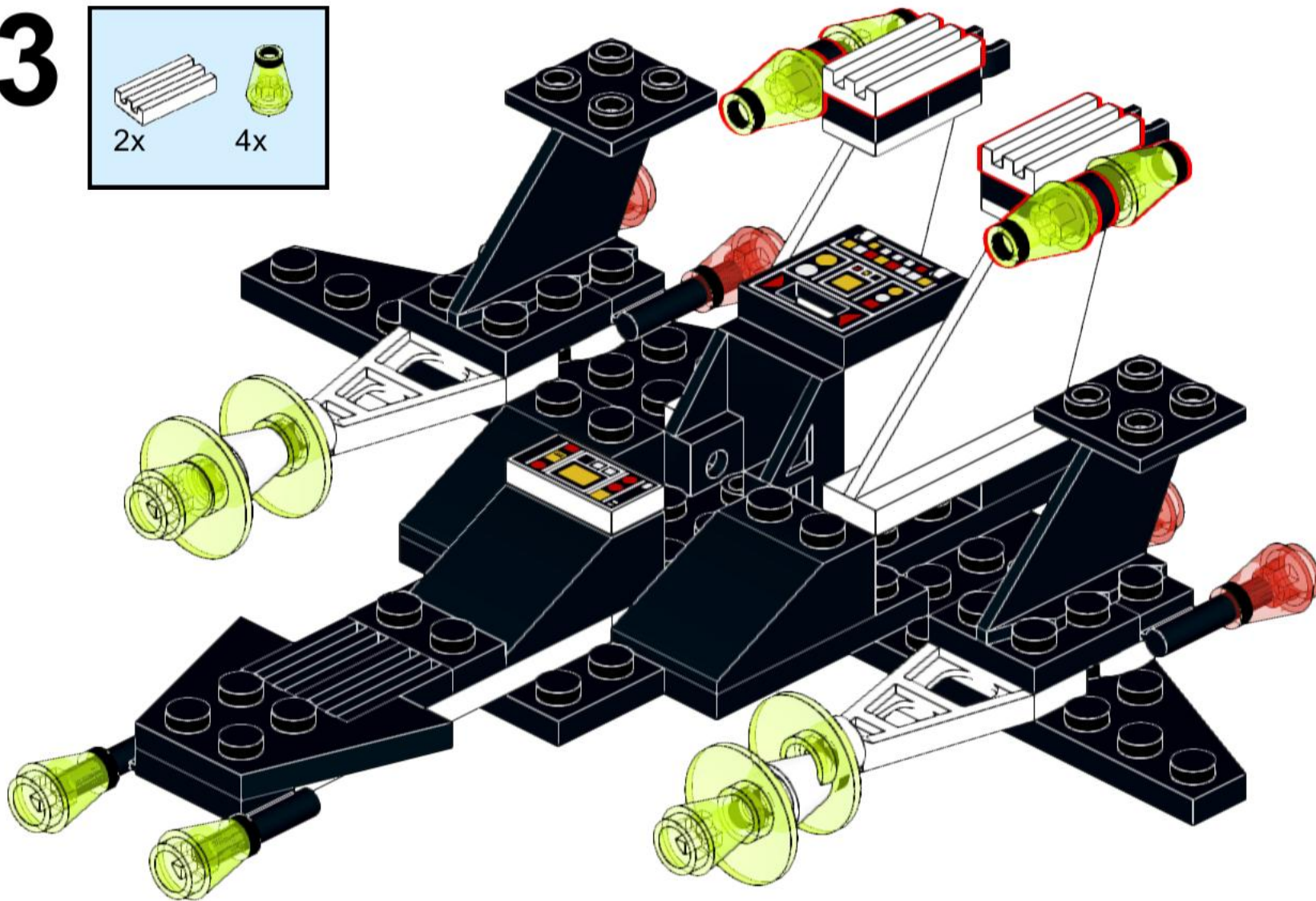
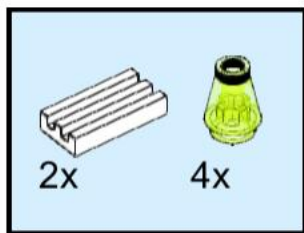

14

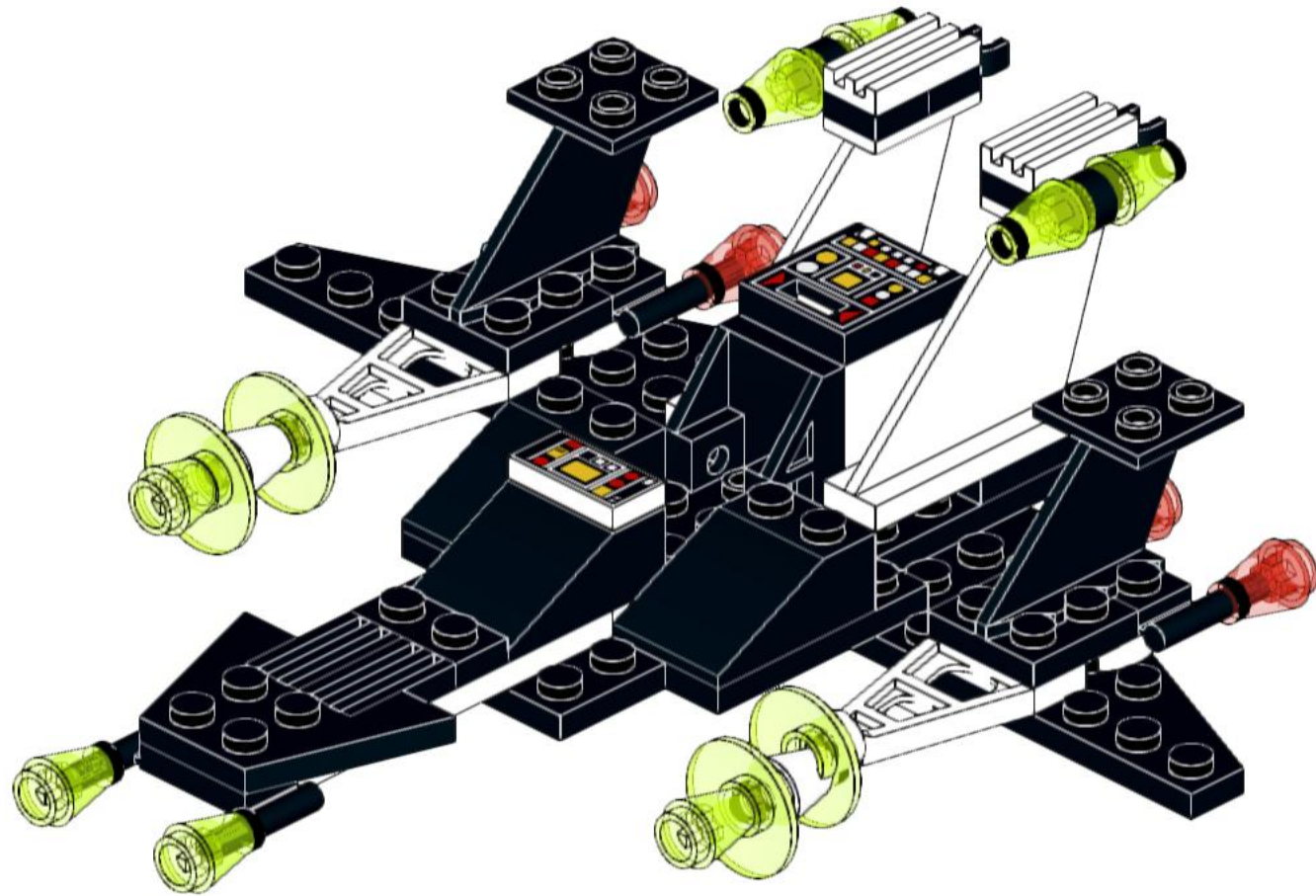

15

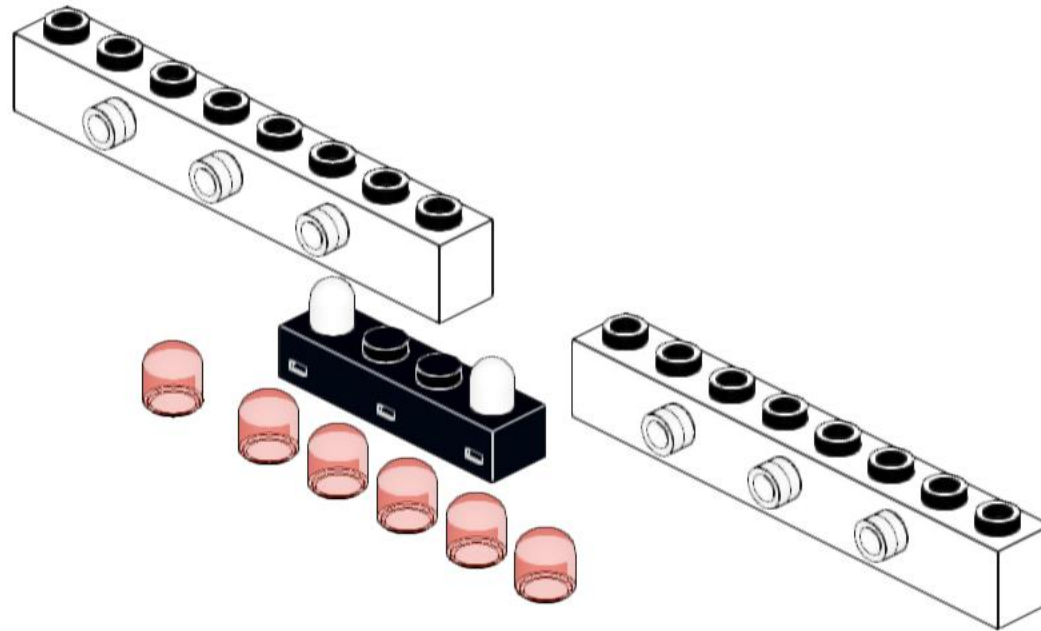
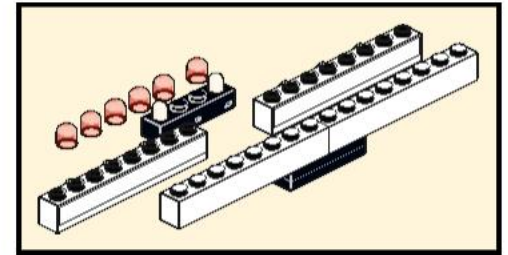
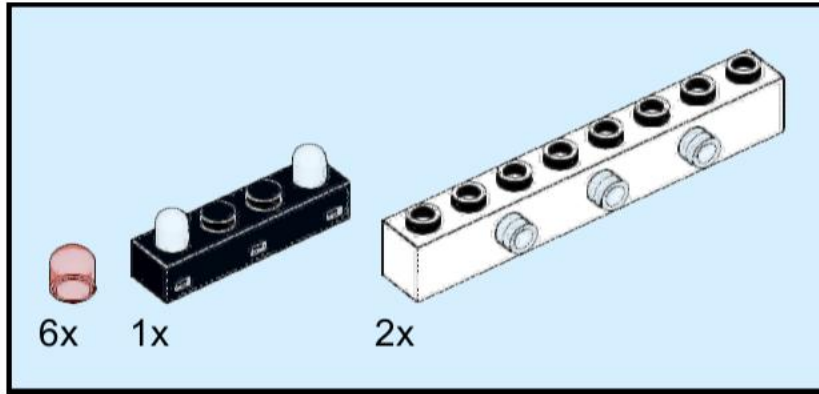

16

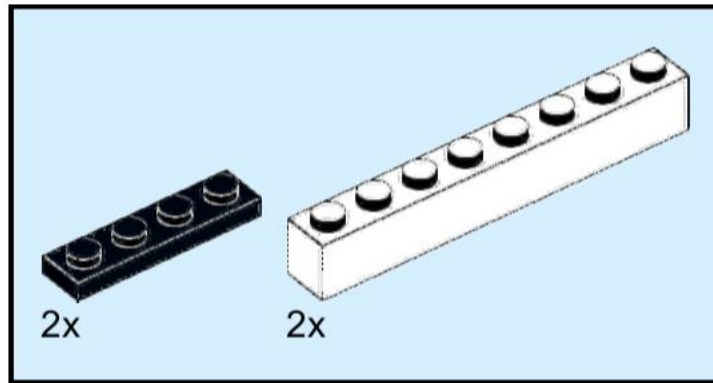

The editor did not let me put these pieces together so here is the example of stacking. Attach the red caps over the white lights. They appear at the front lower part of the base as the simple two 1x8 white bricks

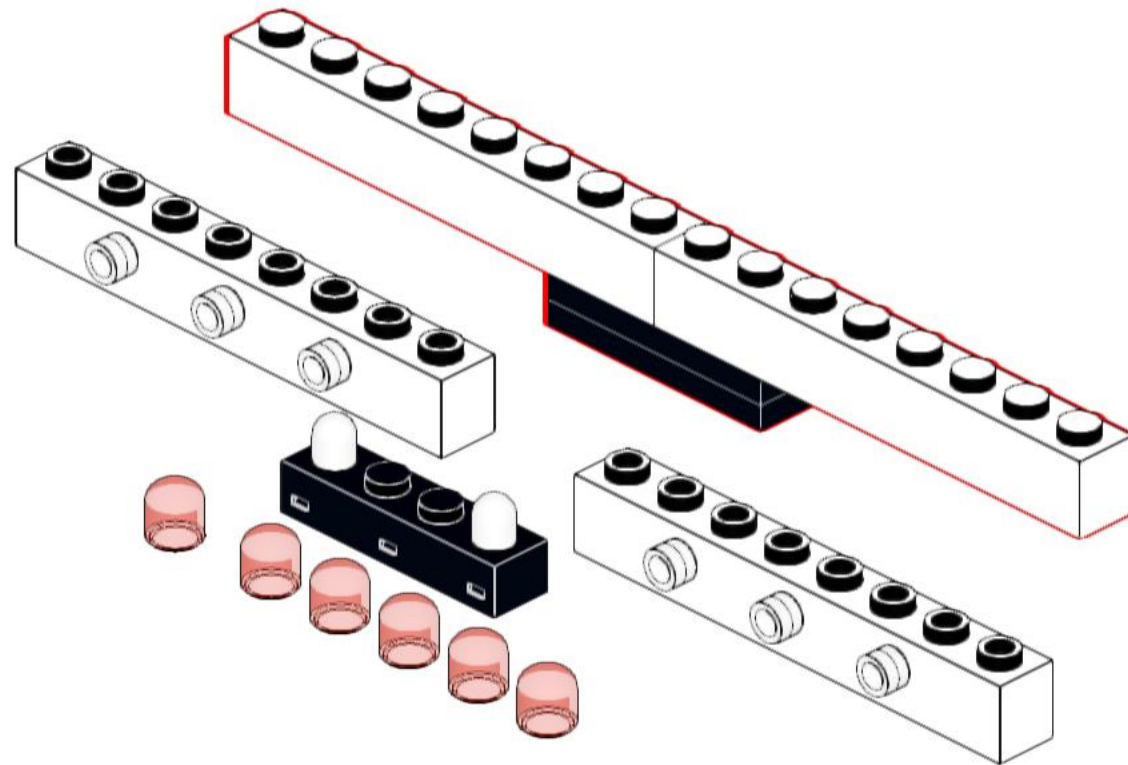

17

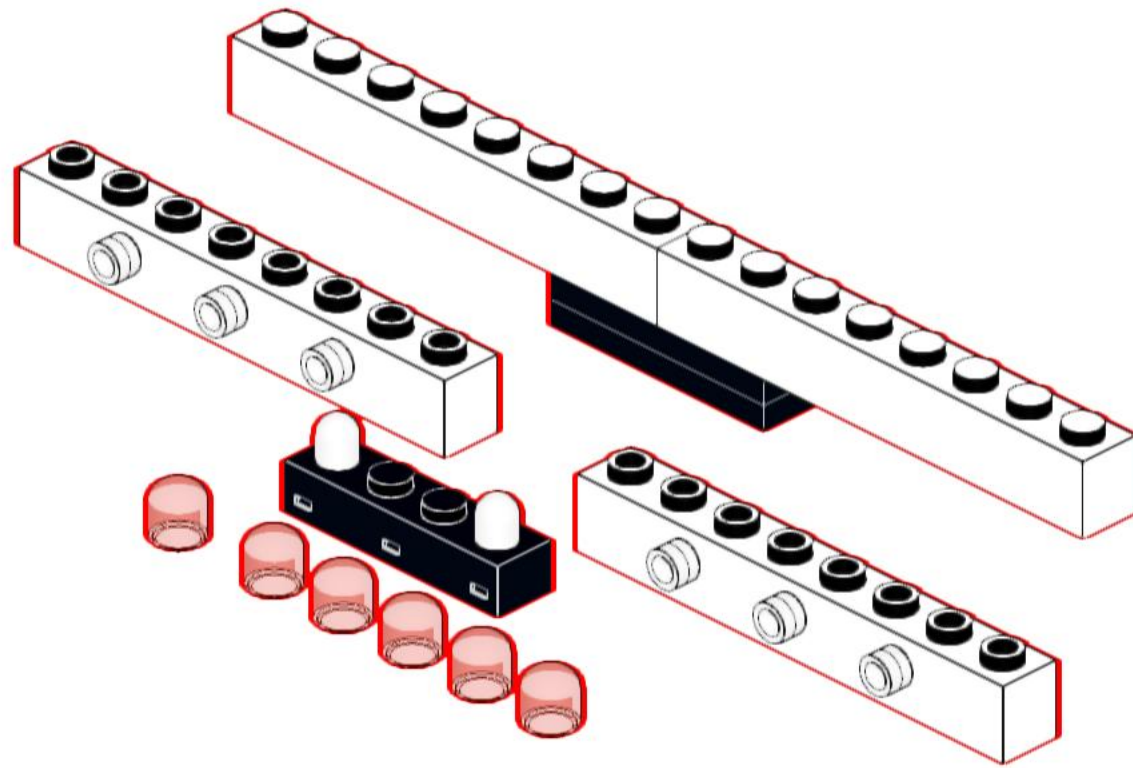

18

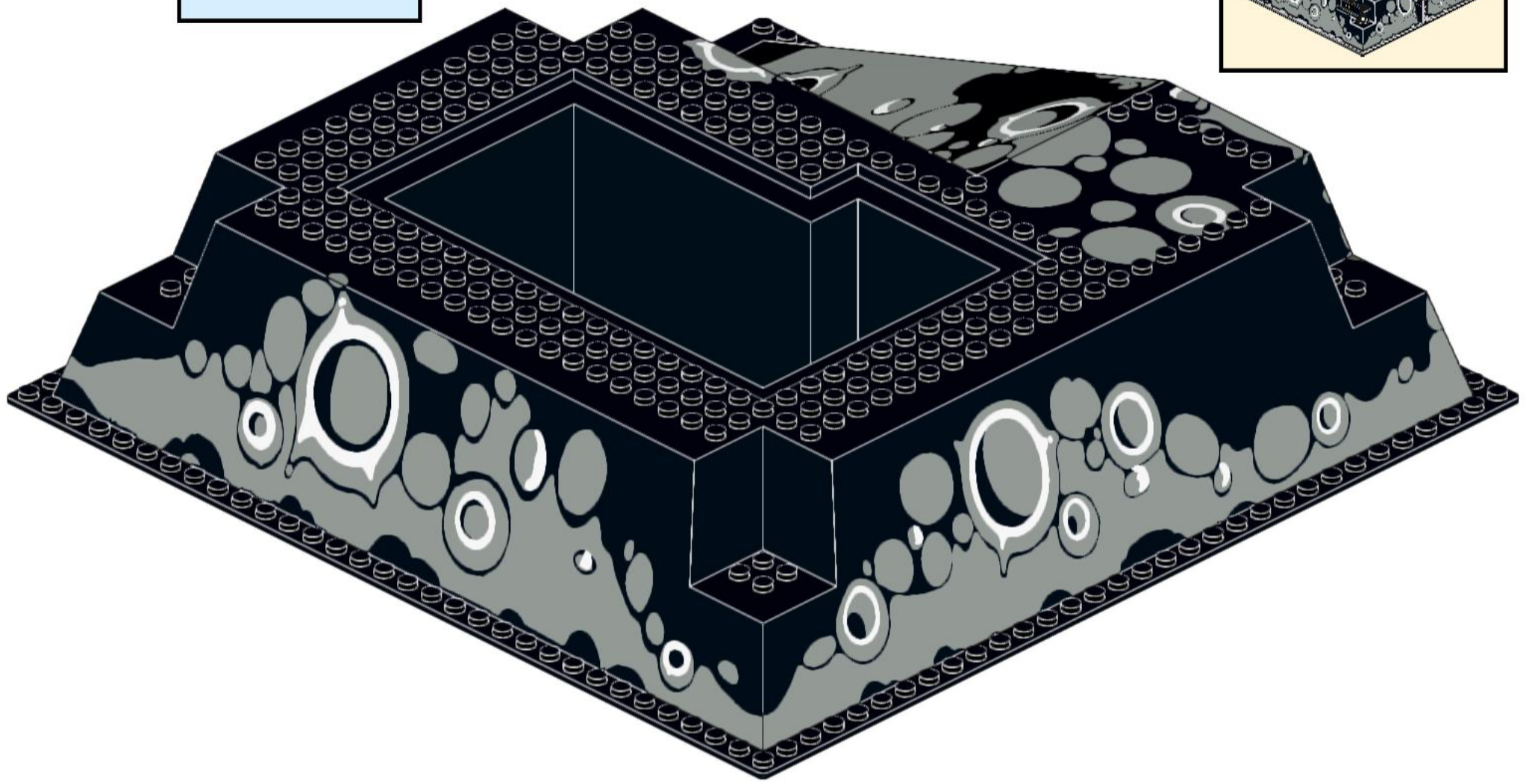
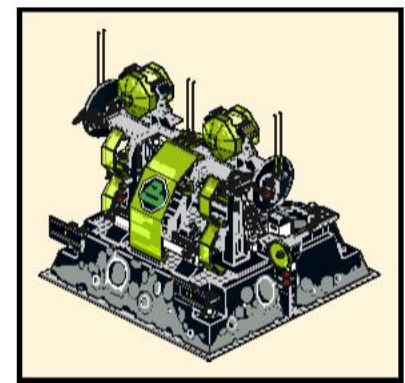
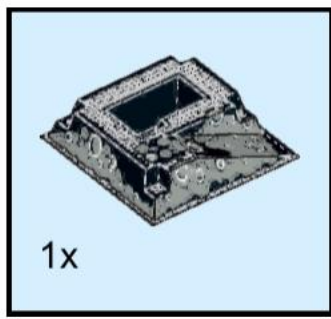

19

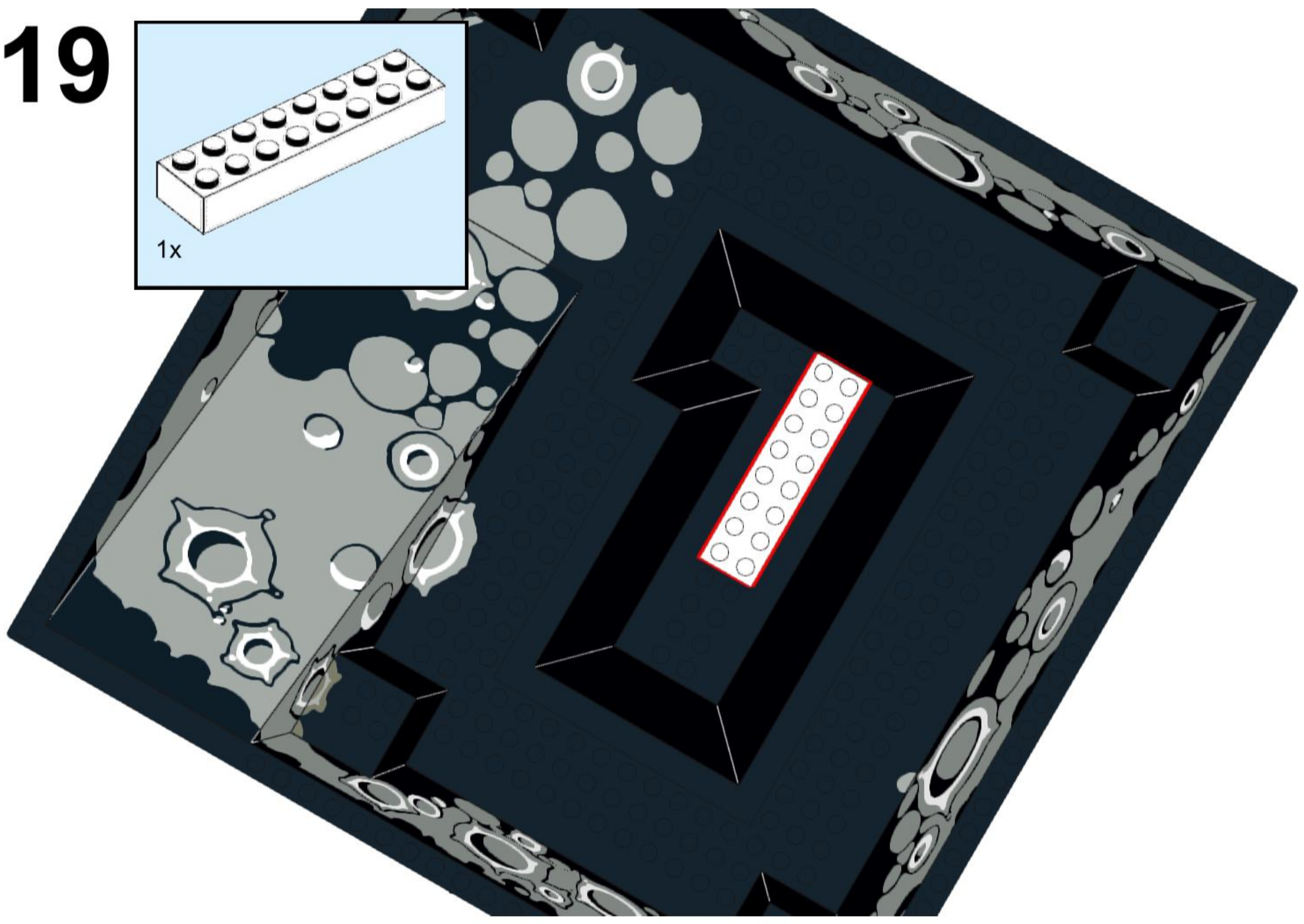
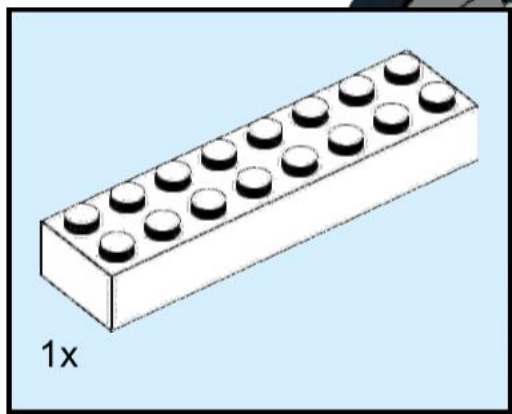

20

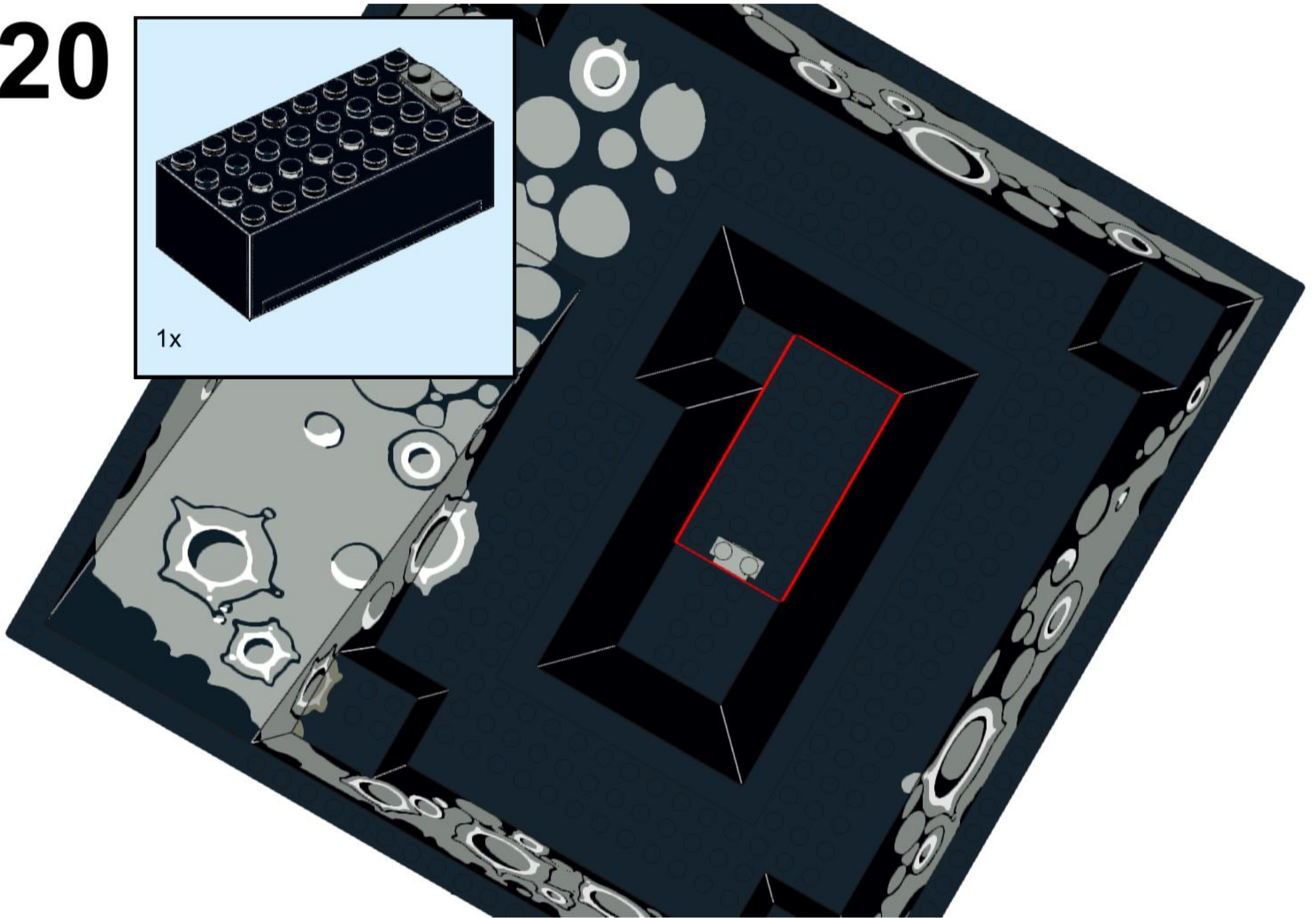
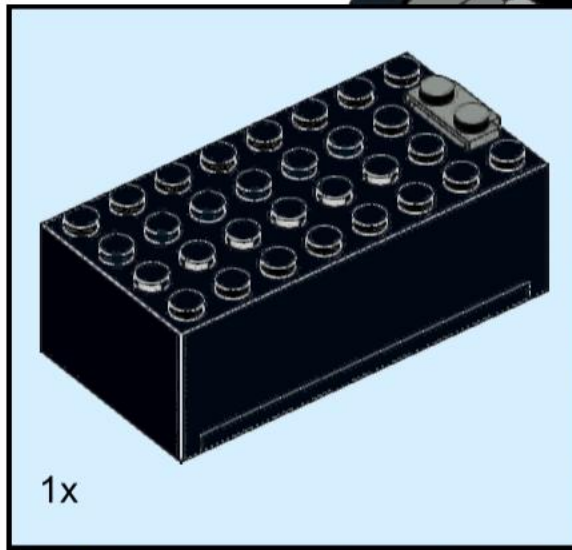

21

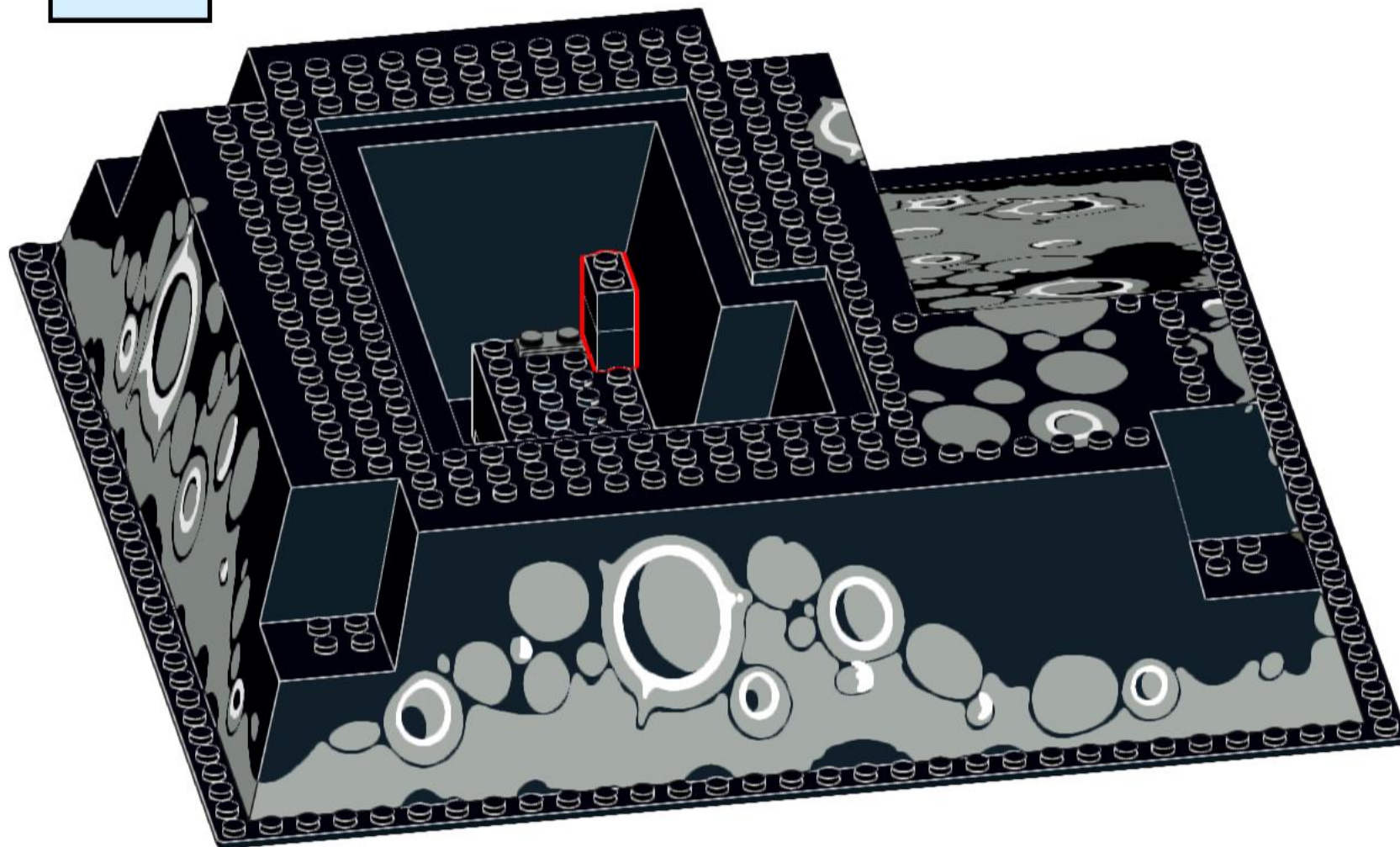
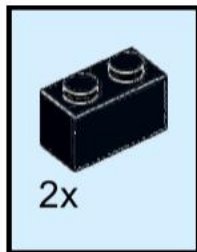

22

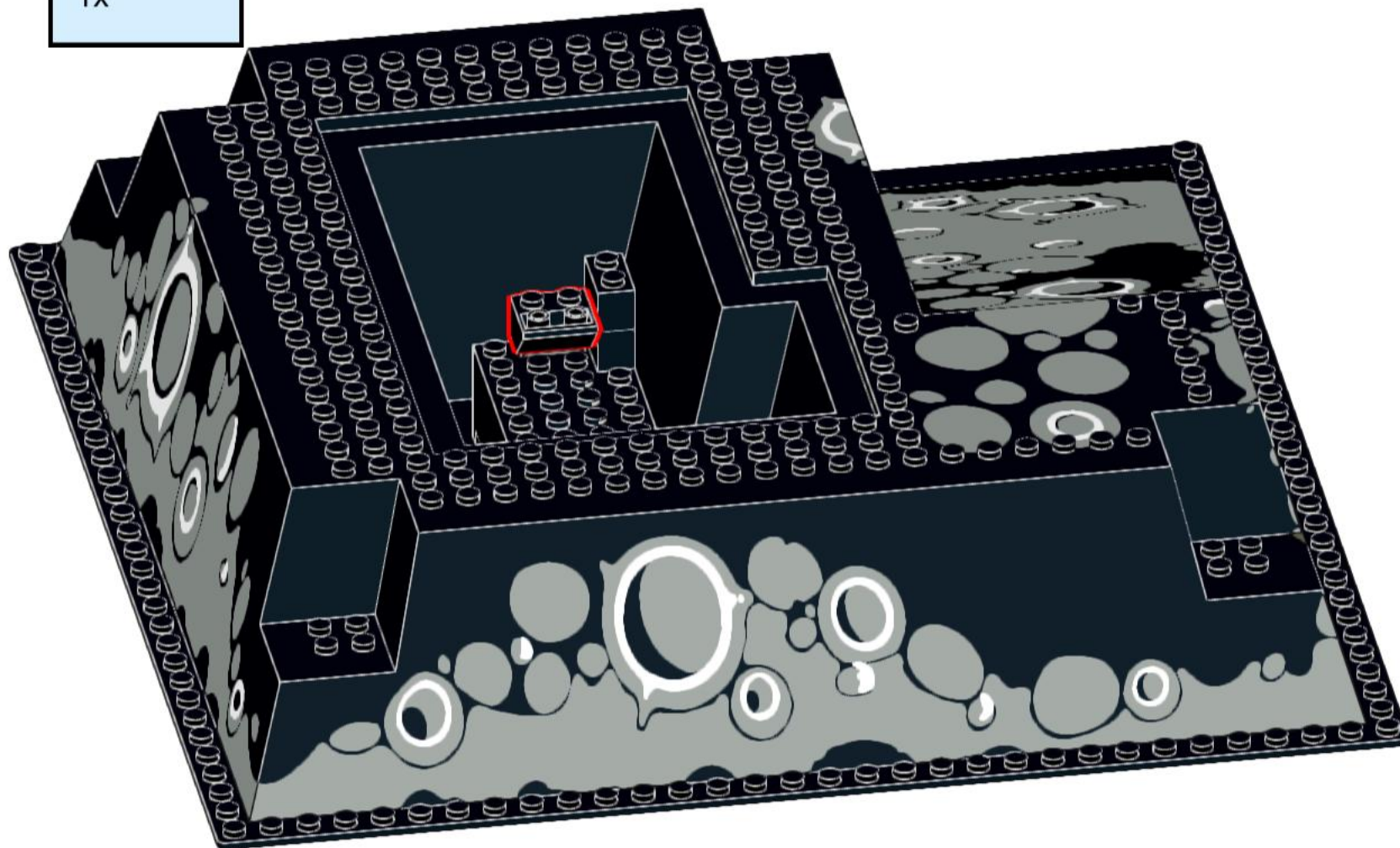
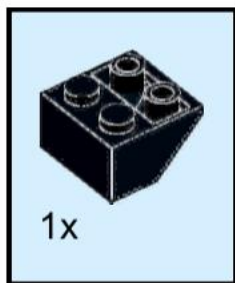

23

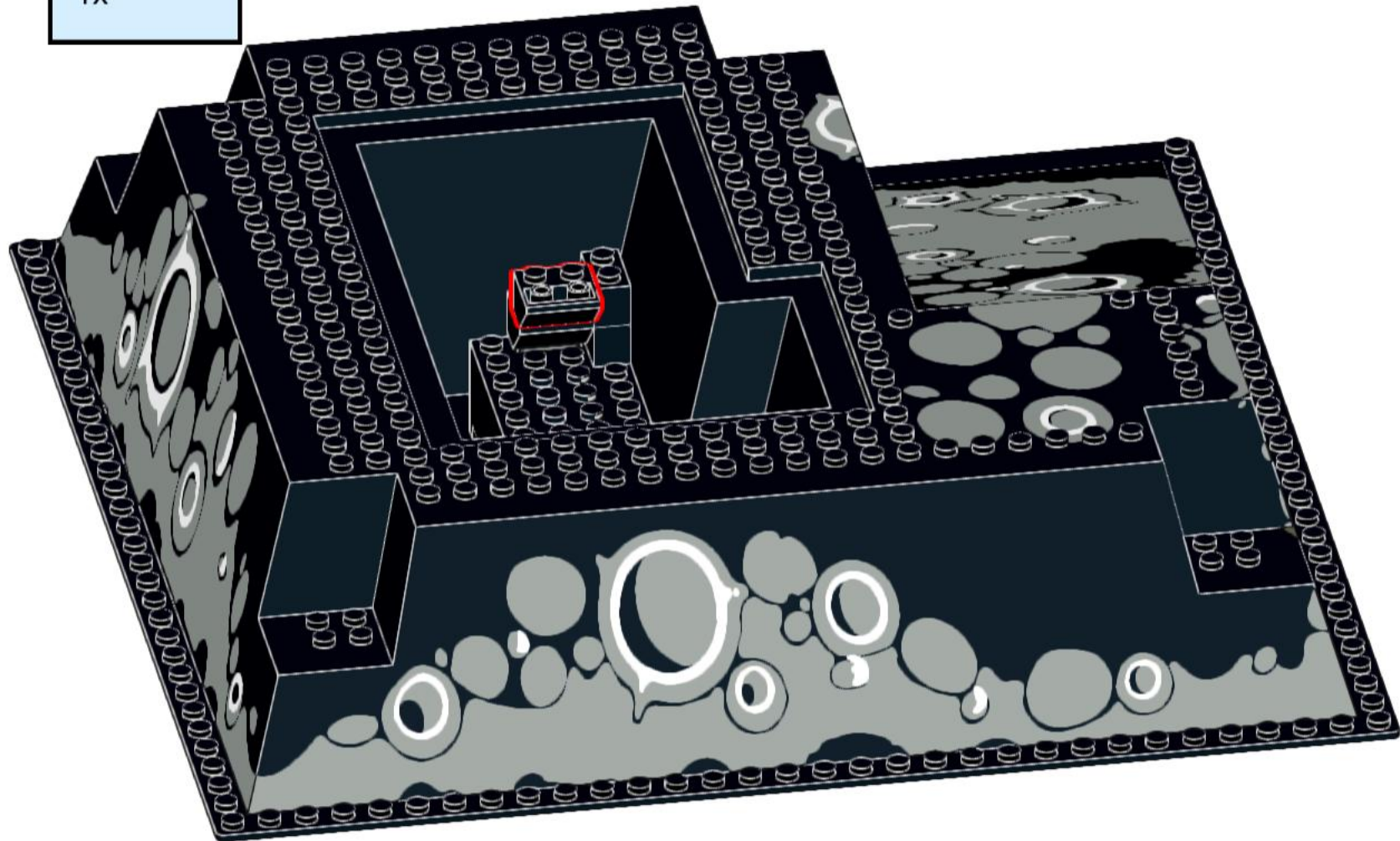
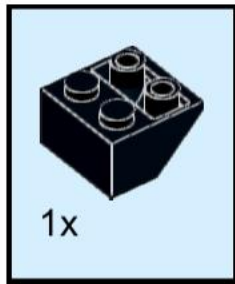

24

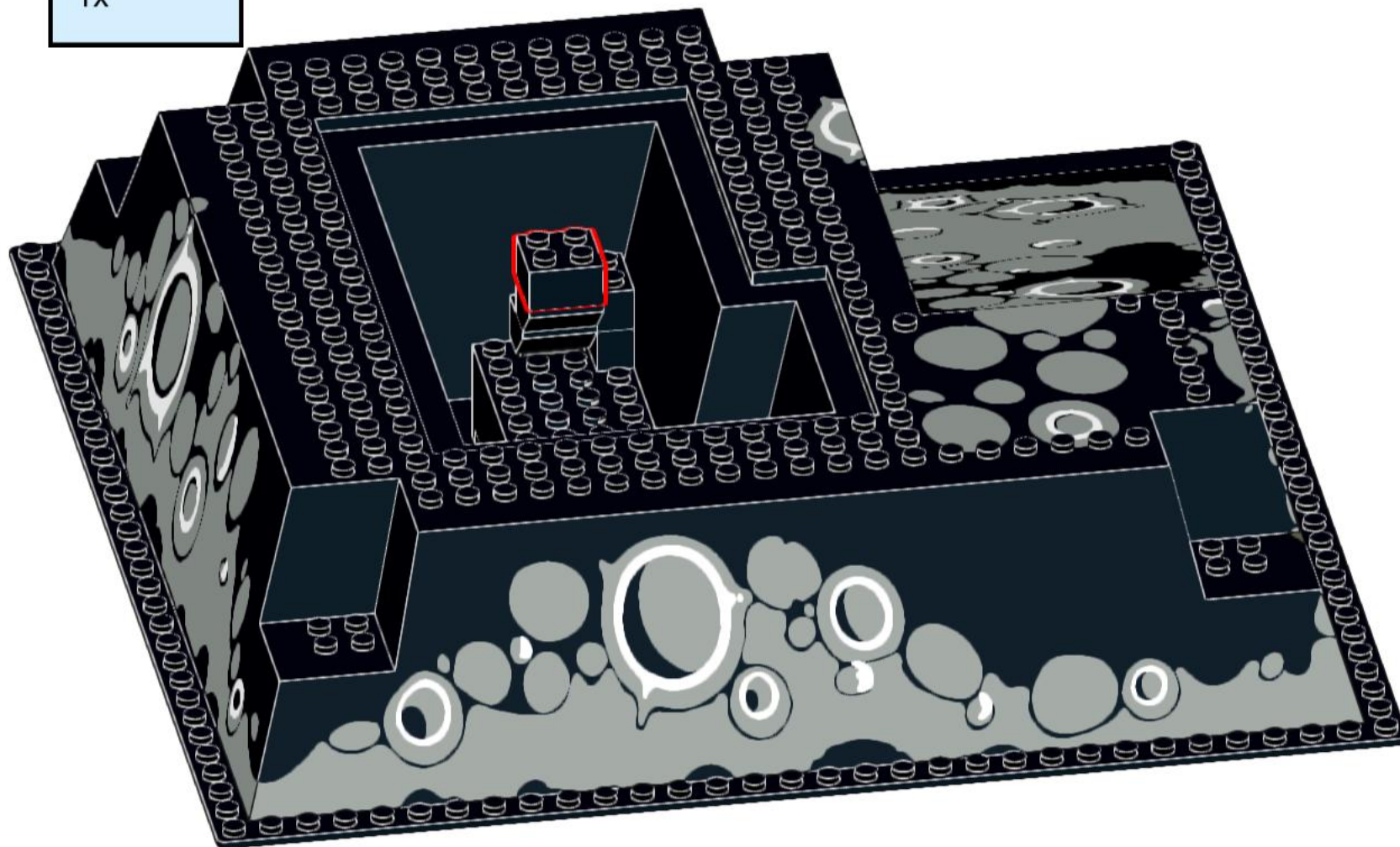
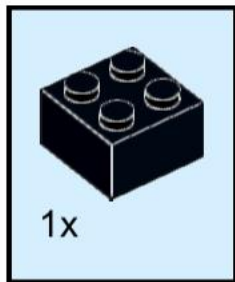

25

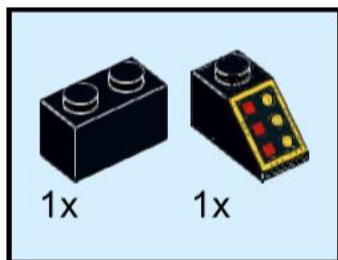

By pressing the control panel you can toggle the lights on and off!

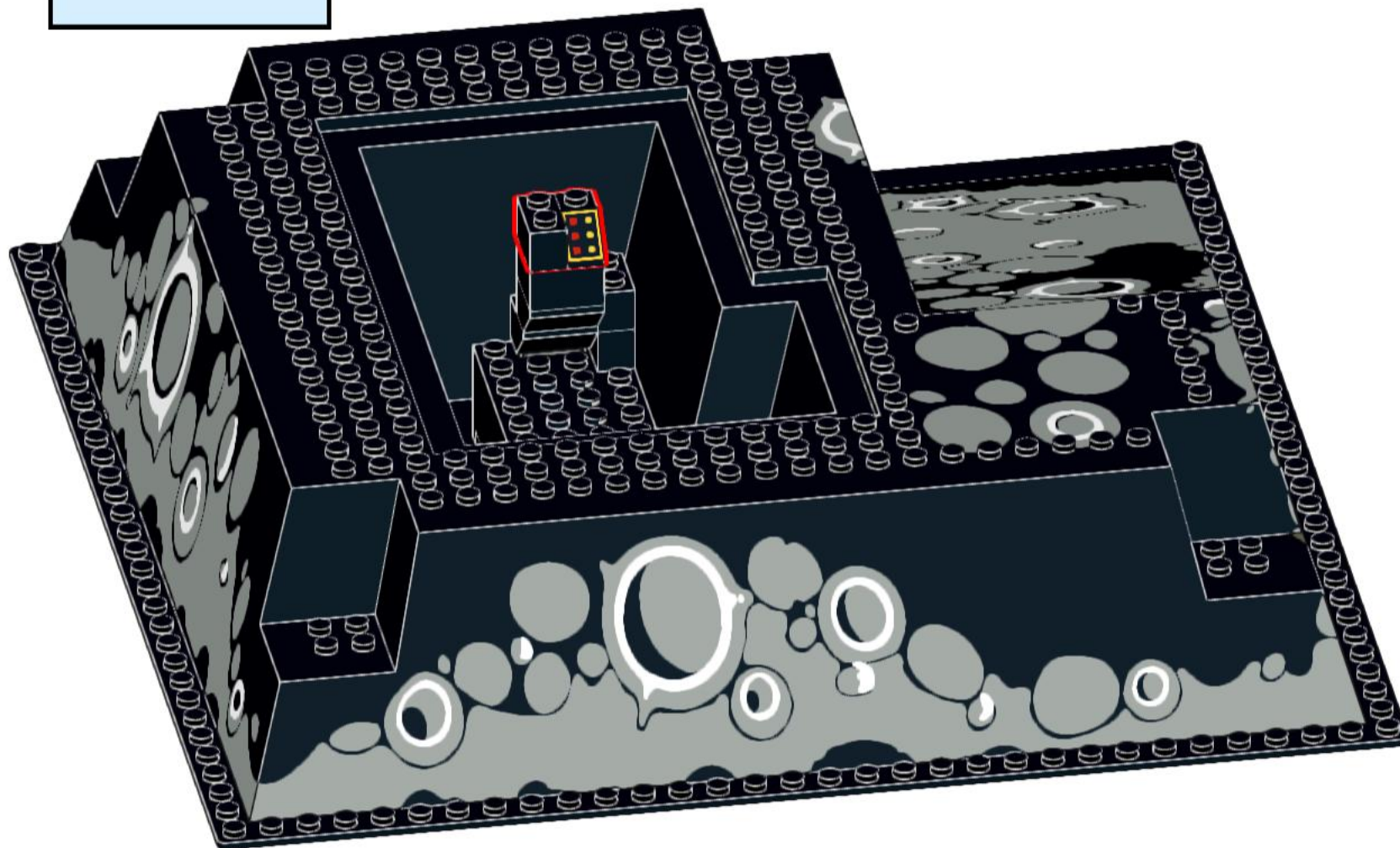

26

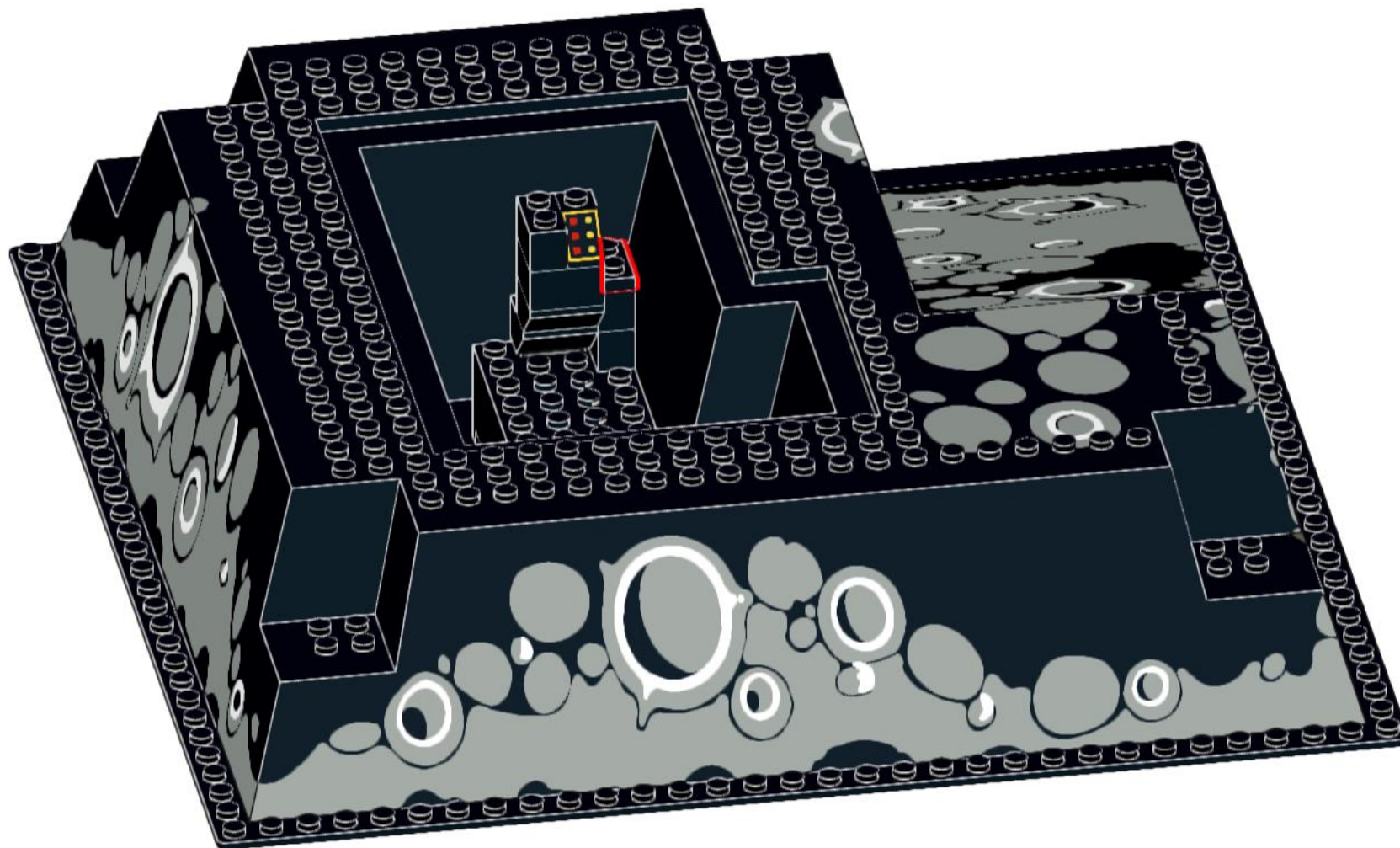
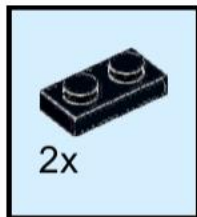

27

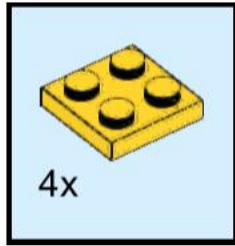

This is the electric cable for the lights, but I couldn't find that piece

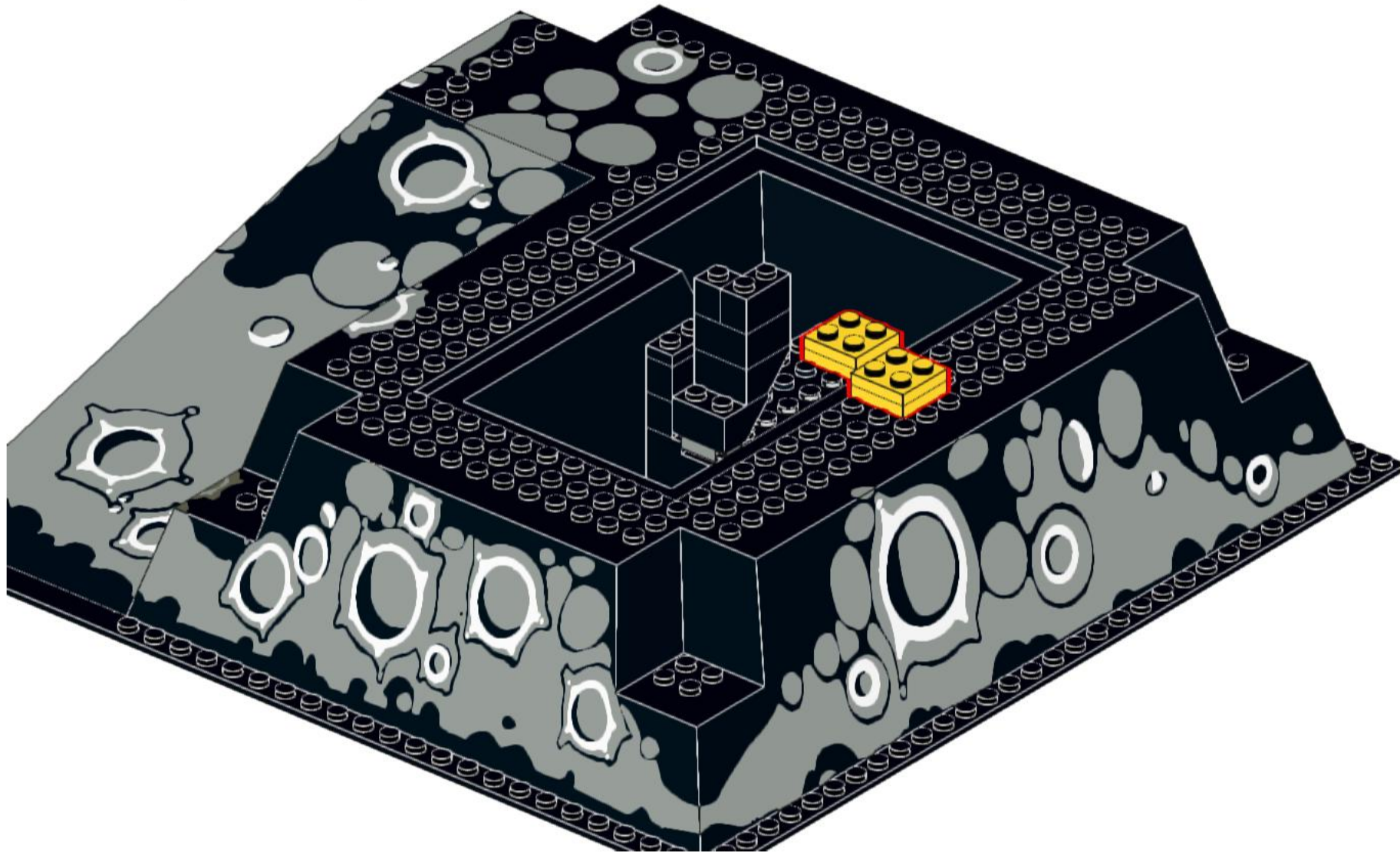

28

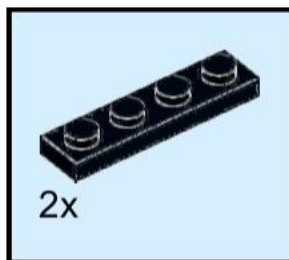

These are the lights.

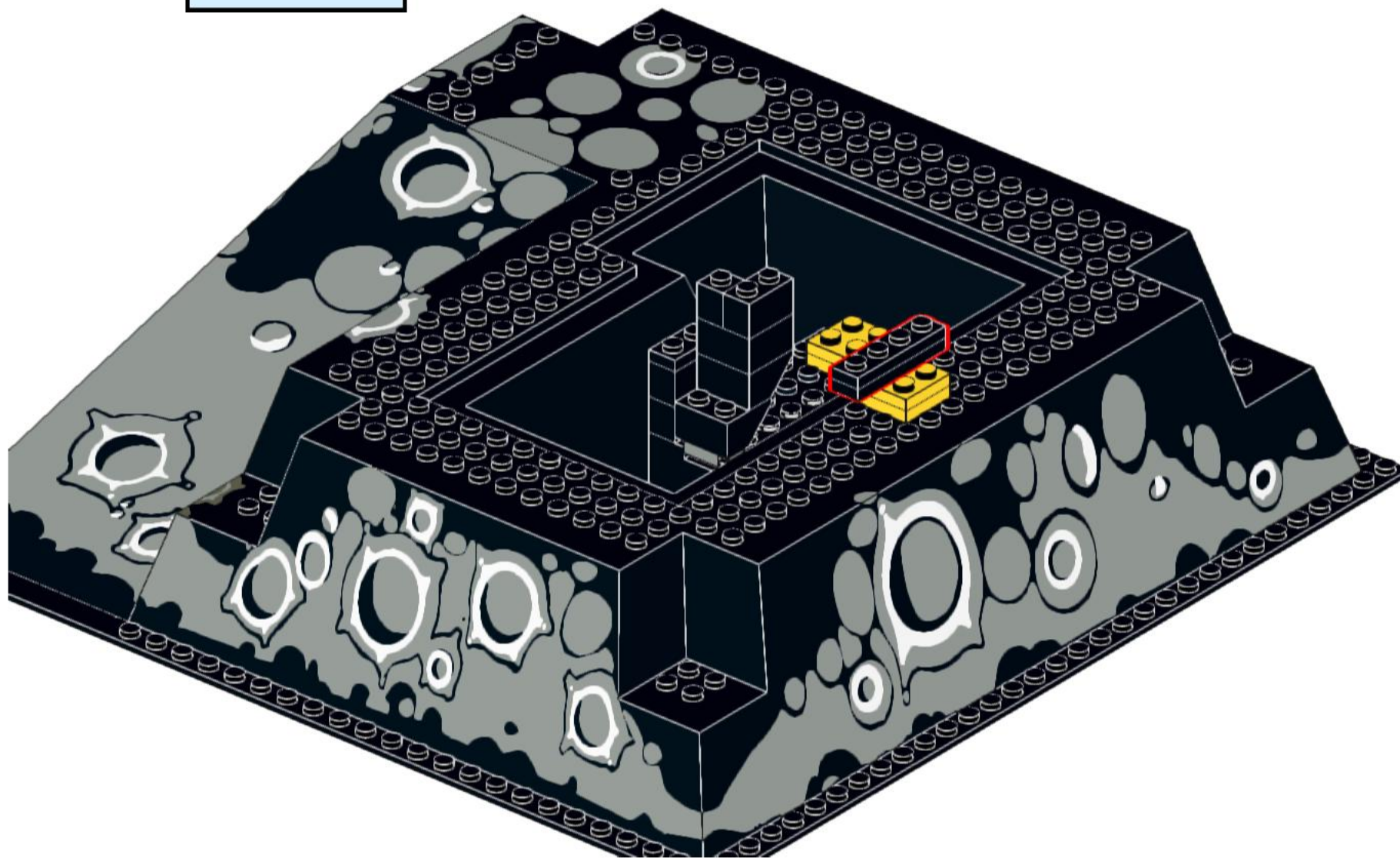

29

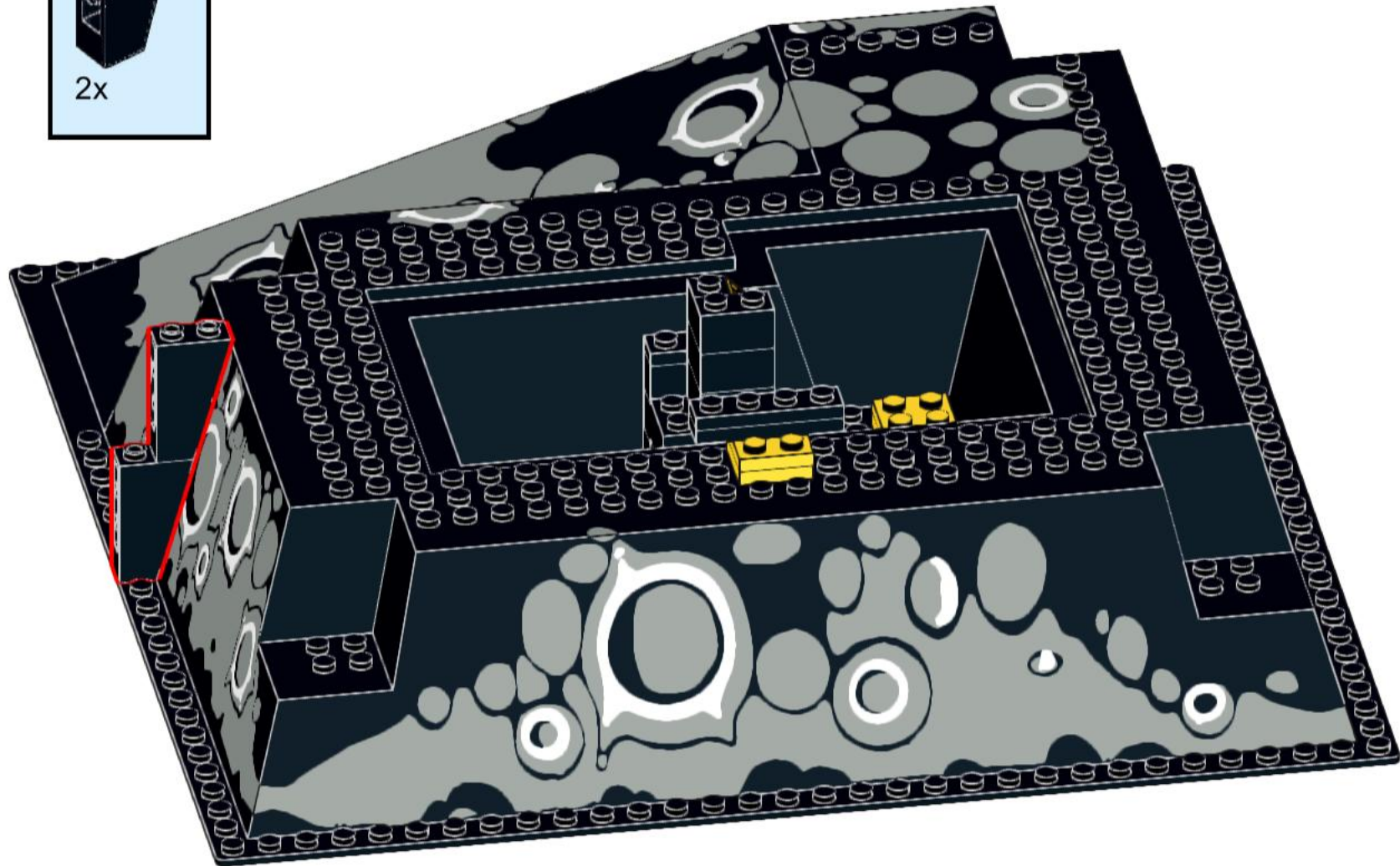
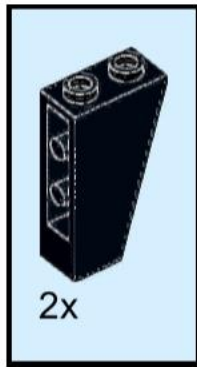

30

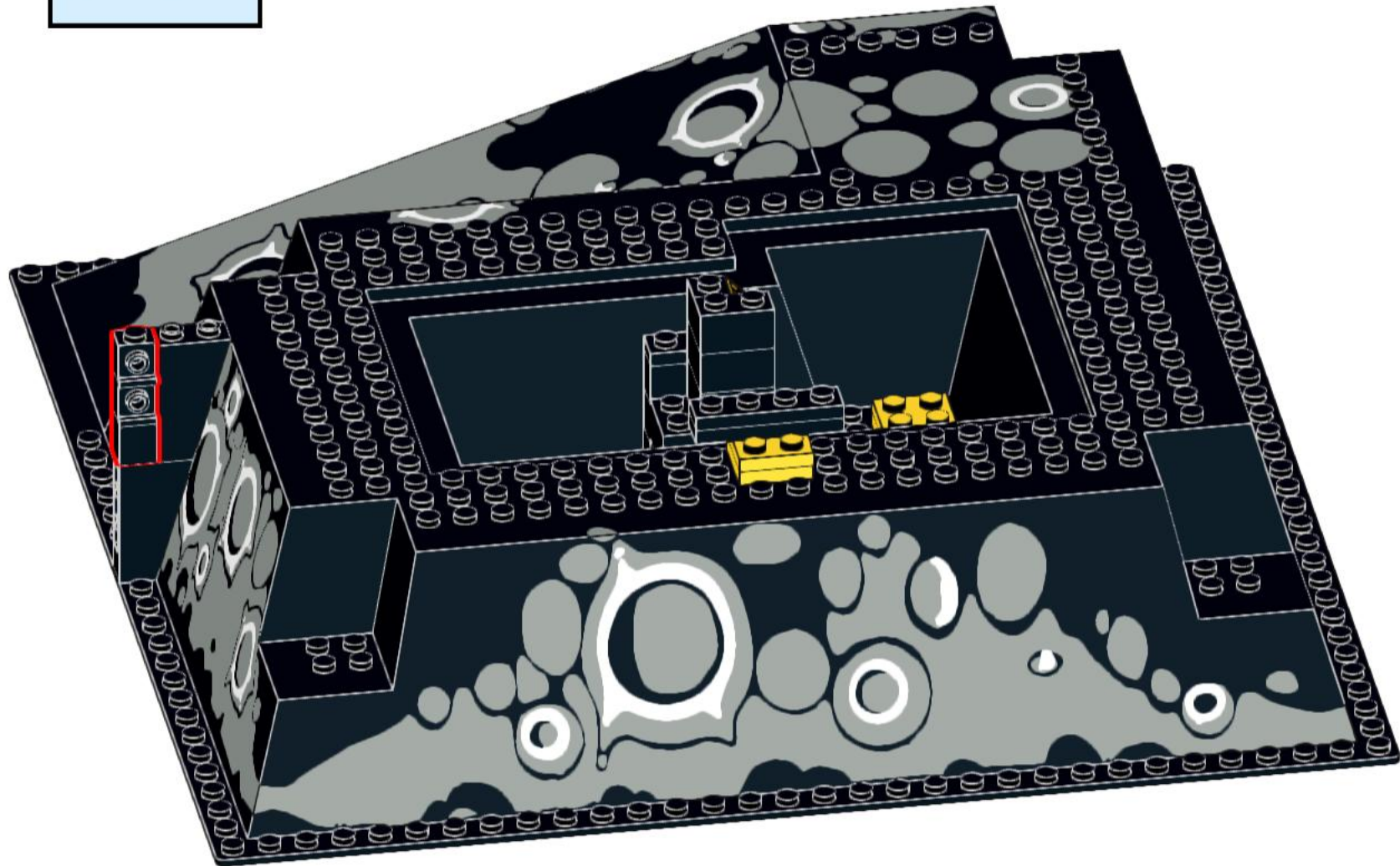
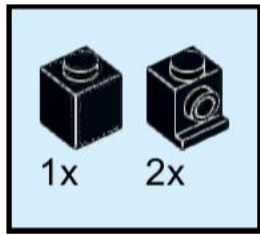

31

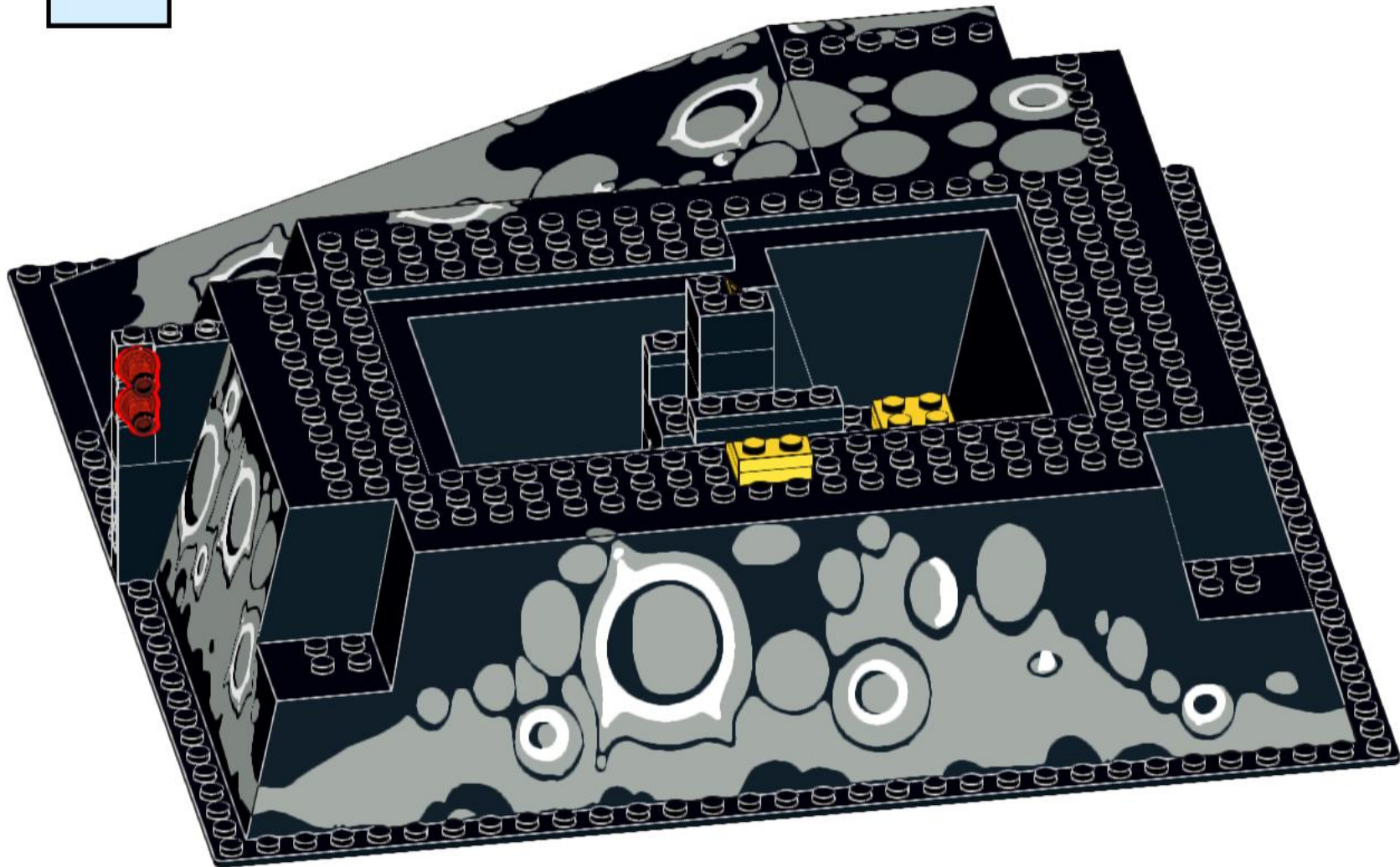

32

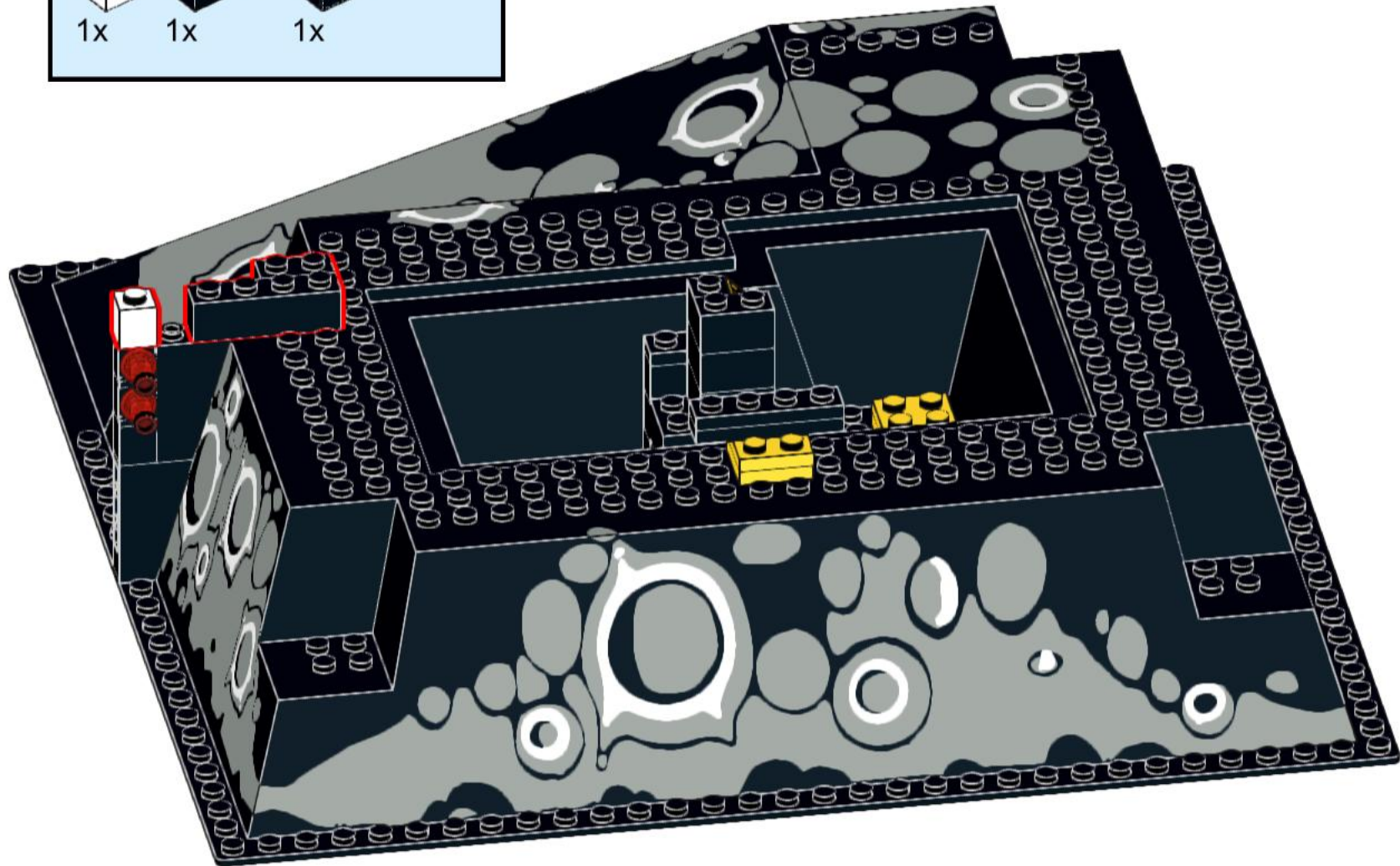
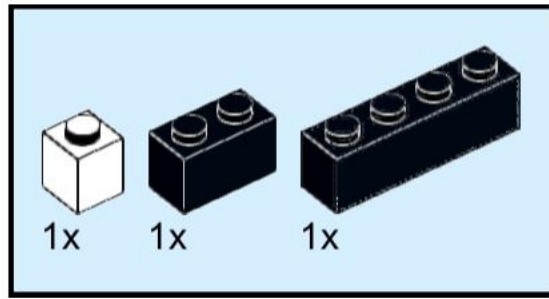

33

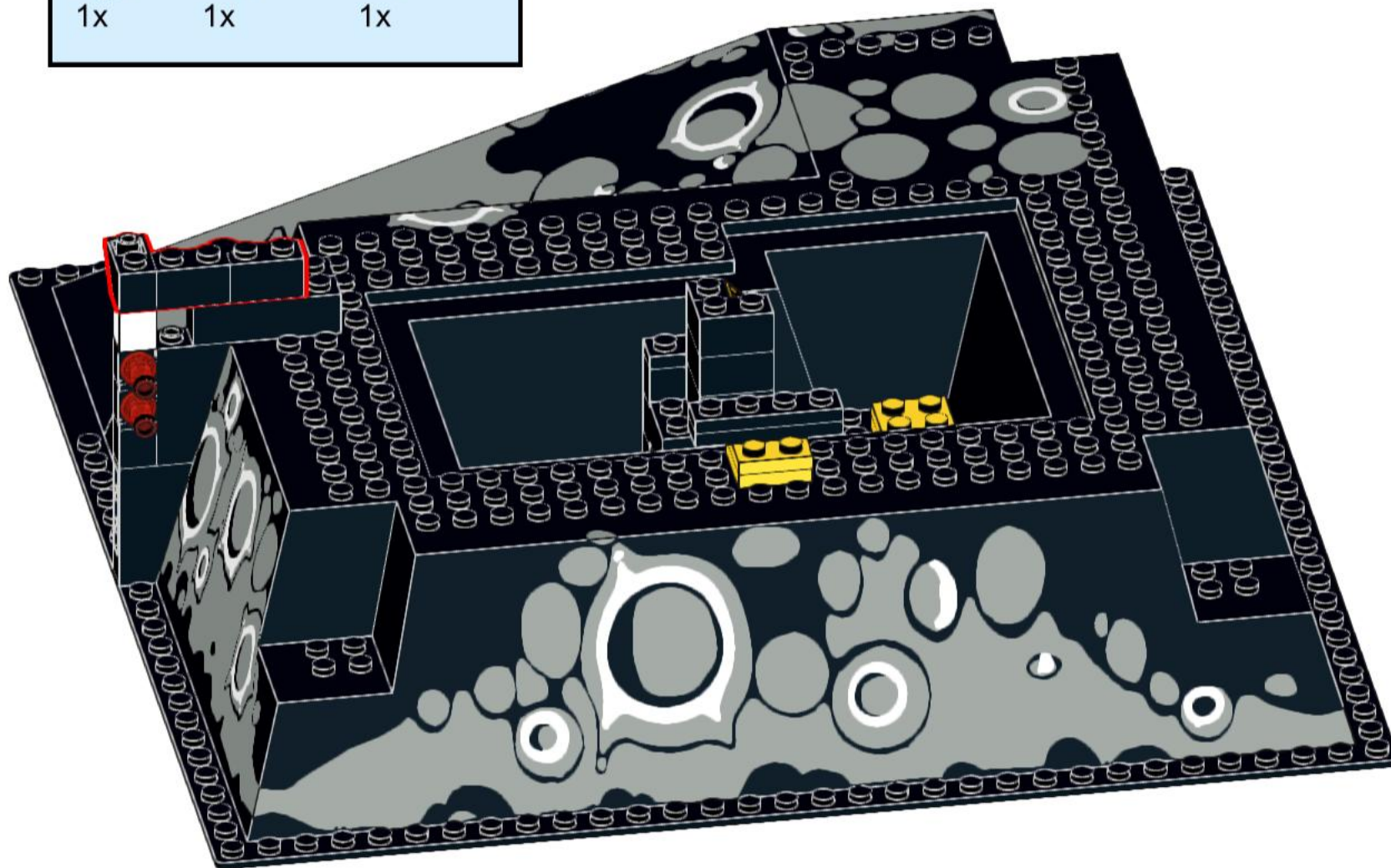
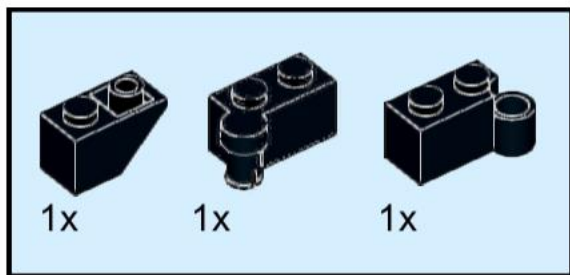

34

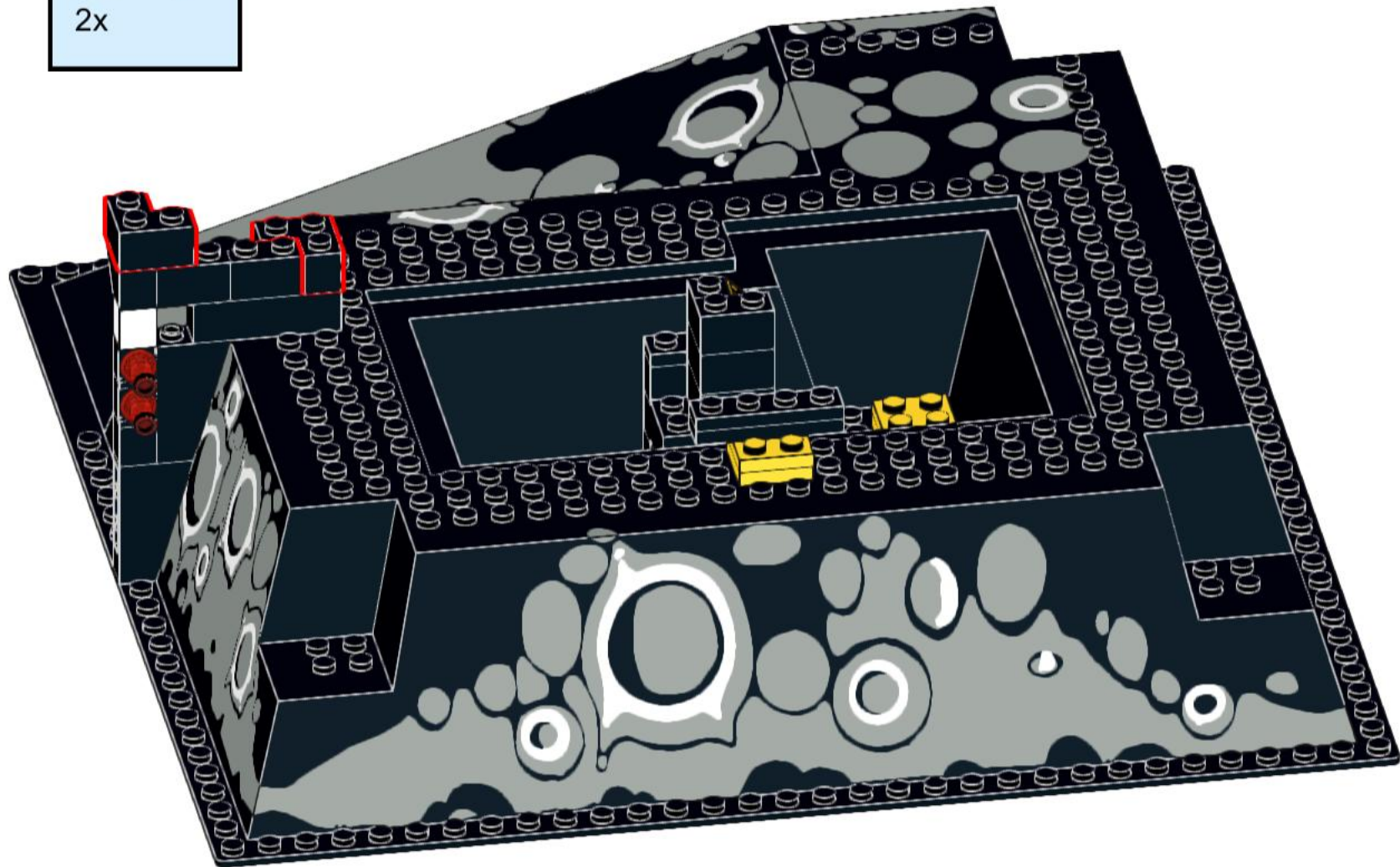
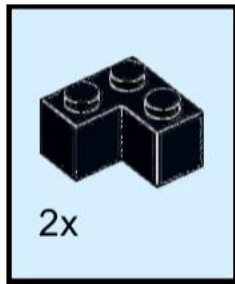

35

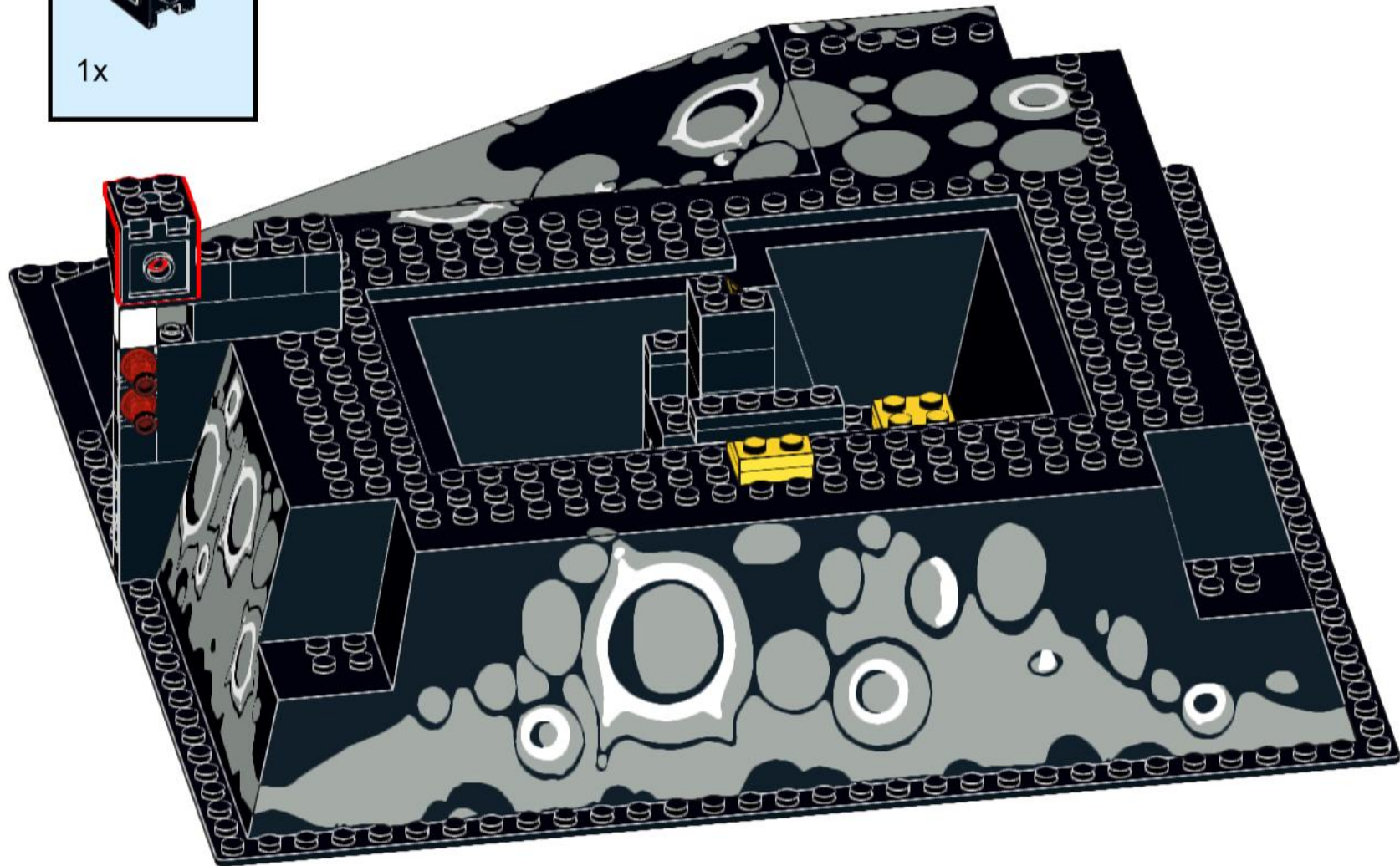
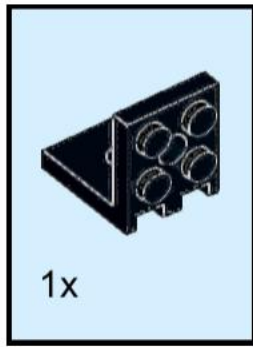

36

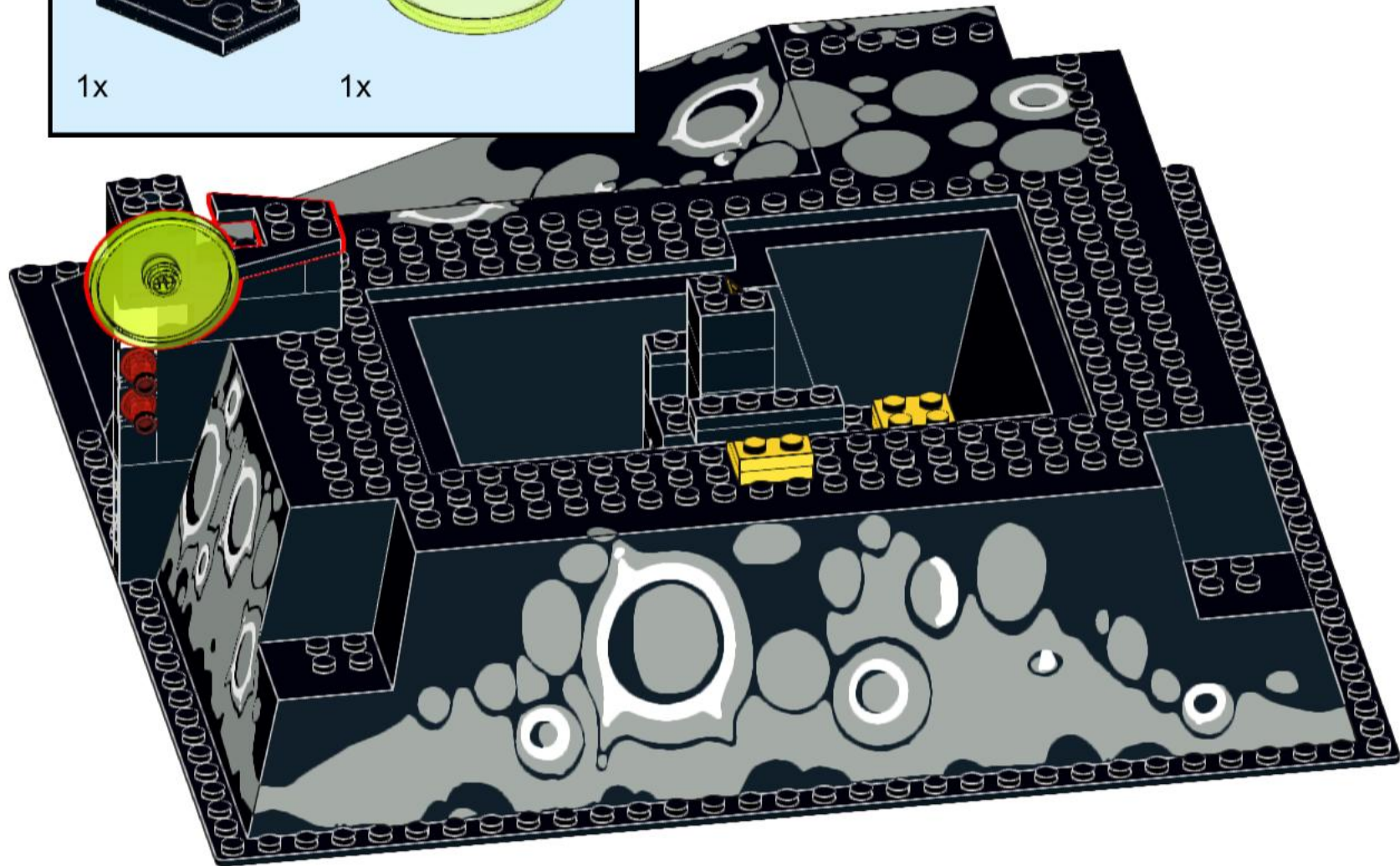
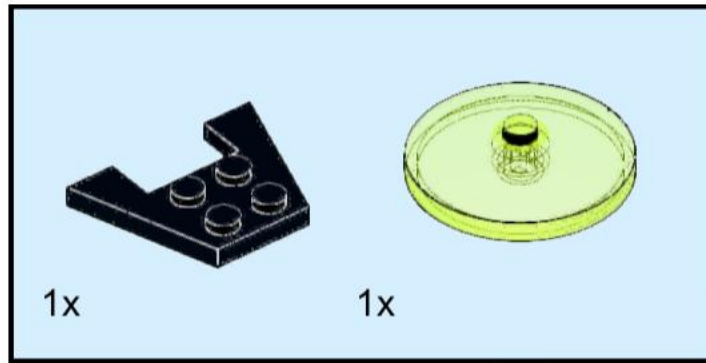

37

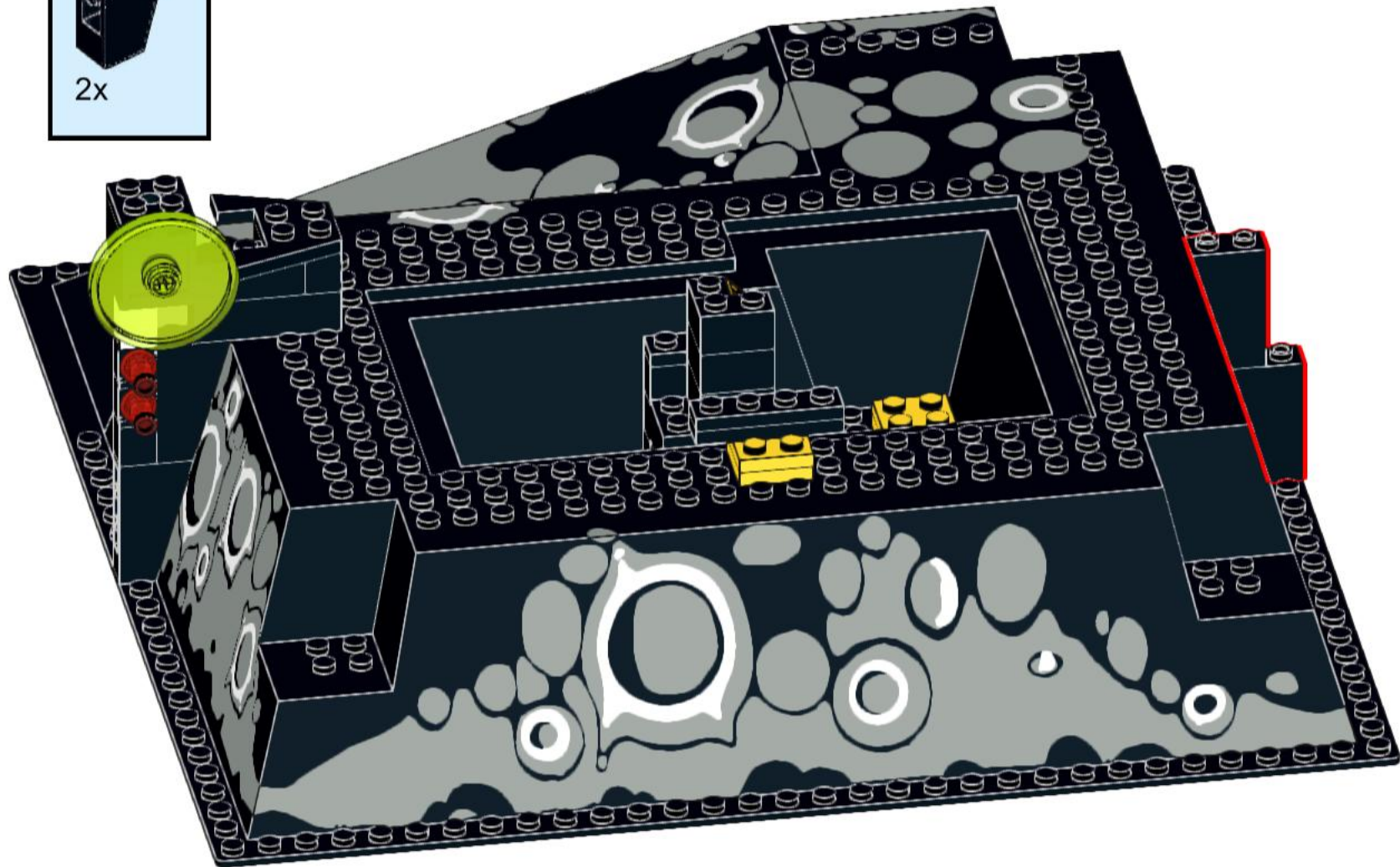
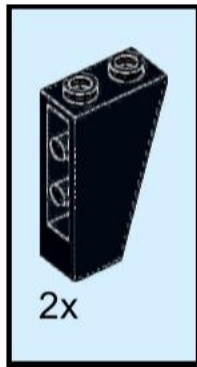

38

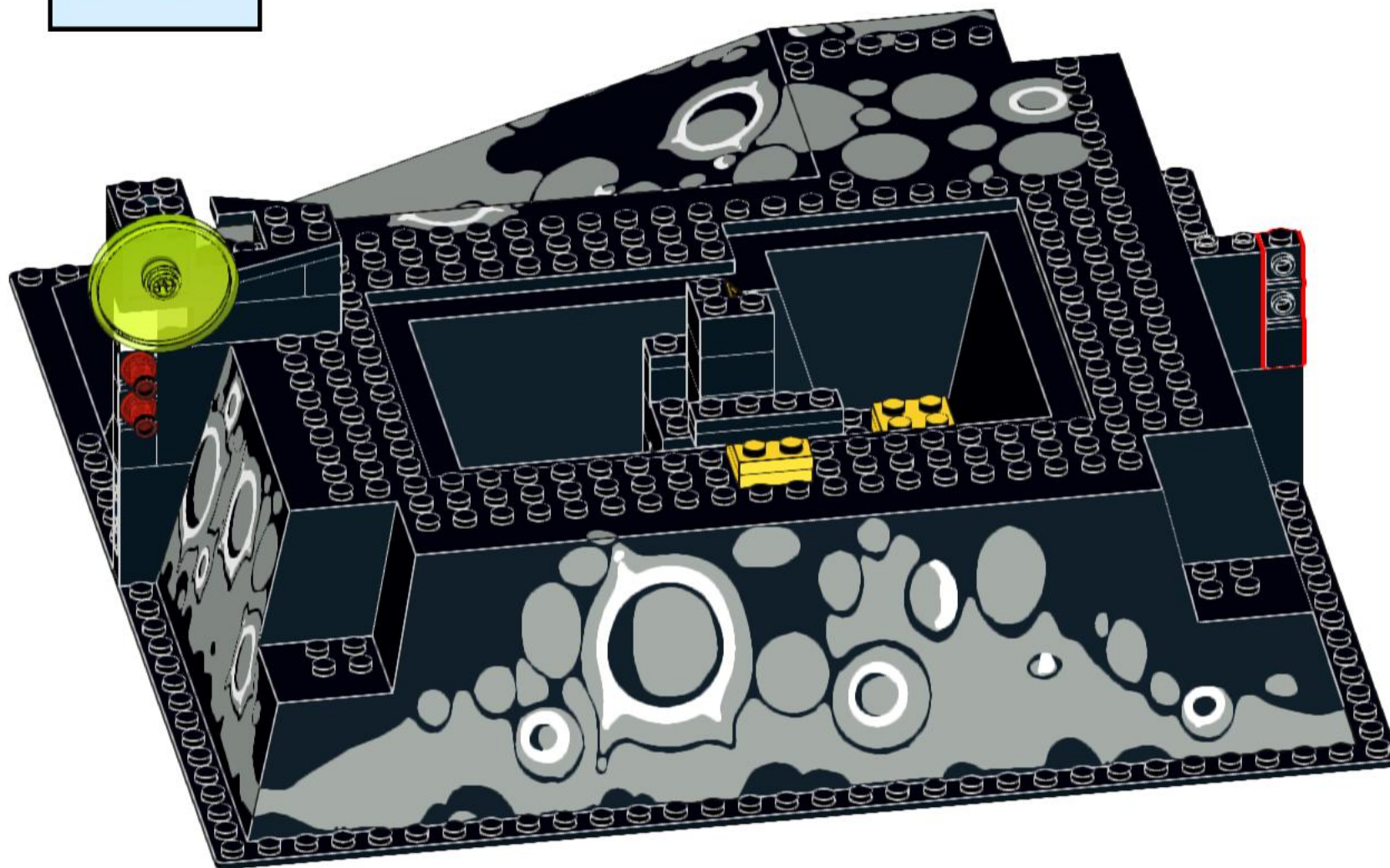
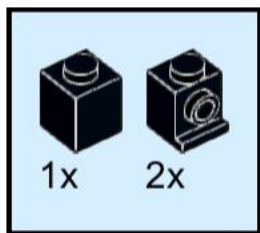

39

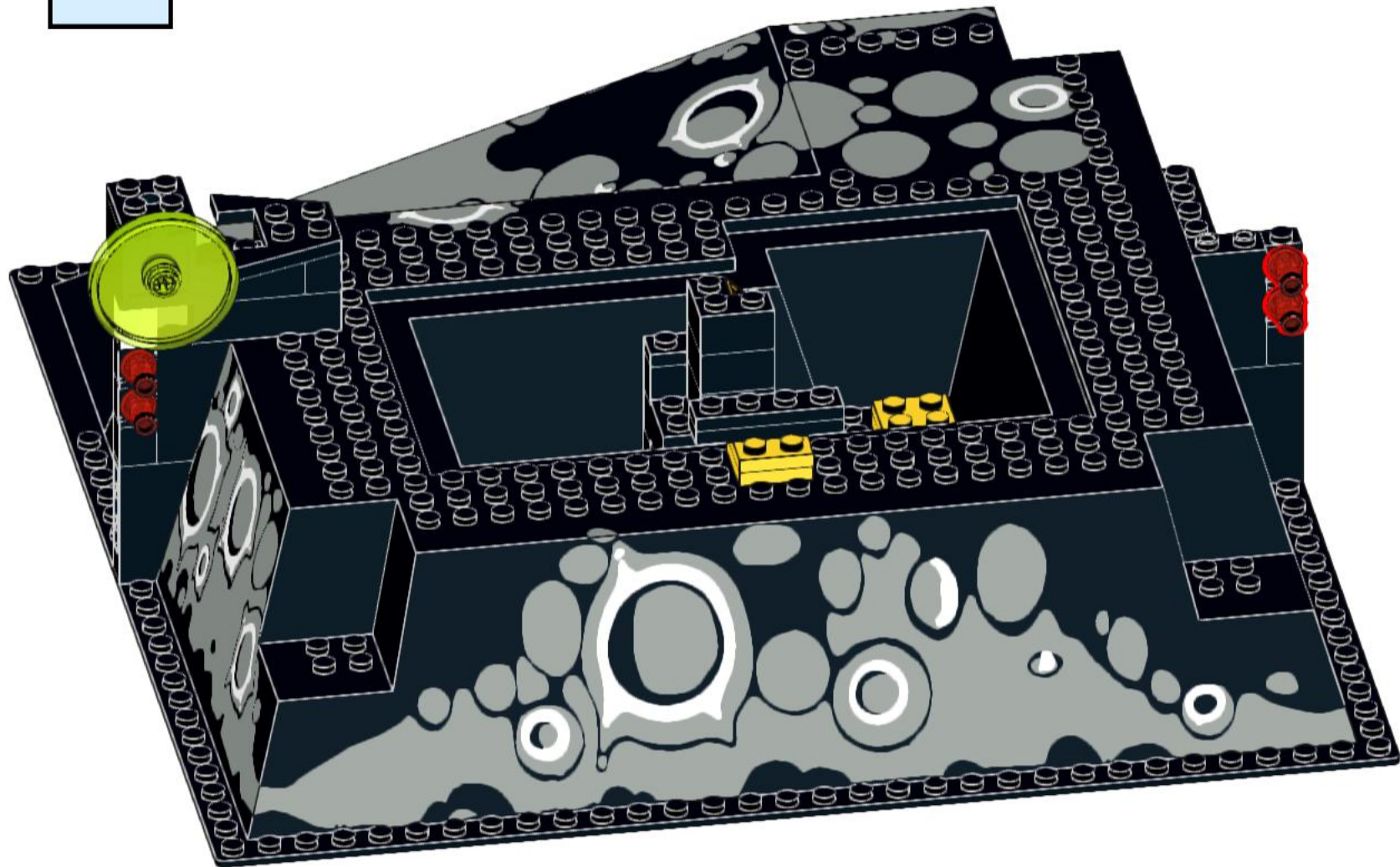

40

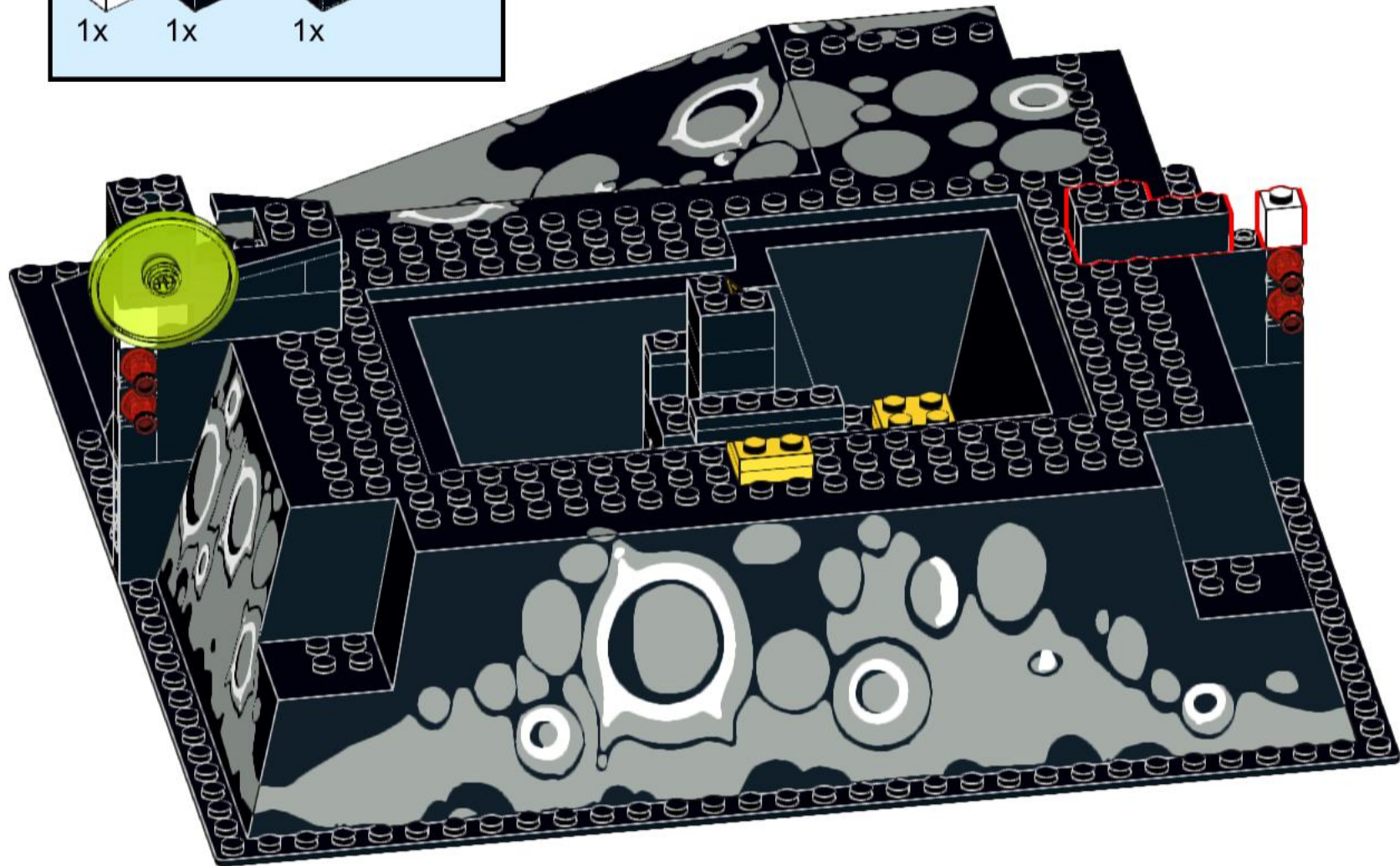
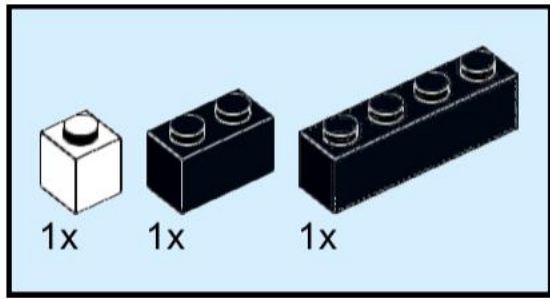

41

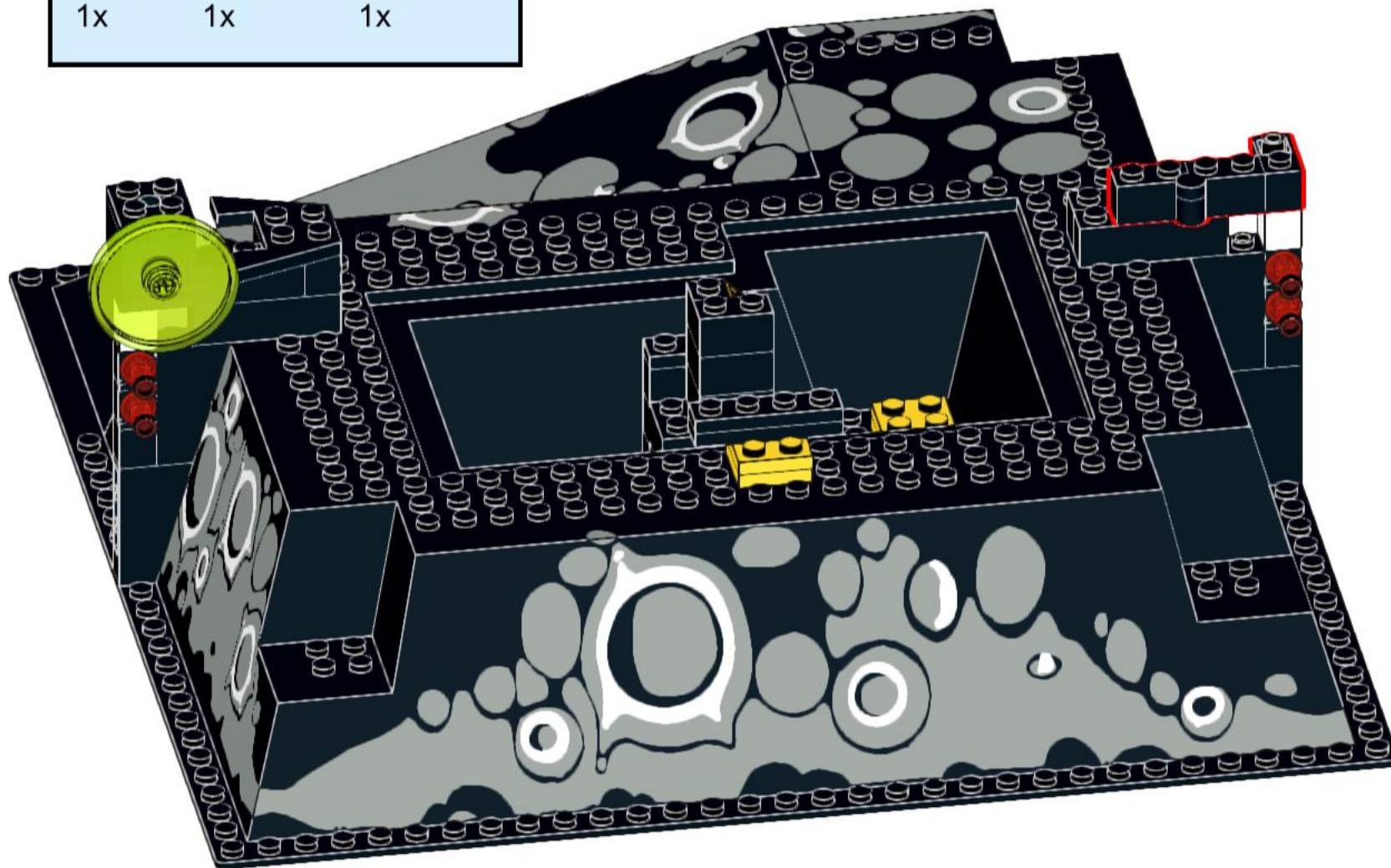
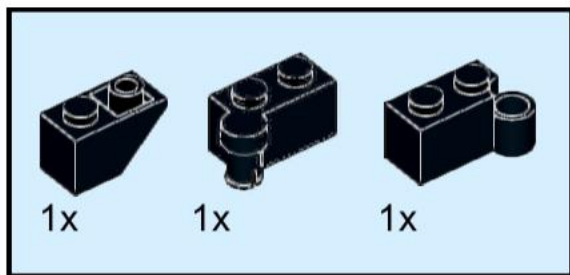

42

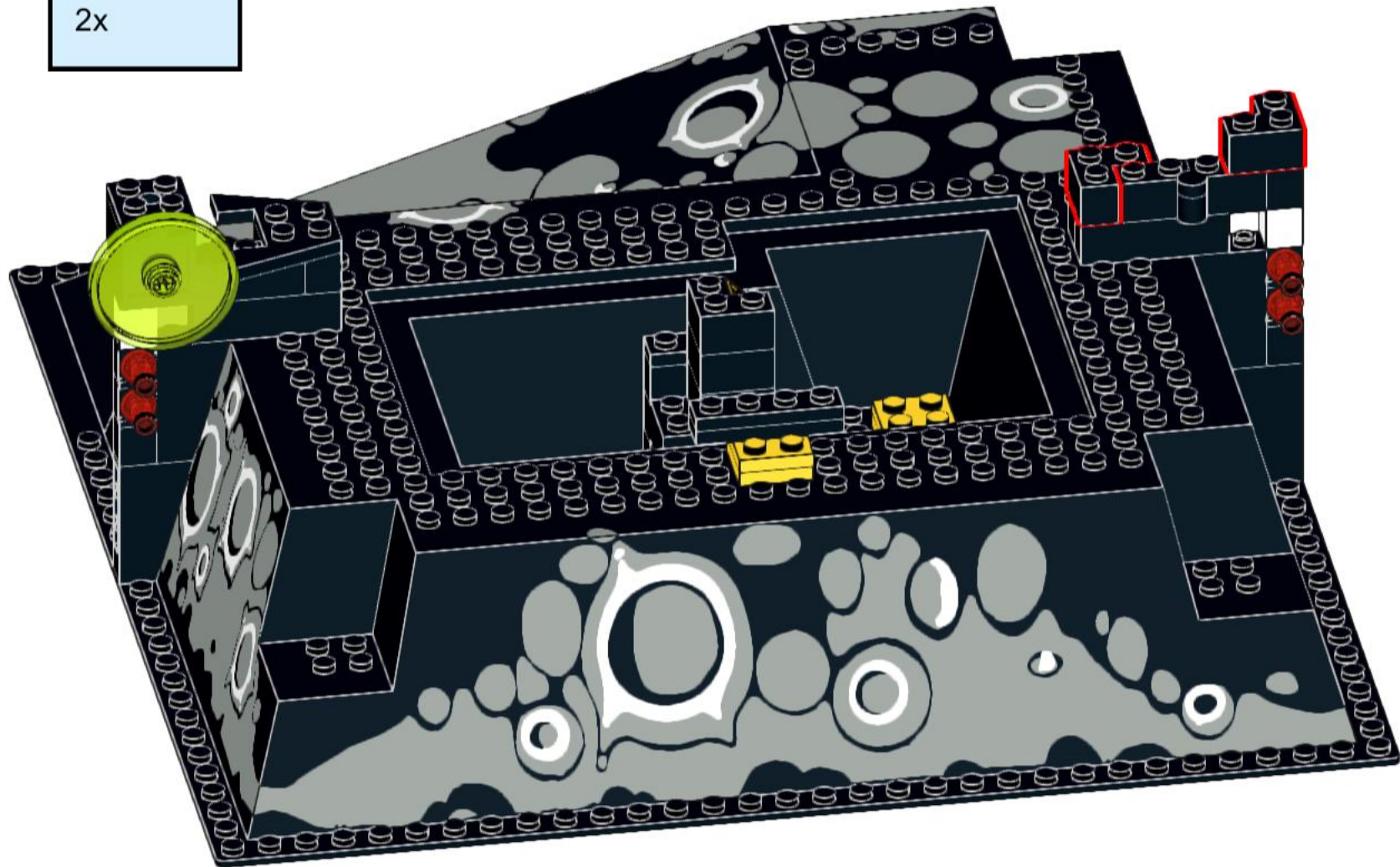
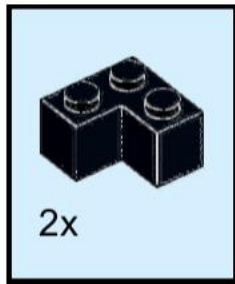

43

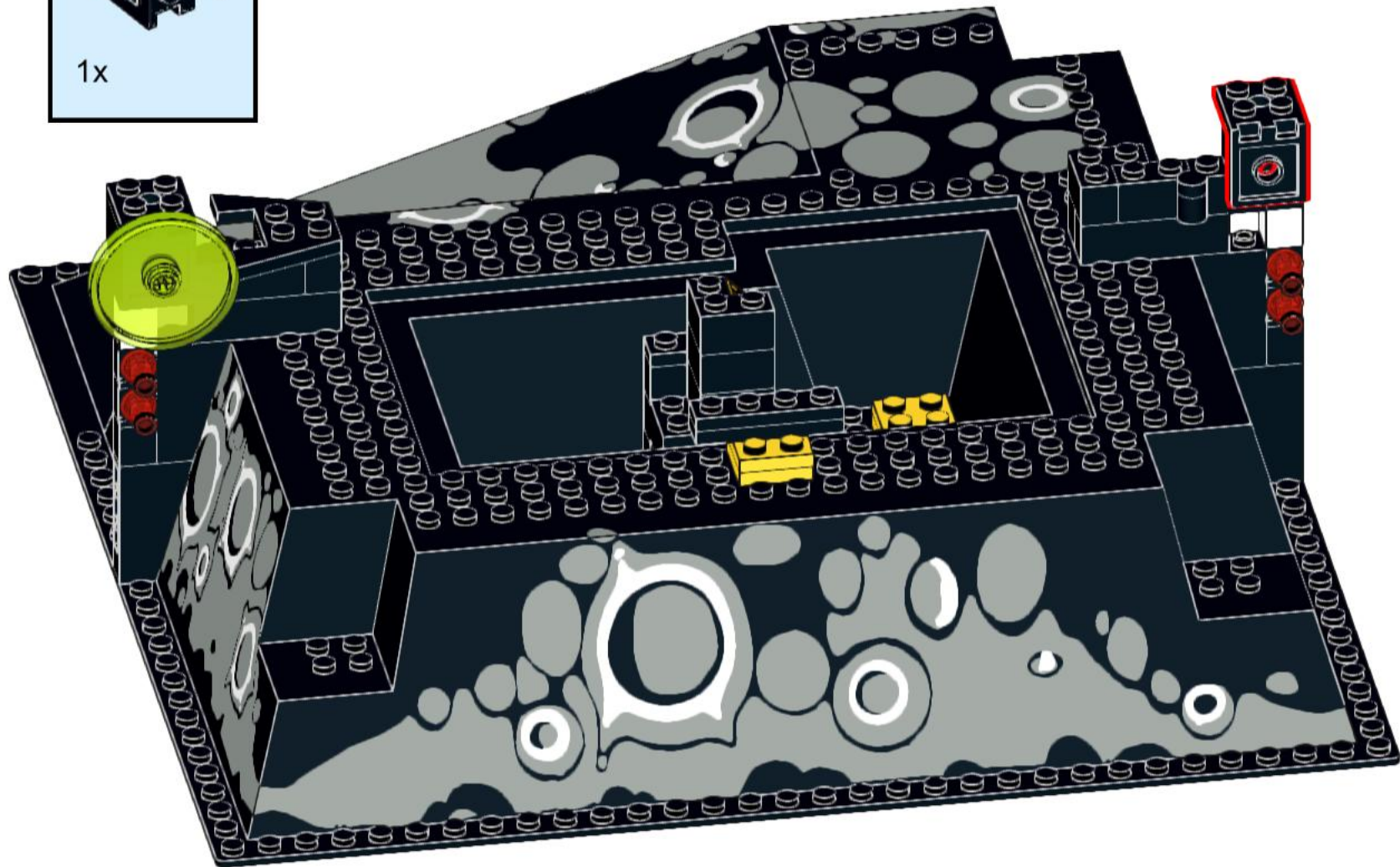
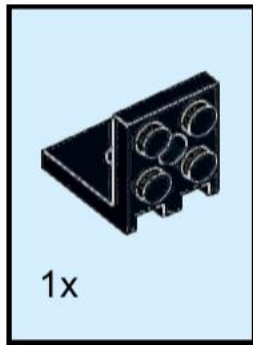

44

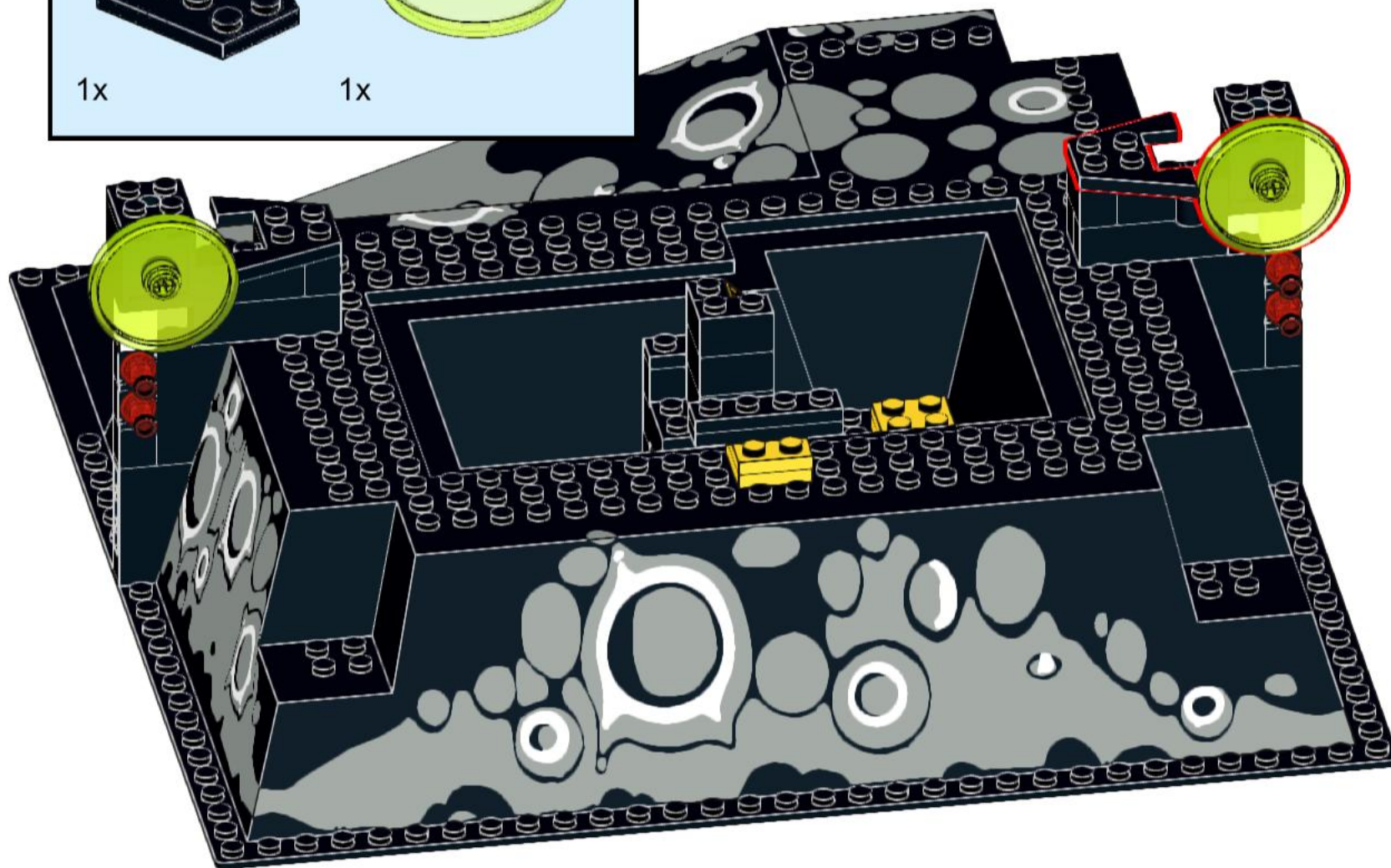
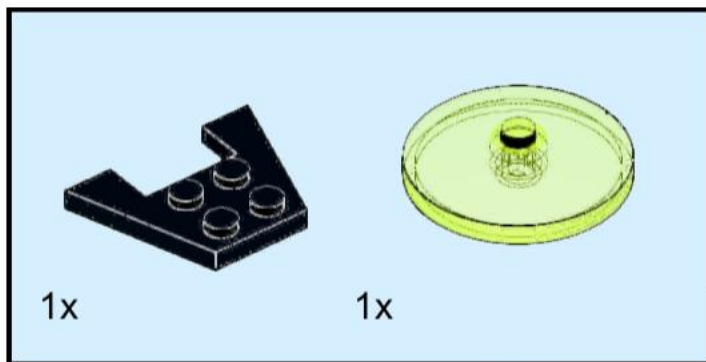

45

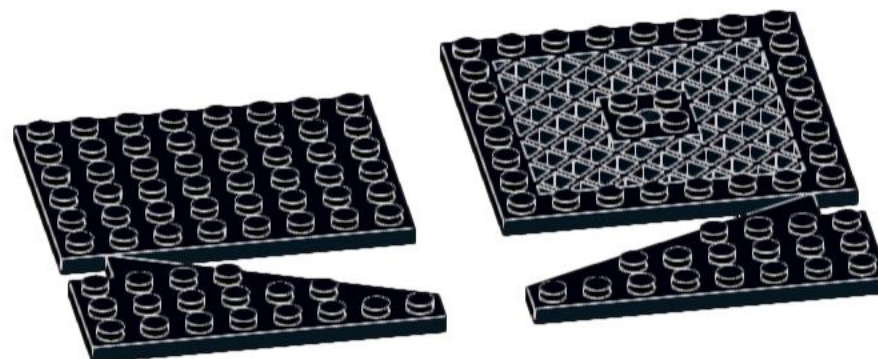
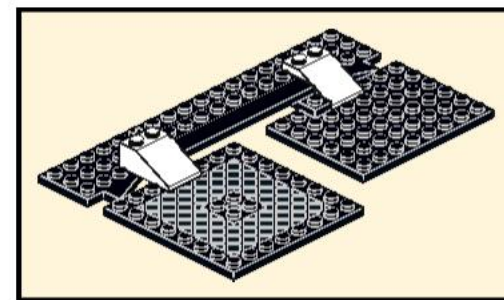
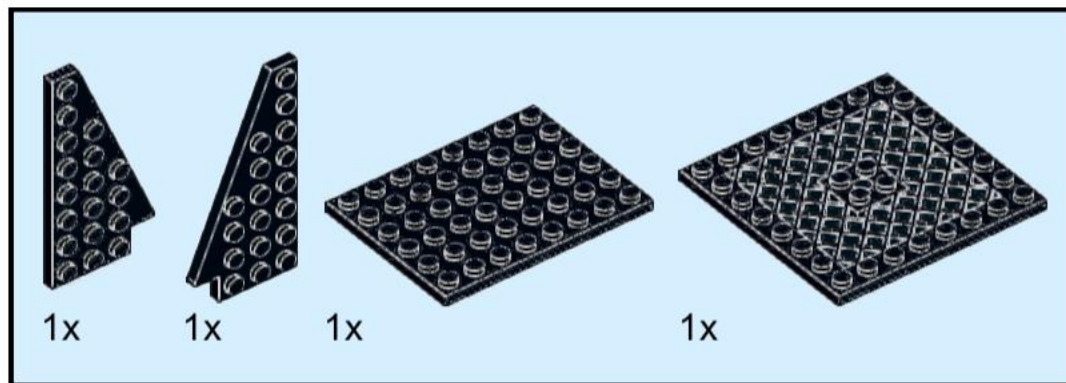

This is for the bottom of the base with the pieces that were left in the set. You can make your own ground floor with your spare pieces.

46

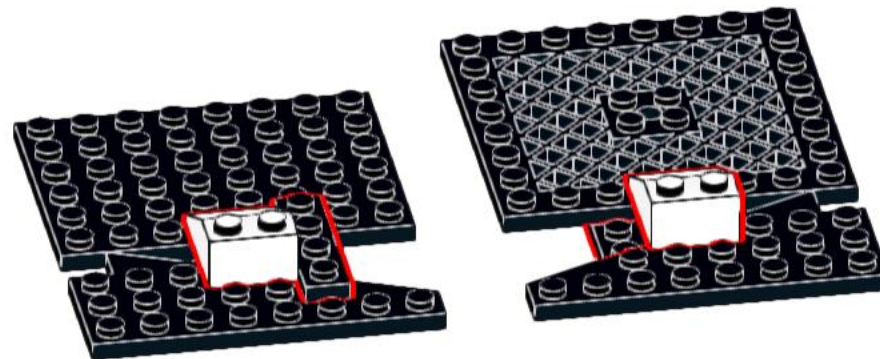
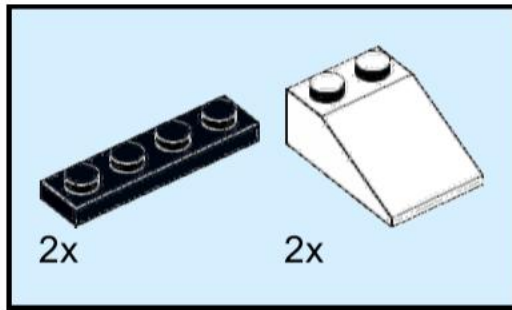

47

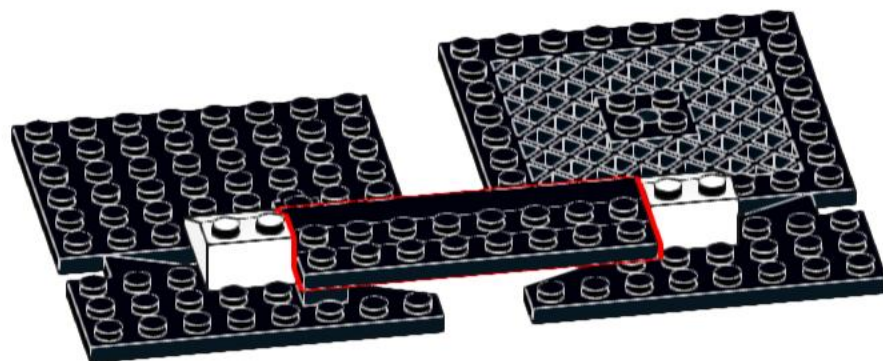
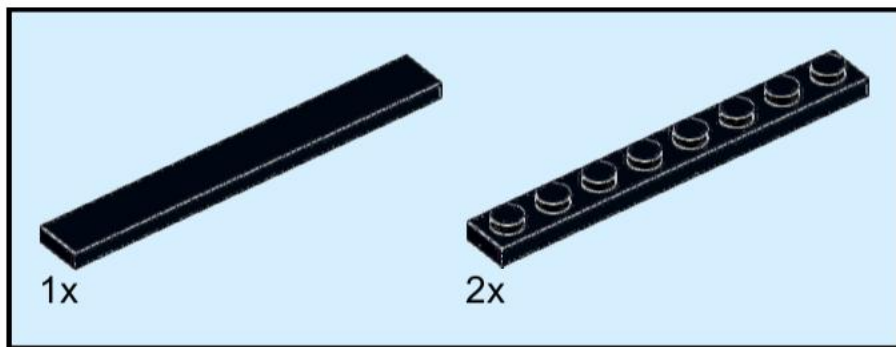

48

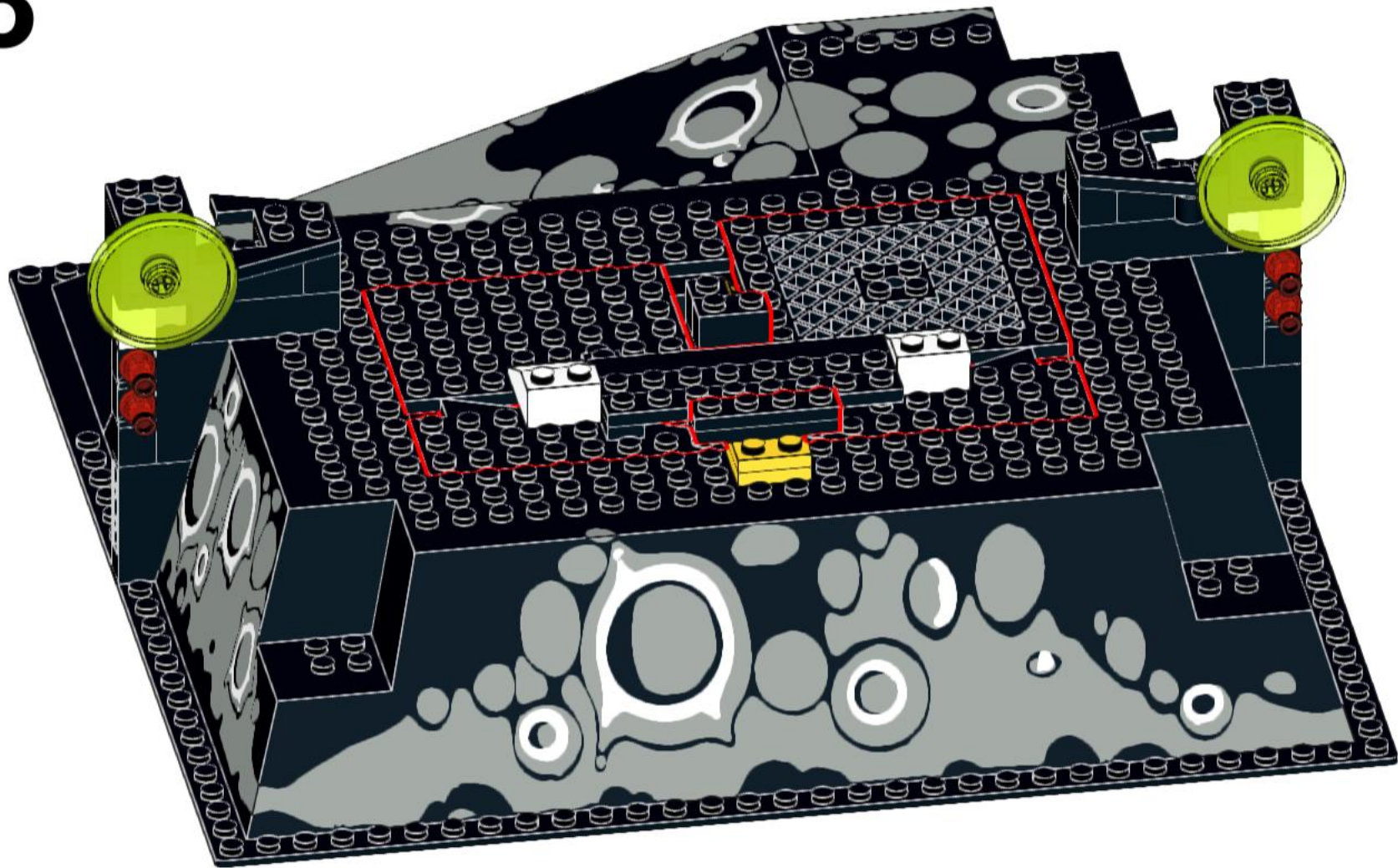

49

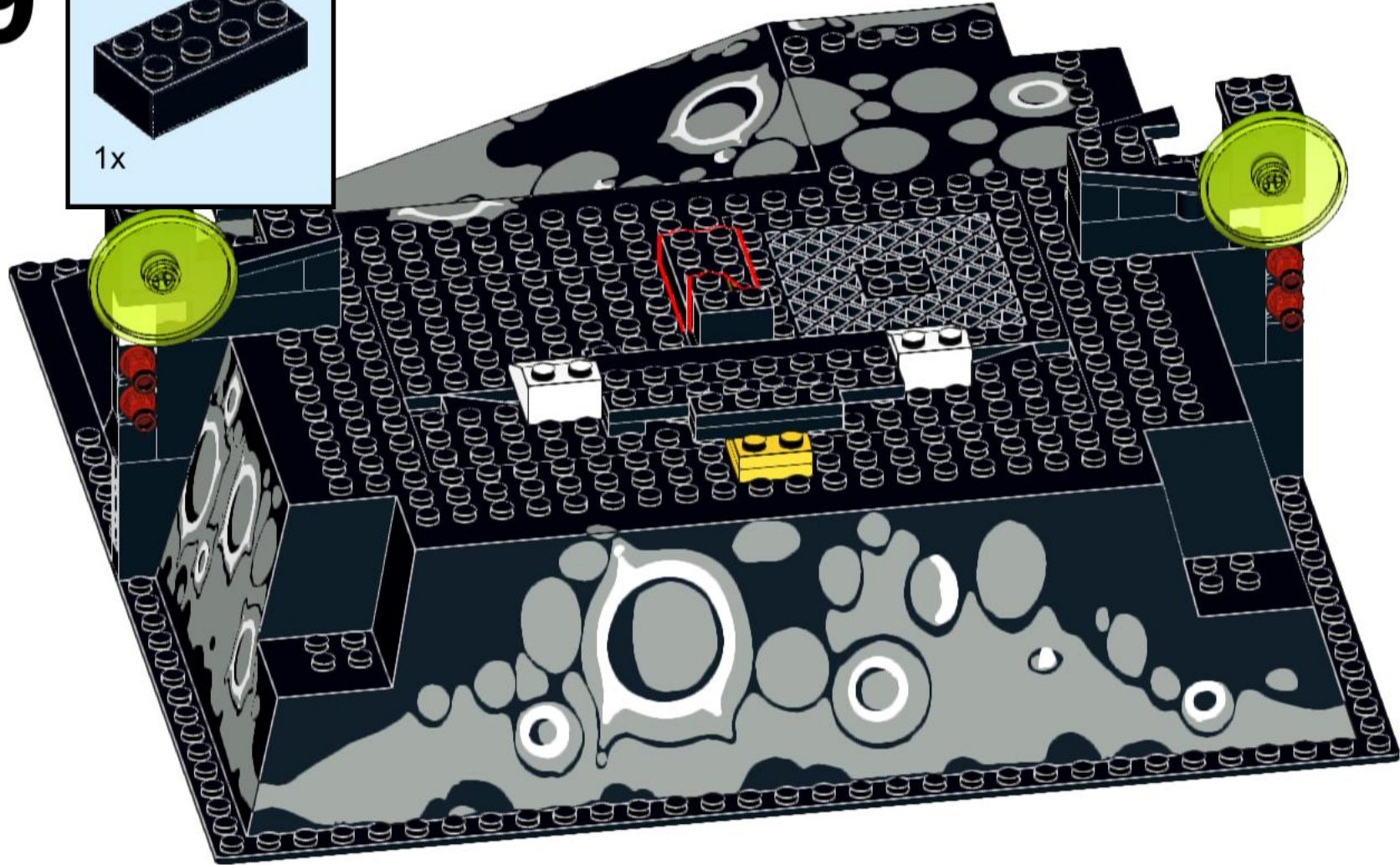
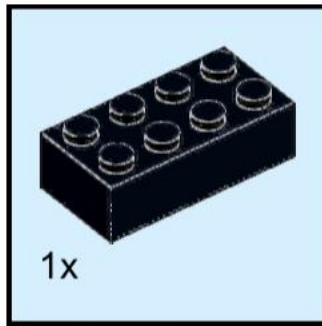

50

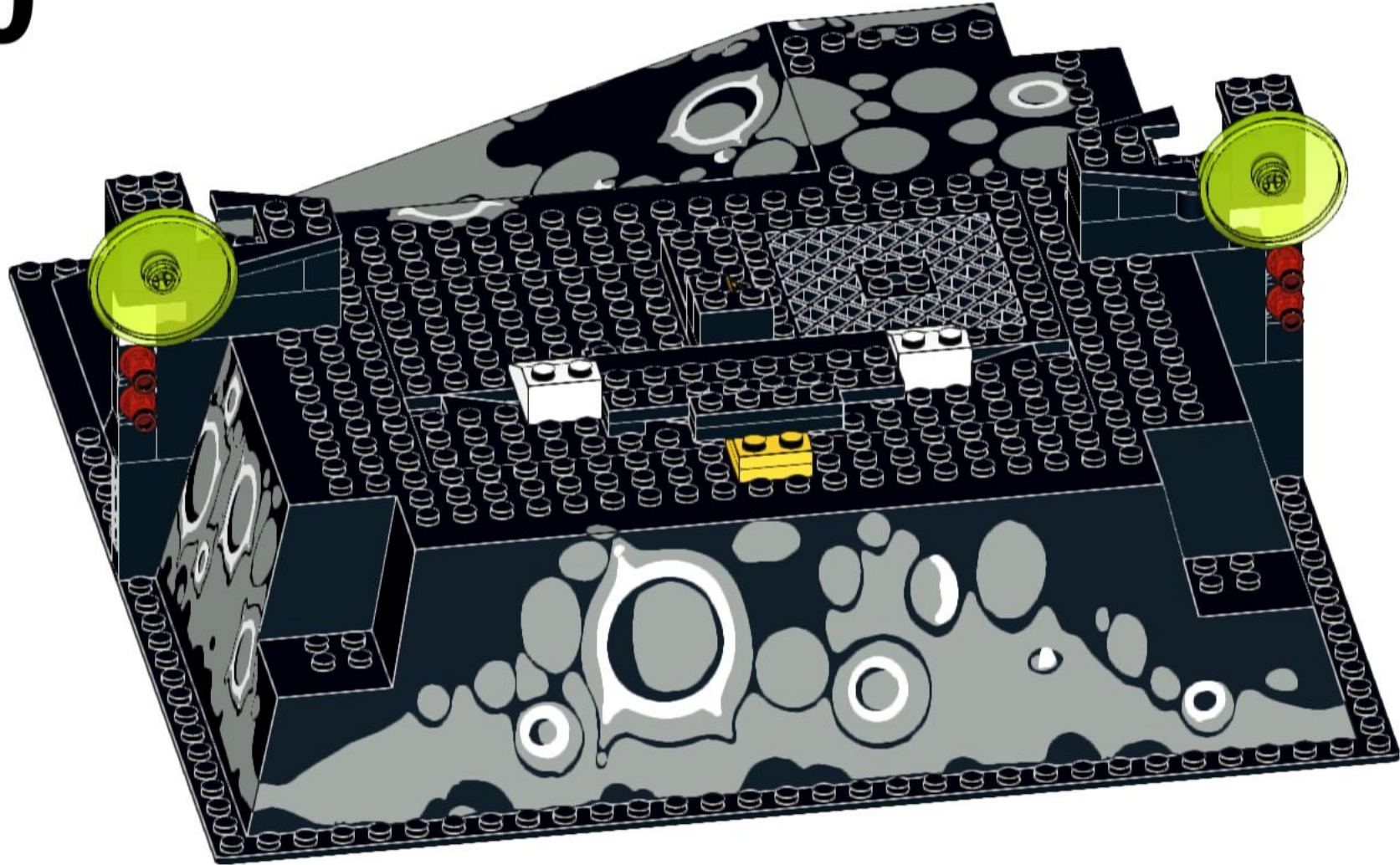

51

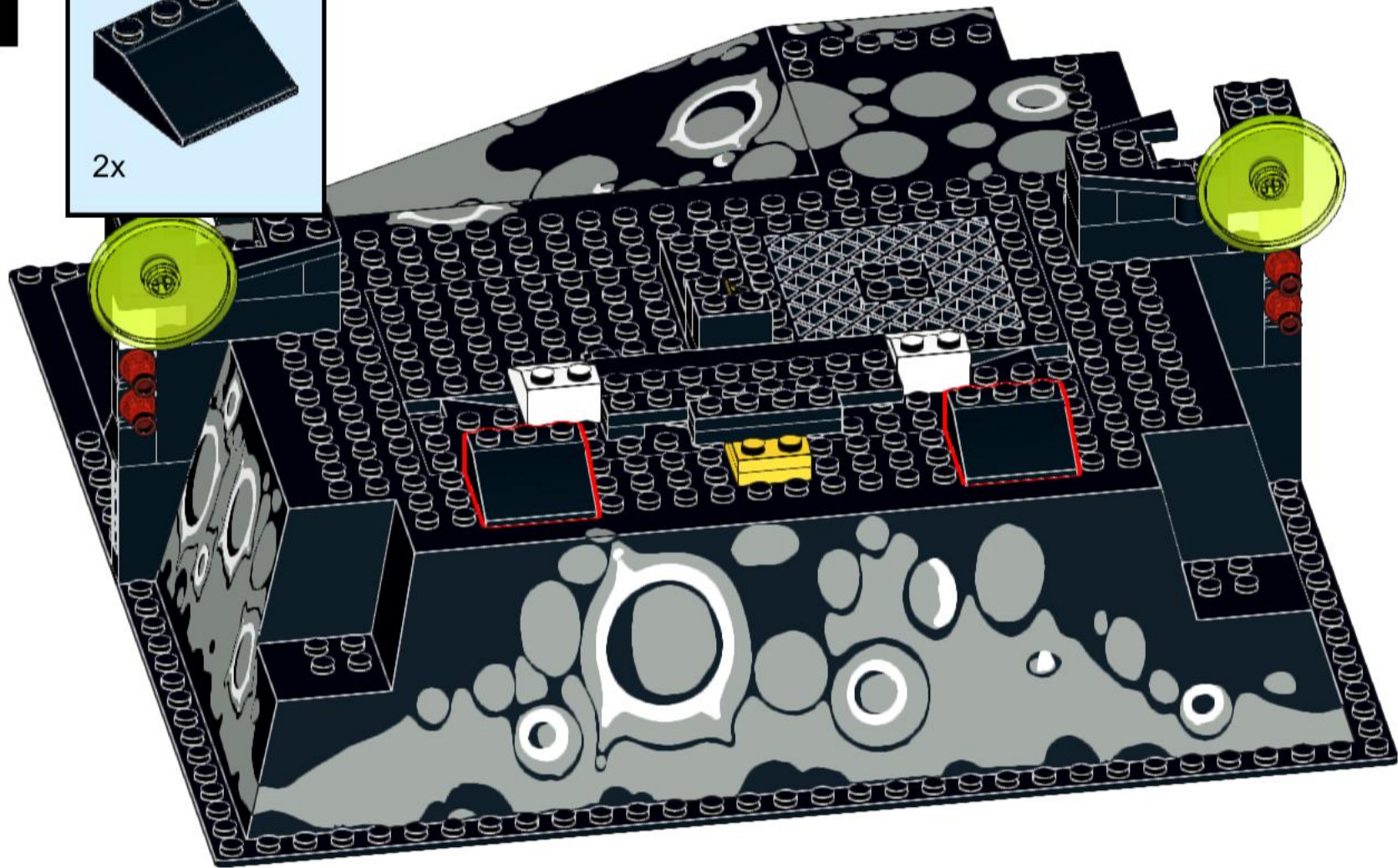
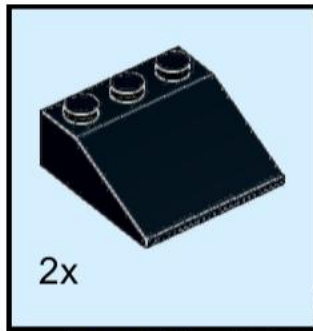

52

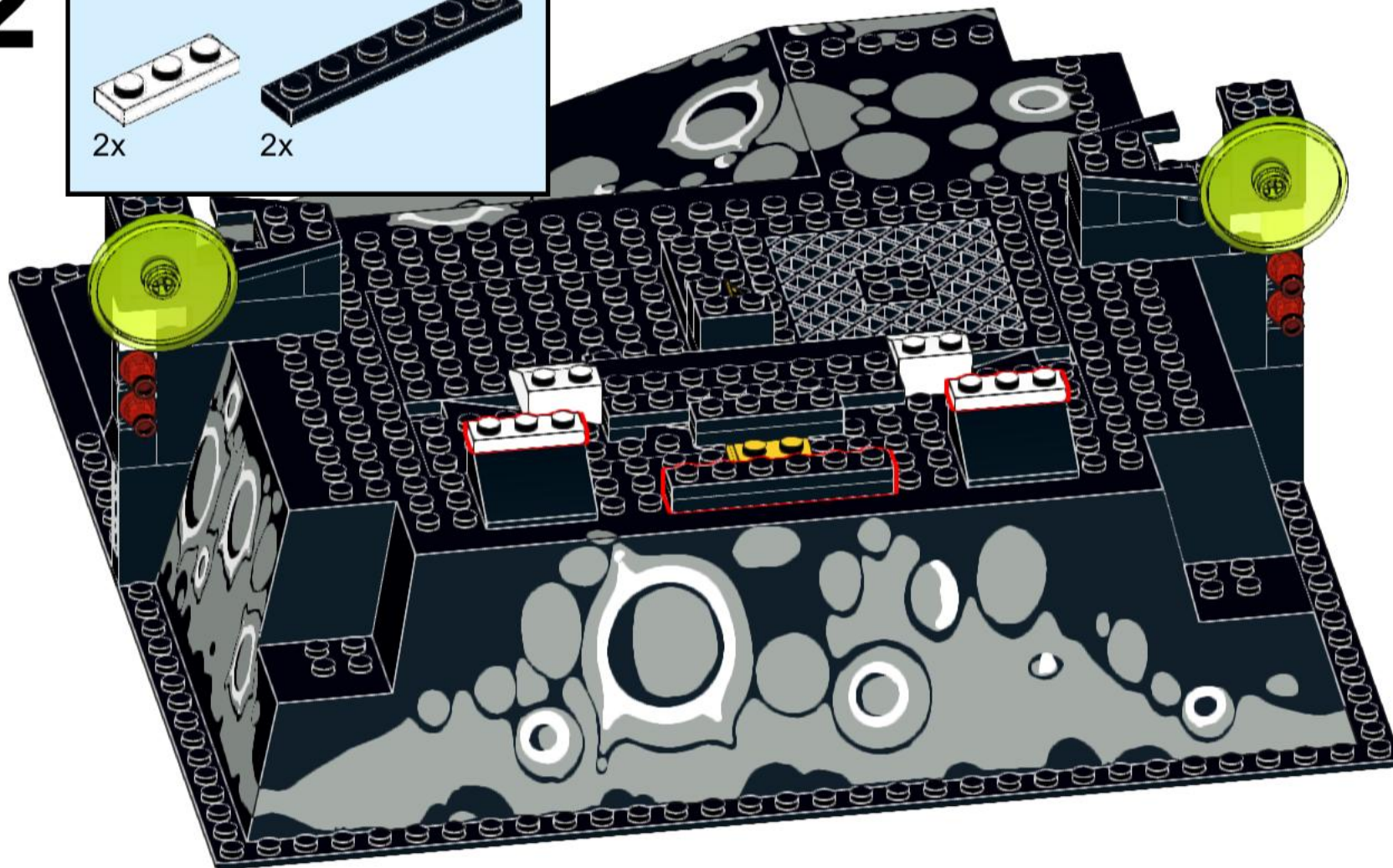
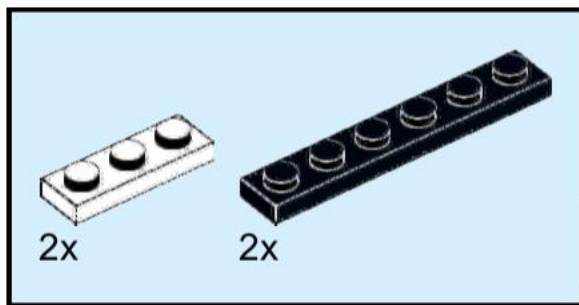

53

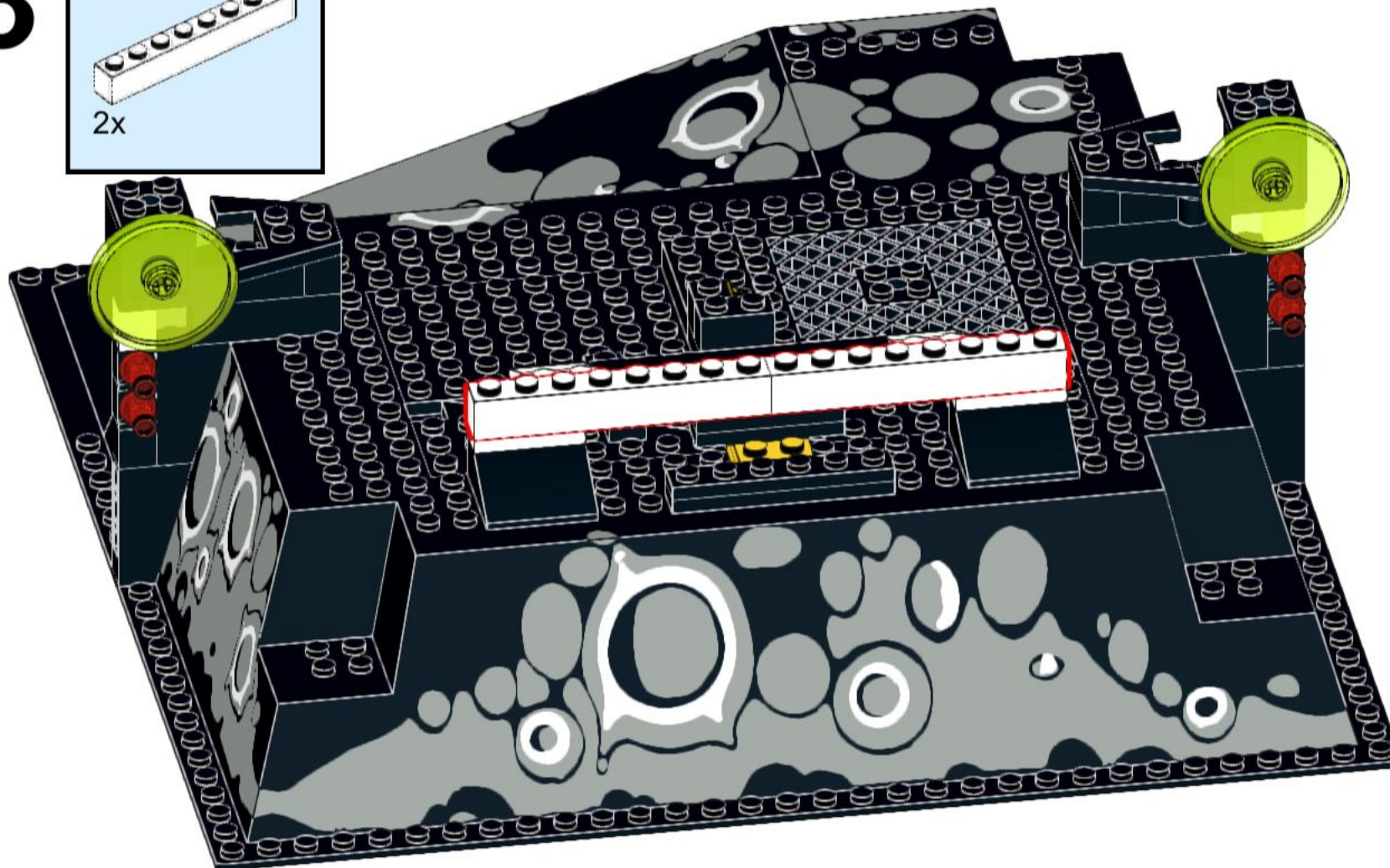
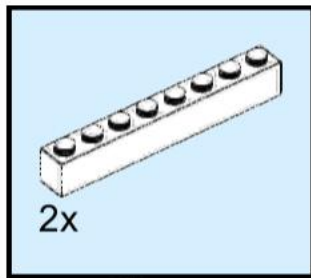

These are the lights, but I could not make that work with the editor

54

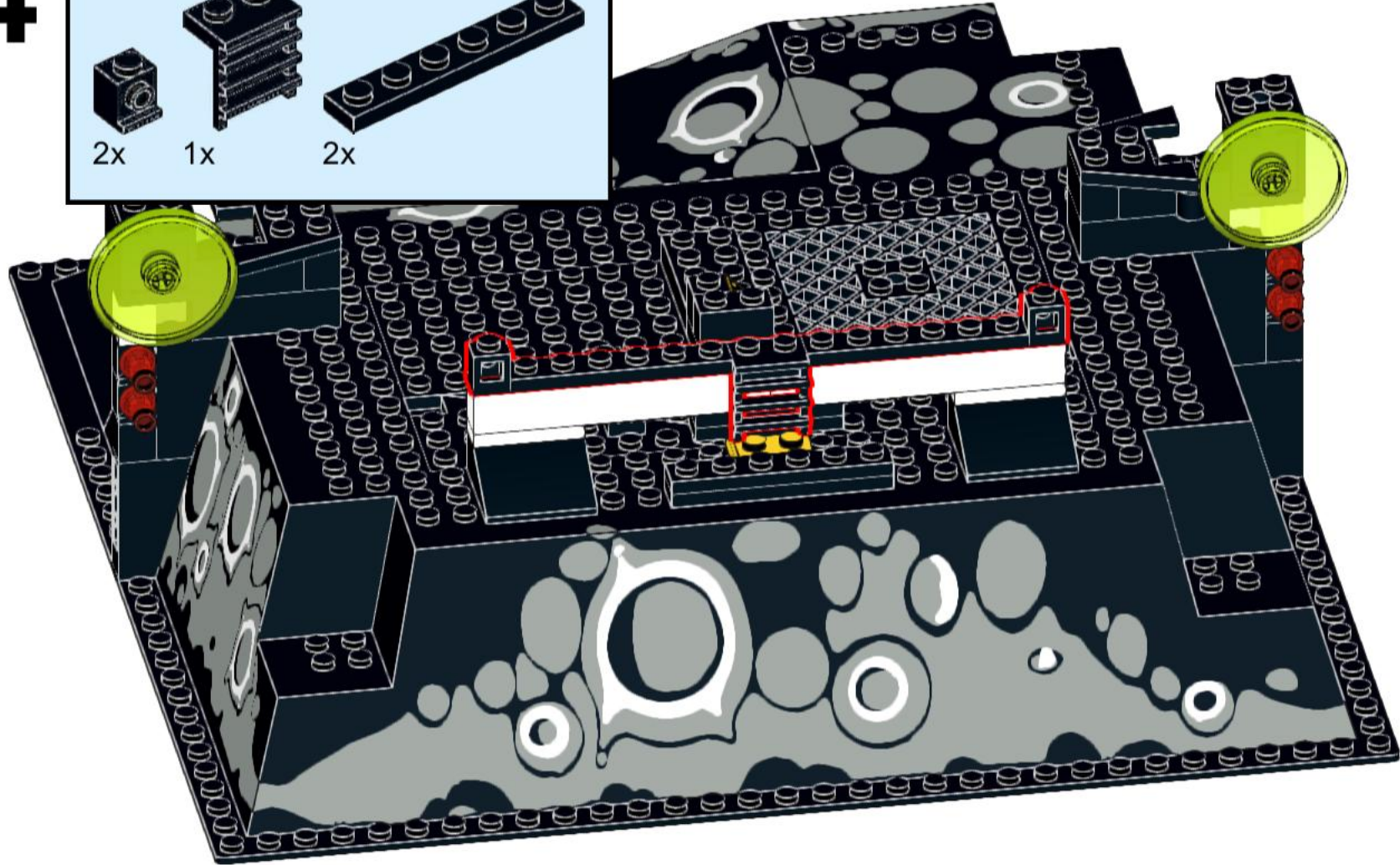
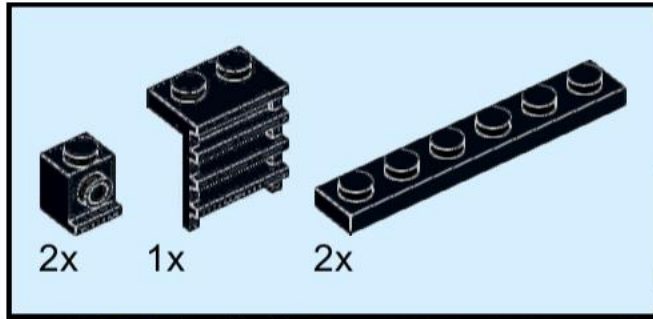

55

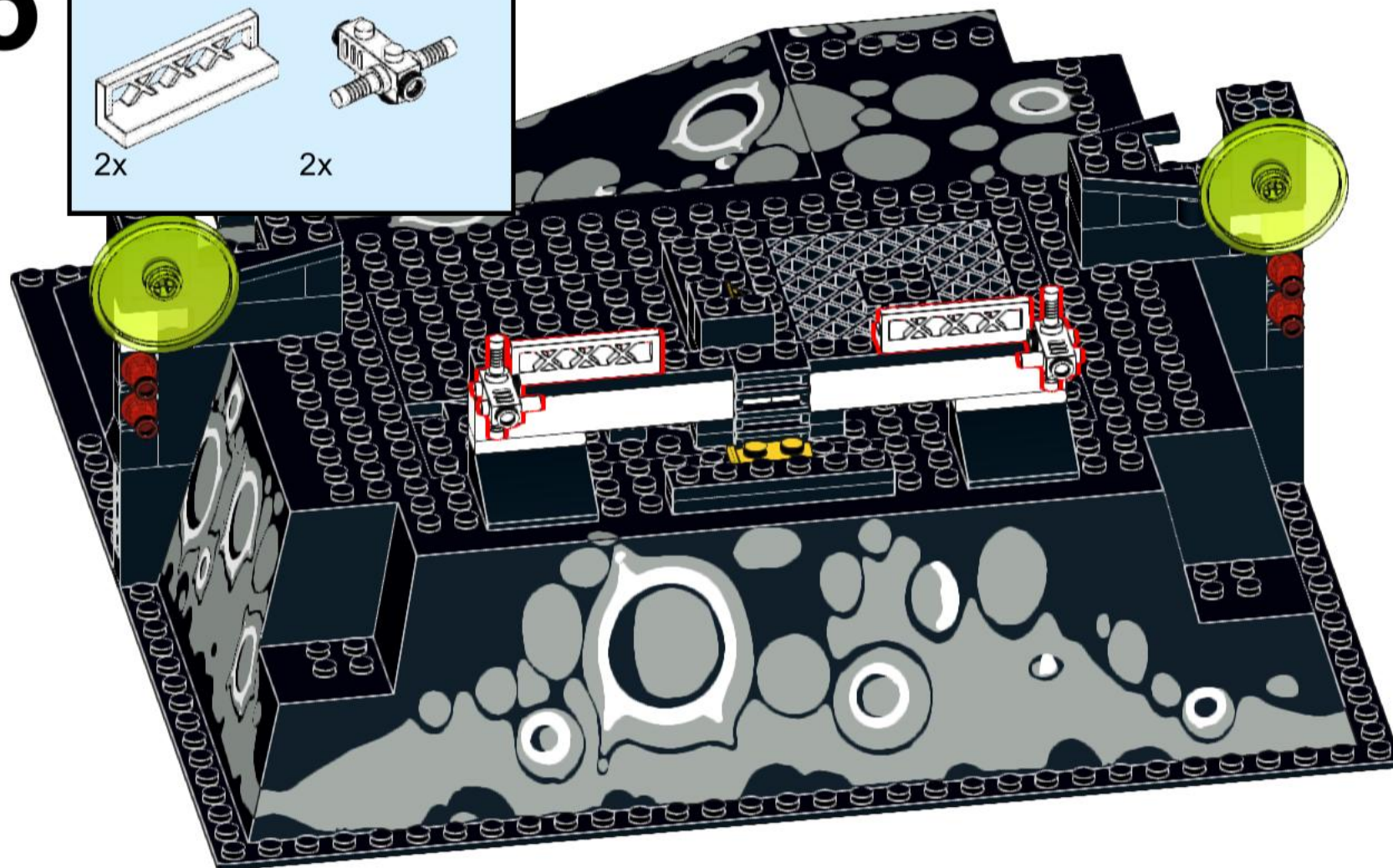
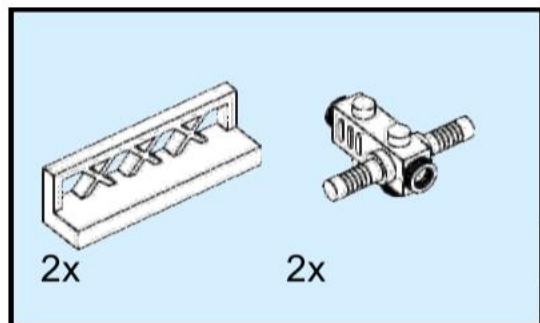

56

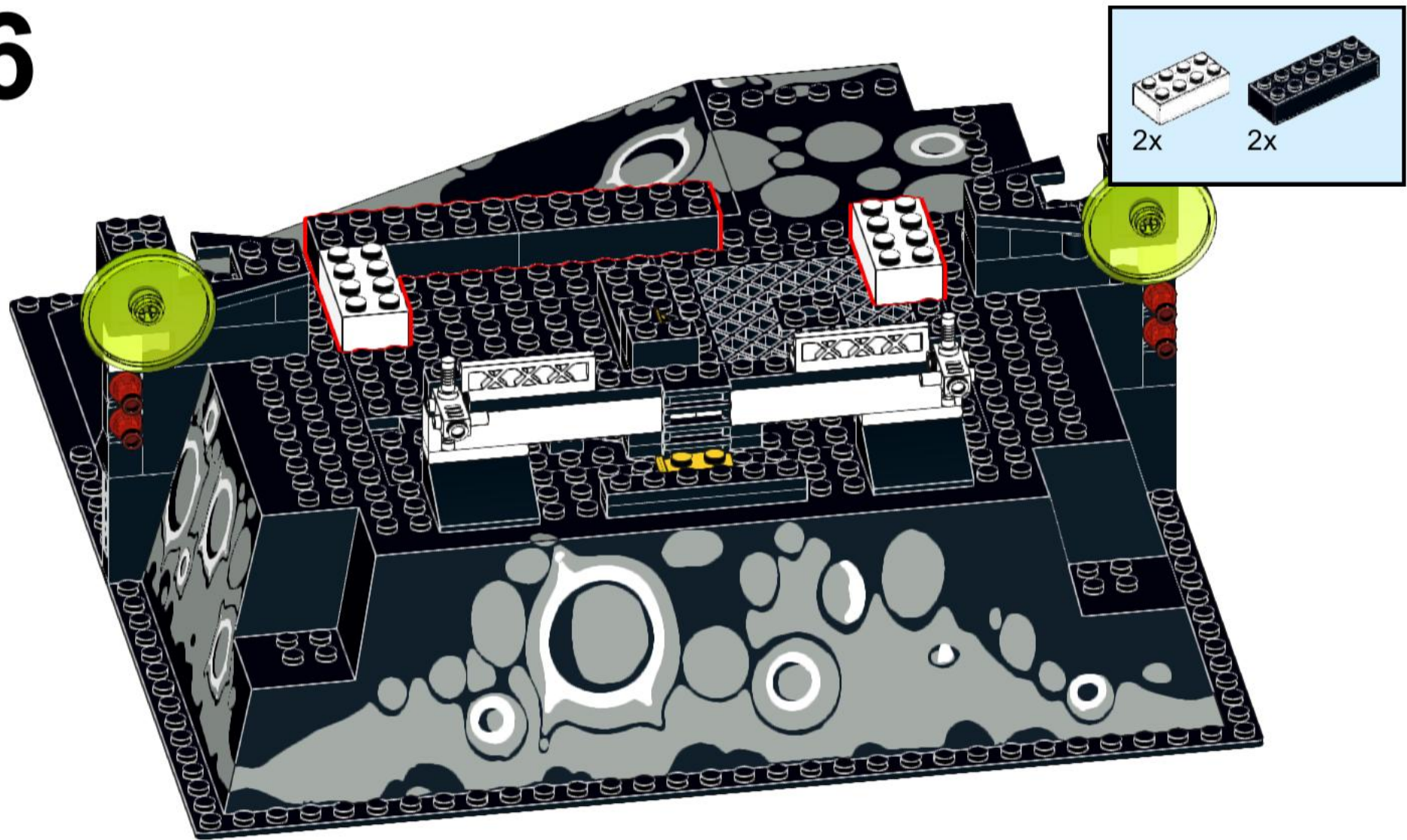

57

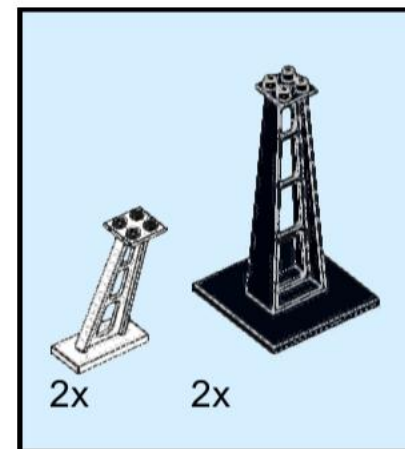
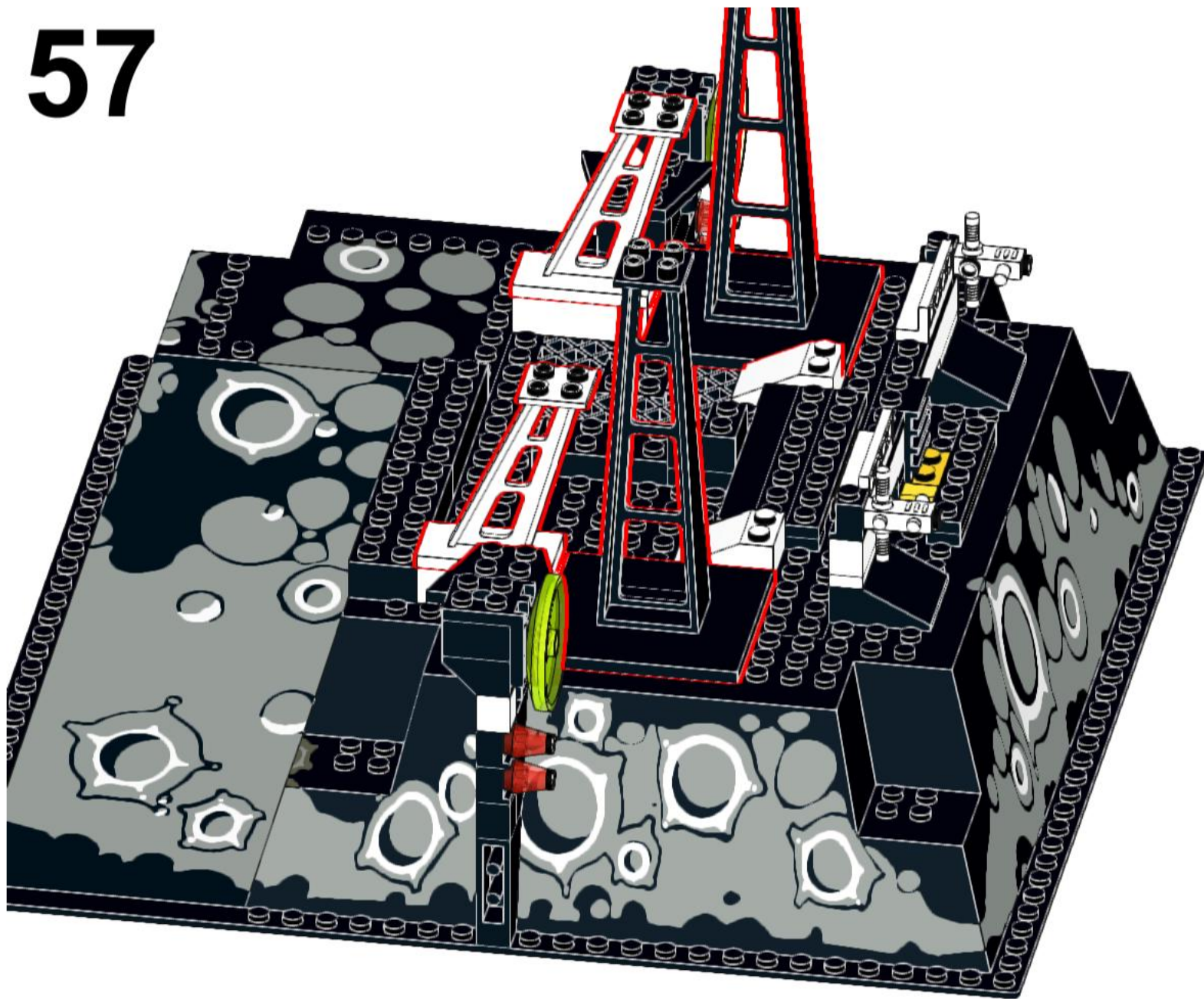

58

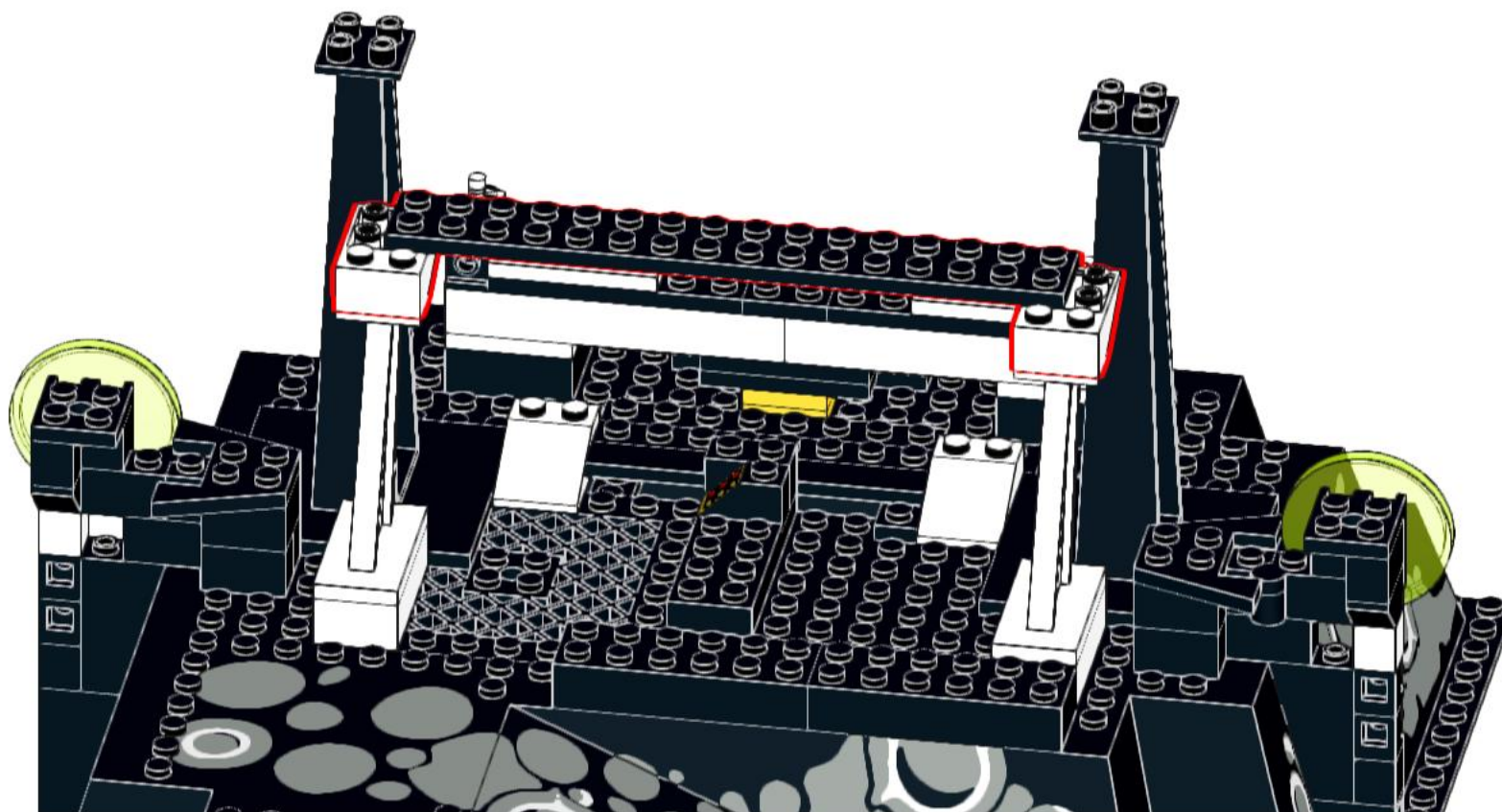
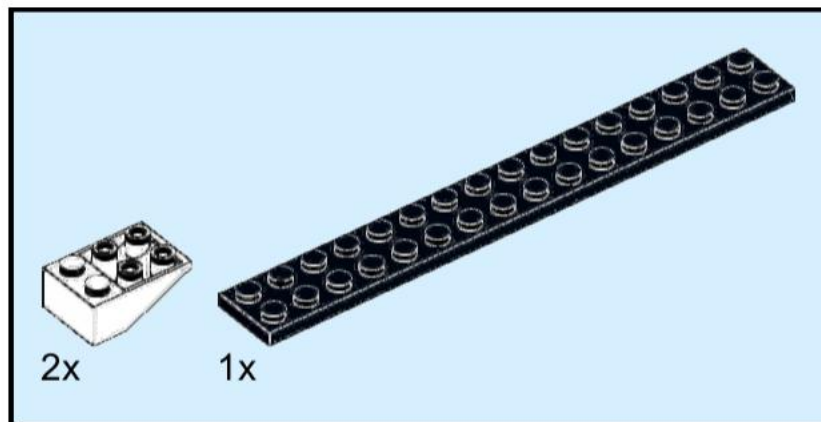

59

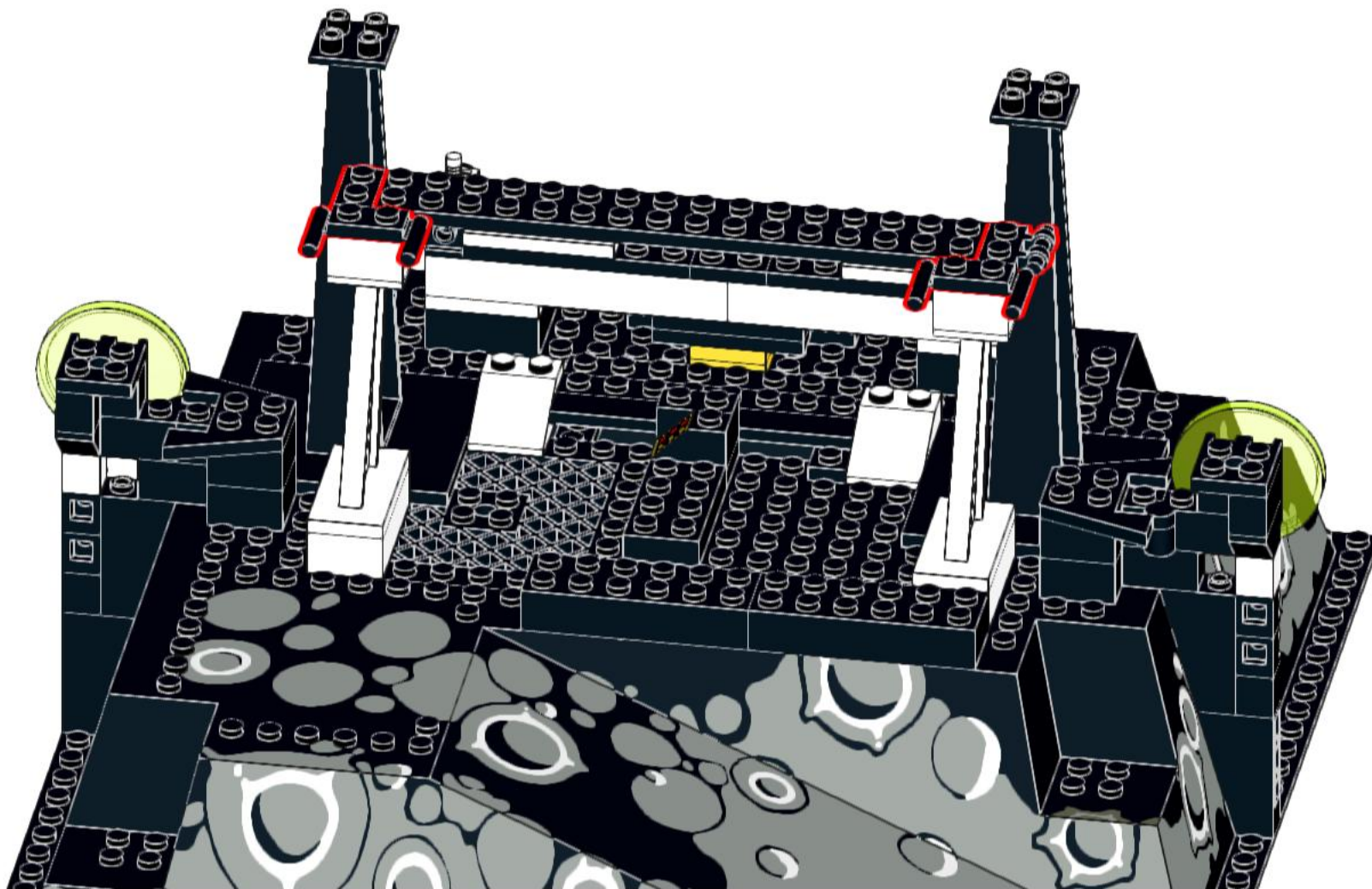
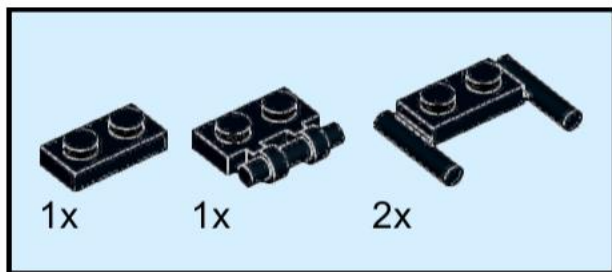

60

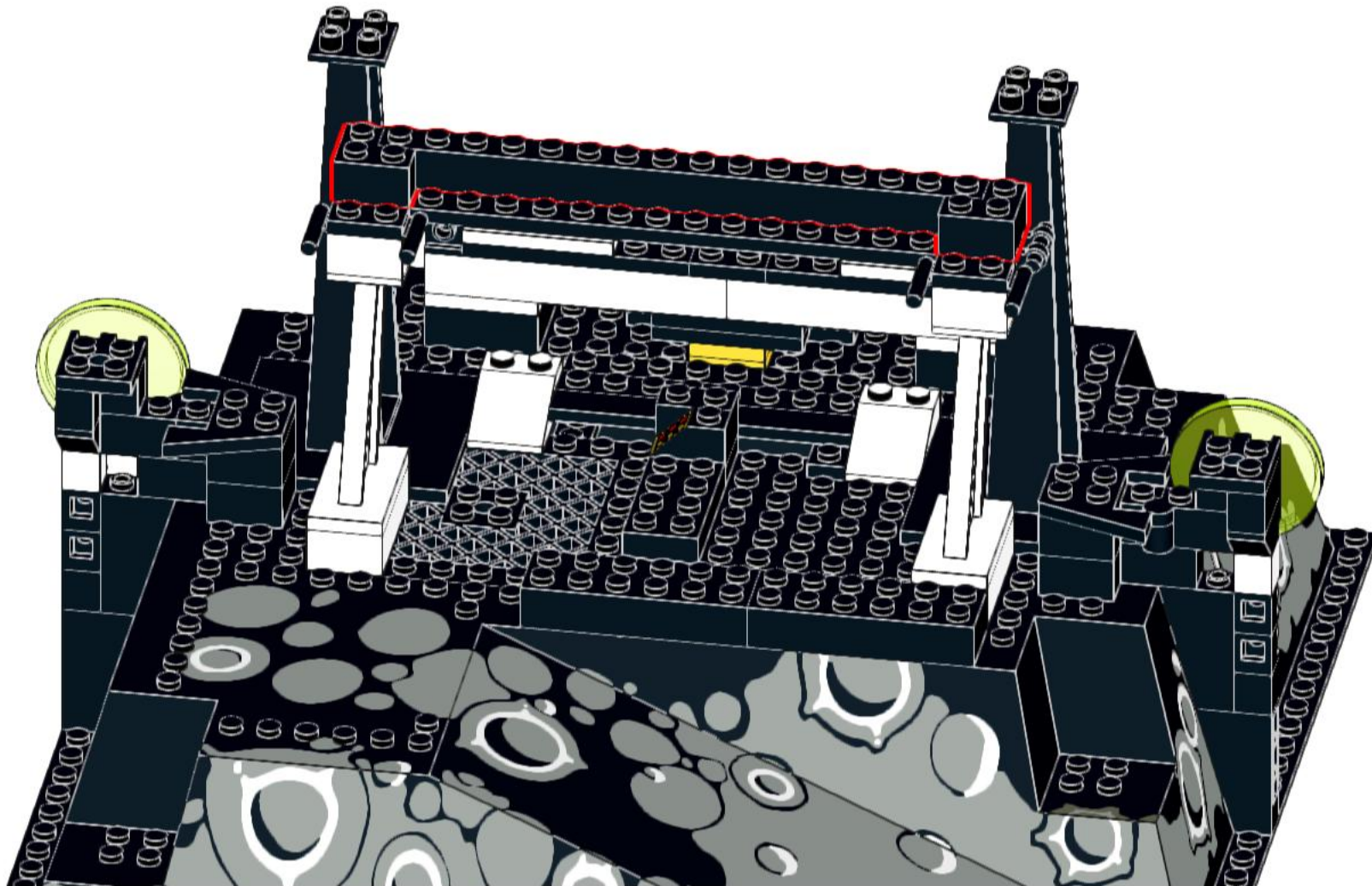
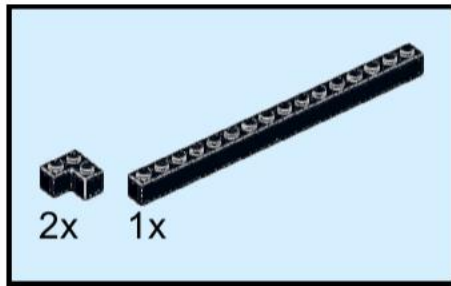

61

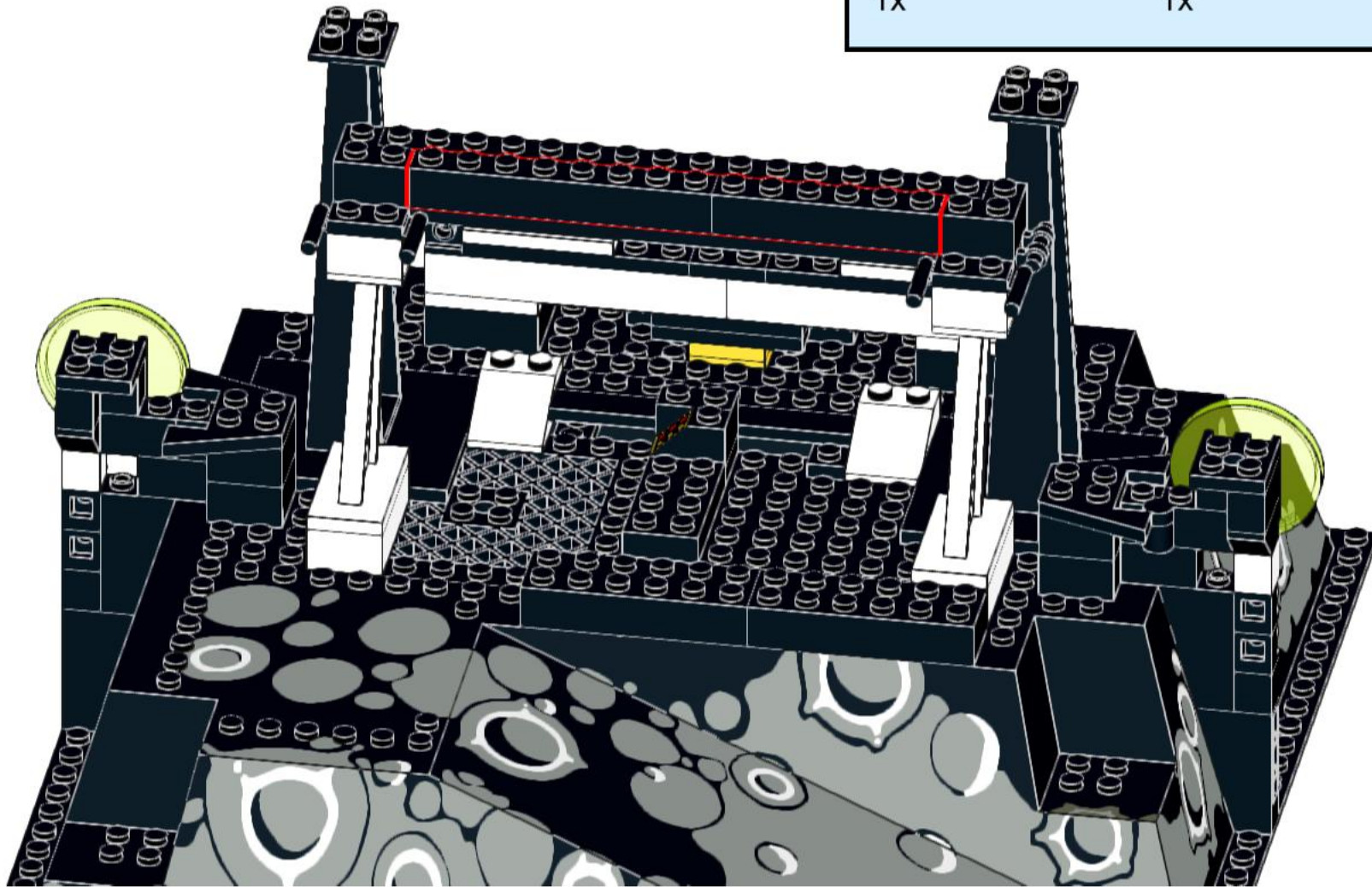
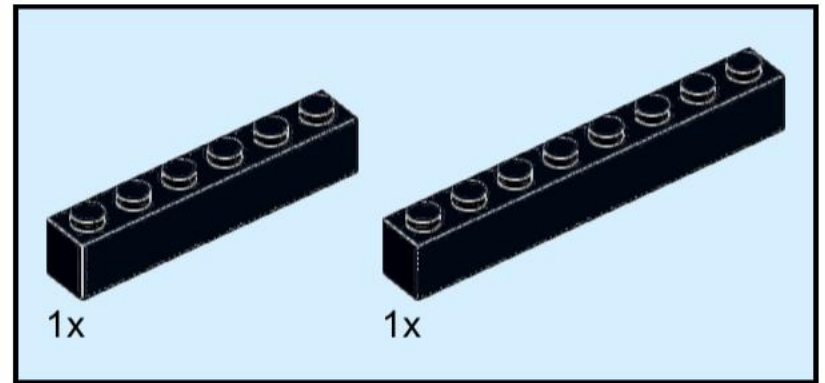

62

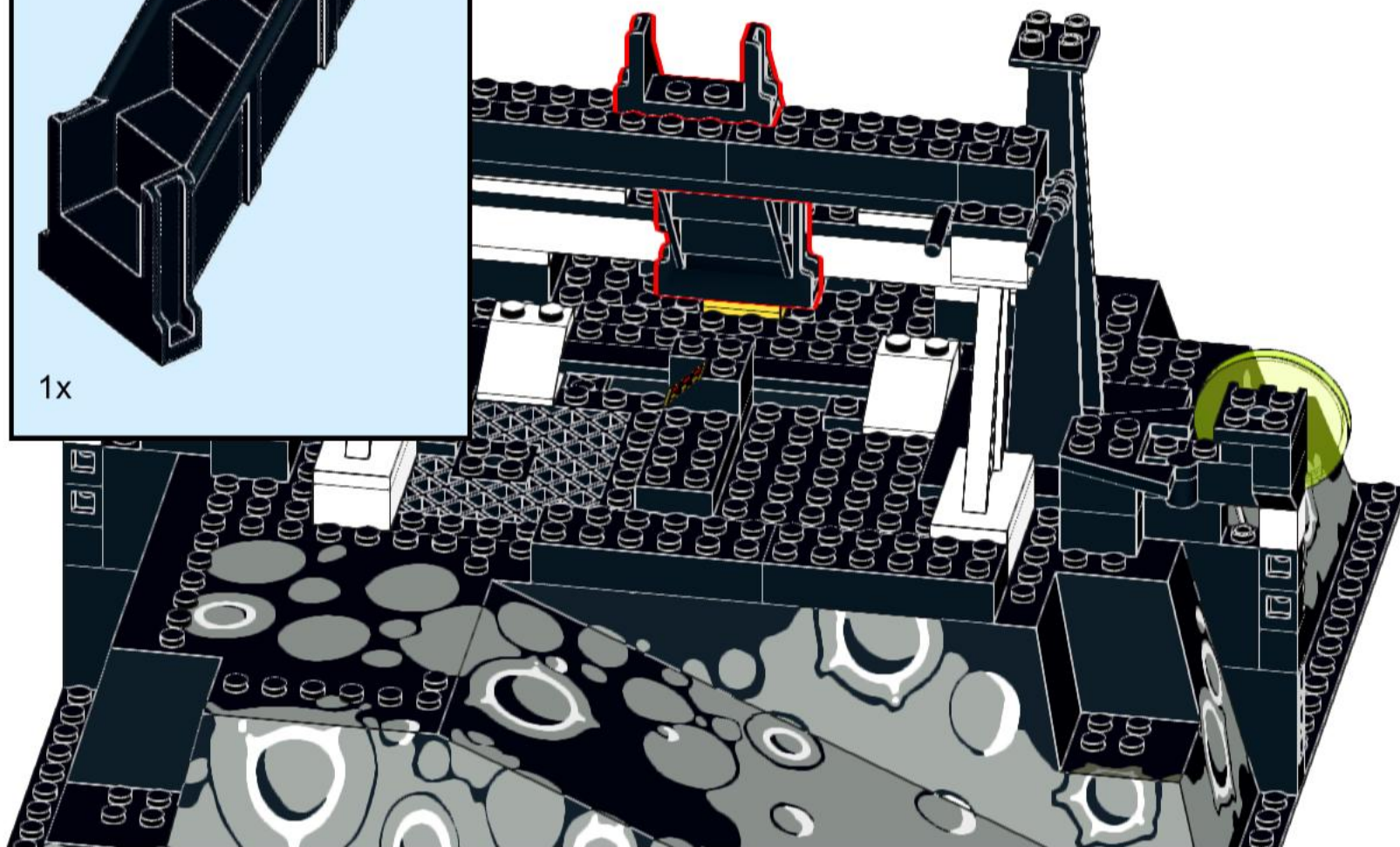
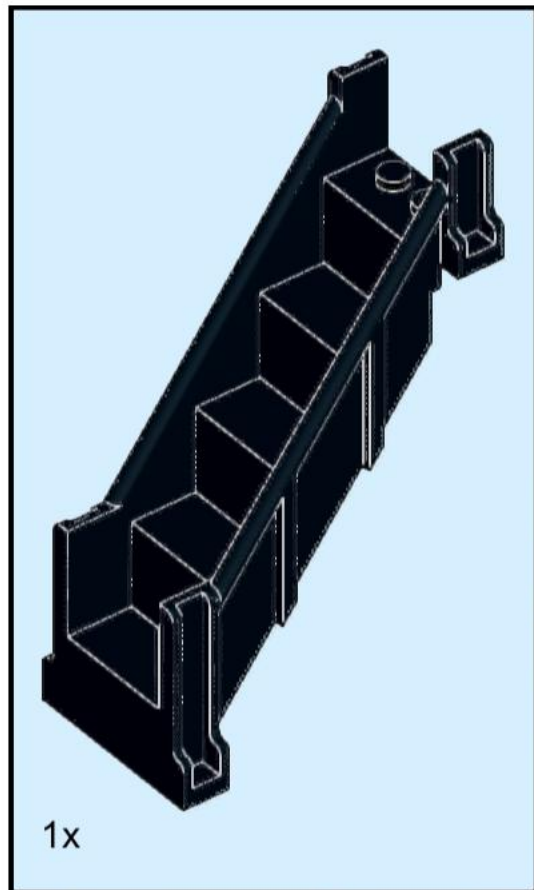

63

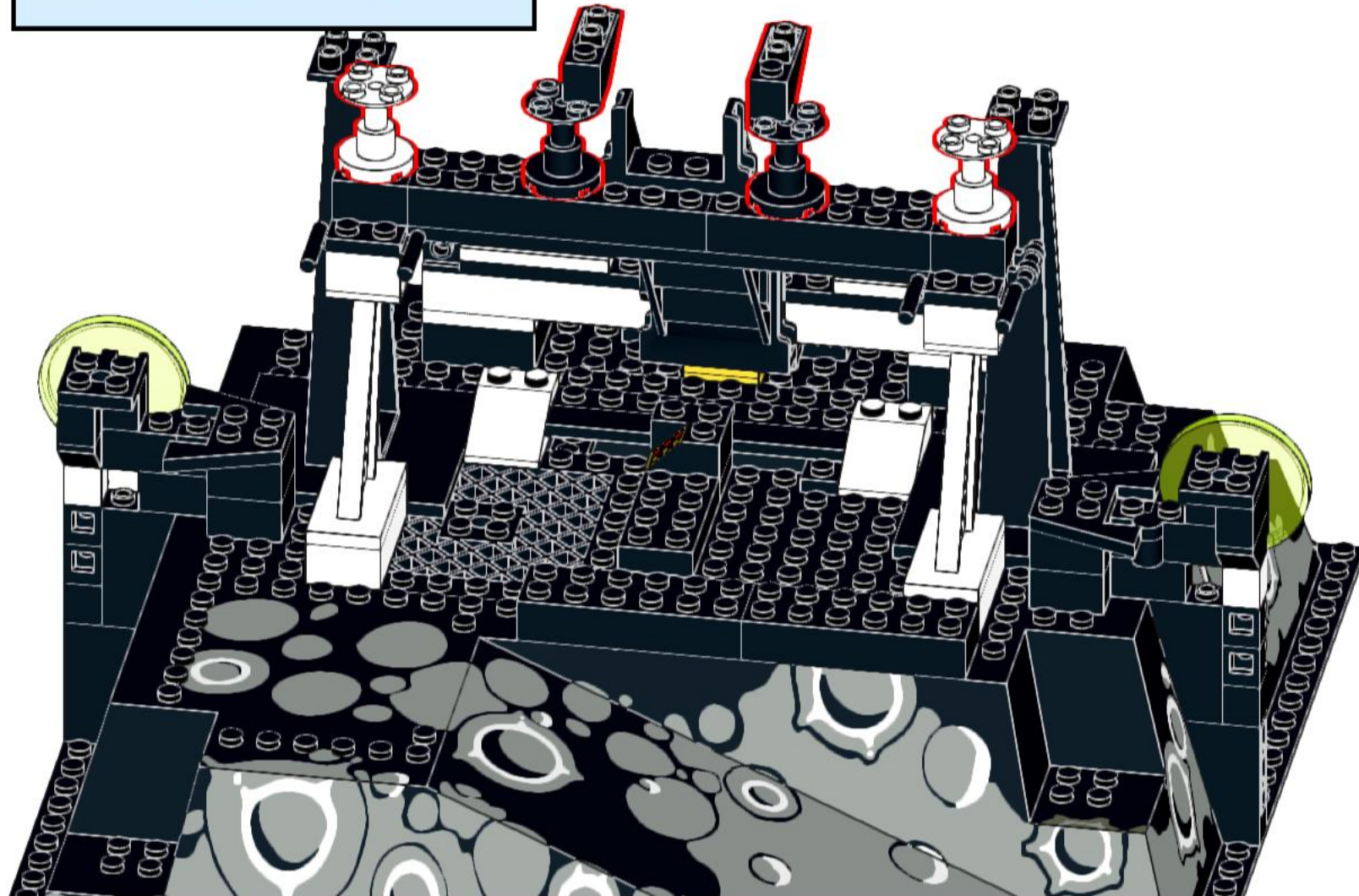
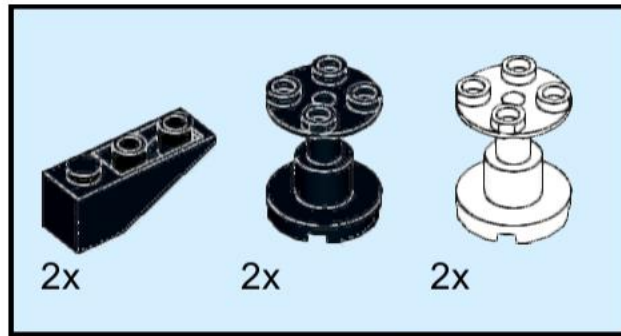

64

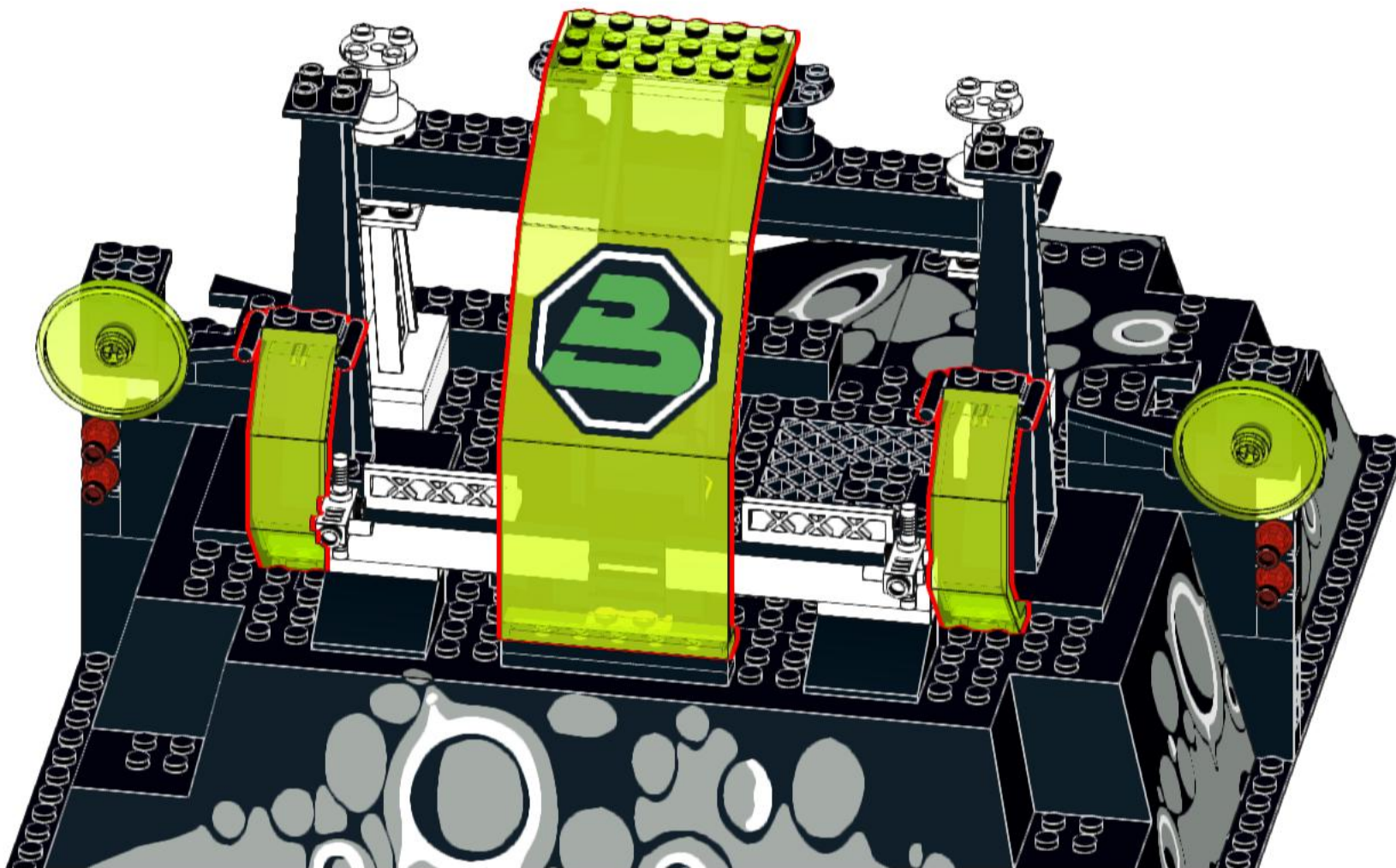
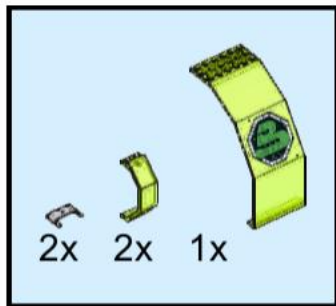

65

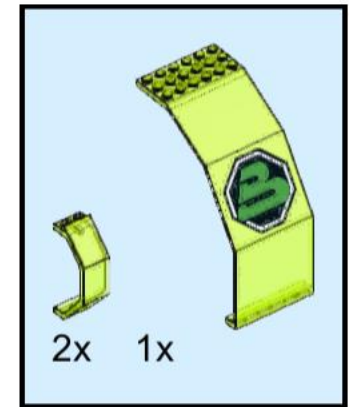
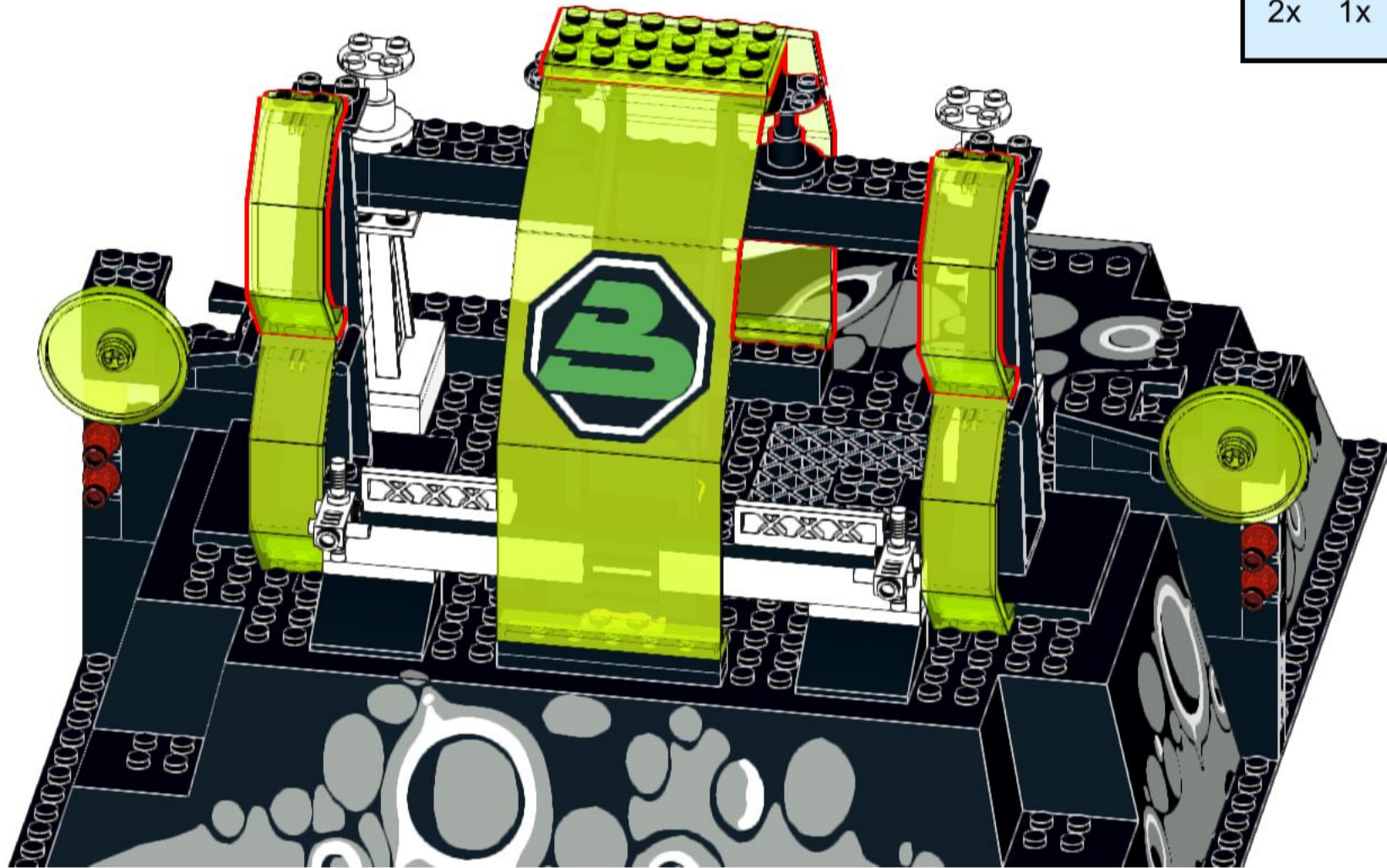

66

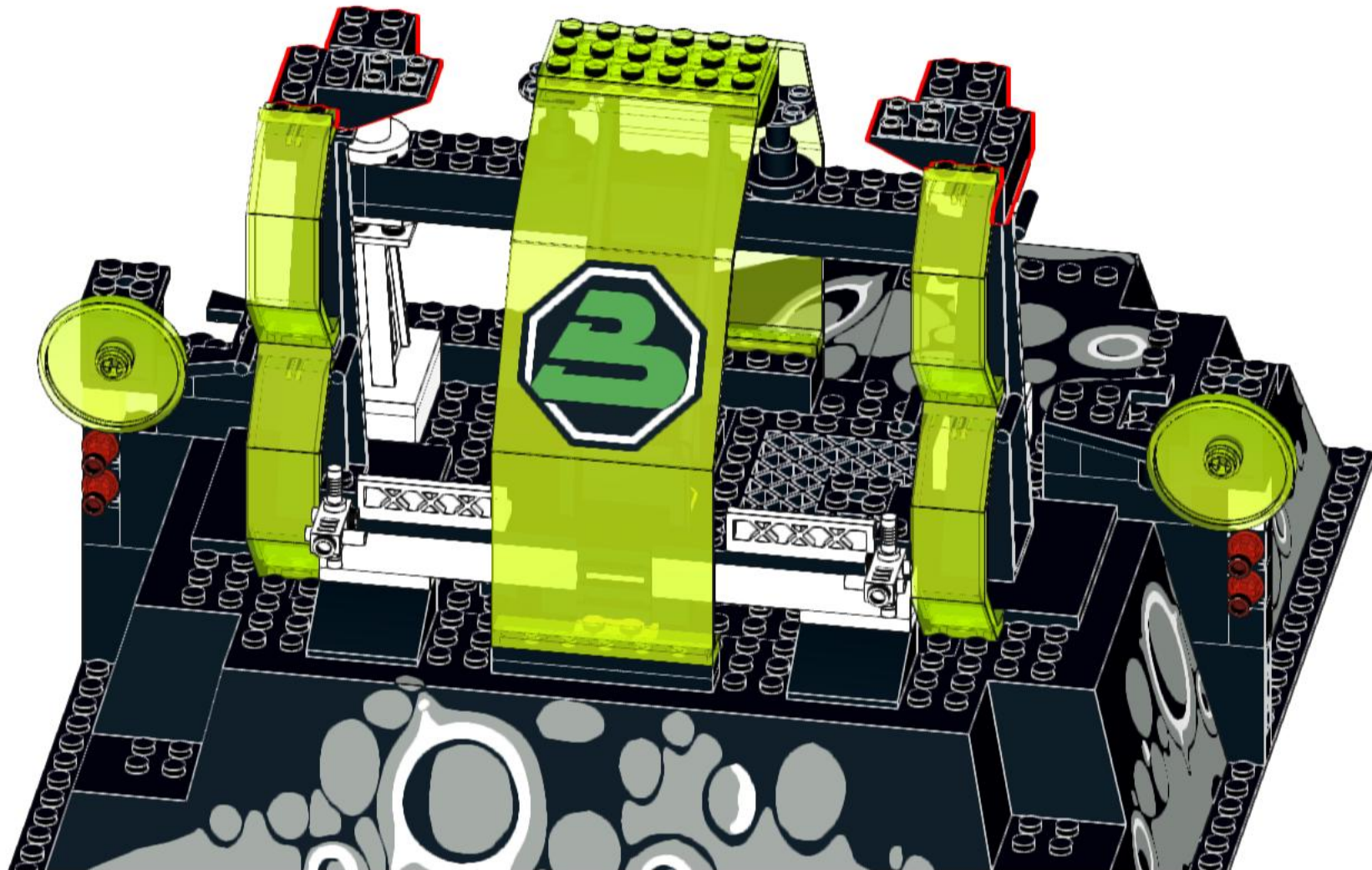
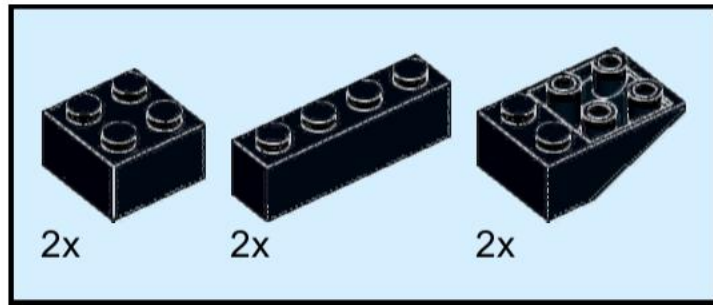

67

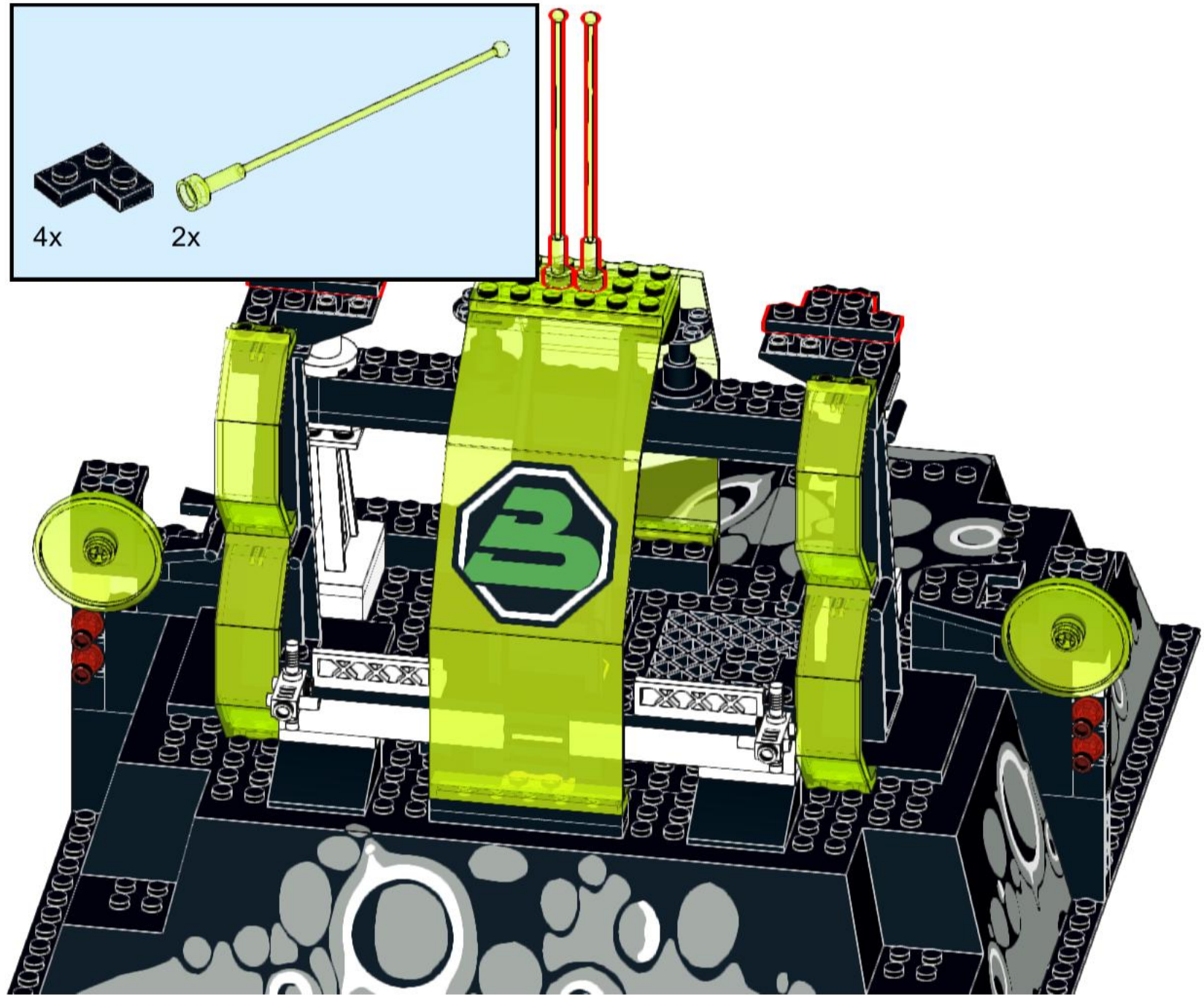
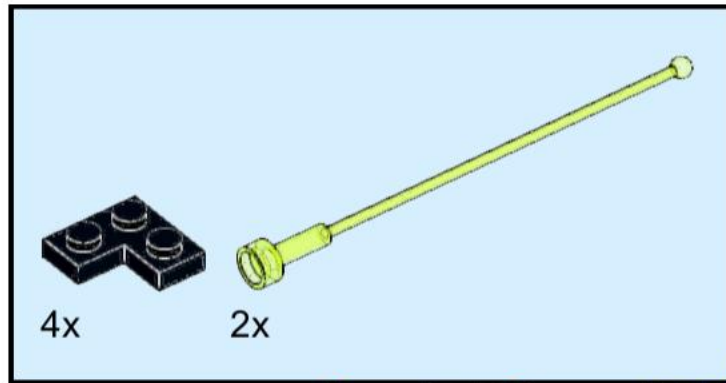

68

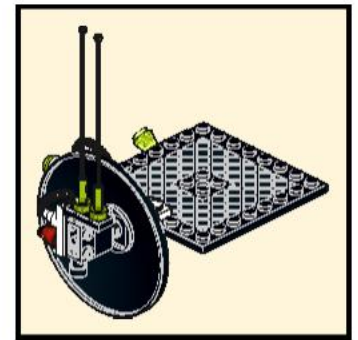
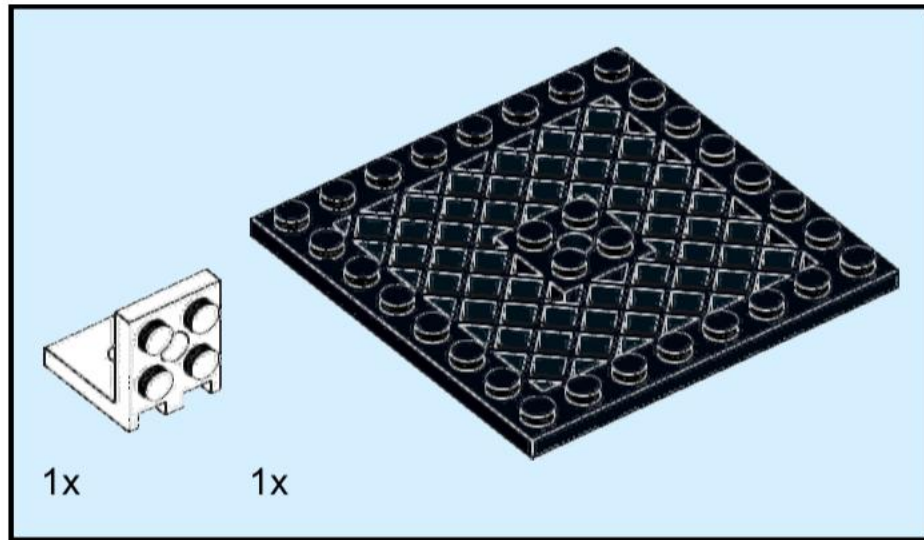

69

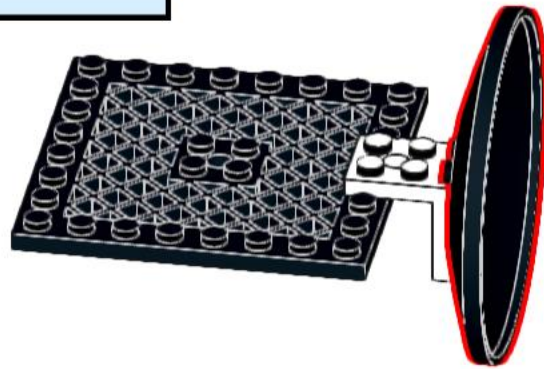

70

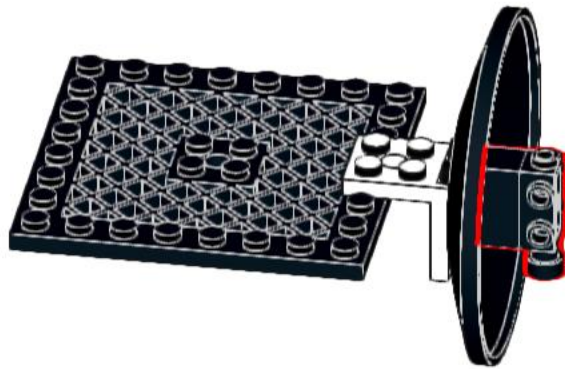
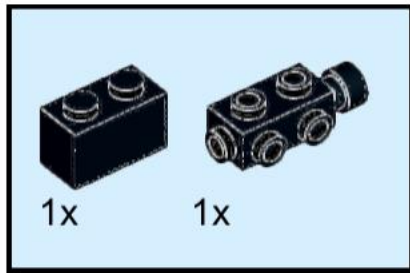

72

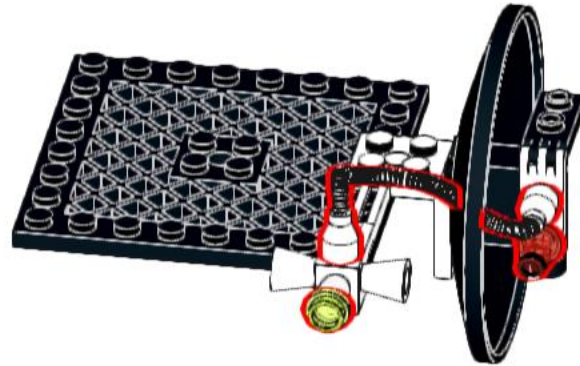
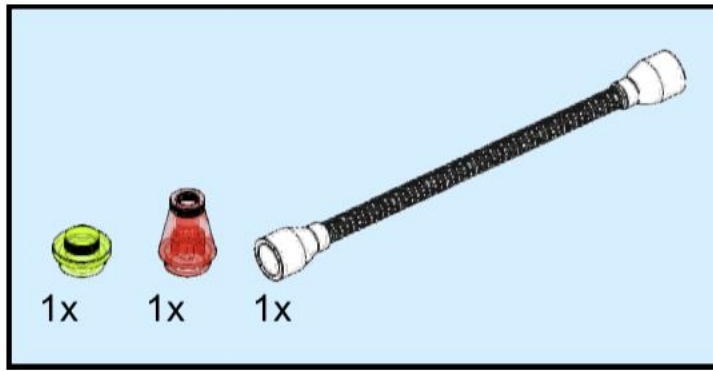

73

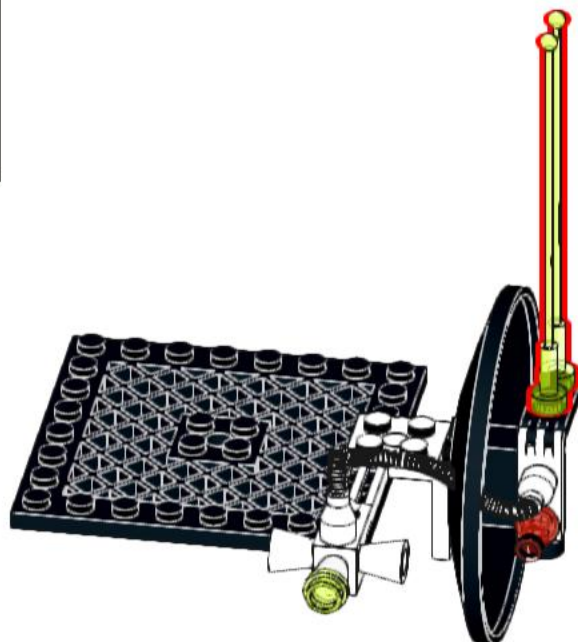
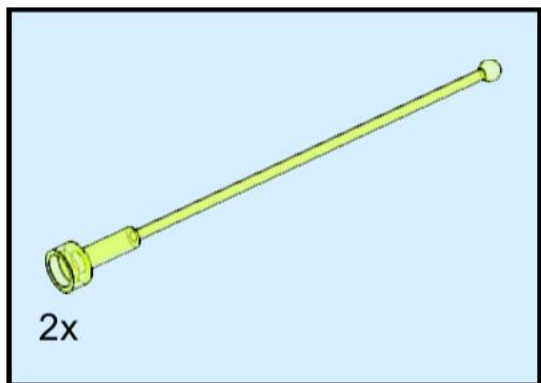

76

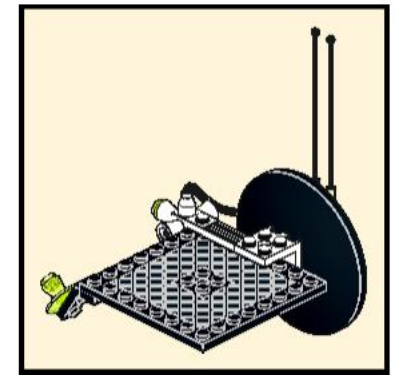
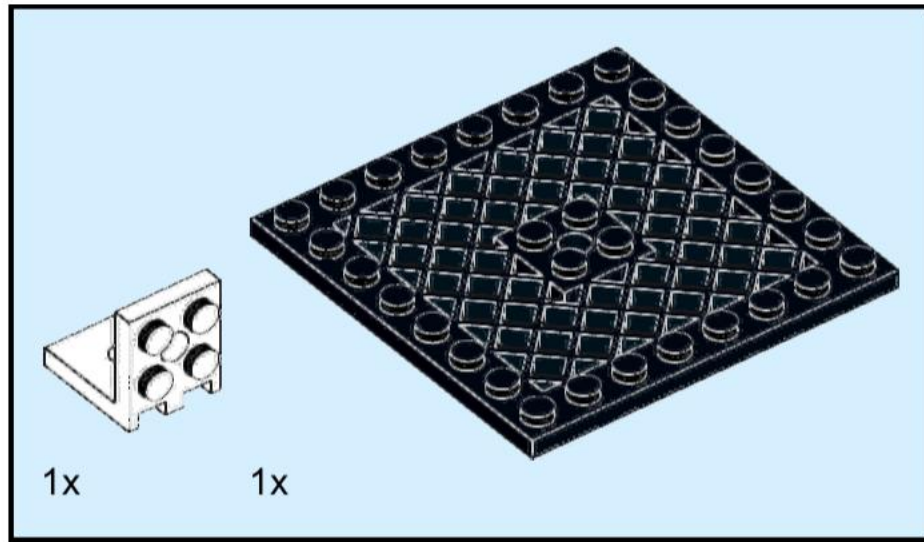

77

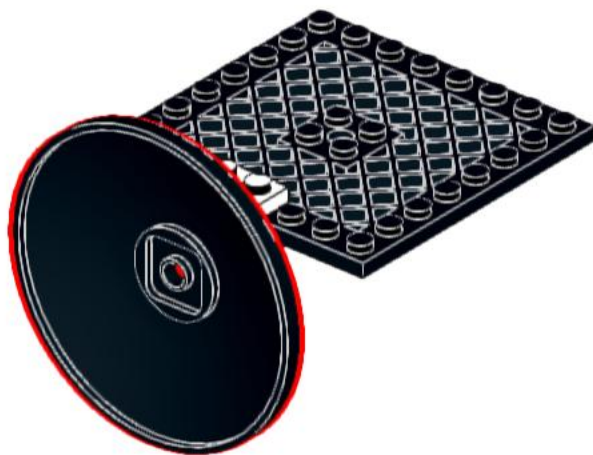

78

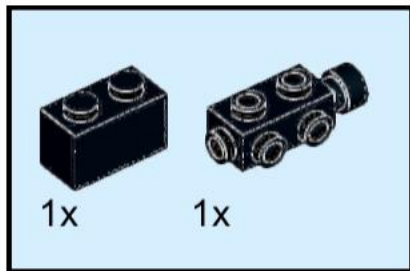

79

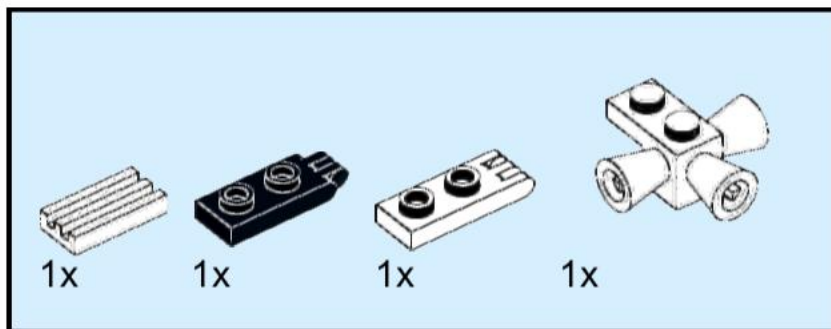

80

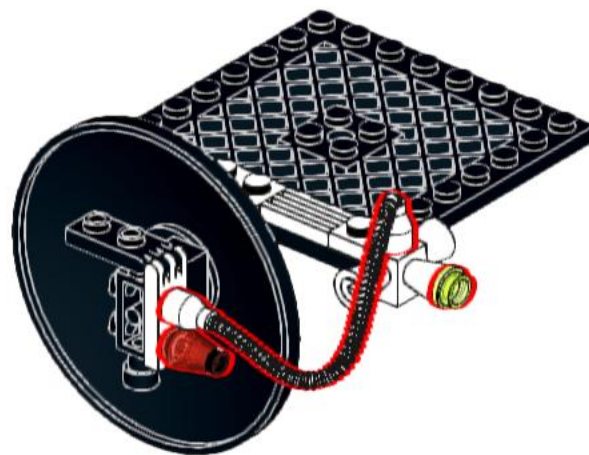
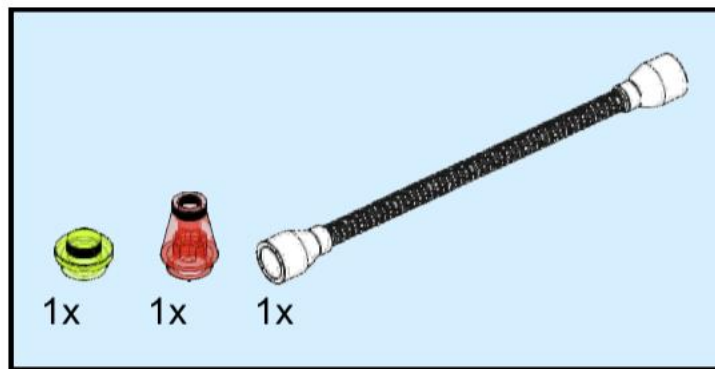

81

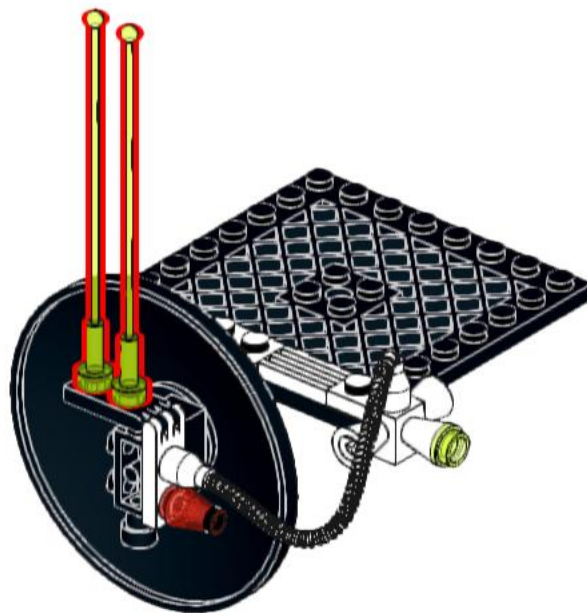
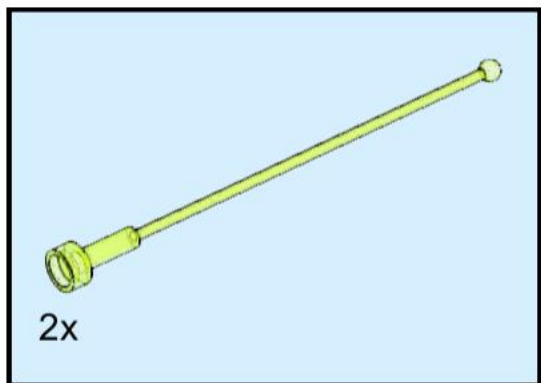

82

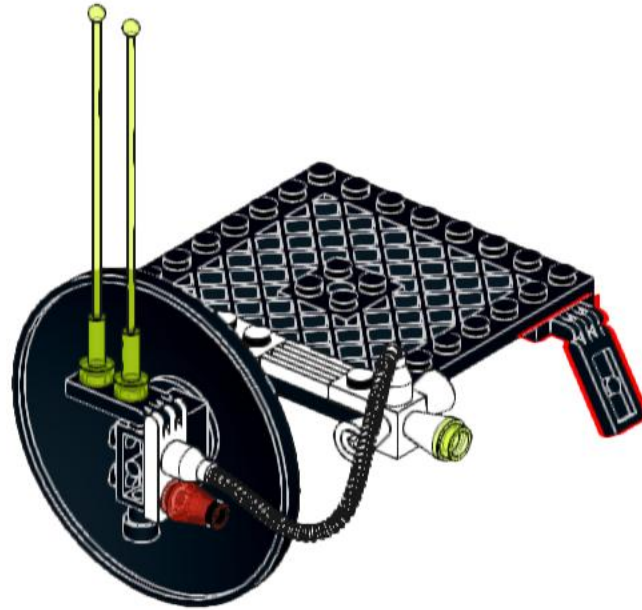
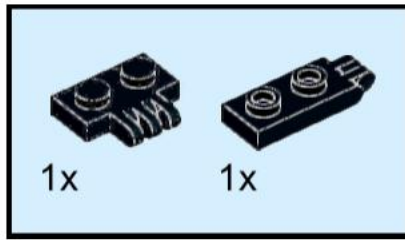

83

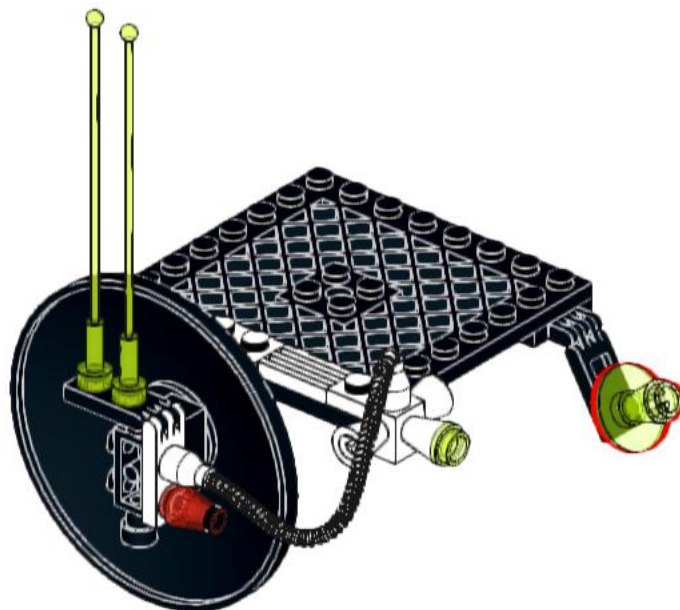
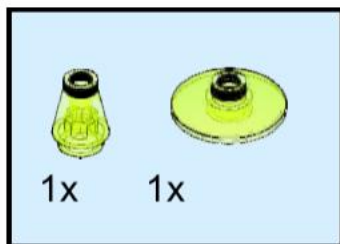

84

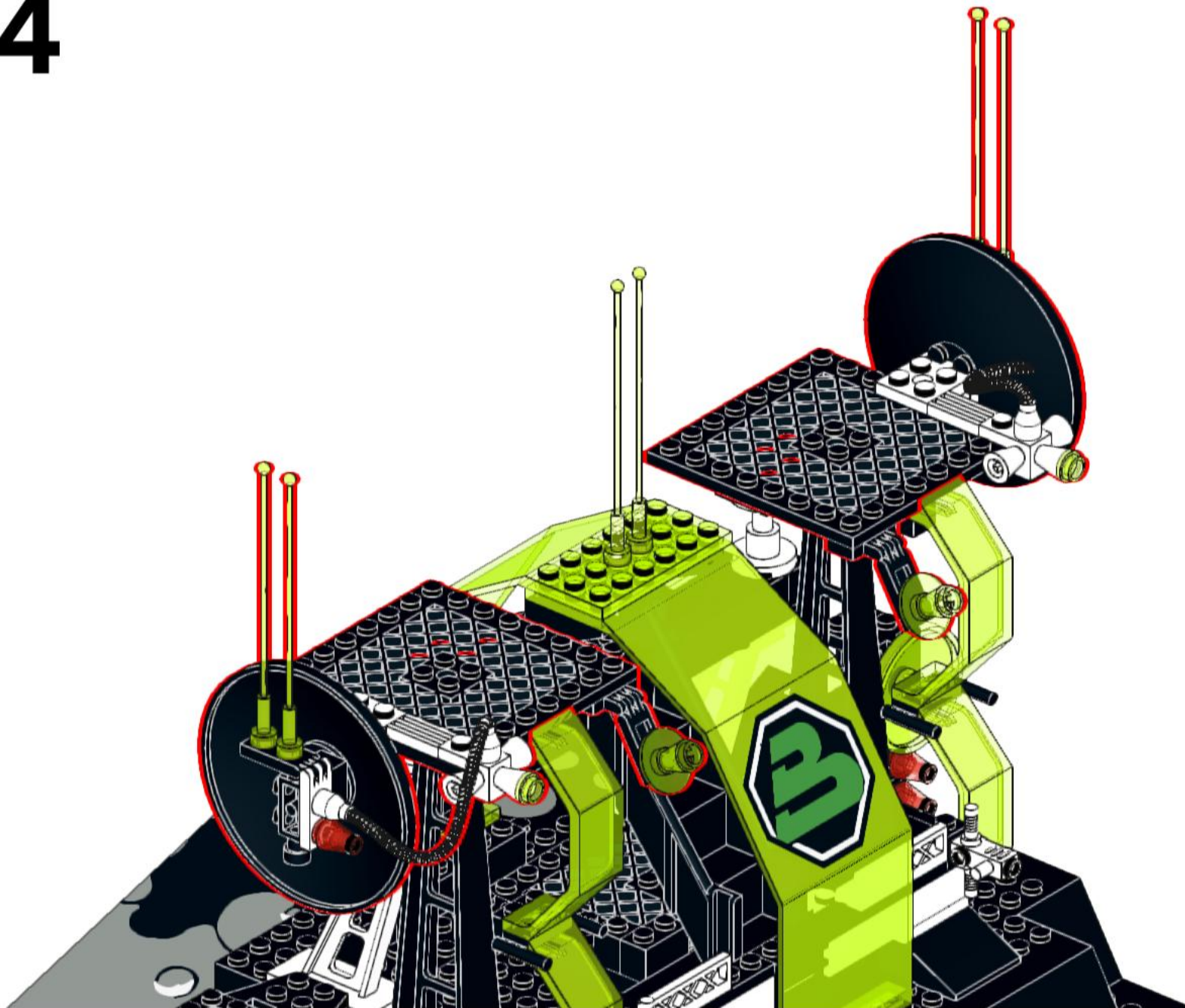

85

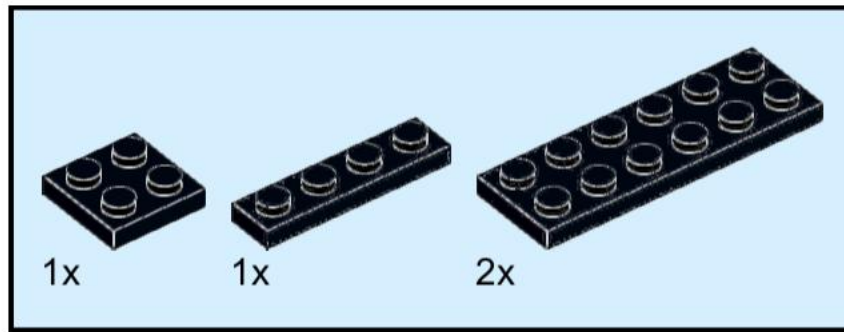

You could replace these with 2x10 plates if you have some on reserve

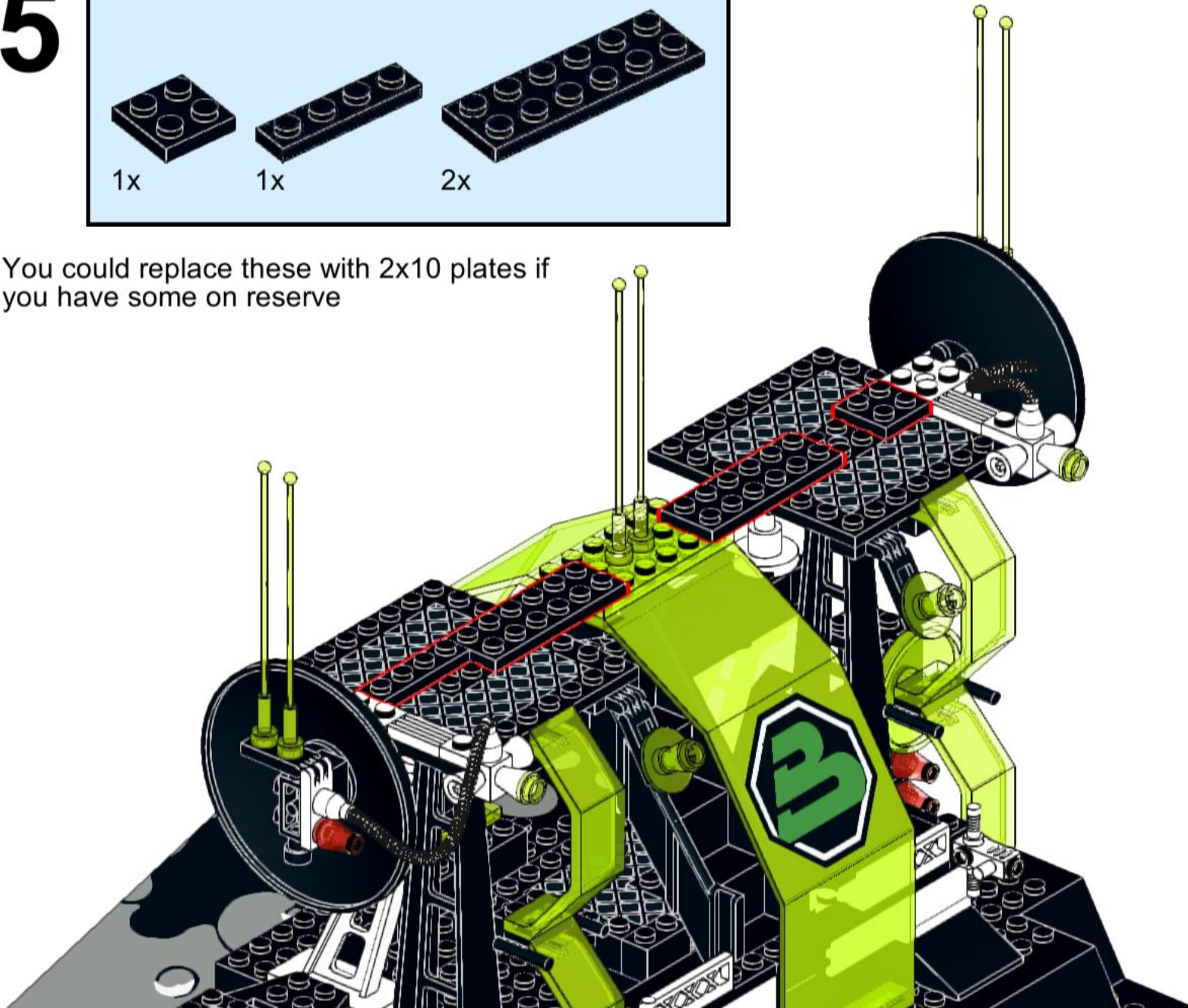

86

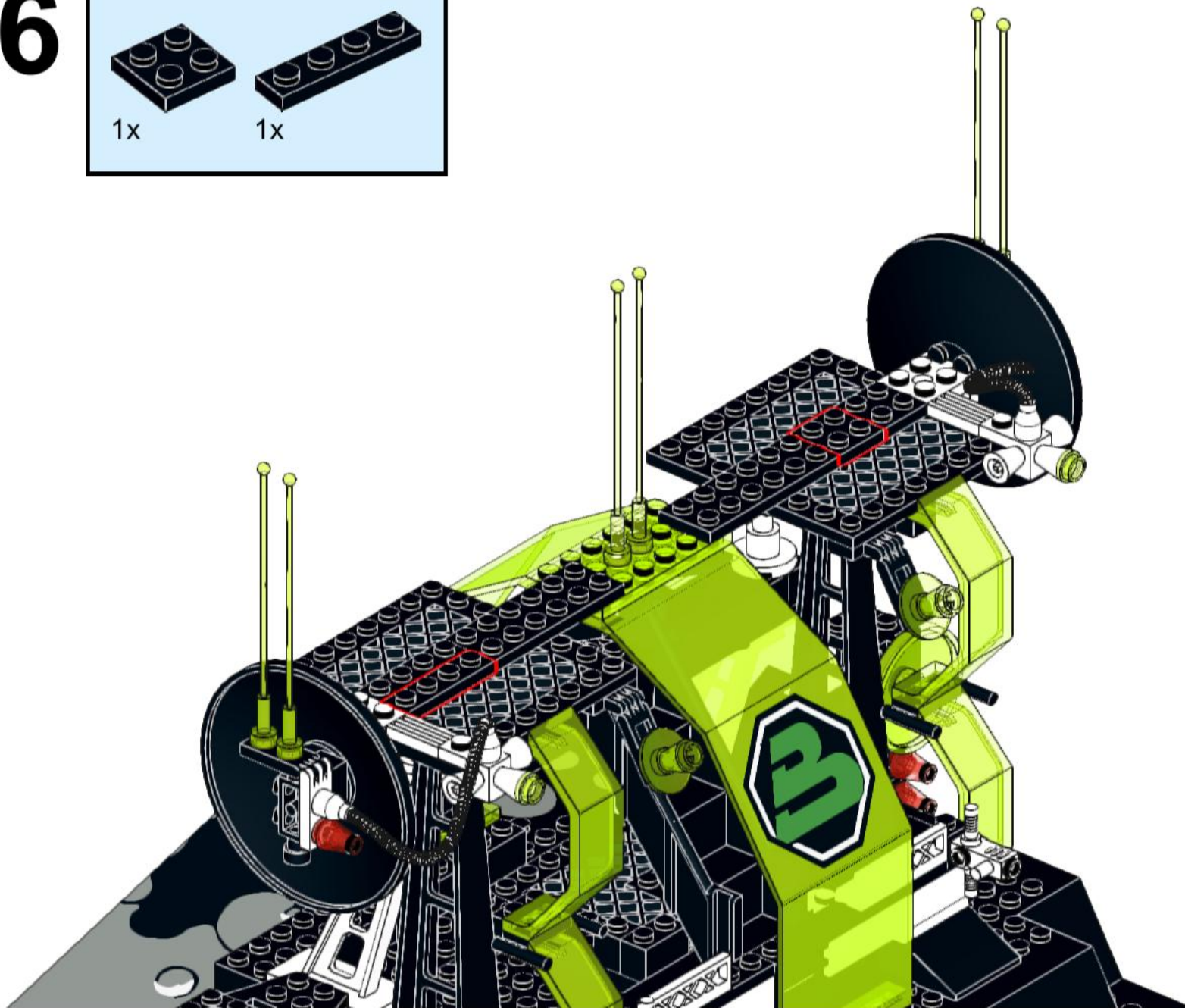
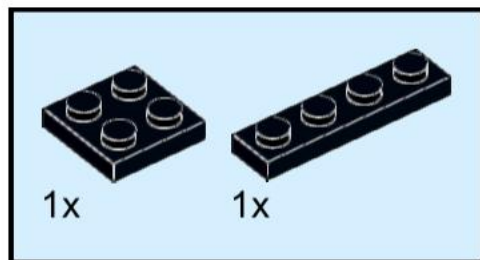

87

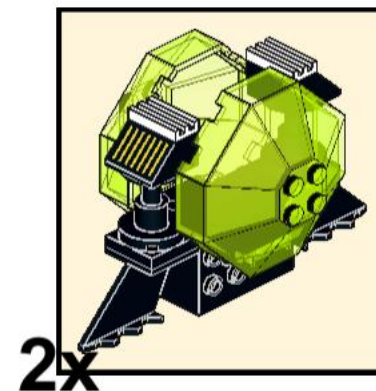
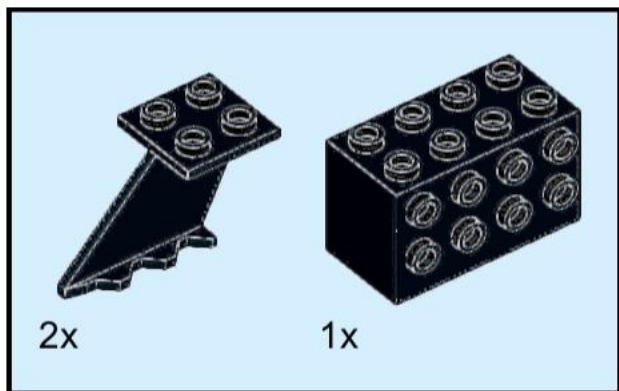

88

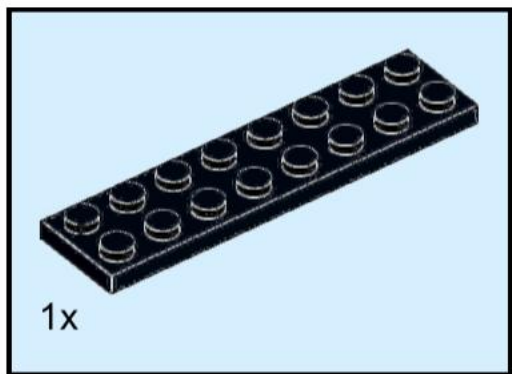

90

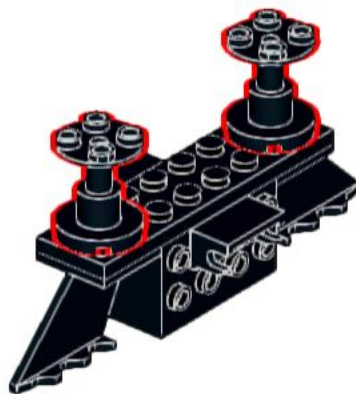
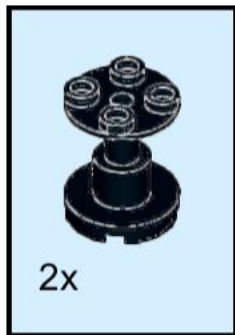

91

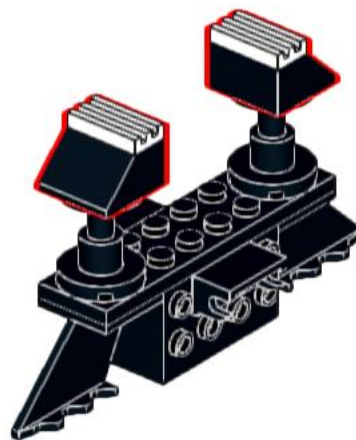
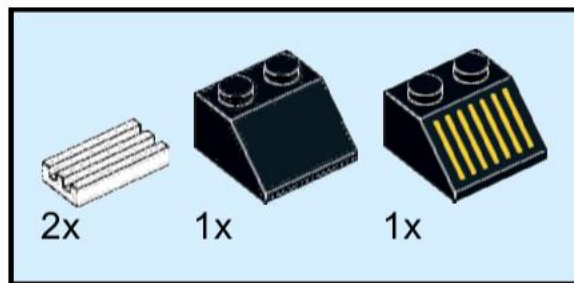

92

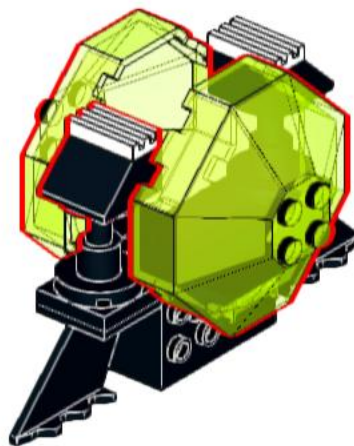
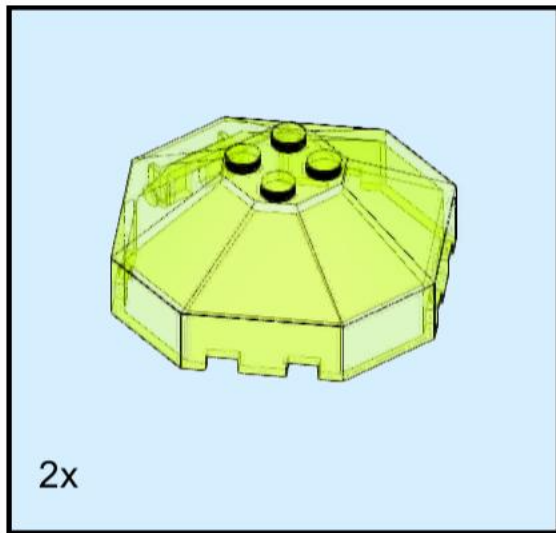

93

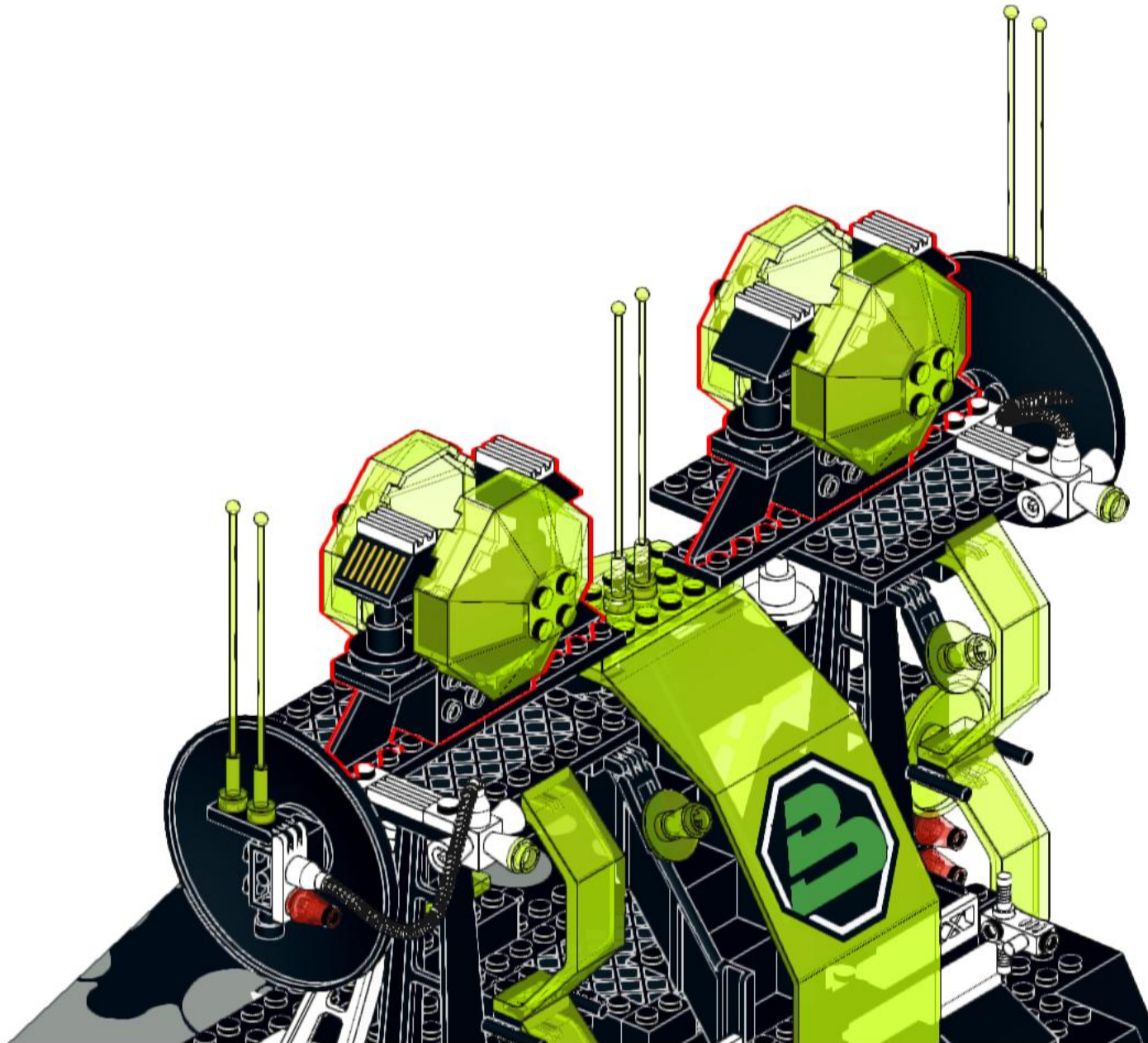

94

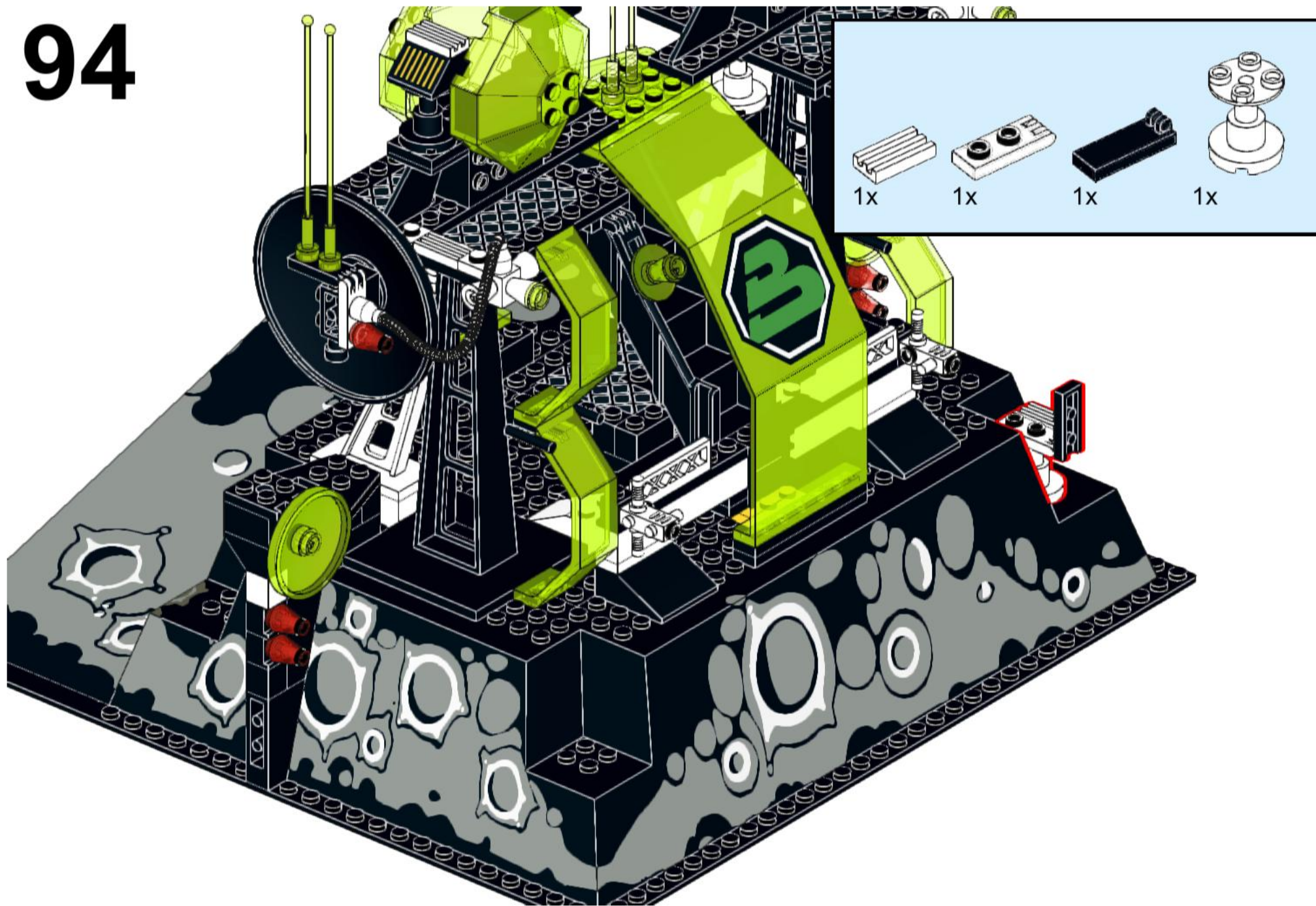

95

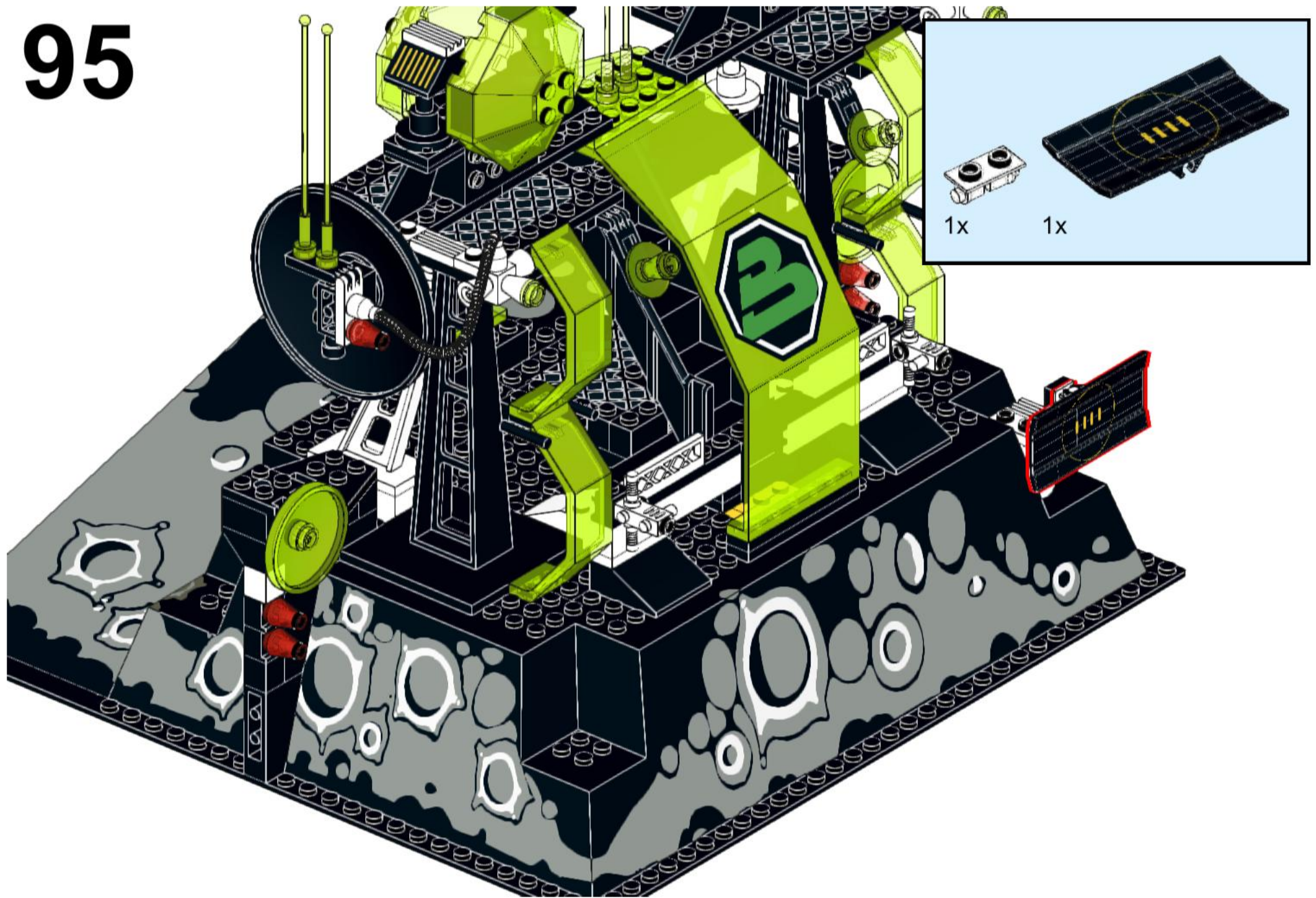

96

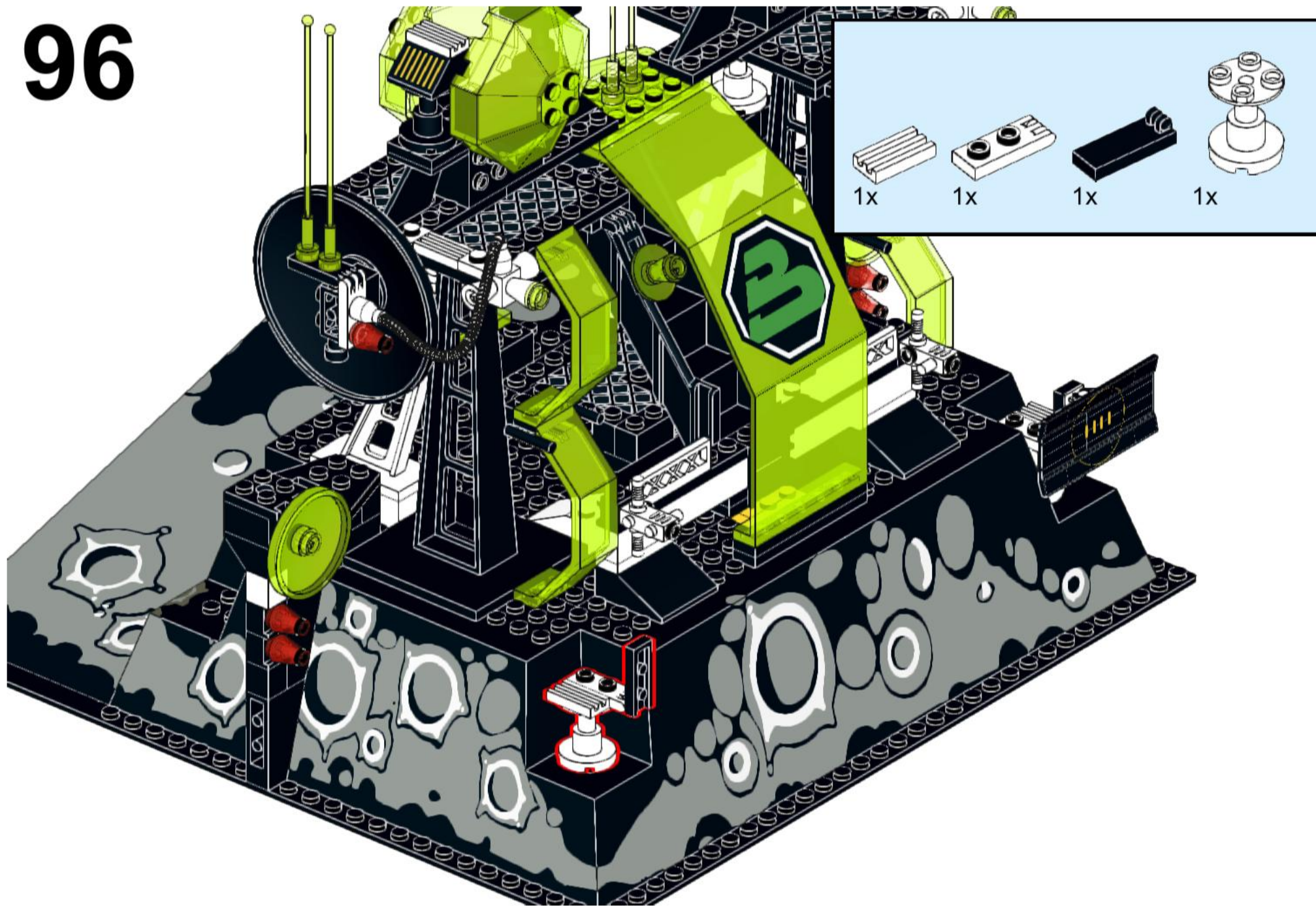

97

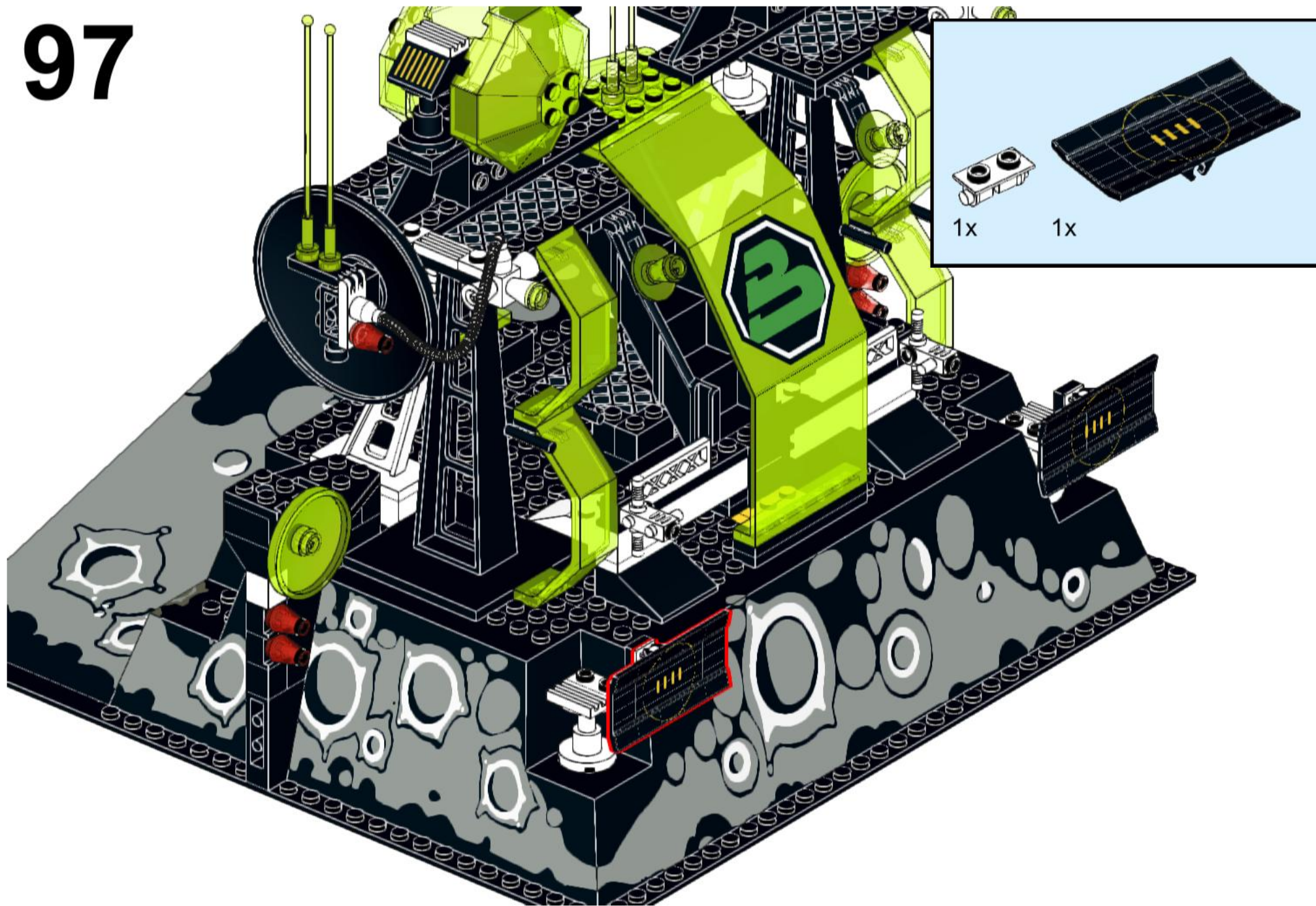

98

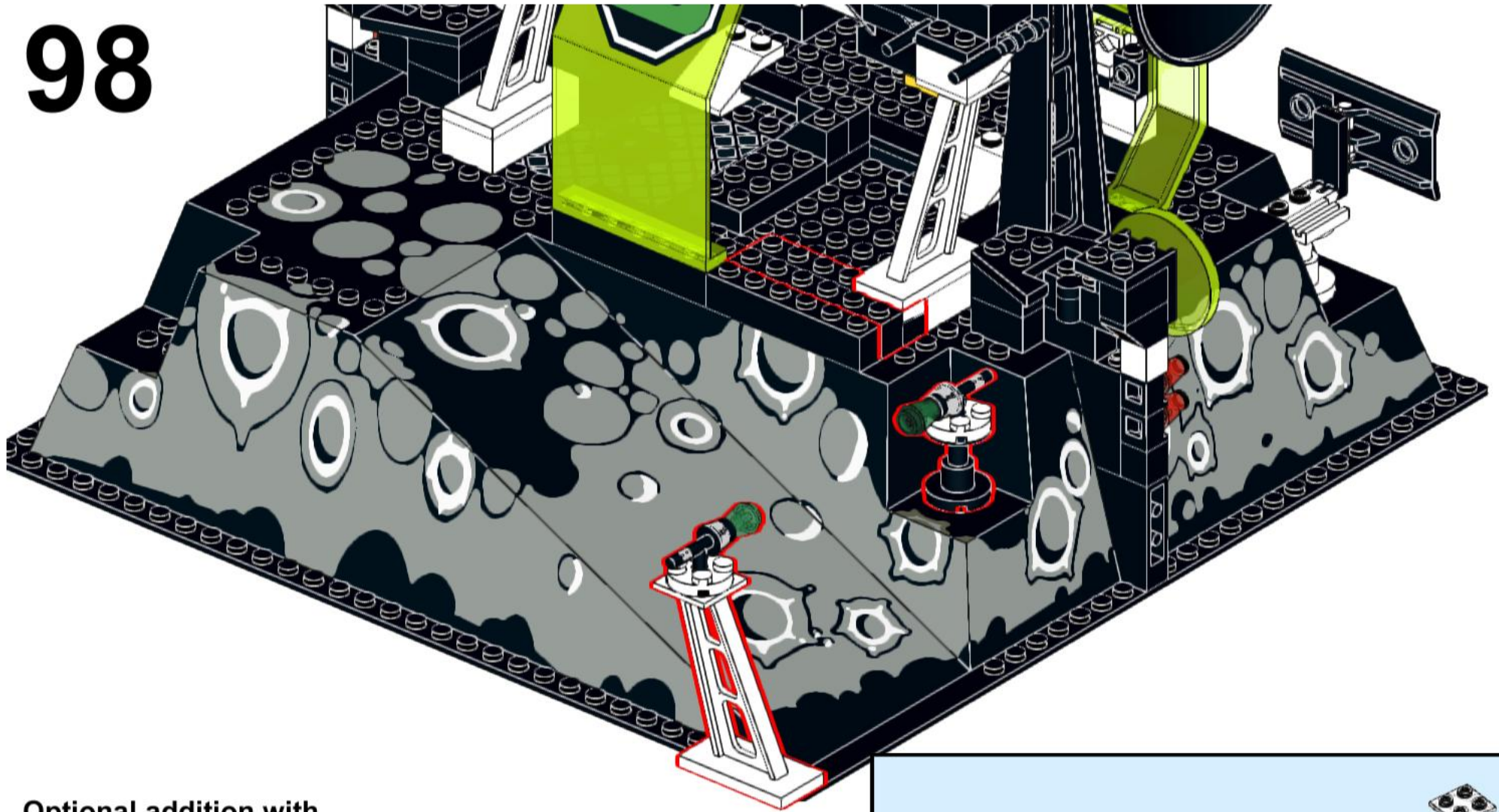

Optional addition with
spare pieces from this
set.

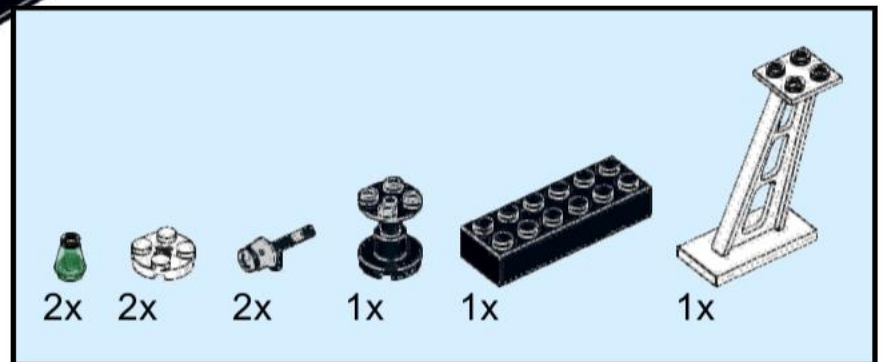

99

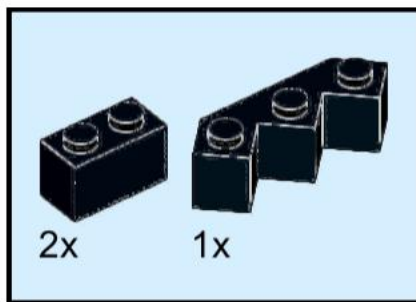

Optional addition with spare pieces from this set.

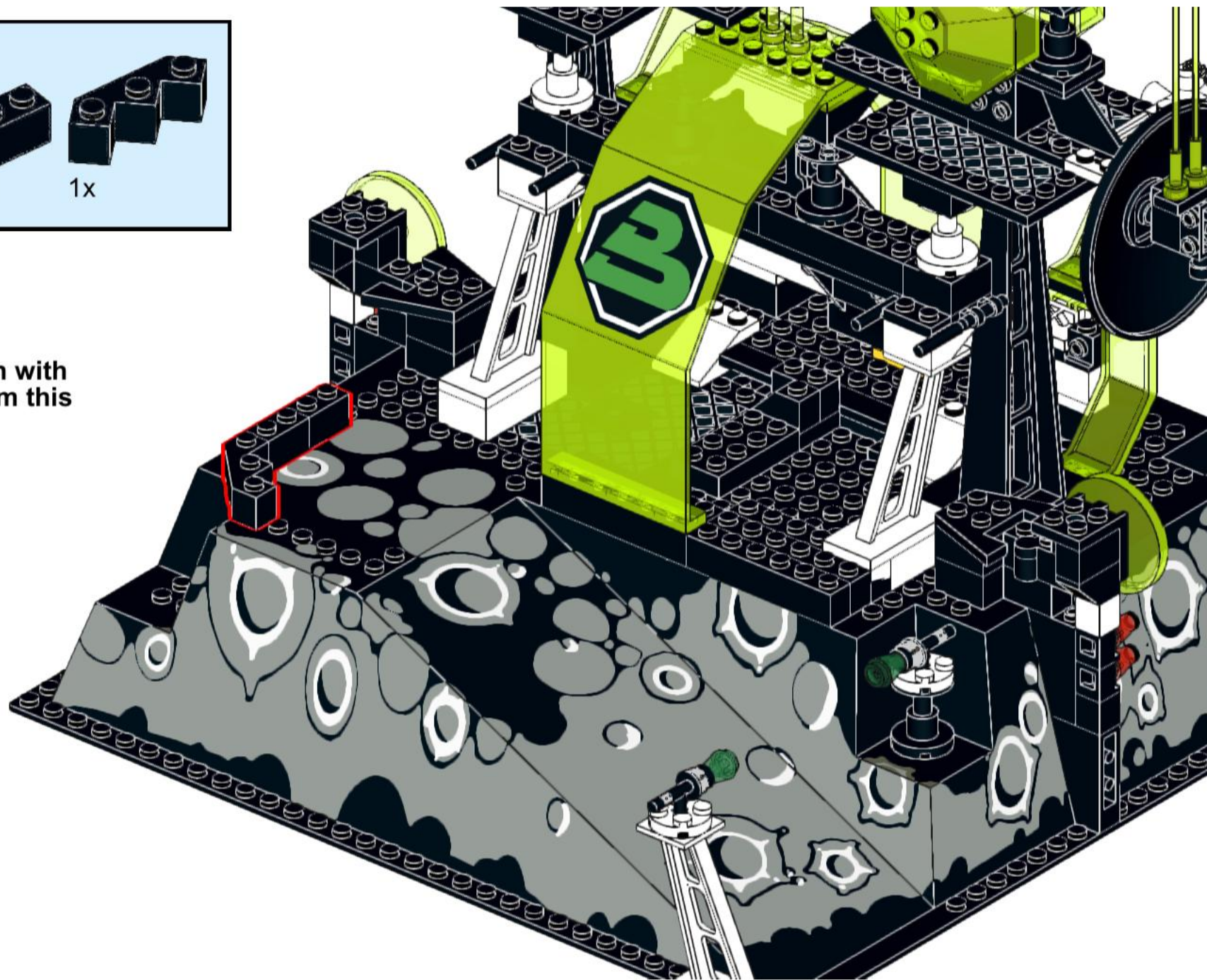

100

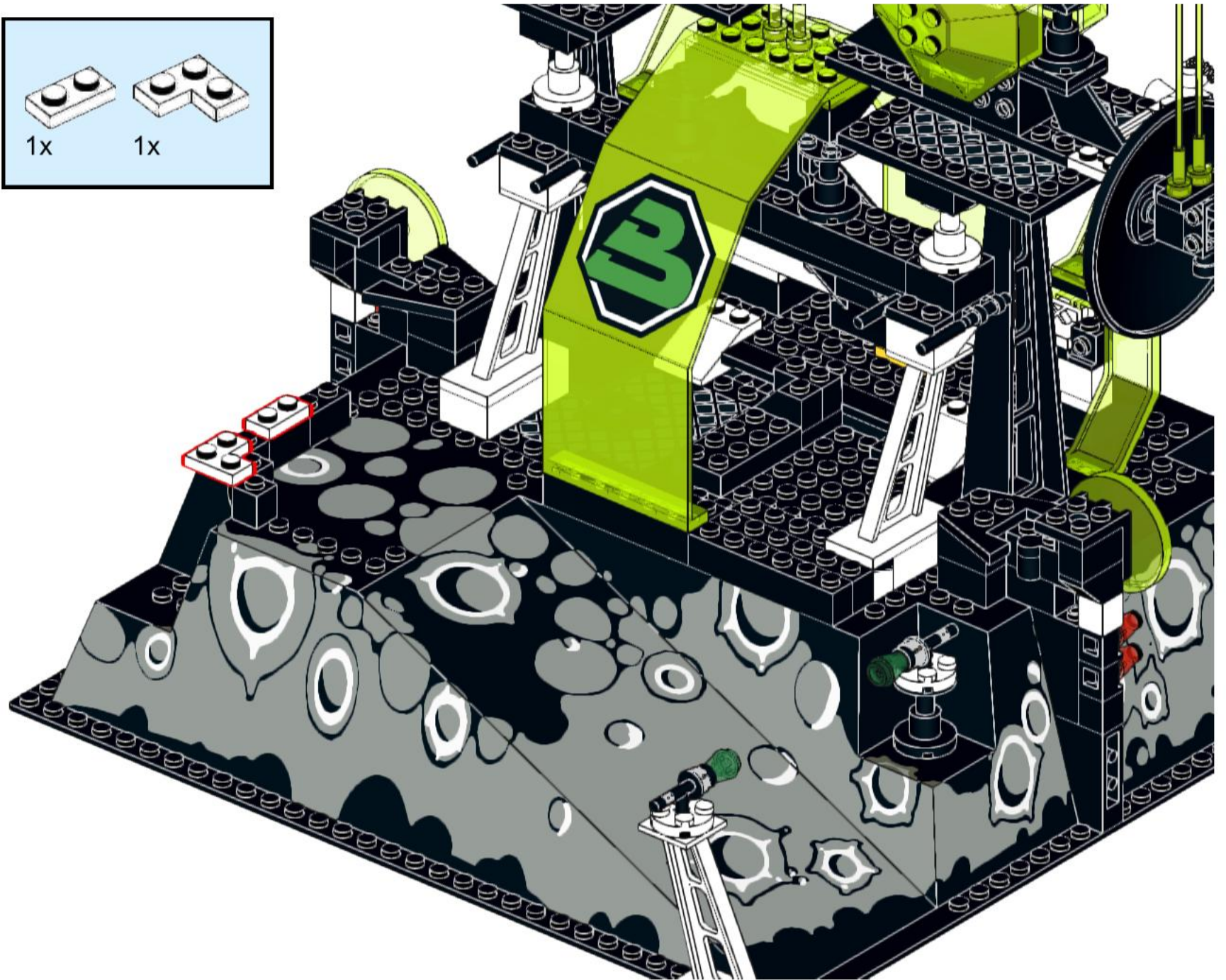
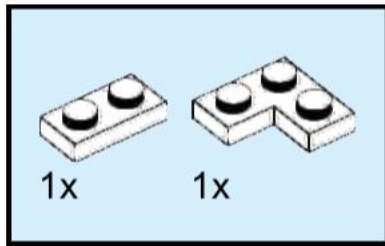

101

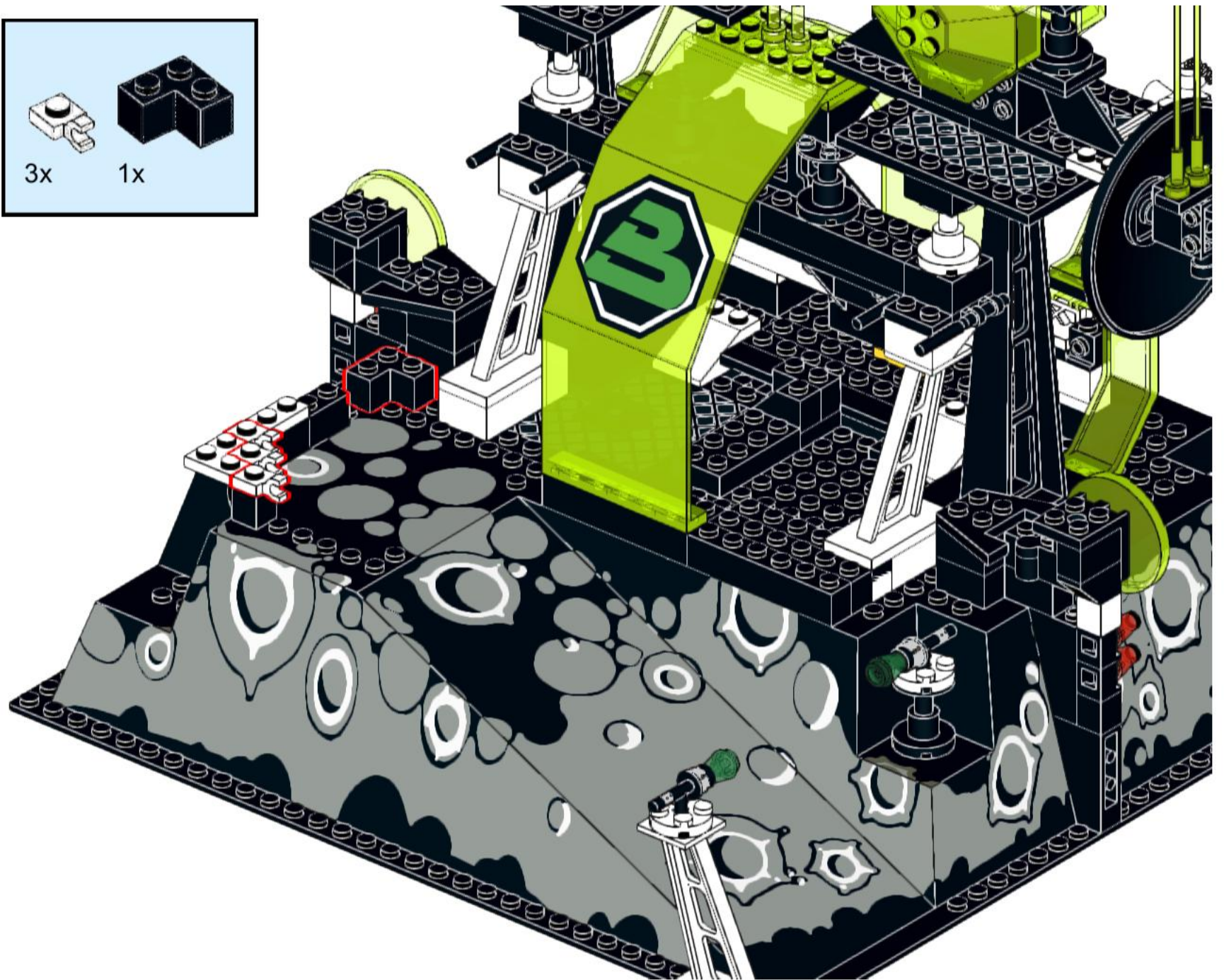
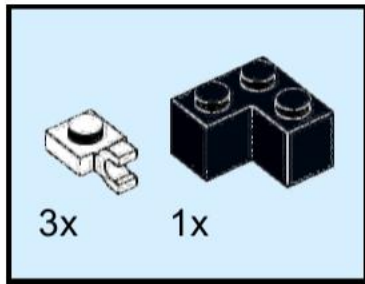

102

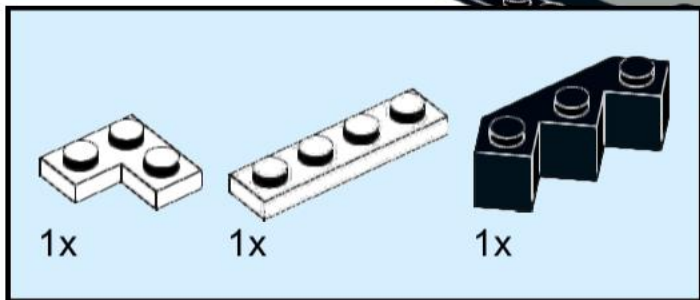
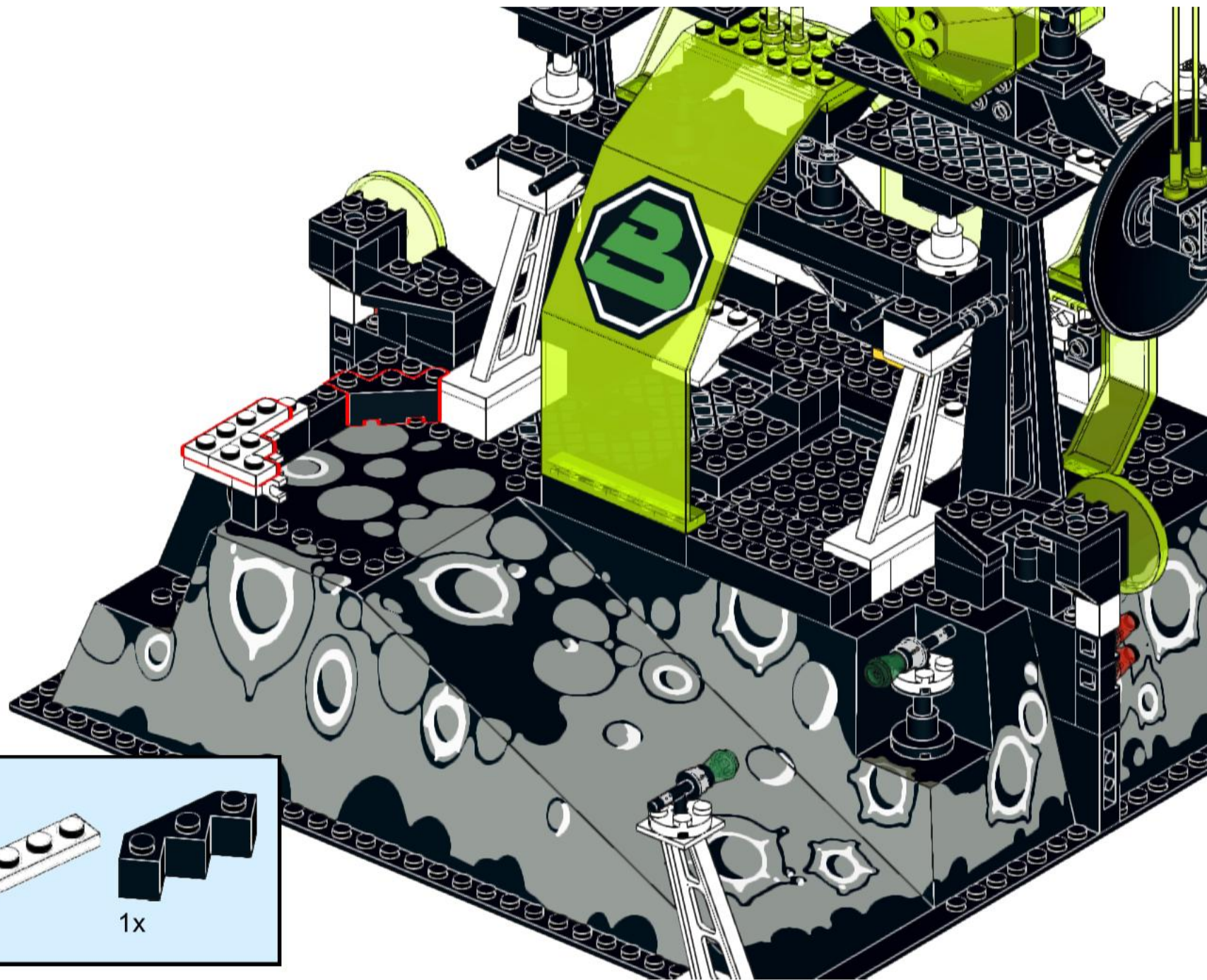

103

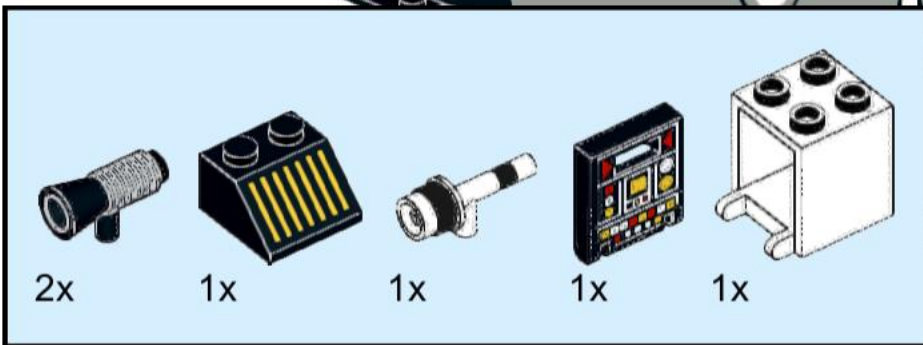
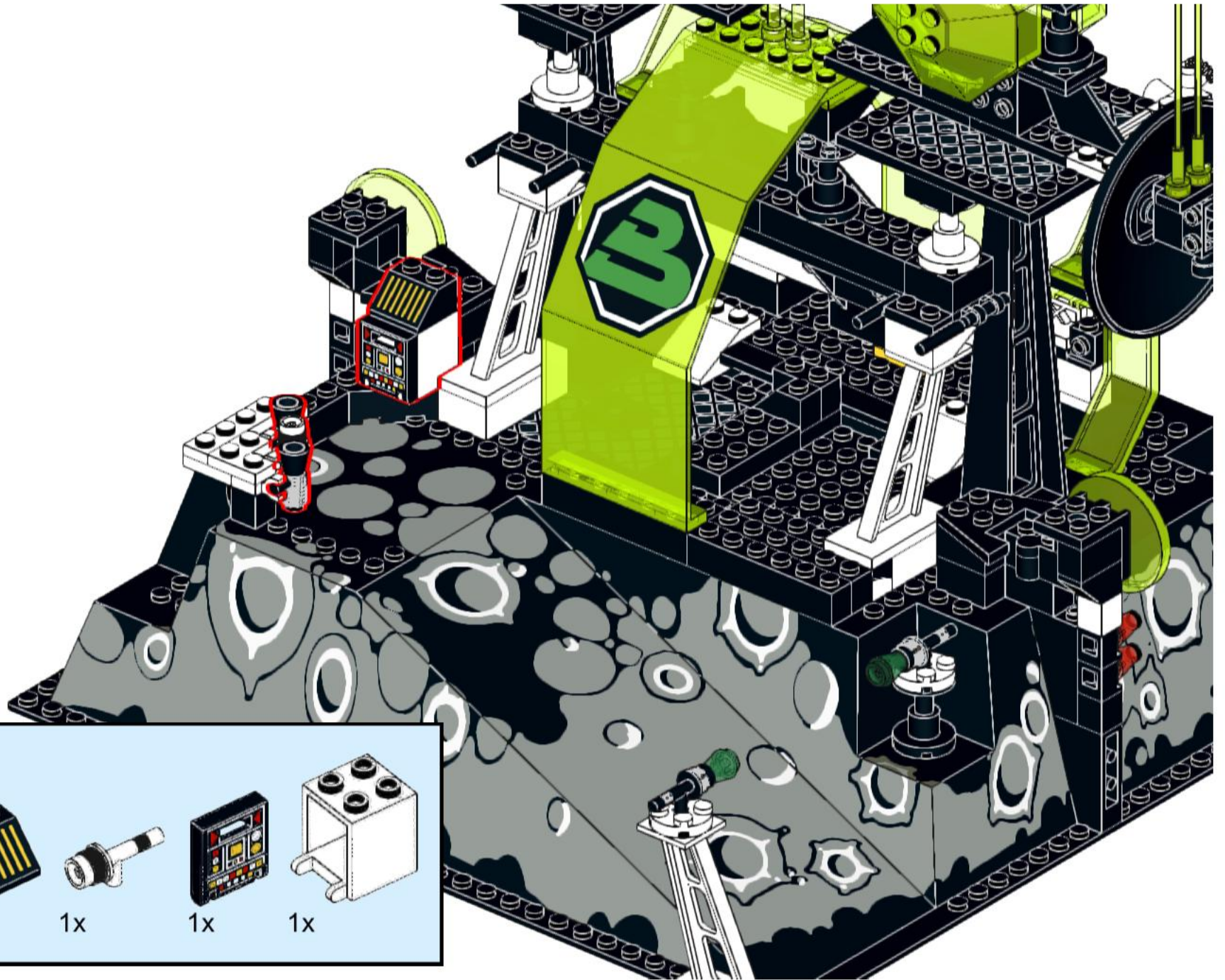

104

