

# IDEAS260 - The Village - House and Windmill

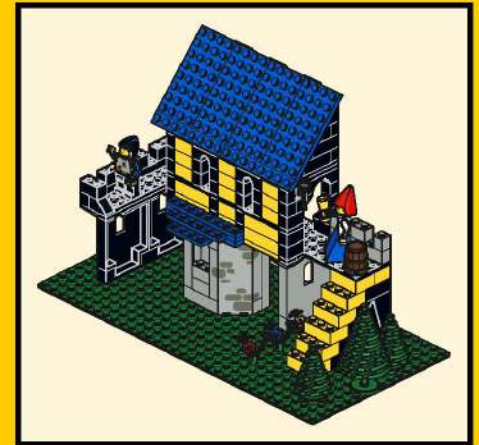

1

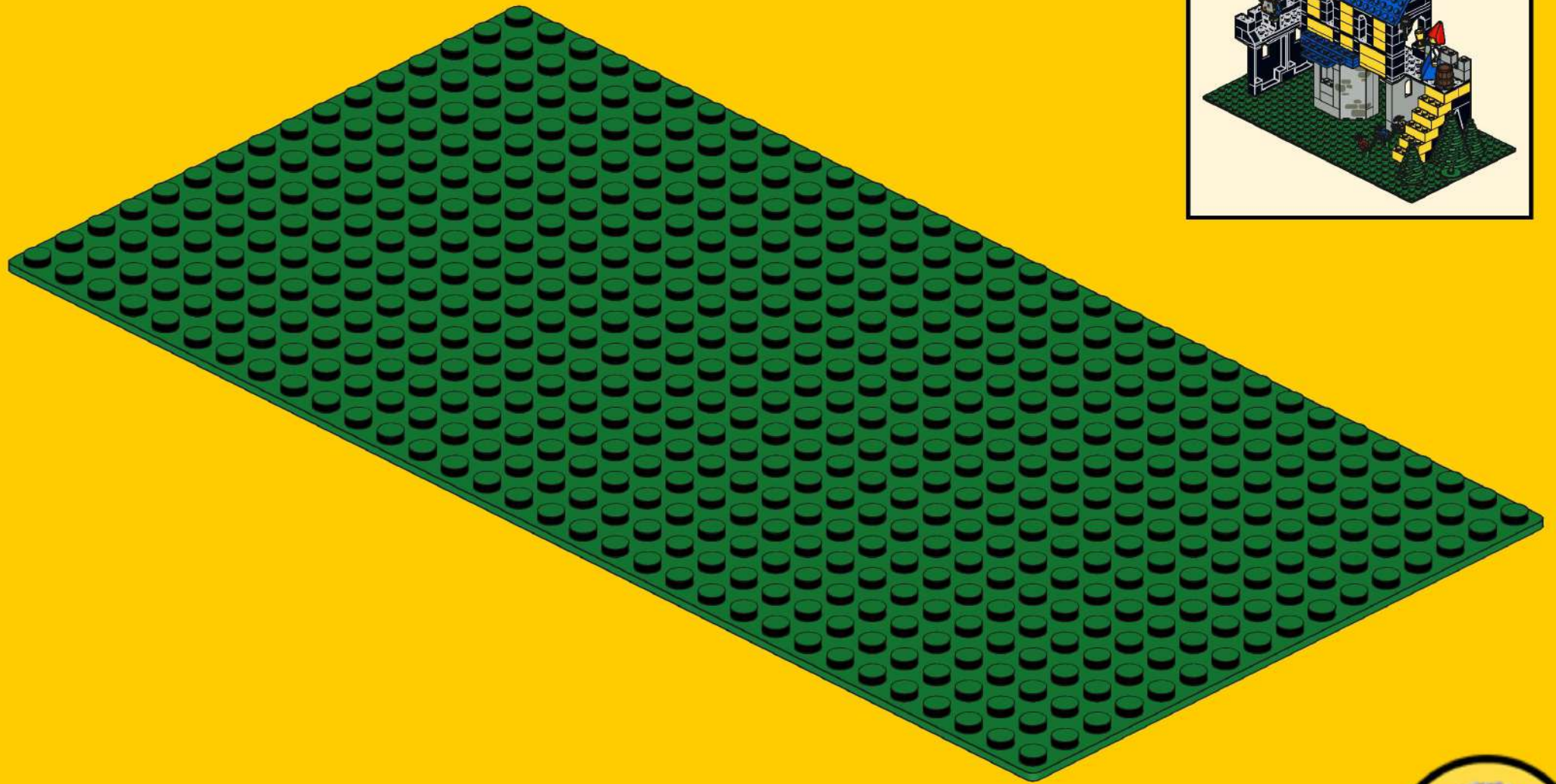

# 2

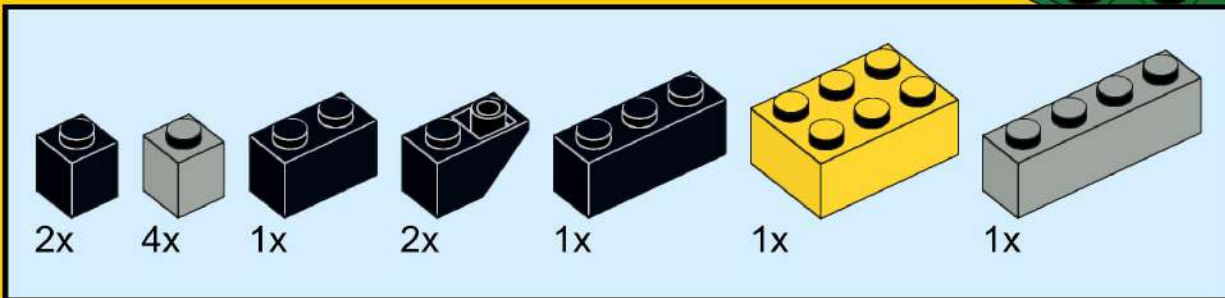
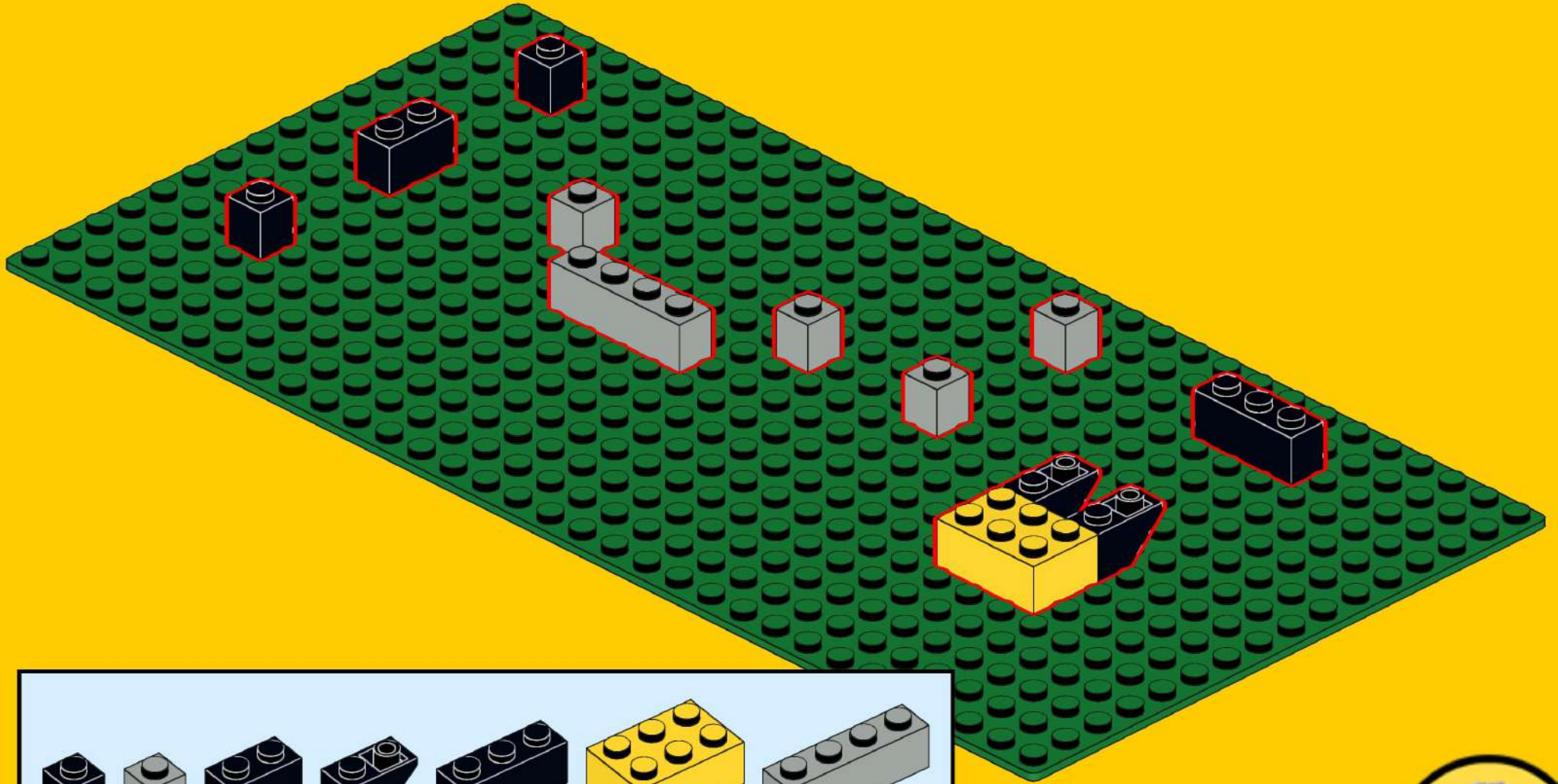

3

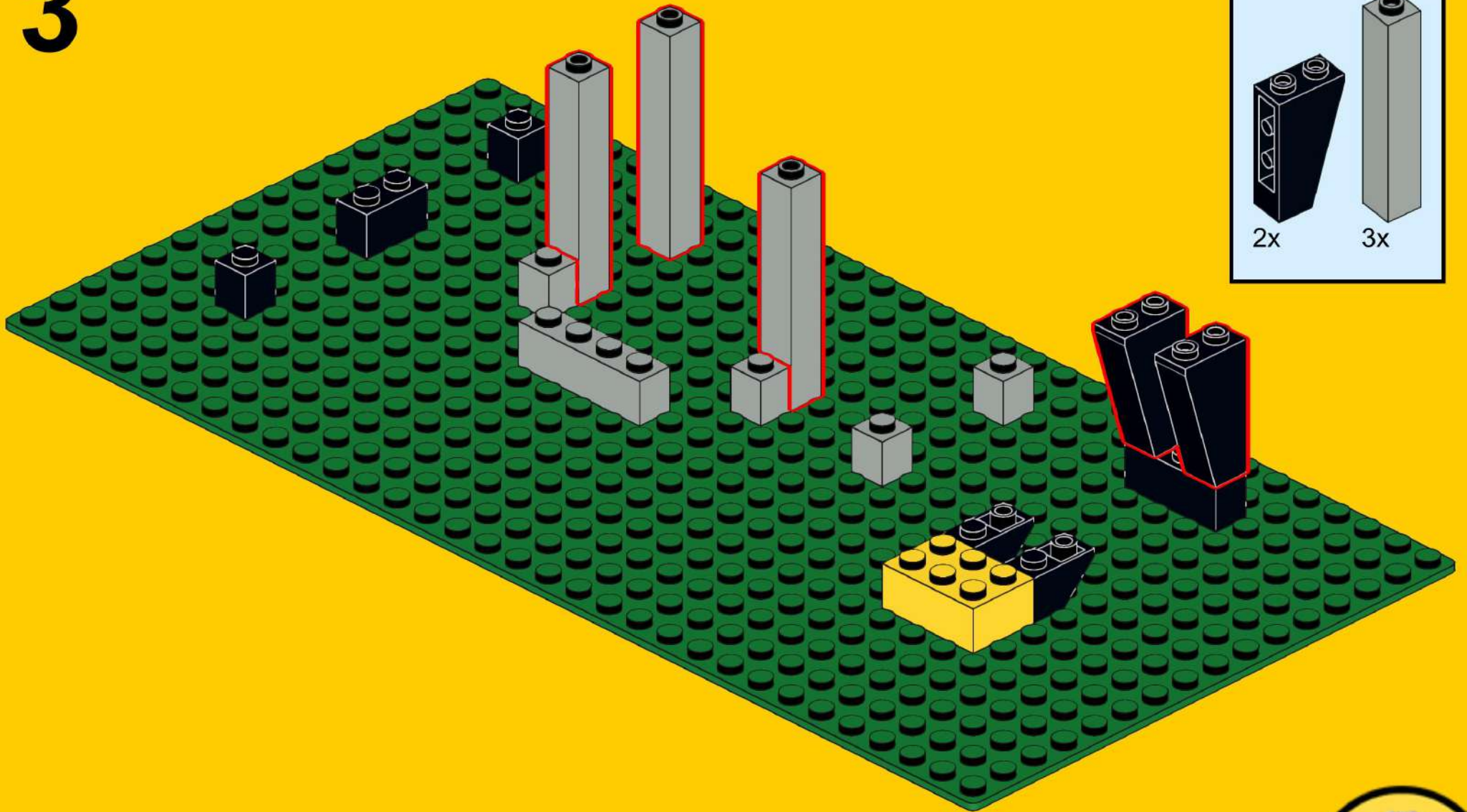

4

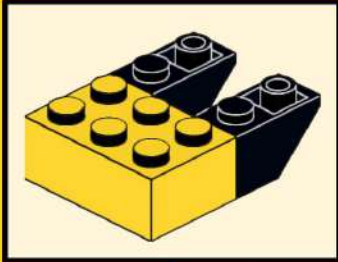
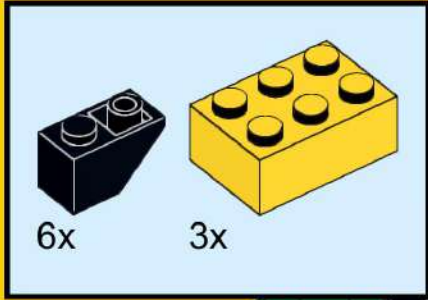

3x

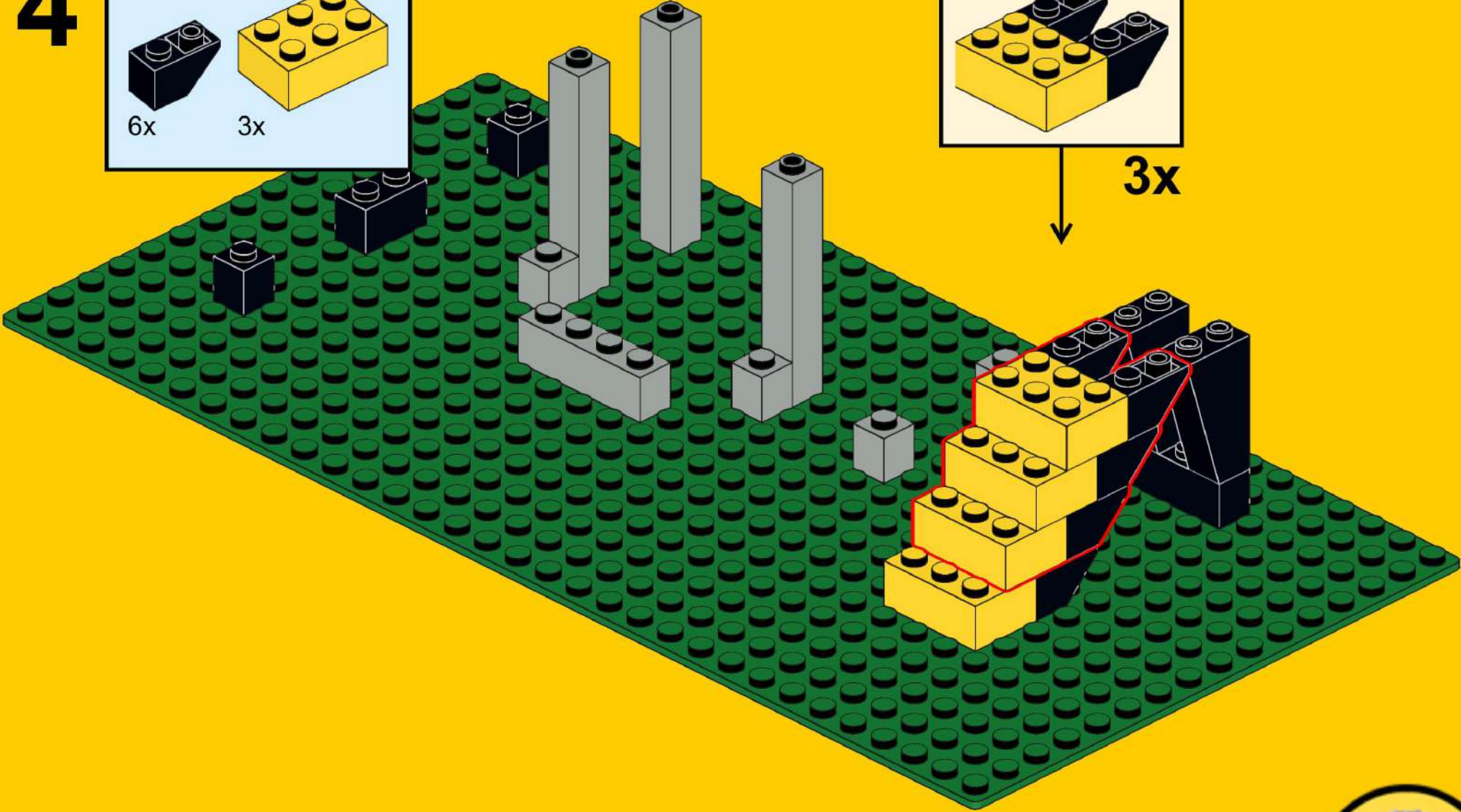

# 5

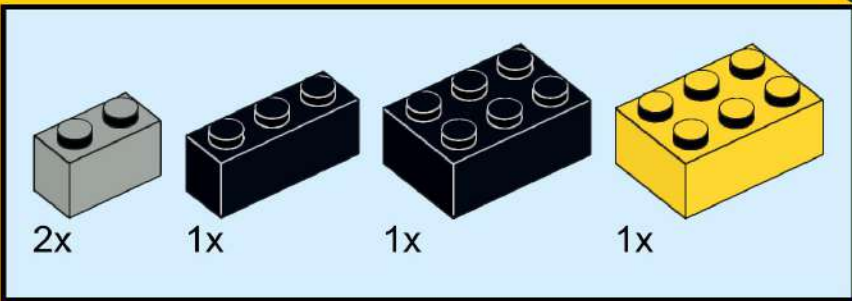
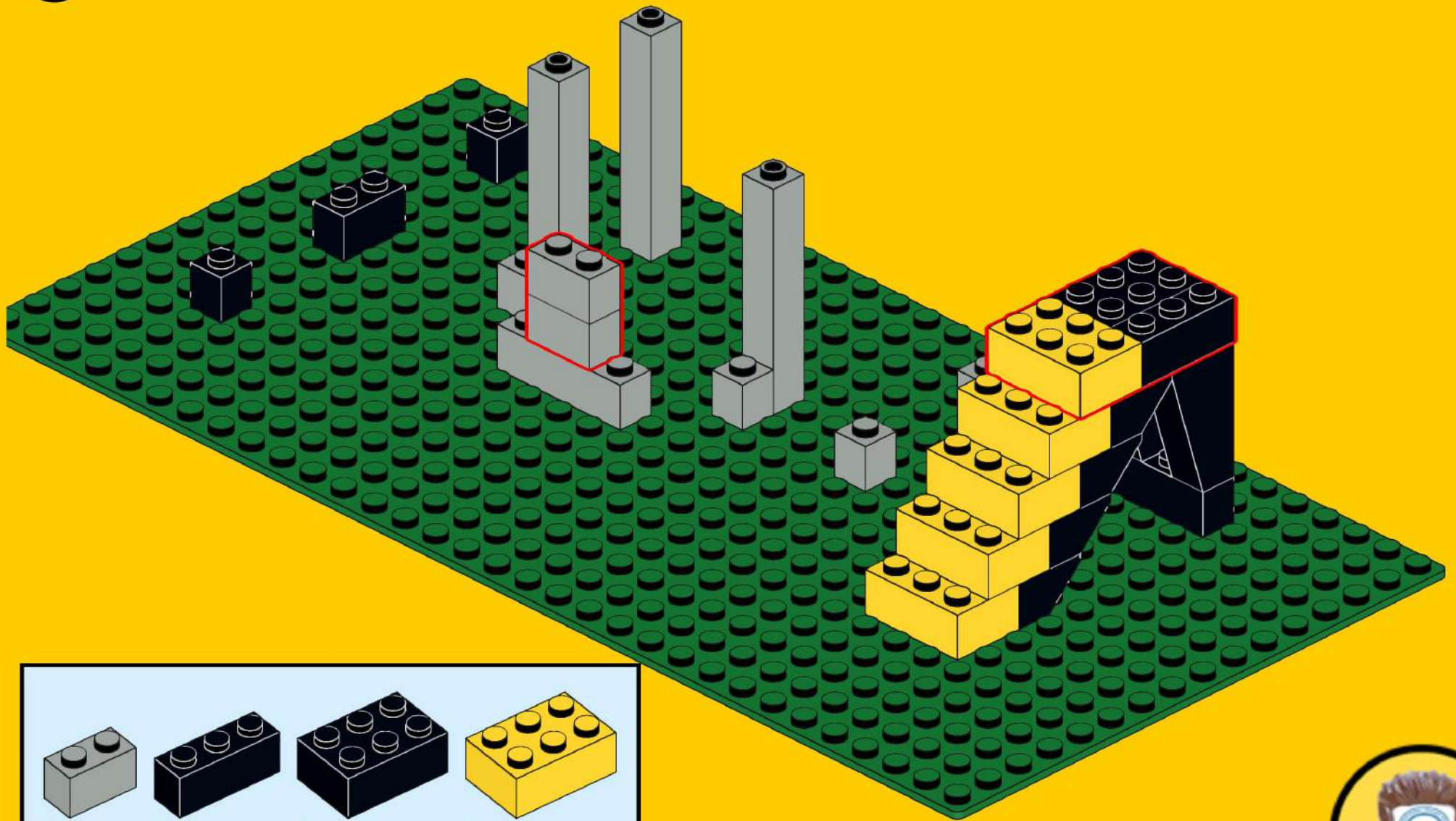

6

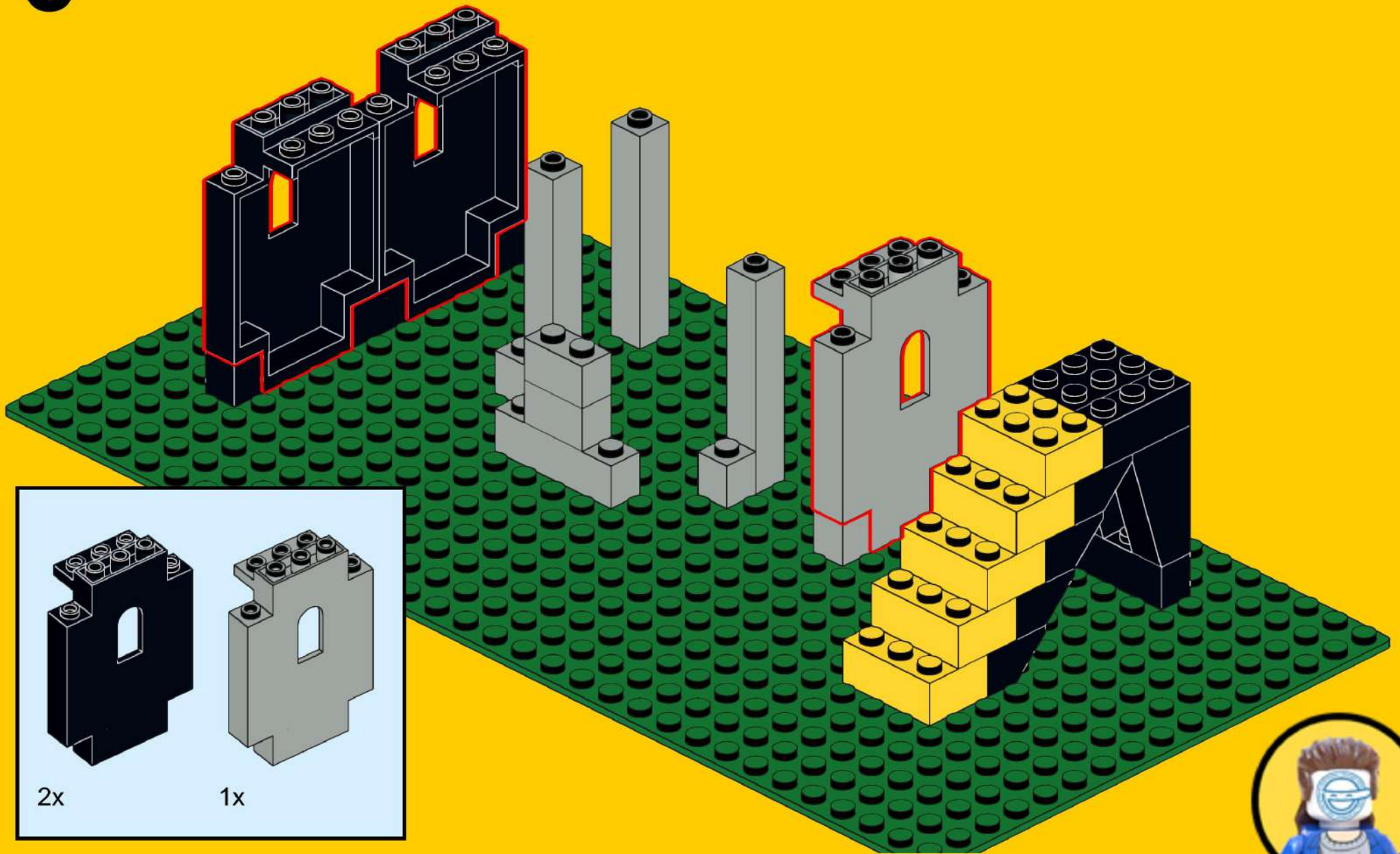

7

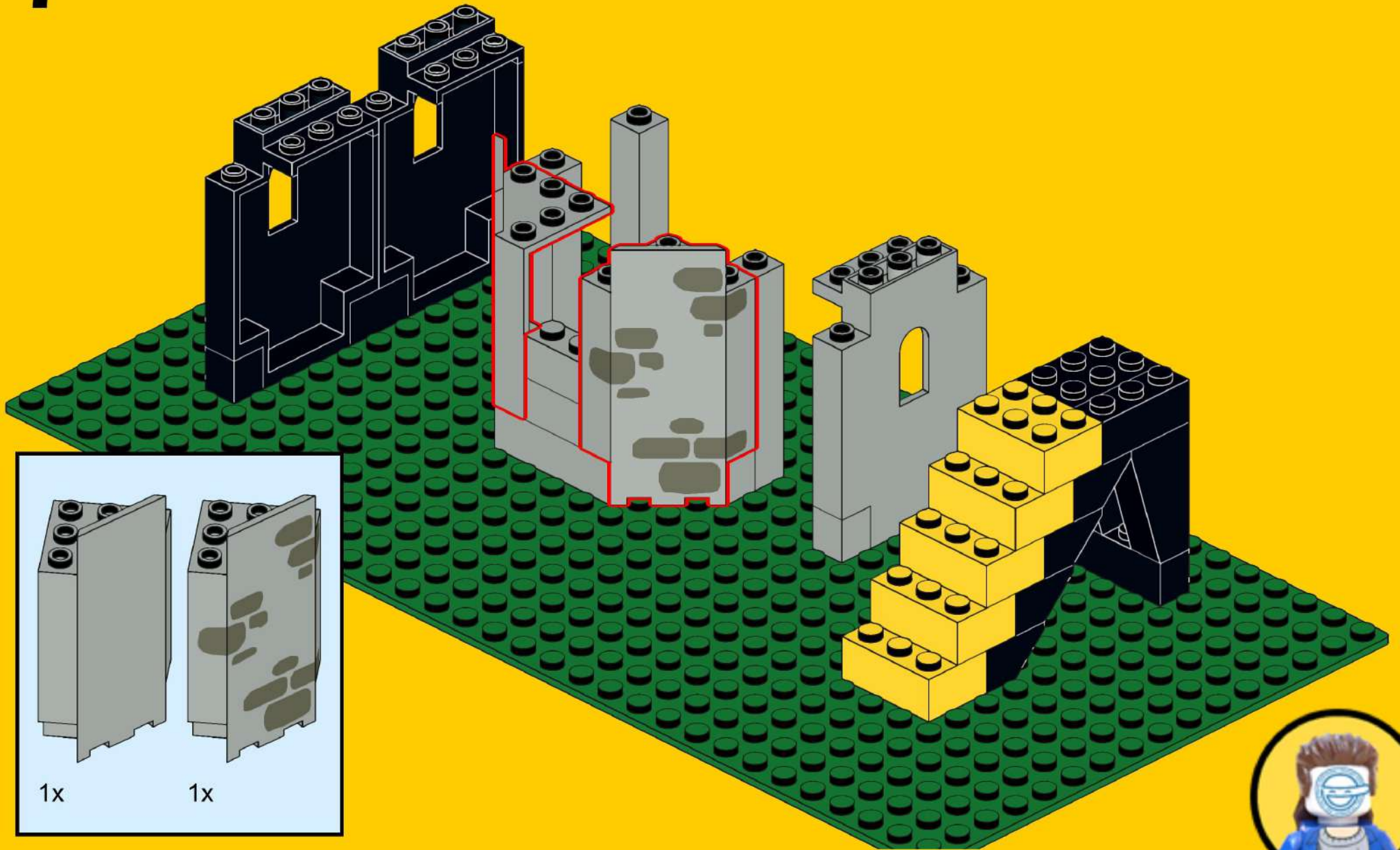



8

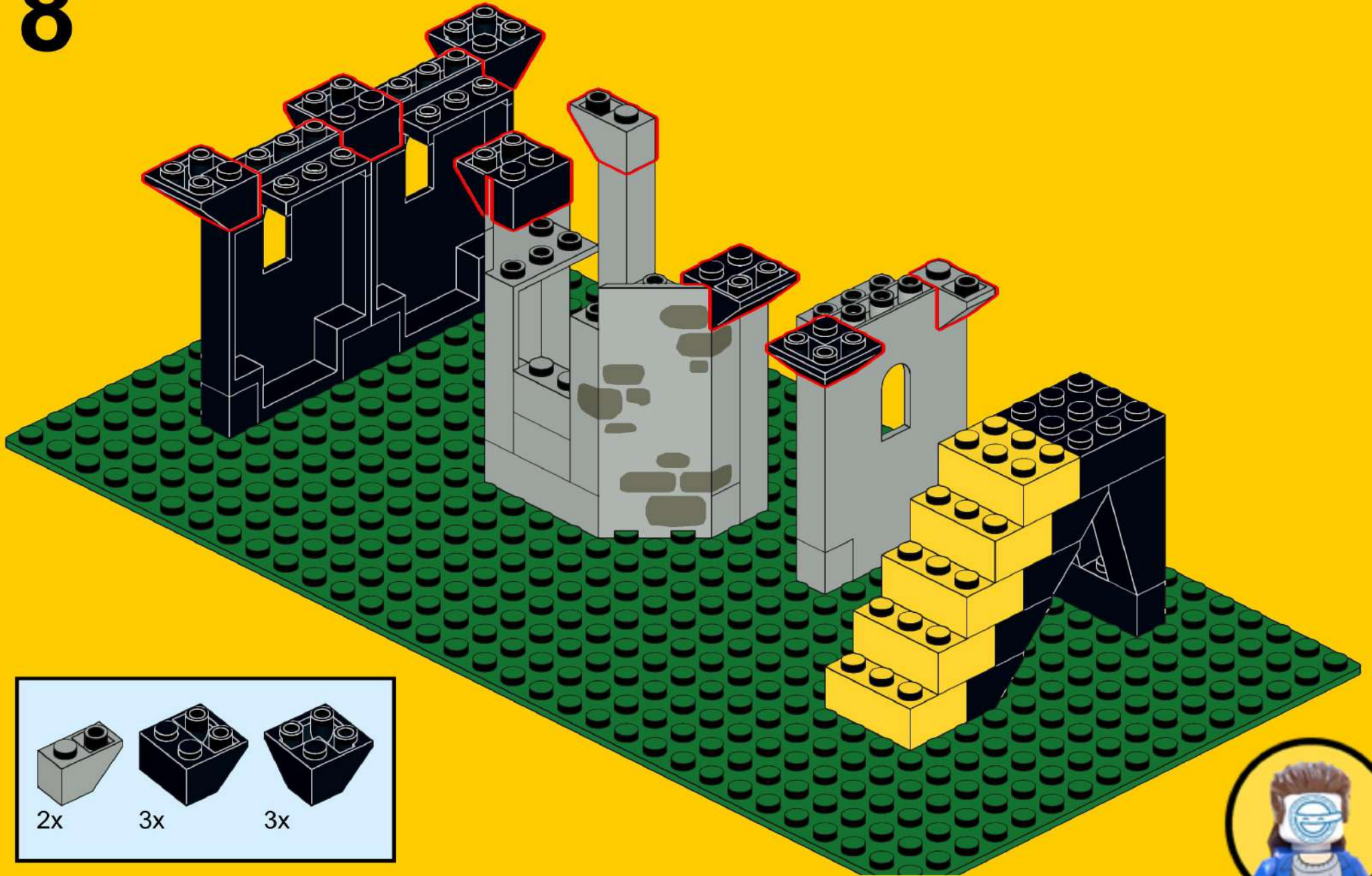

9

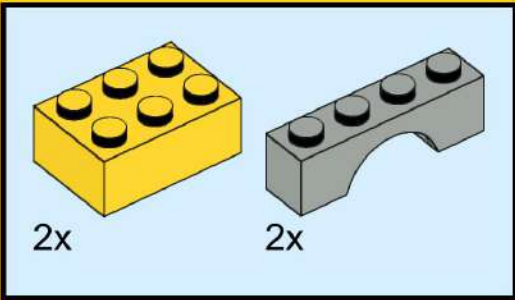
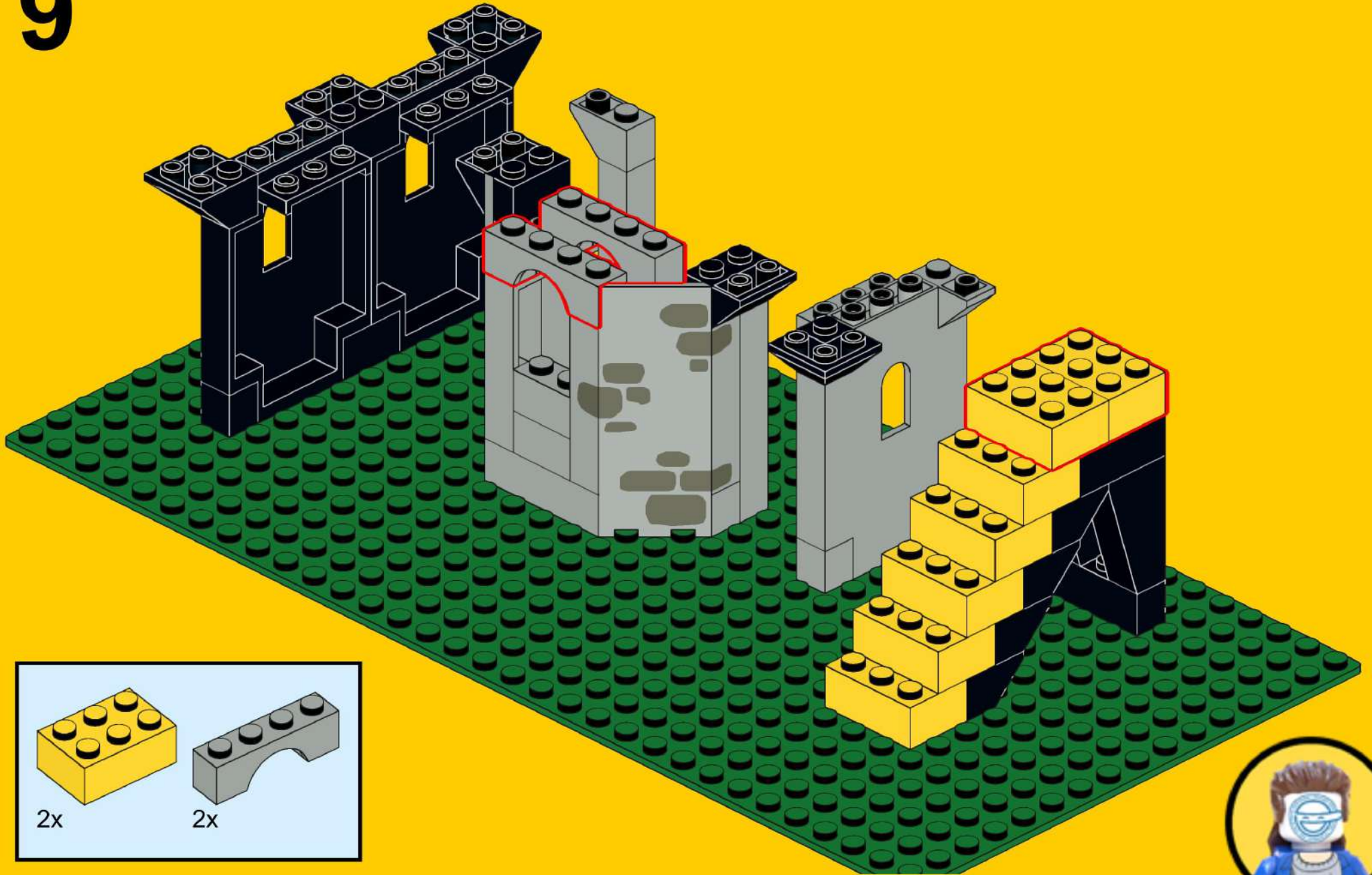

# 10

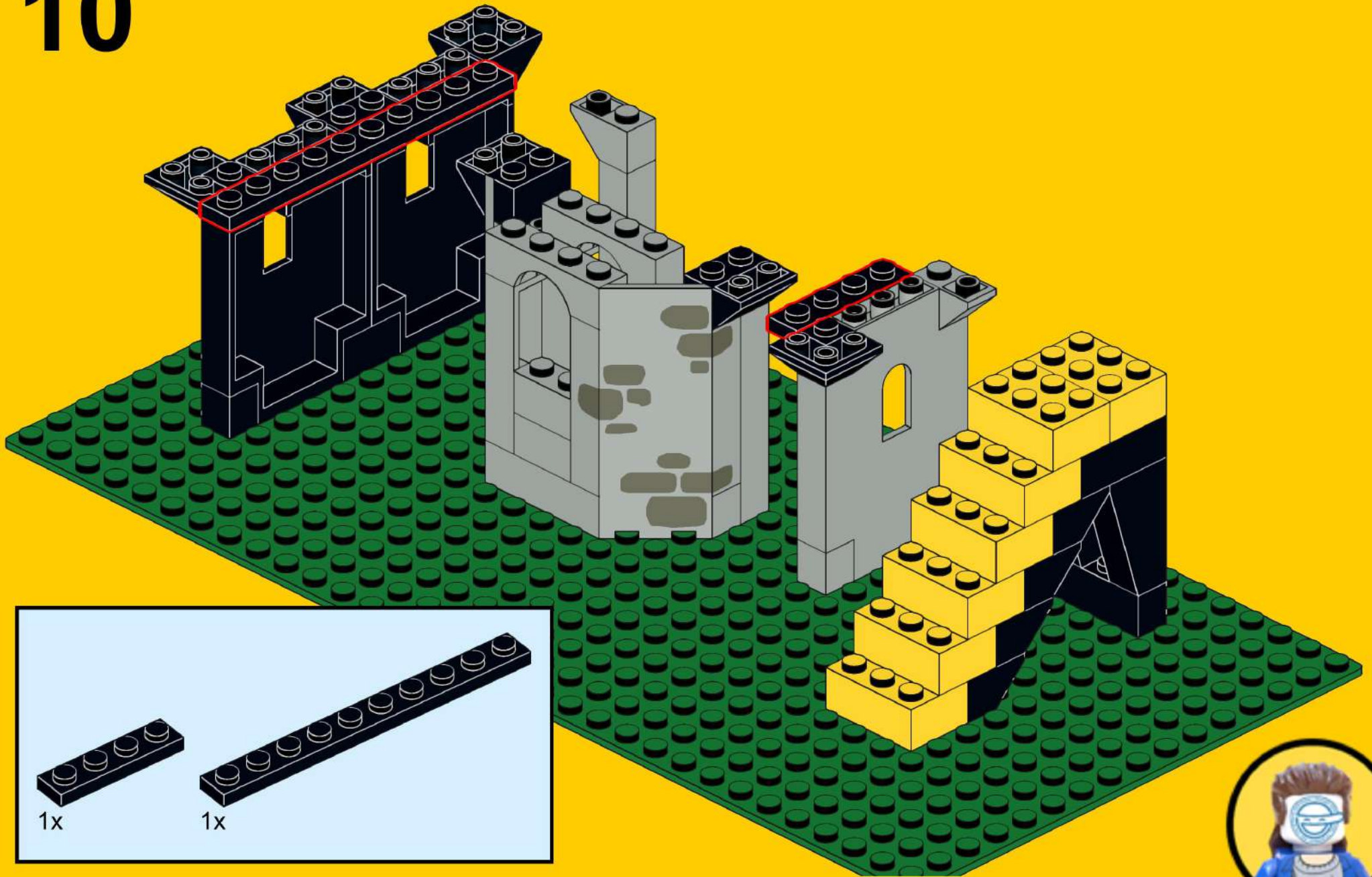

# 11

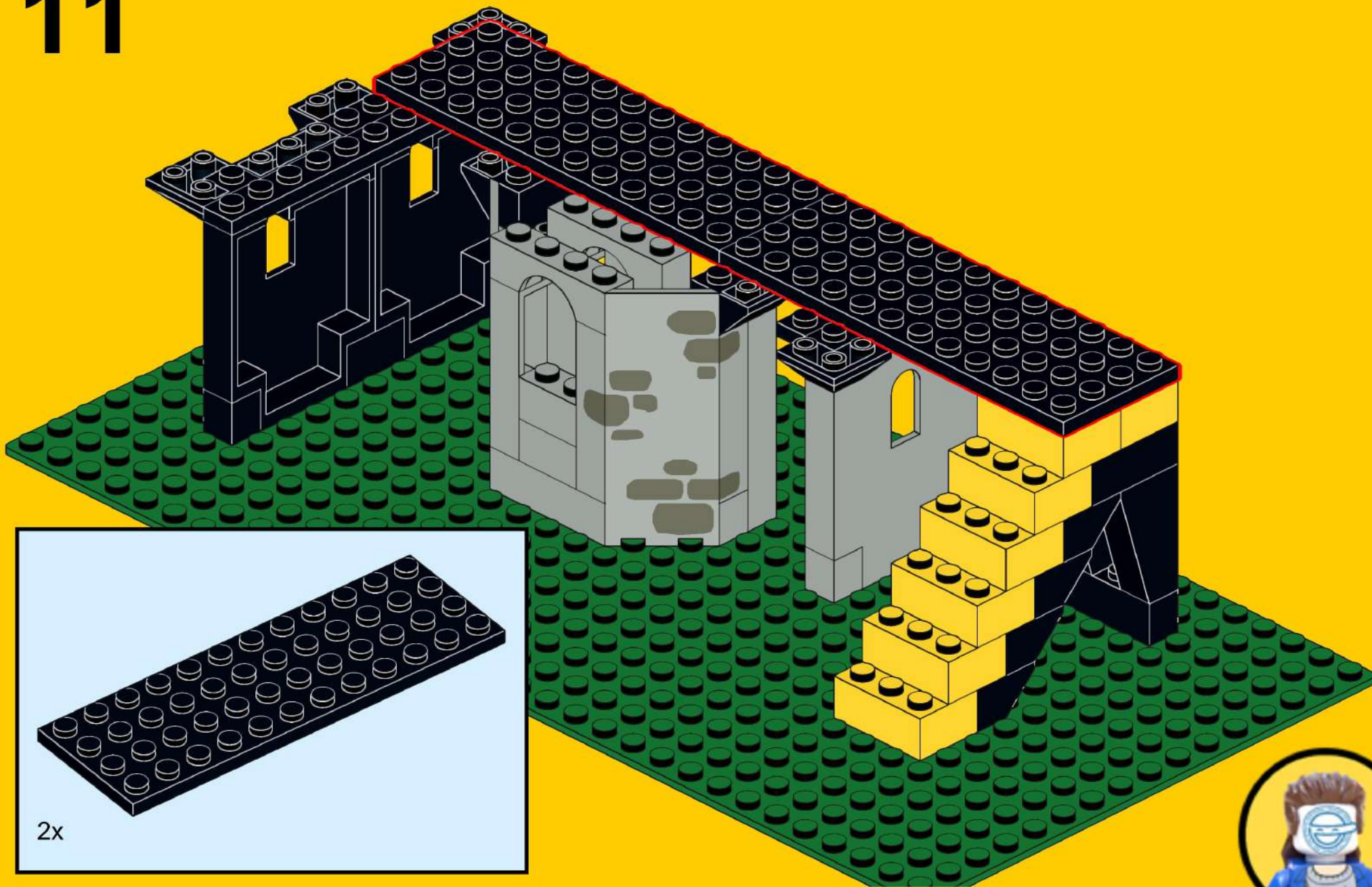

# 12

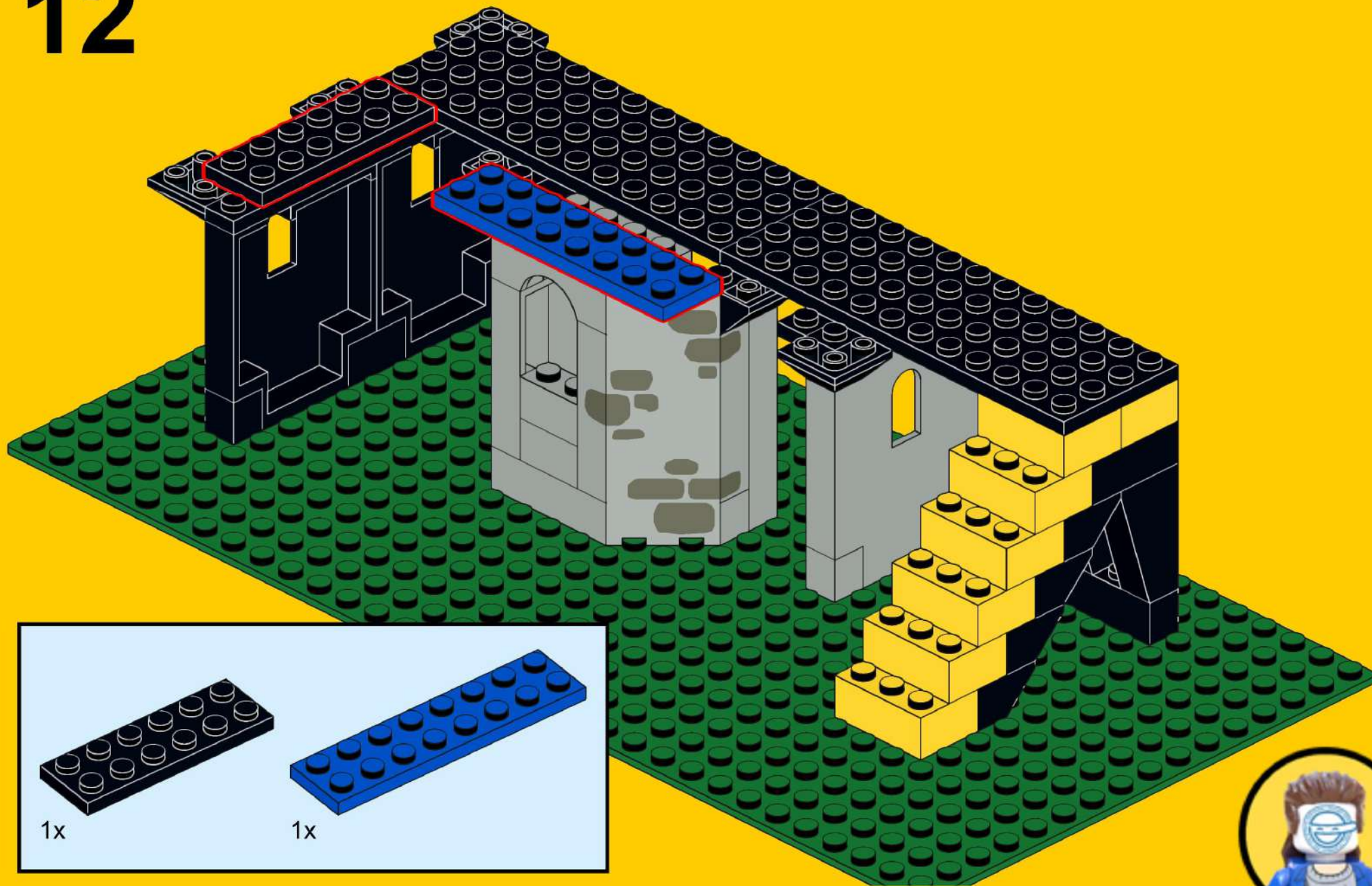

# 13

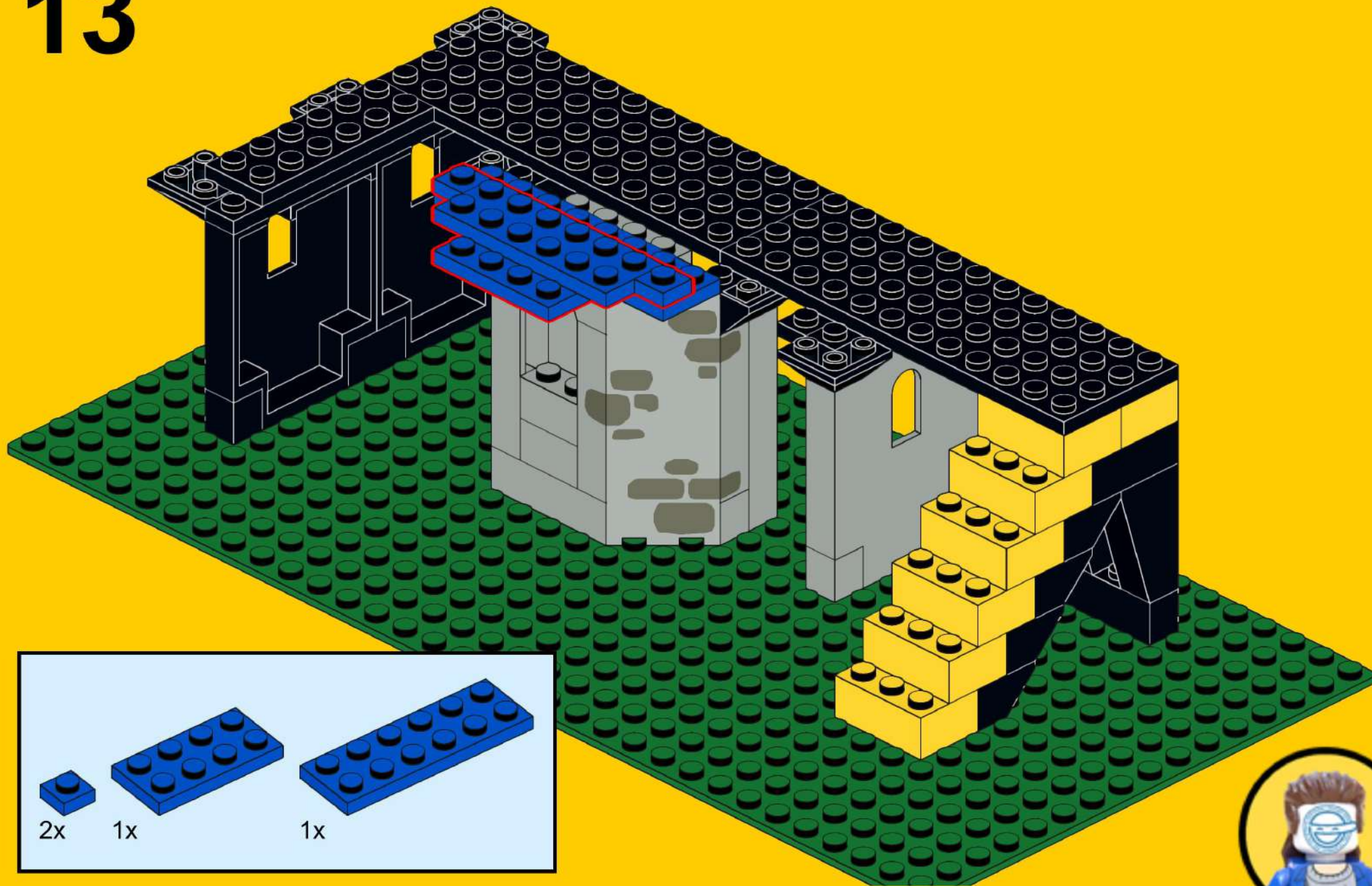

# 14

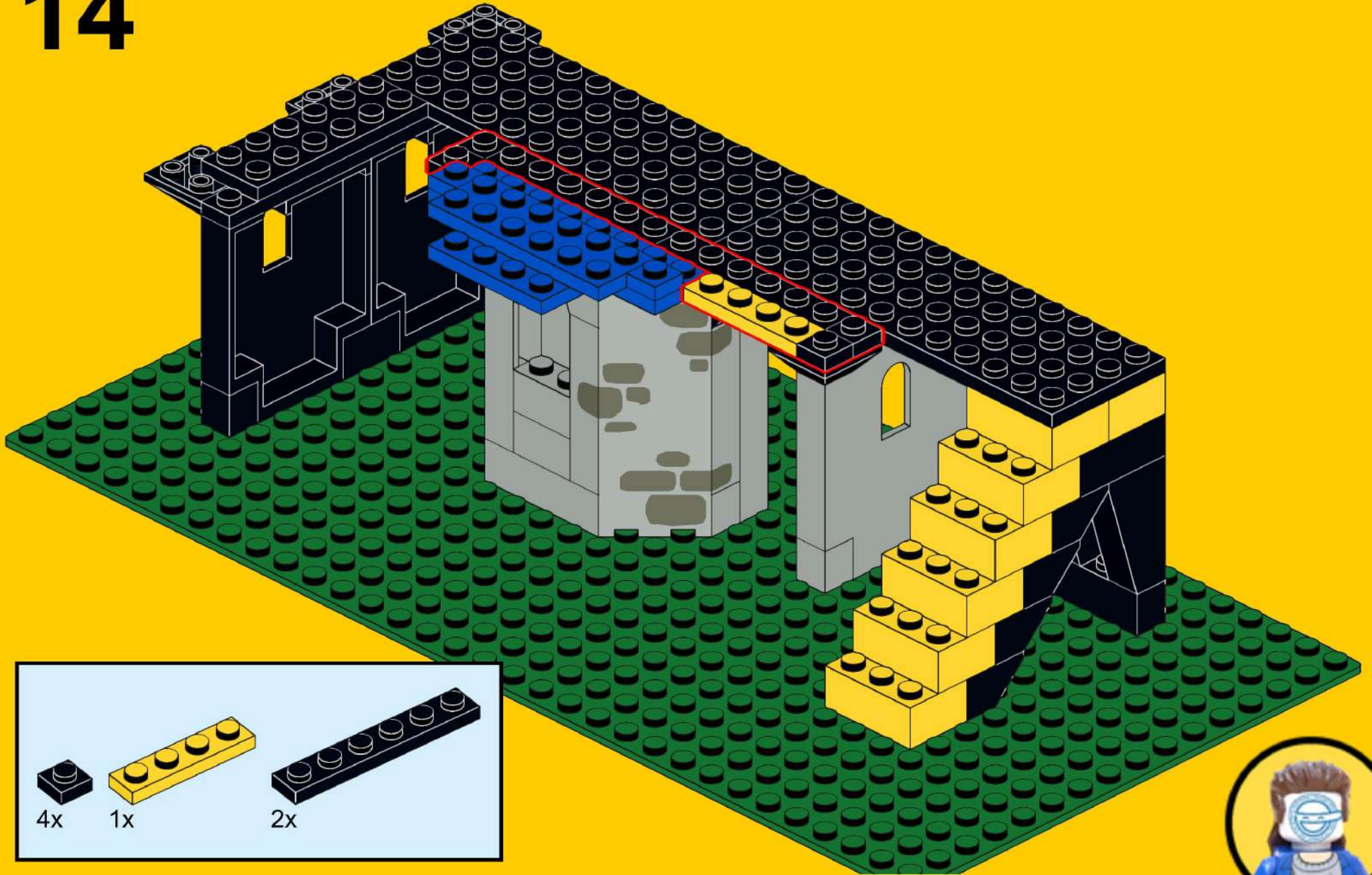

# 15

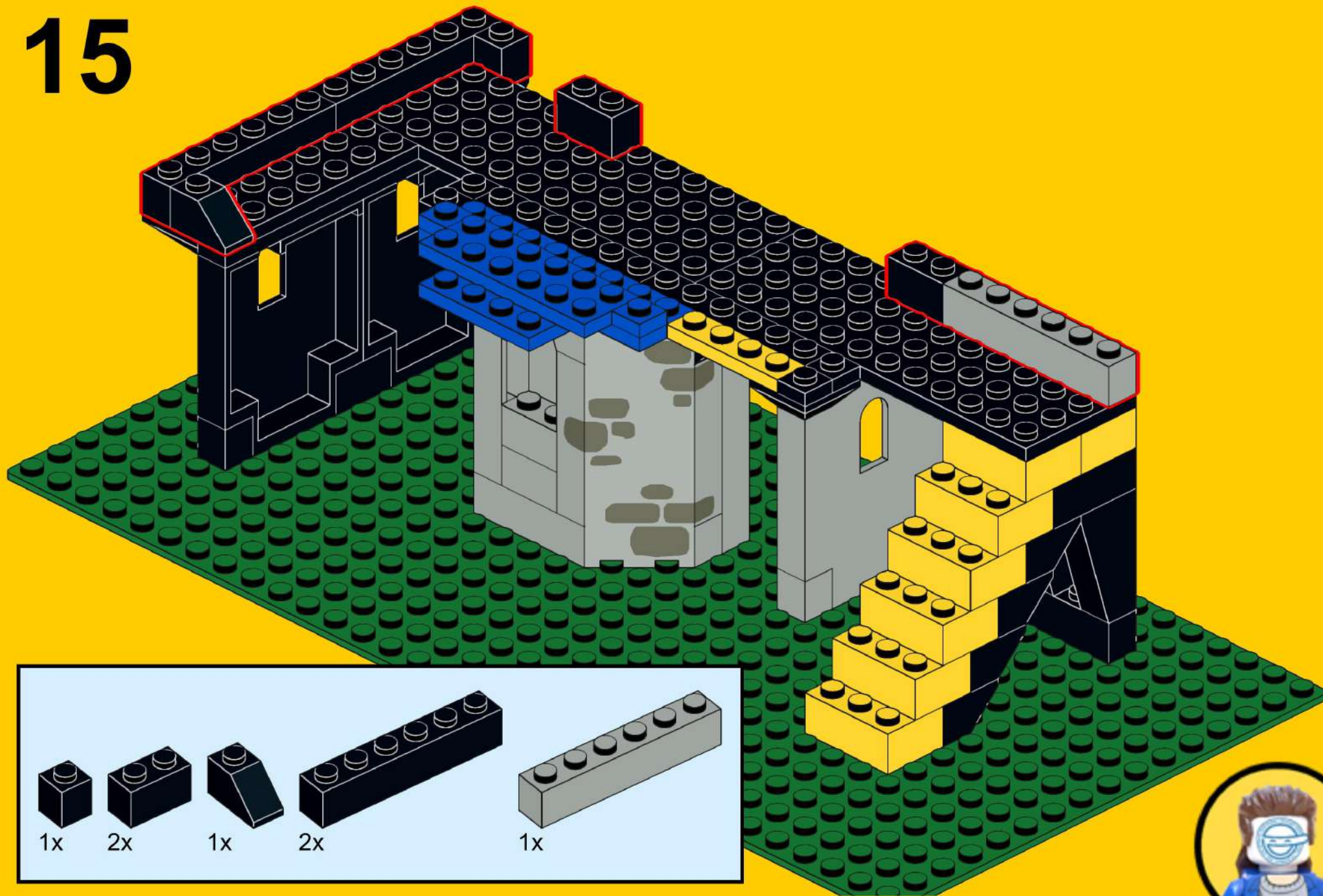



# 16

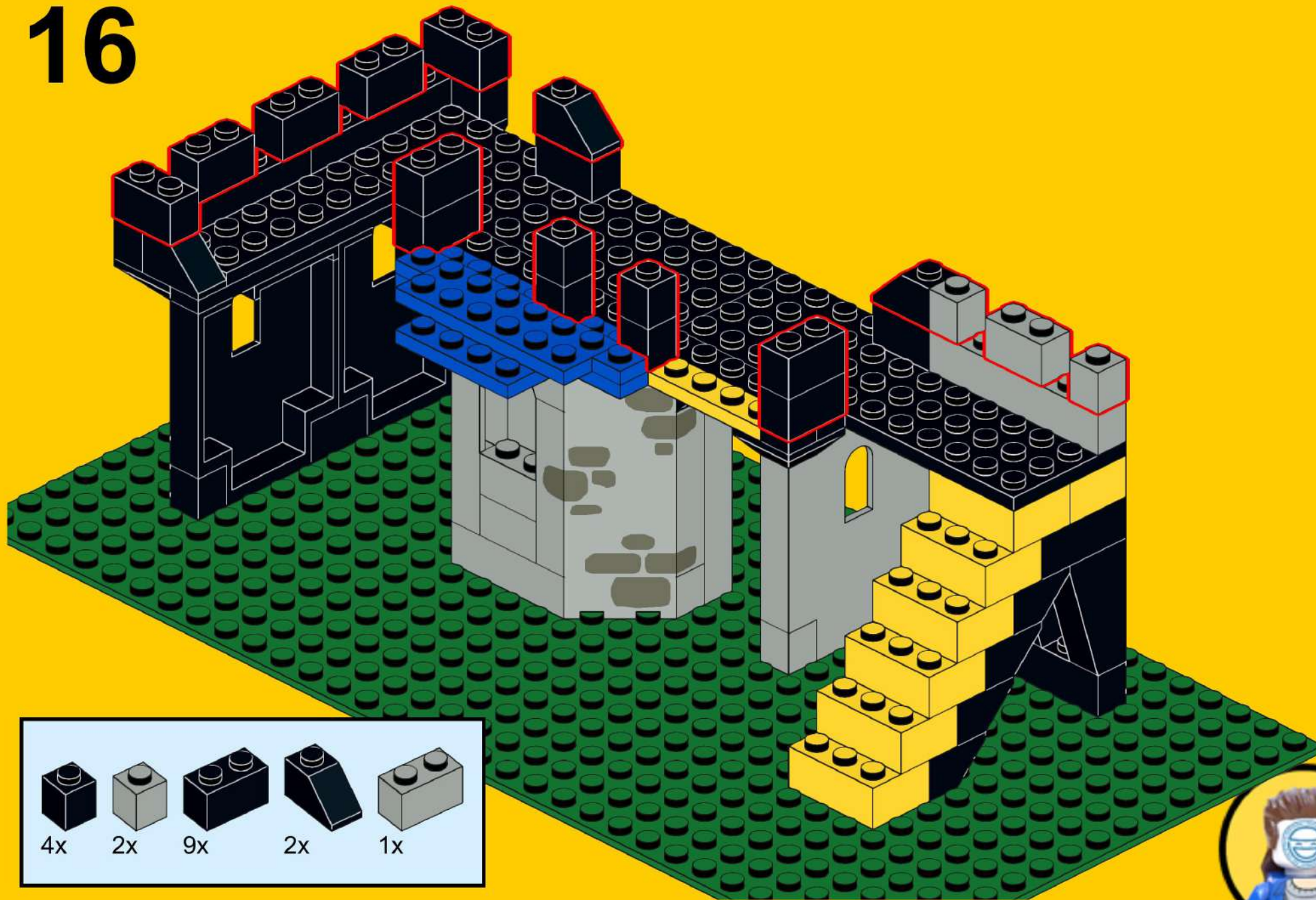

# 17

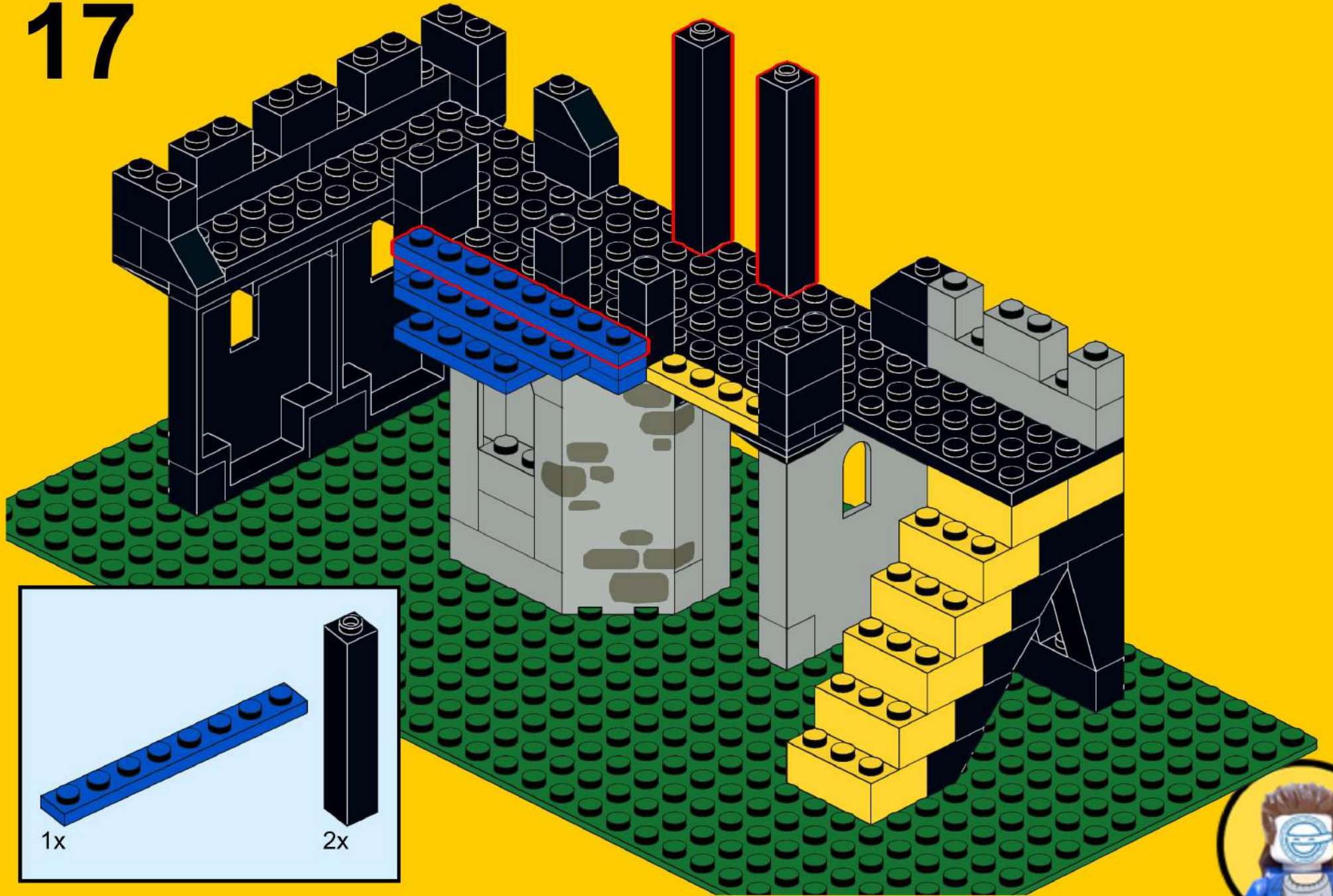

1x

2x



# 18

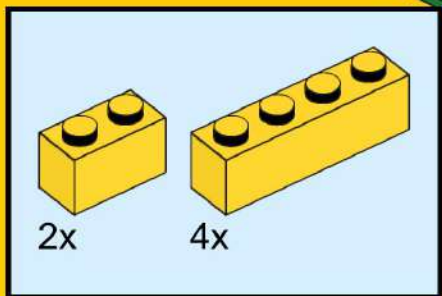
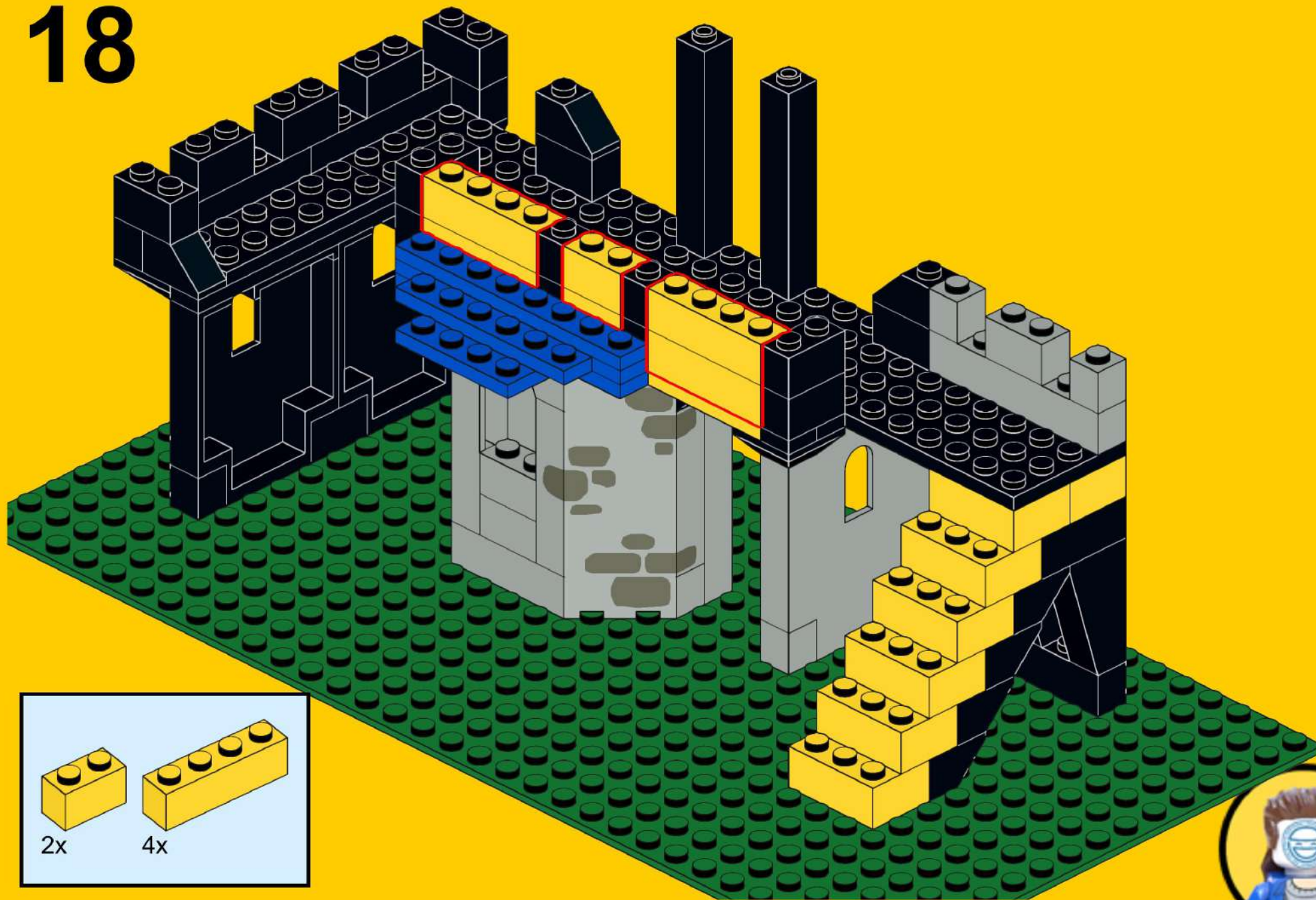

# 19

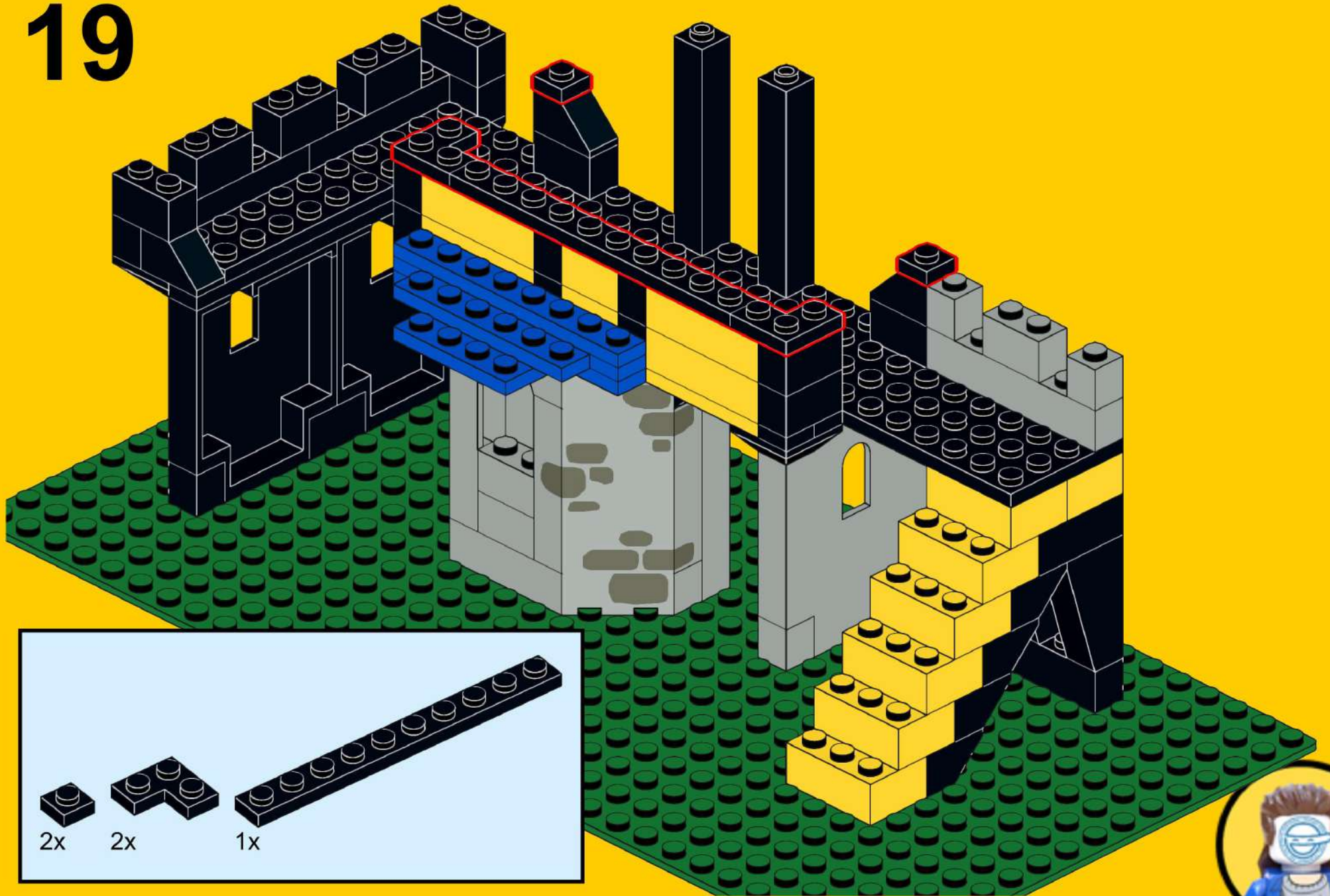

# 20

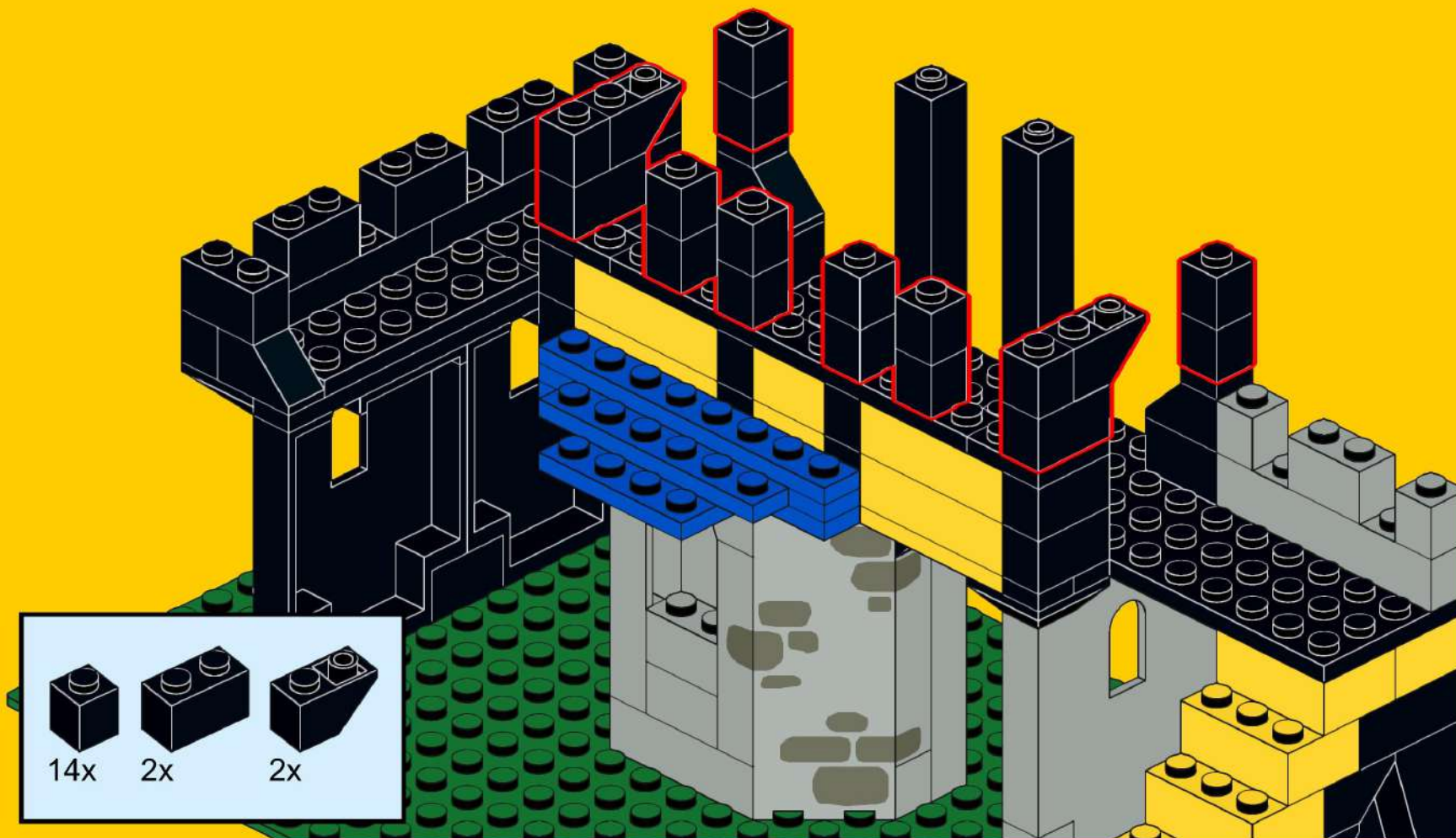

# 21

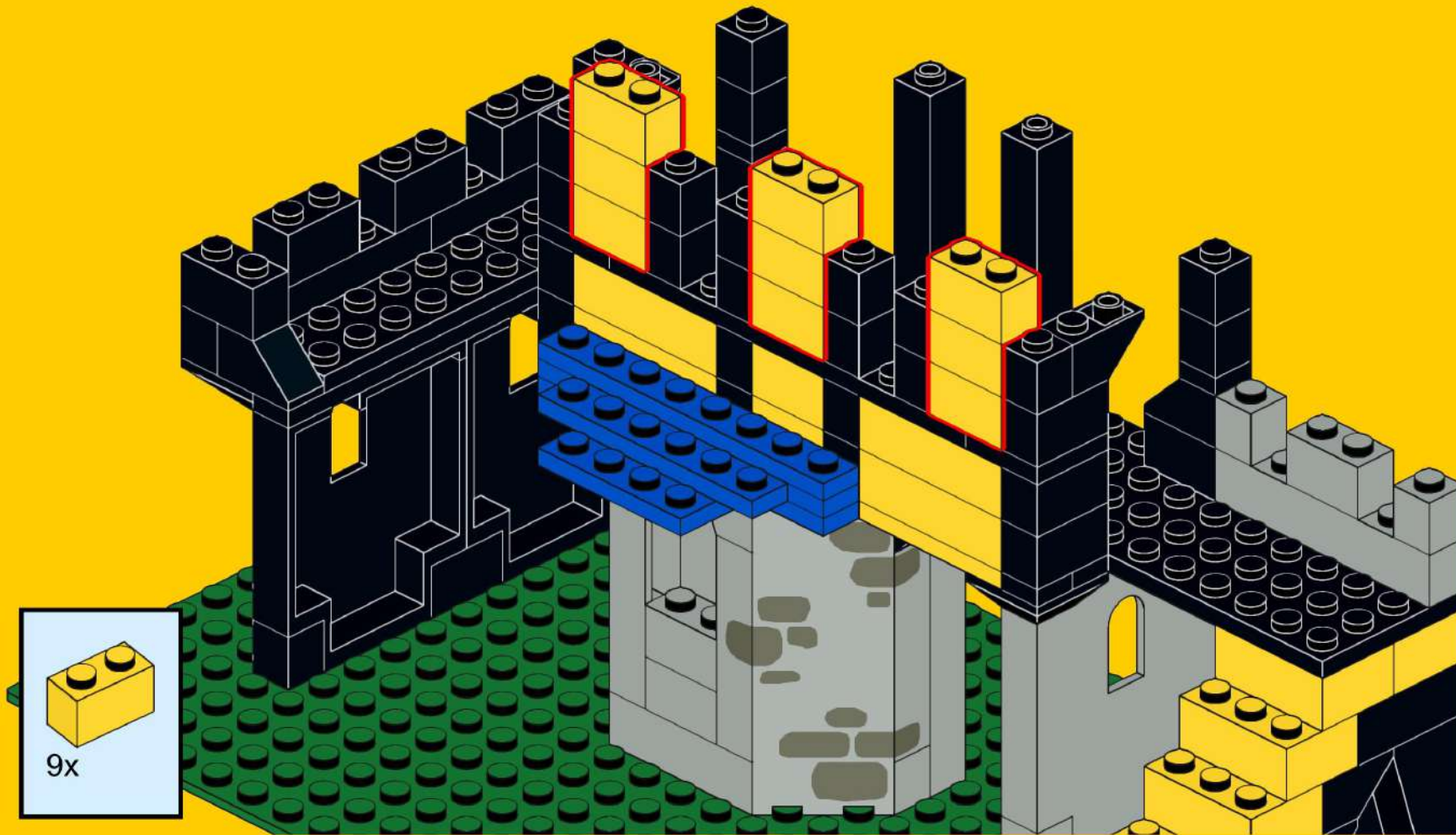

# 22

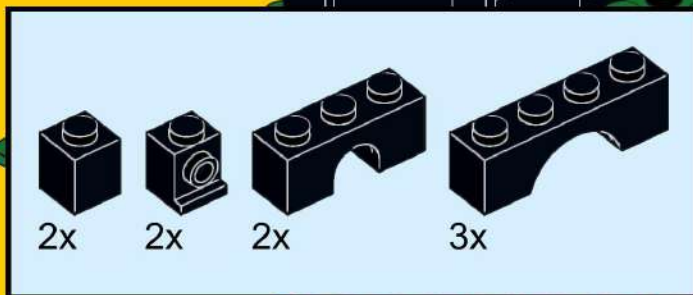
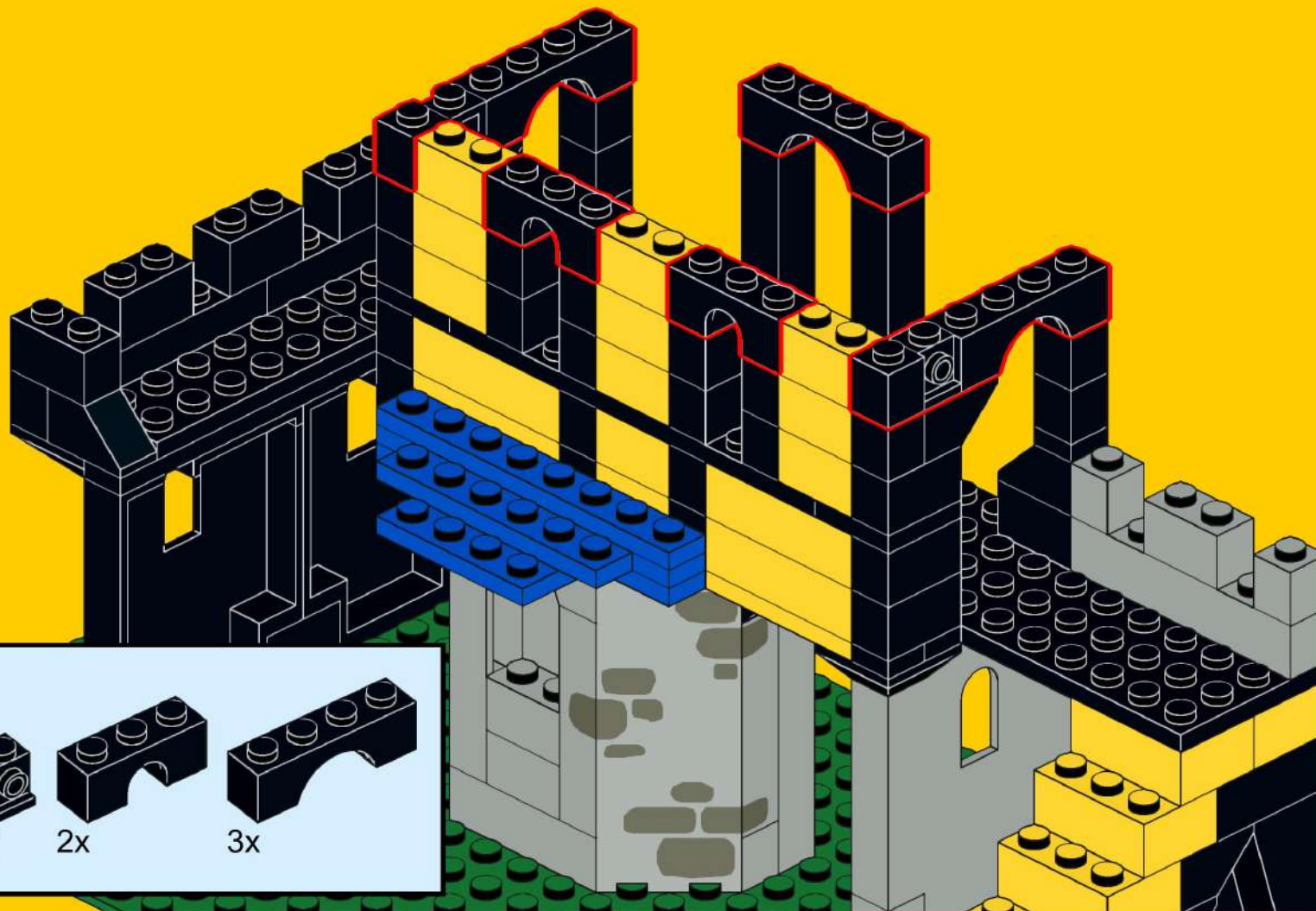

# 23

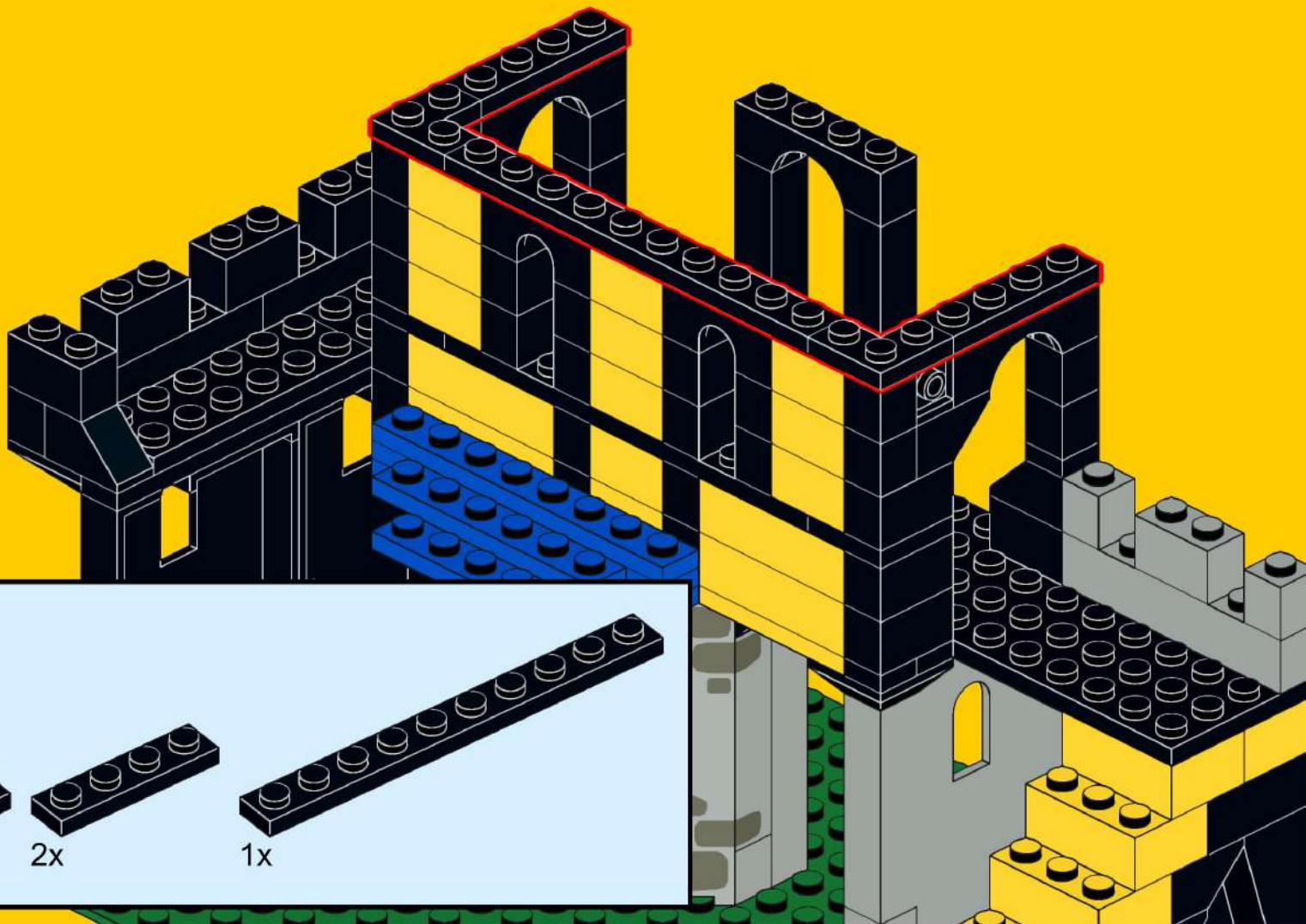



# 24

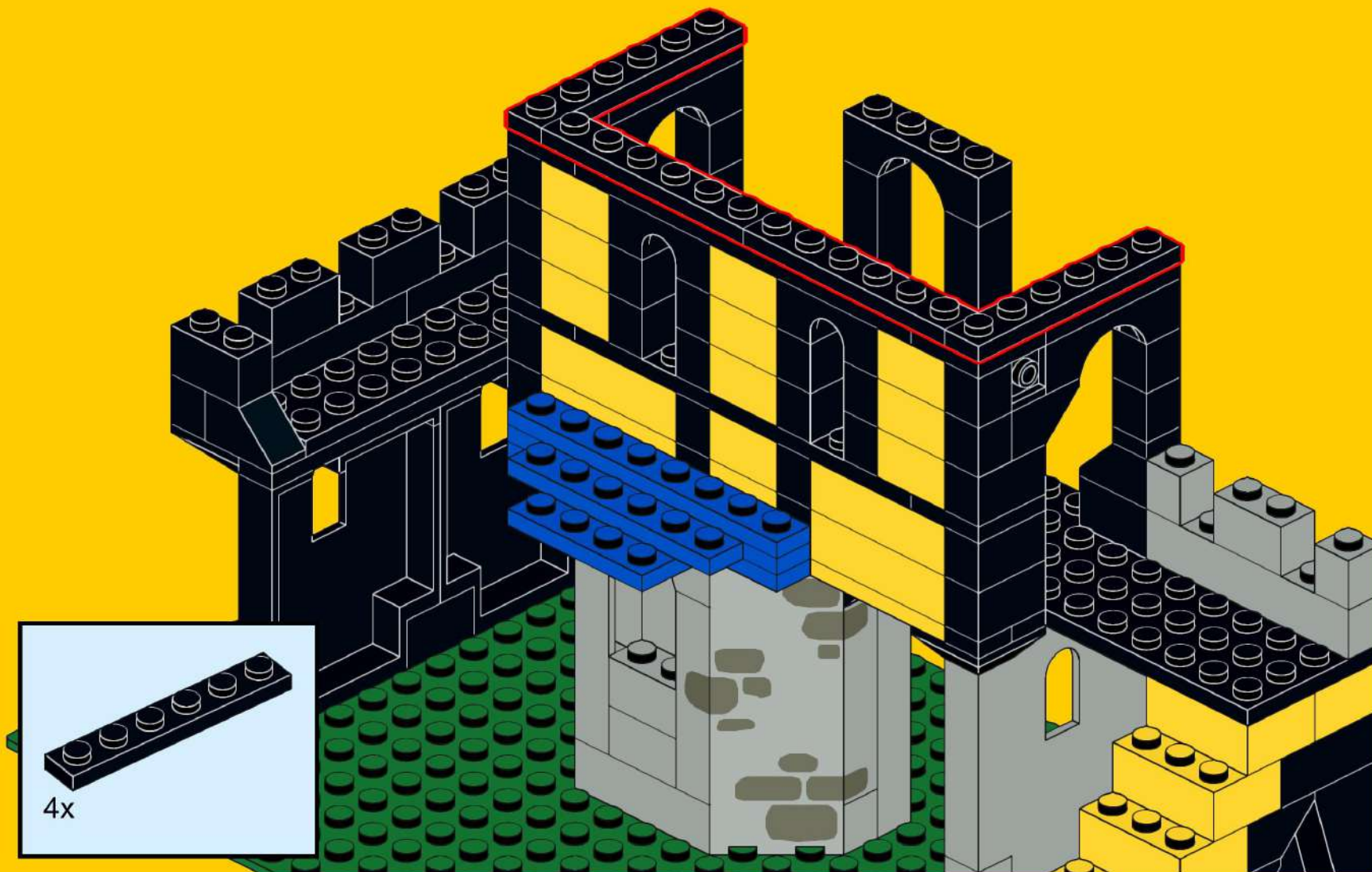

# 25

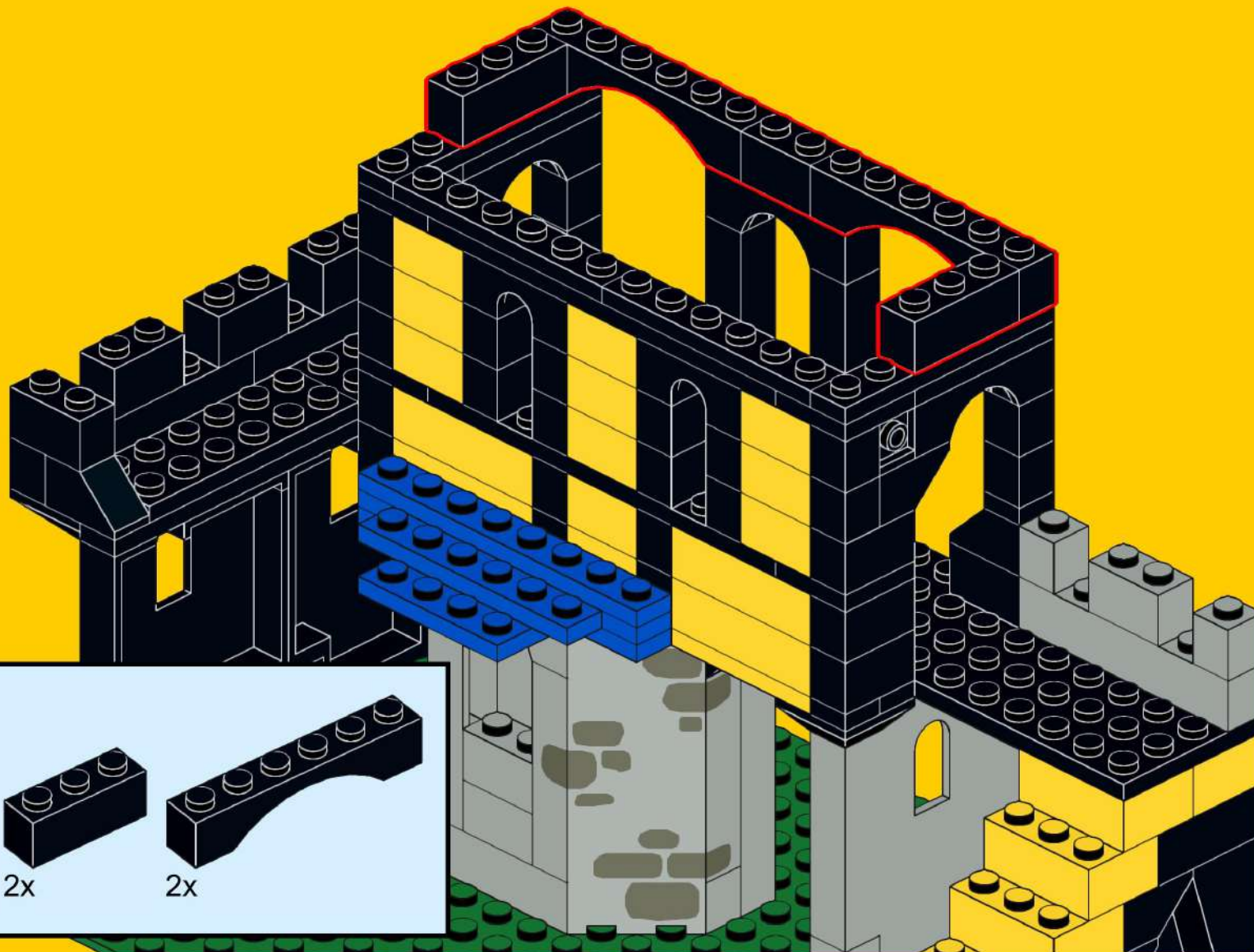

# 26

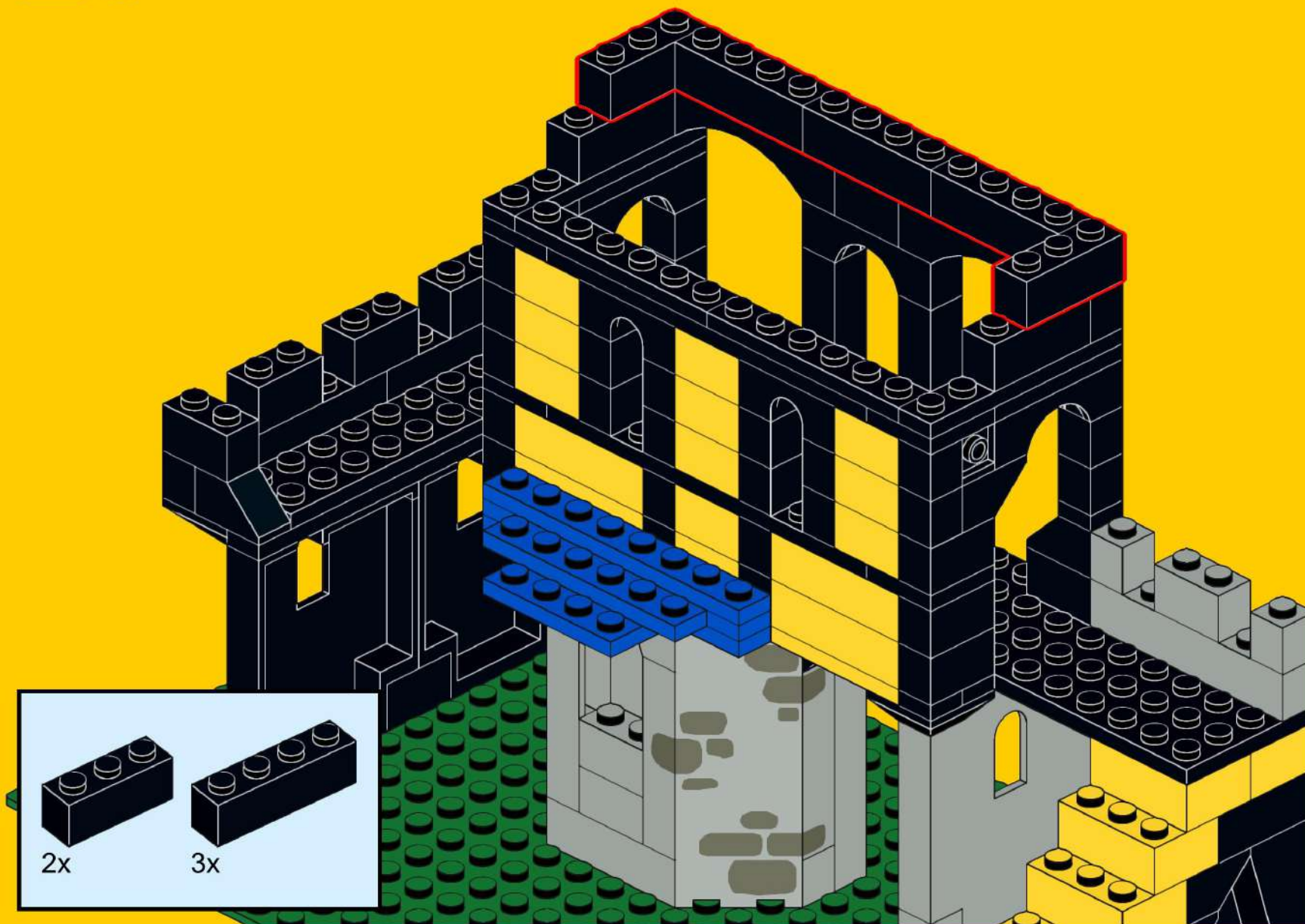

# 27

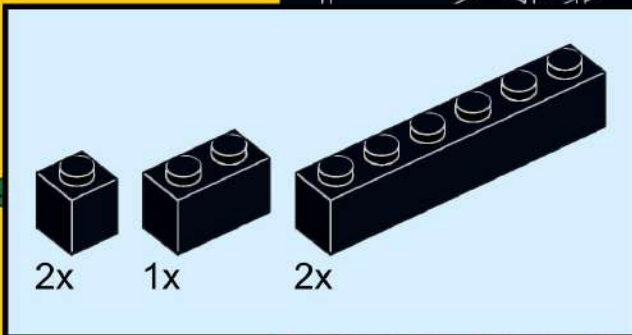
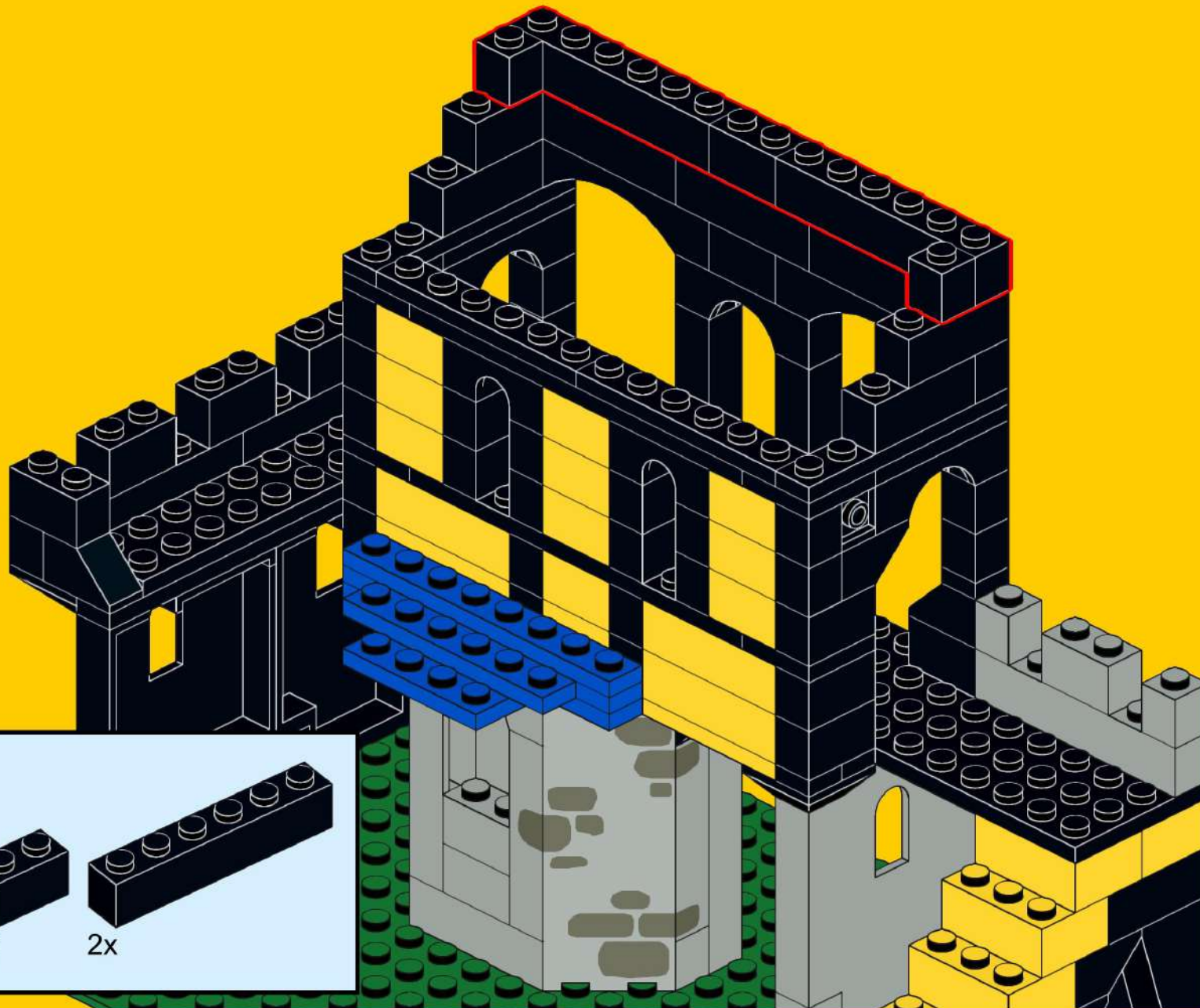

# 28

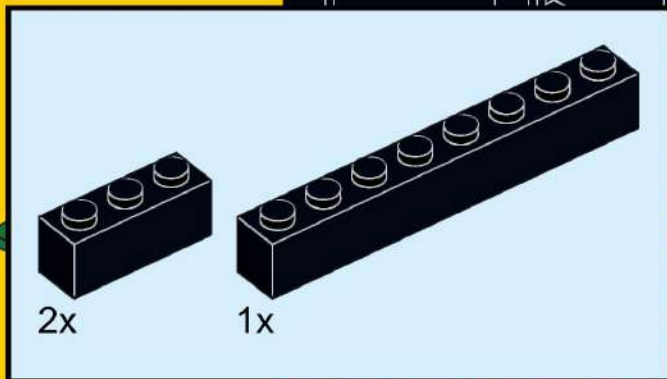
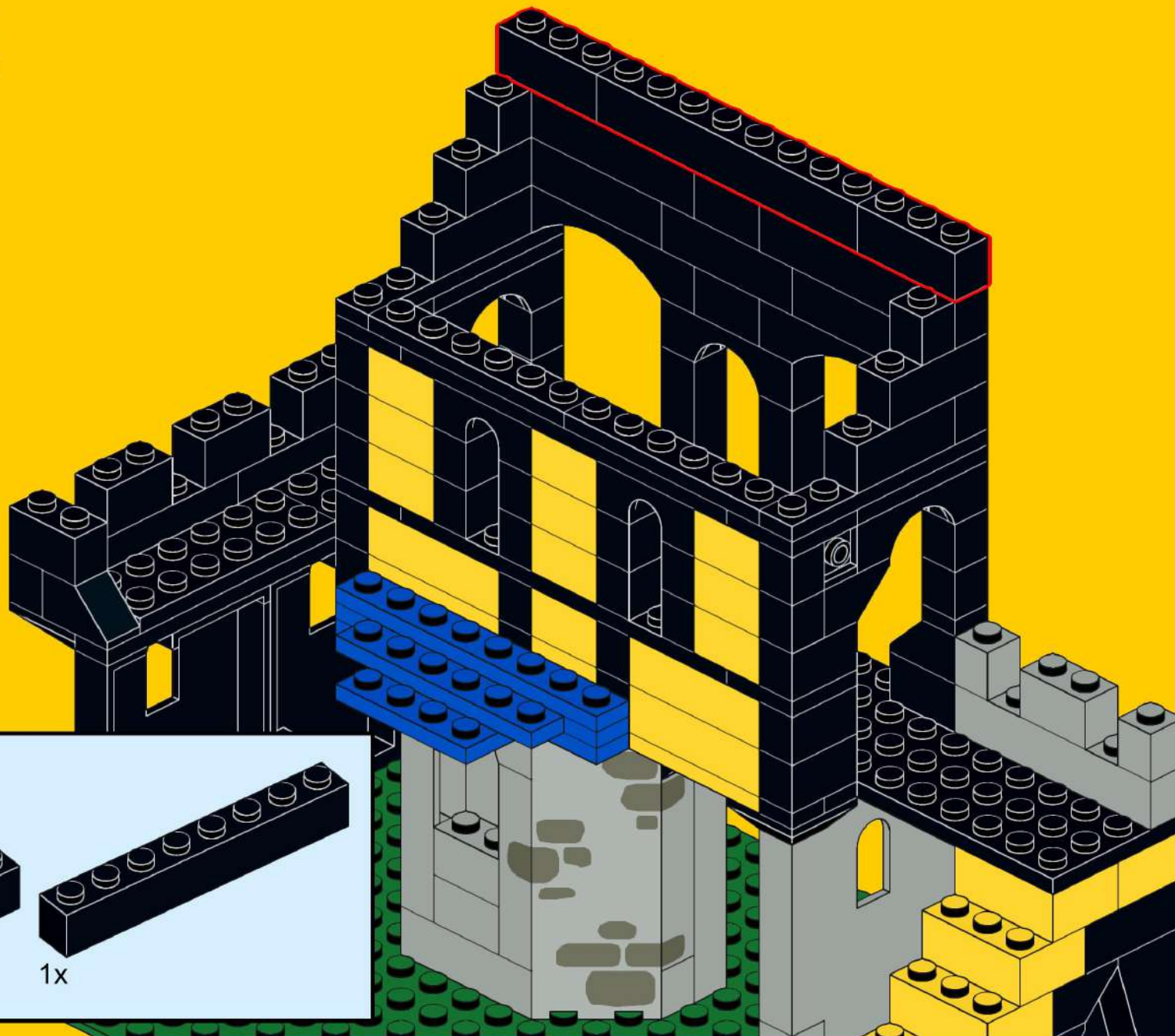

# 29

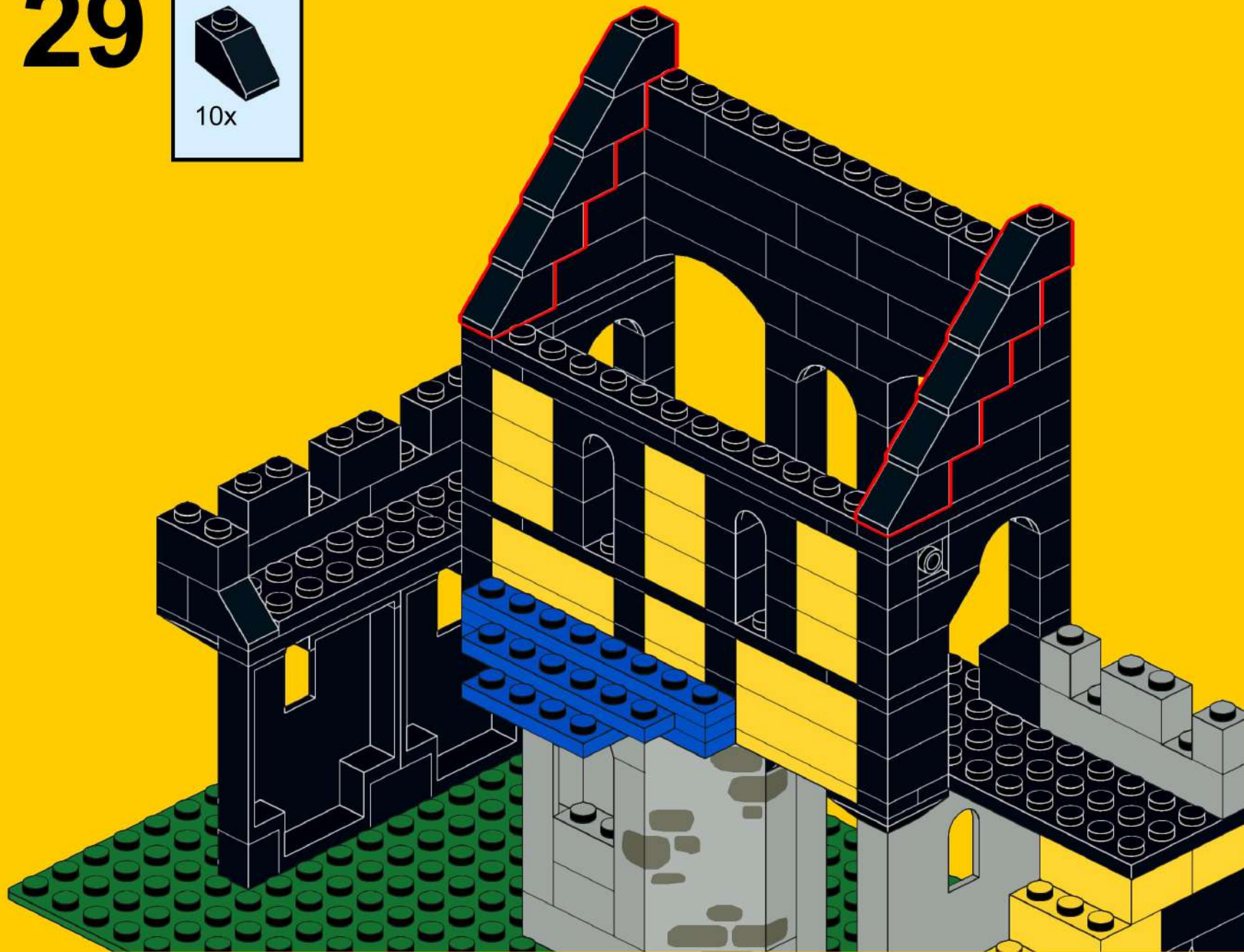

# 30

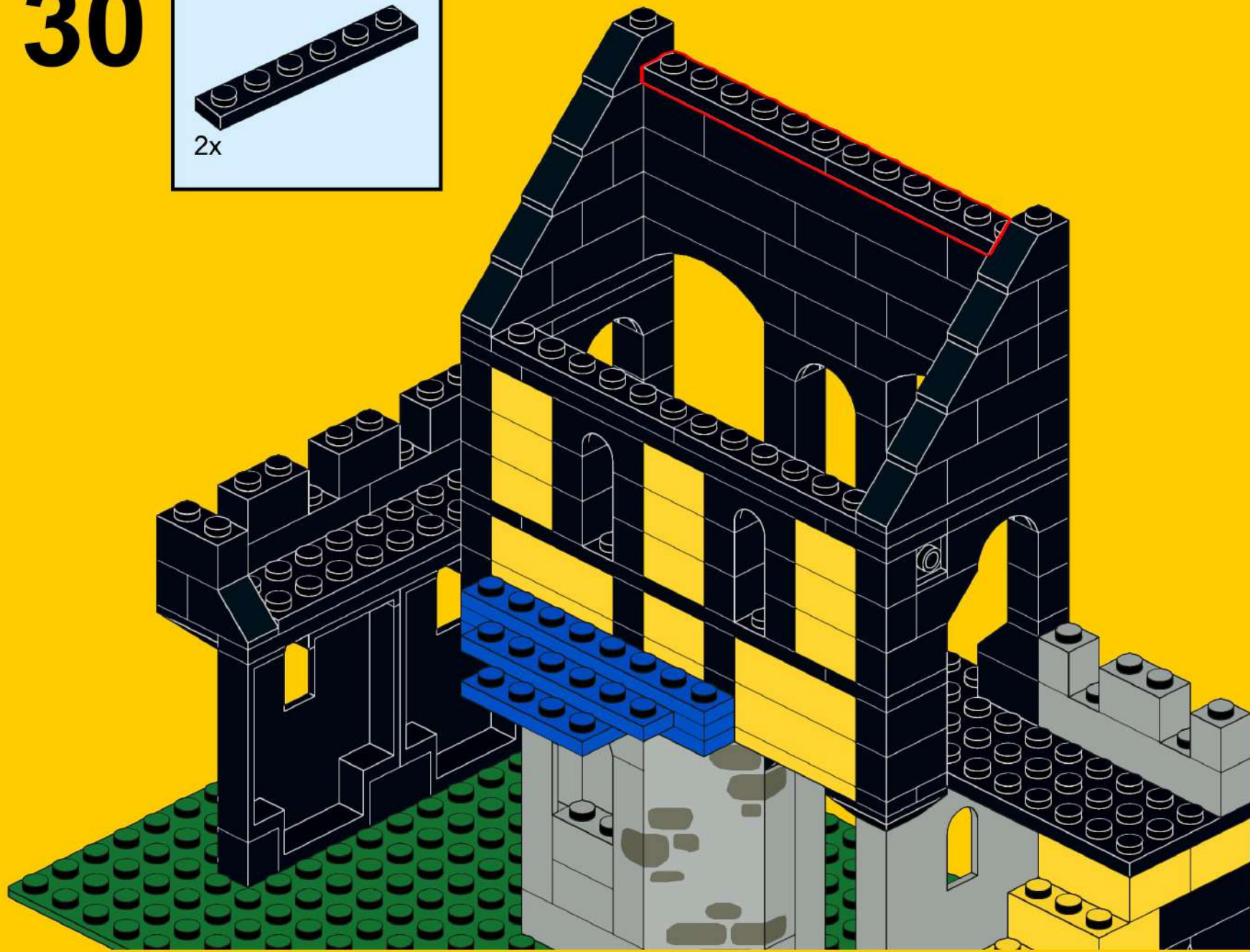
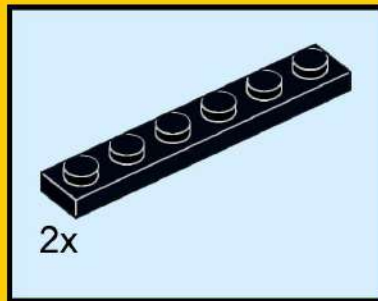

# 31

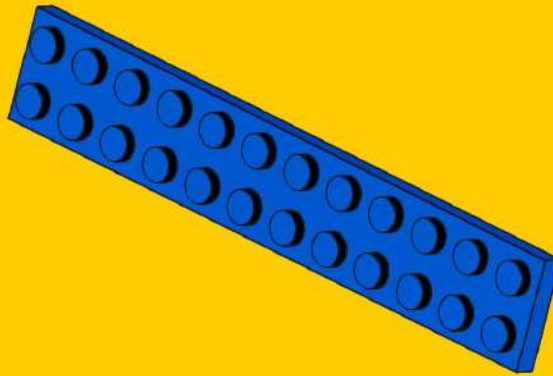
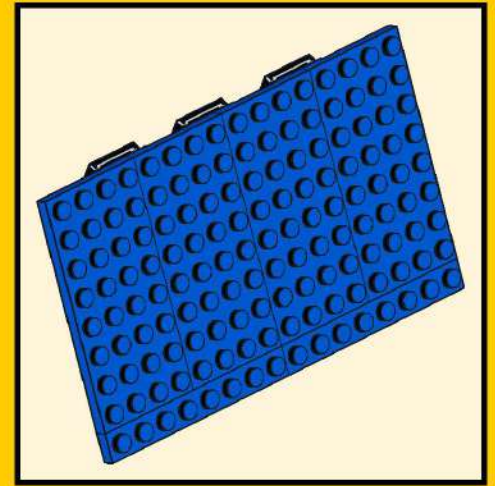
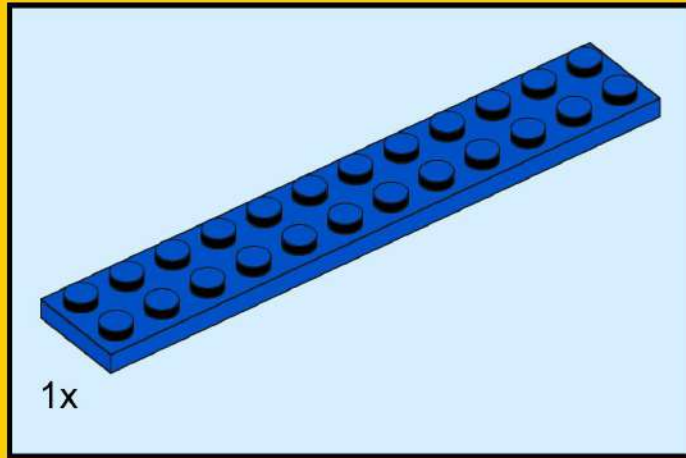



# 32

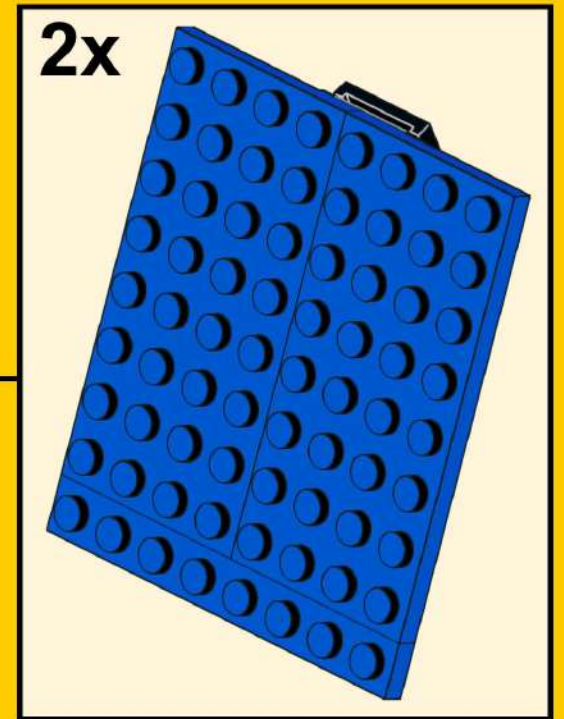
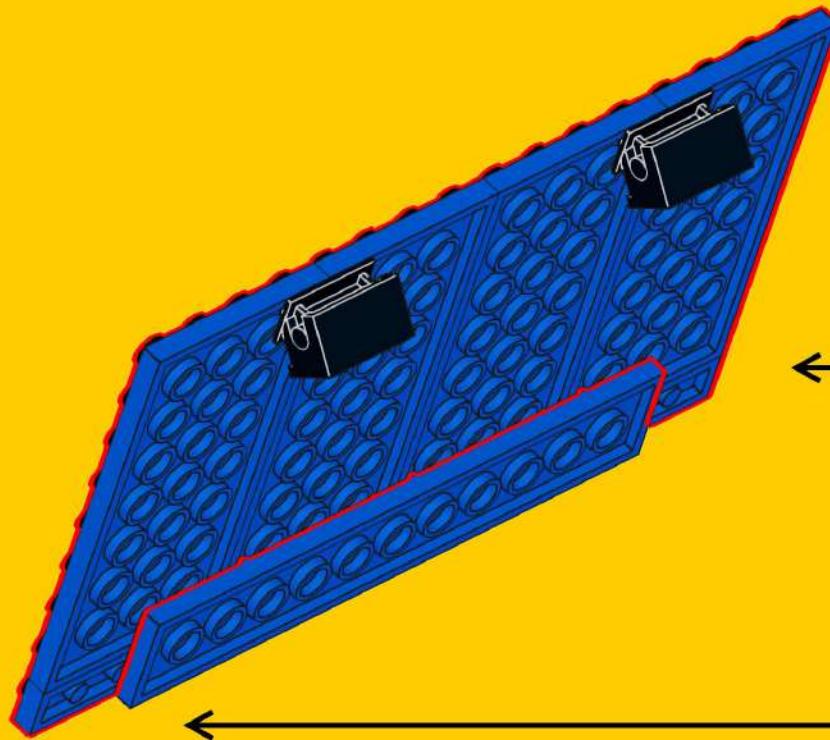
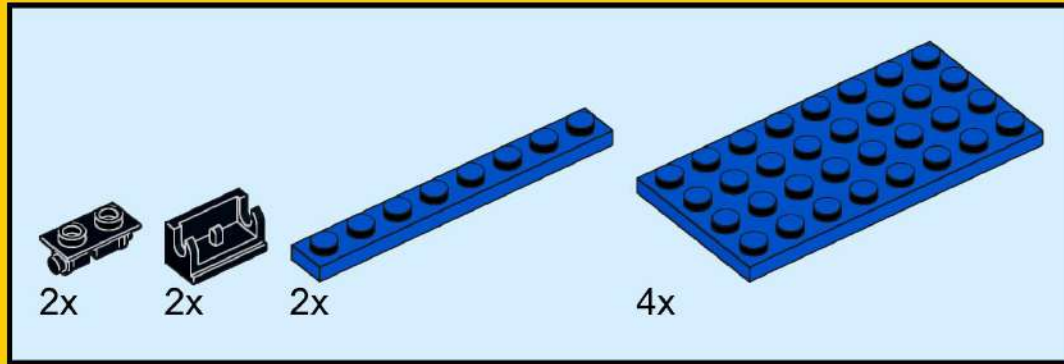



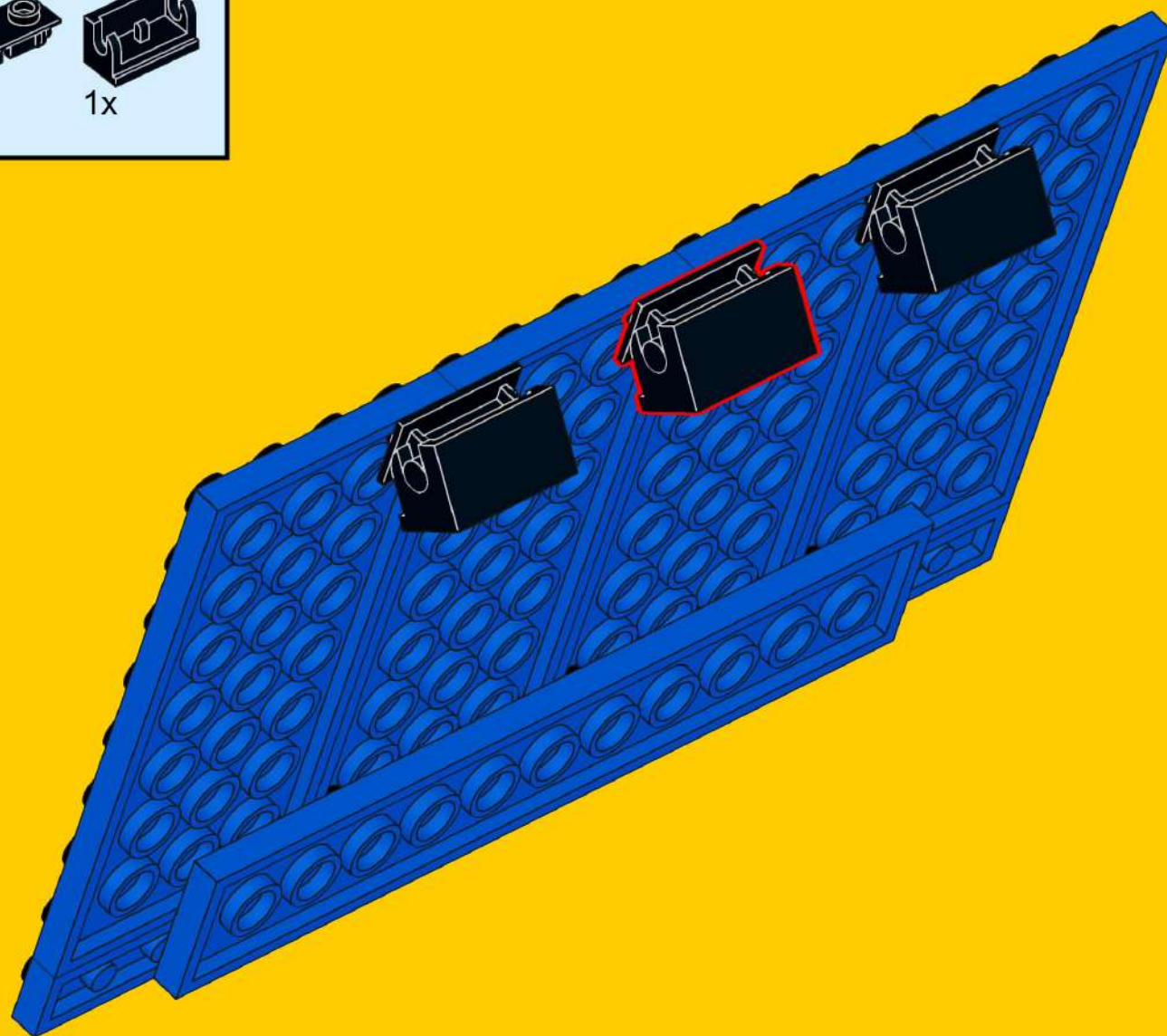
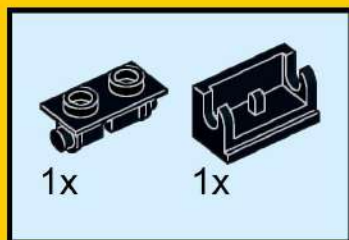

# 33

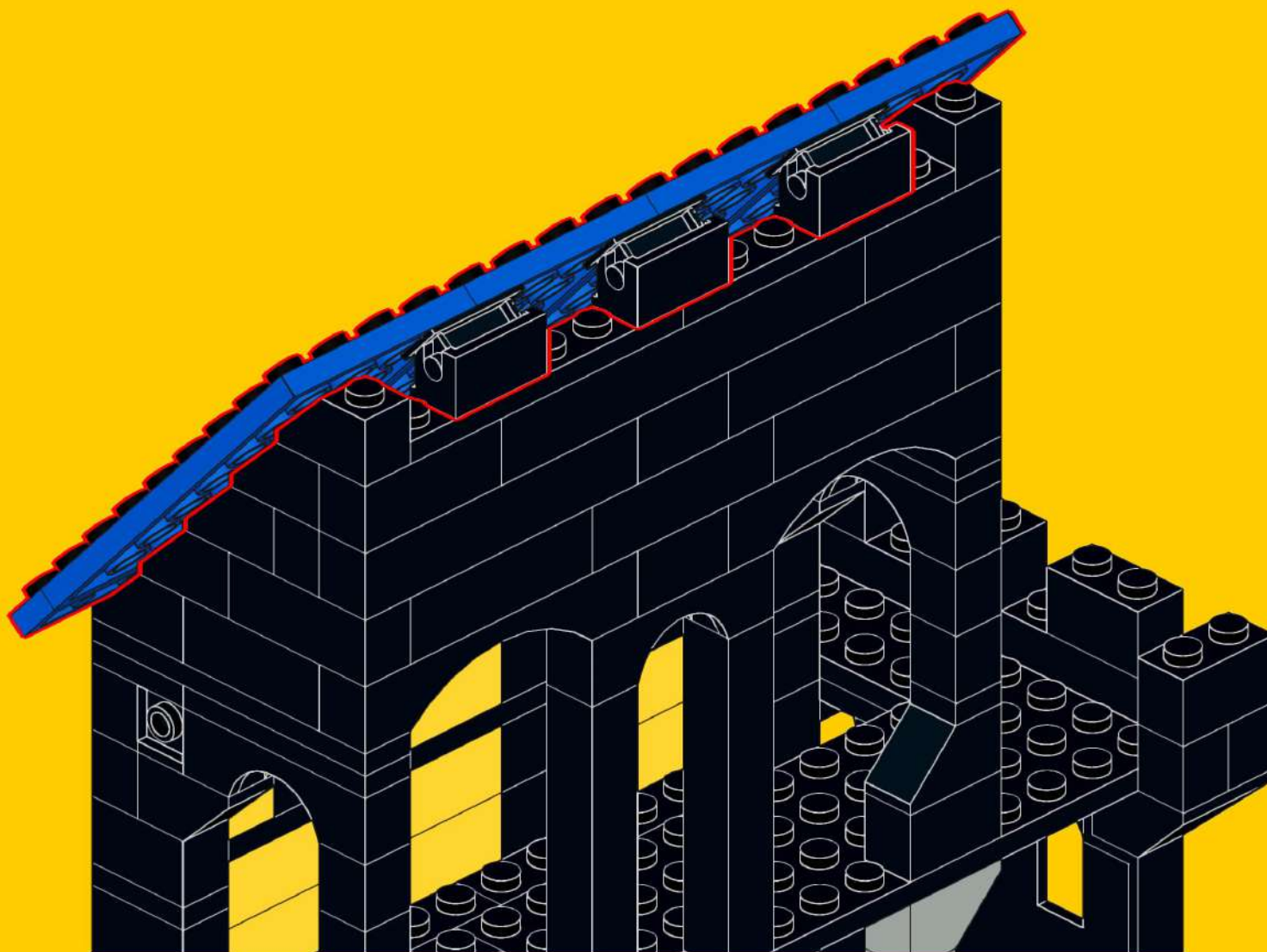

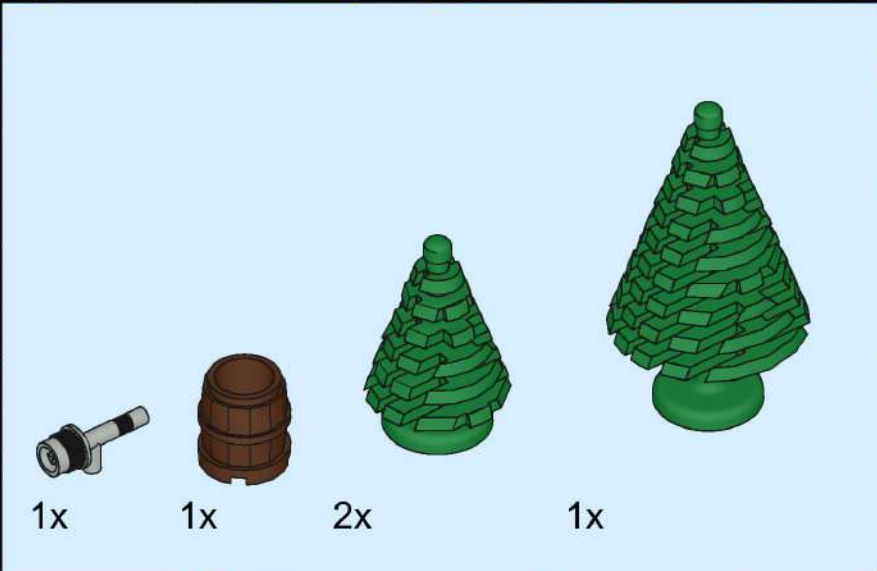
# 34





1x  1x  2x  1x 

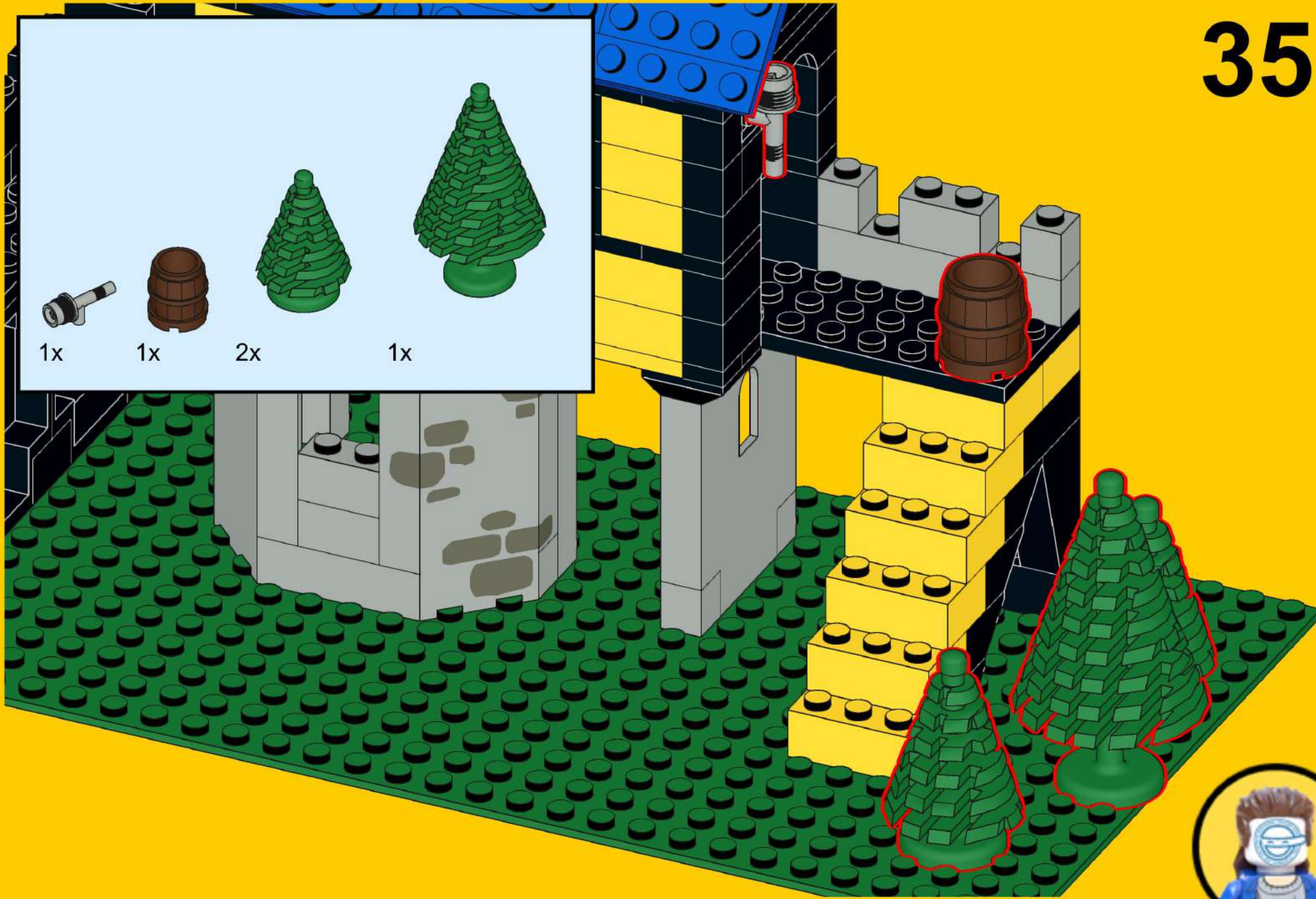

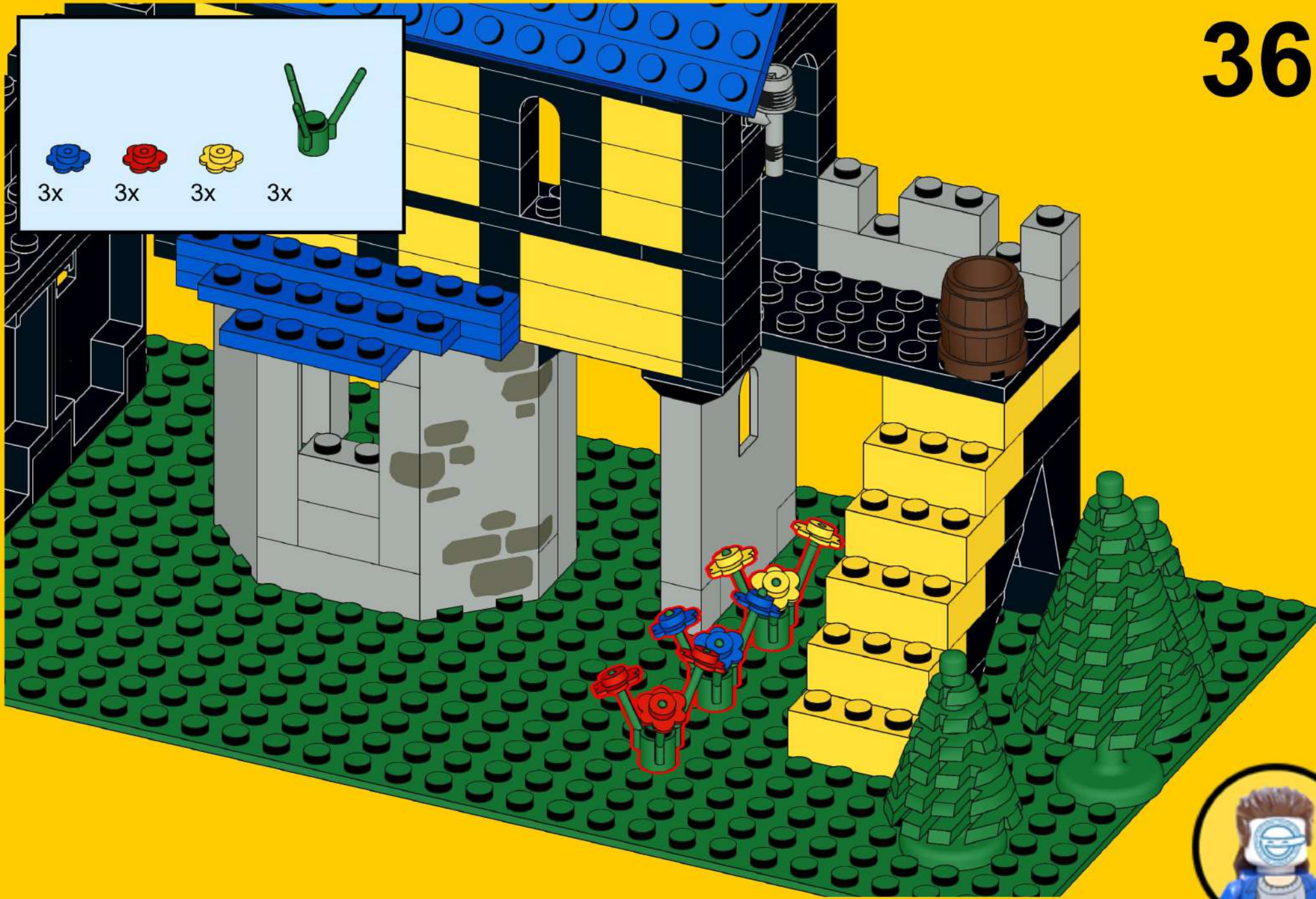

3x 3x 3x 3x

A white callout box with a black border. It contains four items: a blue flower, a red flower, a yellow flower, and a green plant. Below each item is the text "3x".

37



38



39



# 40

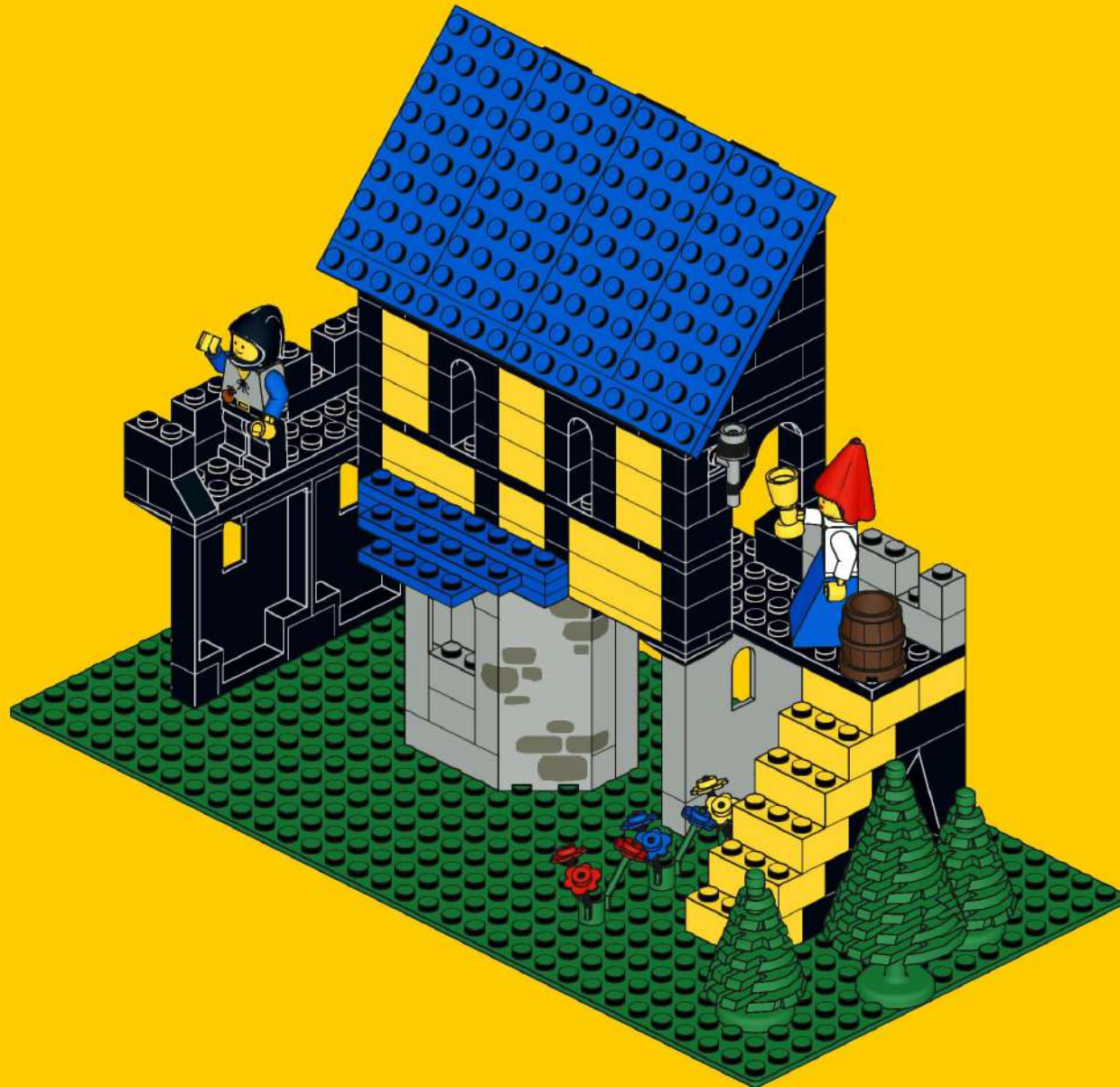



41

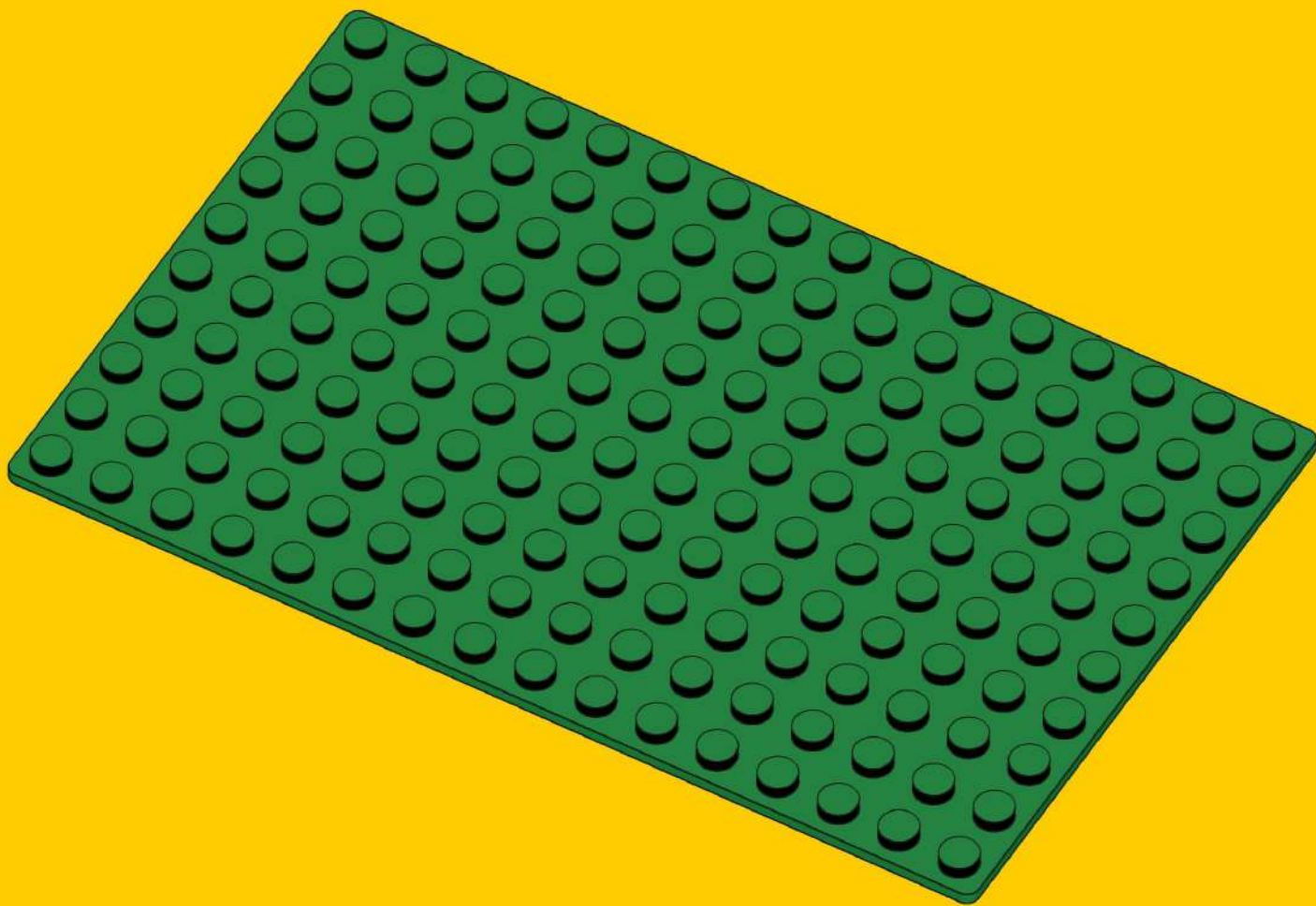

# 42

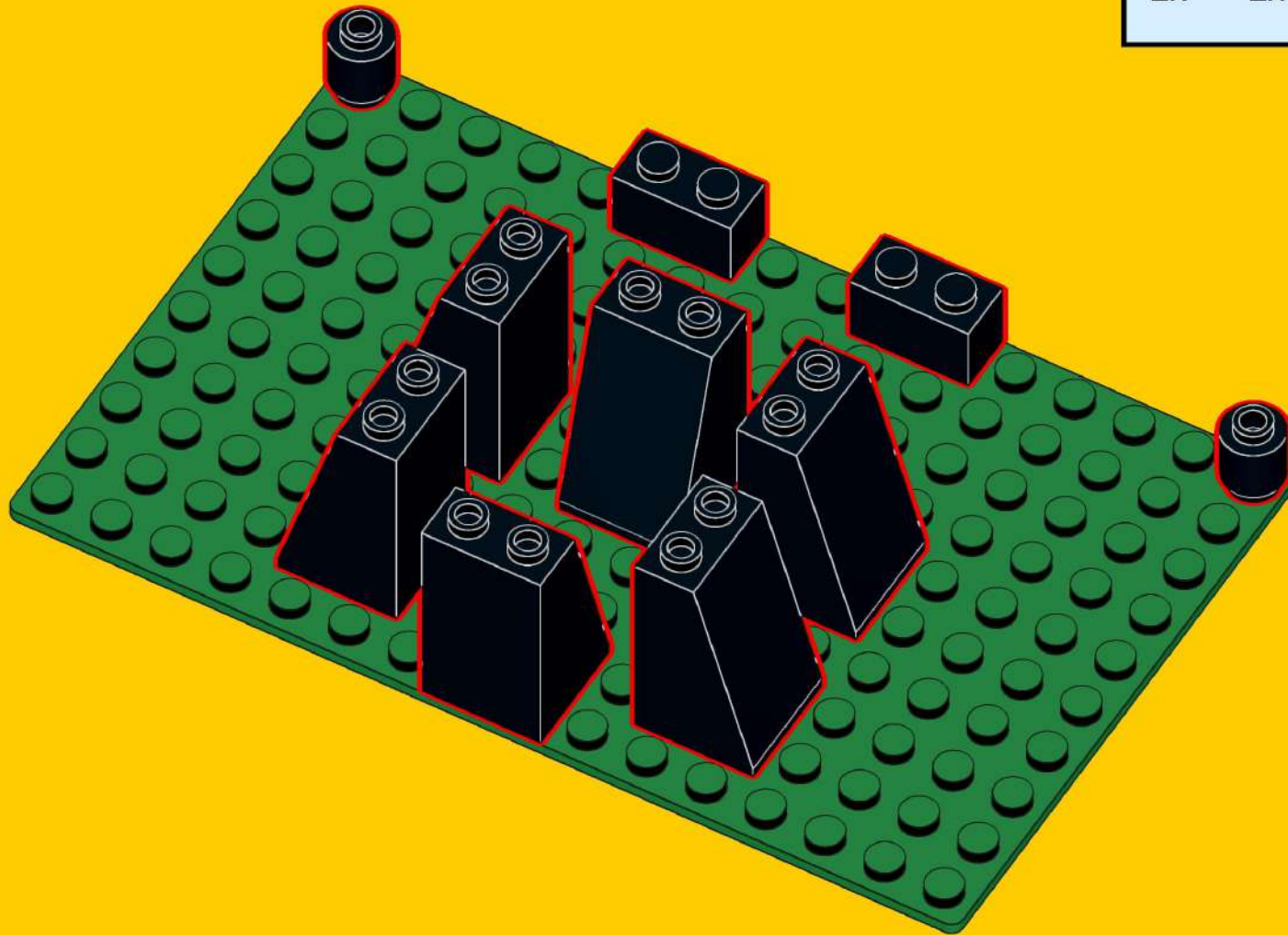
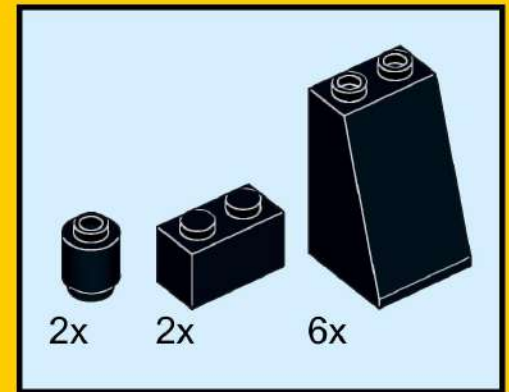

# 43

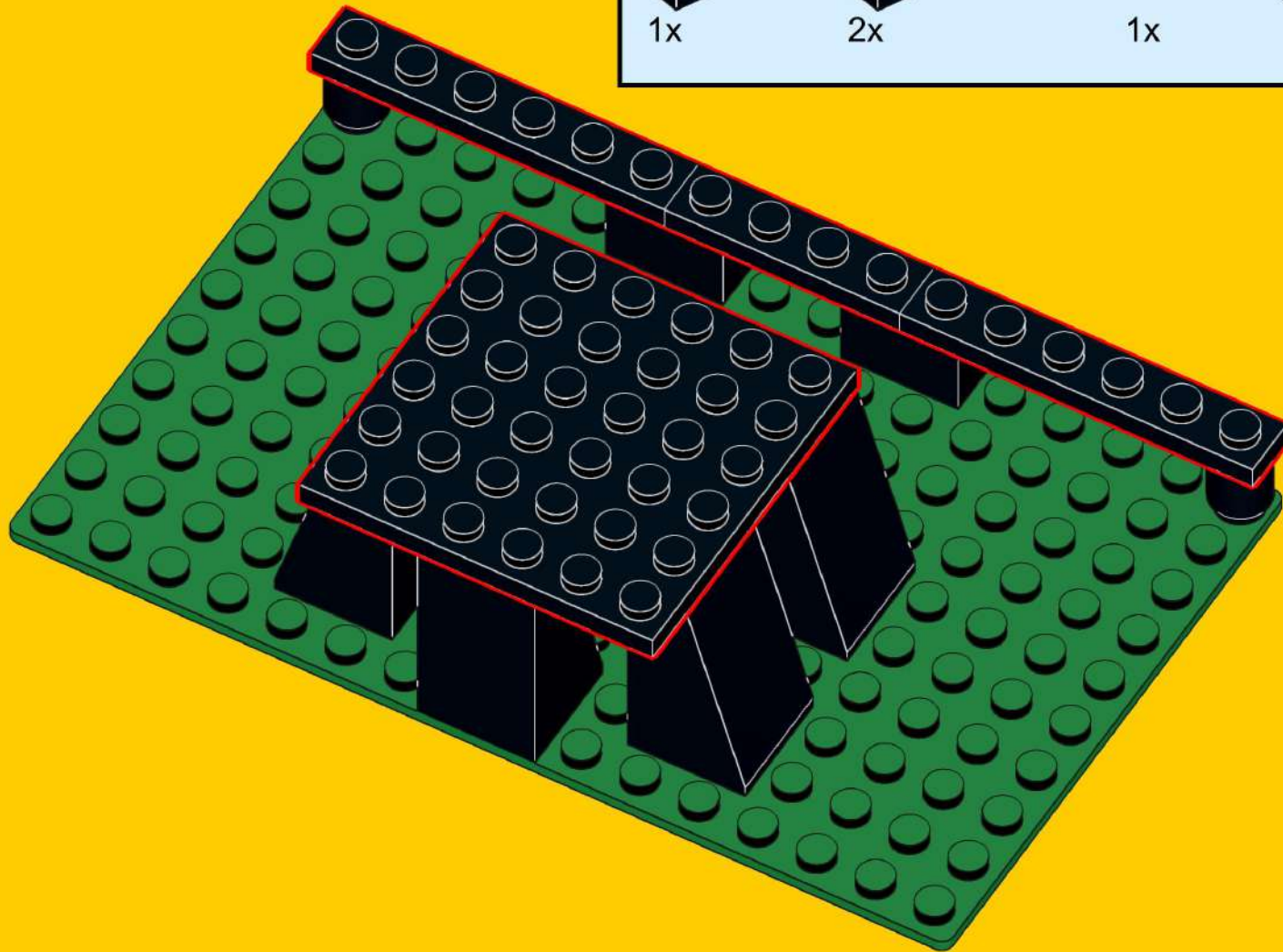
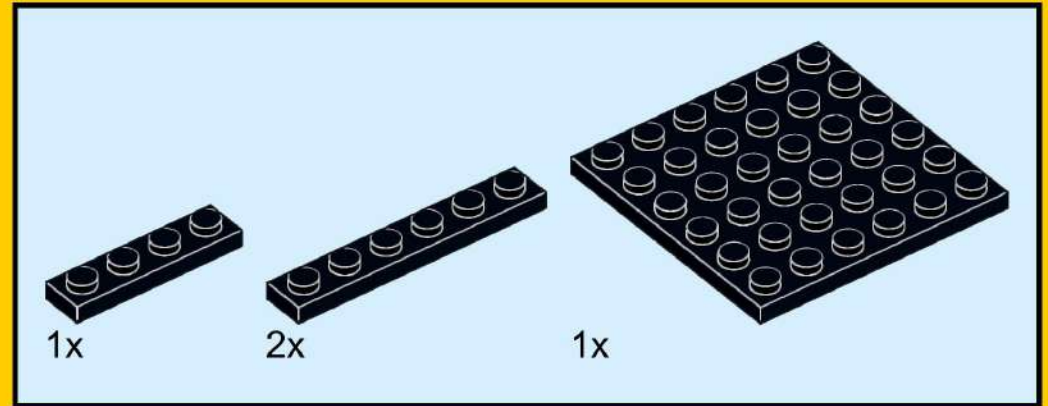

# 44

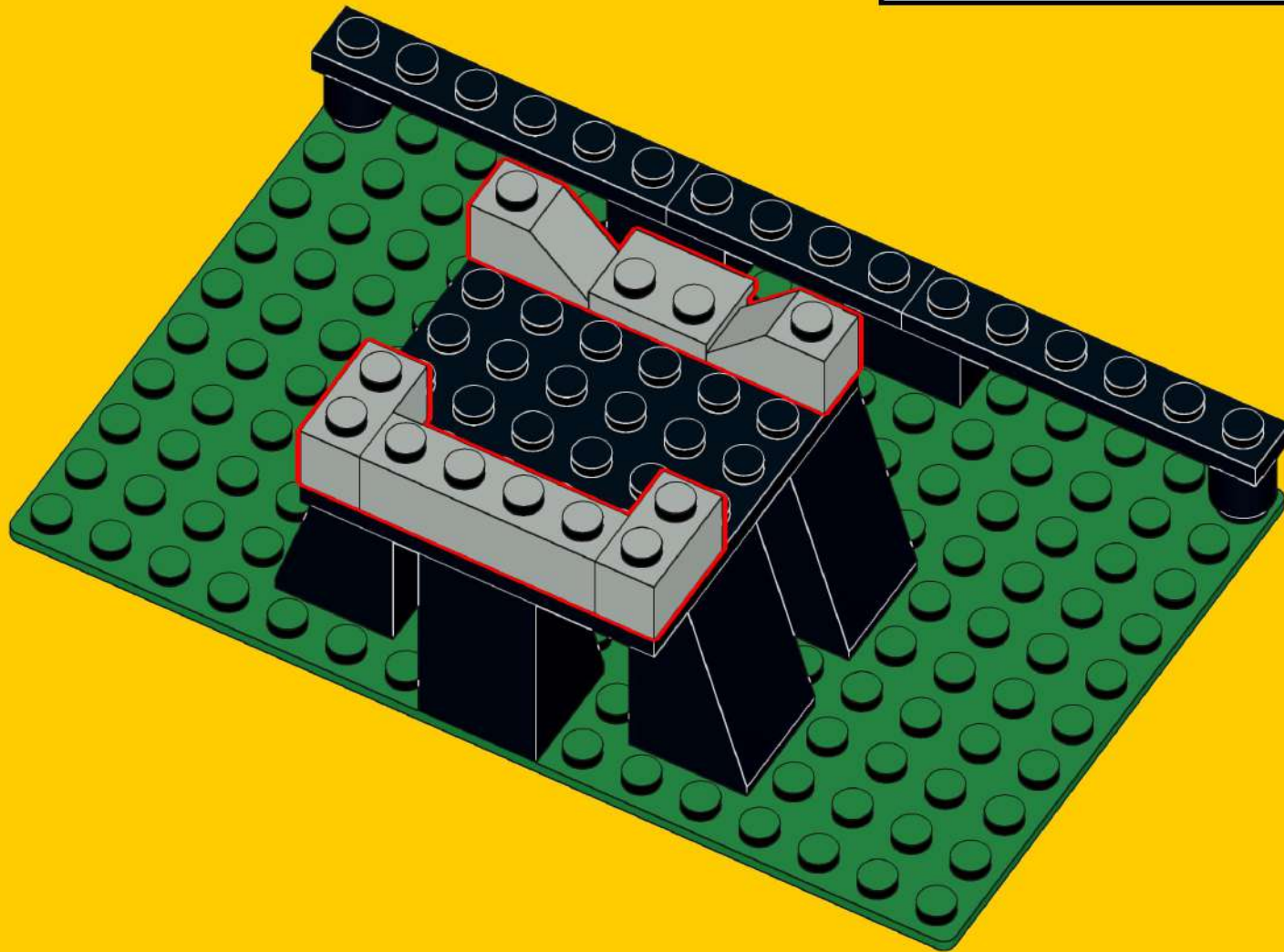
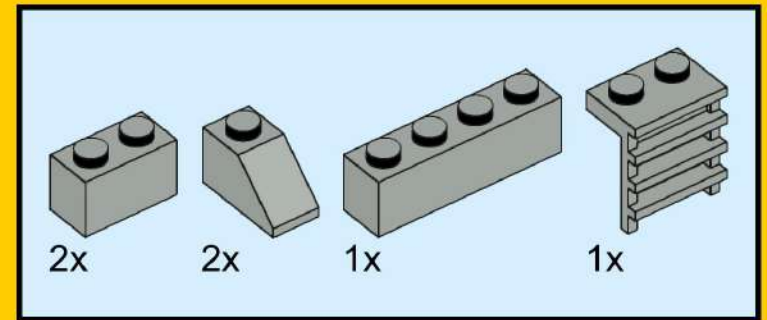

# 45

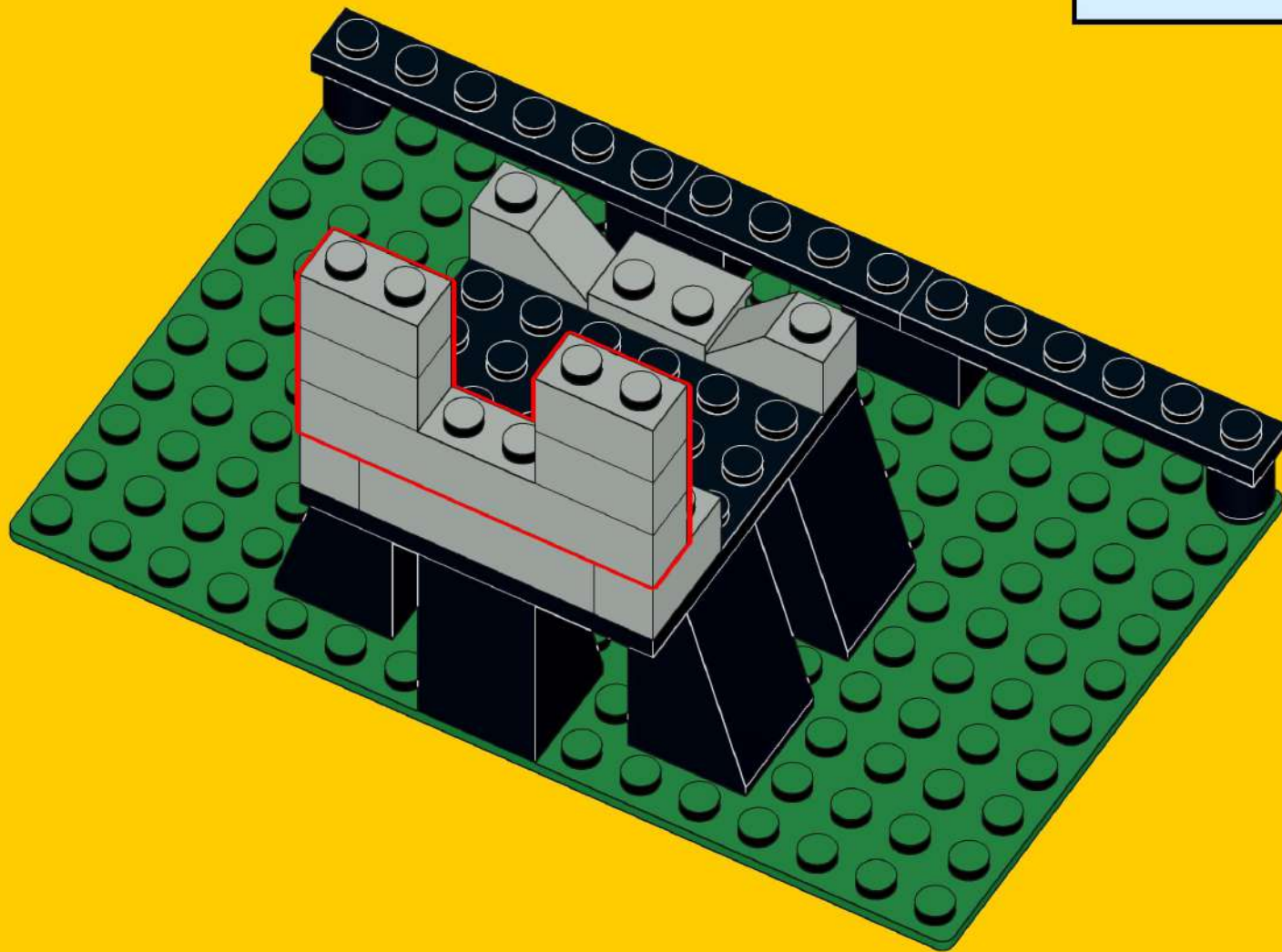
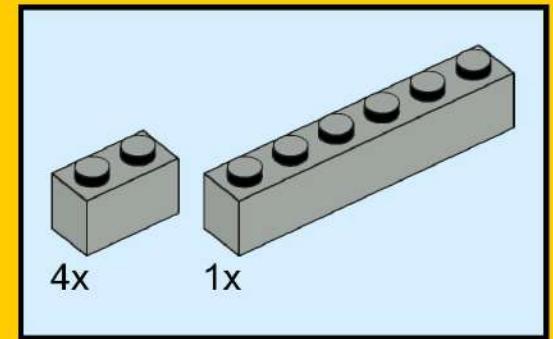

# 46

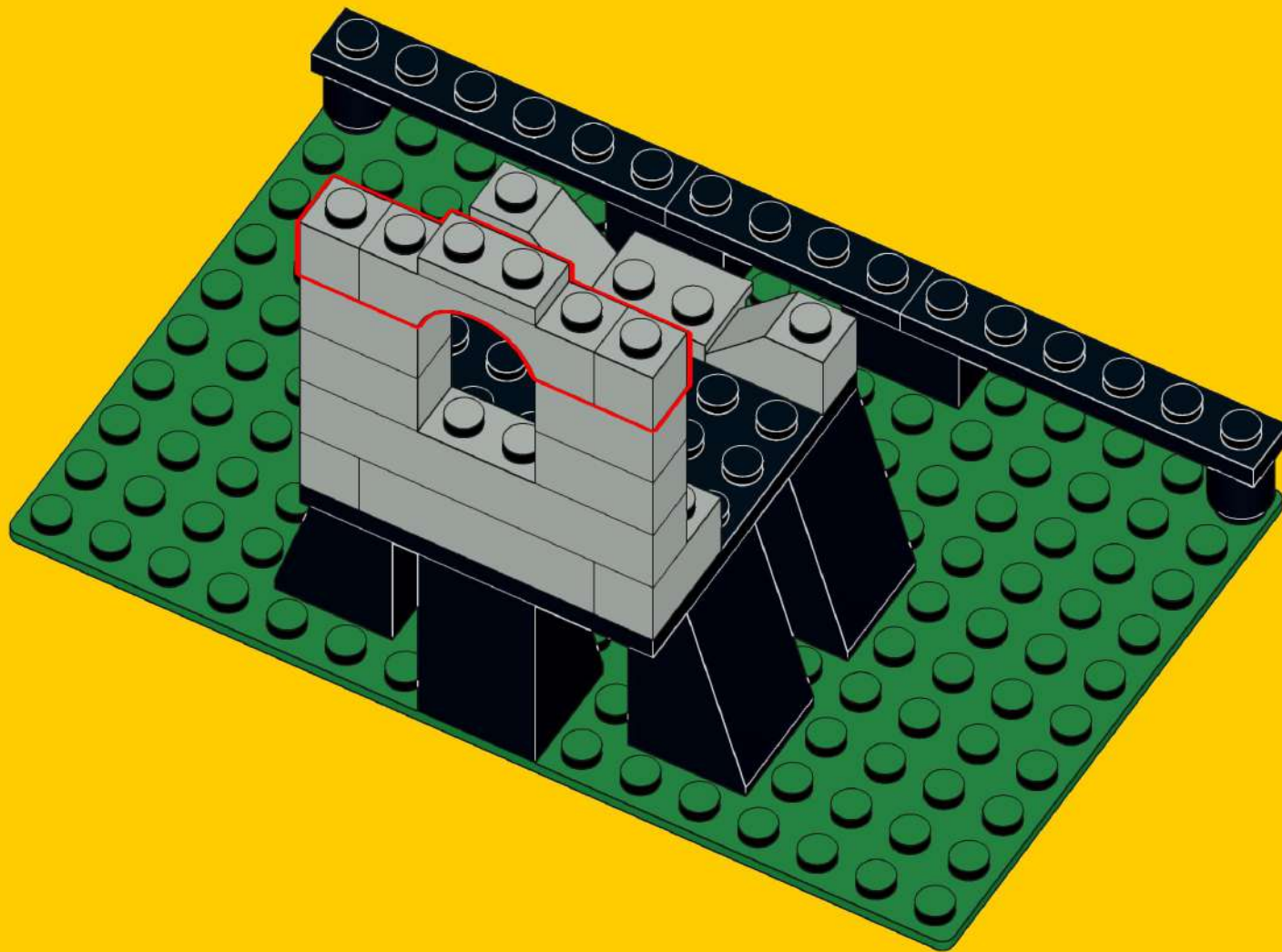
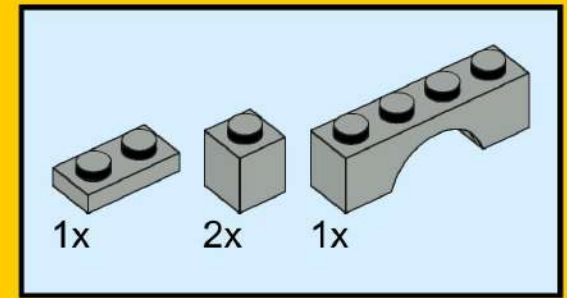

# 47

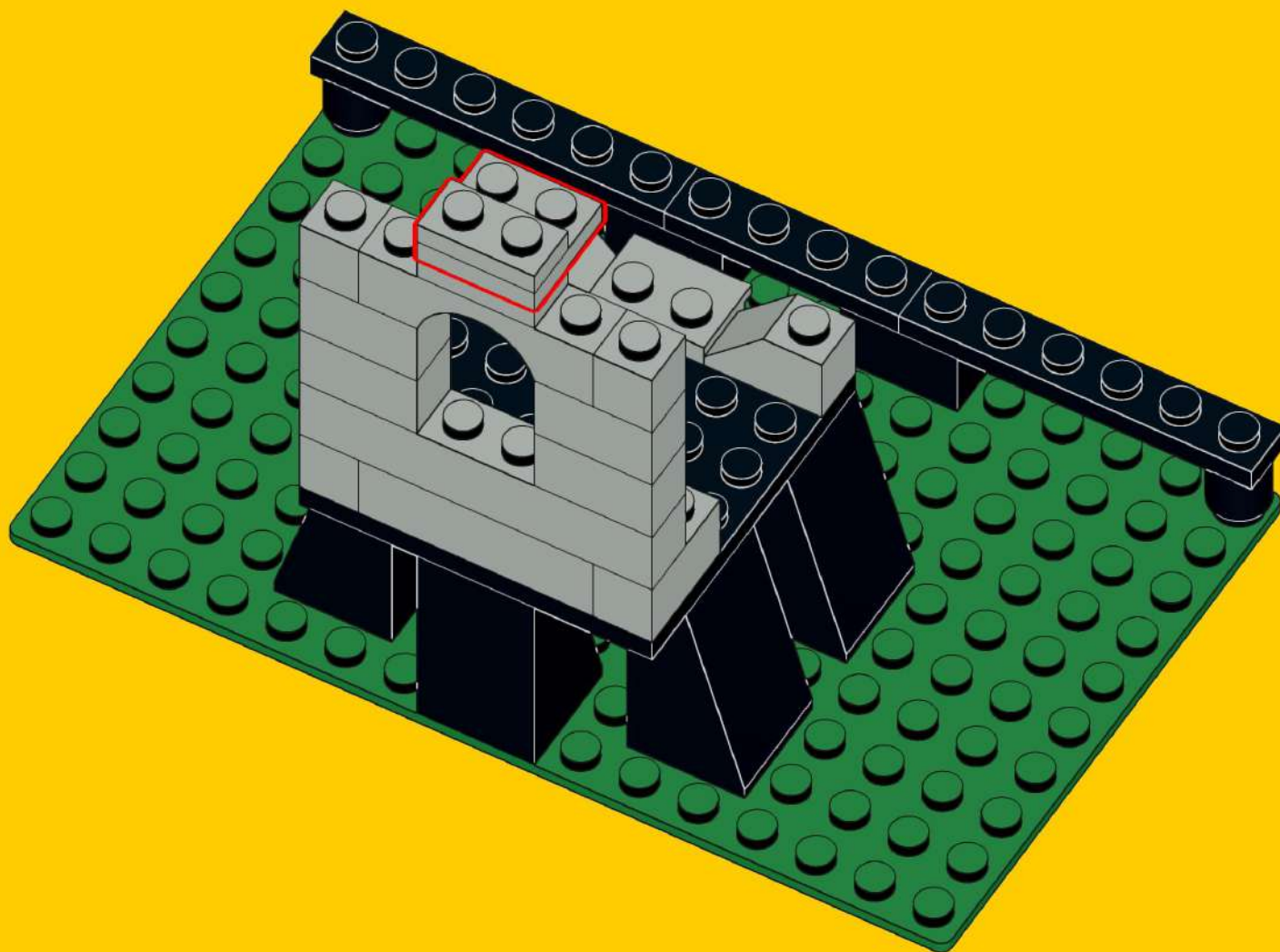
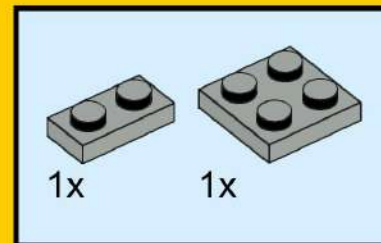

# 48

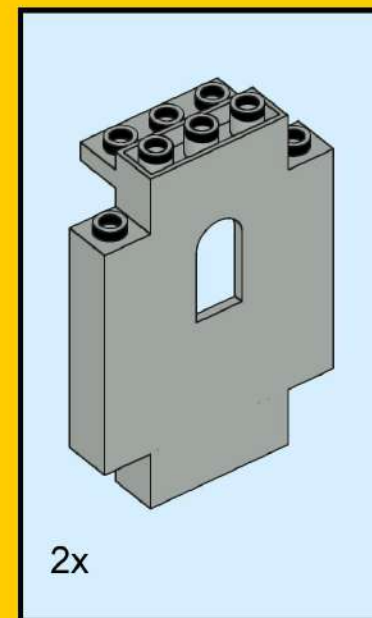
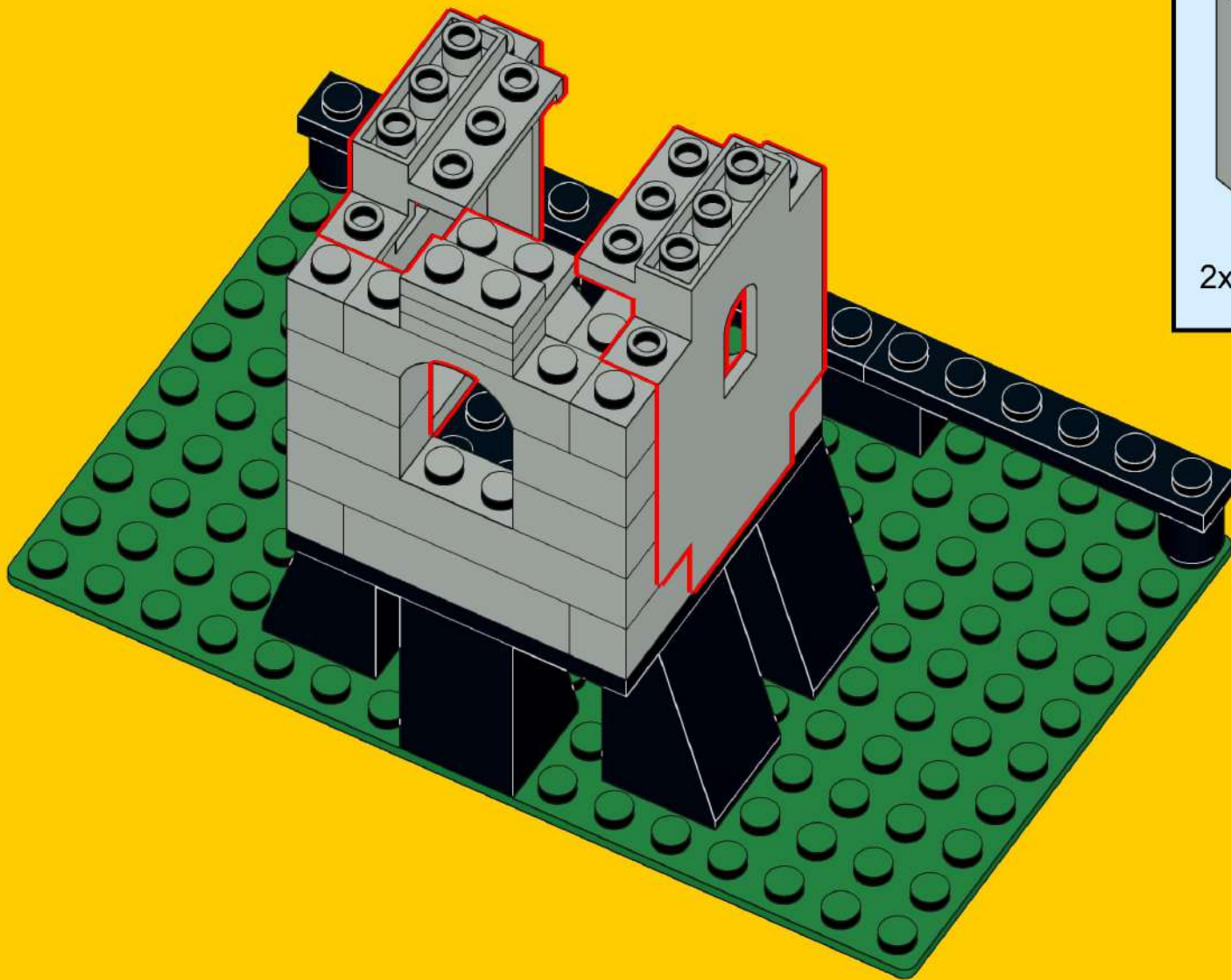



# 49

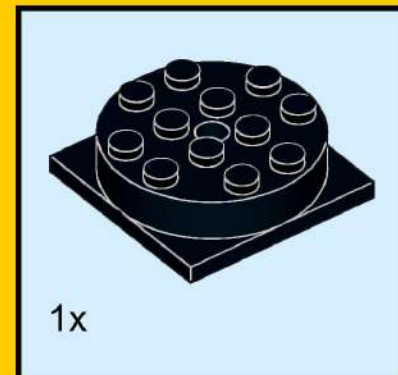
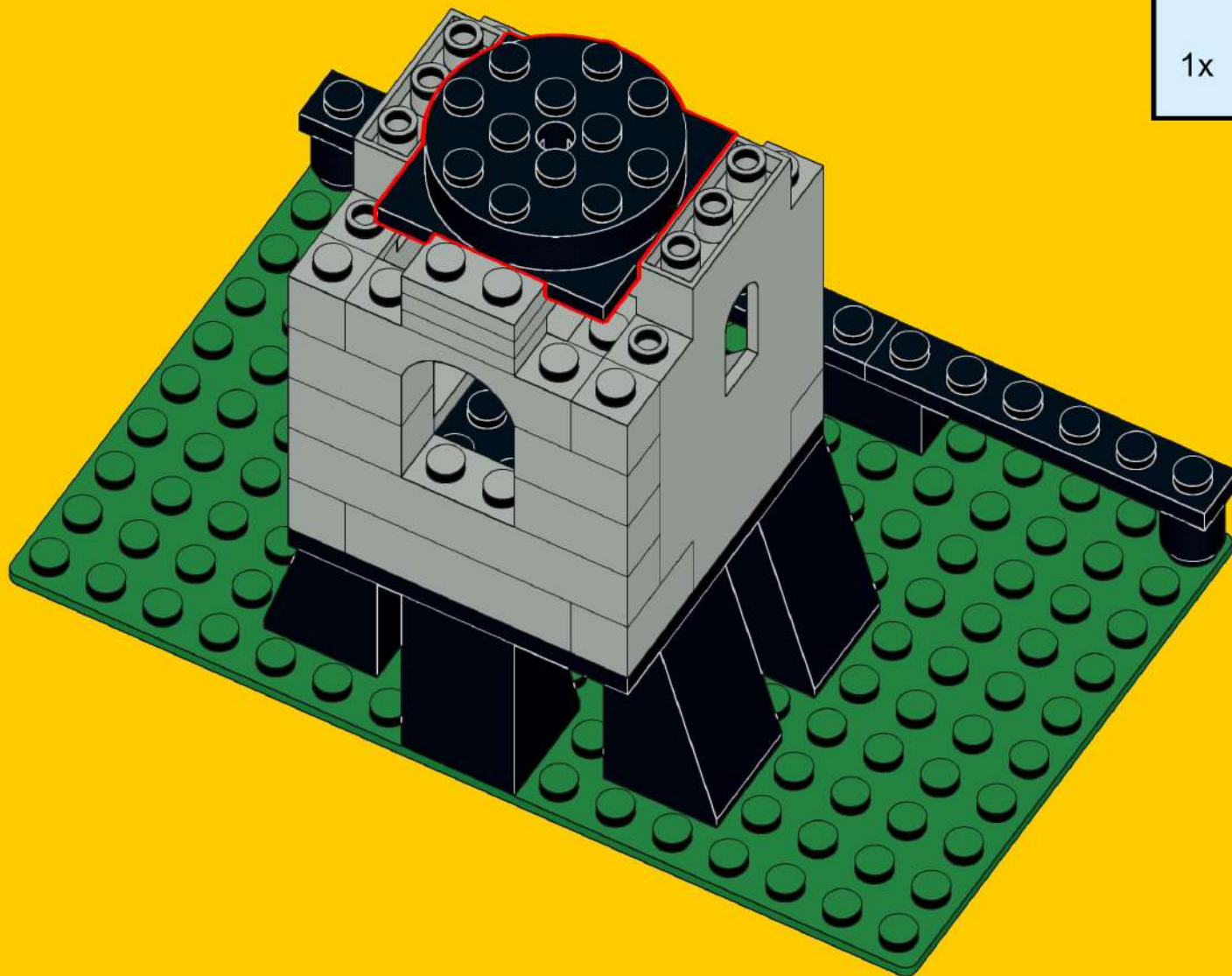

# 50

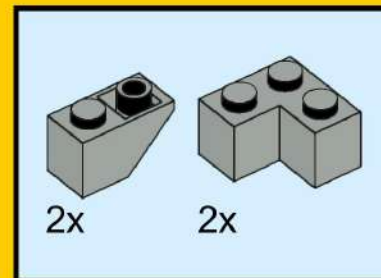
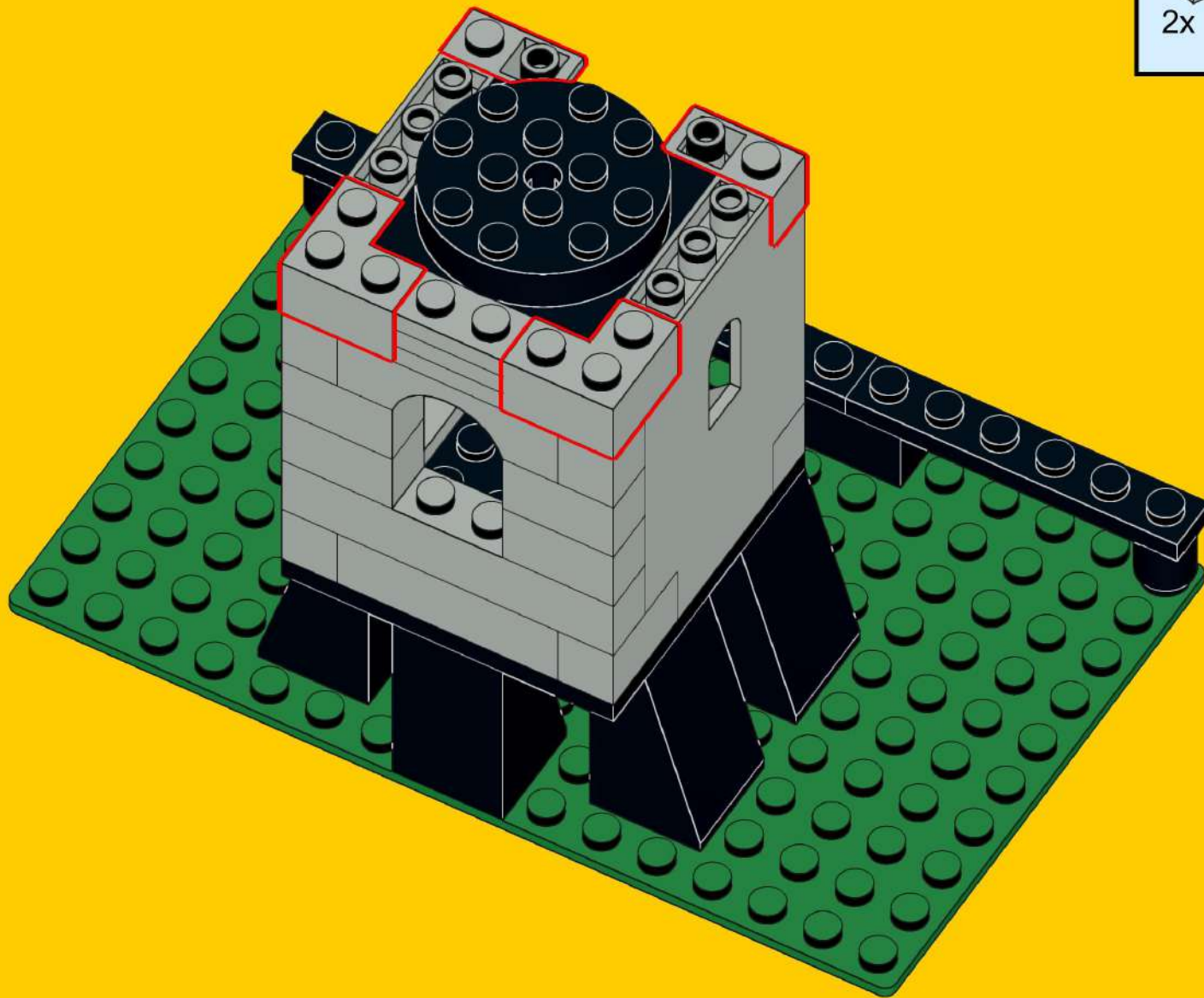

# 51

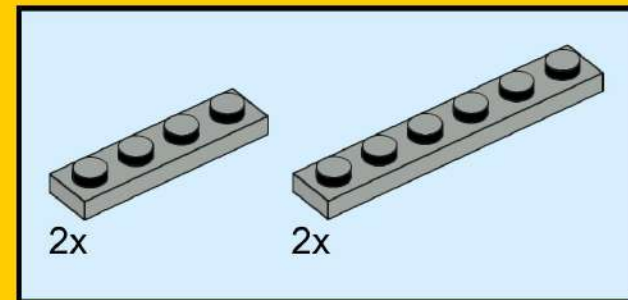
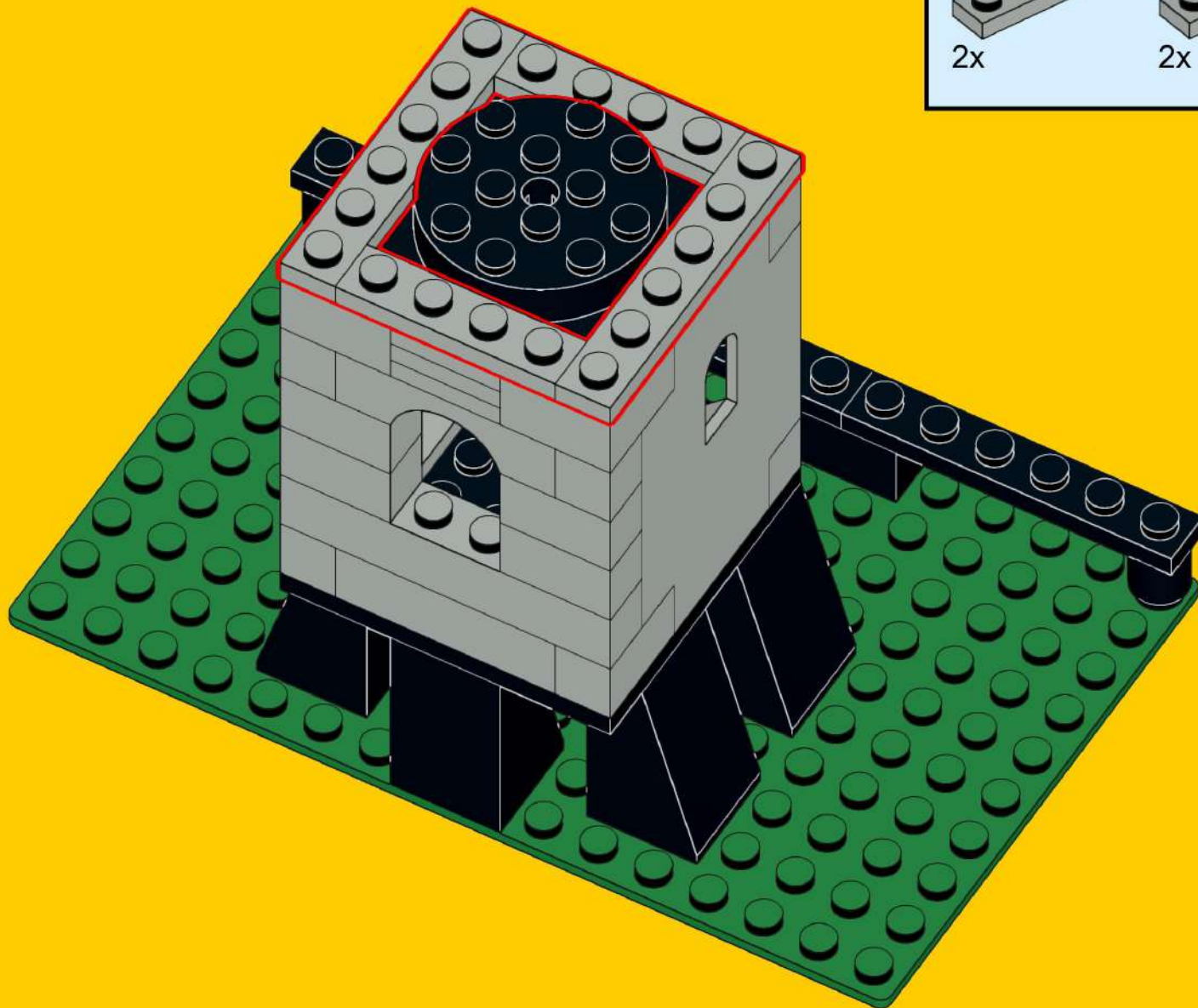

# 52

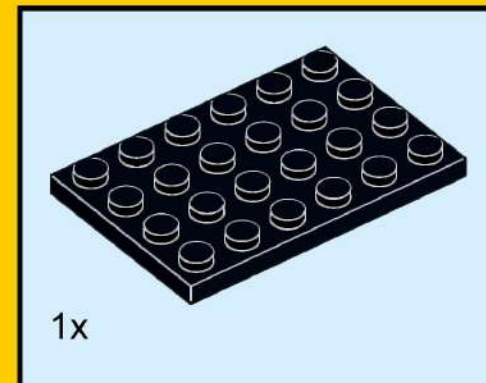
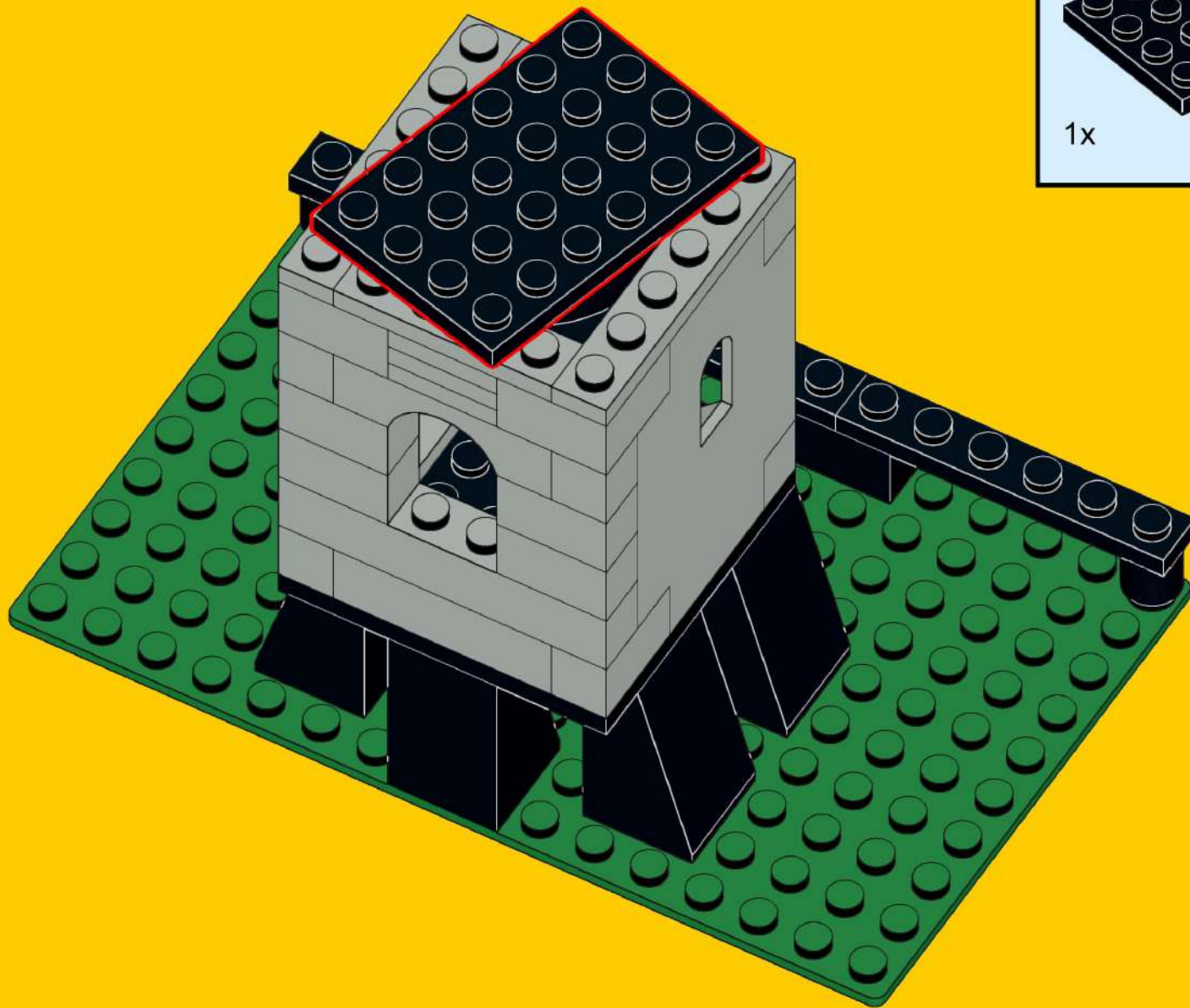

# 53

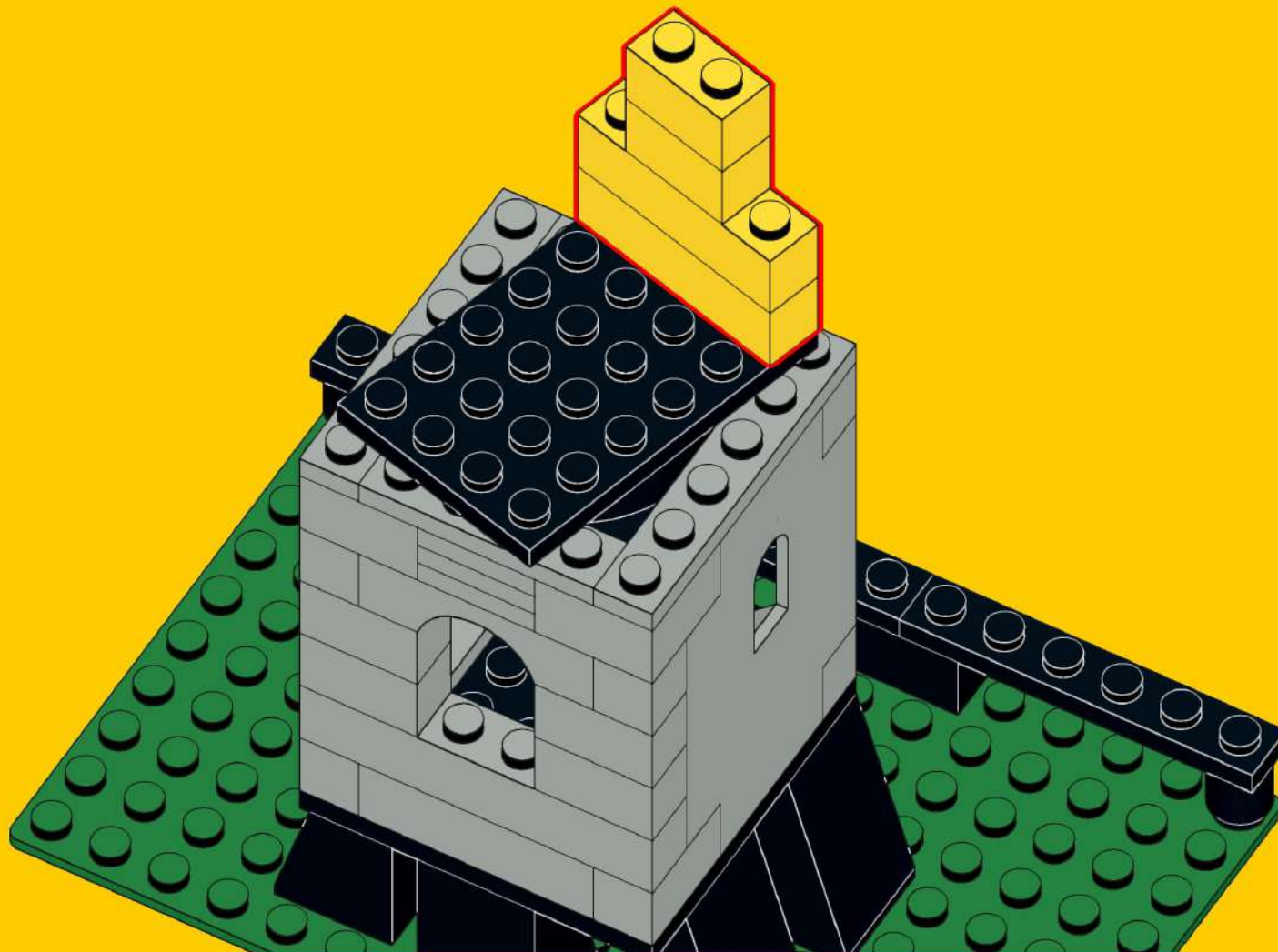
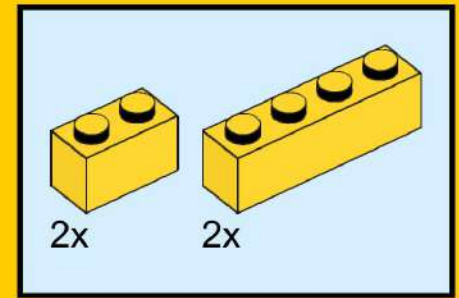

# 54

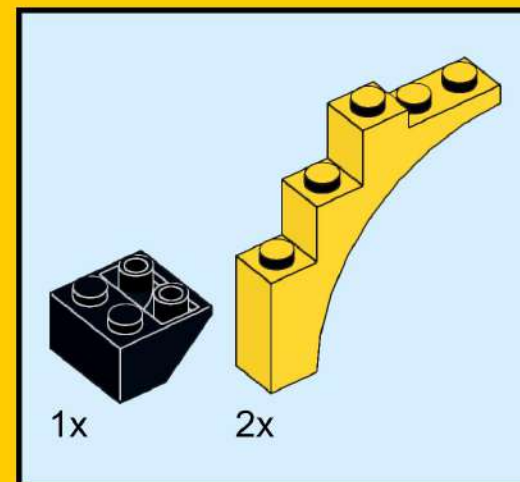
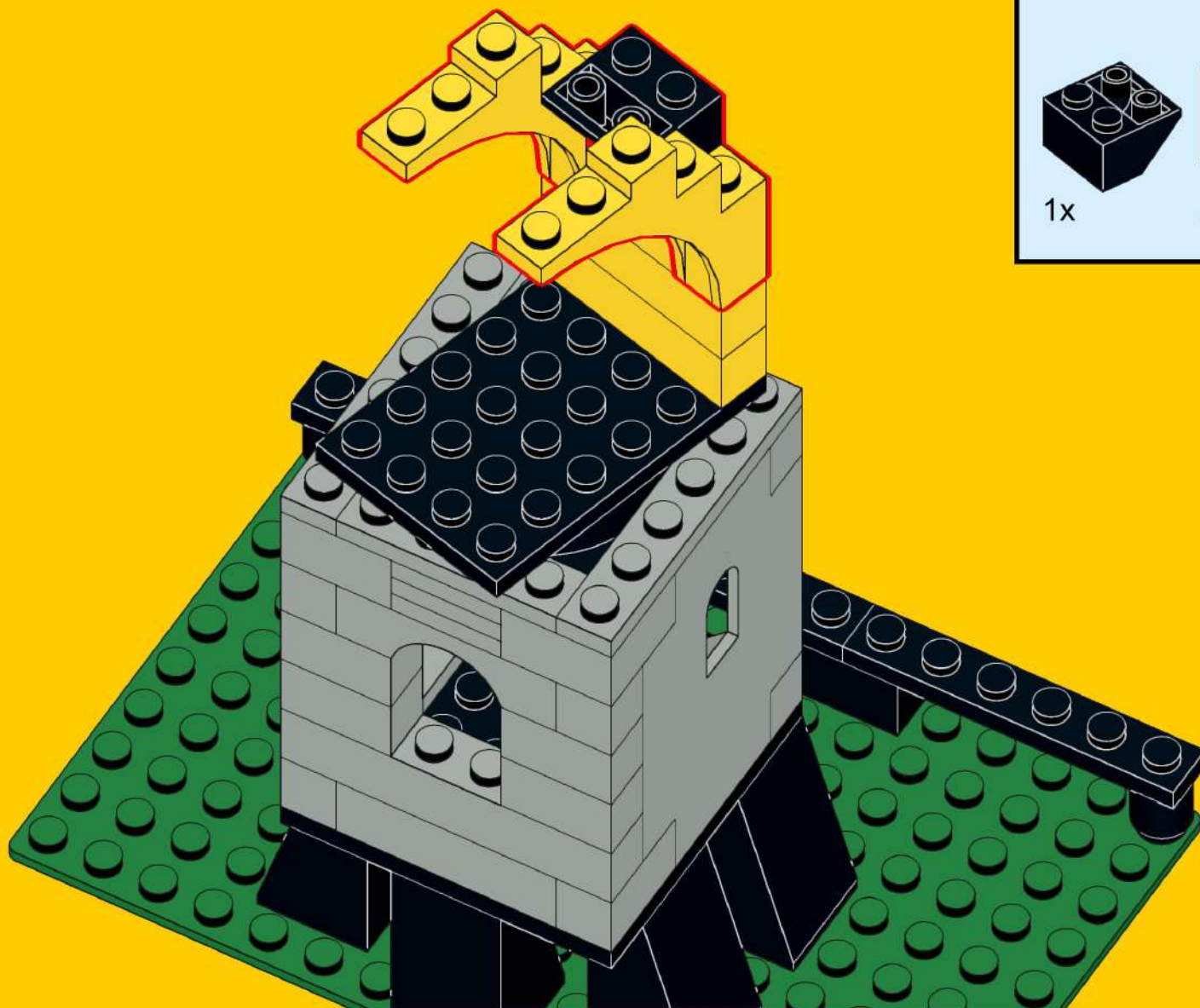

# 55

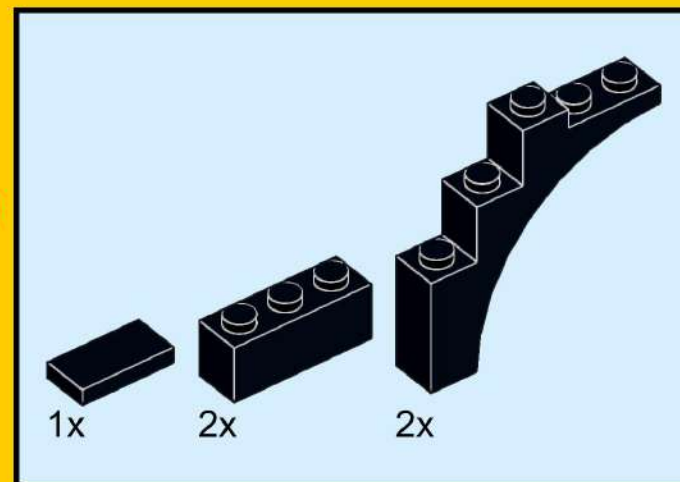
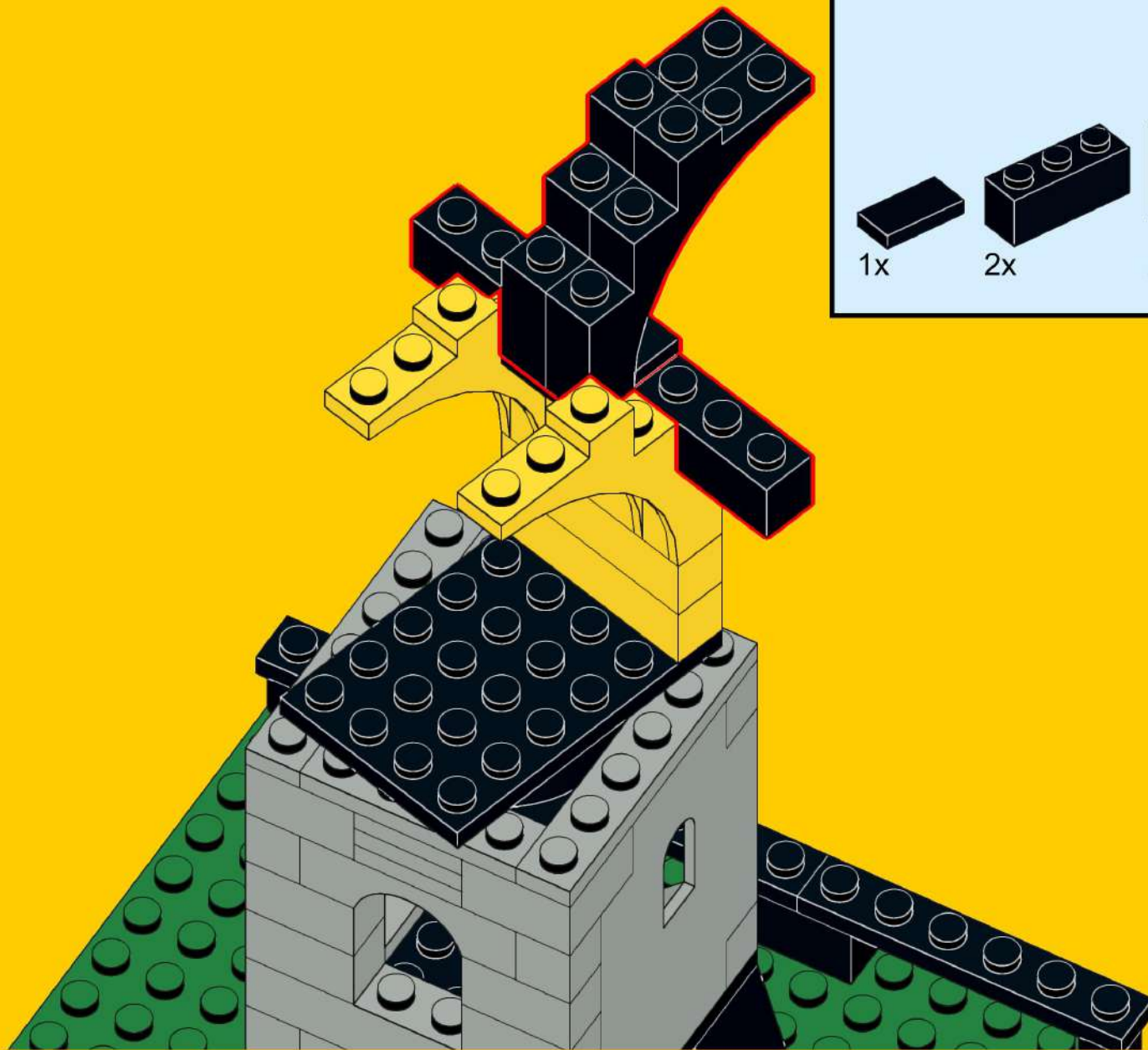

# 56

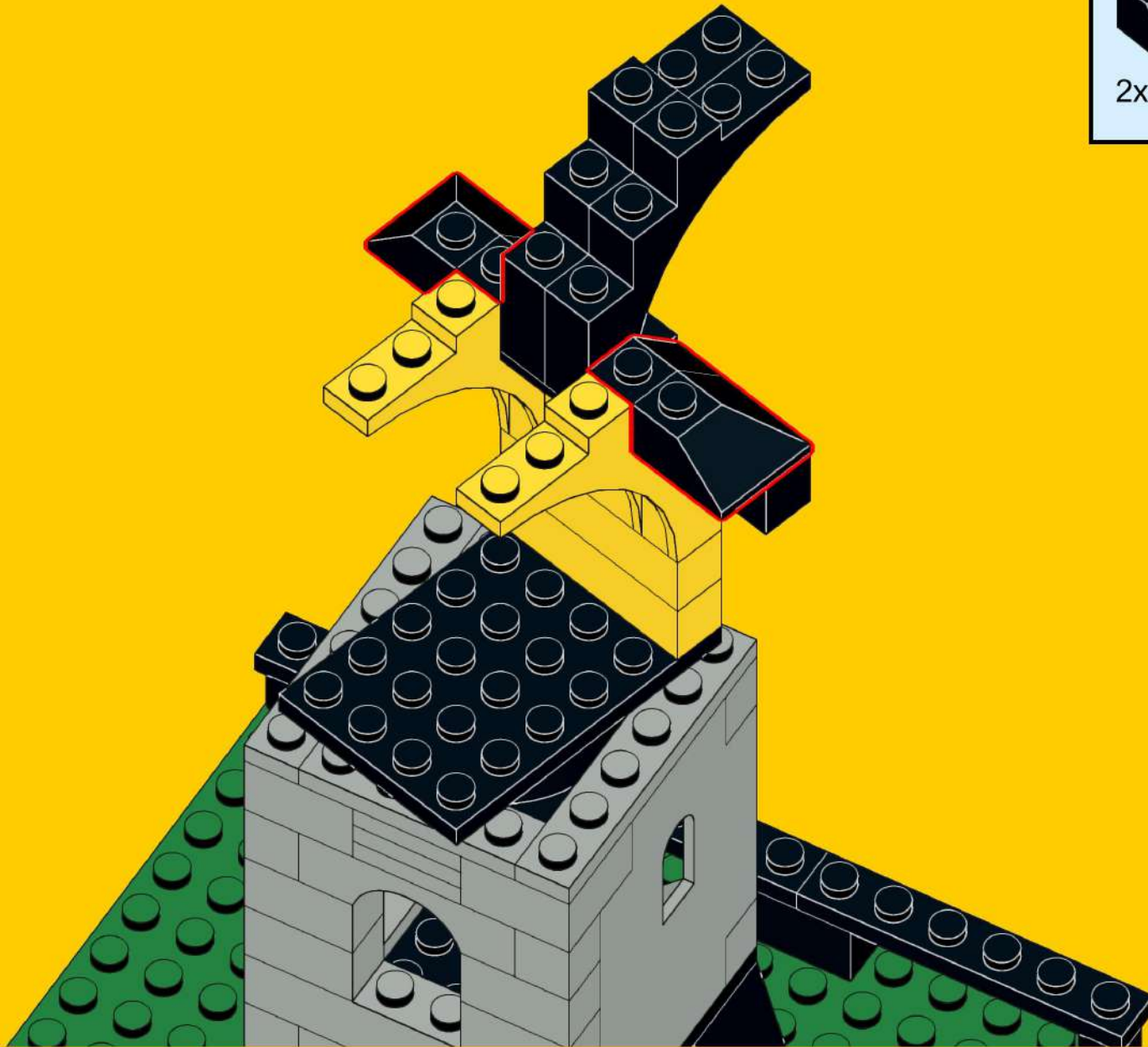
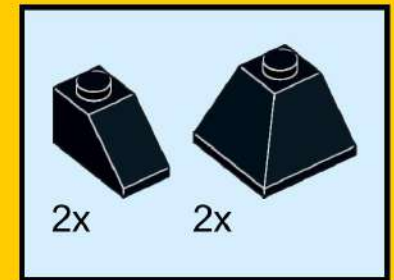



# 57

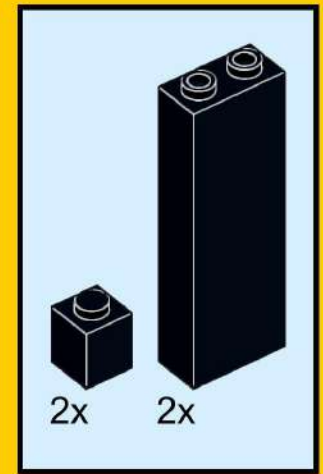
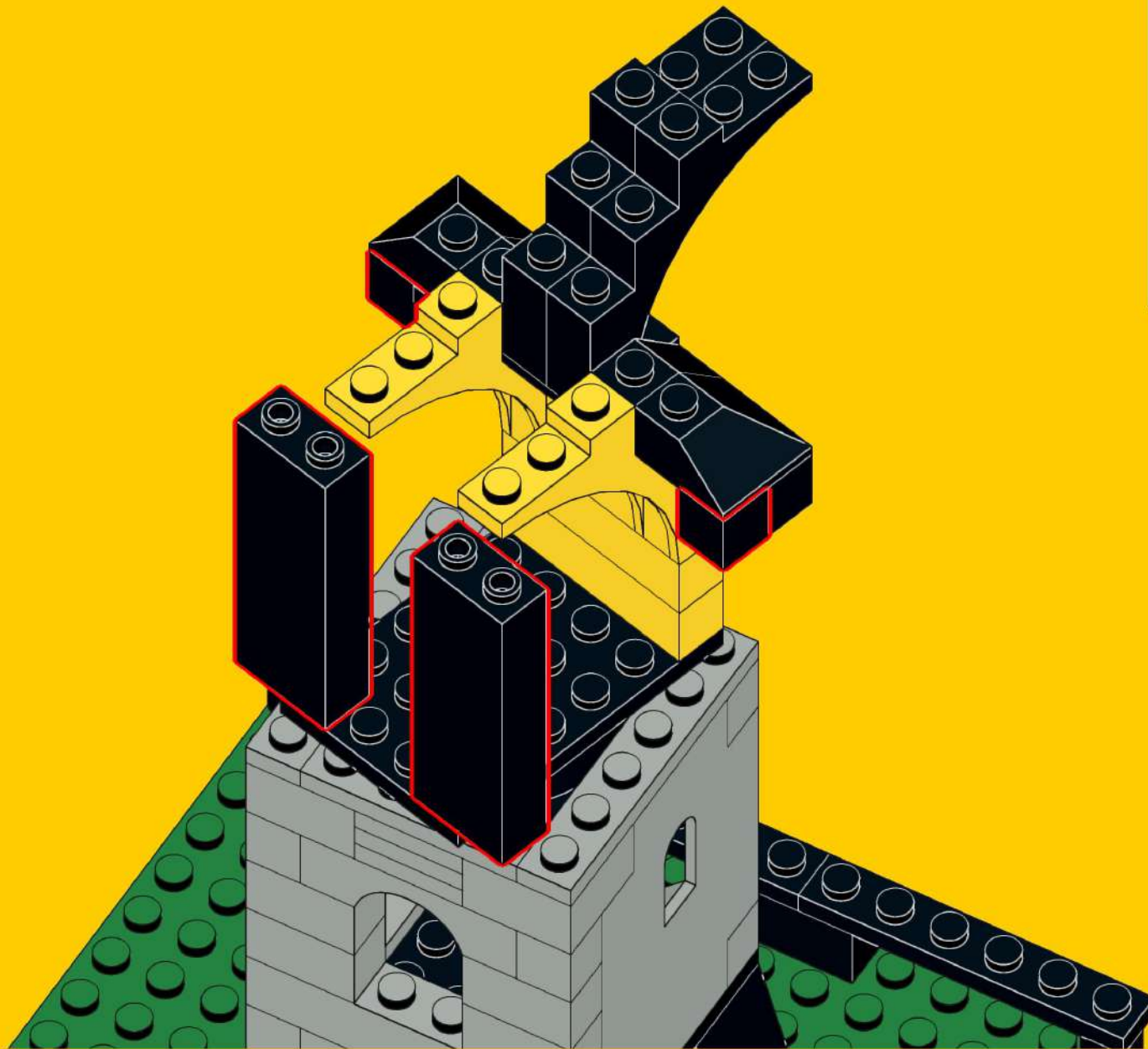

# 58

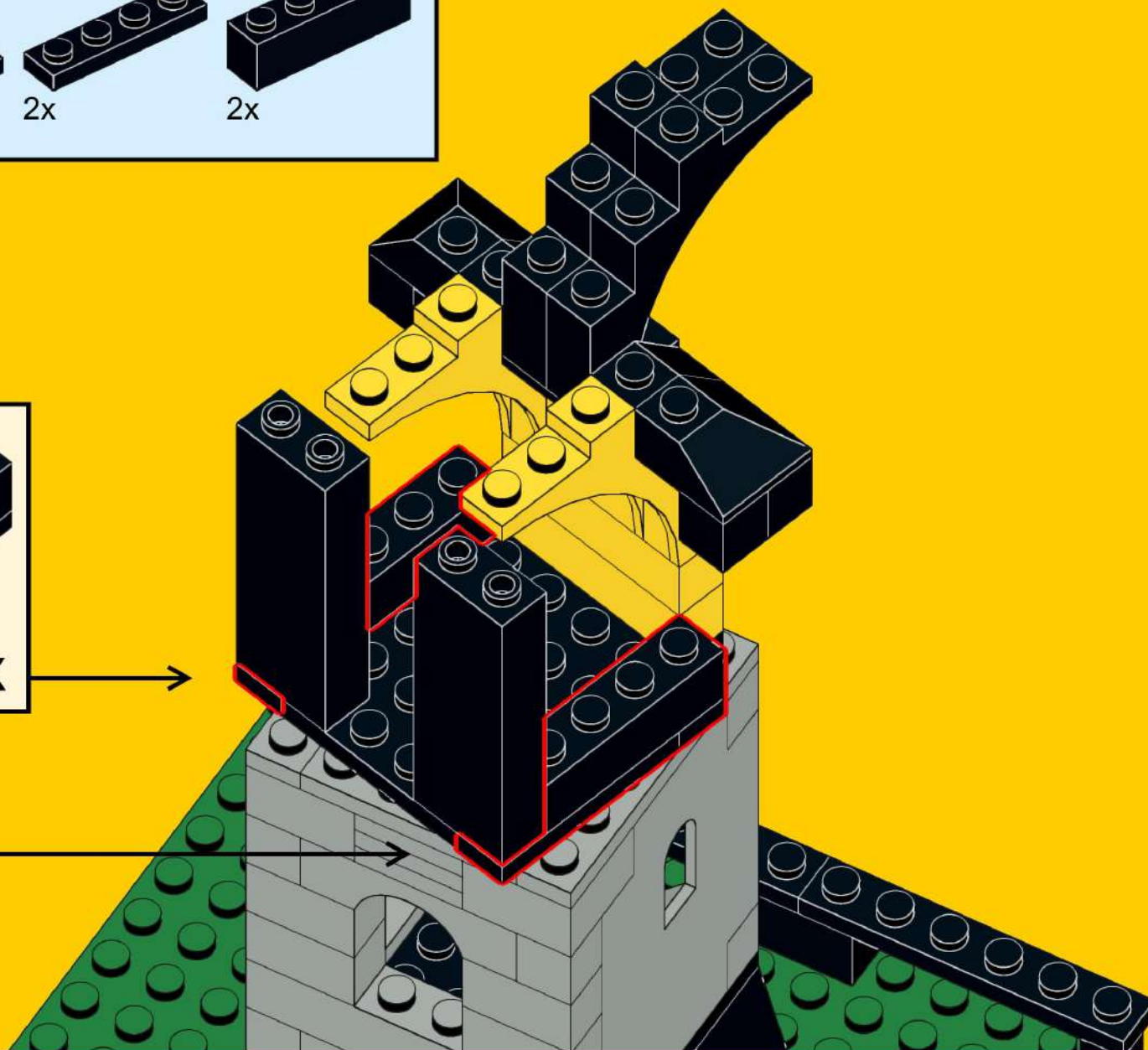
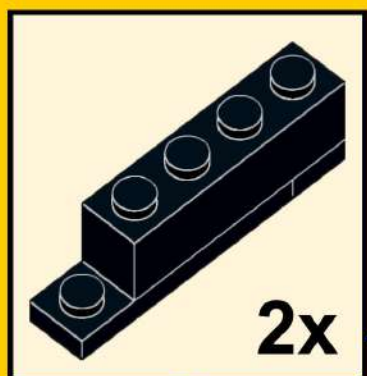
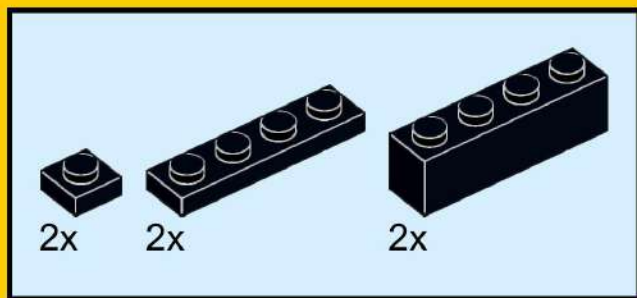

# 59

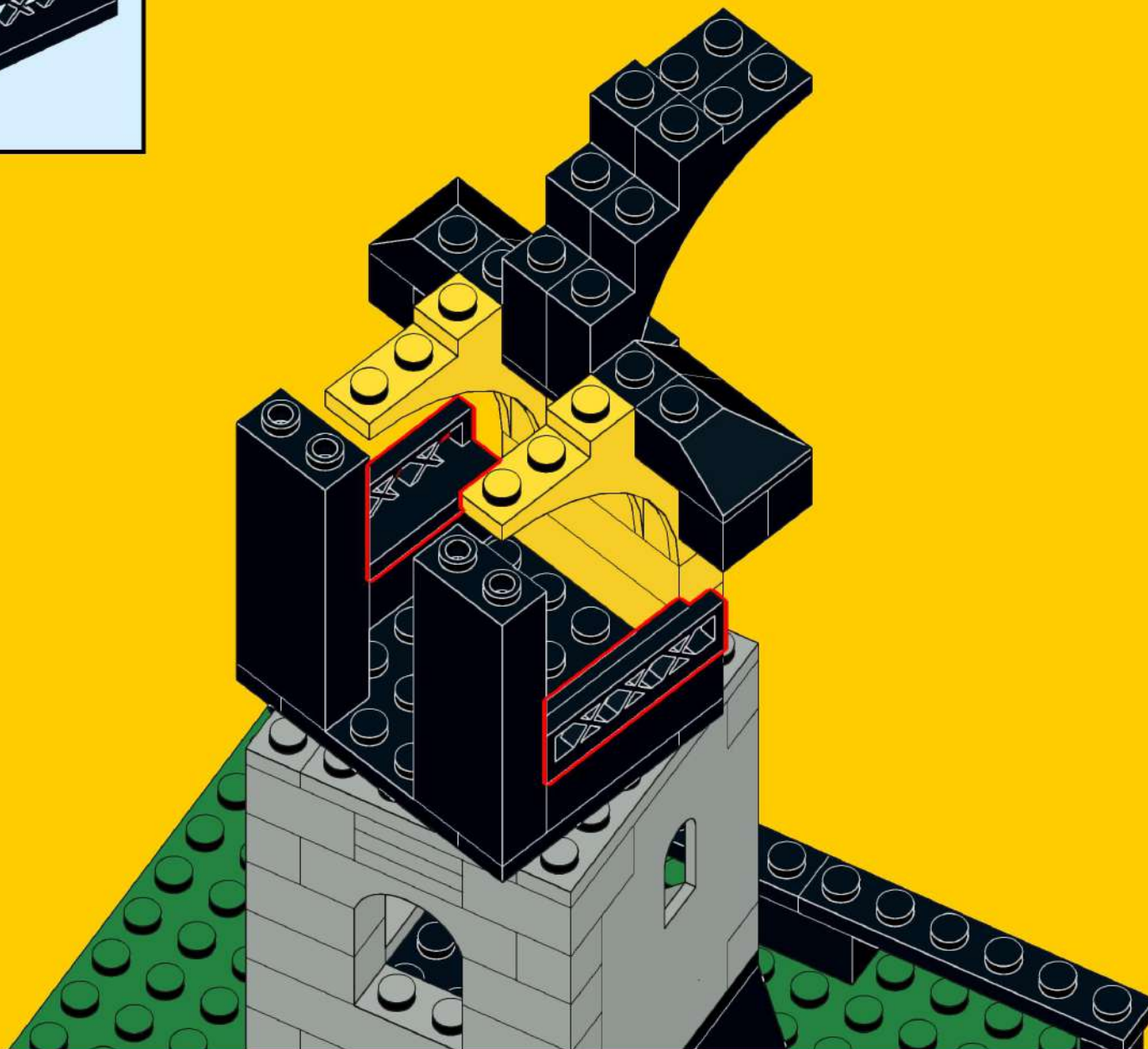
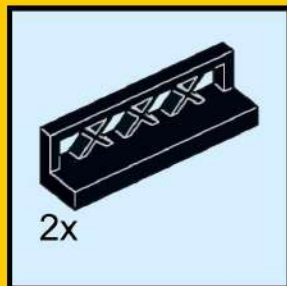

# 60

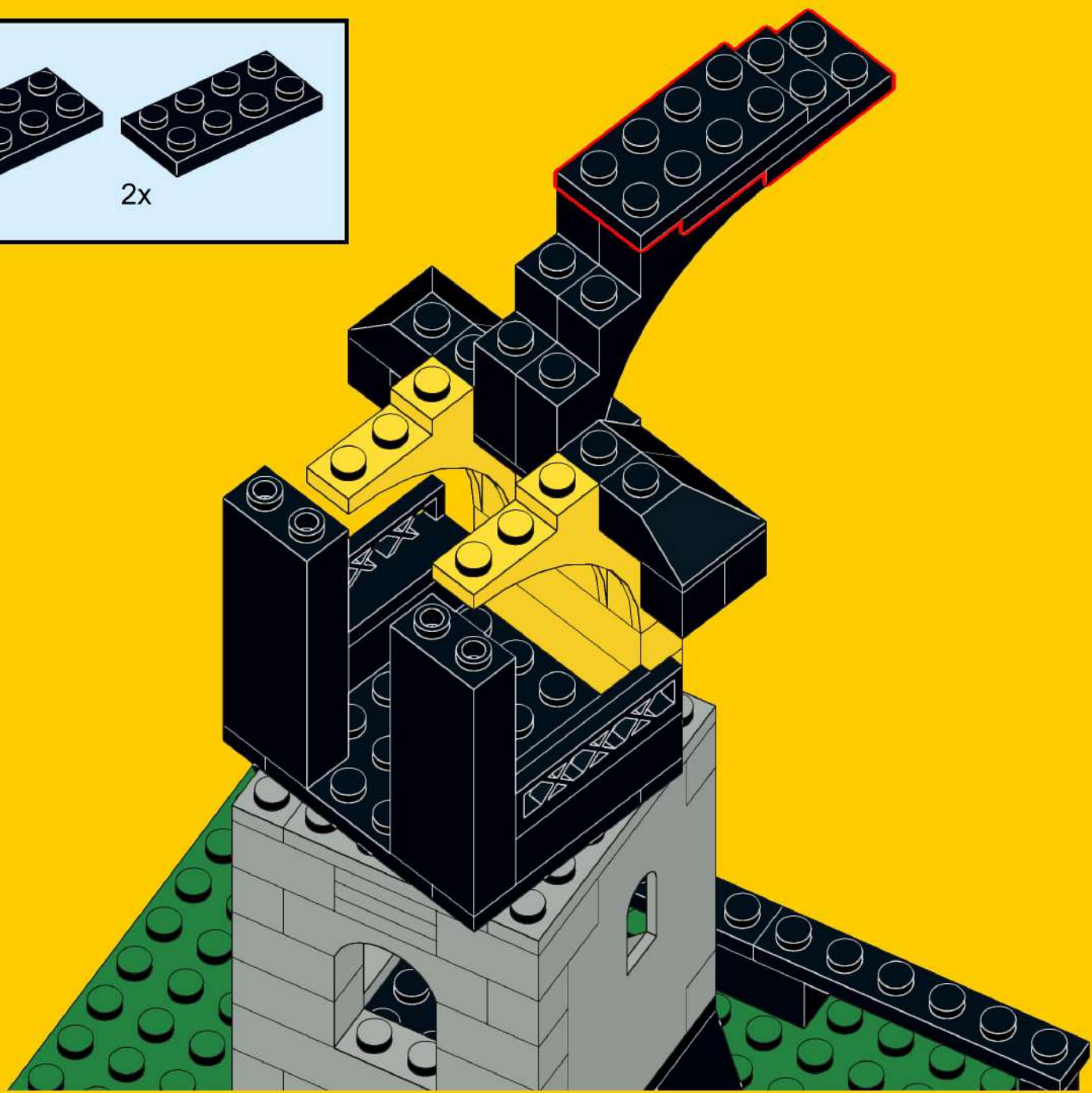
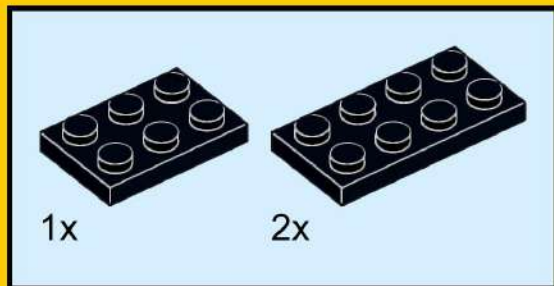

# 61

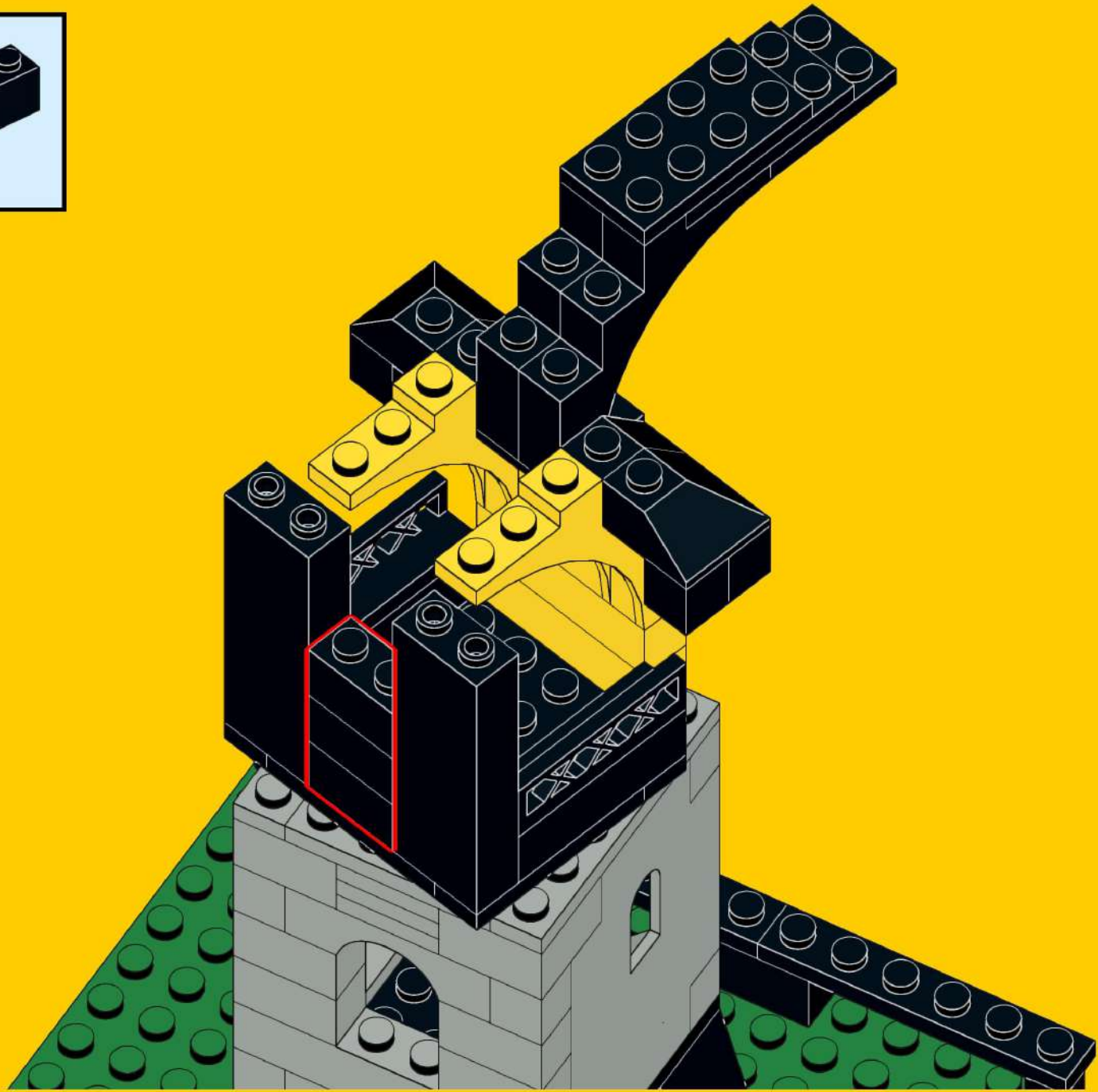
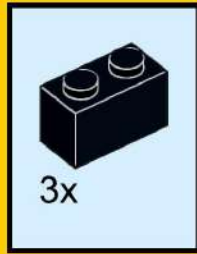

62

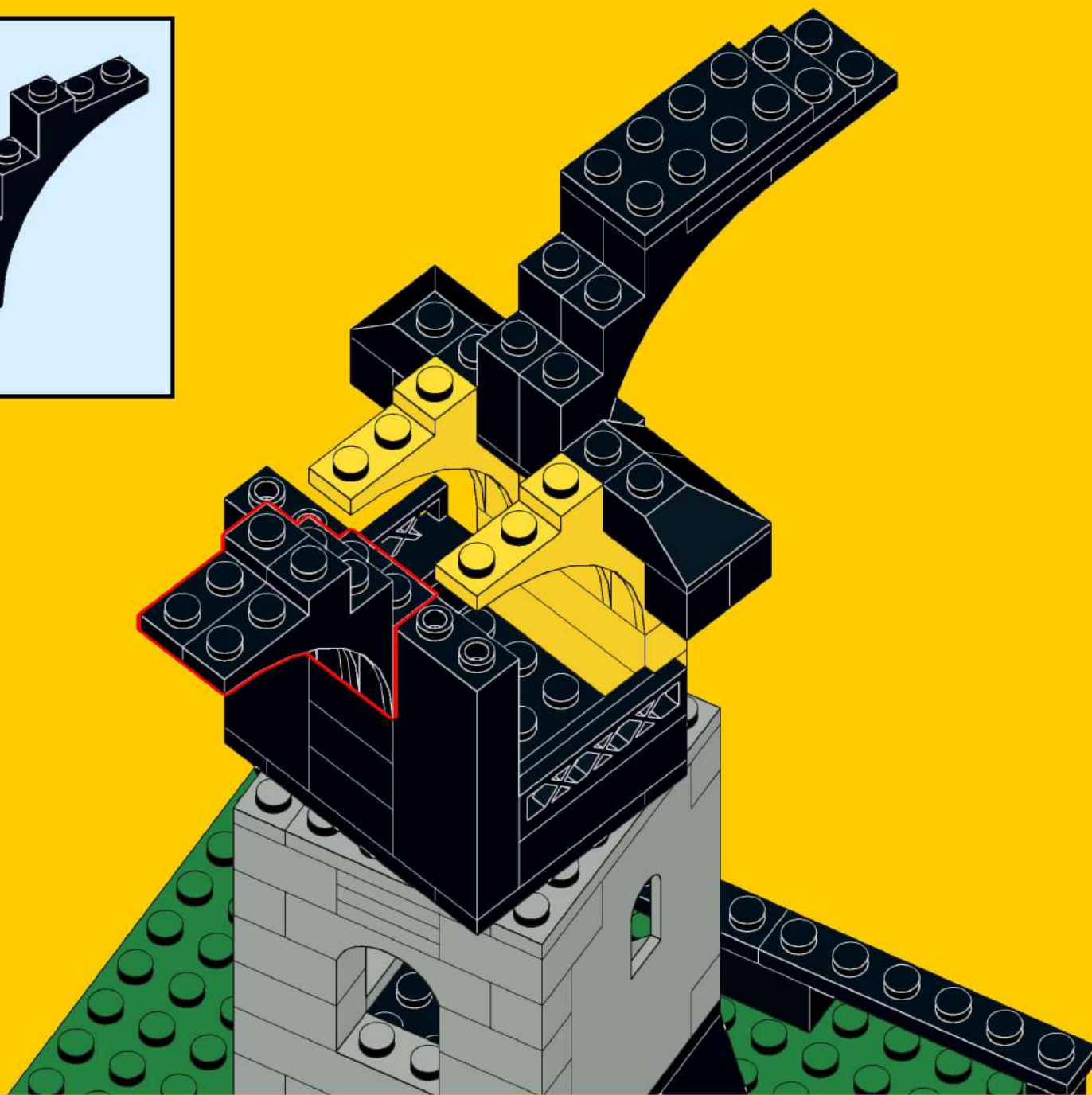
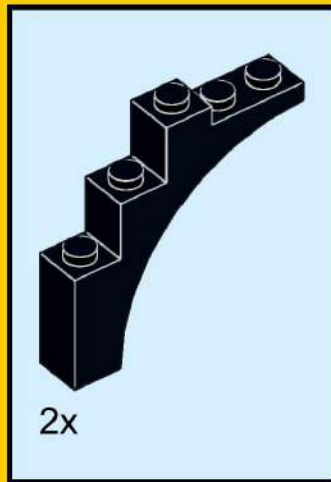

# 63

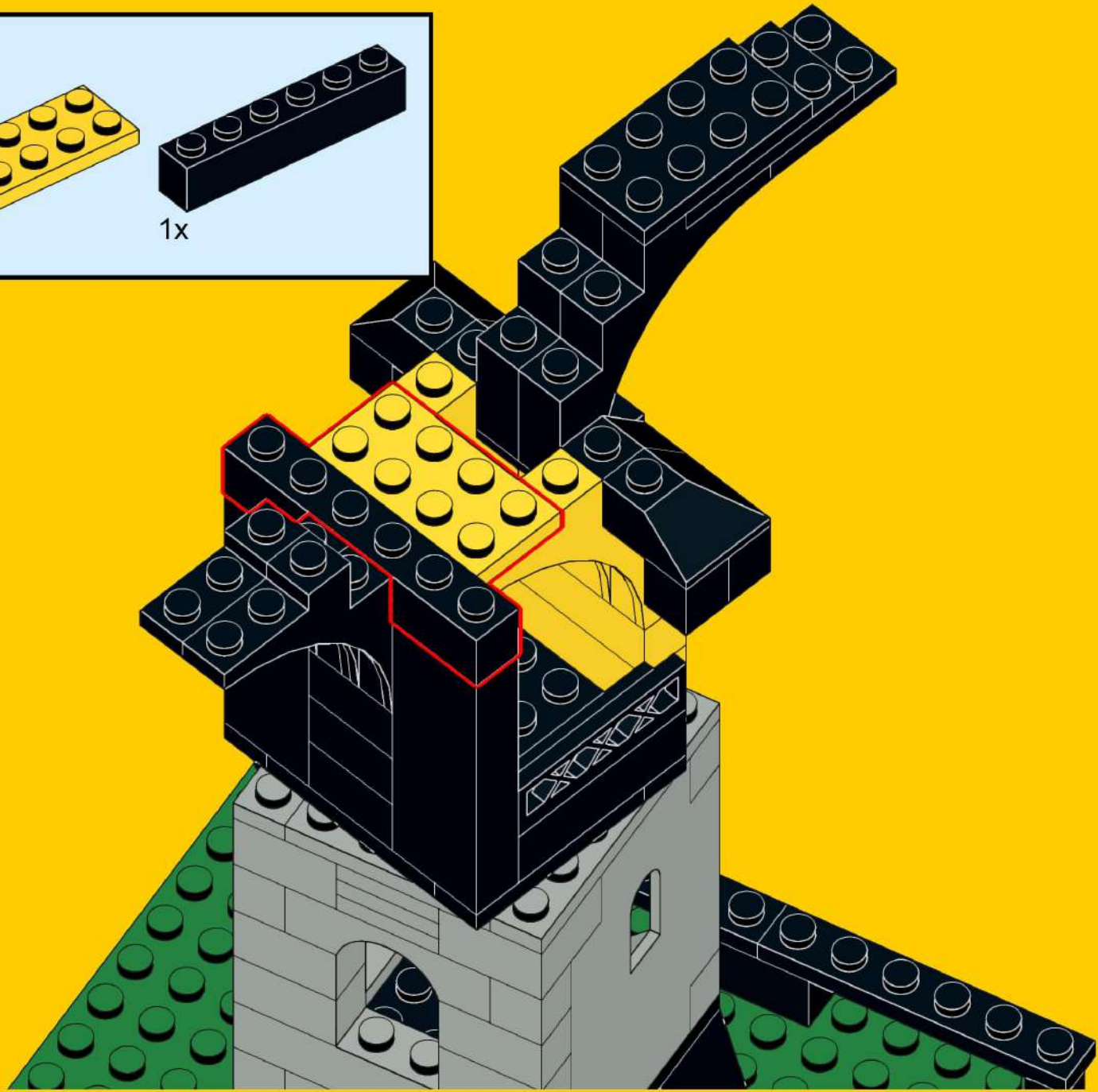
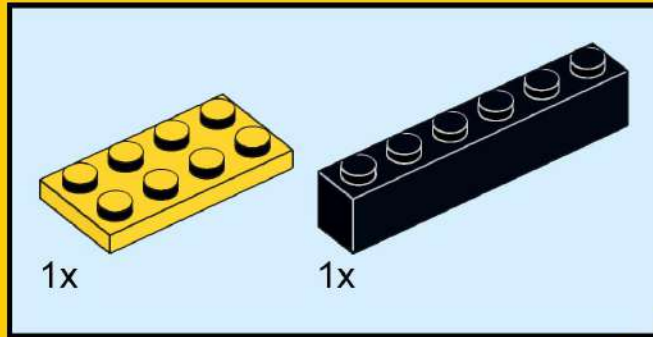

# 64

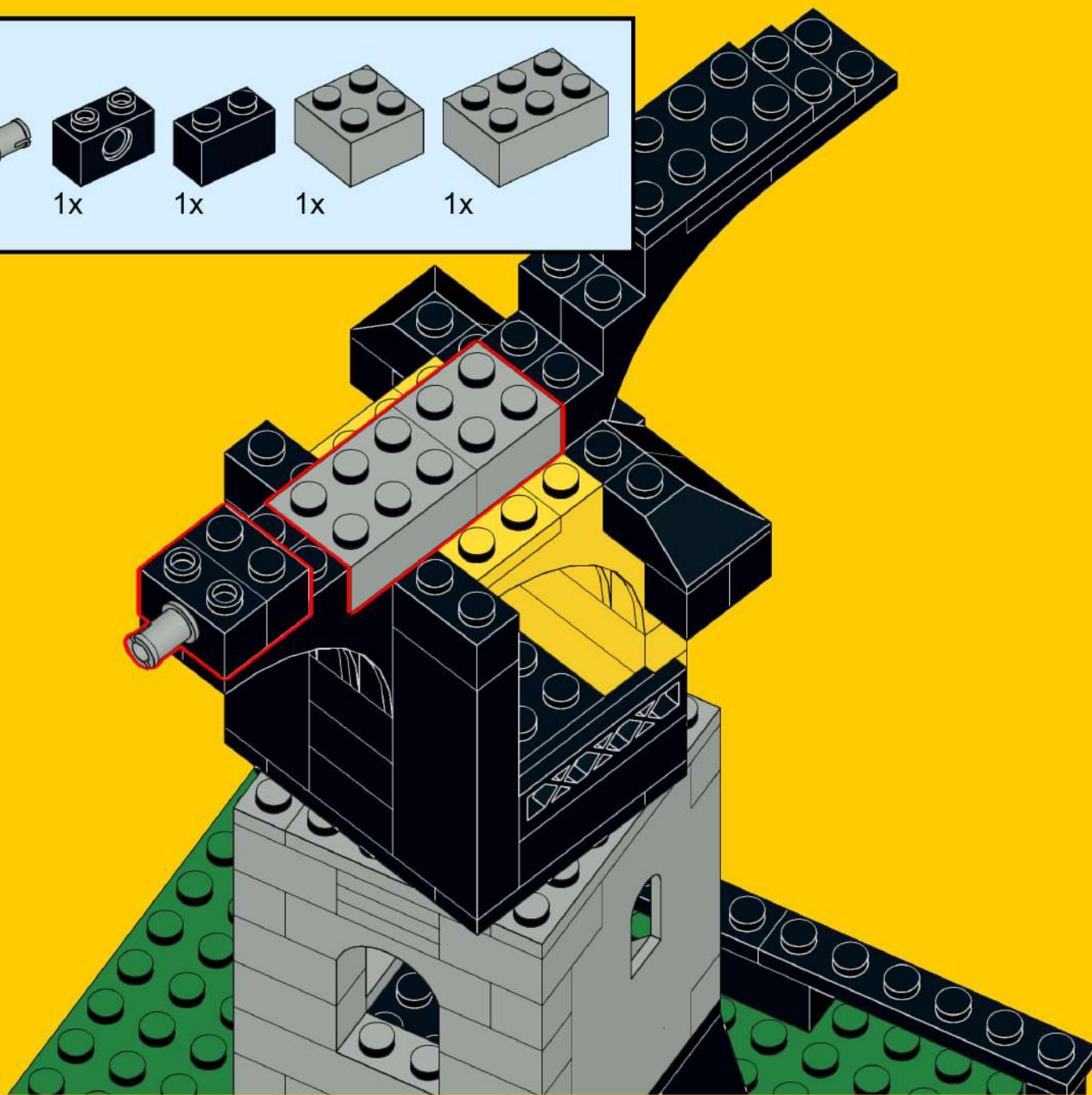
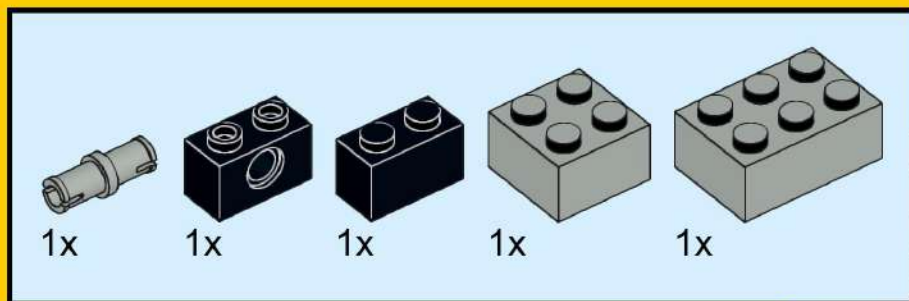



# 65

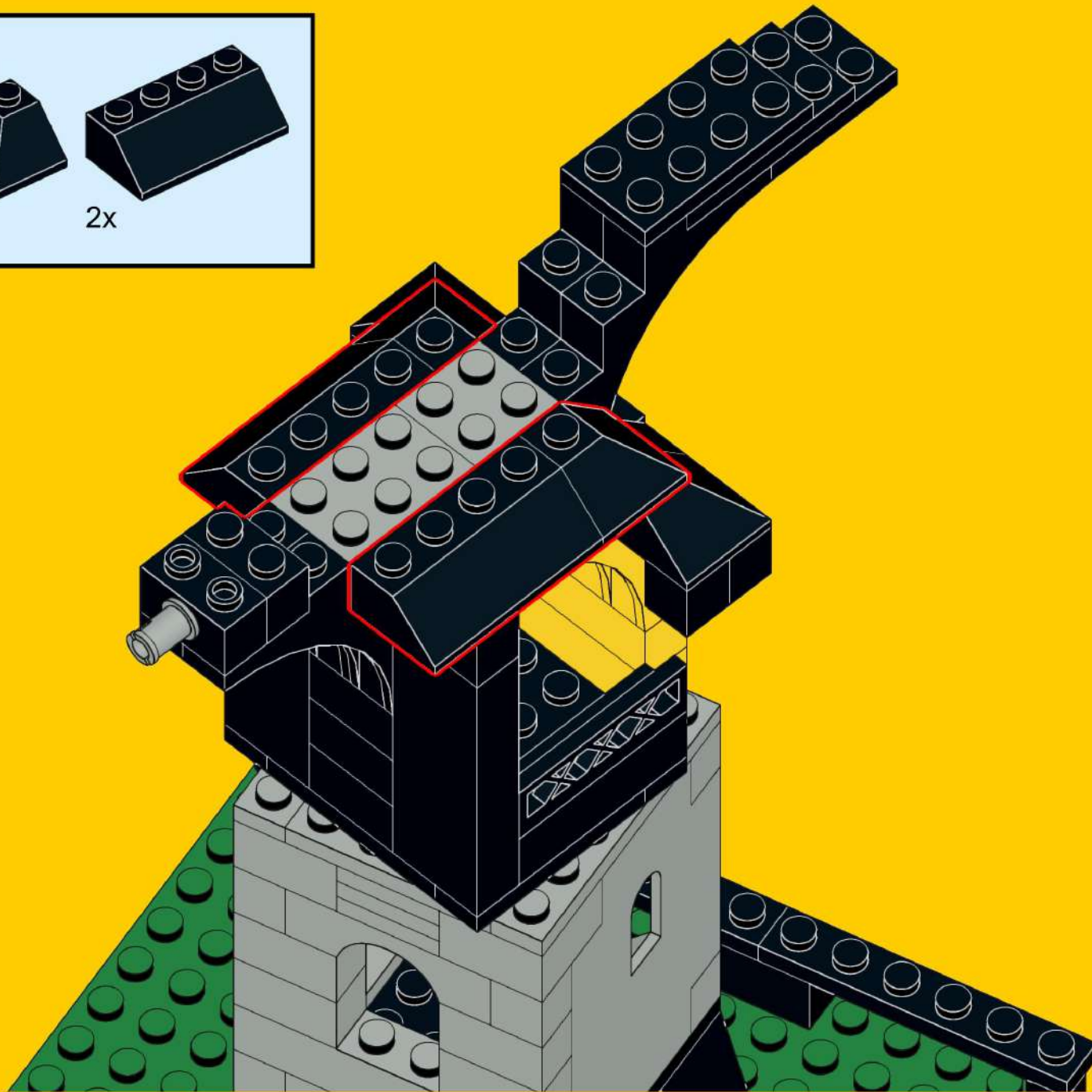
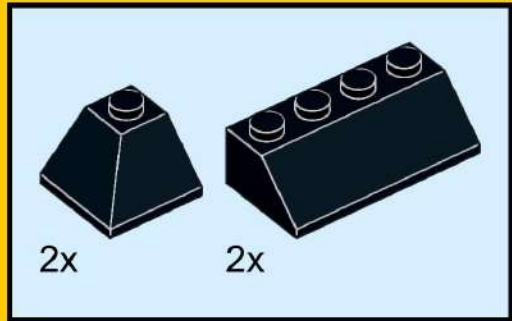

# 66

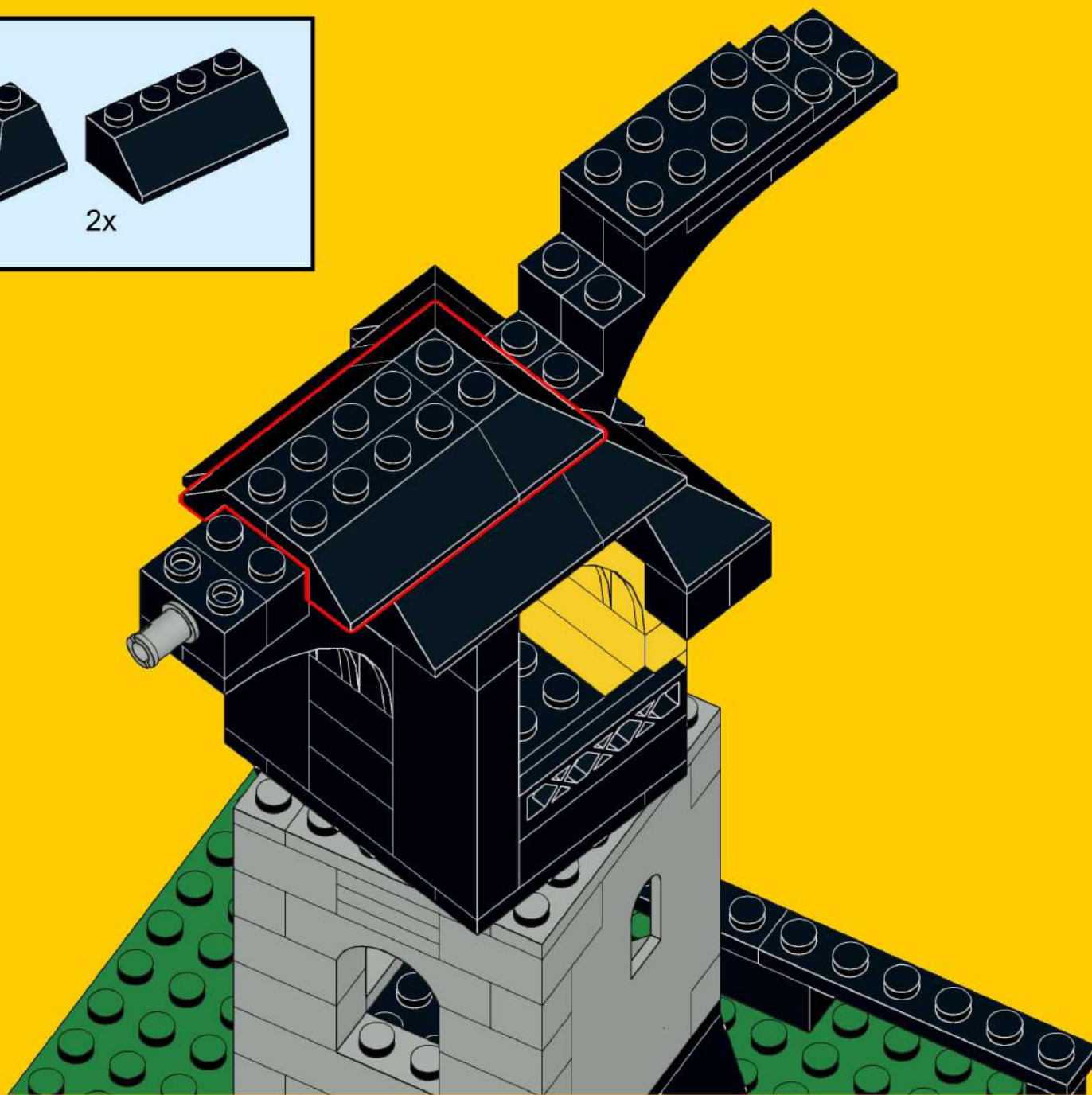
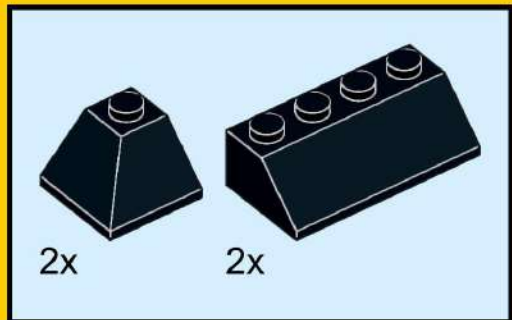

# 67

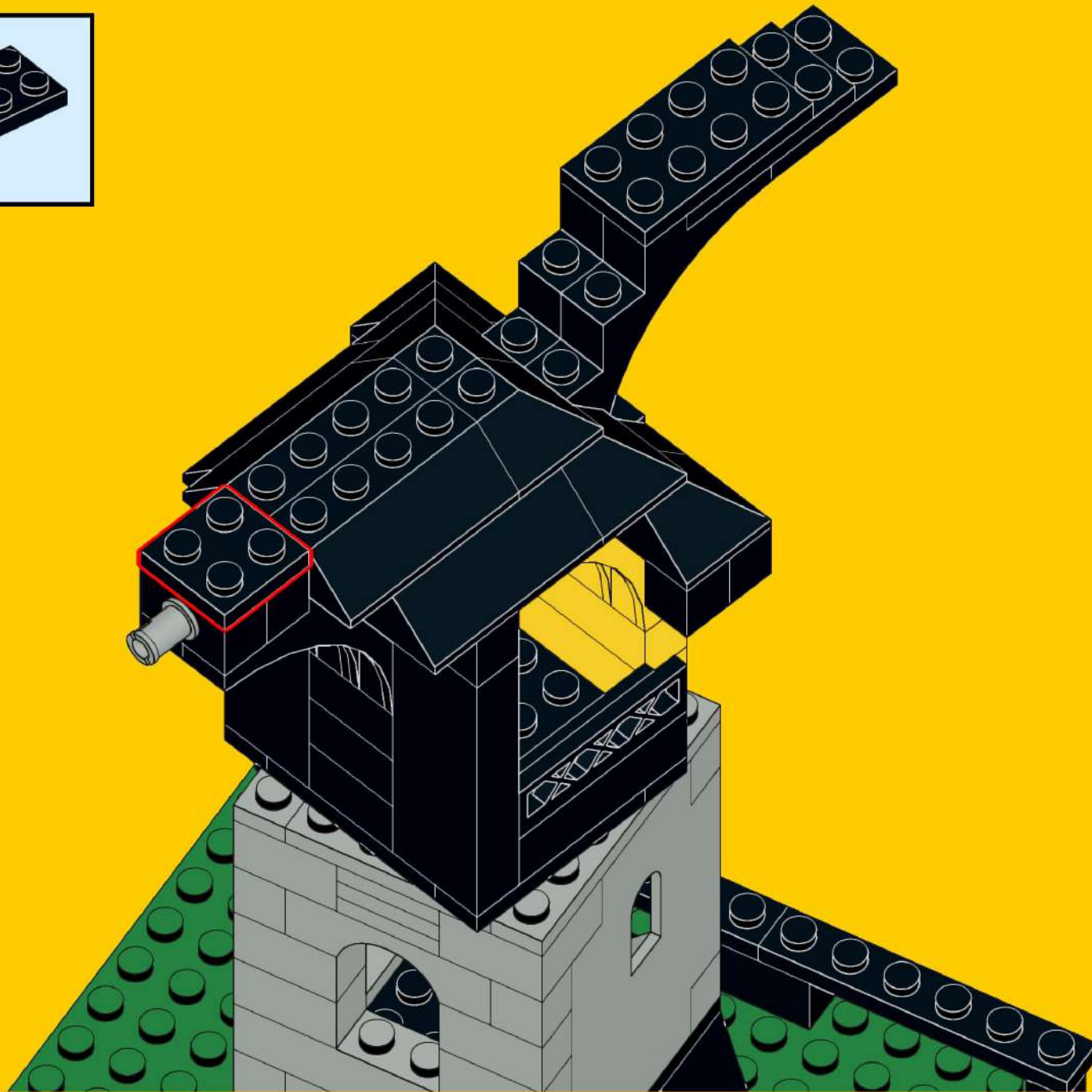
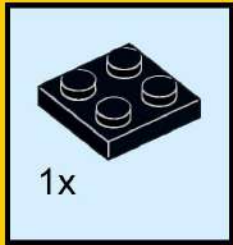

# 68

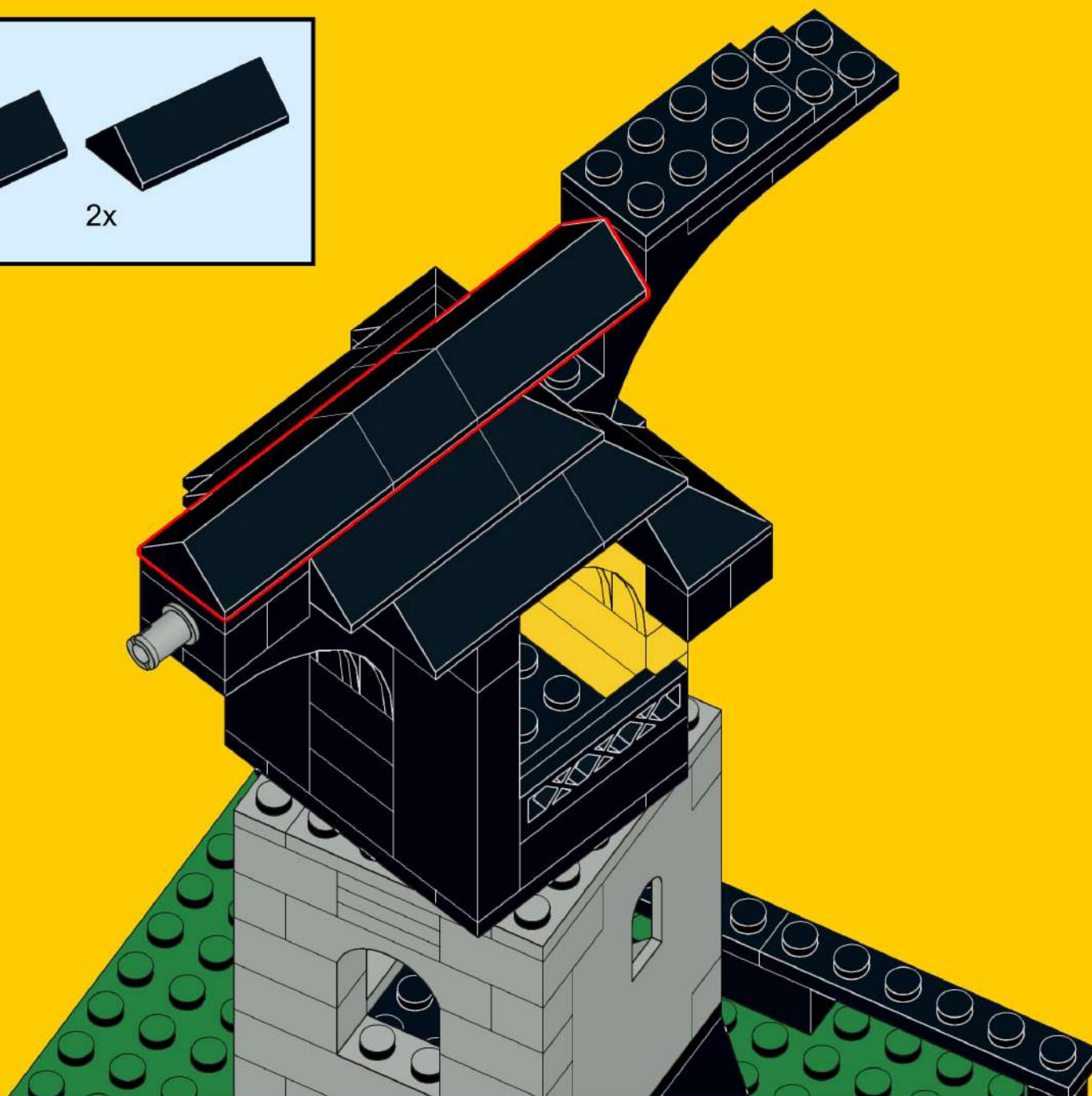
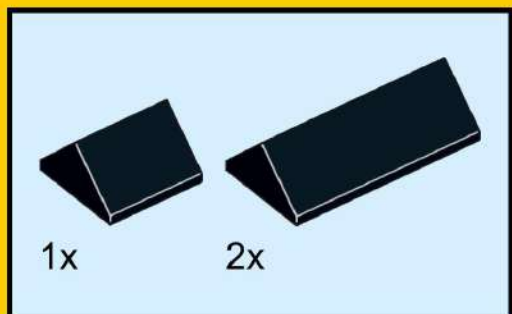

# 69

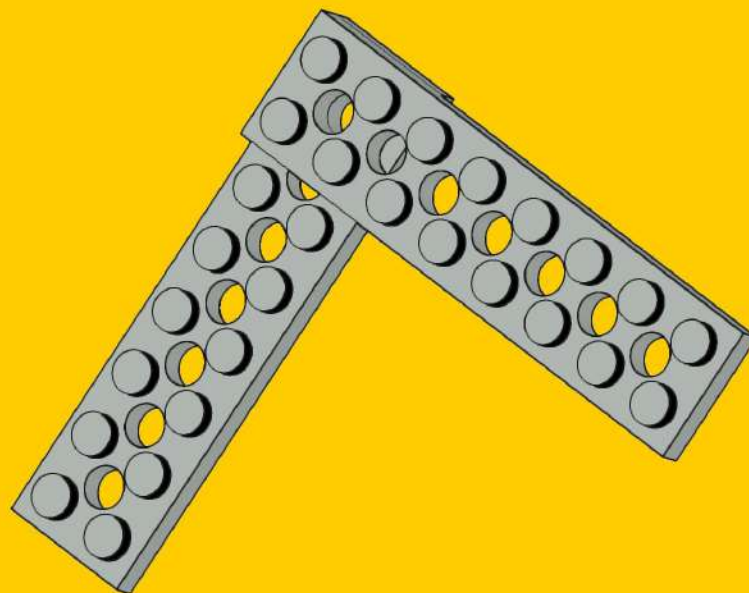
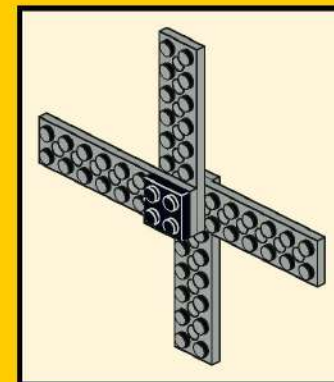
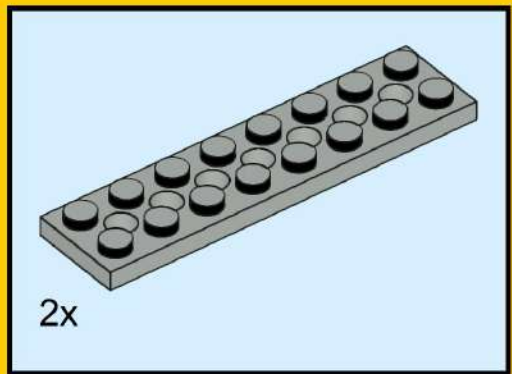

# 70

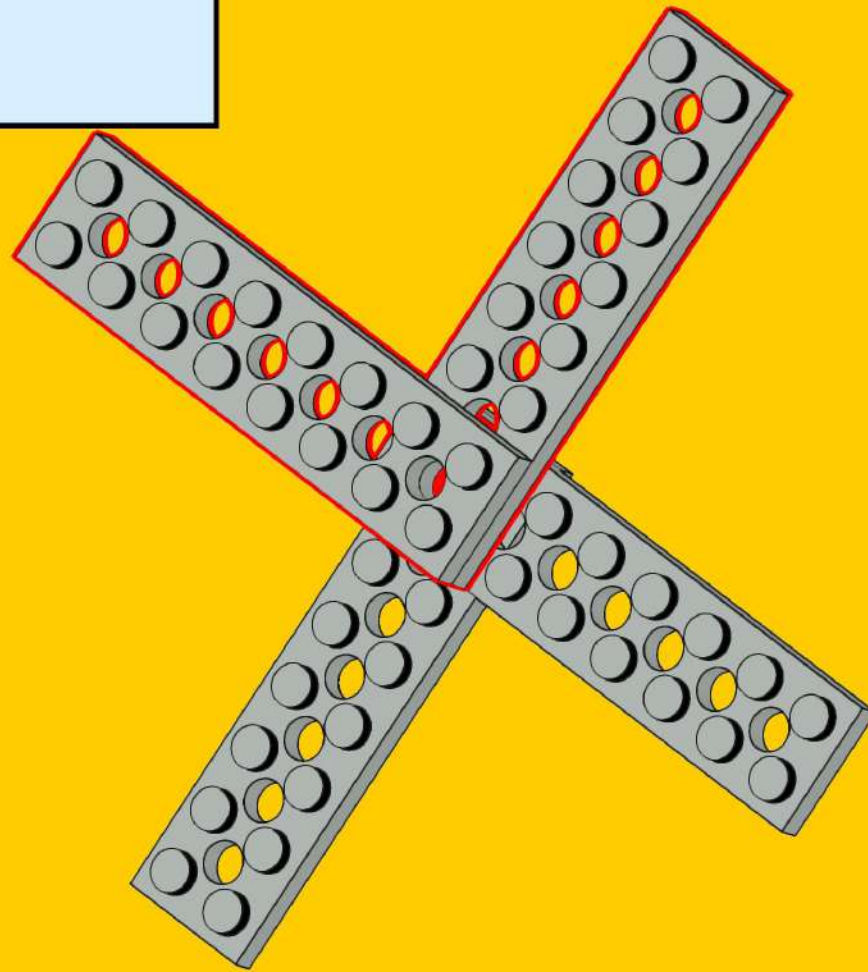
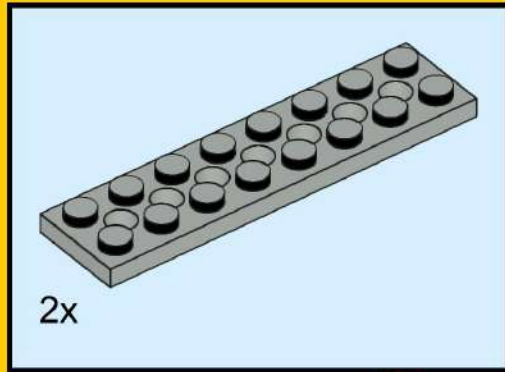

# 71

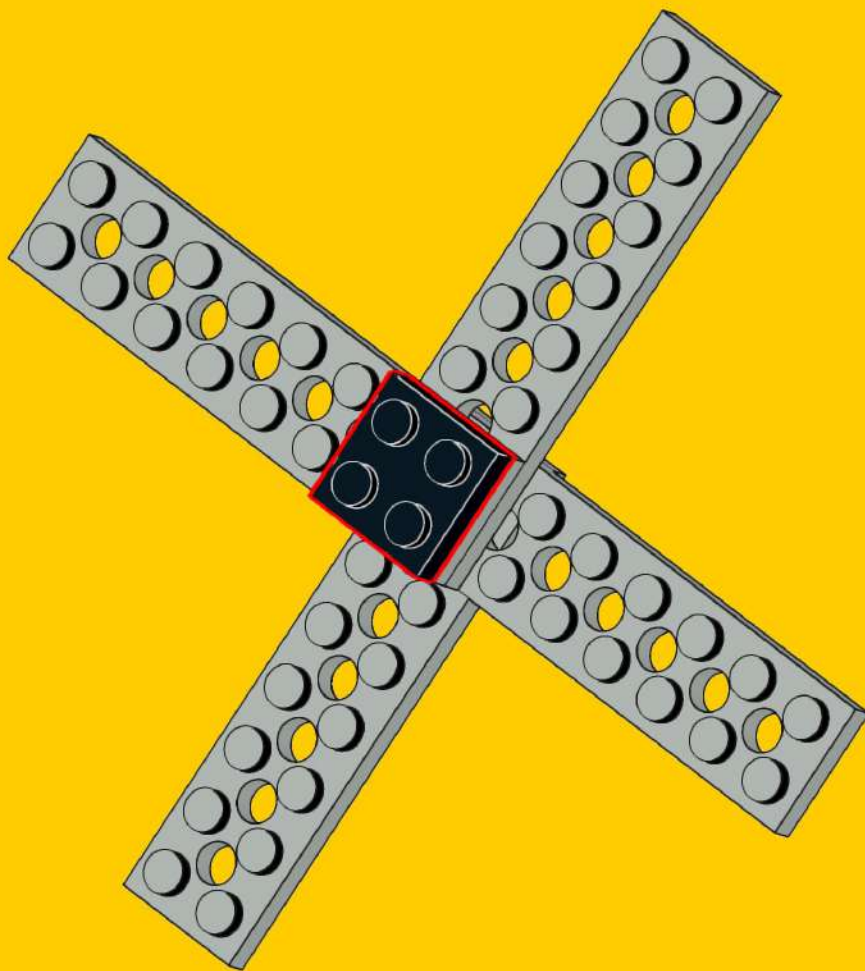
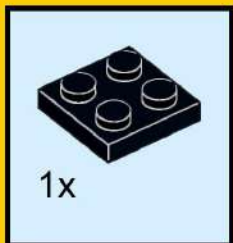

72

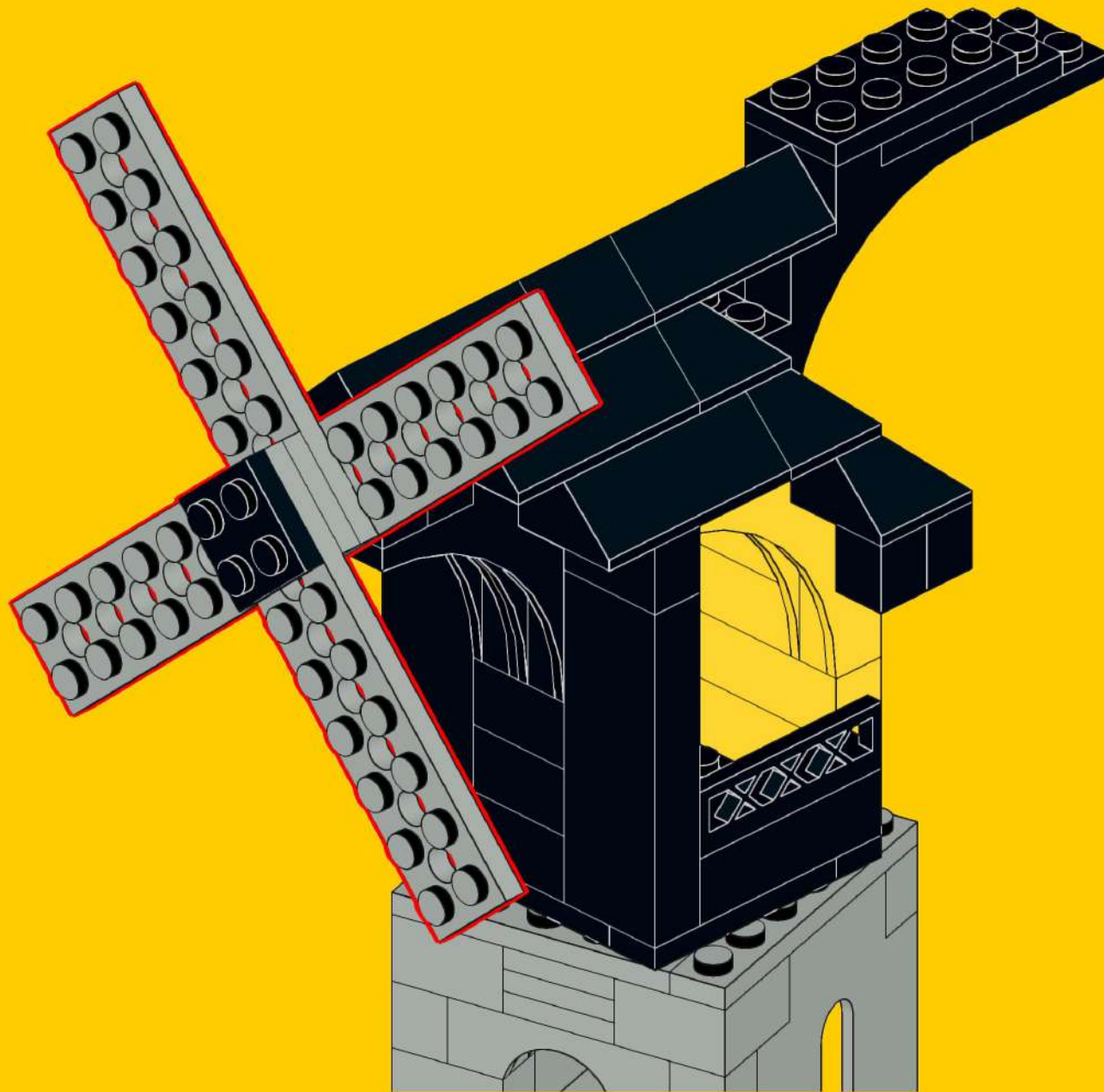



# 73

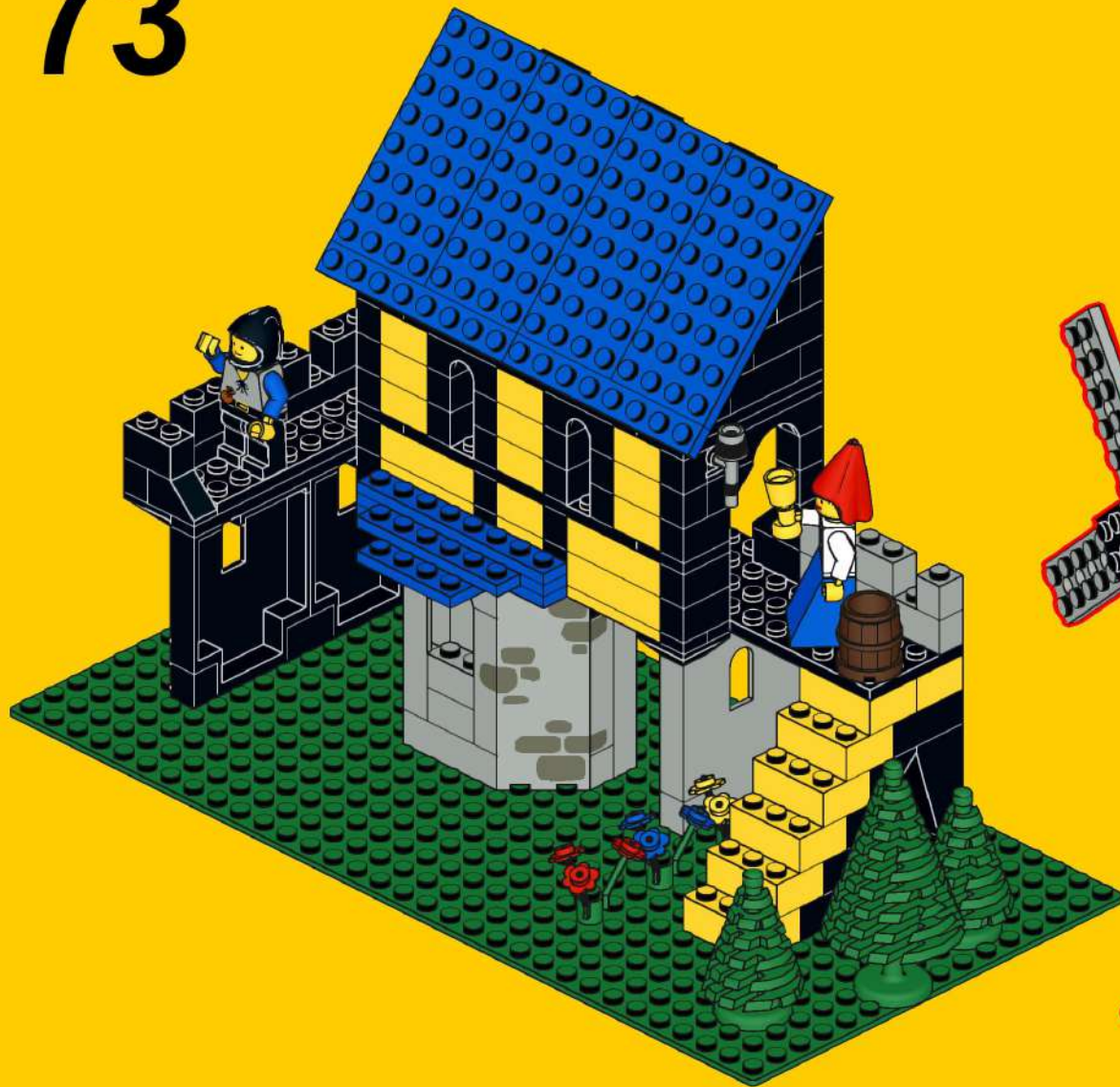





10x  
3666, 11

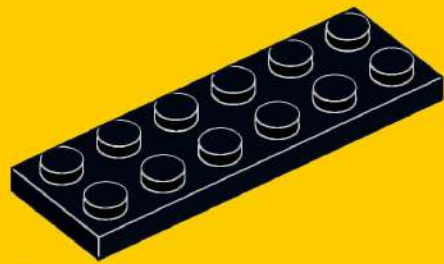

1x  
3795, 11



2x  
2454, 11

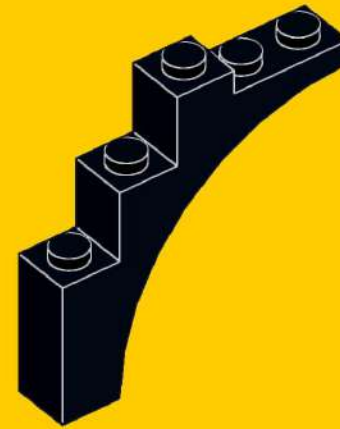

4x  
2339, 11

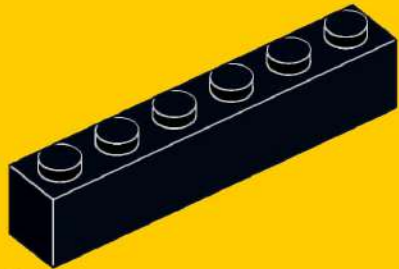

5x  
3009, 11



2x  
2453a, 11

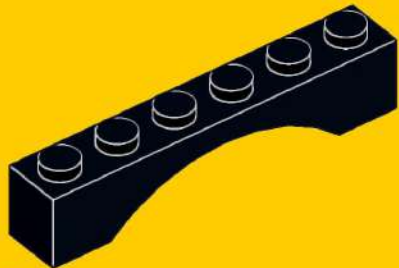

2x  
3455, 11



1x  
3403c01, 11



1x  
3032, 11



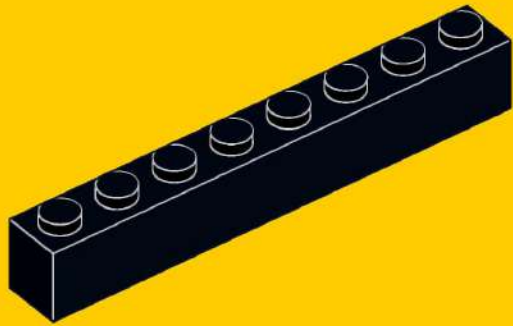

1x  
3008, 11



2x  
4444, 11

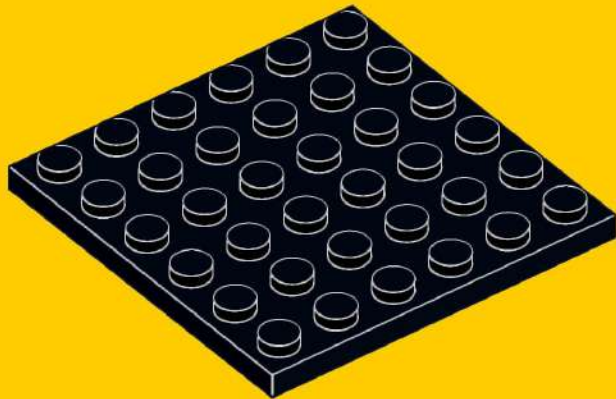

1x  
3958, 11



3x  
4477, 11





2x  
3029, 11

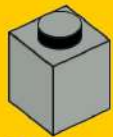

8x  
3005, 9



1x  
3673, 9

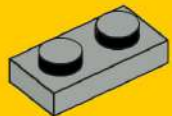

2x  
3023, 9

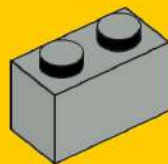

9x  
3004, 9

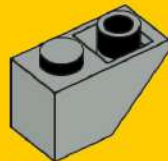

4x  
3665, 9



2x  
3040, 9

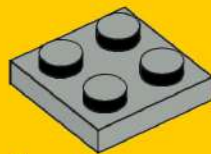

1x  
3022, 9



1x  
973p46, 9



1x  
3959, 9

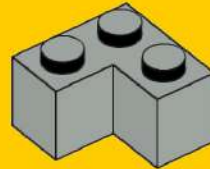

2x  
2357, 9

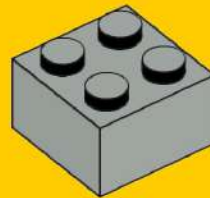

1x  
3003, 9

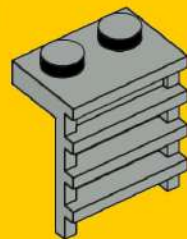

1x  
4175, 9

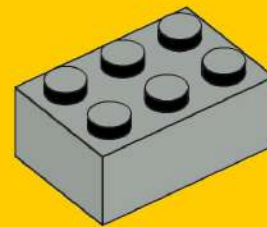

1x  
3002, 9

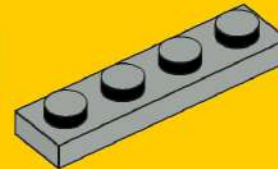

2x  
3710, 9



3x  
3659, 9

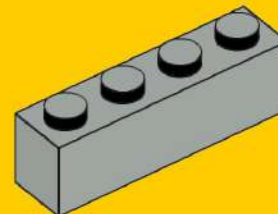

2x  
3010, 9



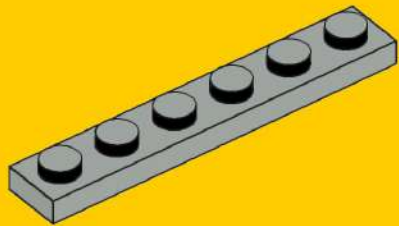

2x  
3666, 9

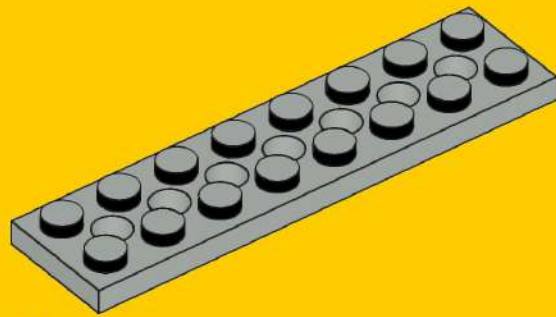

4x  
3738, 9

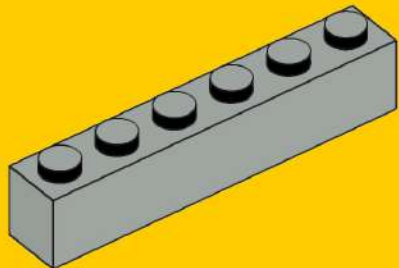

2x  
3009, 9



1x  
2345pb05, 9

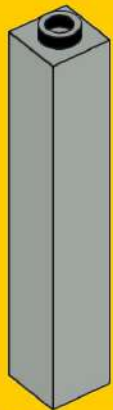

3x  
2453a, 9

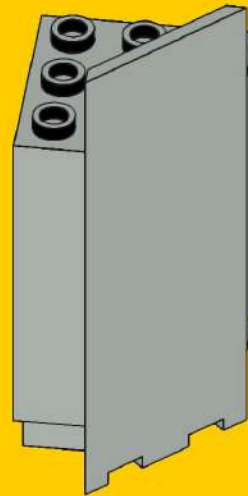

1x  
2345, 9

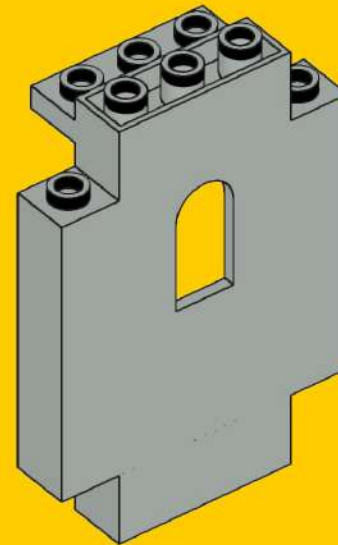

3x  
4444, 9



1x  
973p4n, 1



3x  
3742, 5



1x  
x107, 5



1x  
982, 1



1x  
981, 1



1x  
2489, 8



3x  
3742, 3

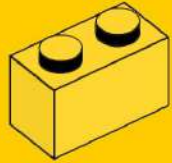

13x  
3004, 3

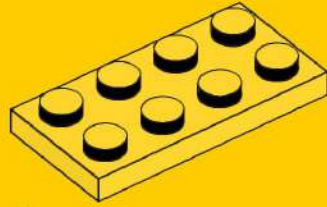

1x  
3020, 3



4x  
983, 3

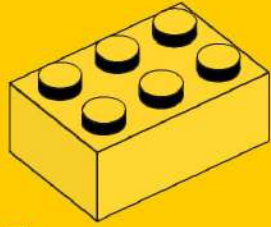

7x  
3002, 3



1x  
3626ap01, 3

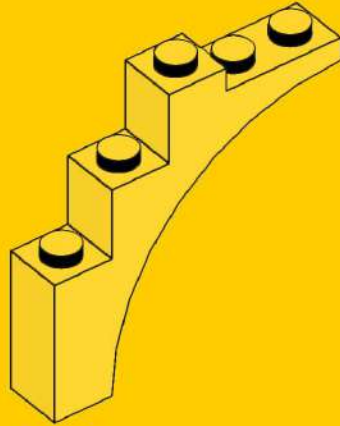

2x  
2435, 6

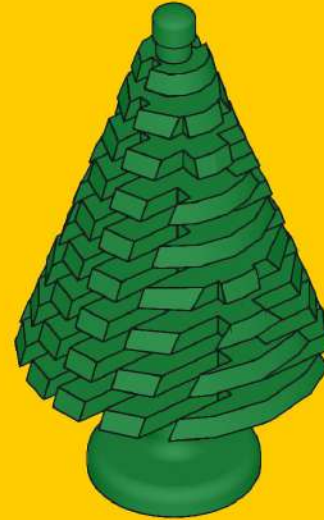
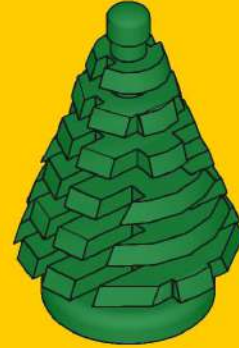

1x  
3626bp40, 3

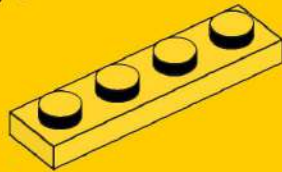

1x  
3710, 3

2x  
2339, 3

1x  
3471, 6



1x  
2343, 3

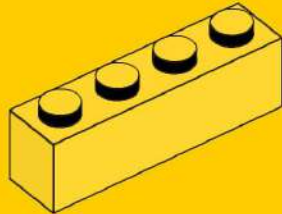

6x  
3010, 3



3x  
3741, 6



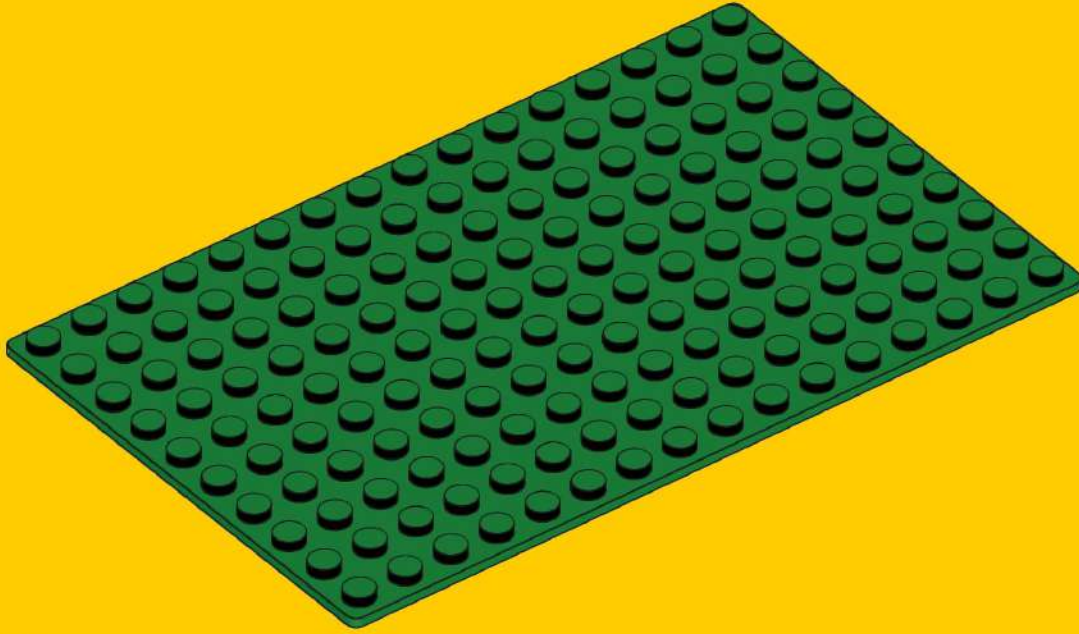

1x  
bp01, 6





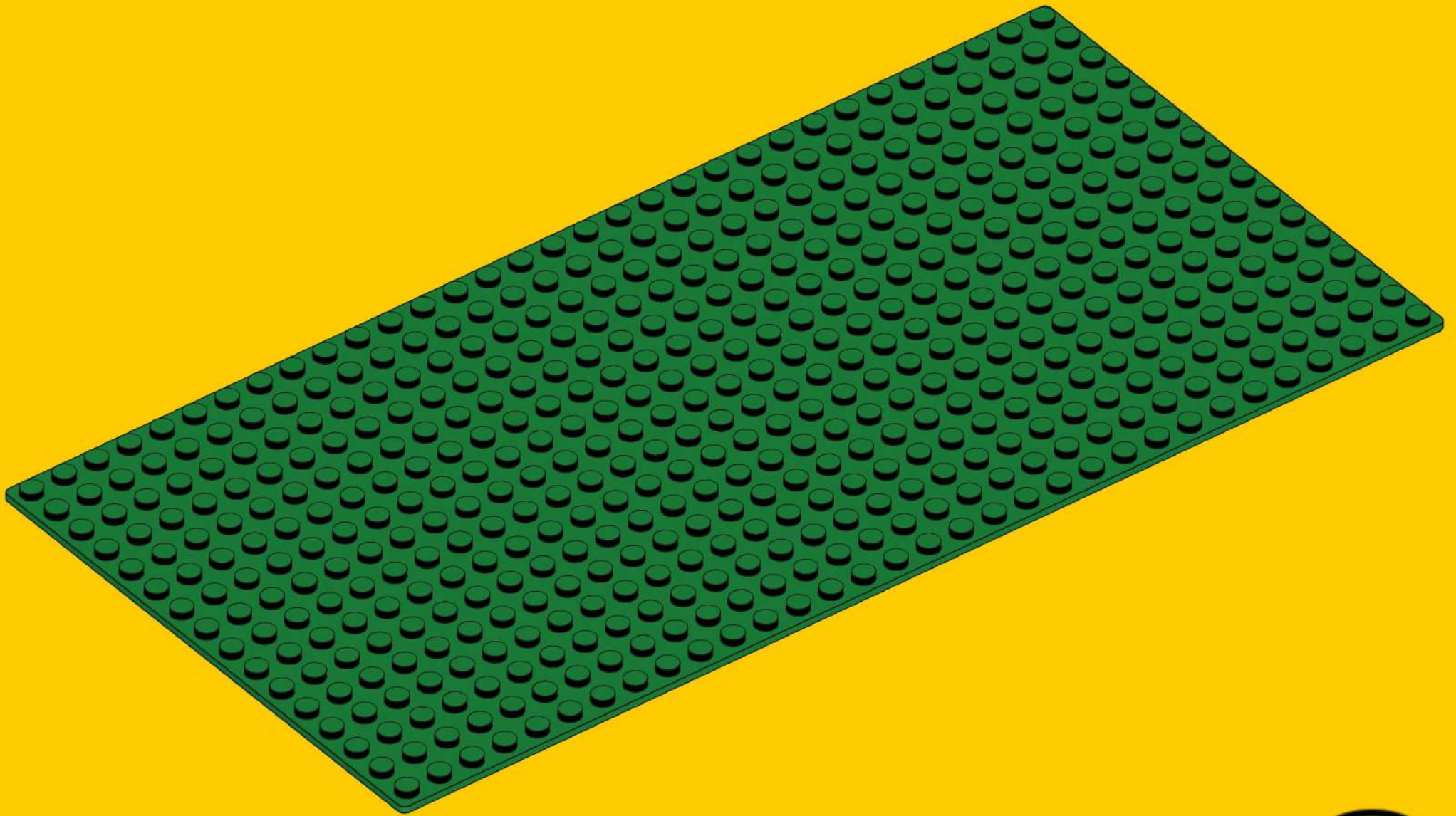

1x  
3857, 6





2x  
3024, 7



3x  
3742, 7



1x  
982, 7



1x  
981, 7



1x  
3678a, 7

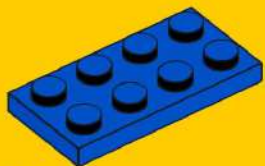

1x  
3020, 7



1x  
3795, 7

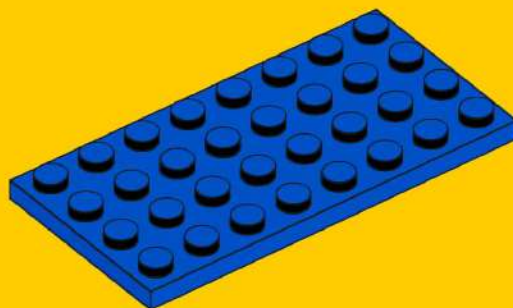

4x  
3035, 7

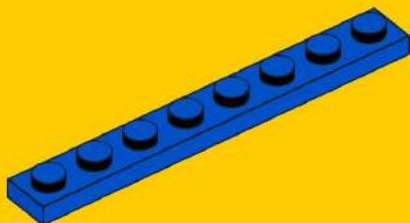

3x  
3460, 7

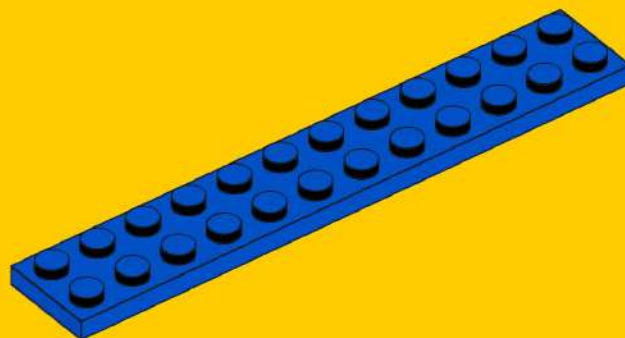

1x  
2445, 7

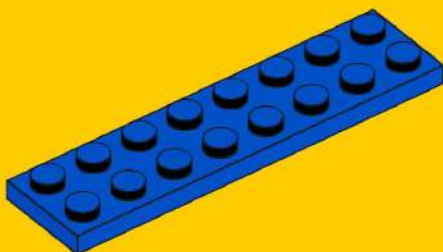

1x  
3034, 7

