

# IDEAS 260 - War of the Two Houses

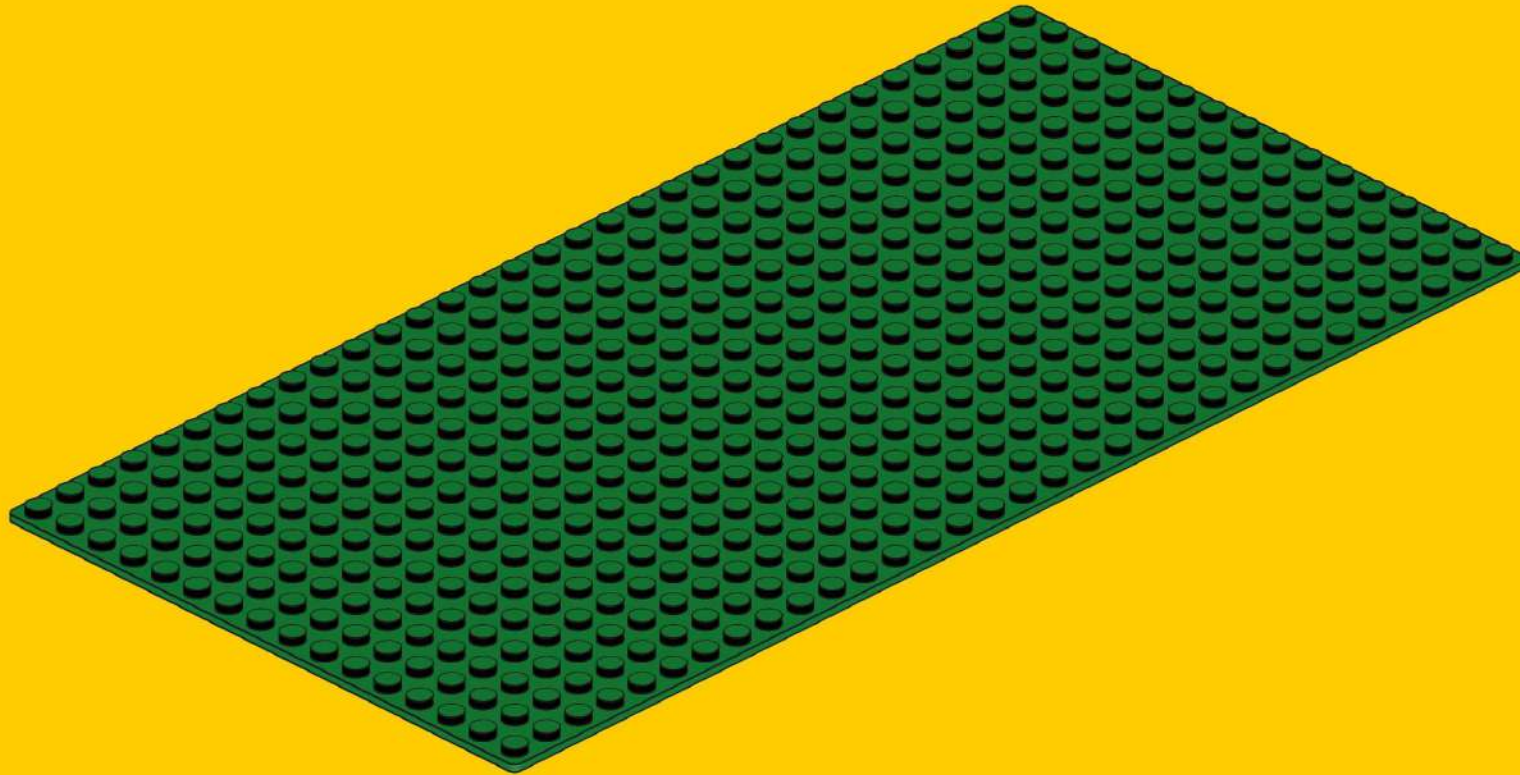

1



2

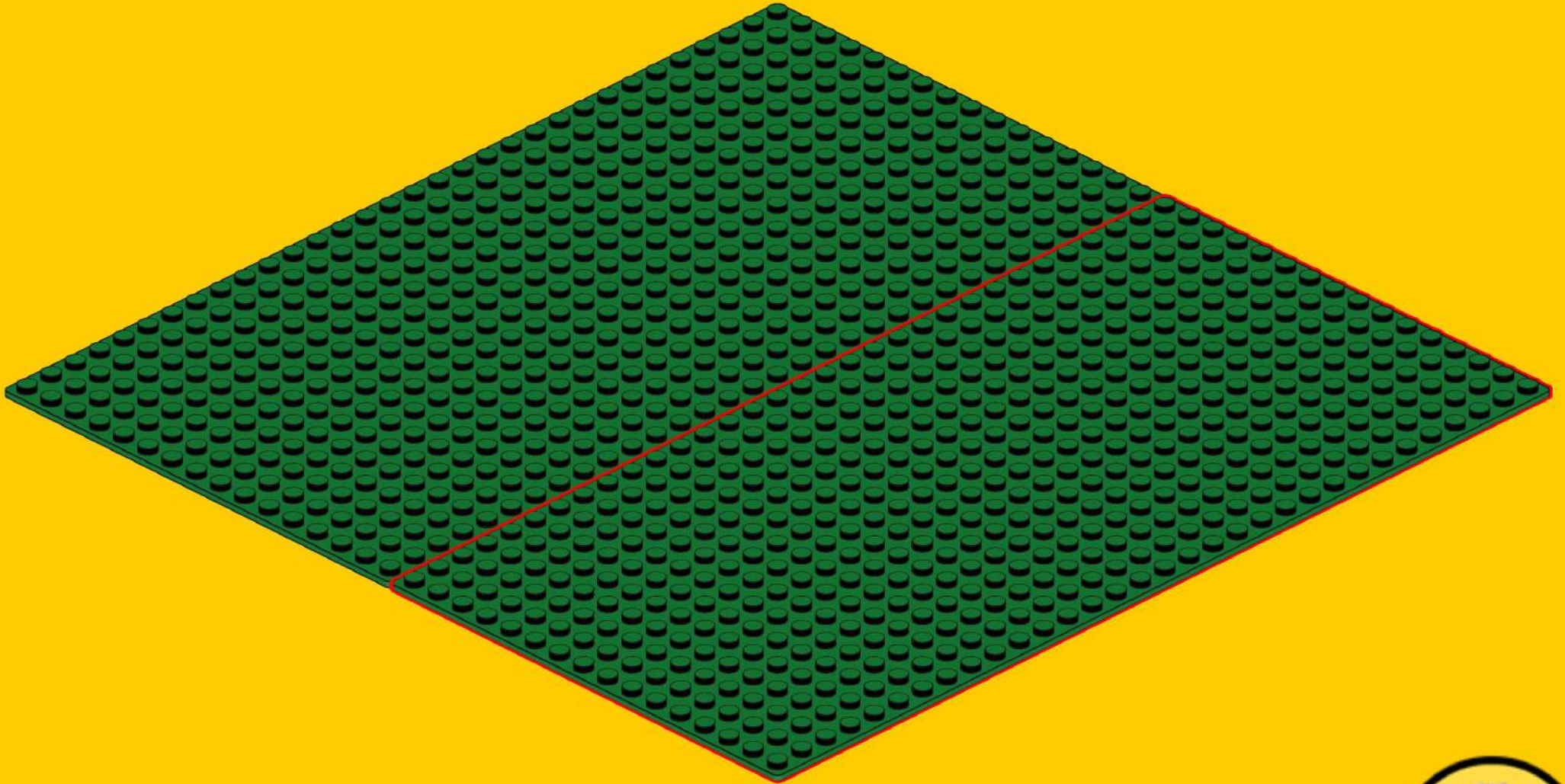

# 3

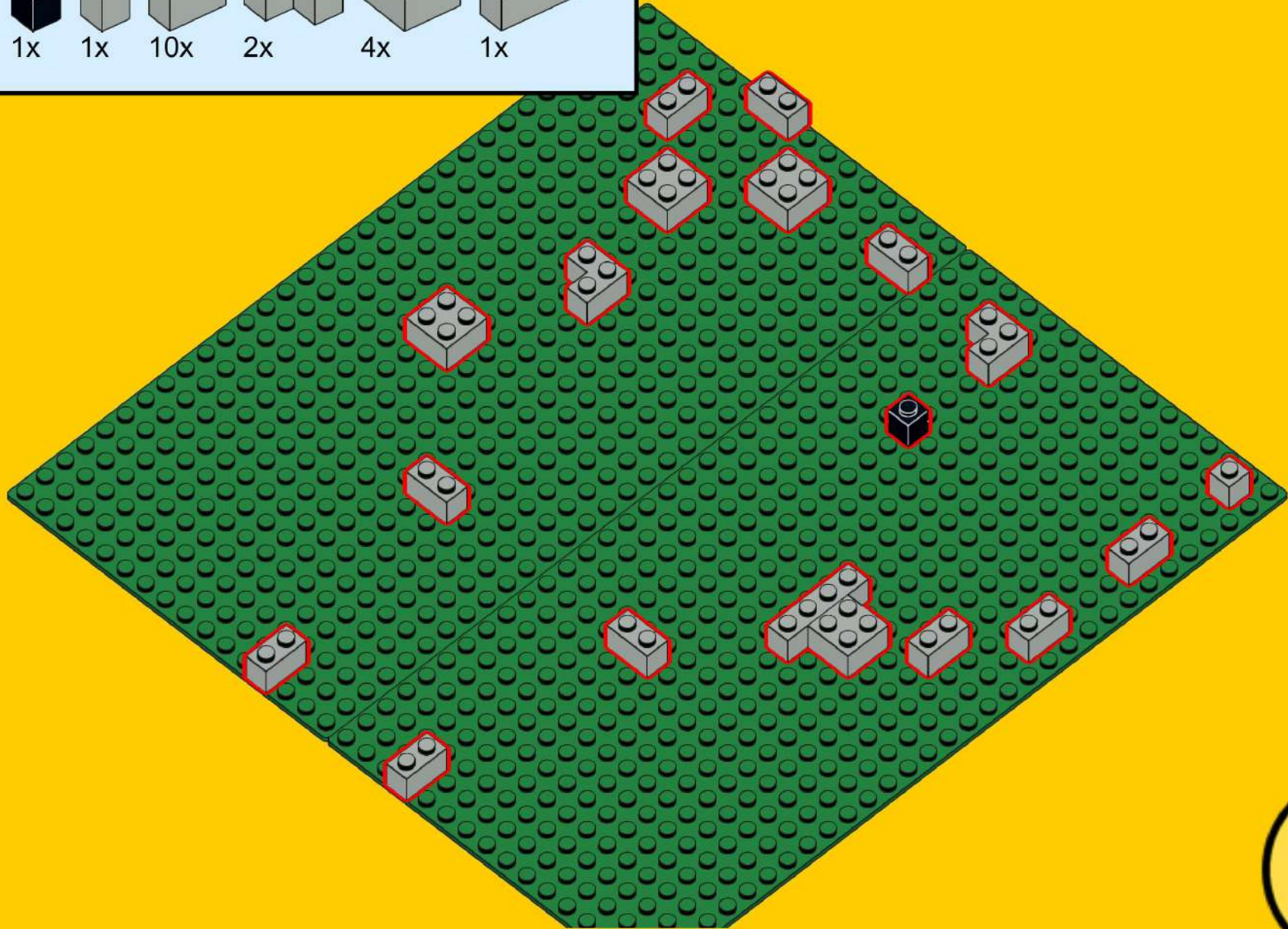
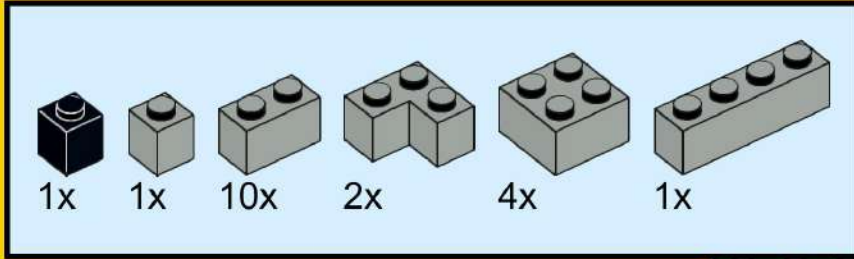

# 4

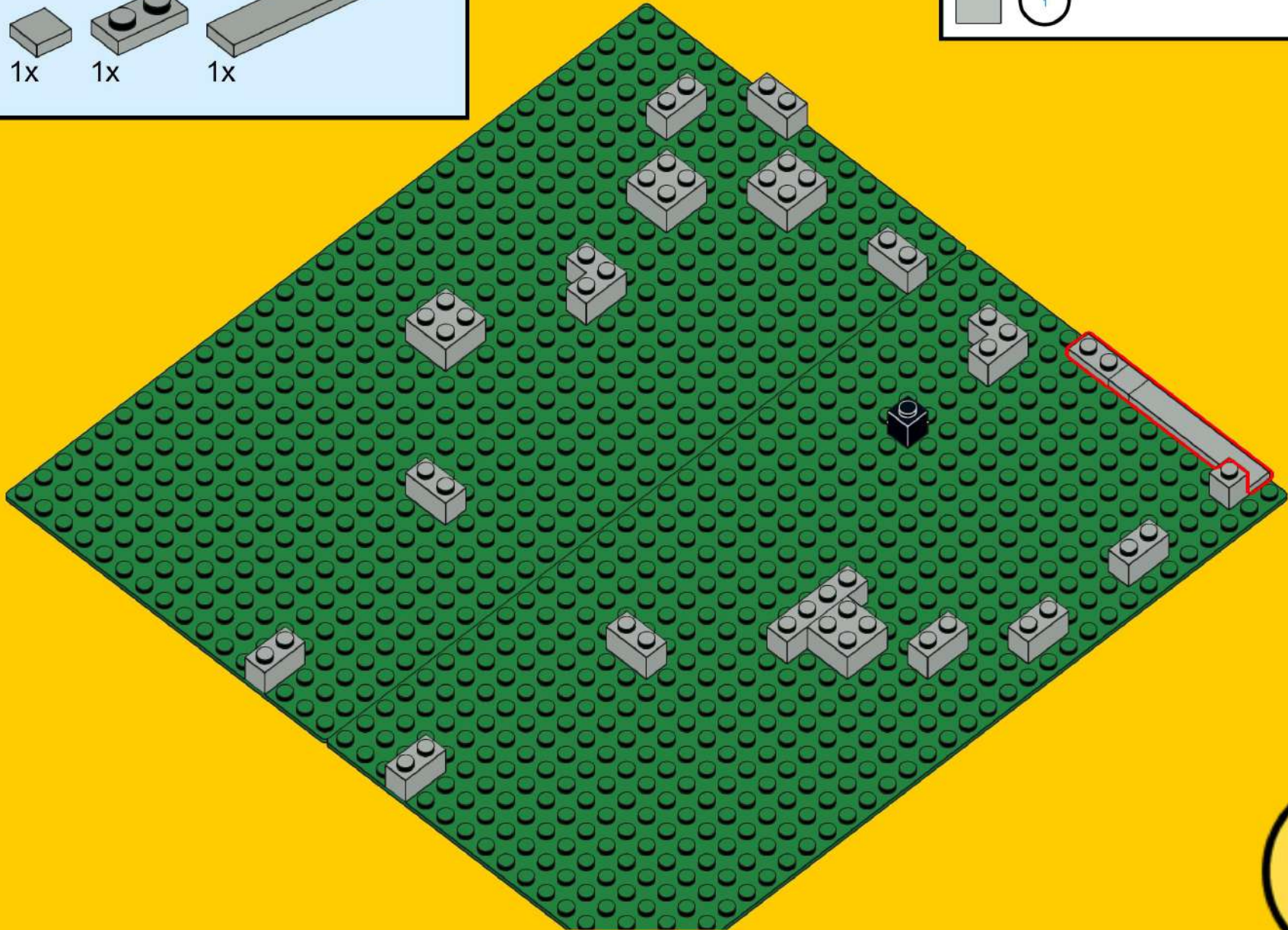
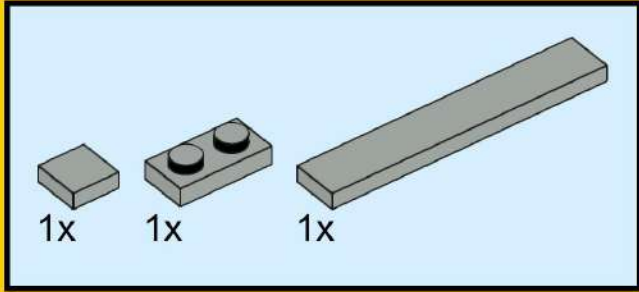

# 5

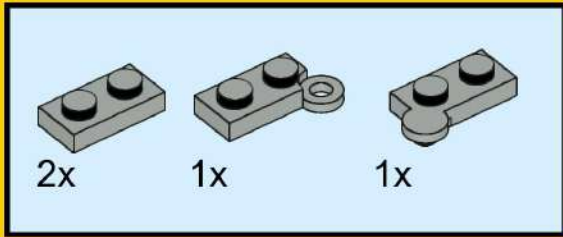

# 6

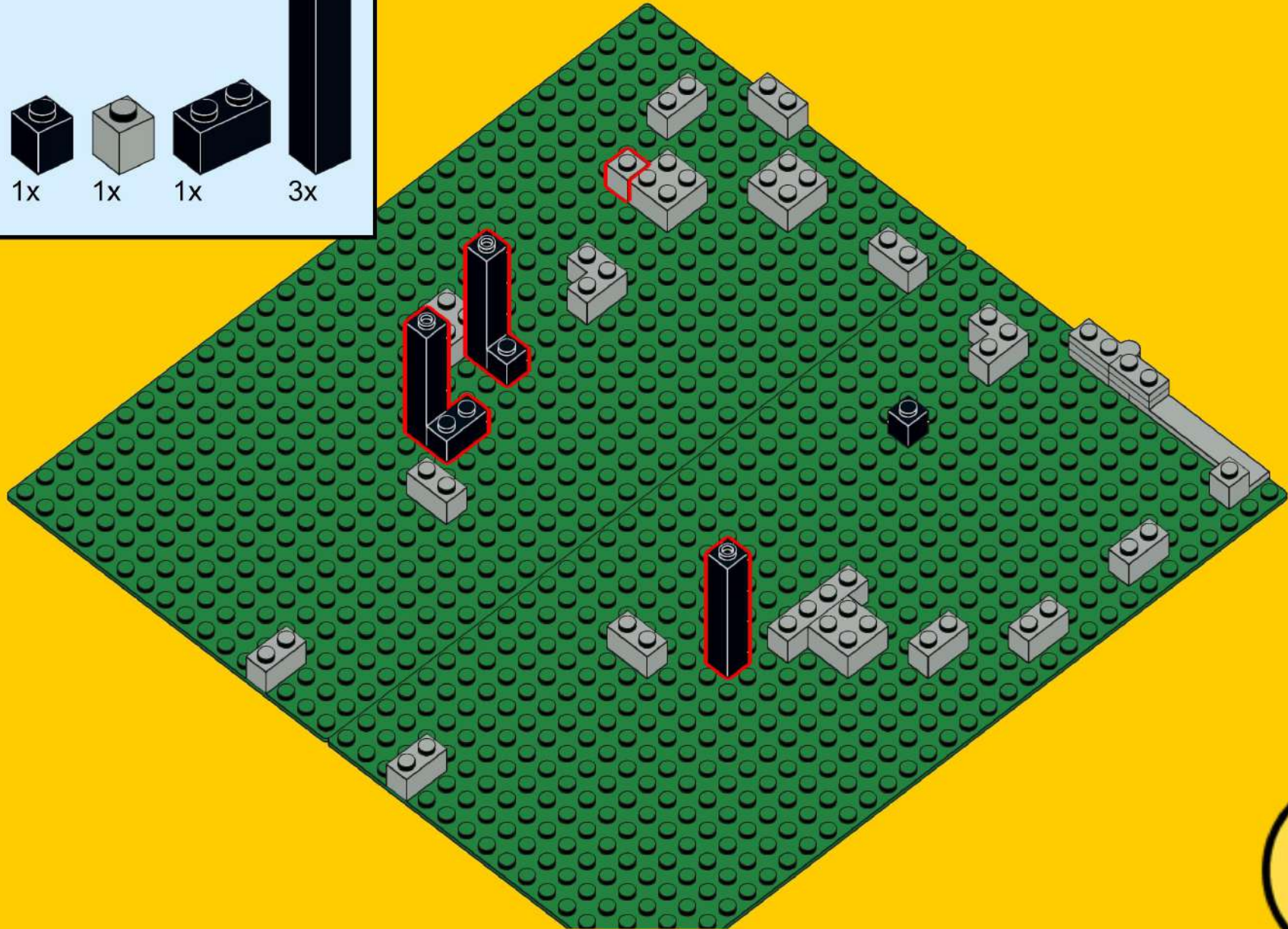
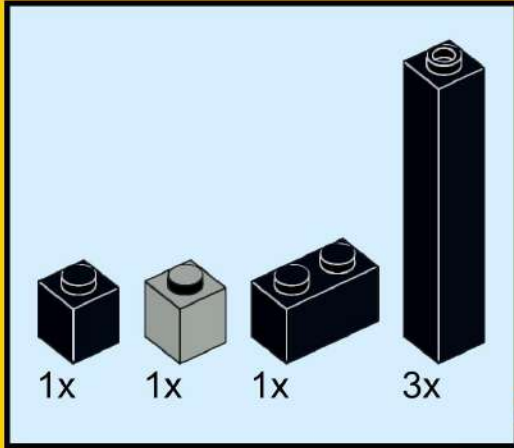

7

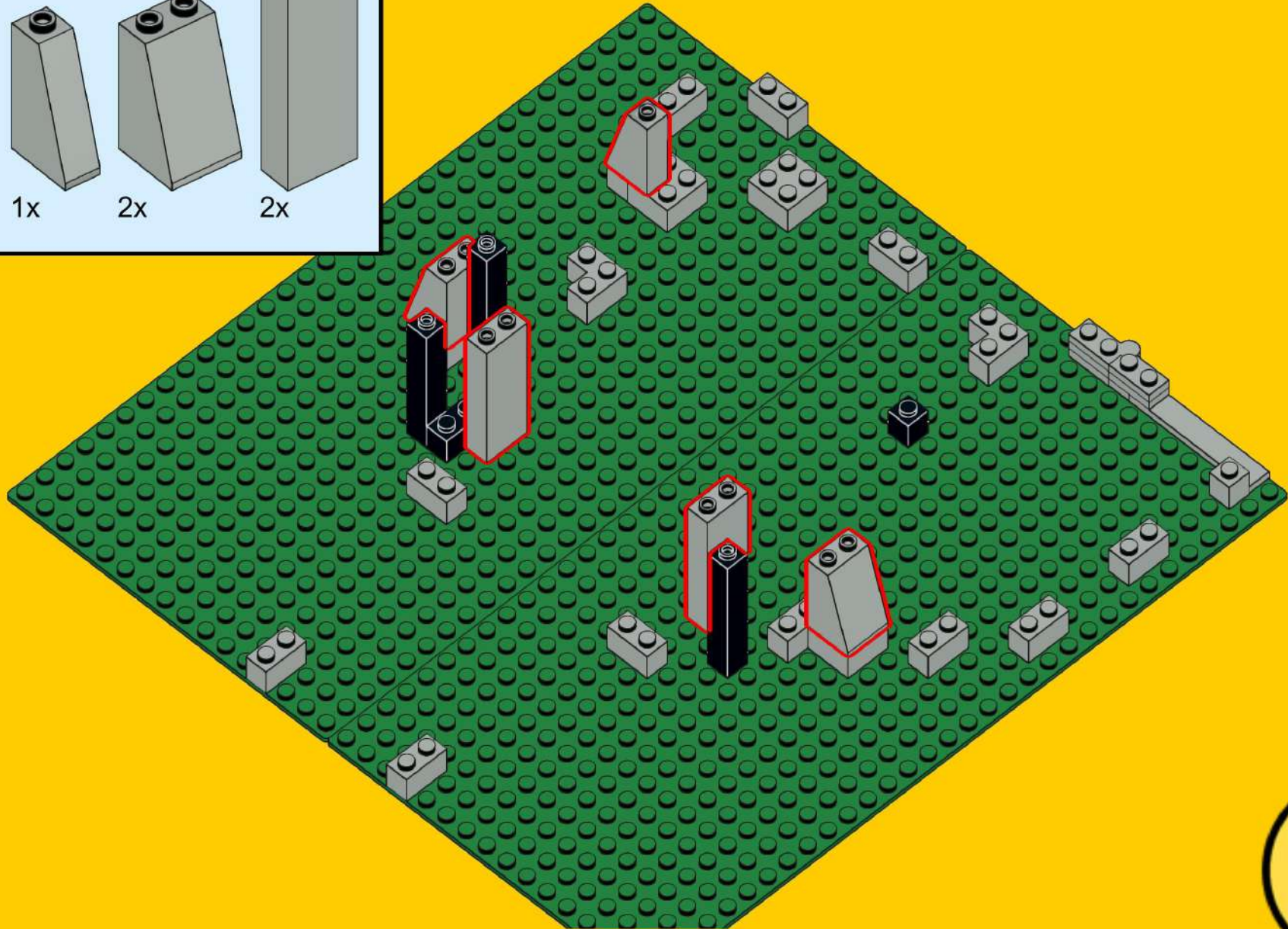
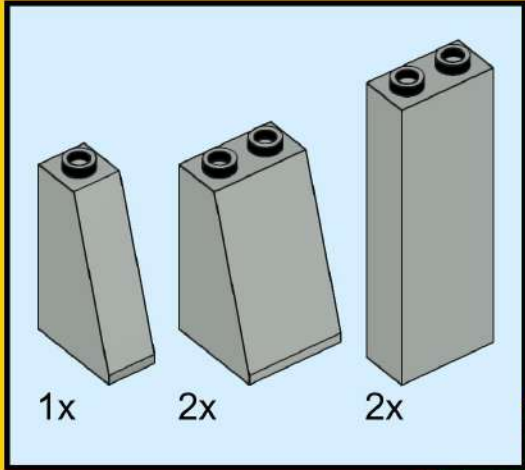



8

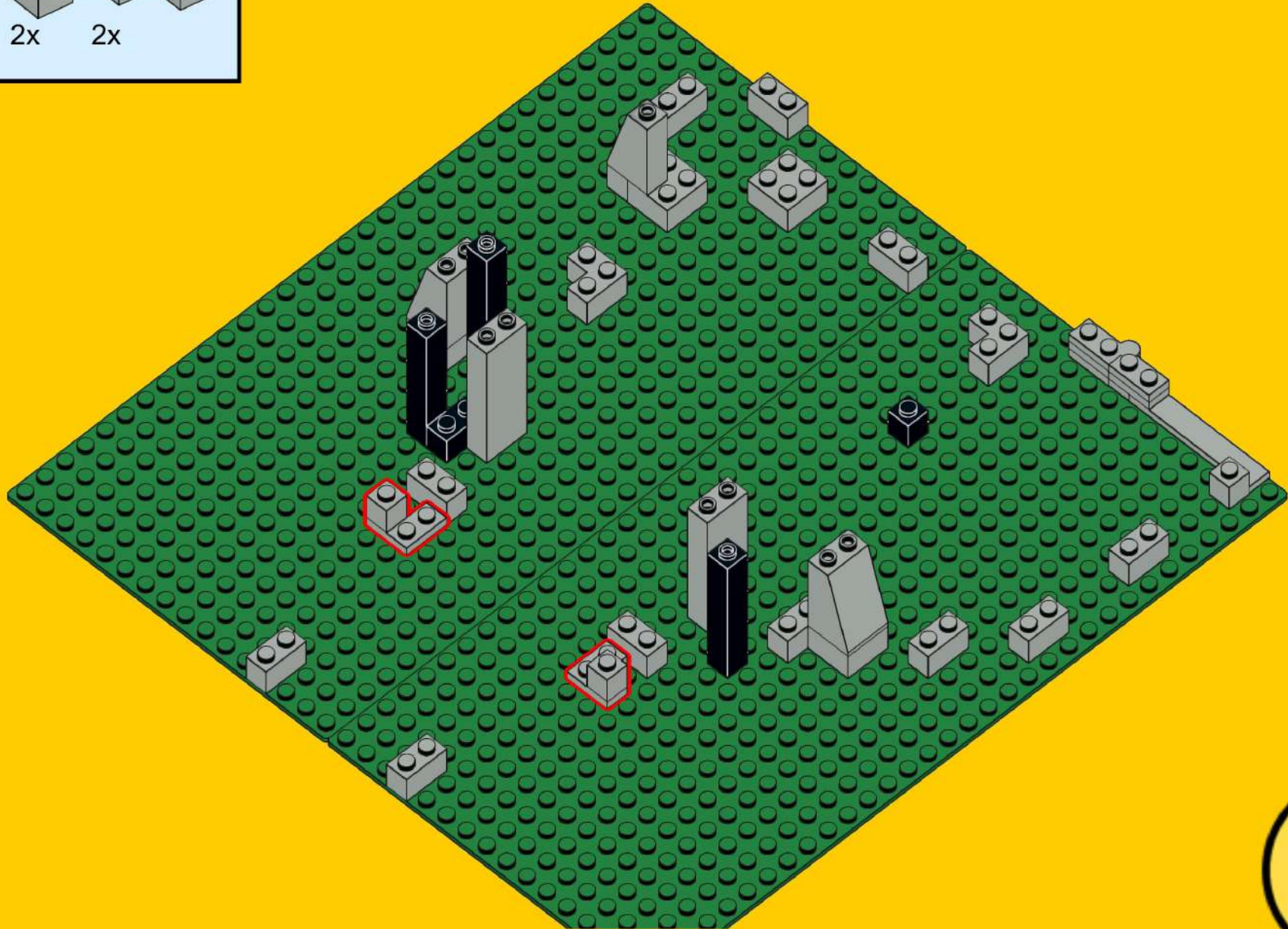
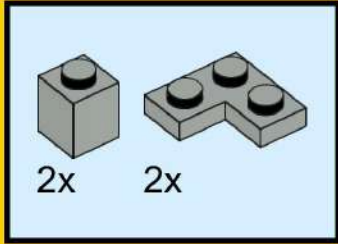

# 9

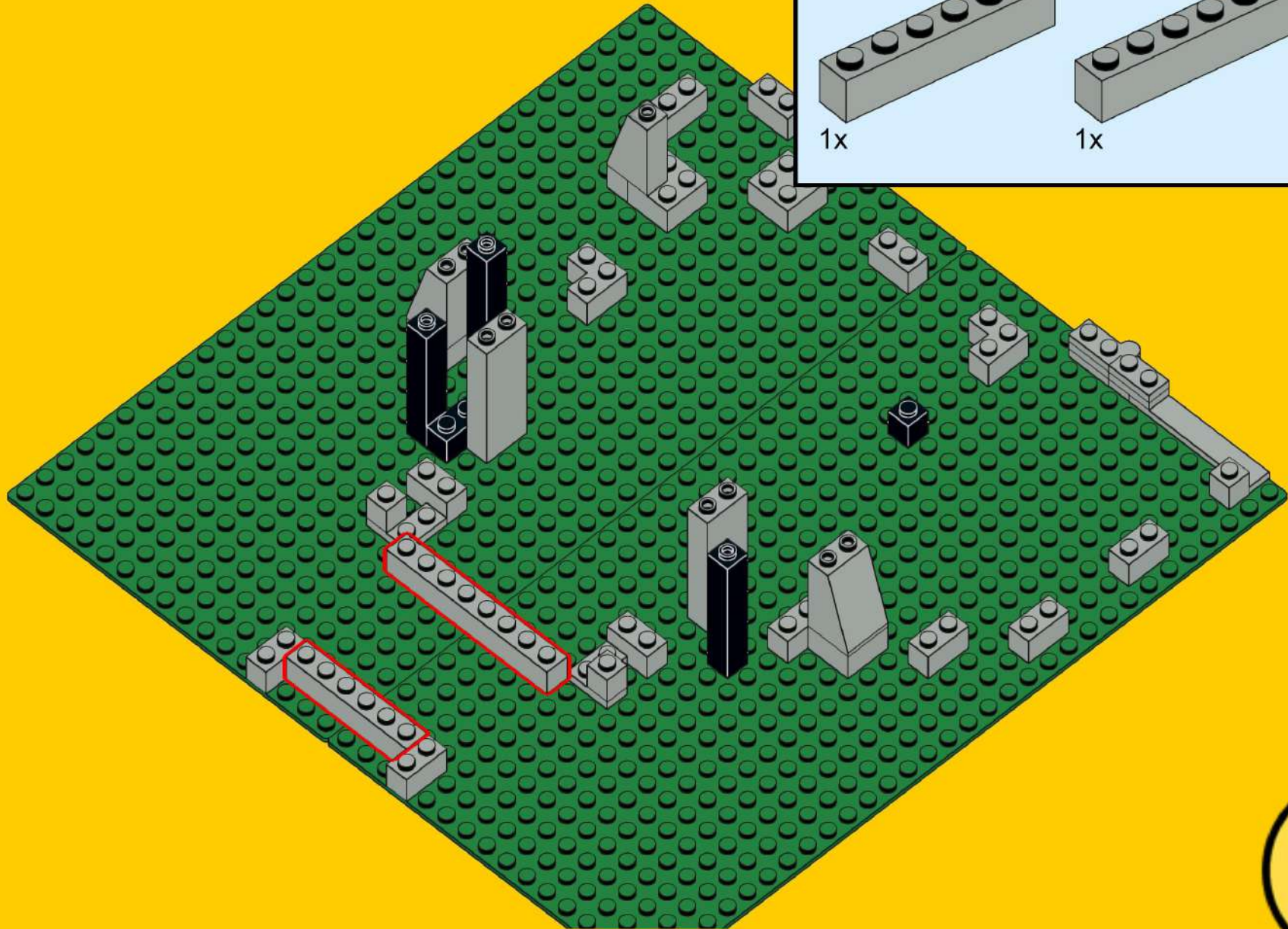

# 10

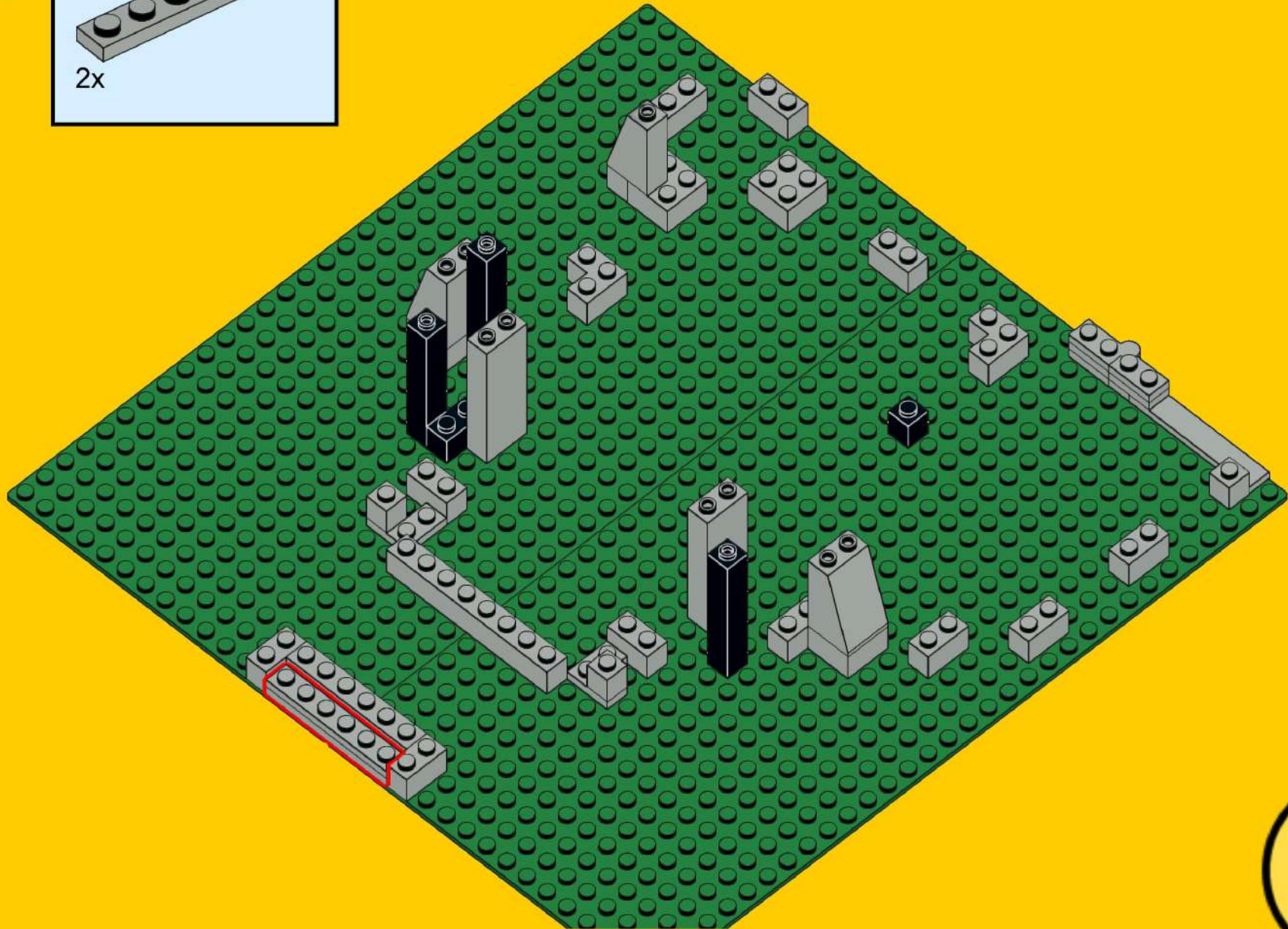
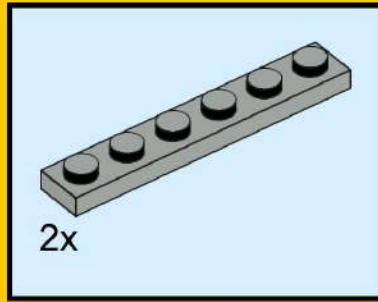

# 11

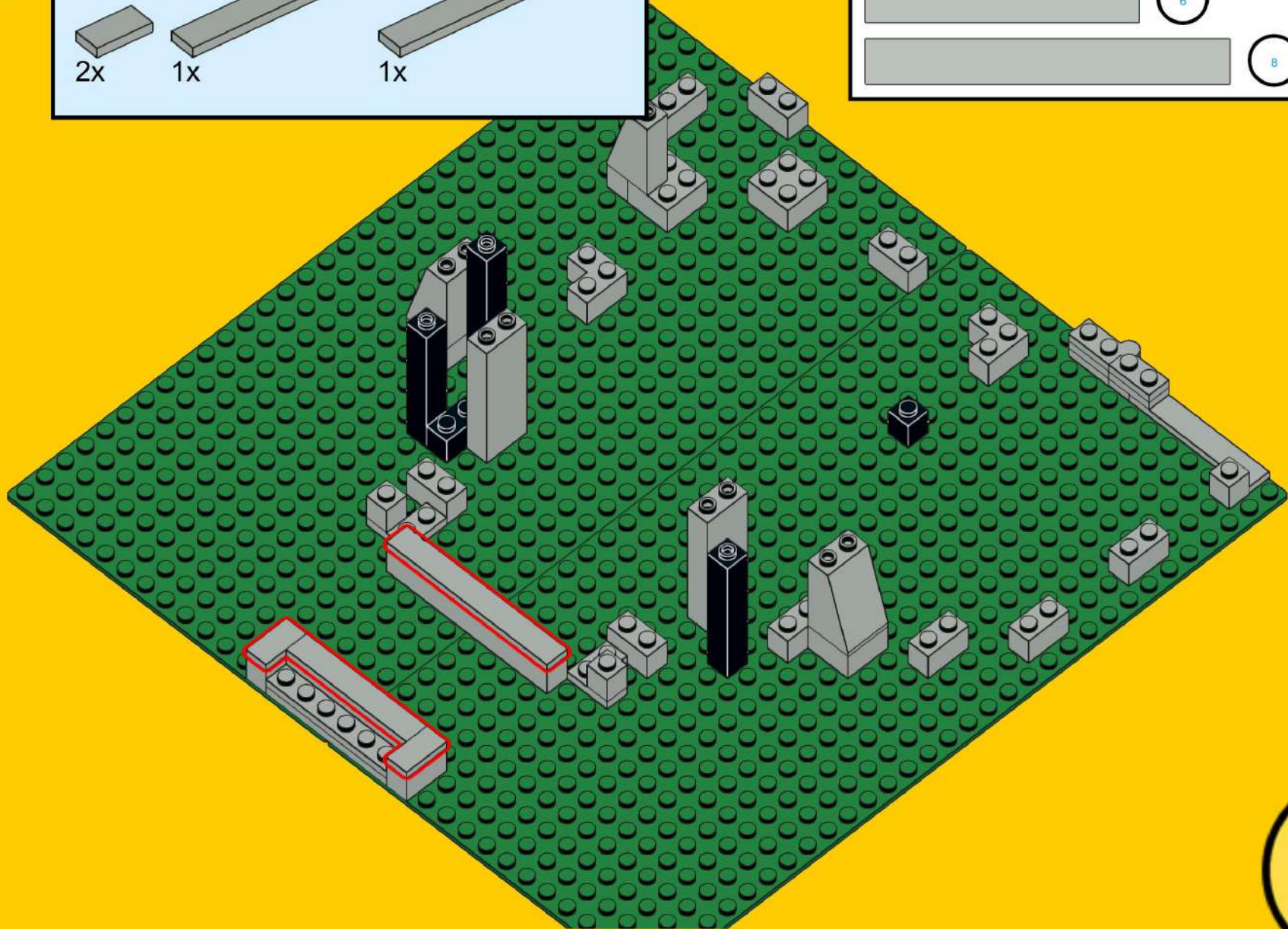
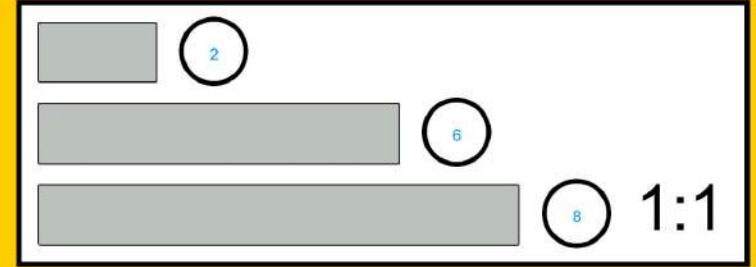
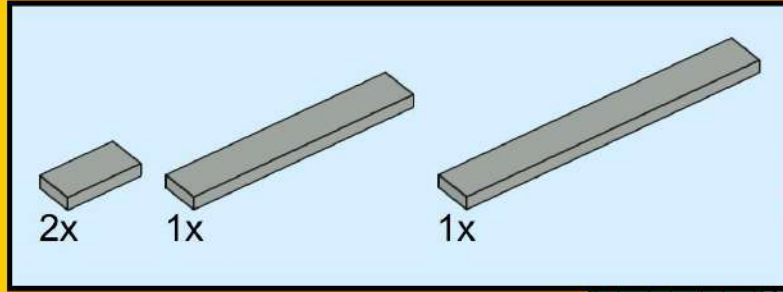

# 12

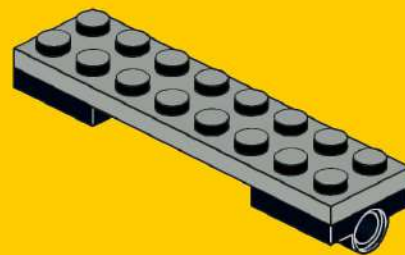
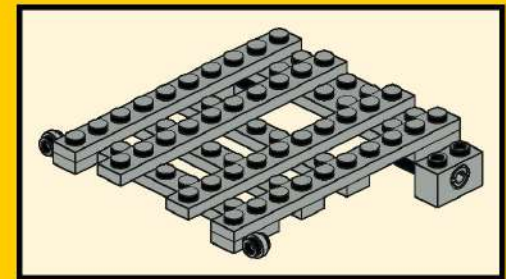
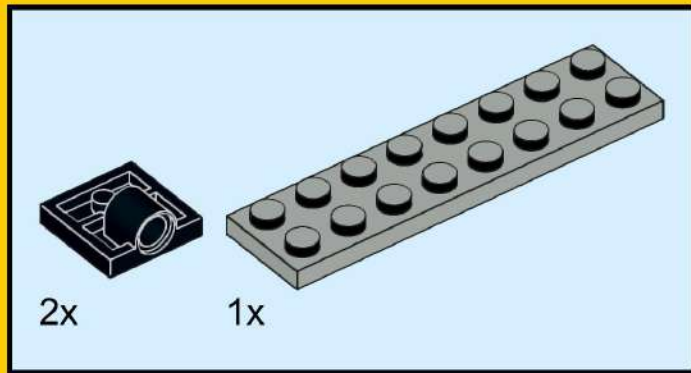

# 13

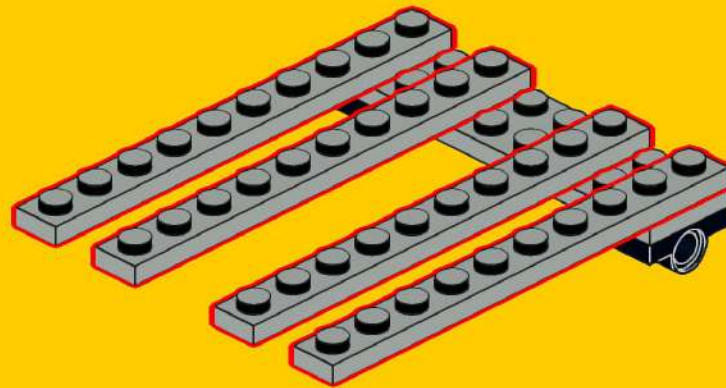
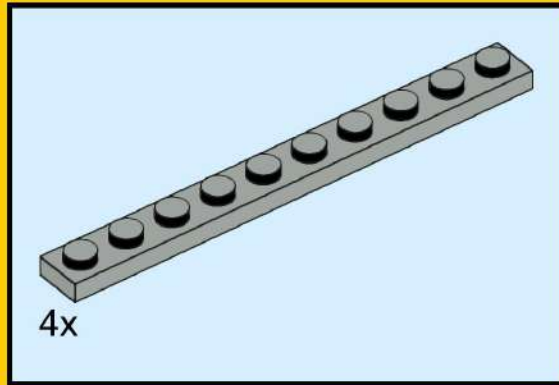

# 14

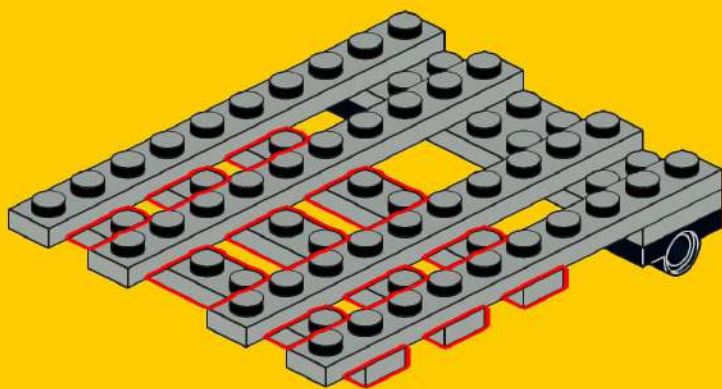
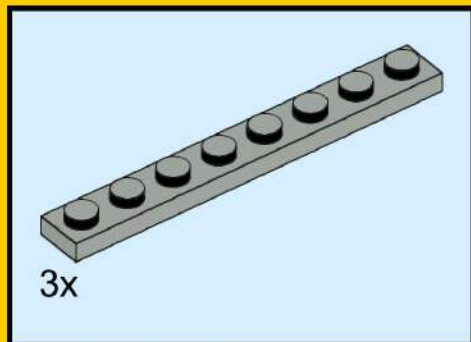

# 15

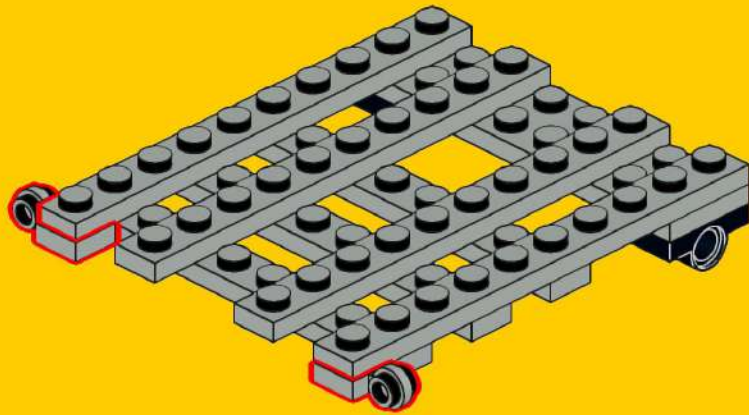
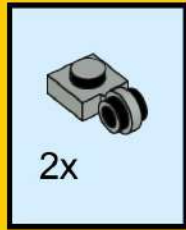



# 16

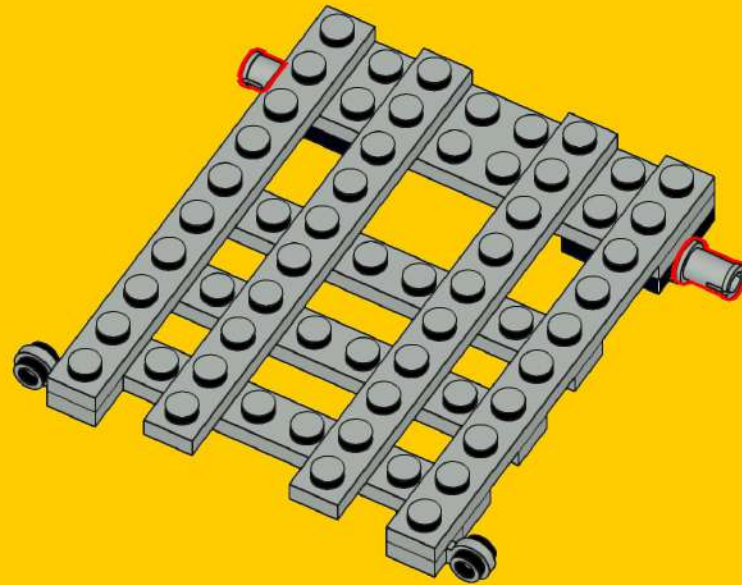
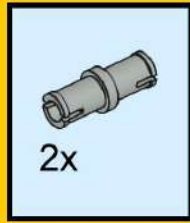

# 17

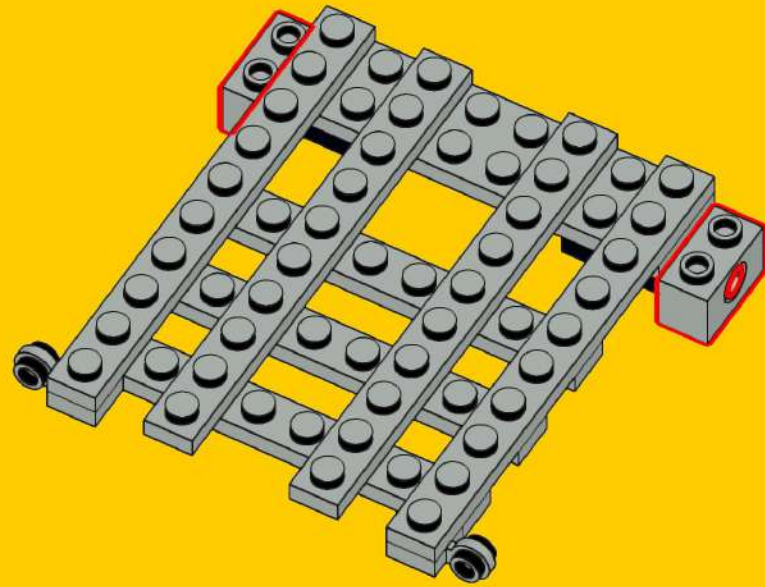
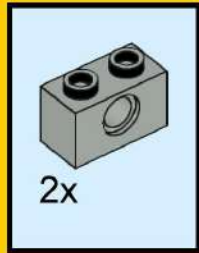

# 18

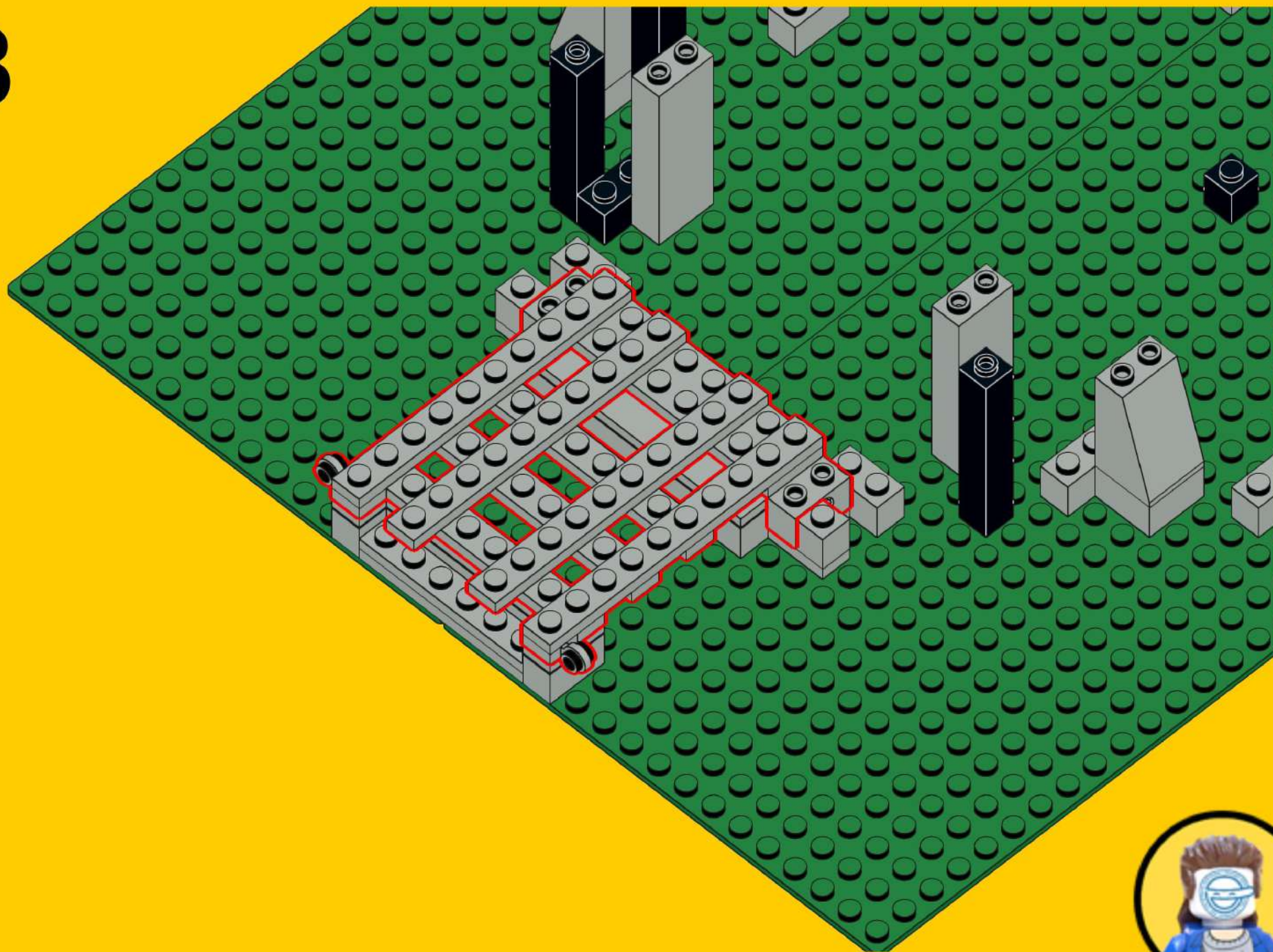

# 19

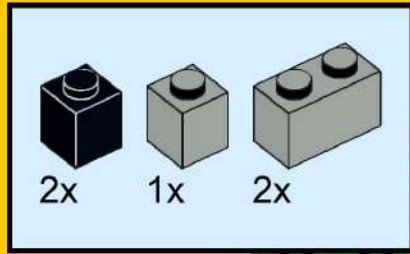

2x 1x 2x

This inset box shows the parts required for step 19: two black 1x1 Technic bricks, one grey 1x1 Technic brick, and two grey 1x2 Technic bricks. The quantities are listed as 2x, 1x, and 2x respectively.

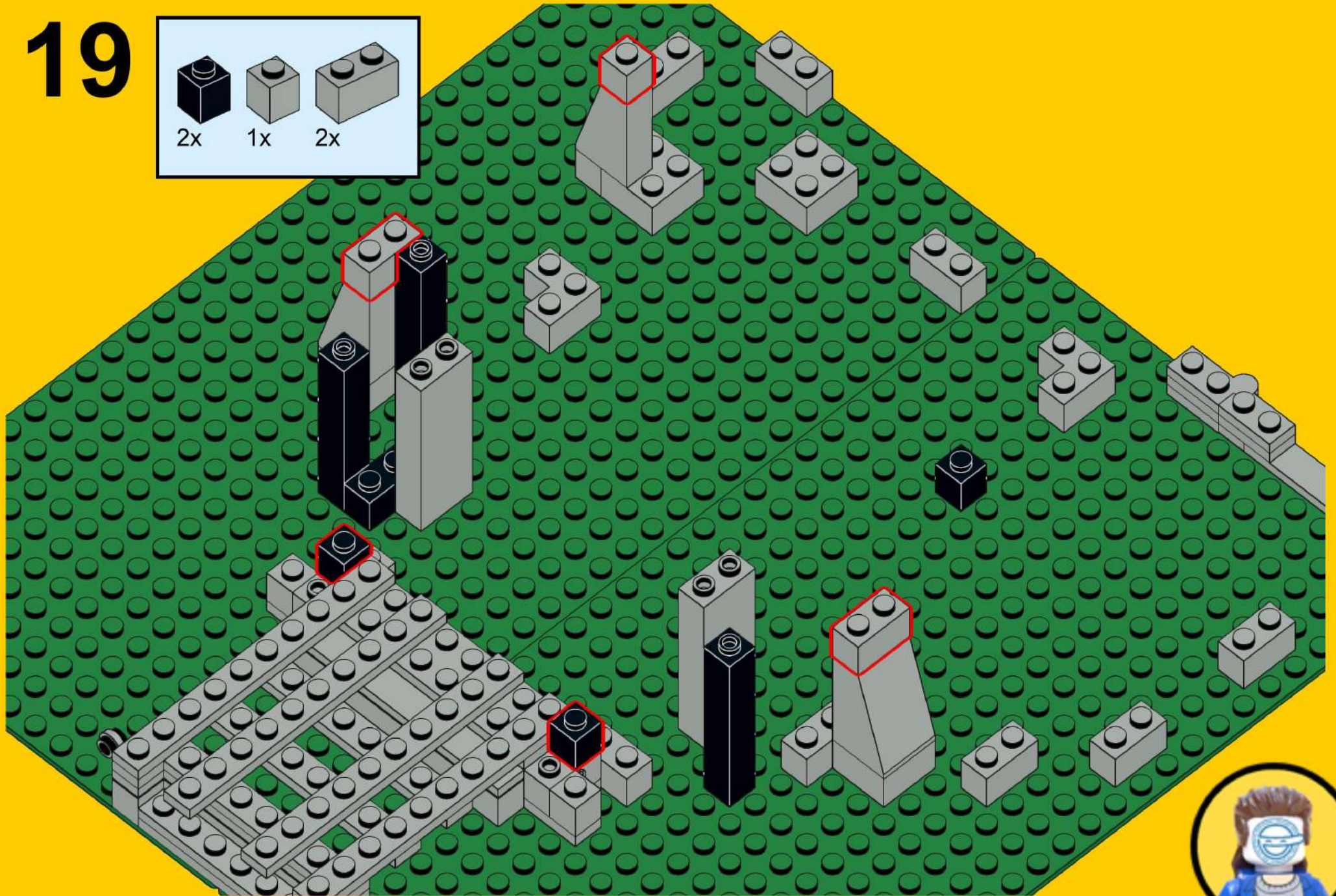

# 20

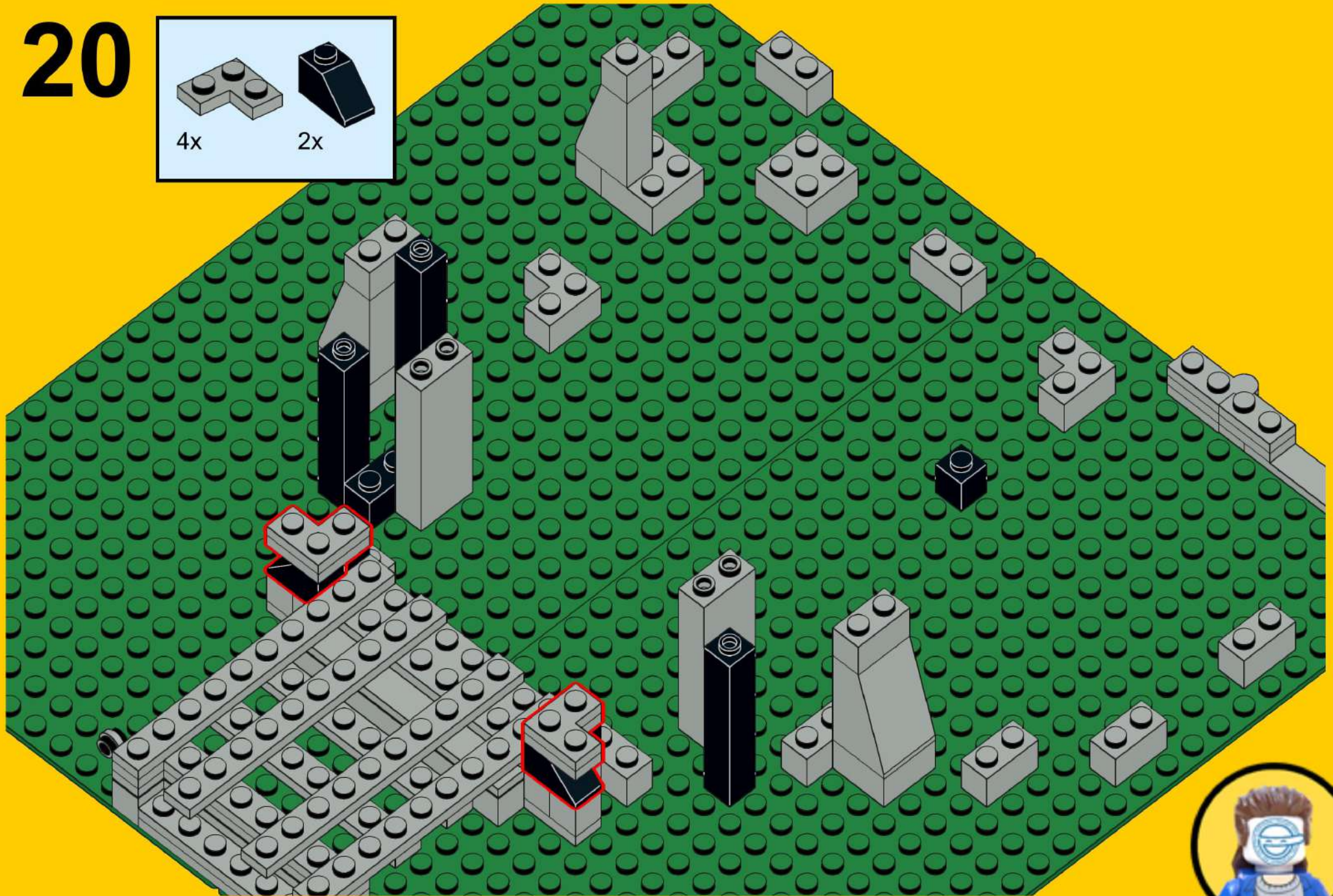
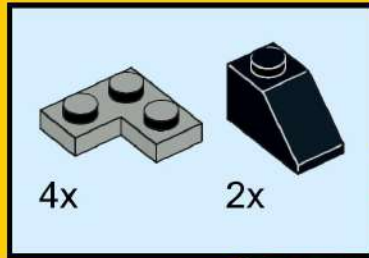

# 21

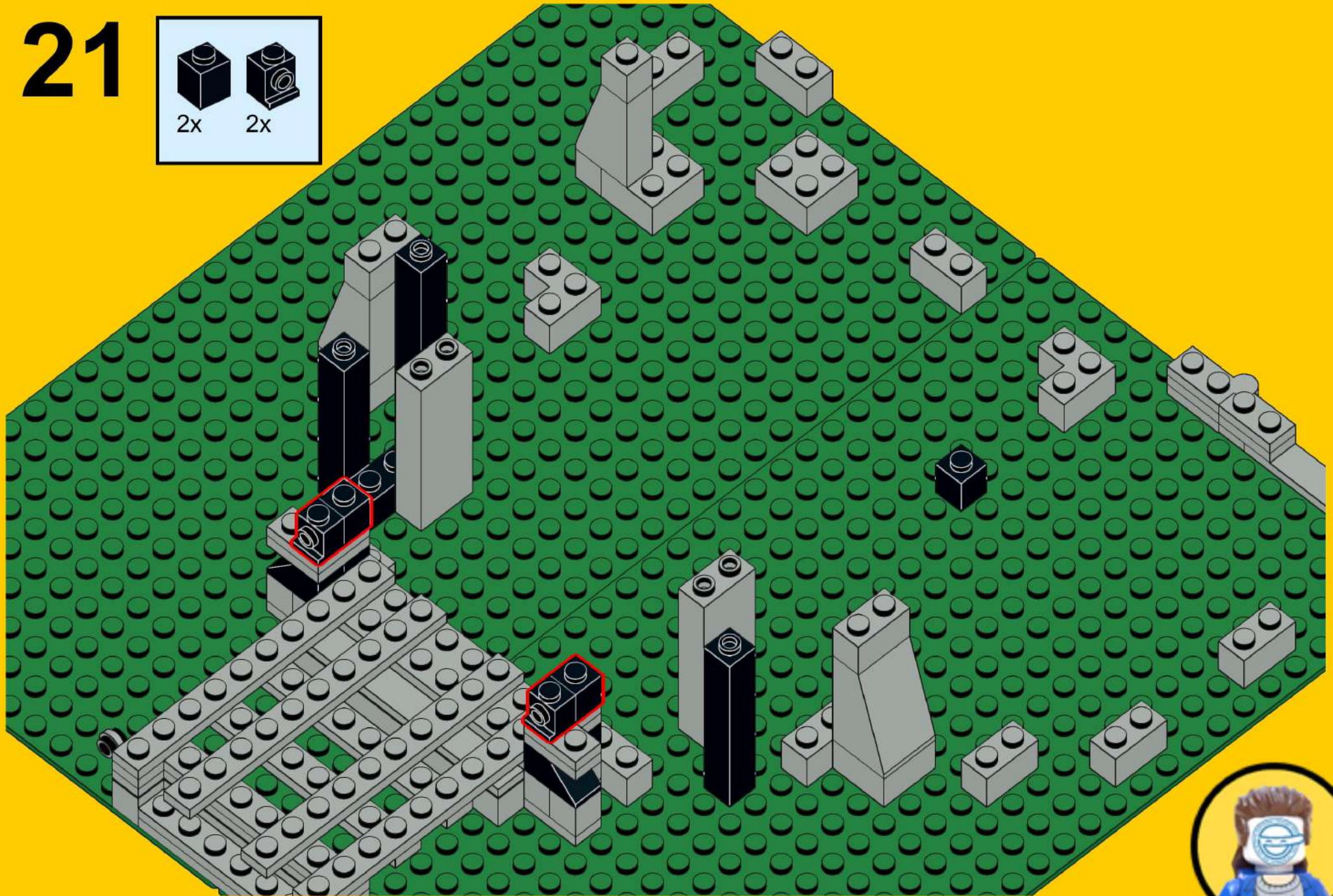
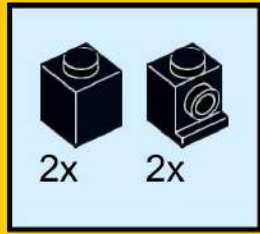

# 22

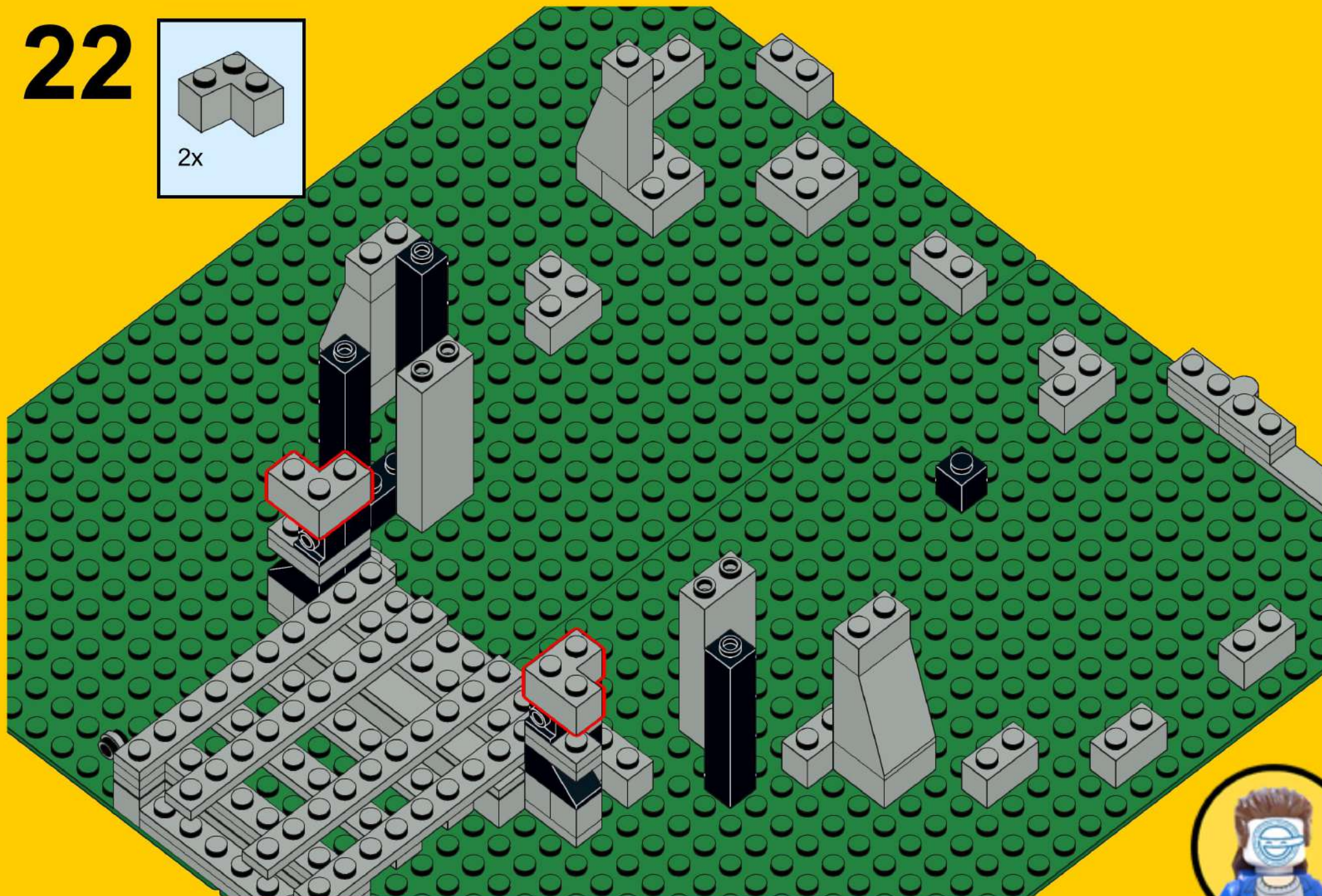
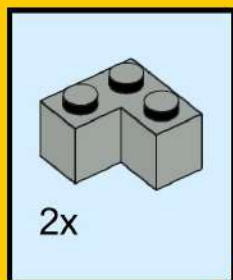

# 23

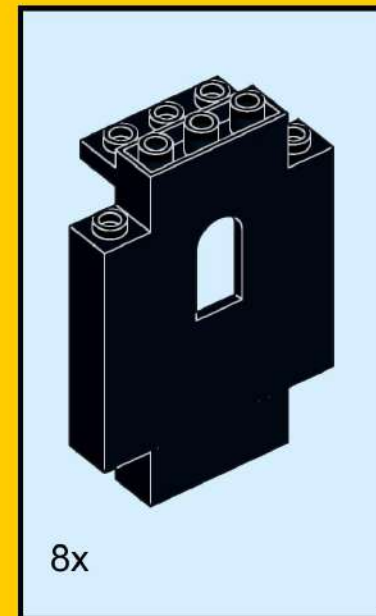



# 24

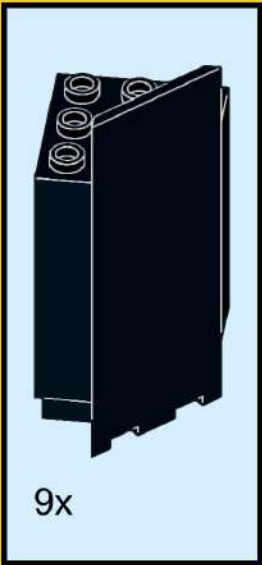
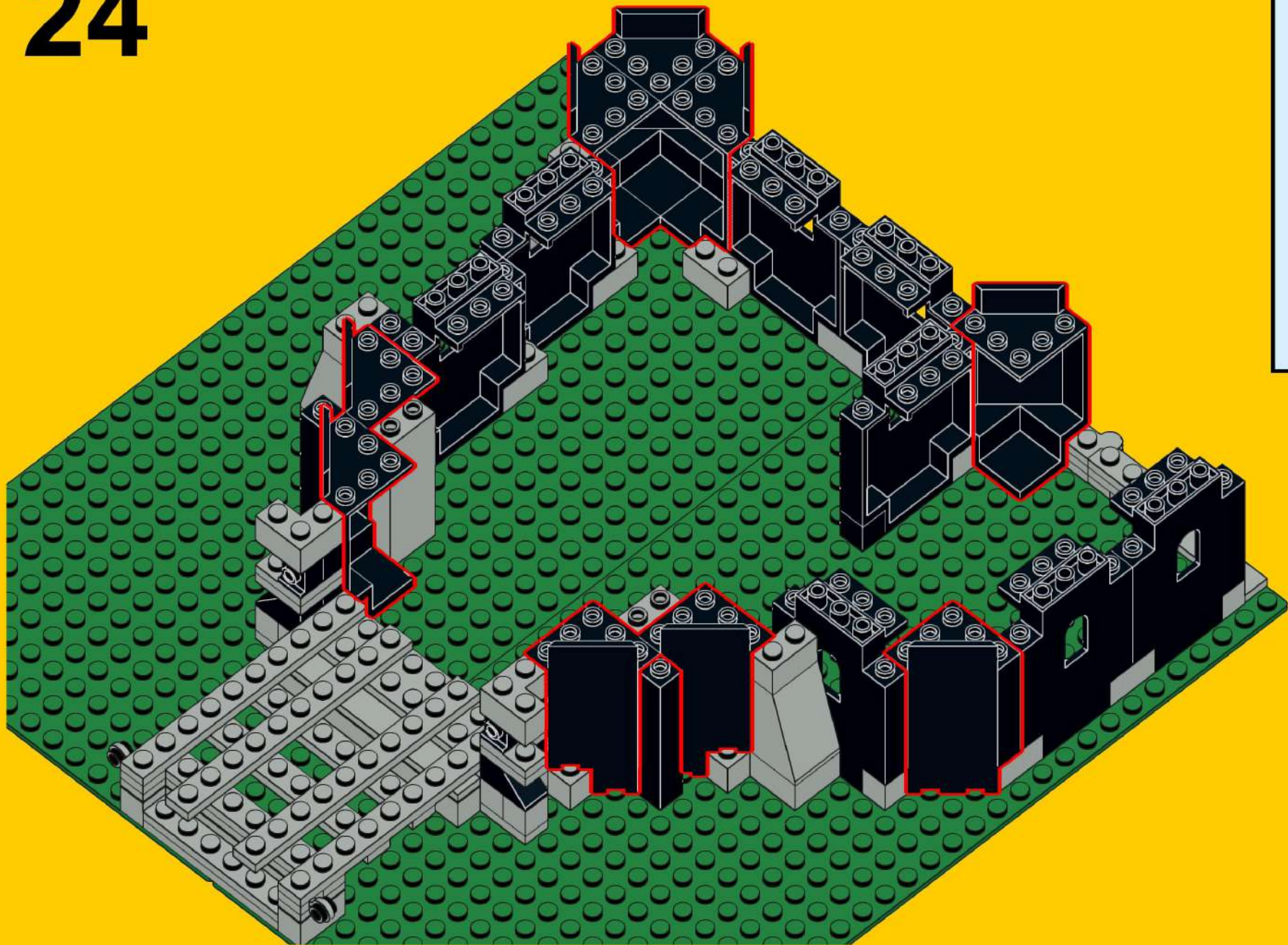

# 25

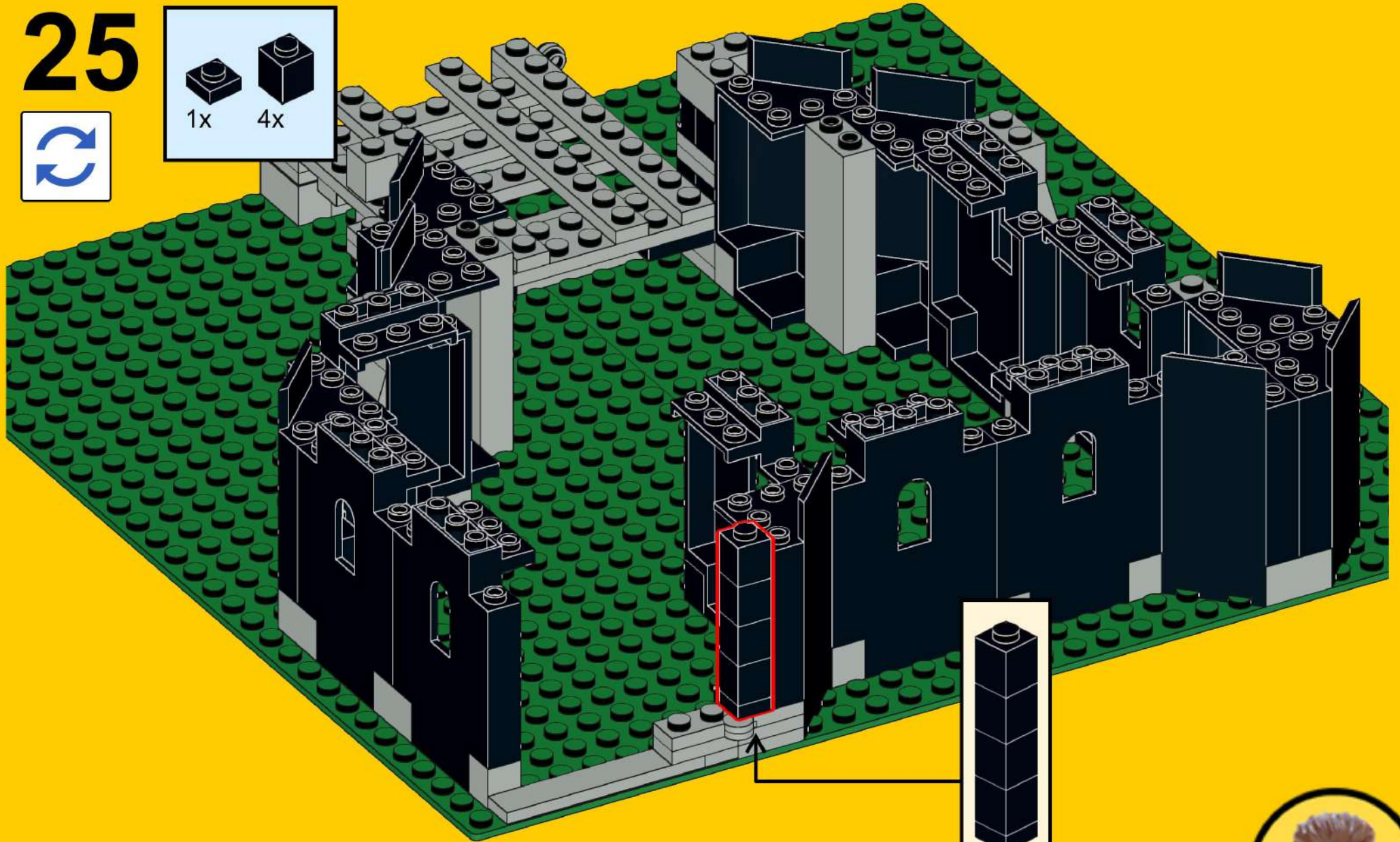
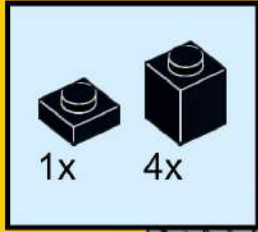

# 26

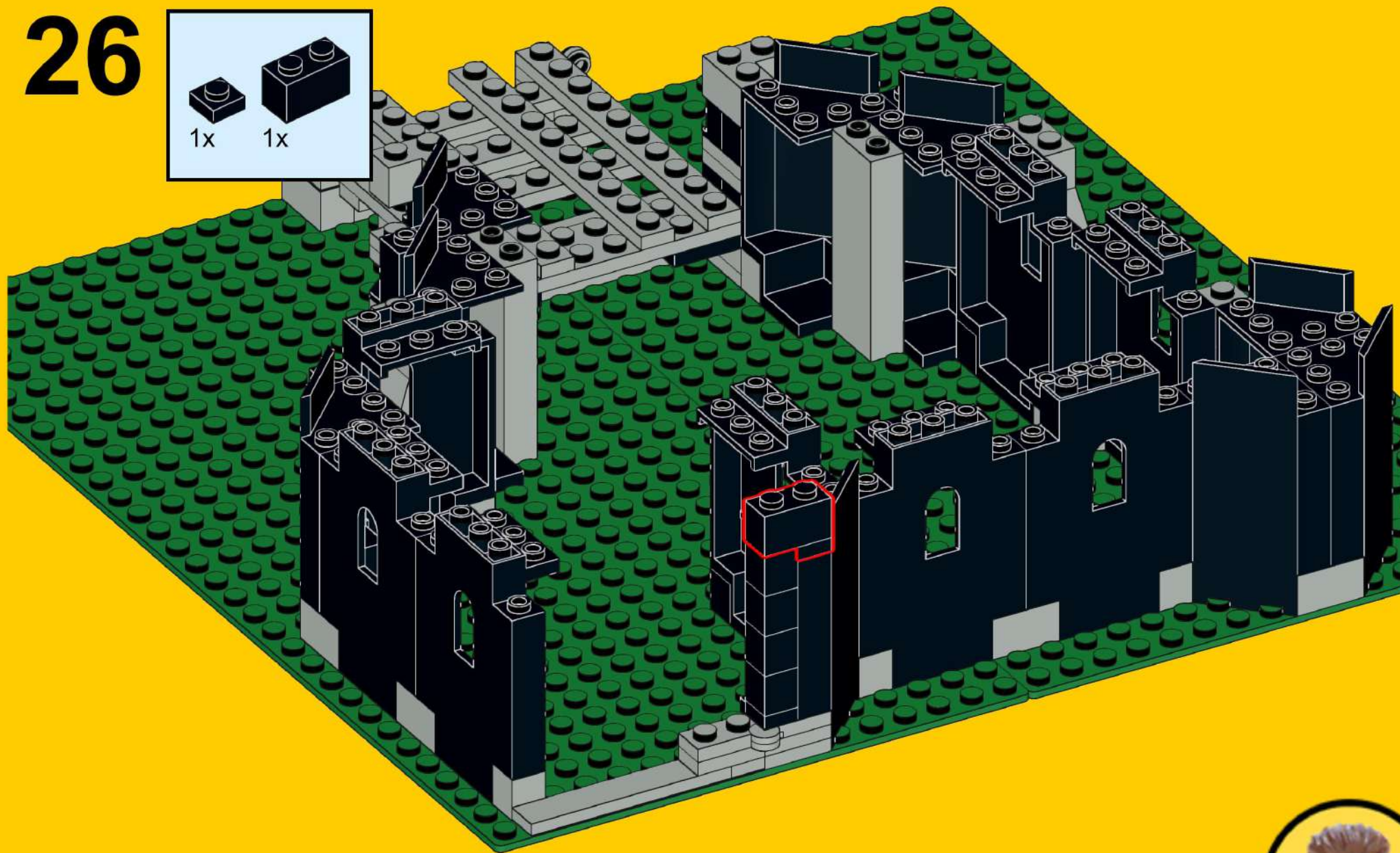
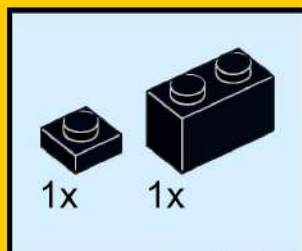

# 27

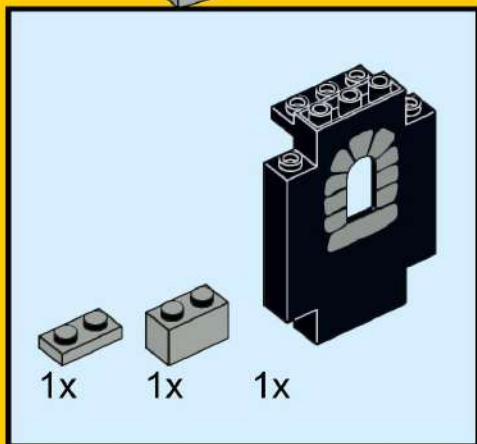
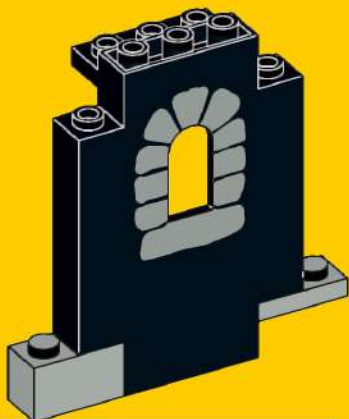
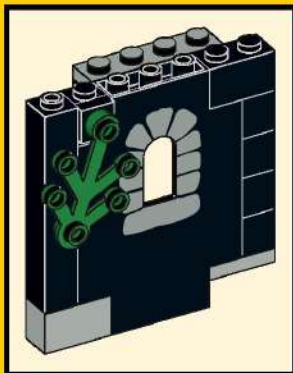

# 28

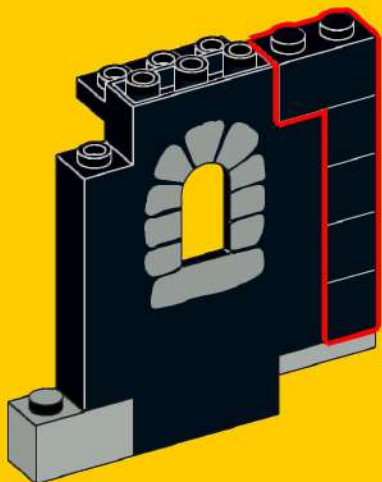
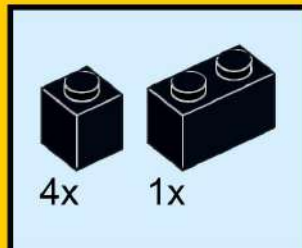

# 29

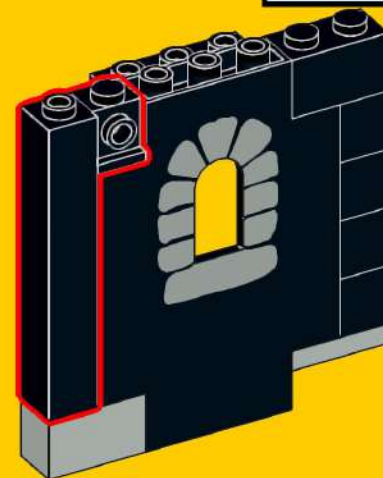
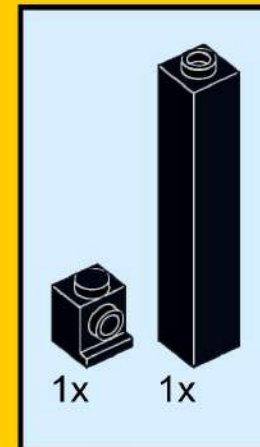

# 30

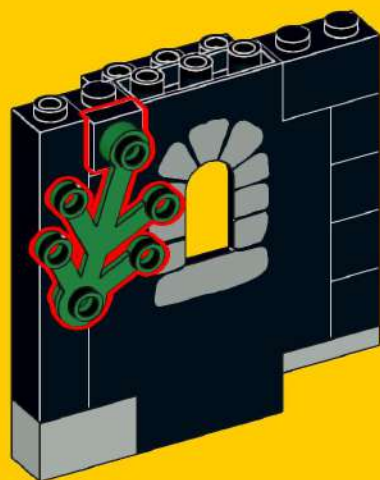
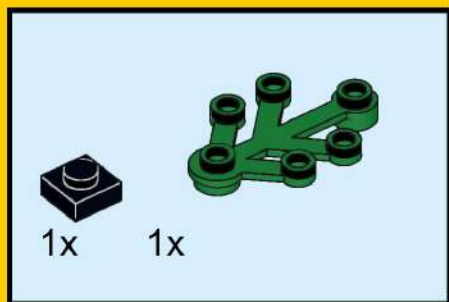

# 31

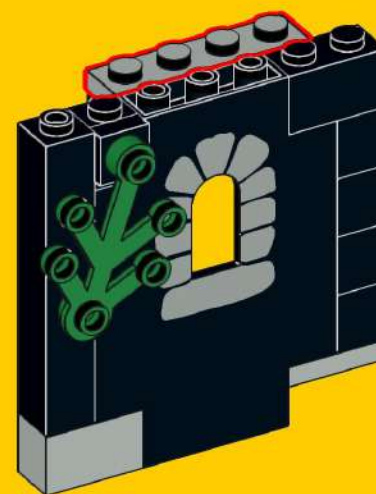
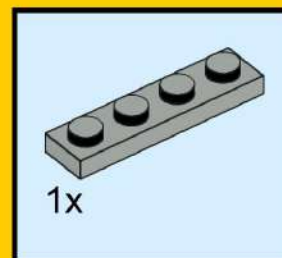

32



# 33

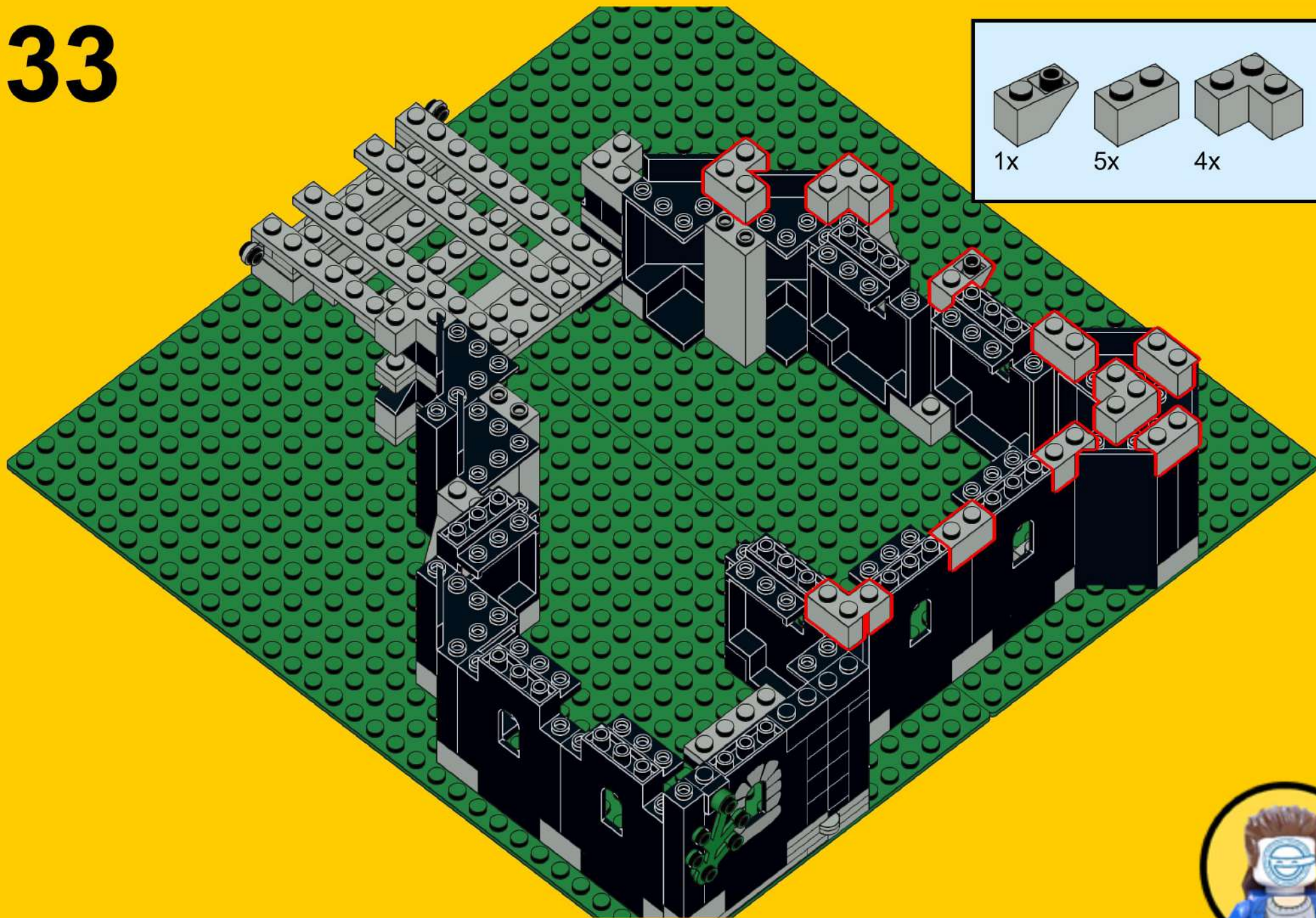

# 34

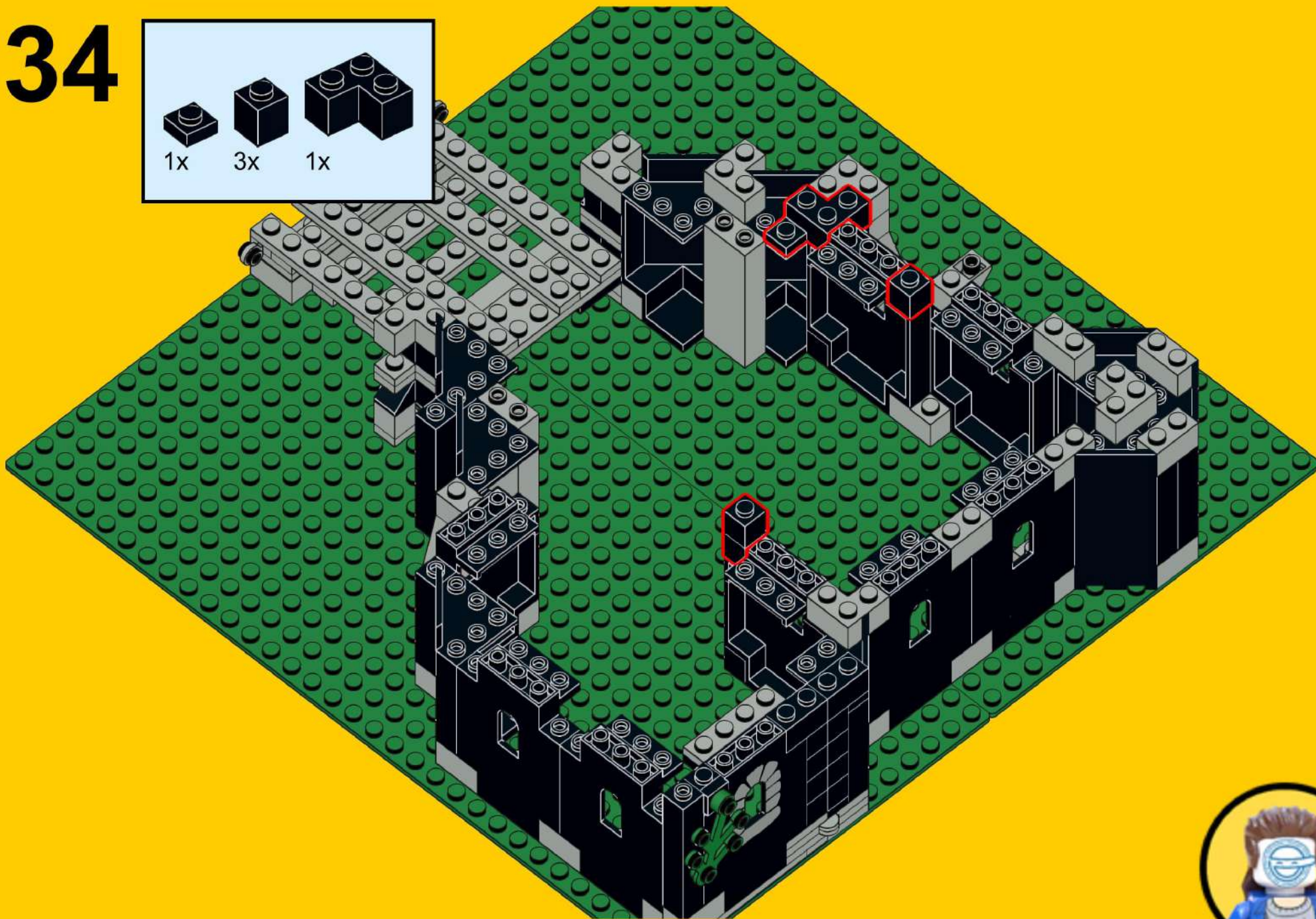
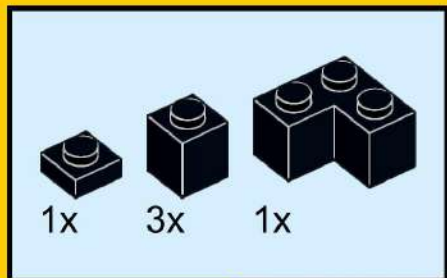



# 35

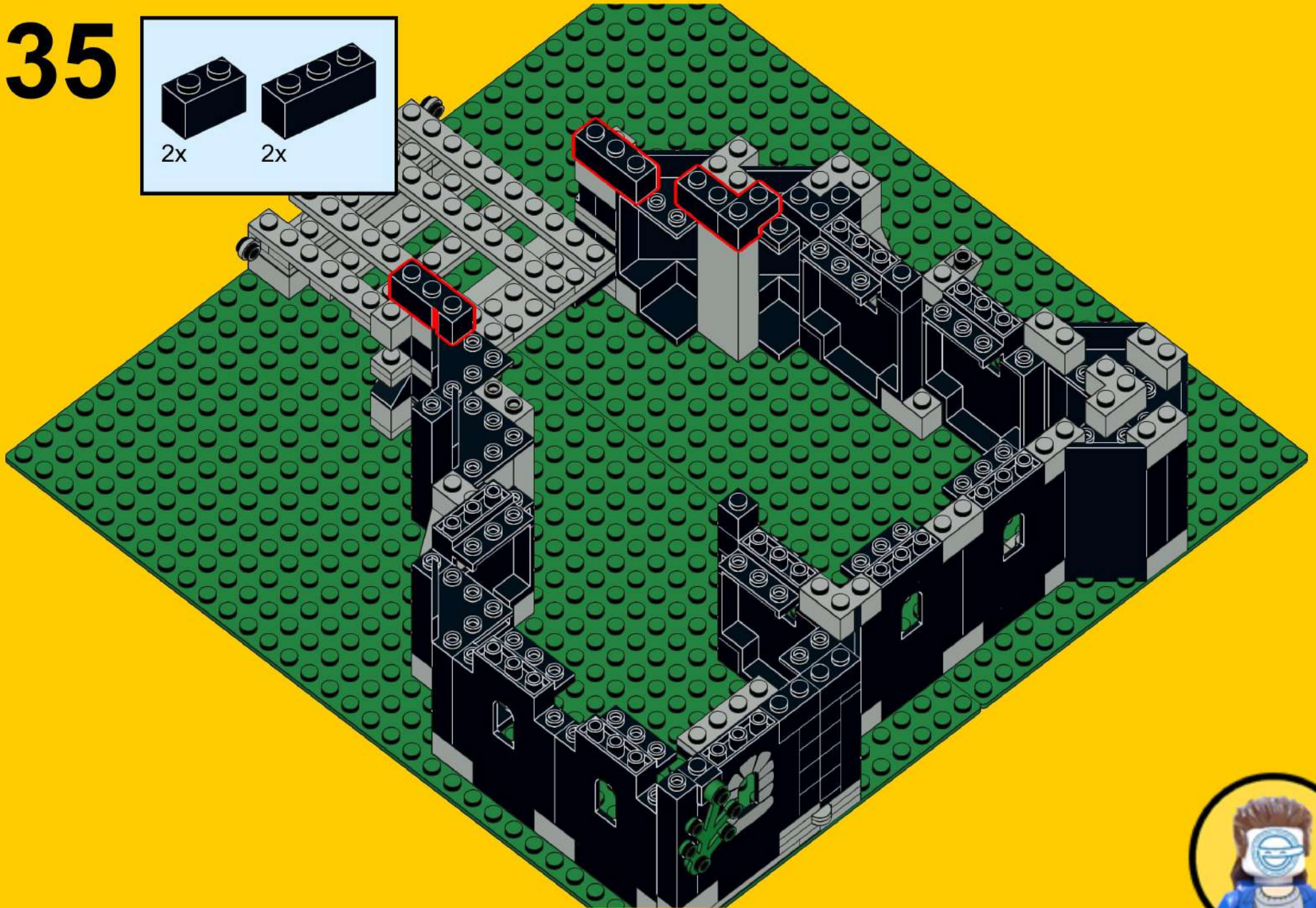
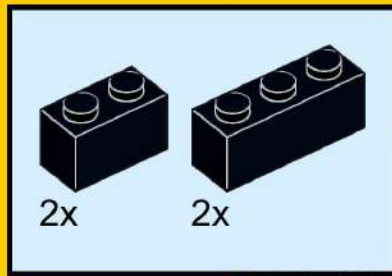

# 36

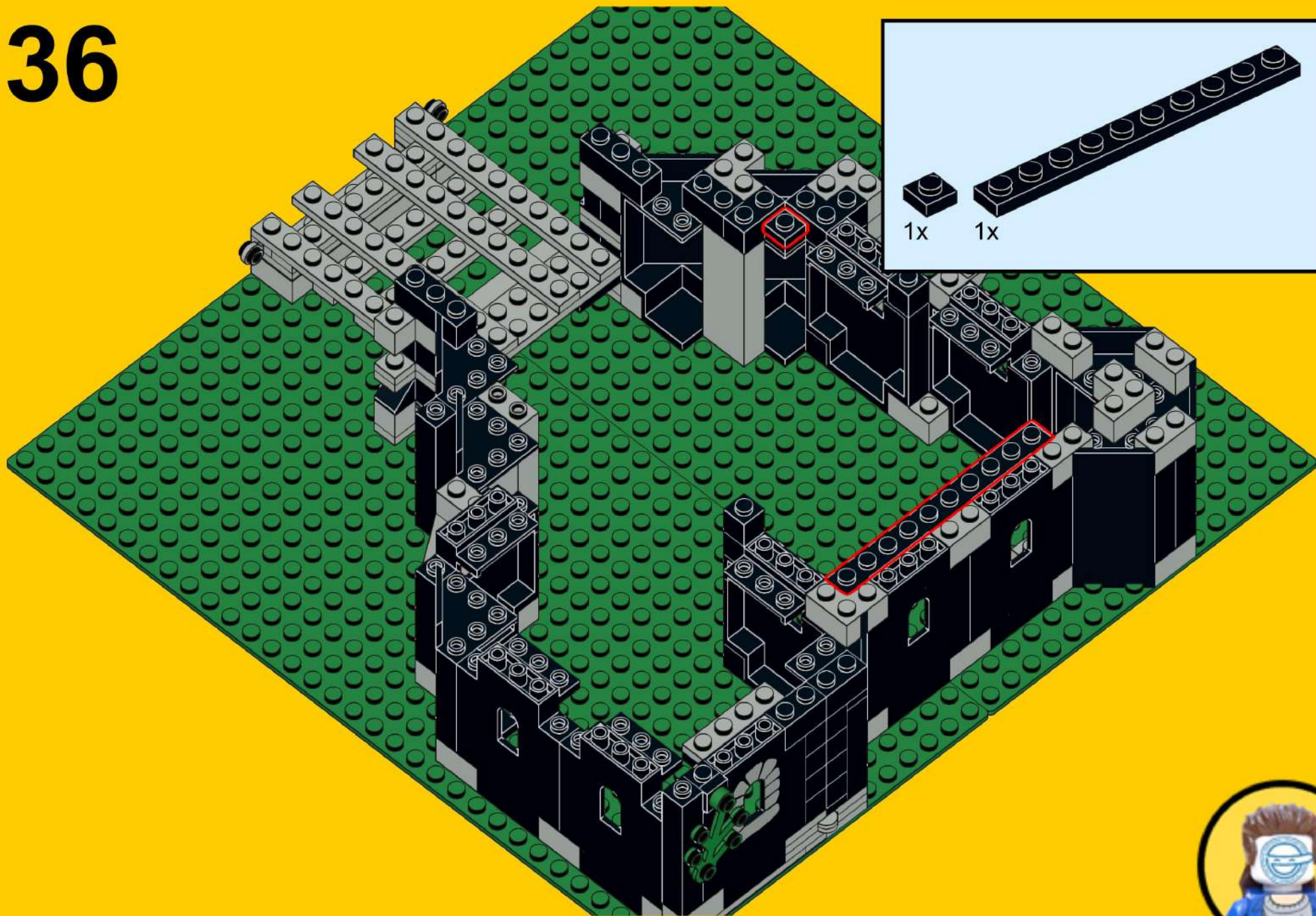

# 37

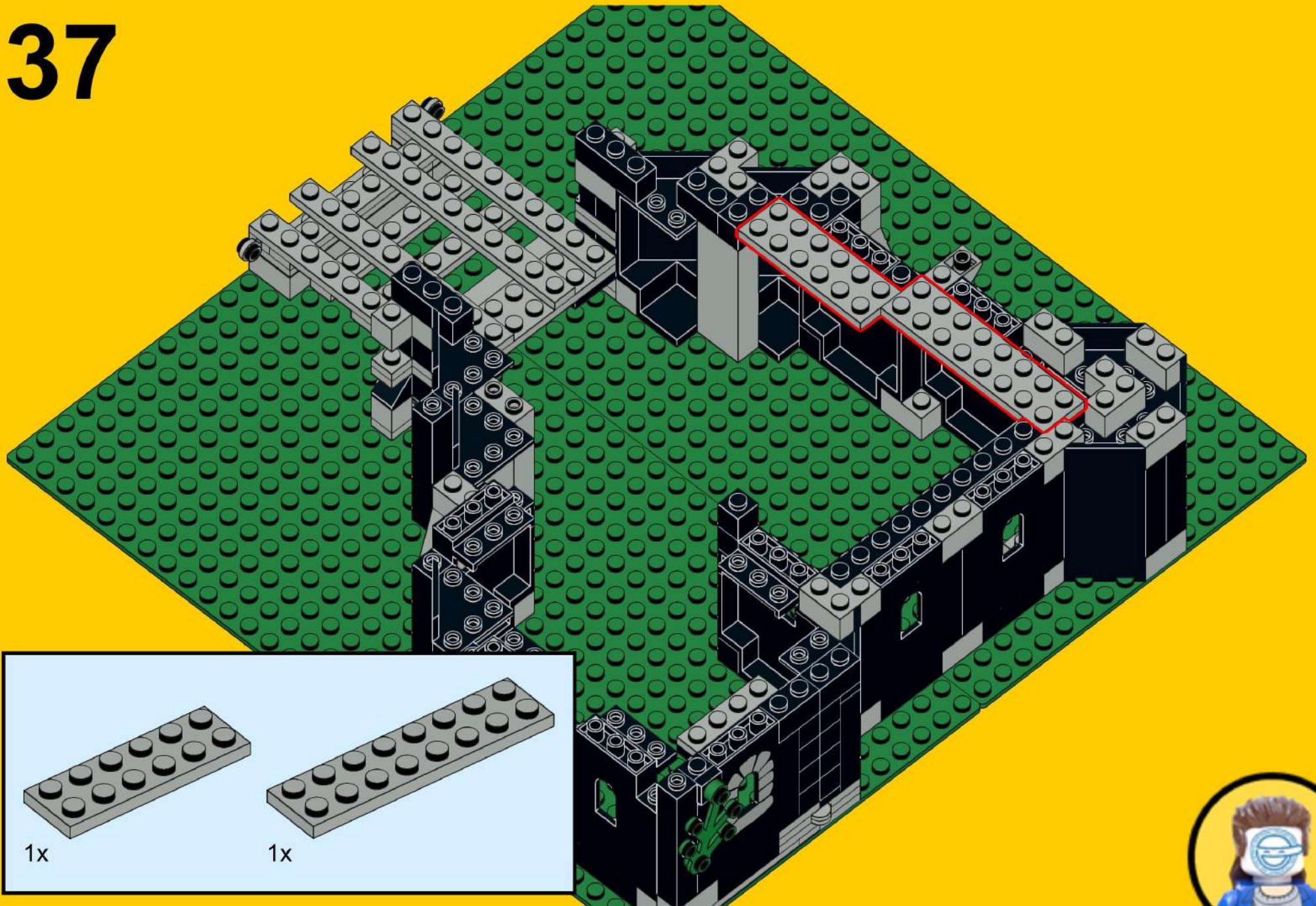

# 38

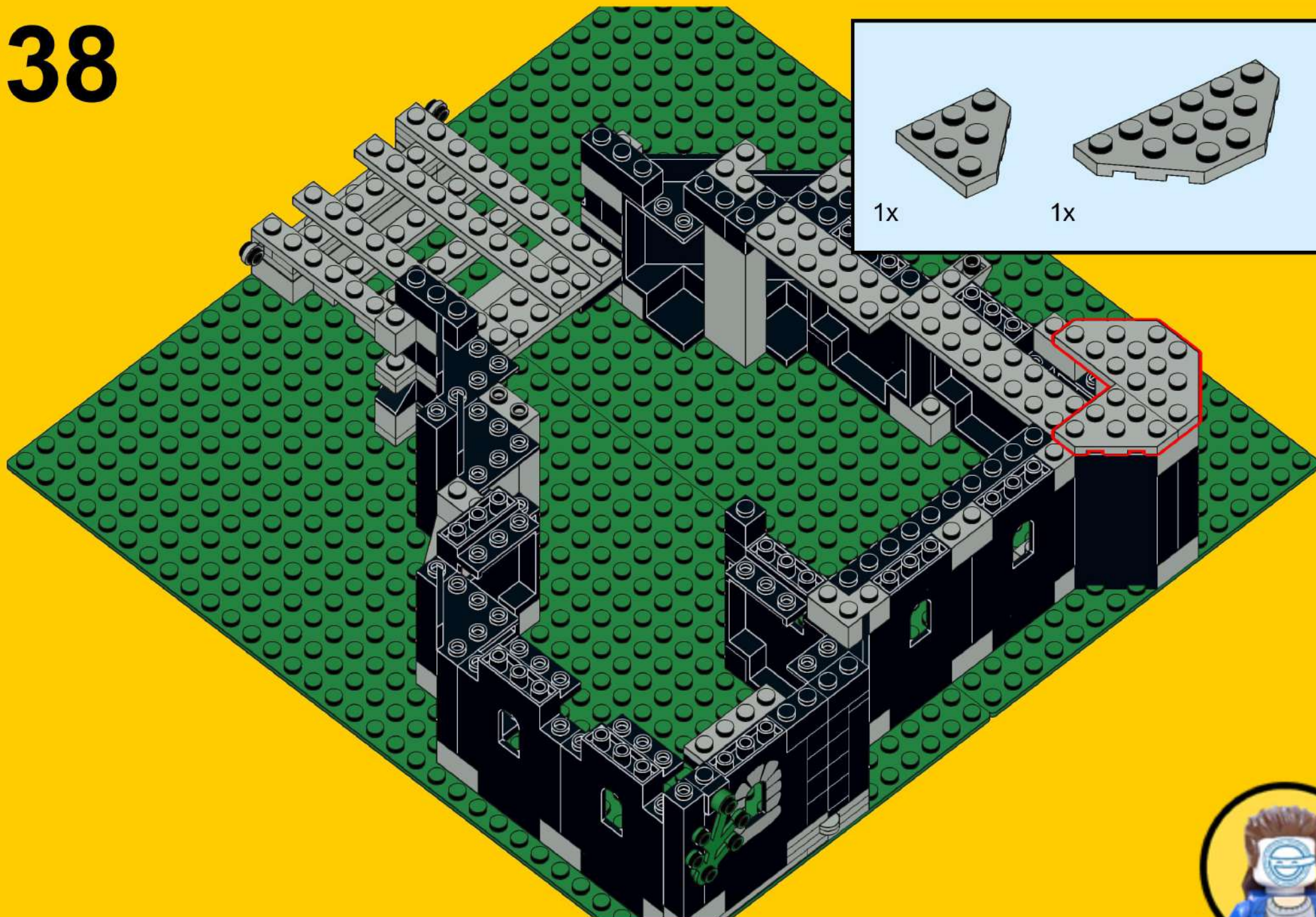

# 39

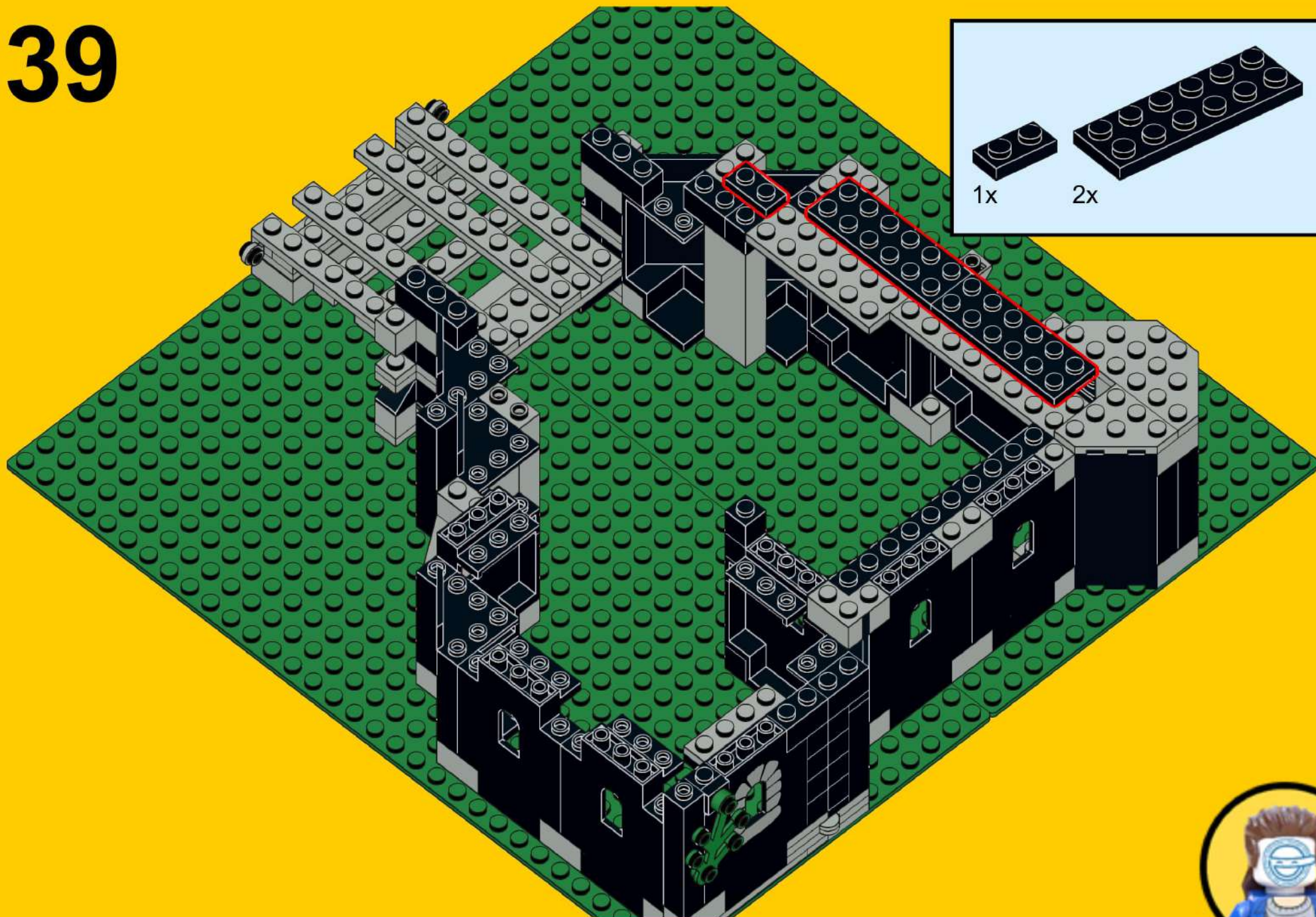

# 40

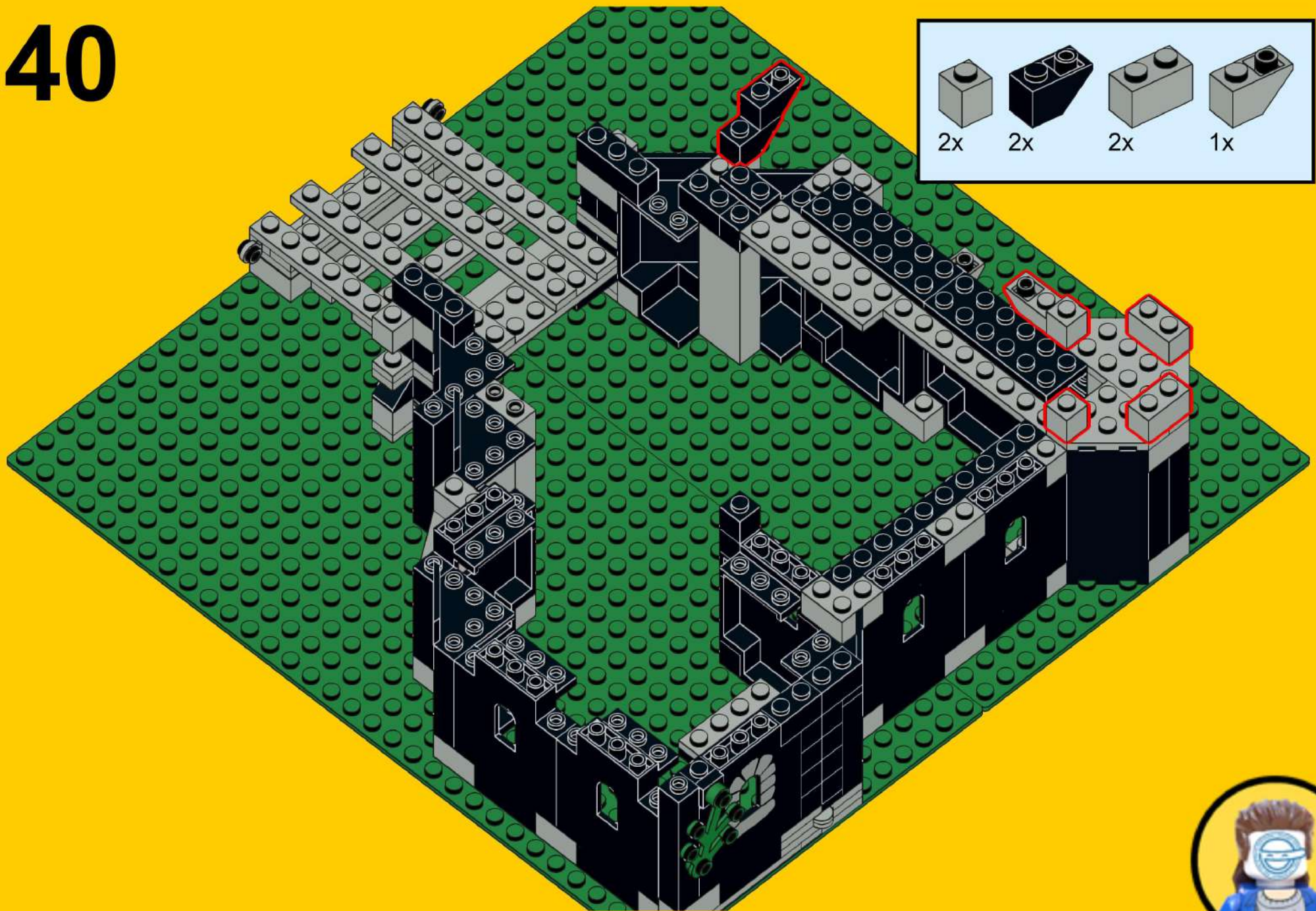

# 41

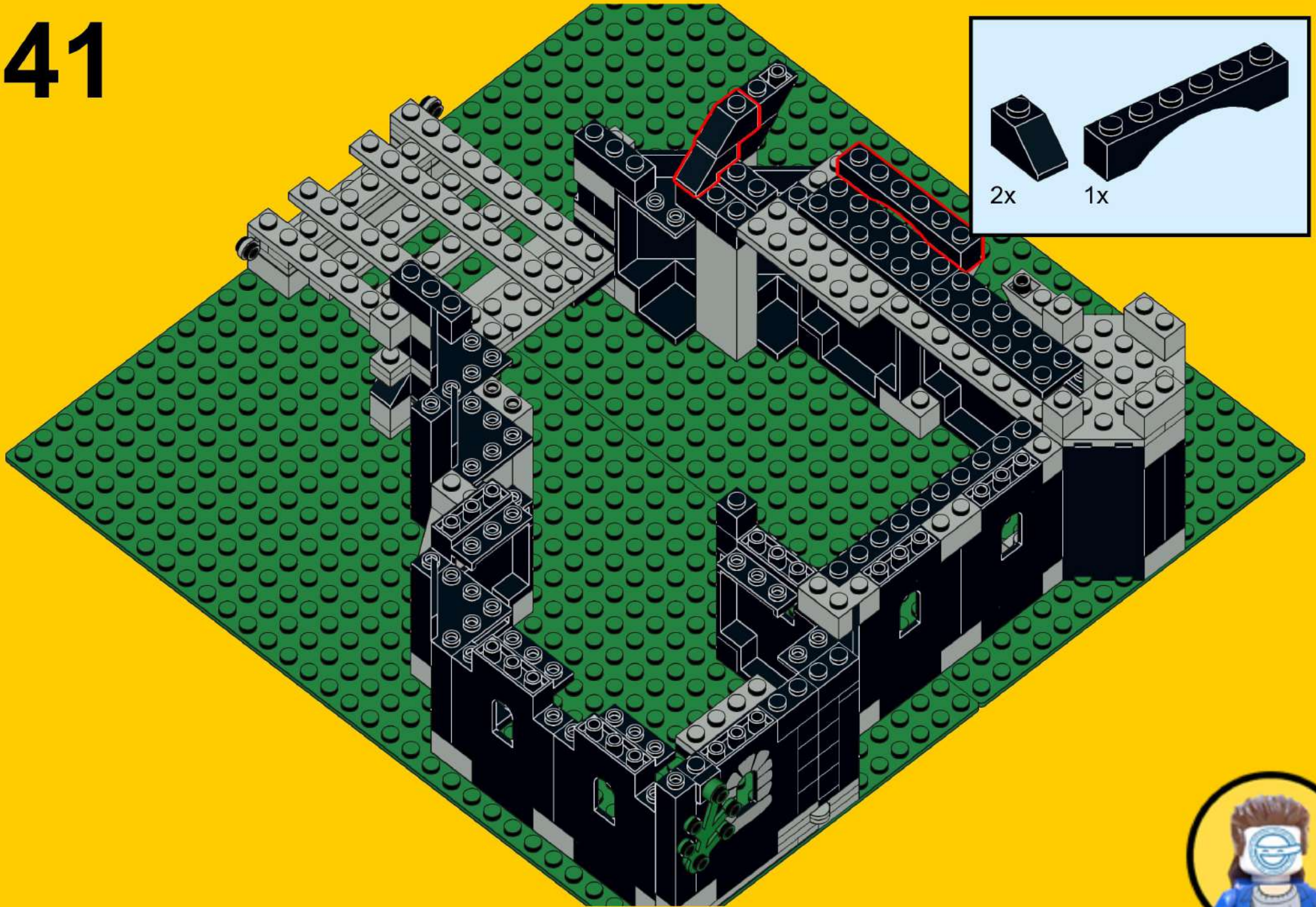

# 42

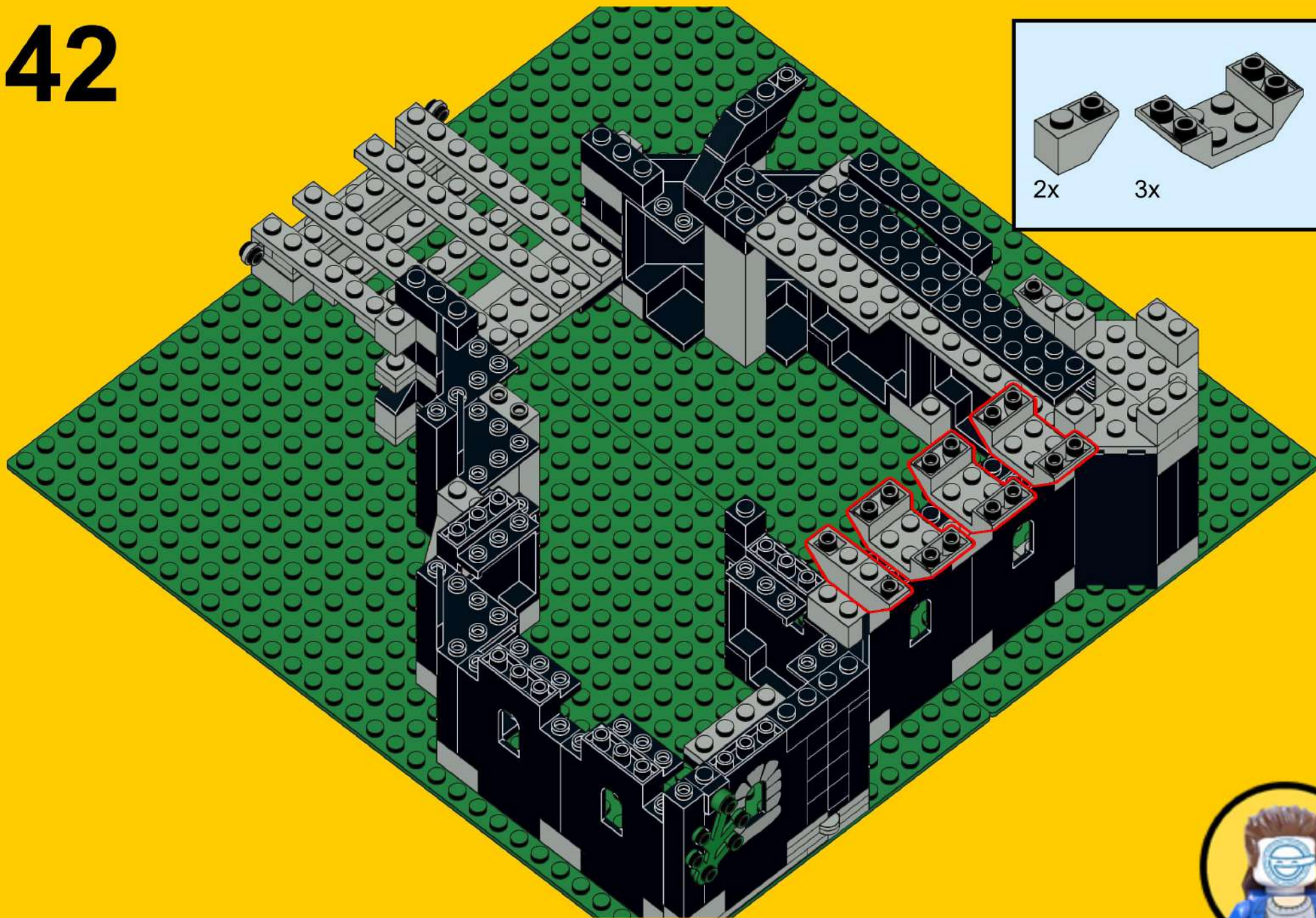



# 43

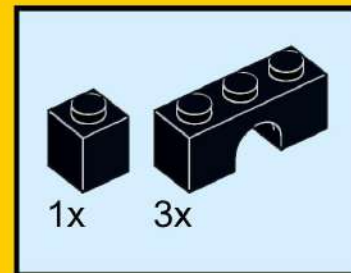

# 44

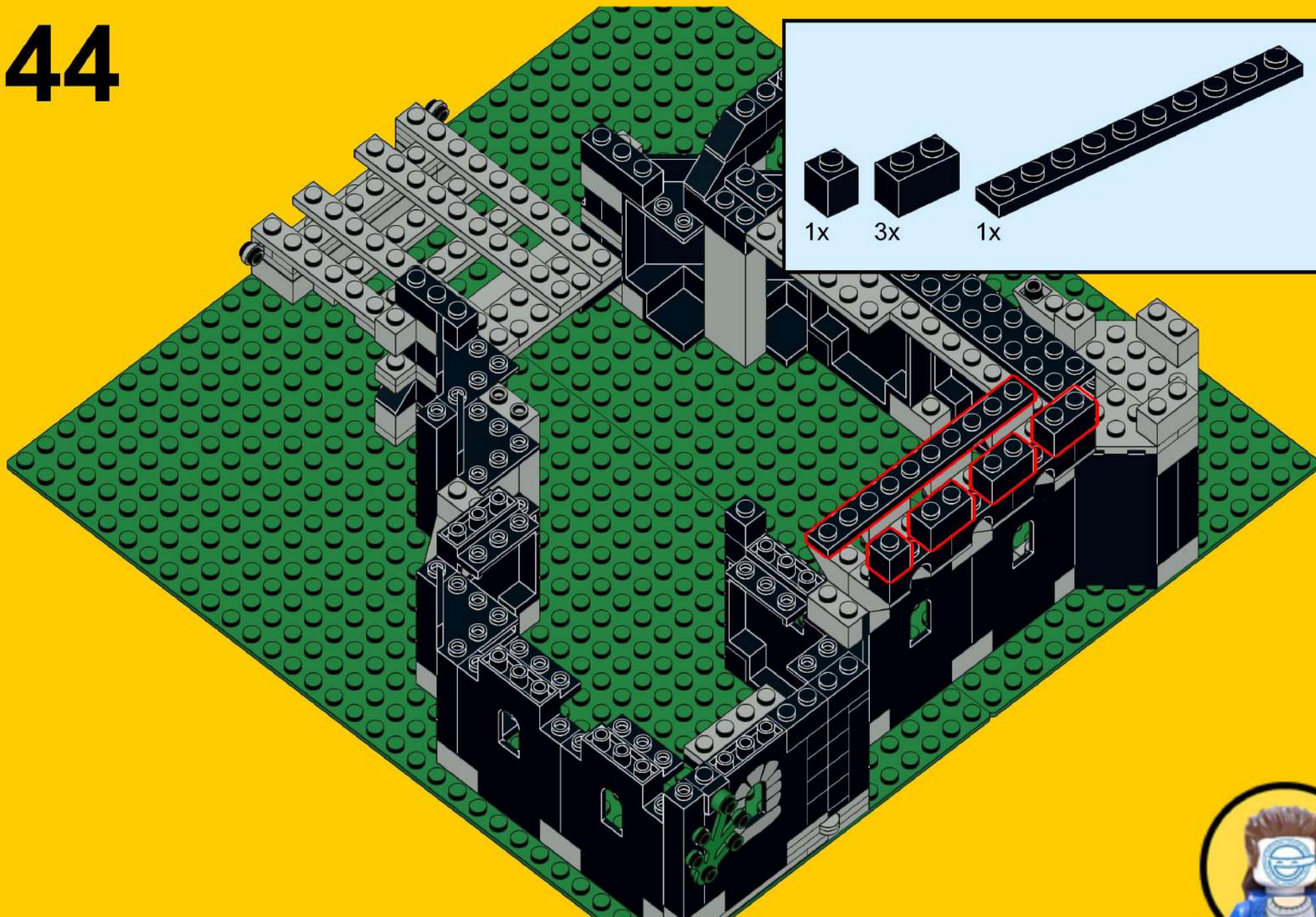

# 45

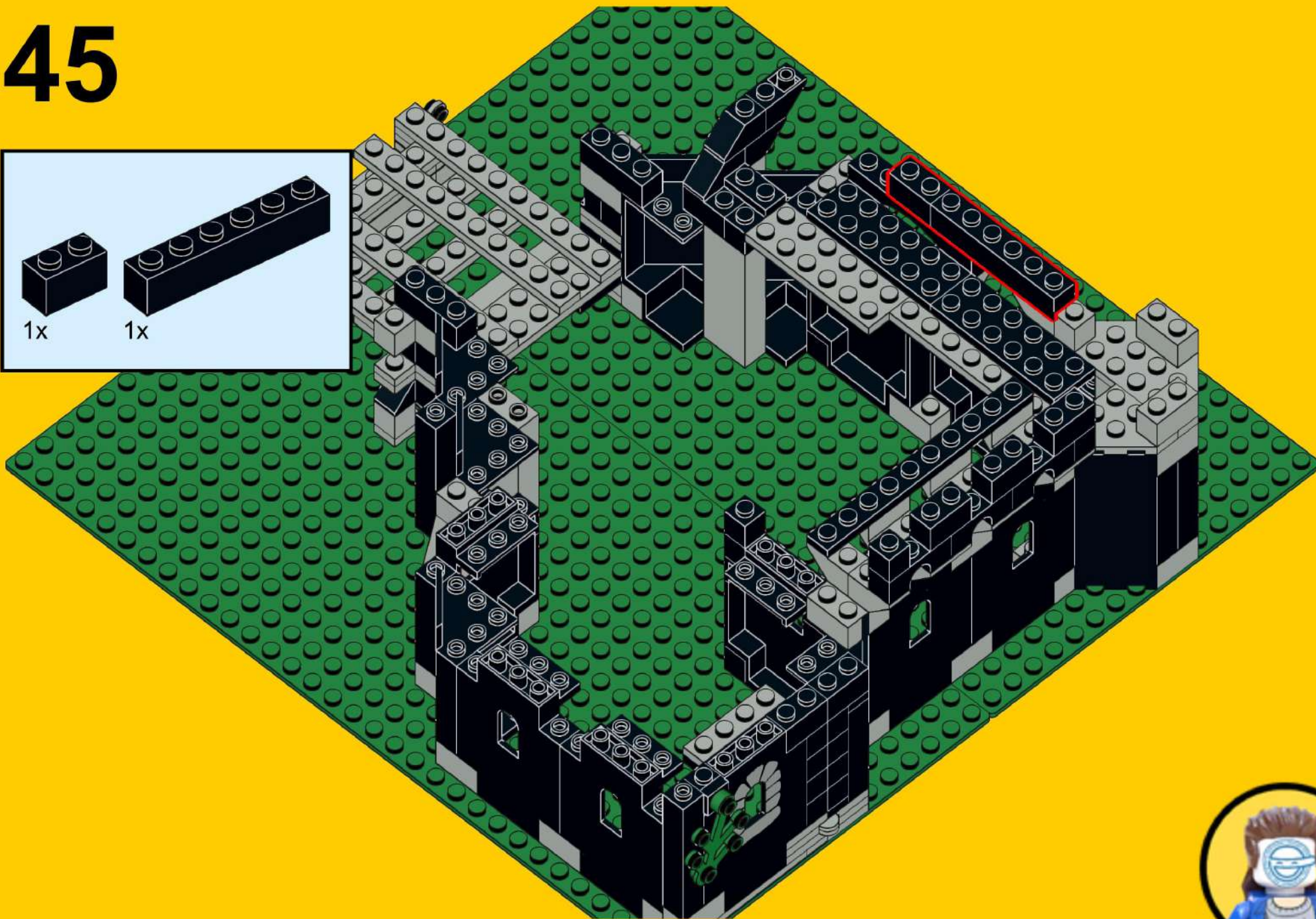
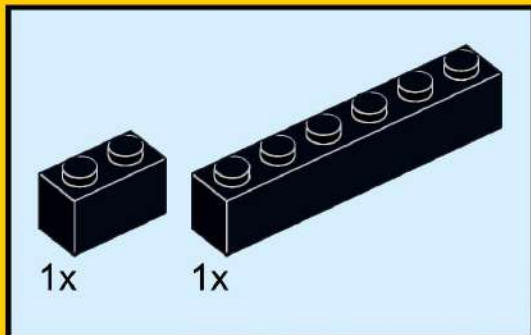

# 46

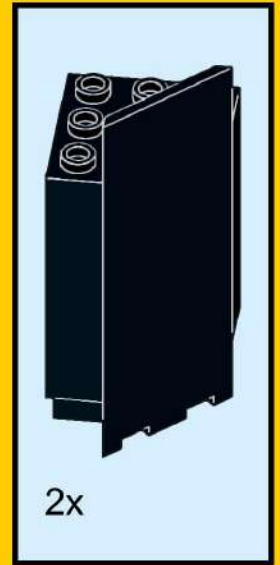
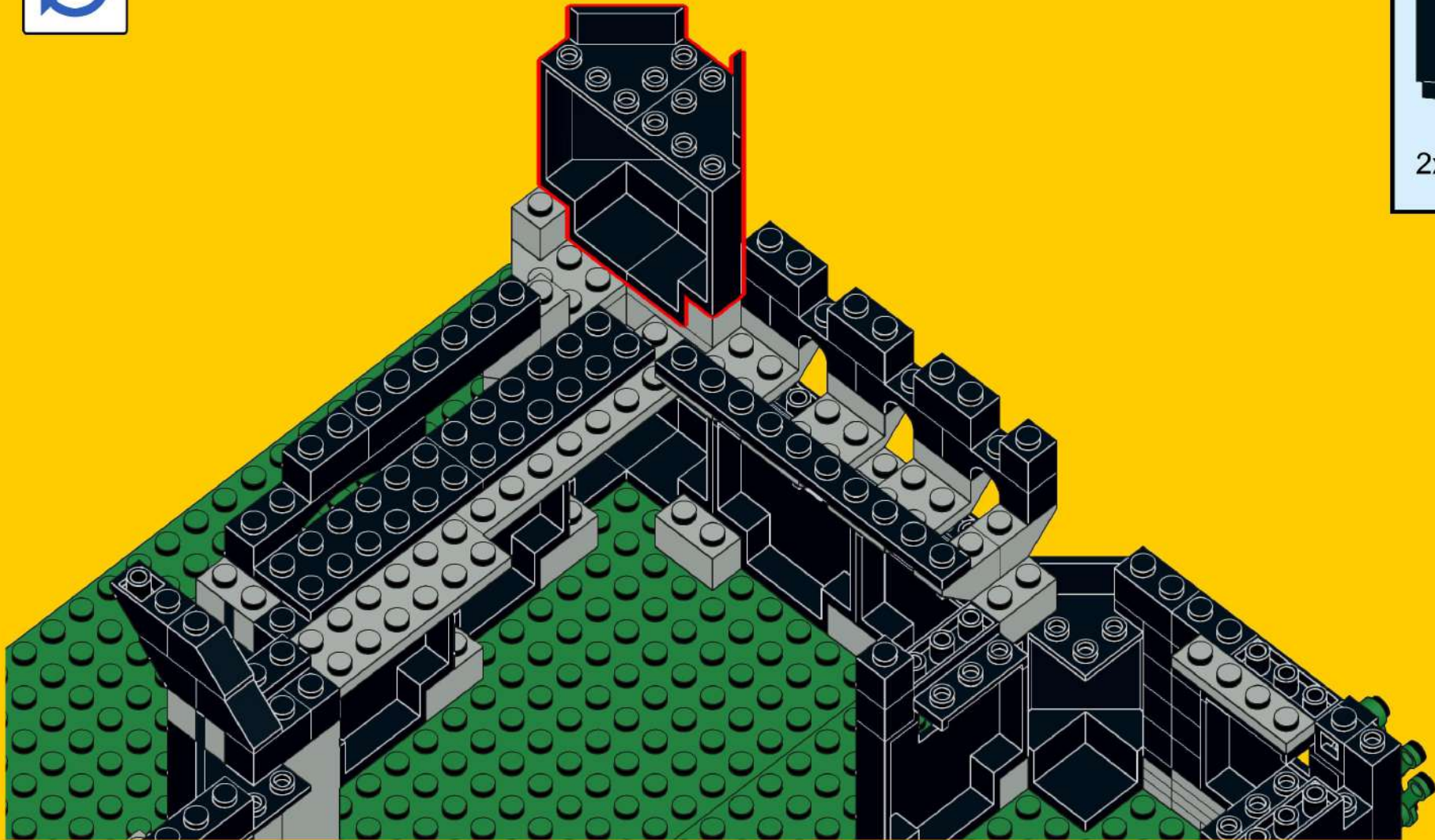

# 47

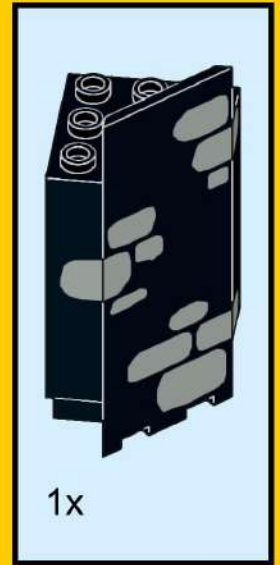
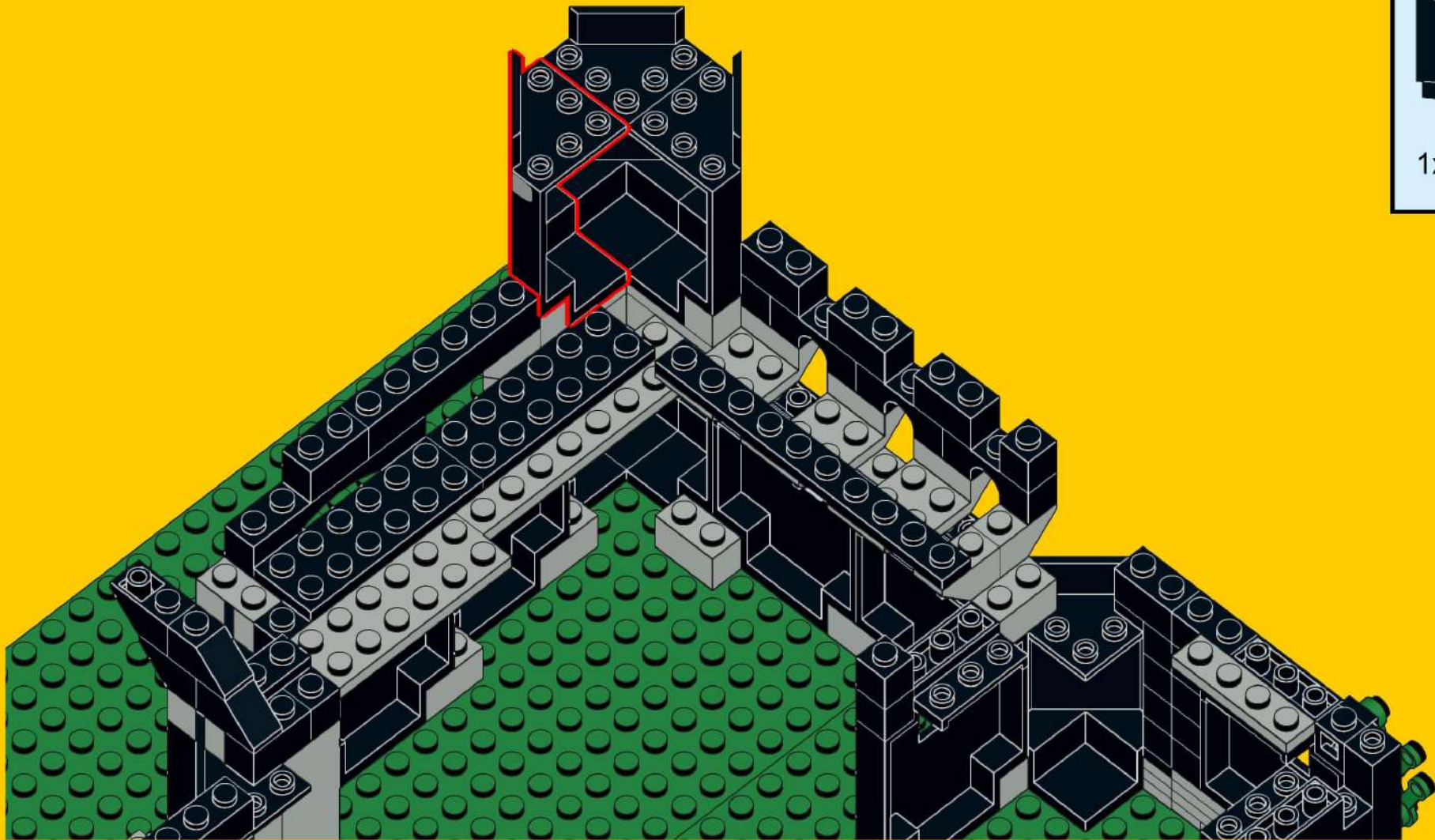

# 48

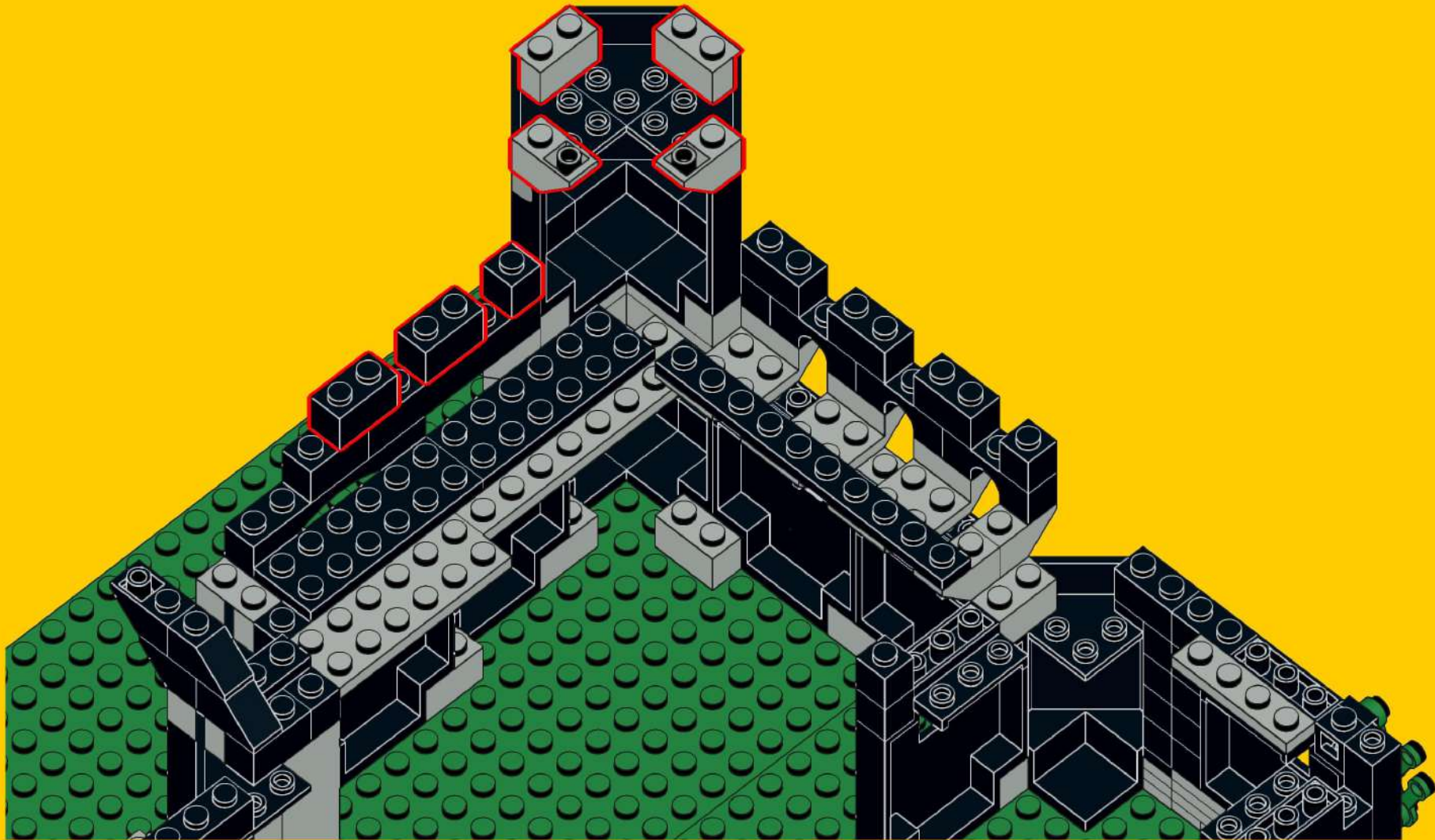
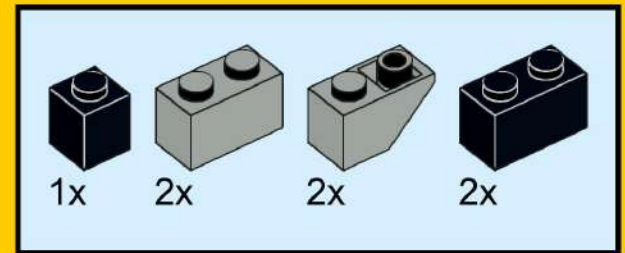

# 49

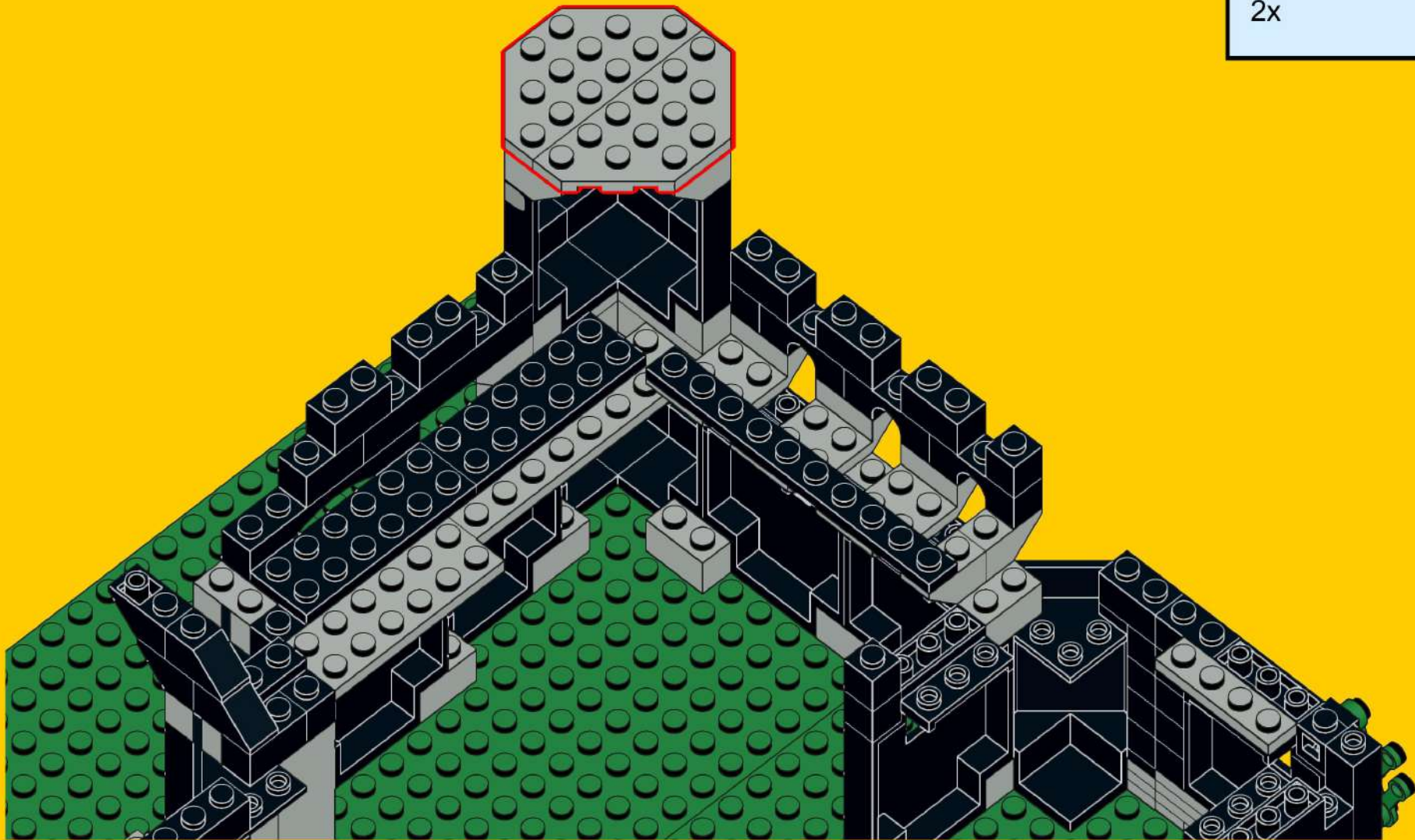
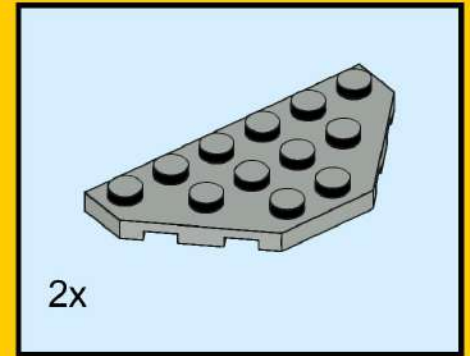

# 50

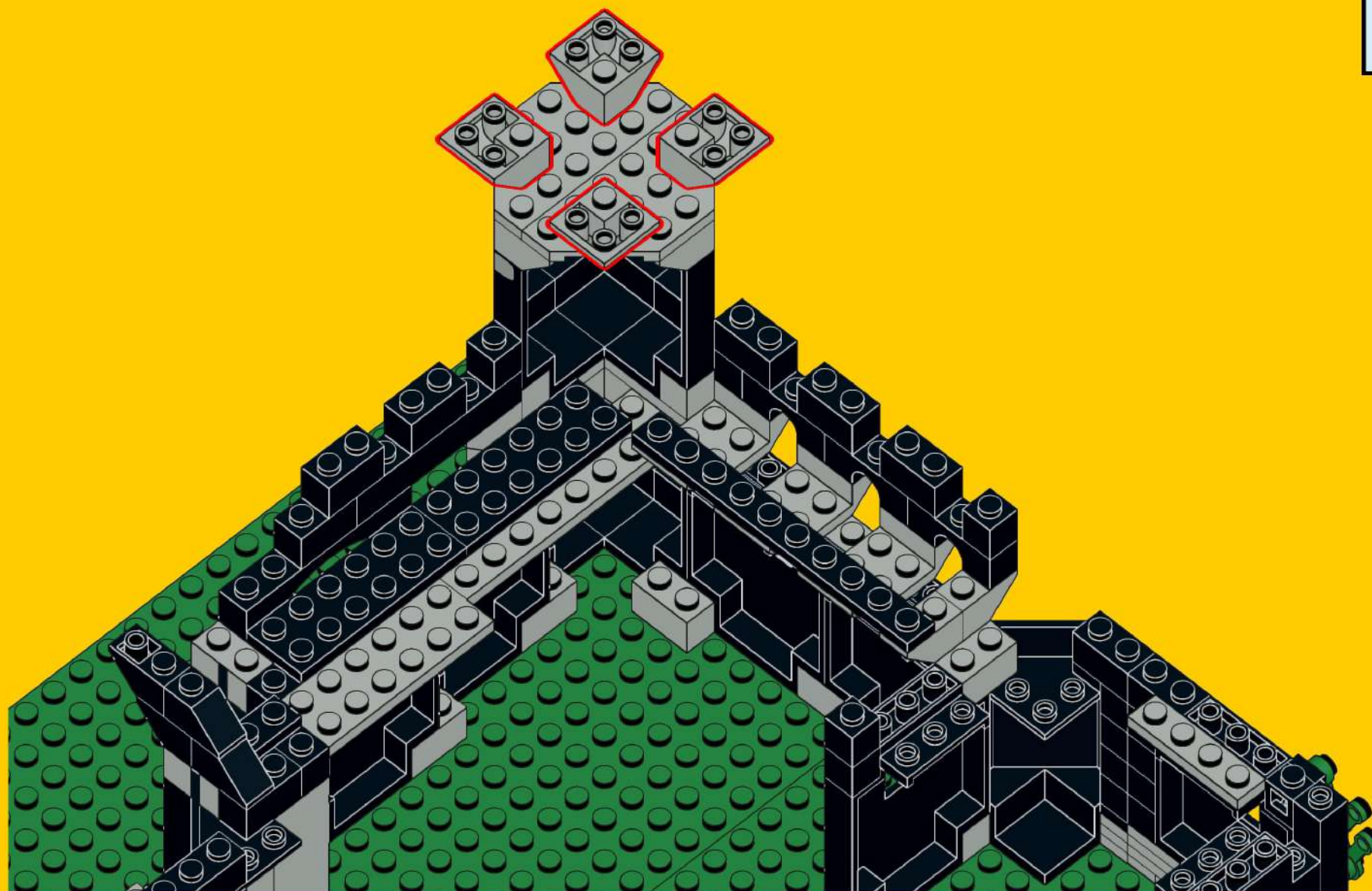
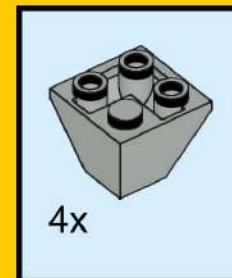



# 51

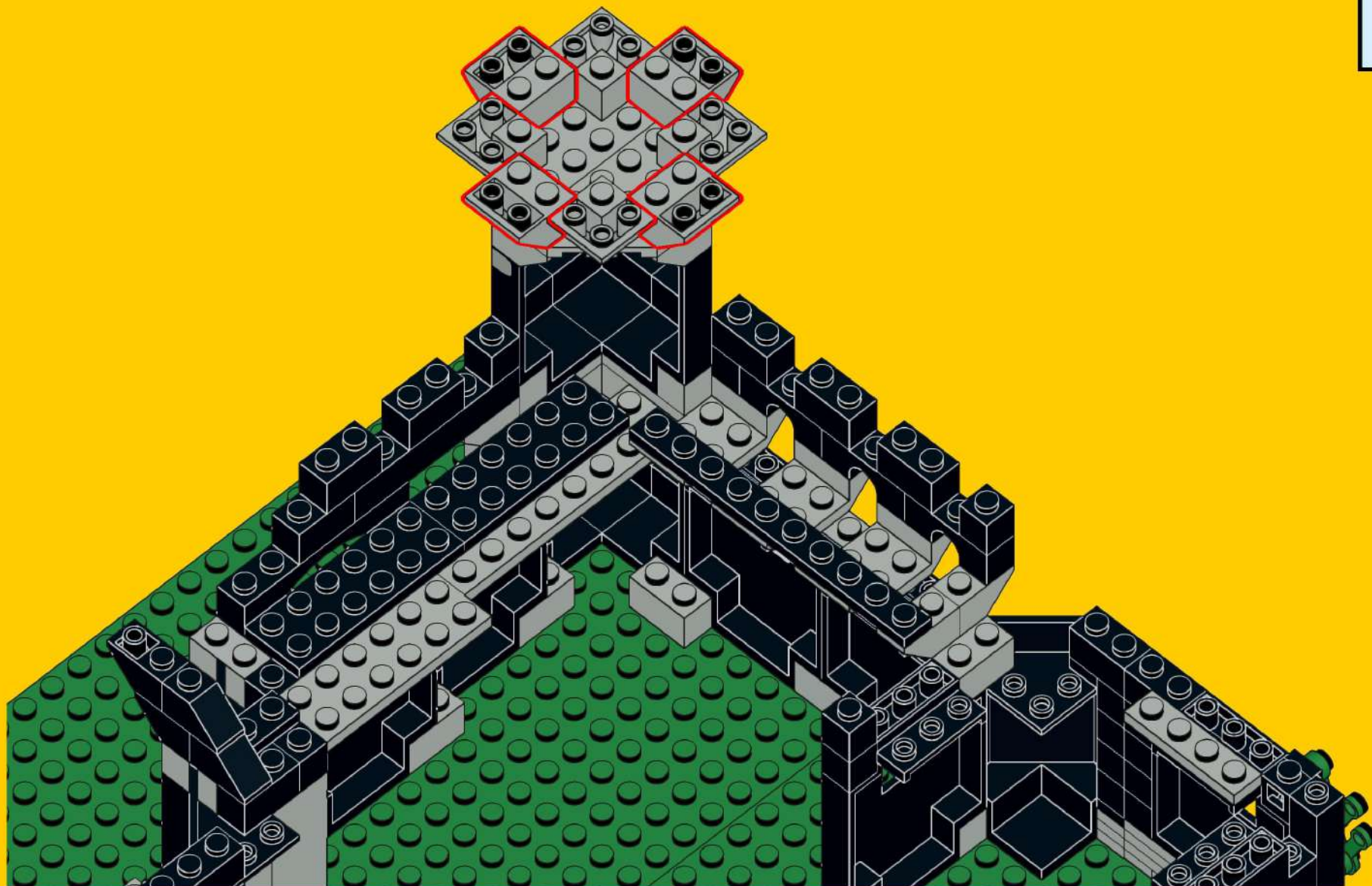
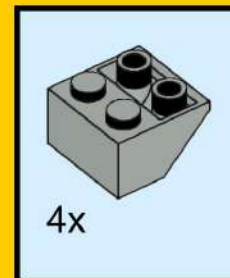

# 52

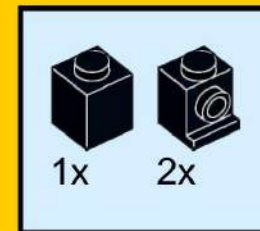

# 53

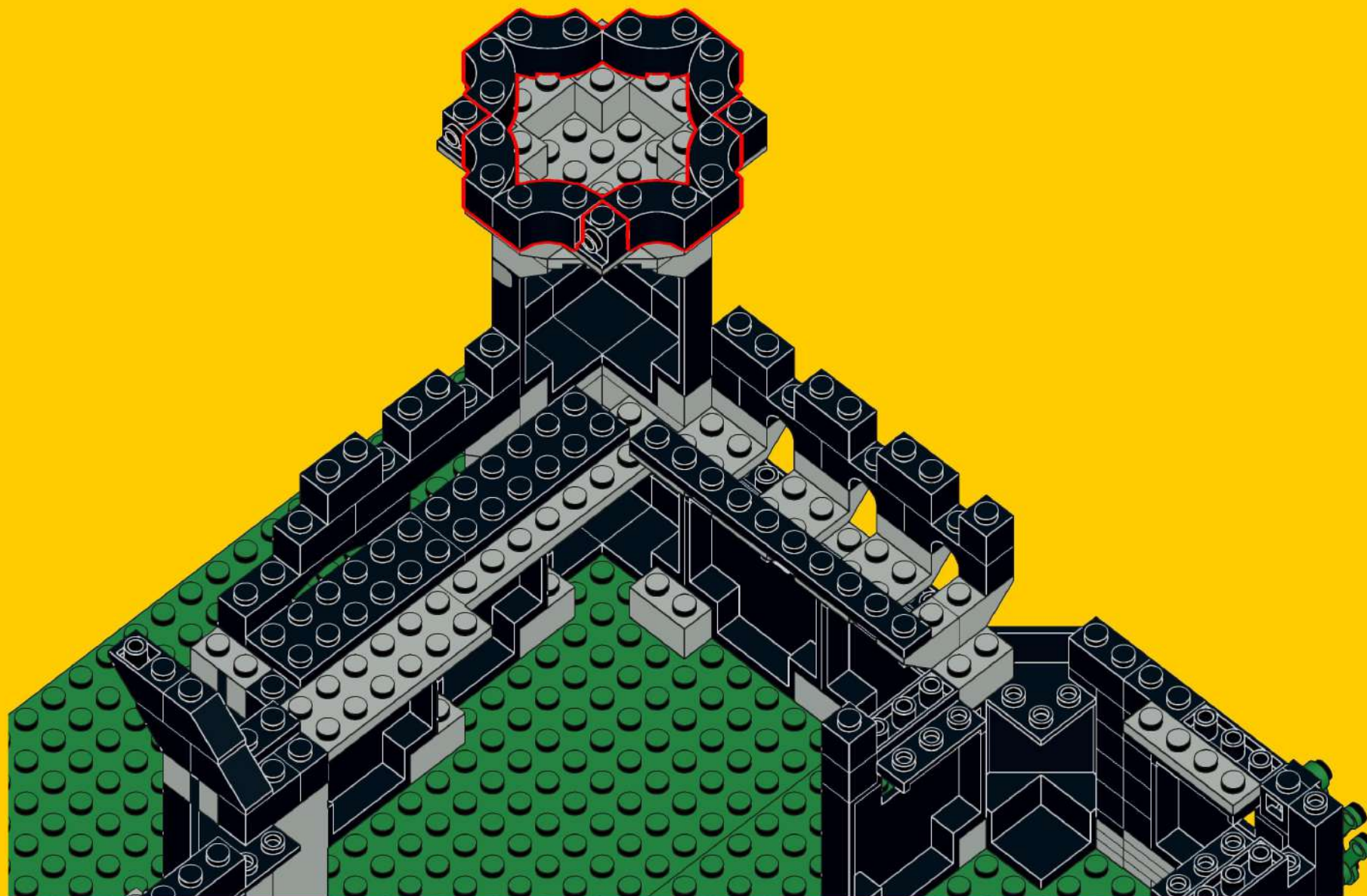

# 54

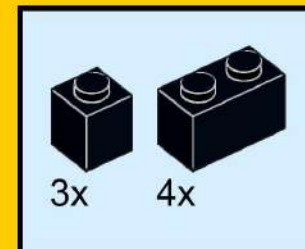

# 55

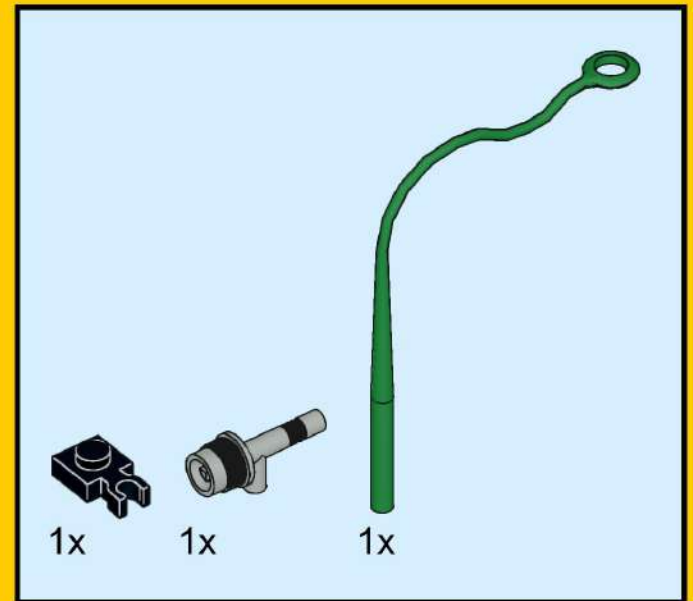
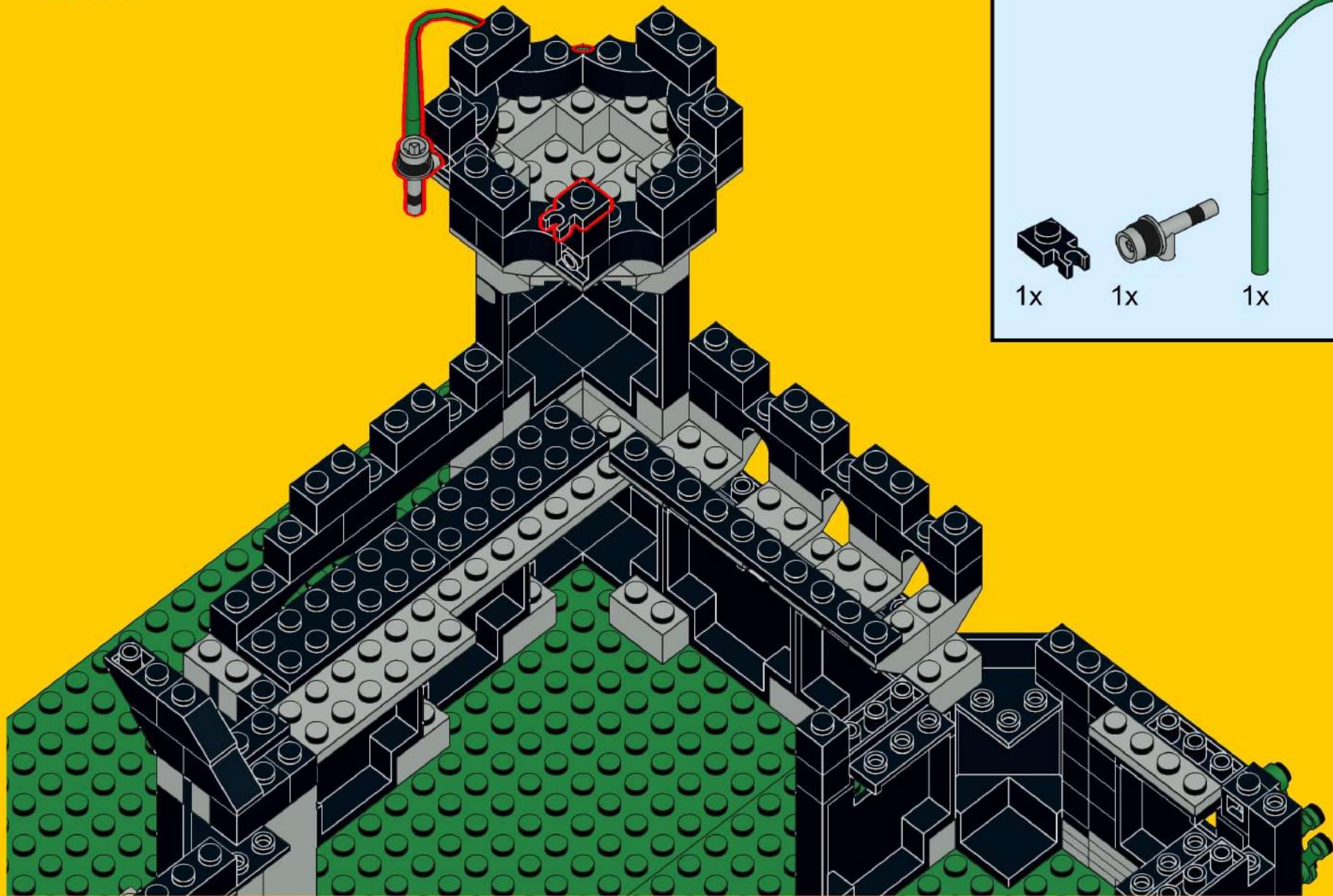

# 56

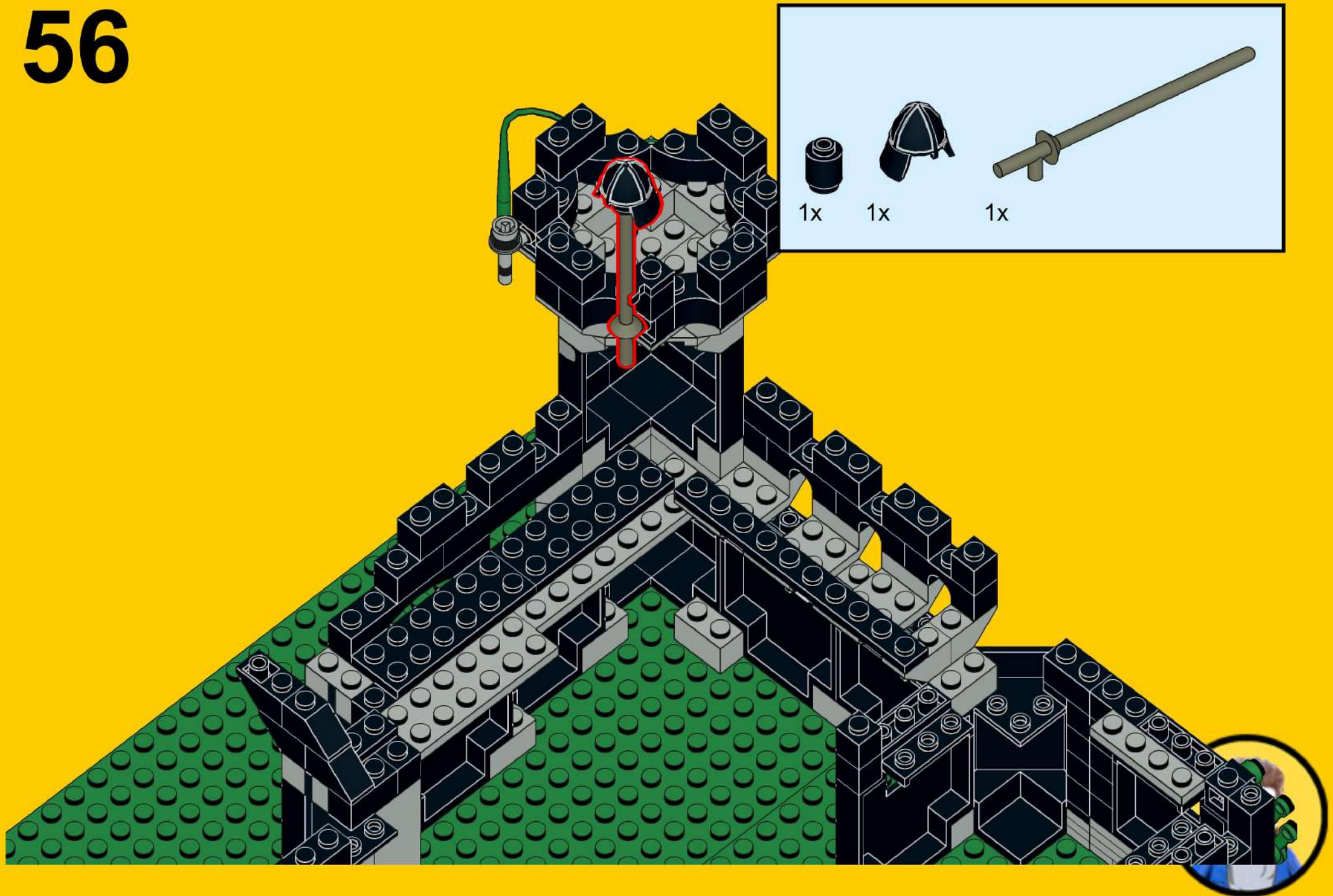

# 57

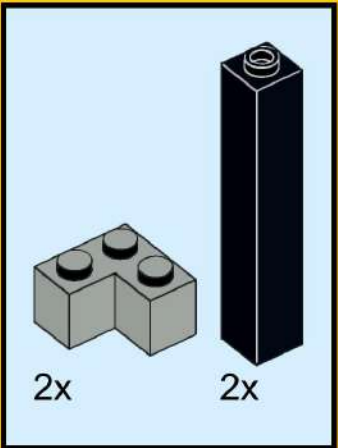
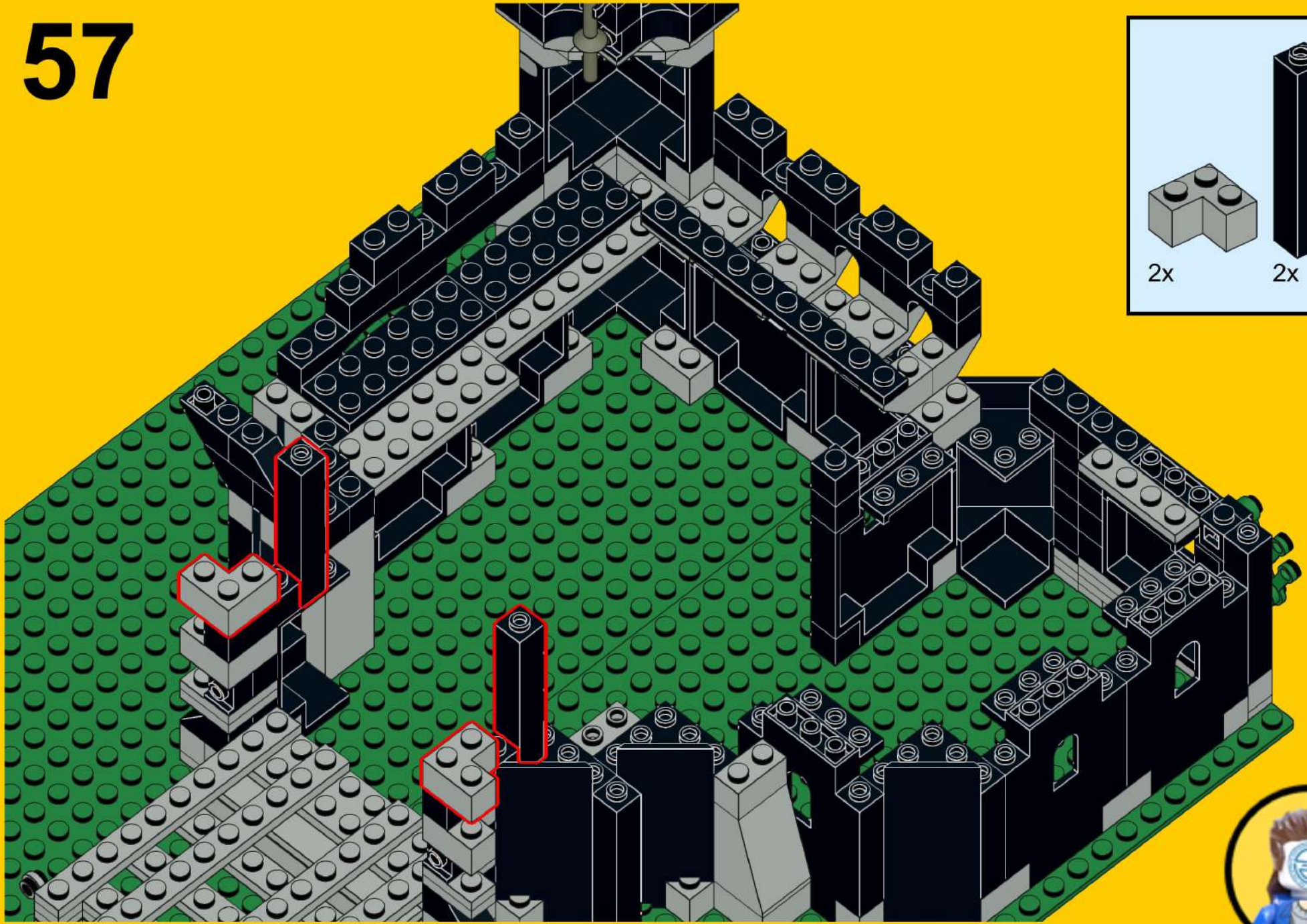

# 58

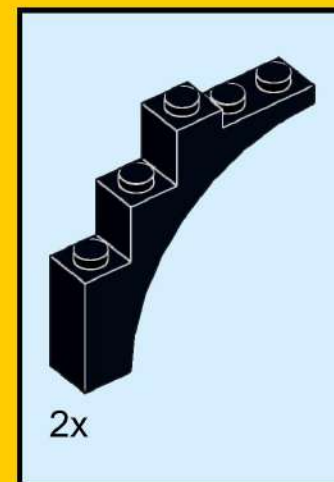



# 59

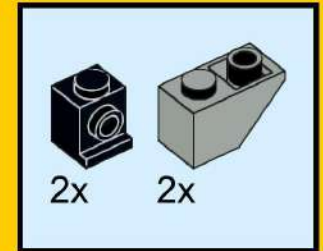

# 60

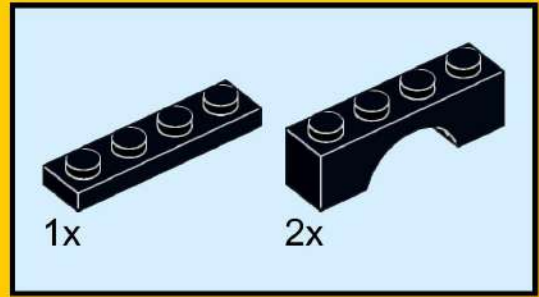
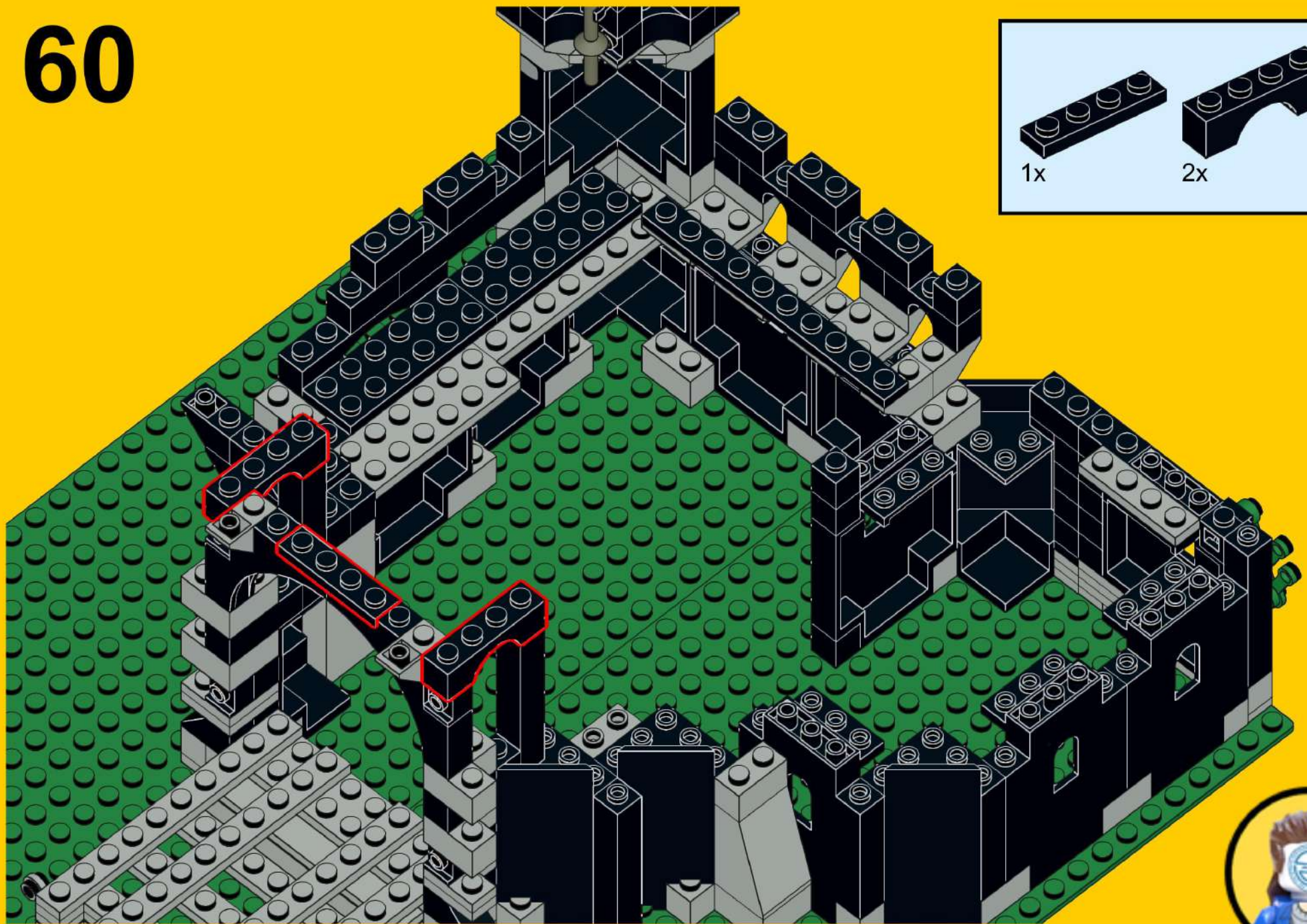

61

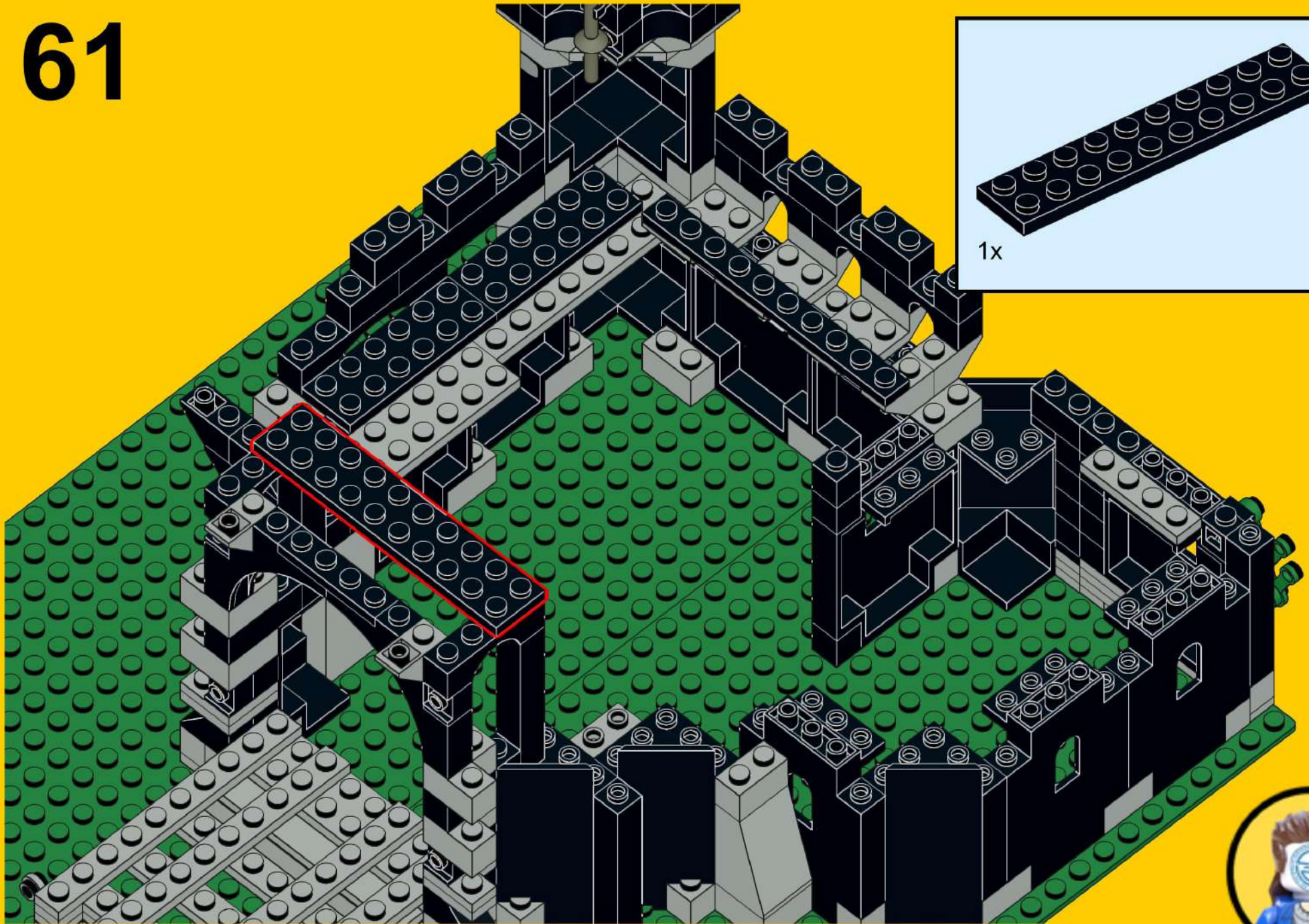

# 62

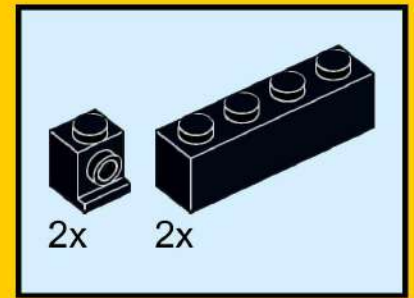
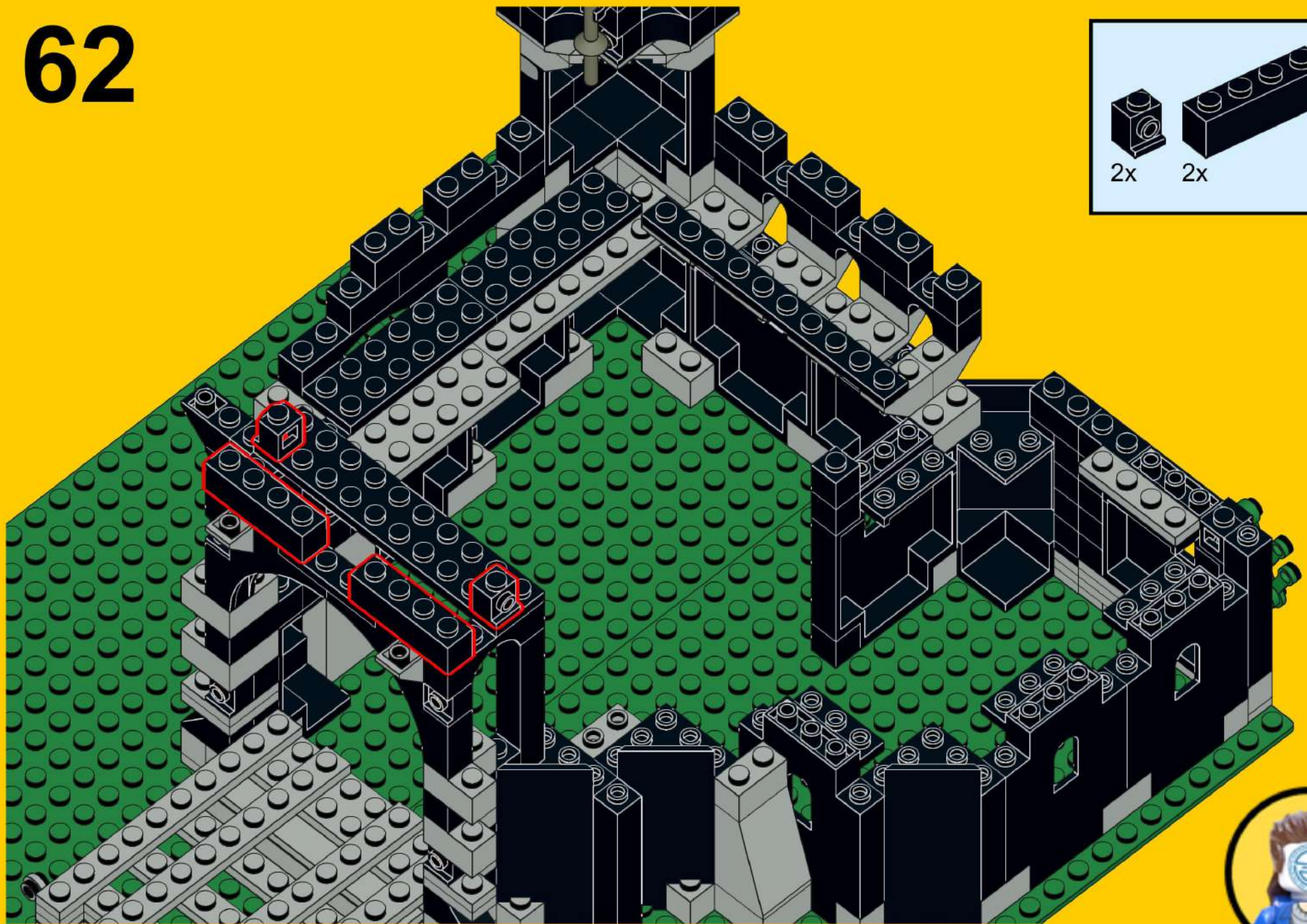

# 63

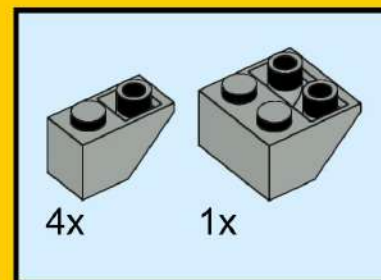
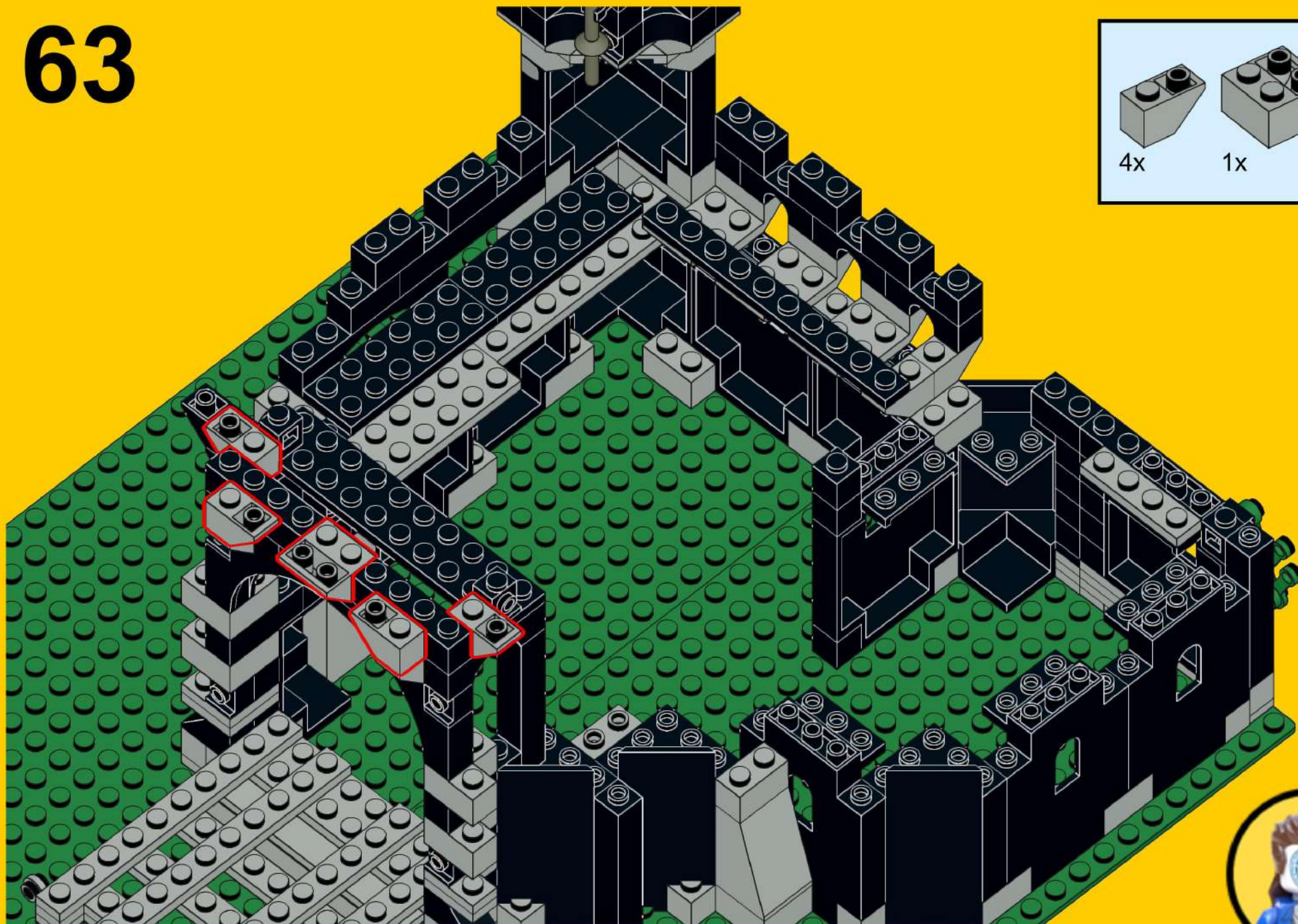

# 64

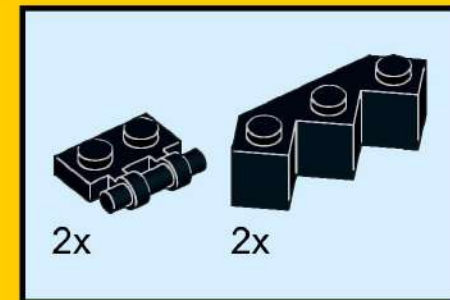
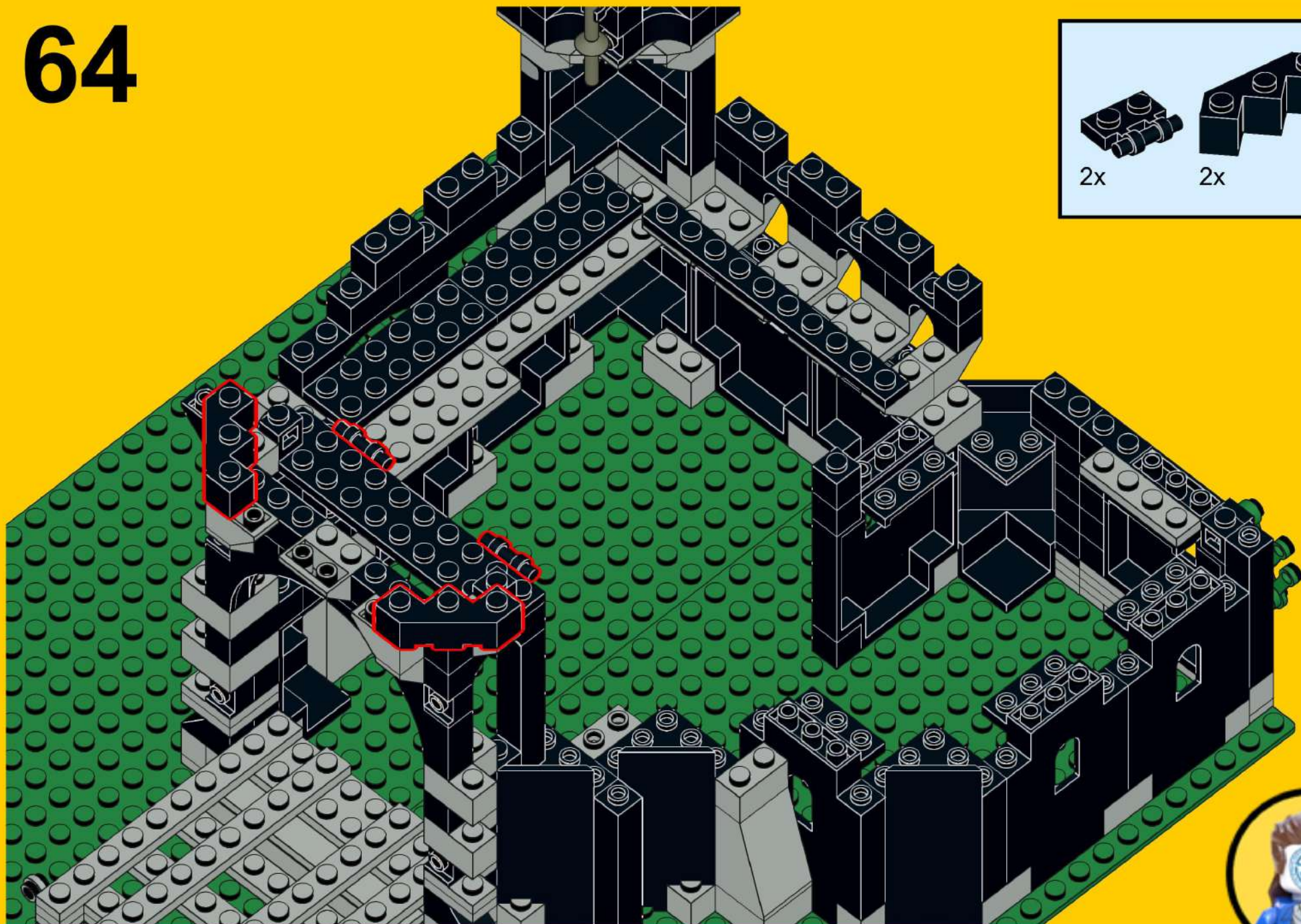

# 65

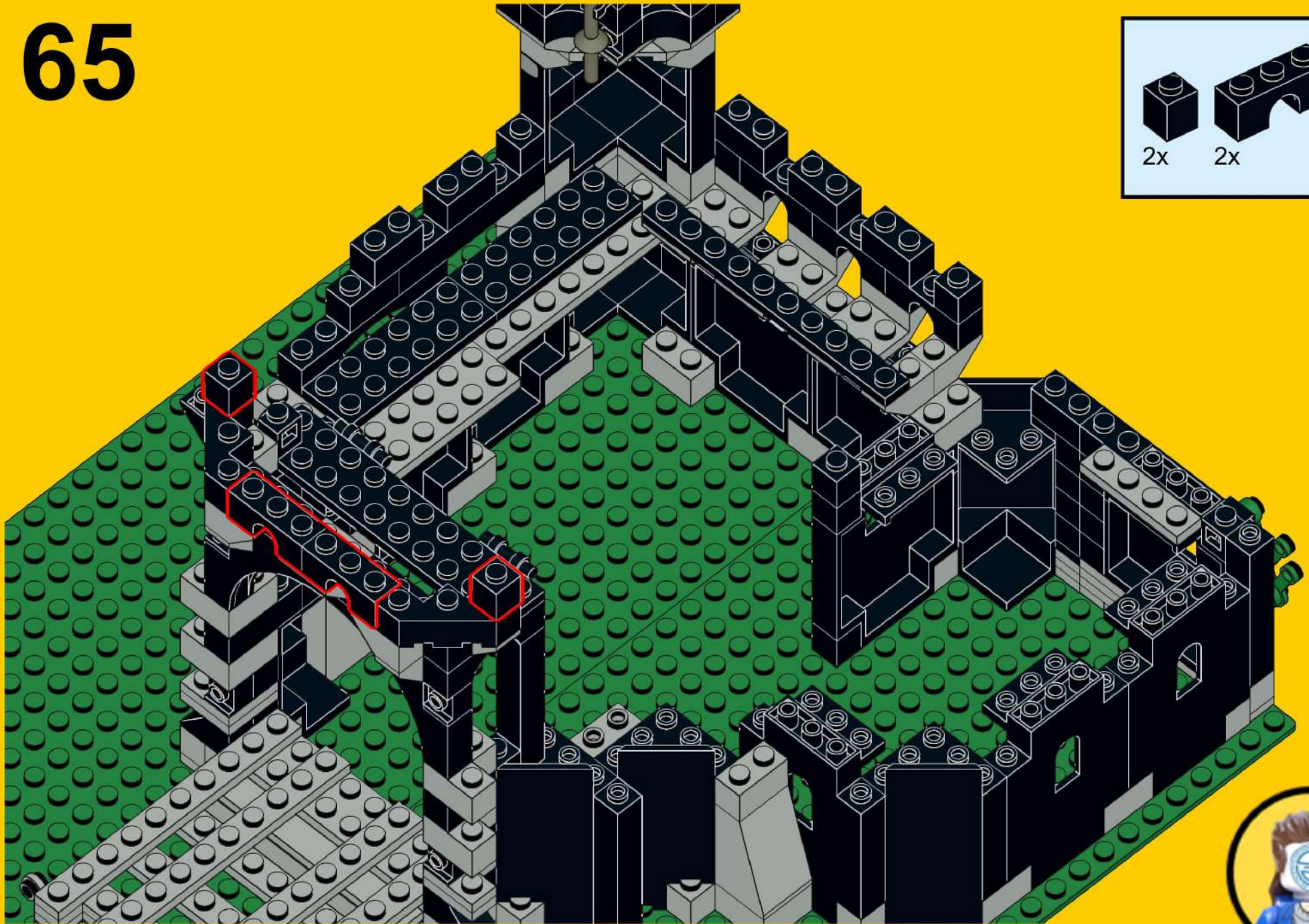
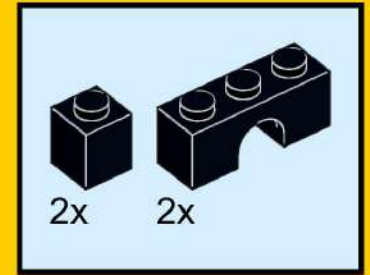



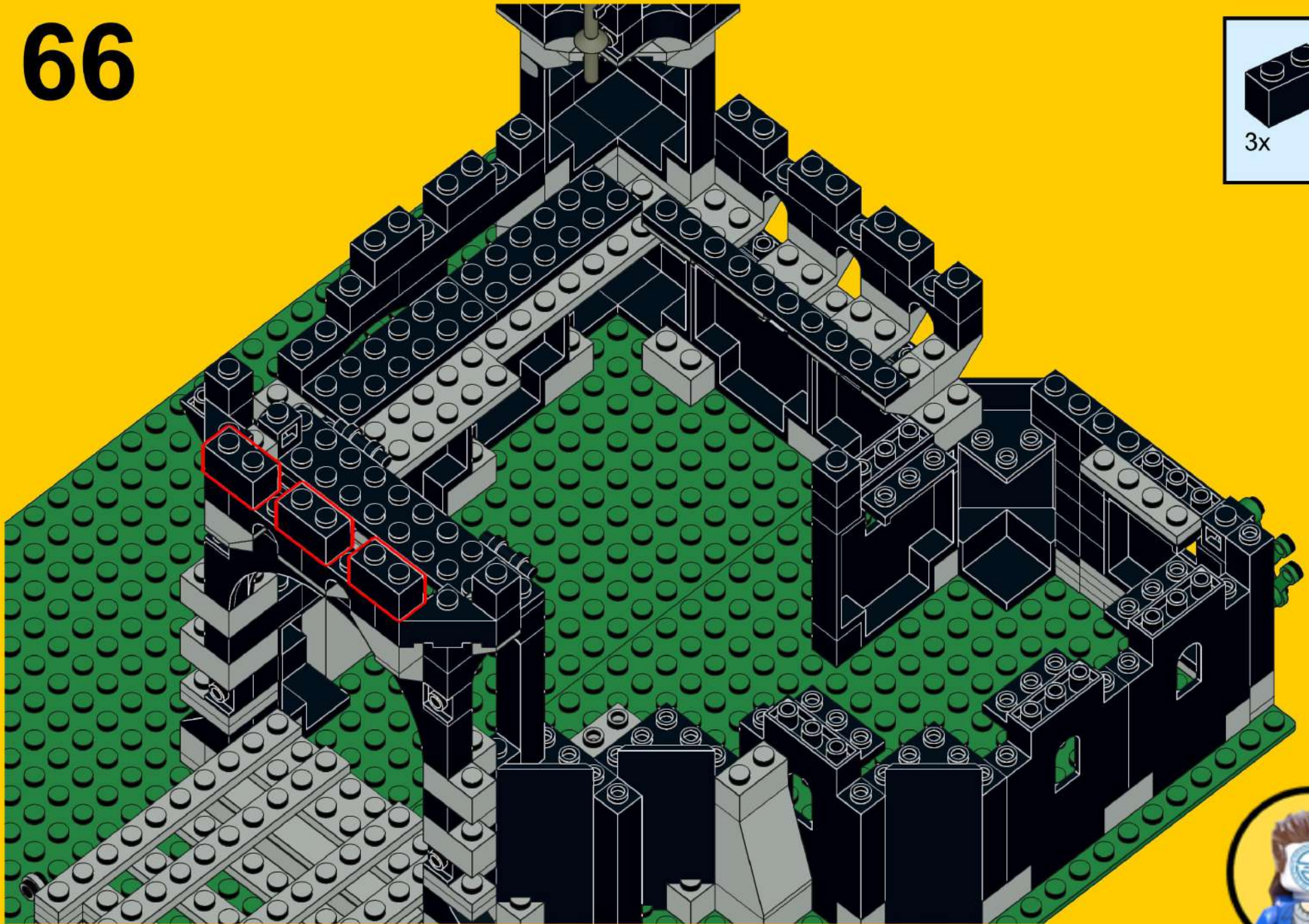
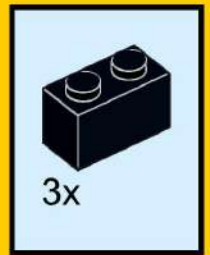

# 66



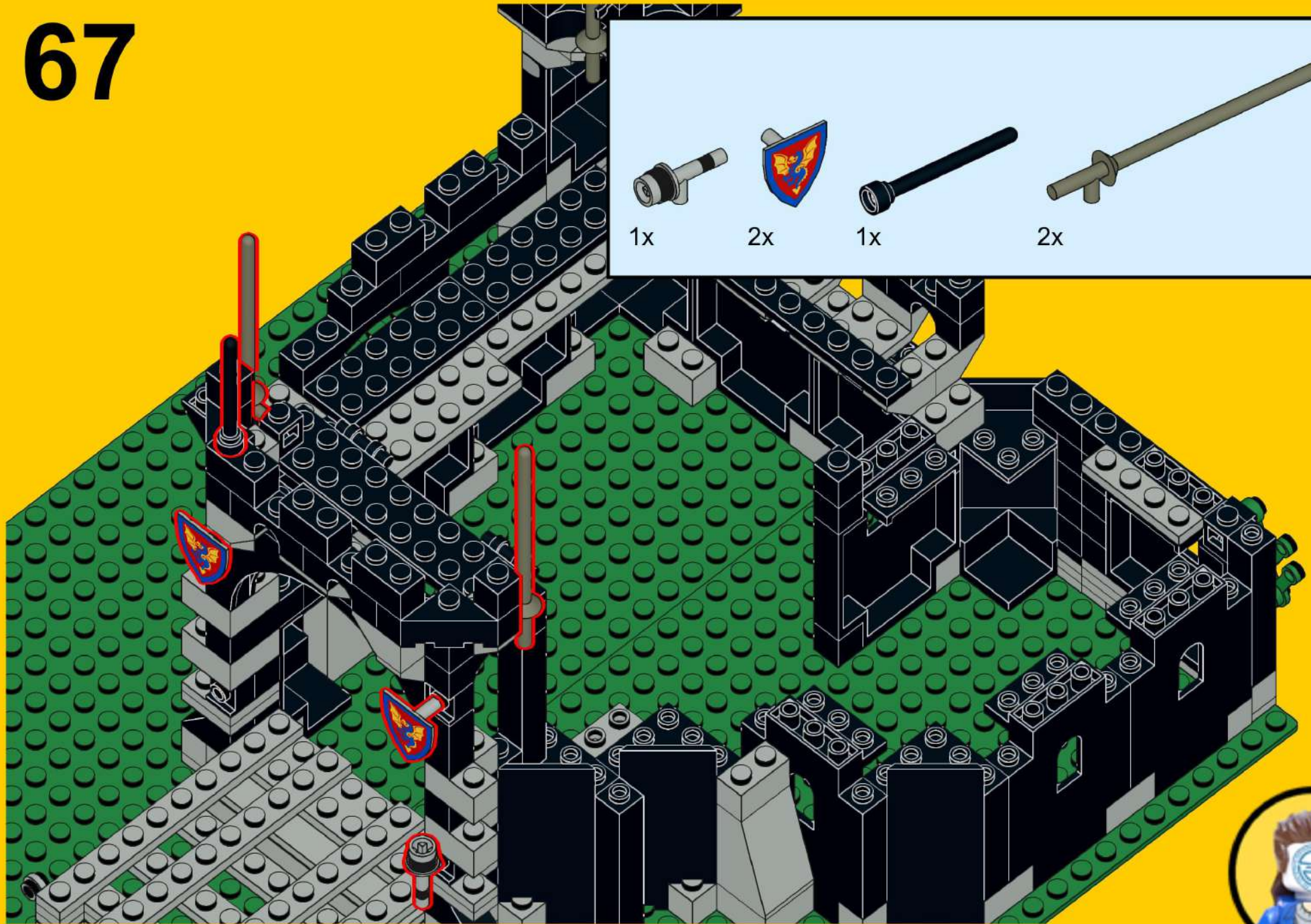

# 67

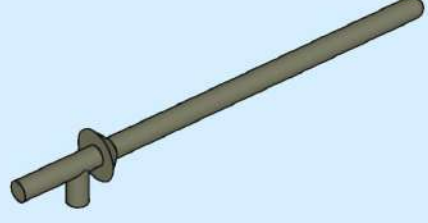

			
1x	2x	1x	2x



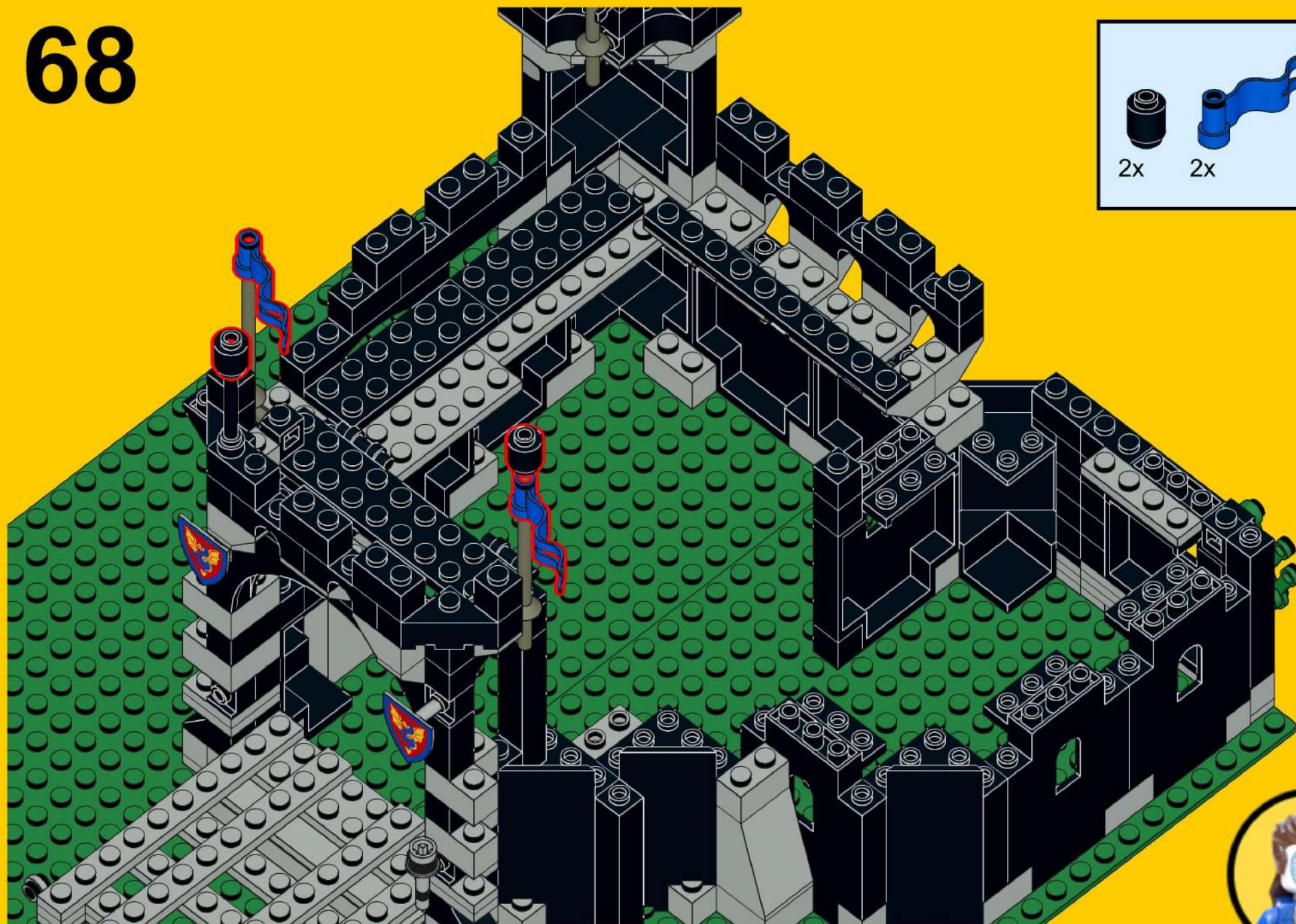
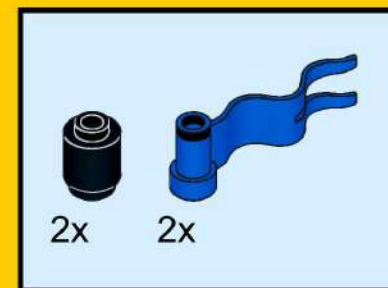

# 68

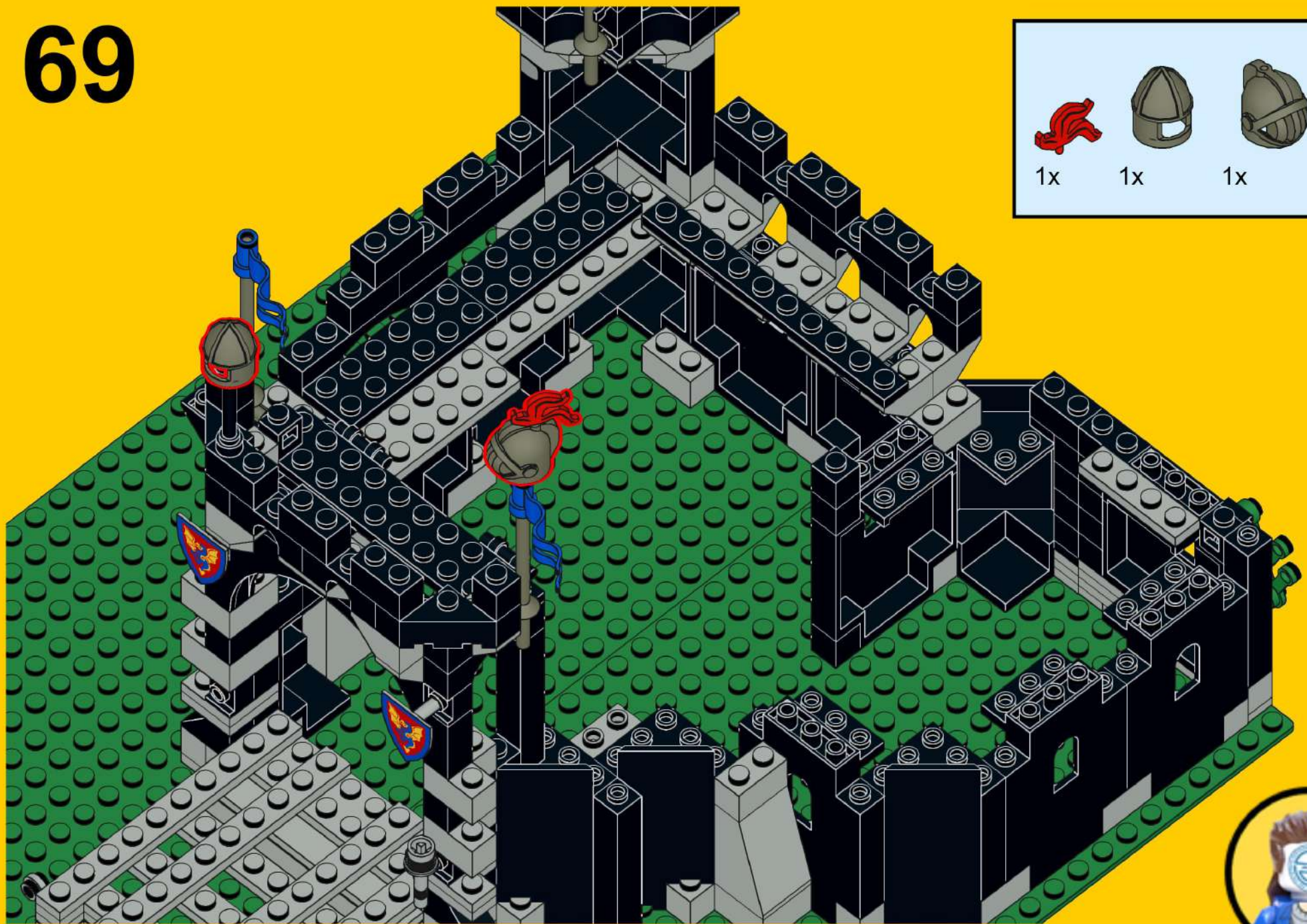

# 69



		
1x	1x	1x



# 70

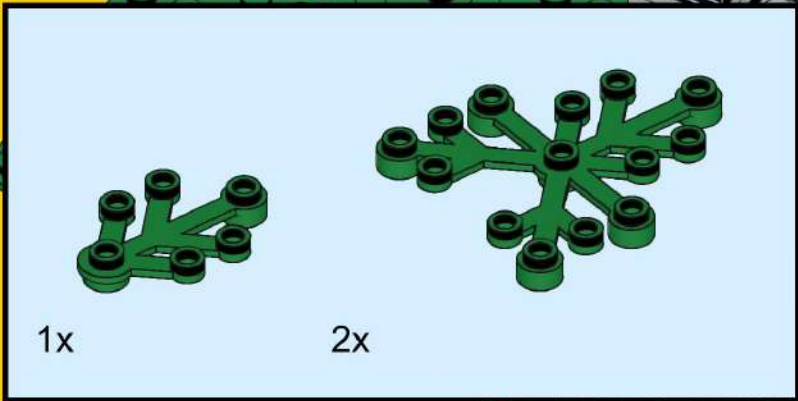

# 71

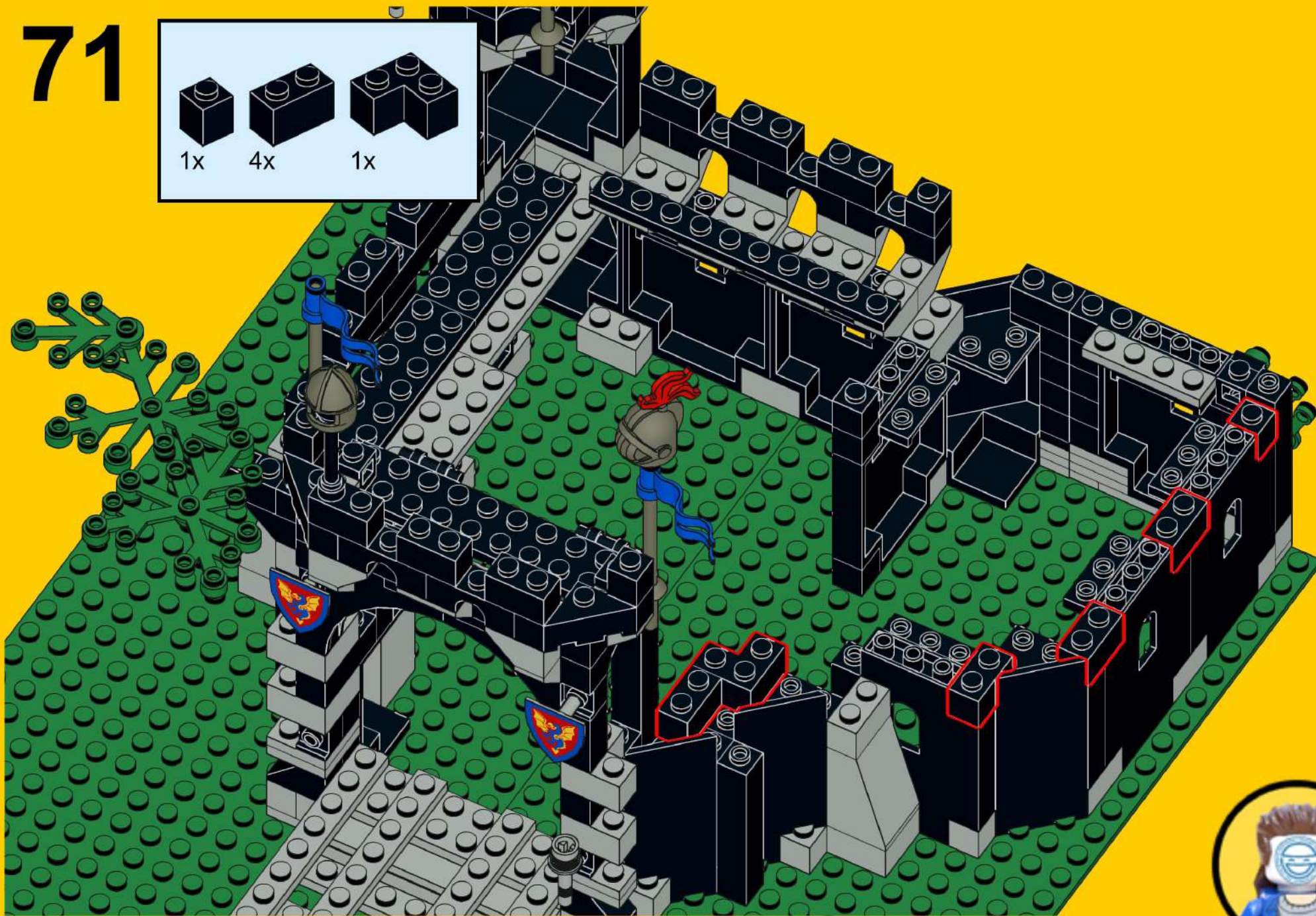
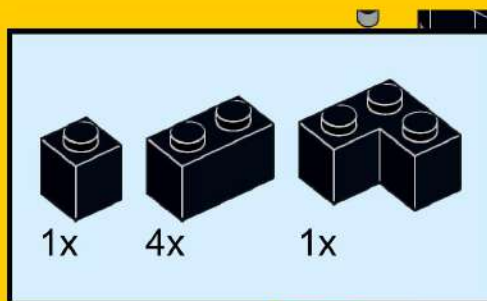

# 72

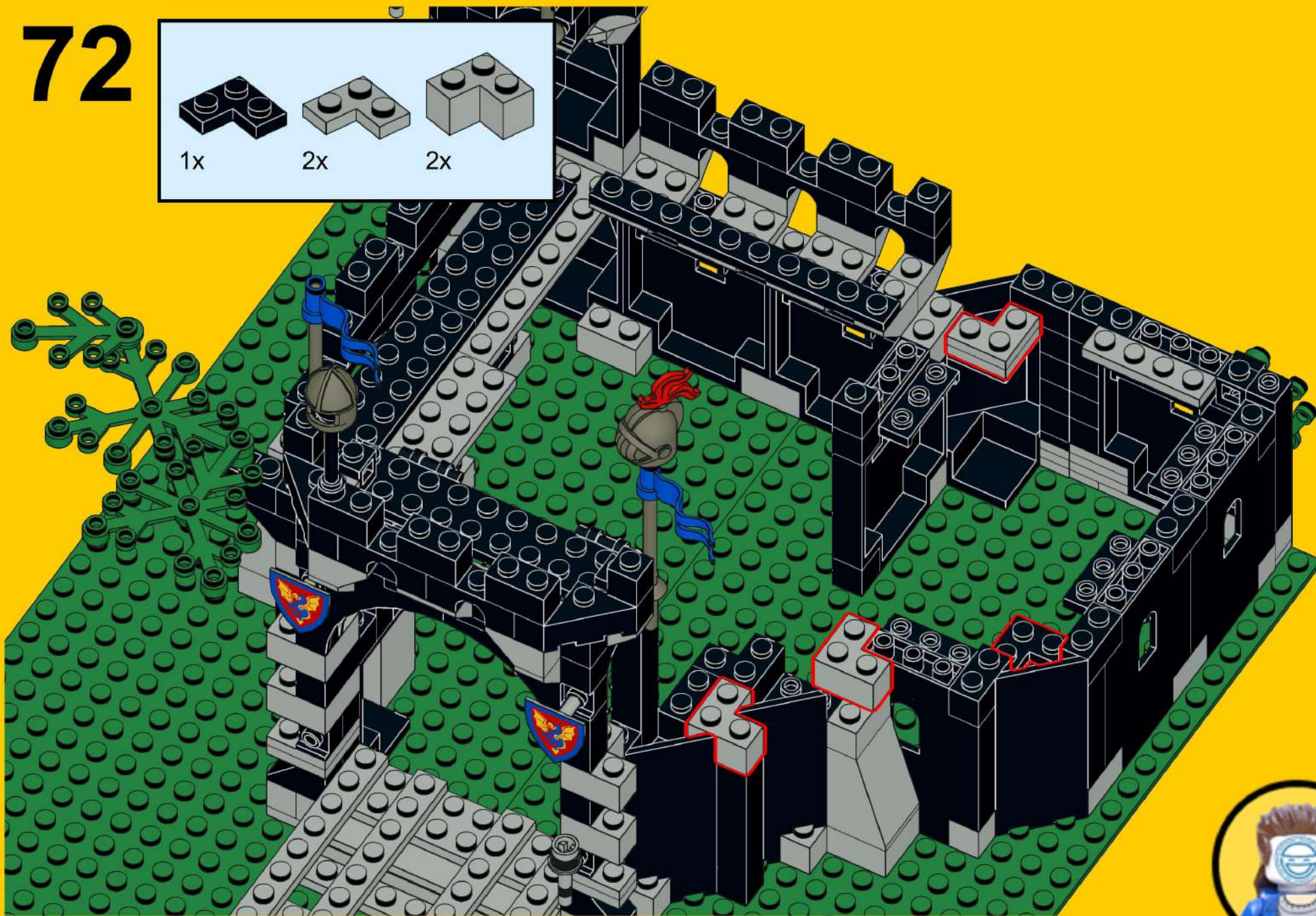
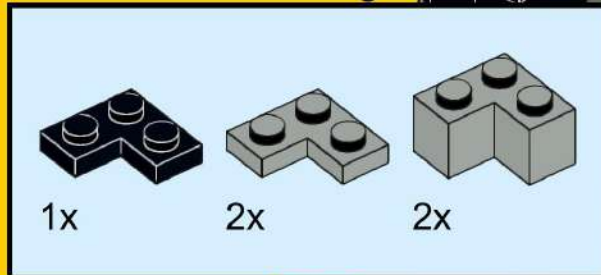

# 73

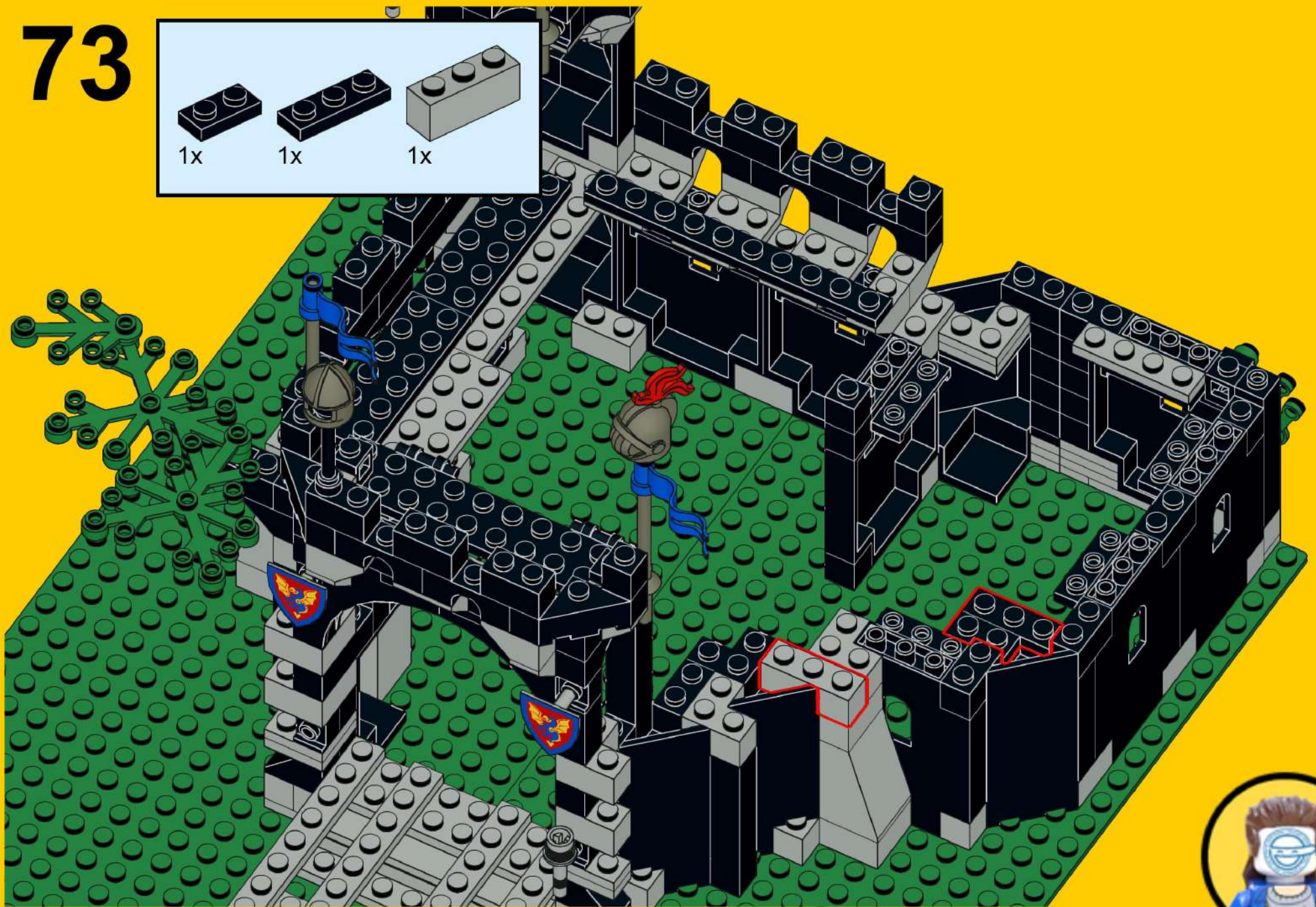
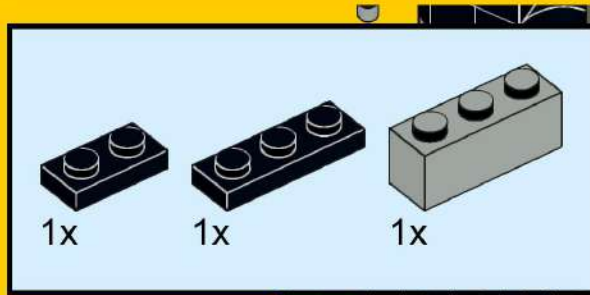

# 74

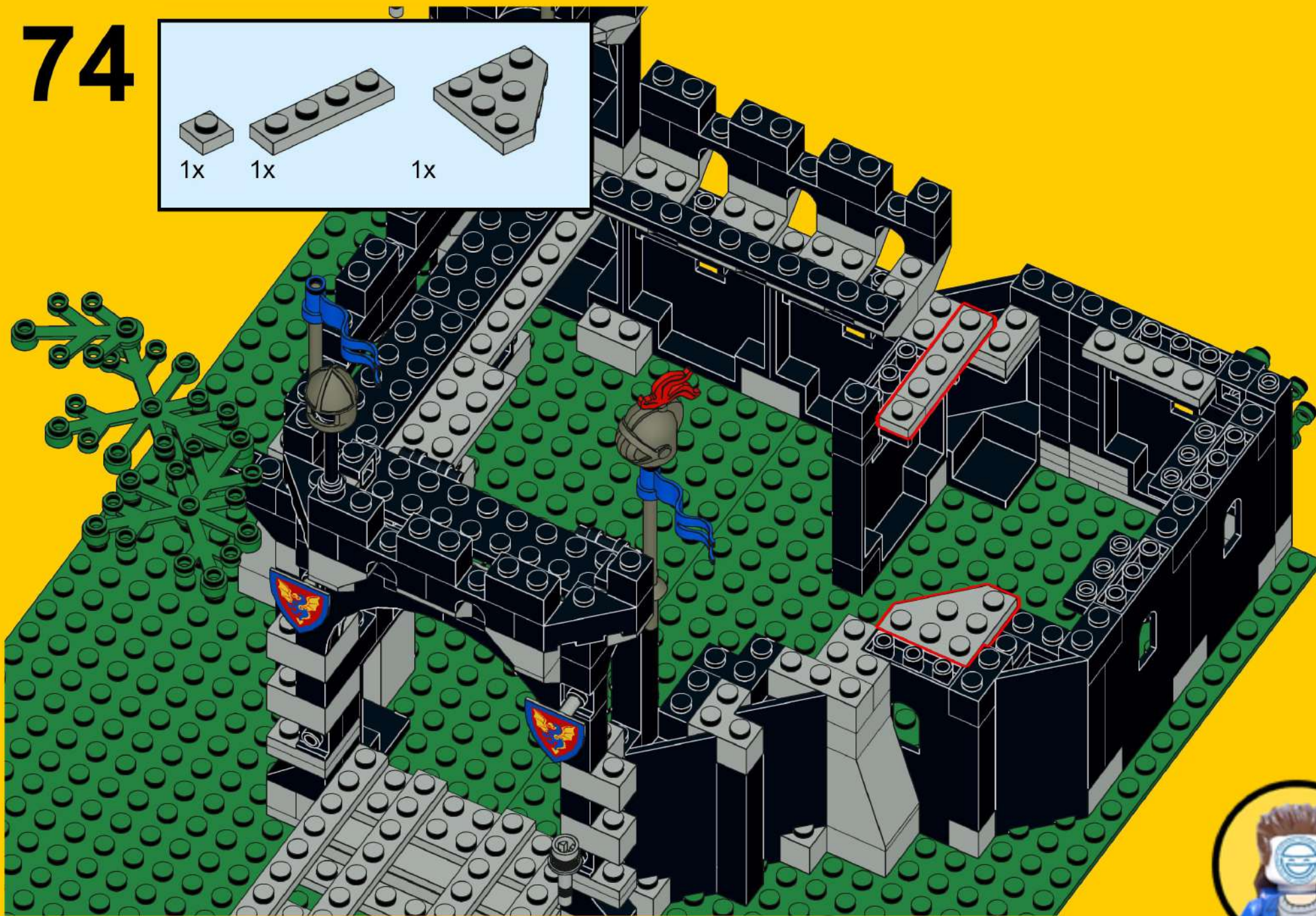
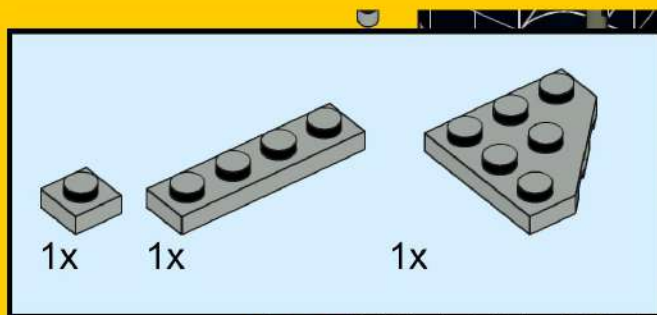



# 75

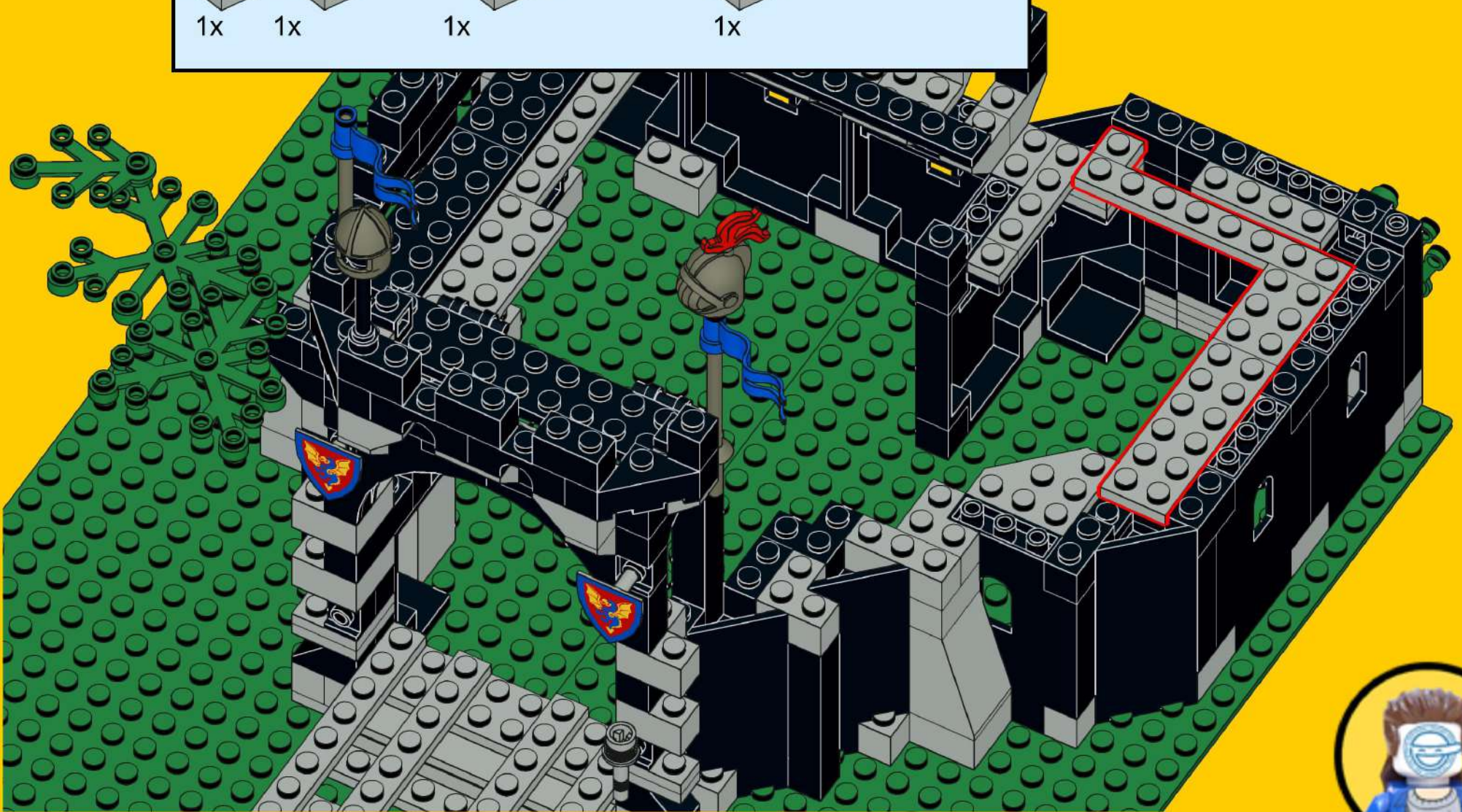
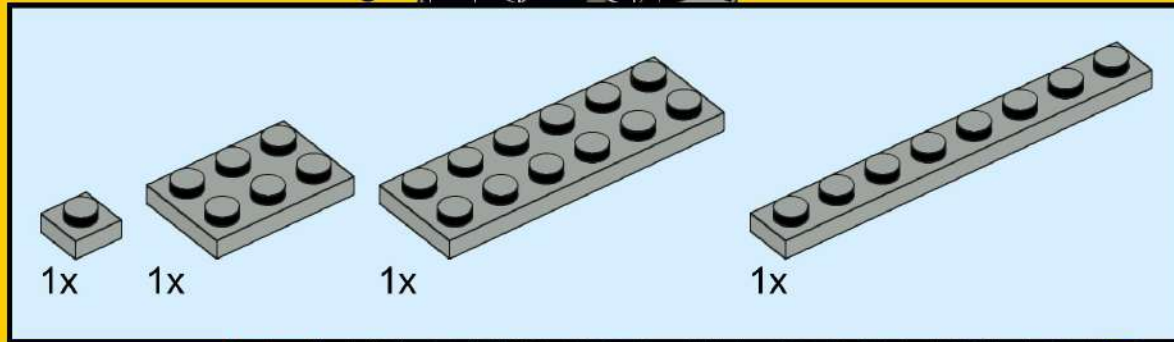

# 76

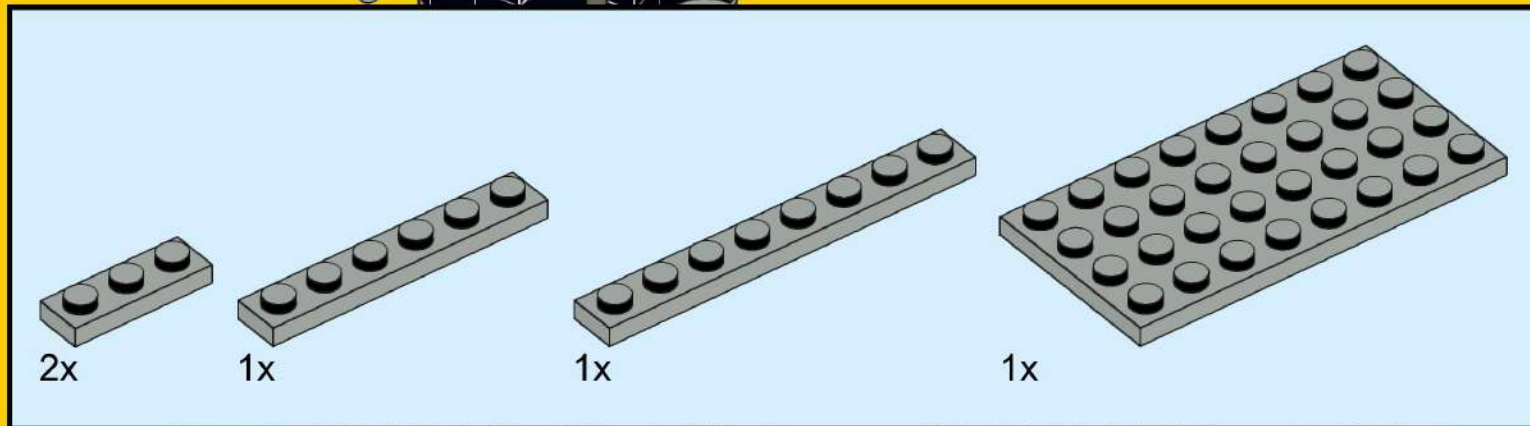

# 77

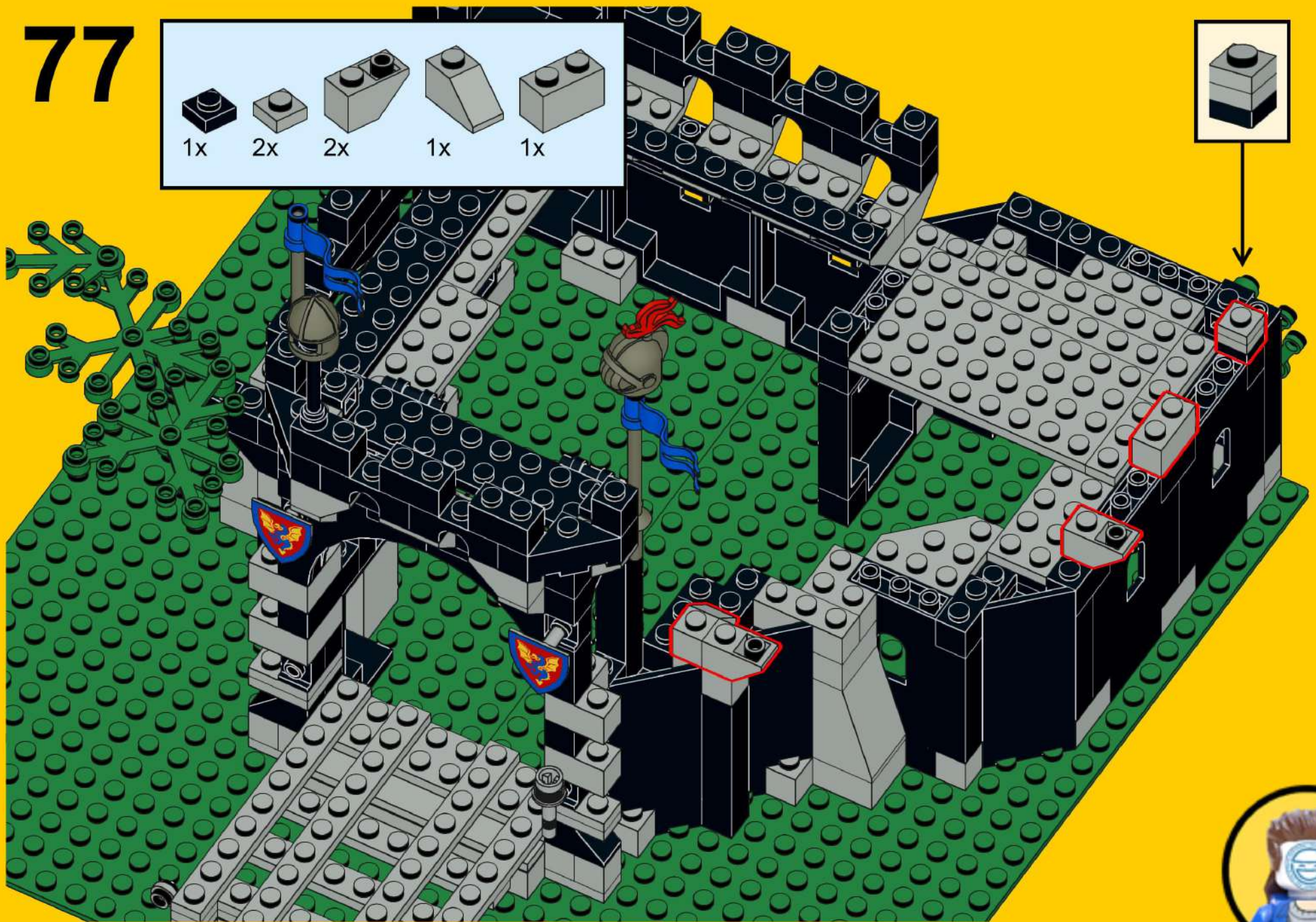
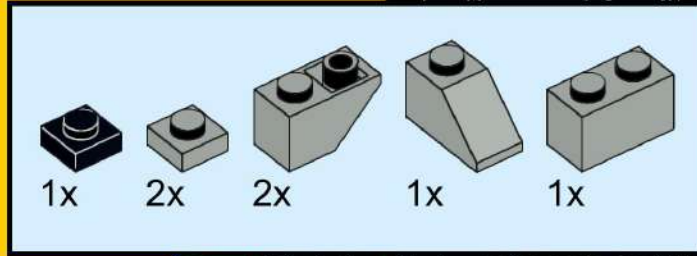

# 78

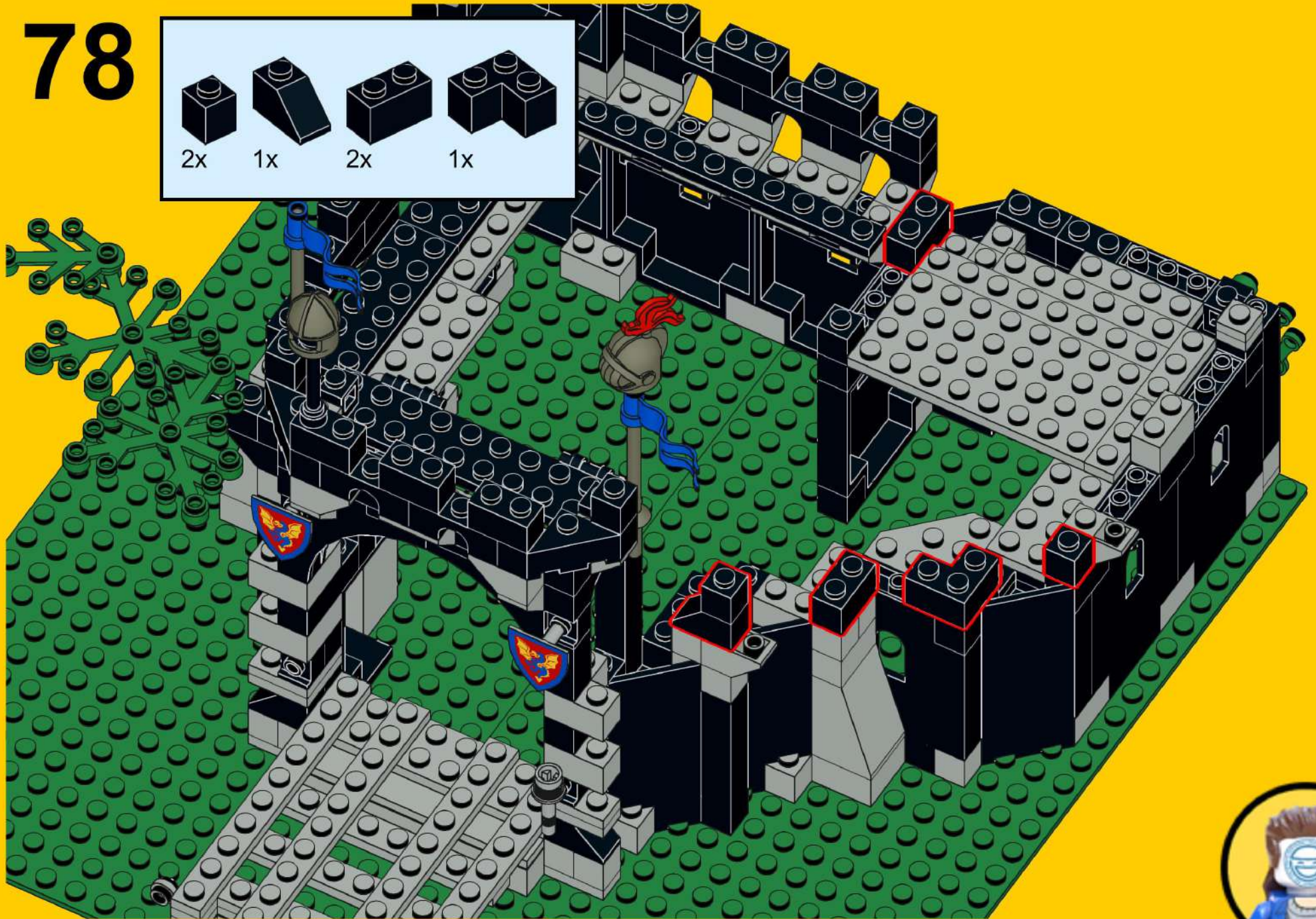
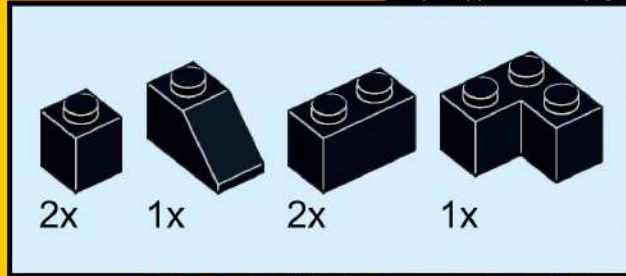

# 79

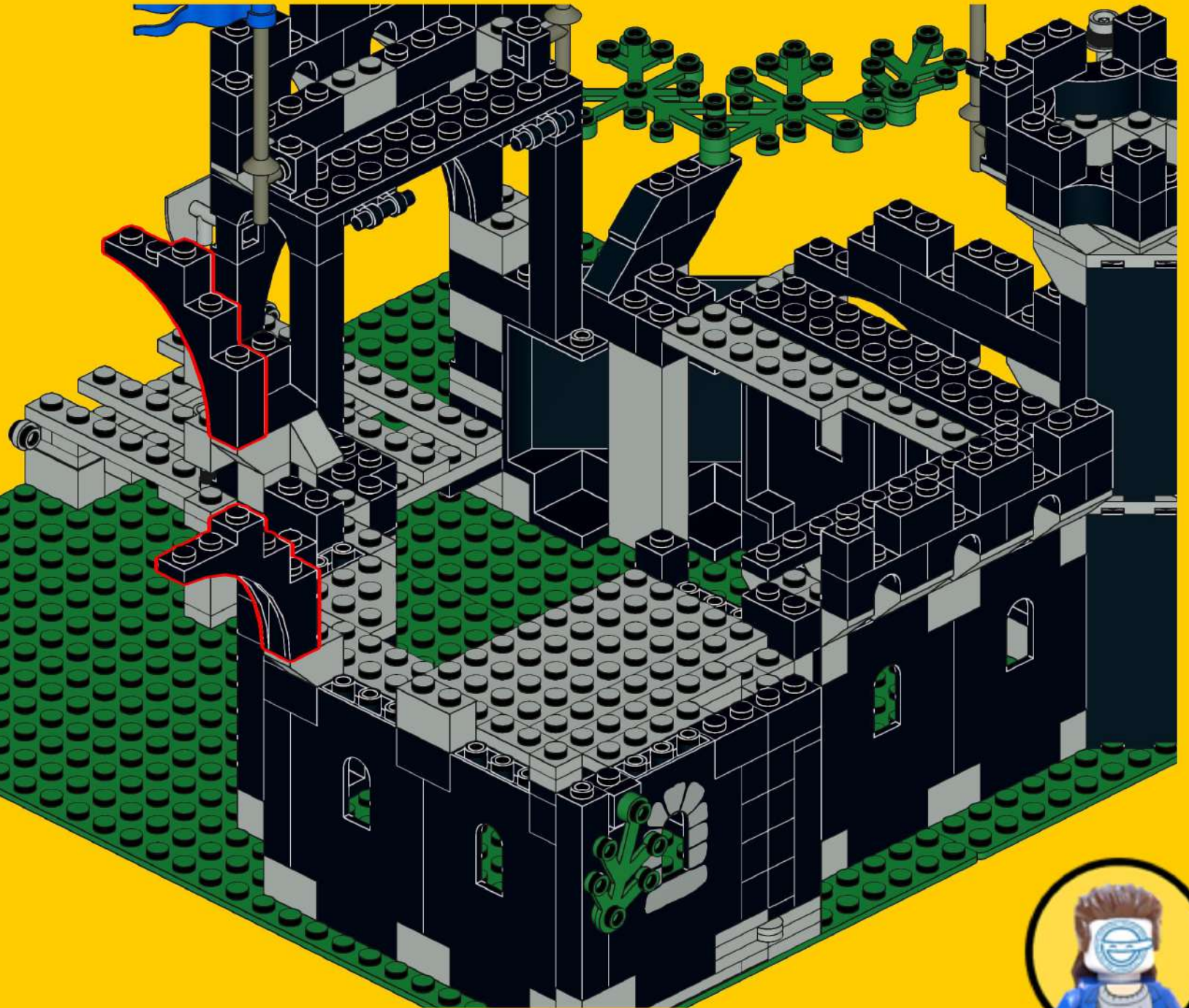
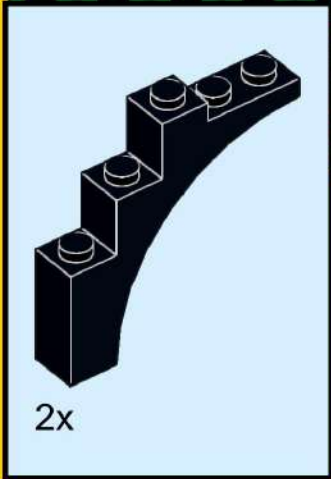

80

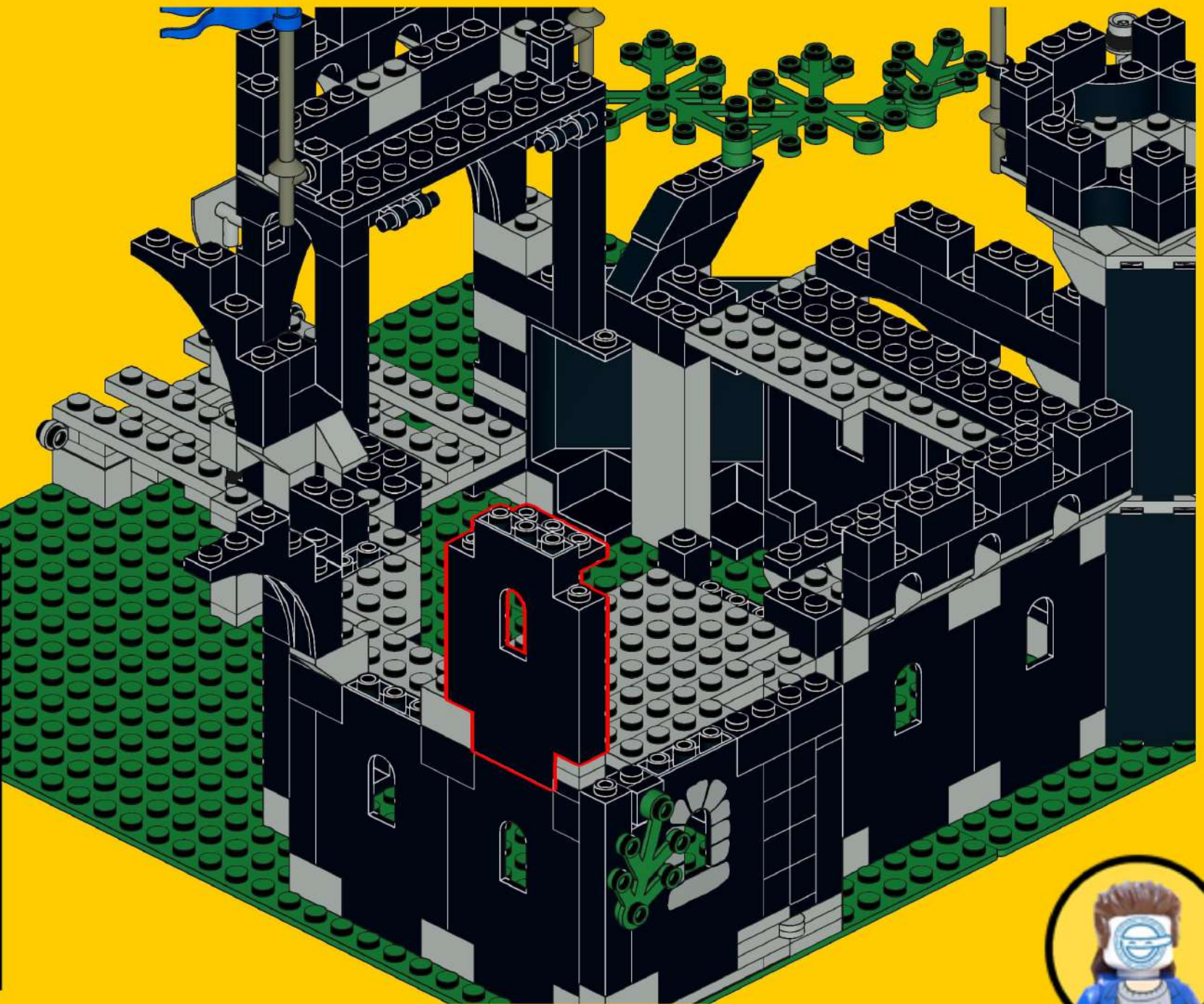
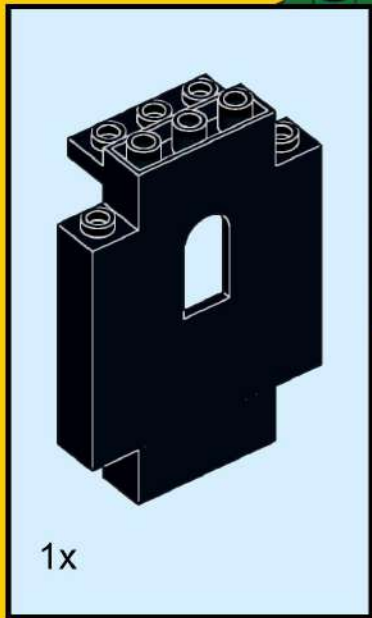

# 81

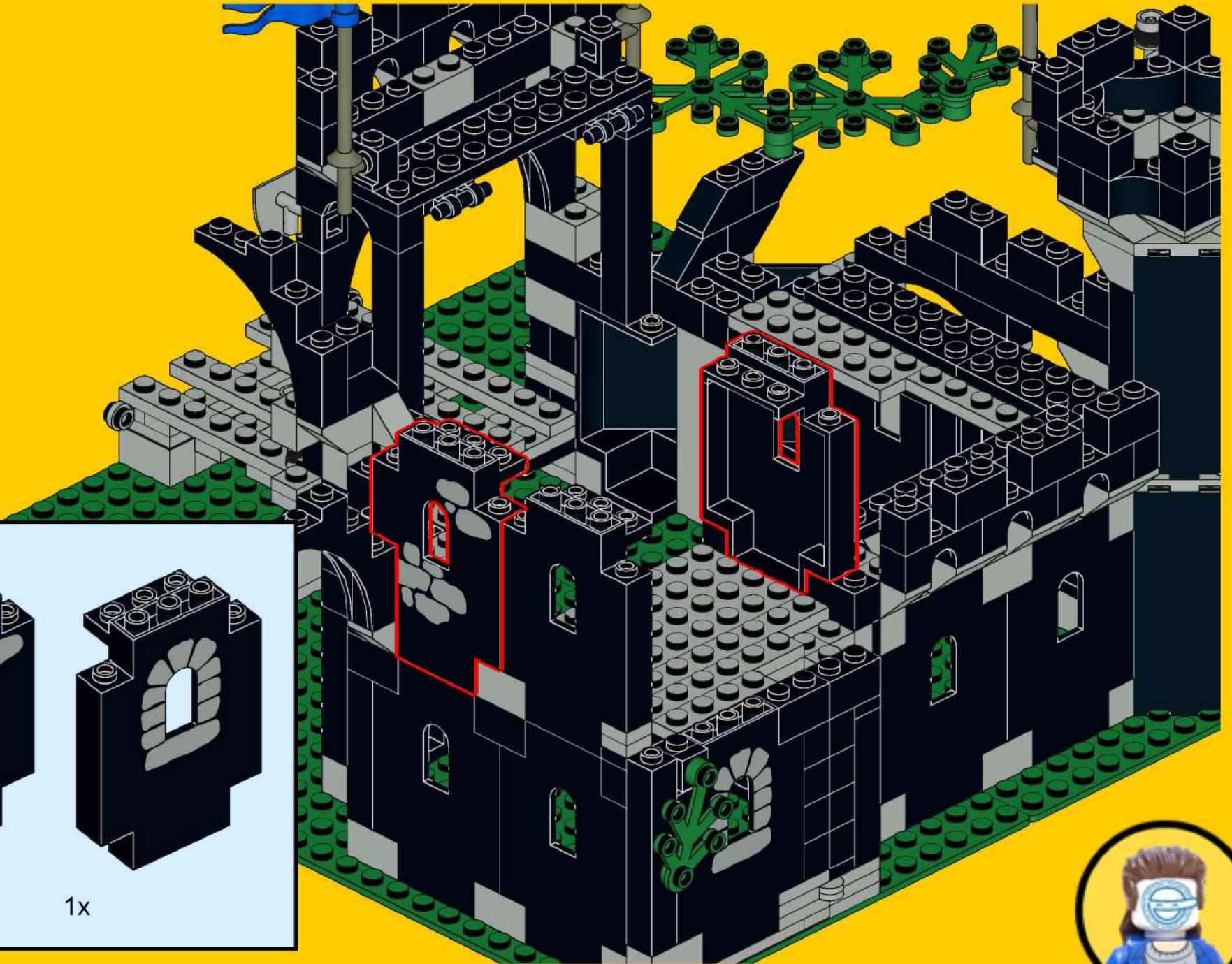
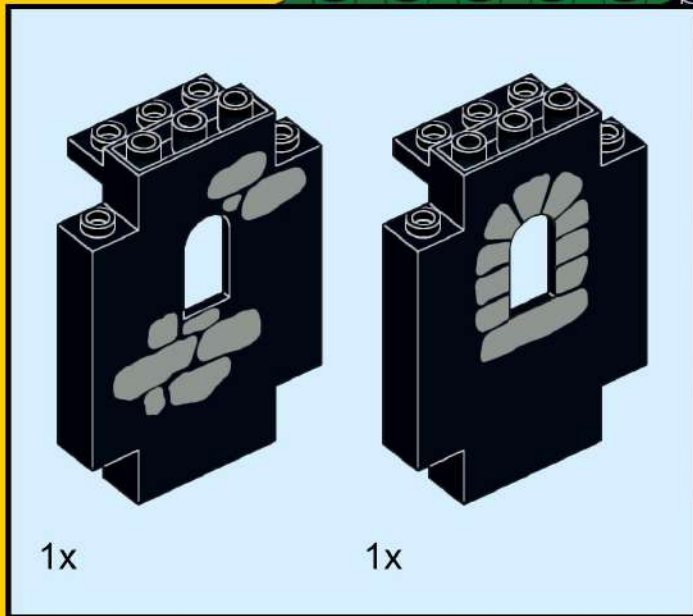

# 82

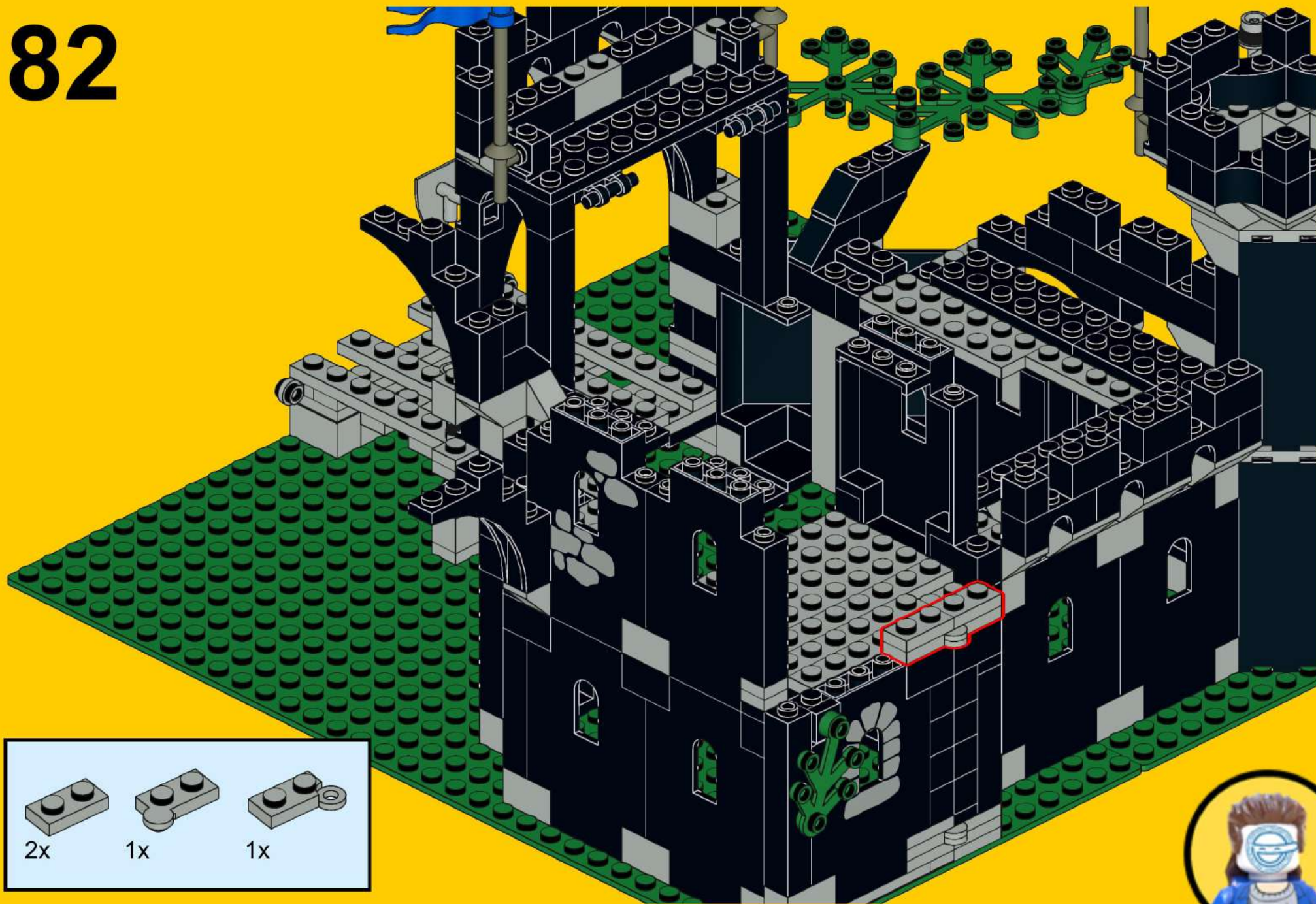

2x



1x



1x





# 83

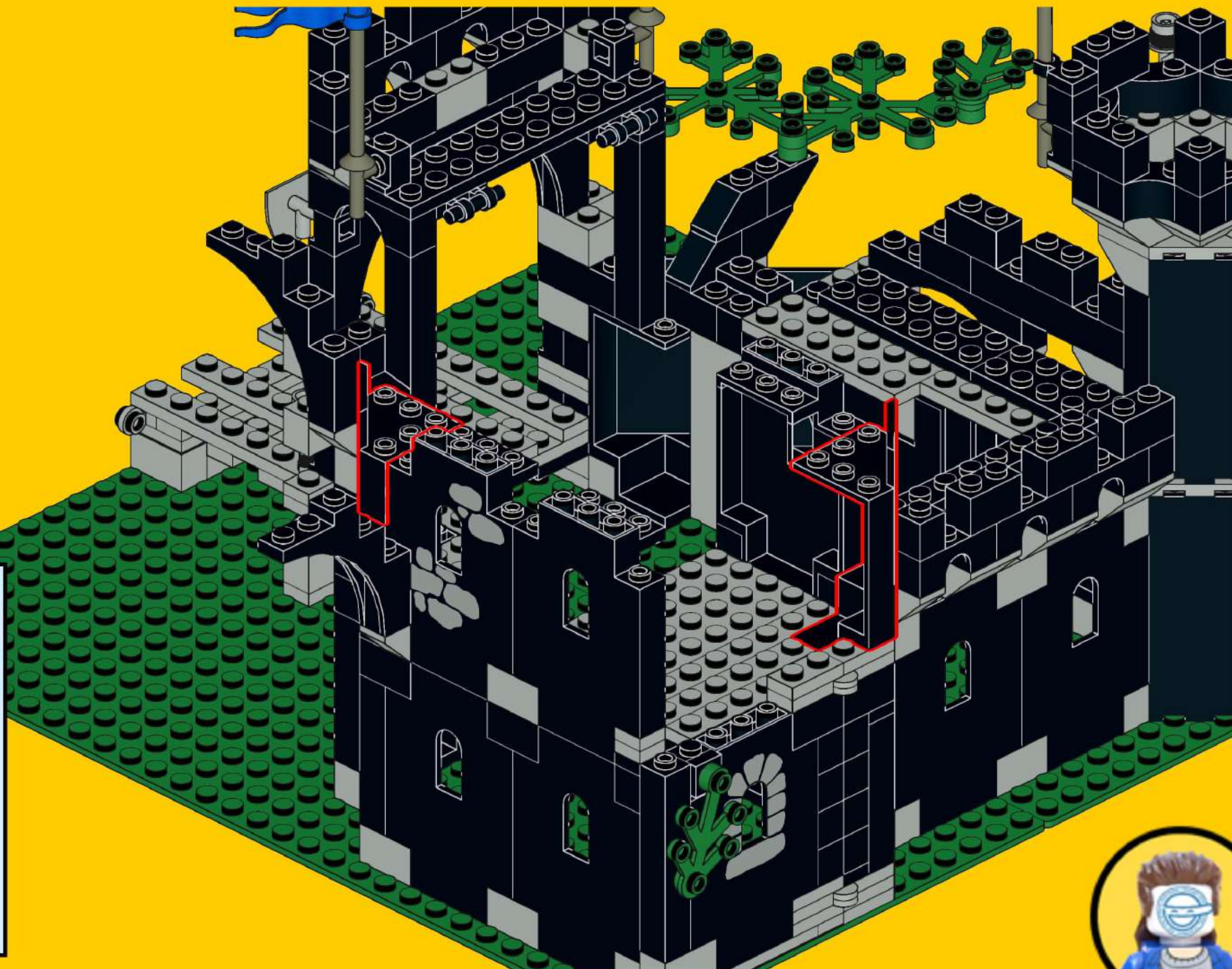
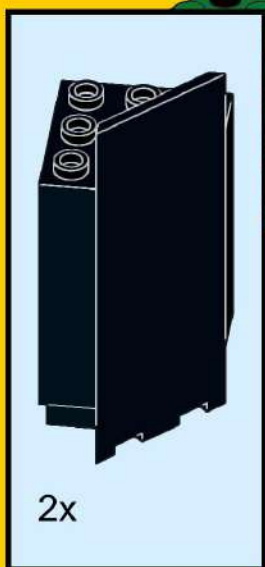

# 84

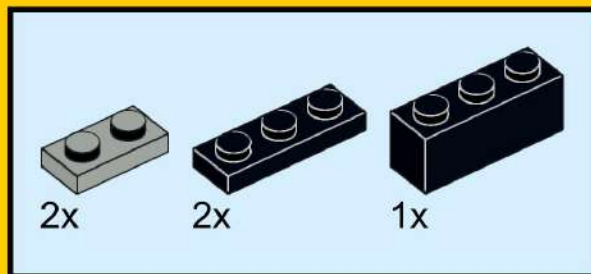
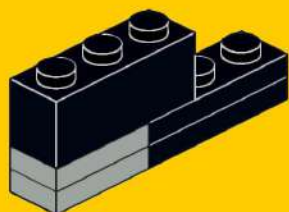
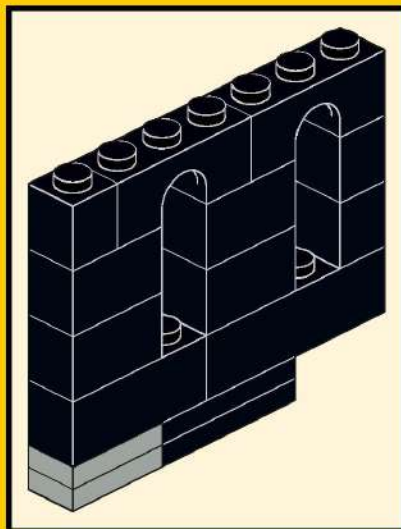

# 85

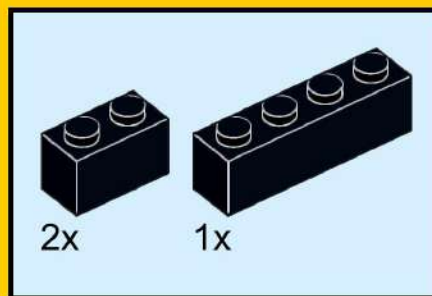
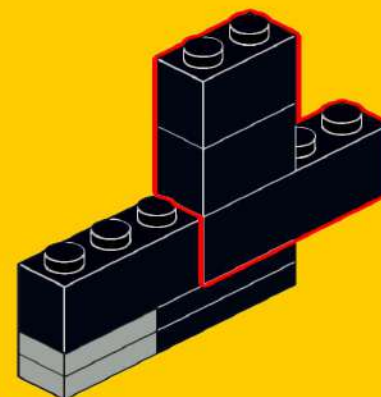

# 86

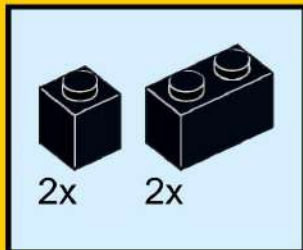
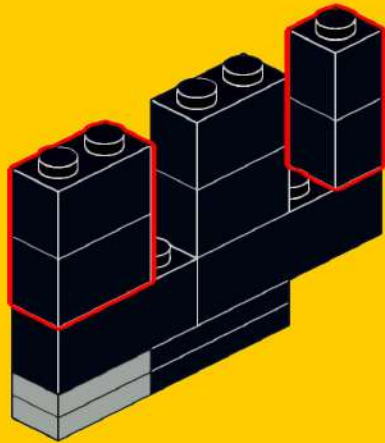

# 87

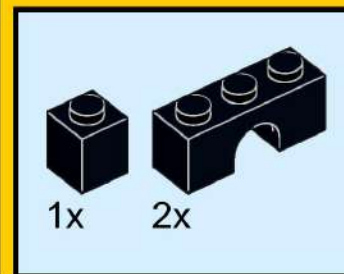
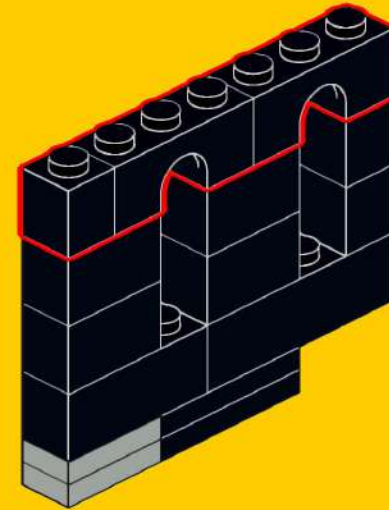

88

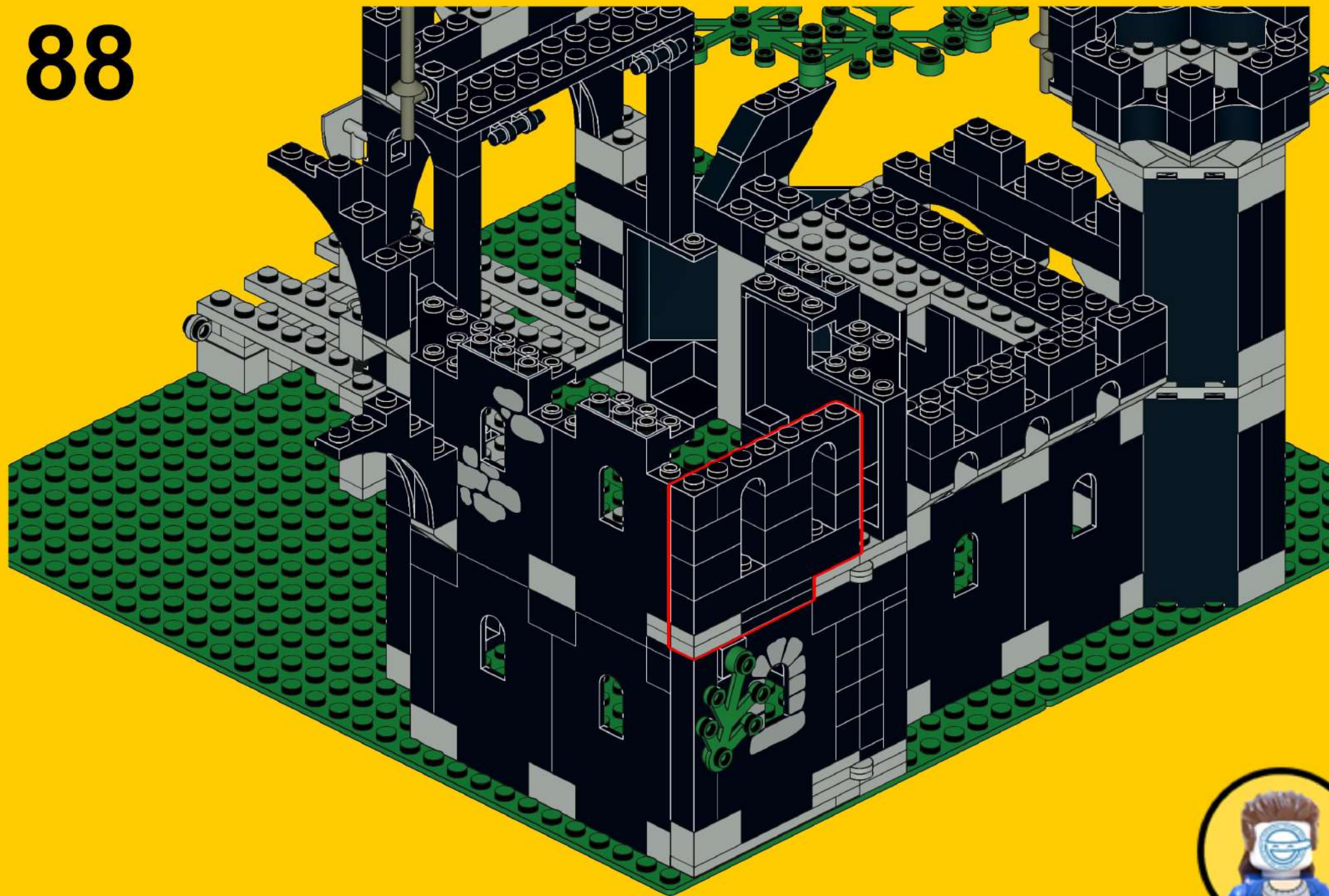

# 89

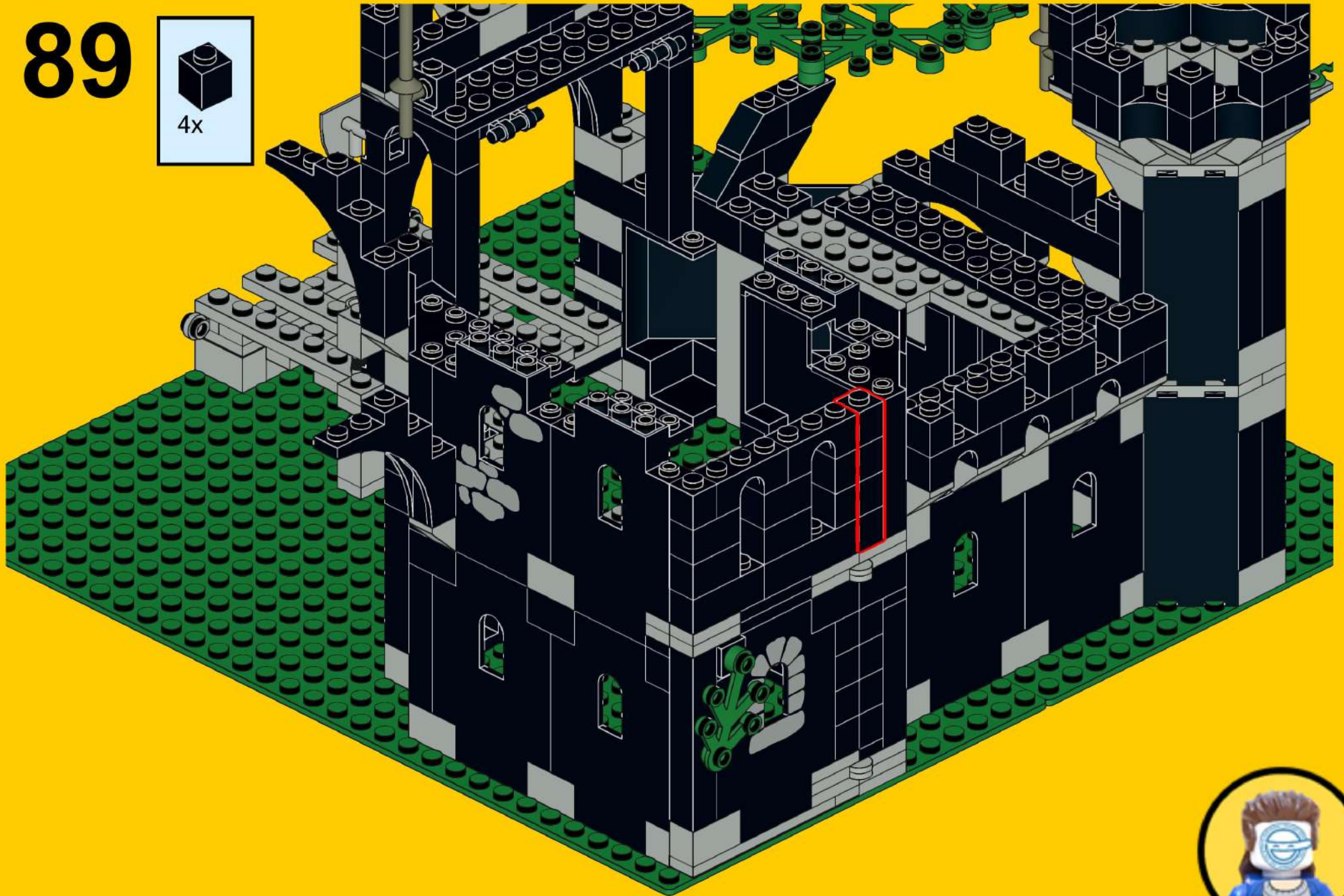

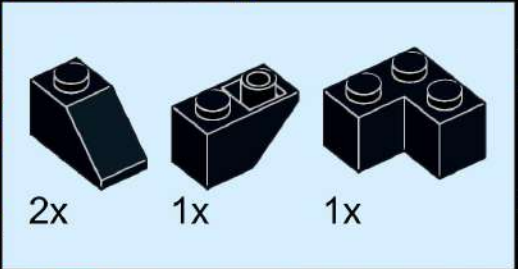

2x 1x 1x

This inset box shows the parts required for step 90: two black 1x2 Technic bricks, one black 1x3 Technic brick, and one black 1x3 Technic brick with a hole. The quantities are listed below each part.

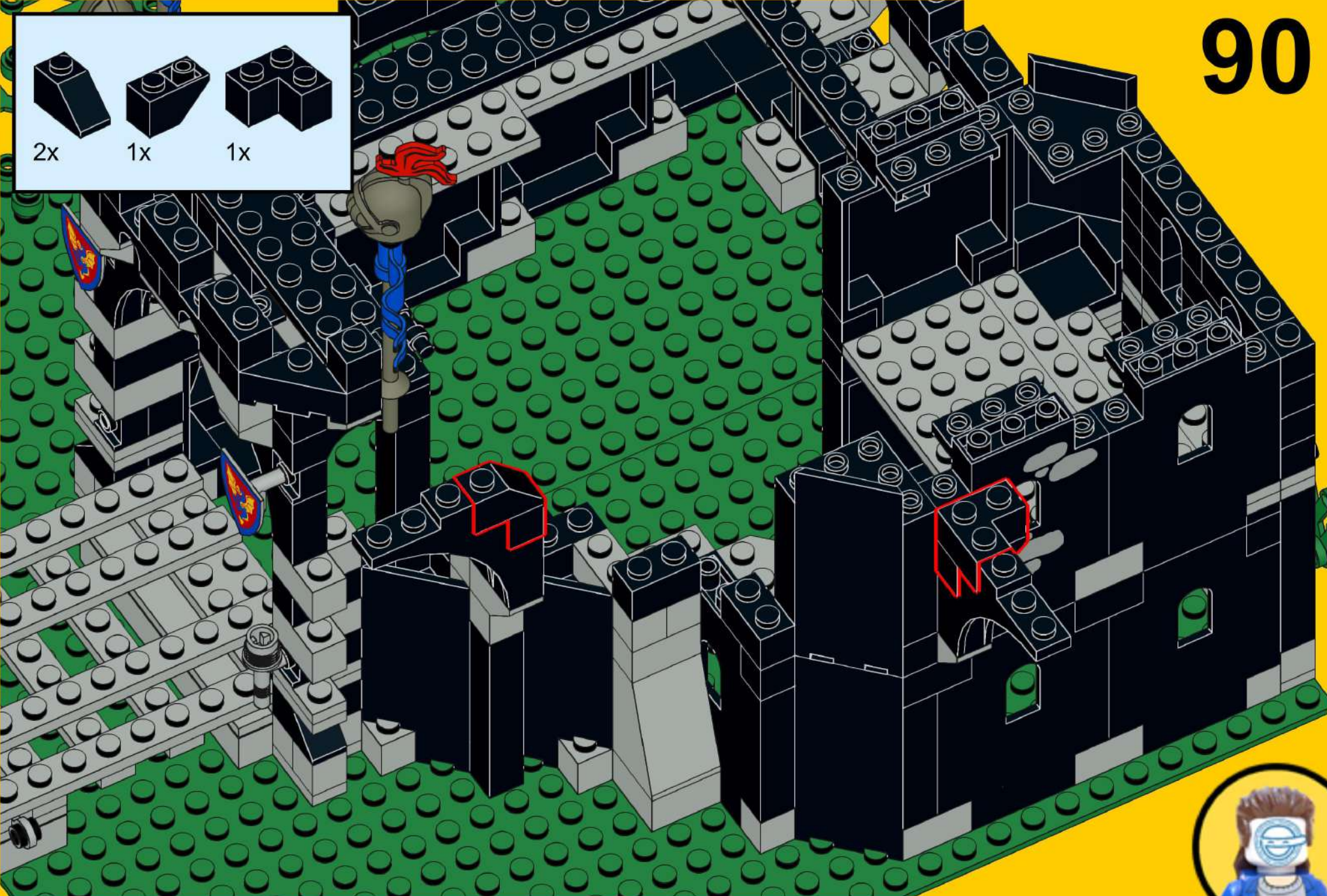

1x 1x 1x

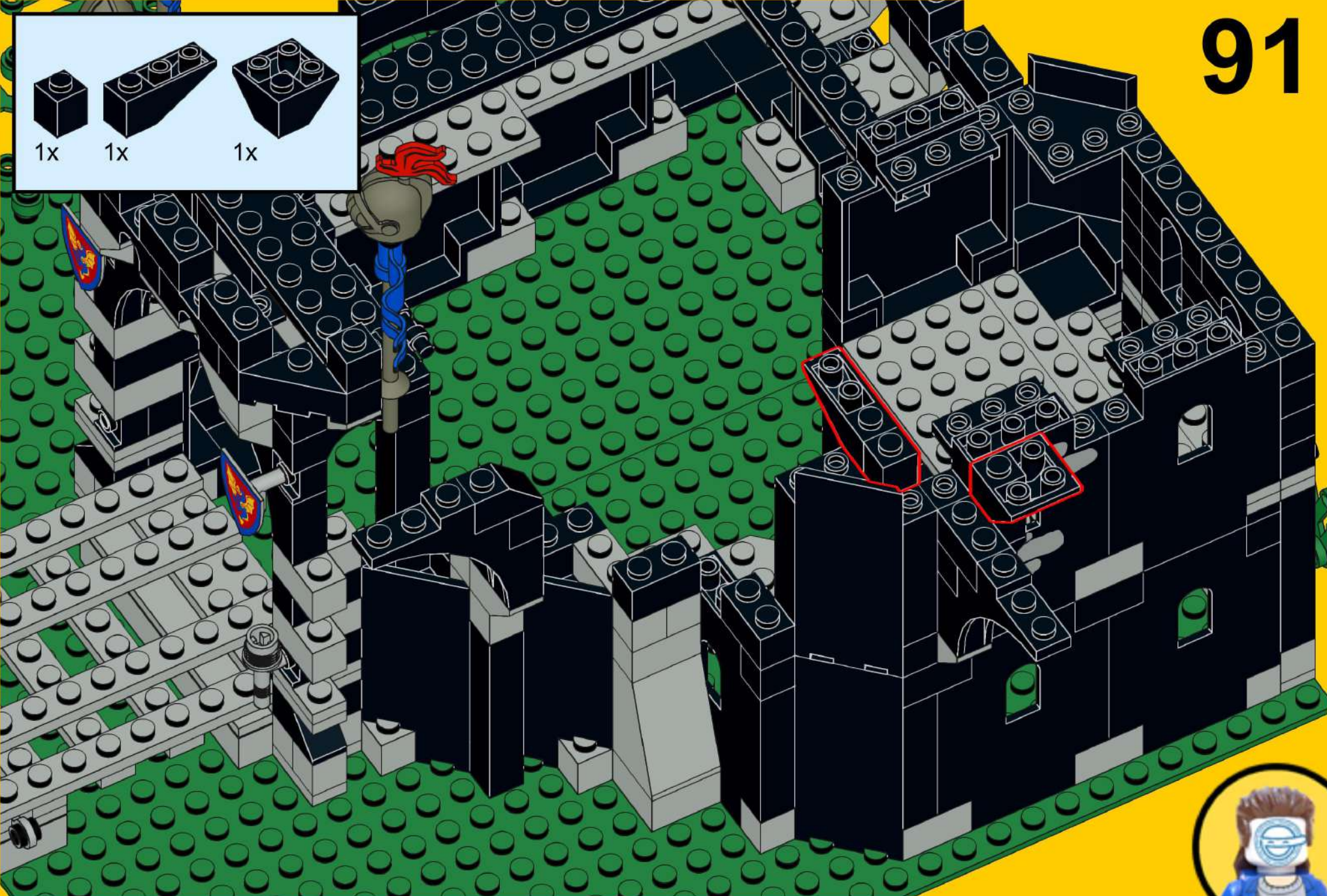
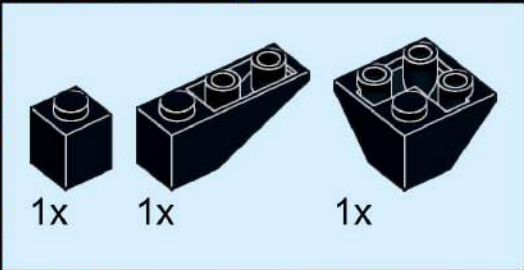

1x 1x 1x

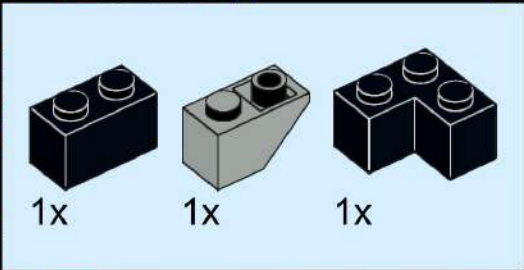

This inset box lists the parts required for step 92. It contains three items, each with a '1x' quantity label below it: a black 1x2 brick, a grey 1x2 brick with a hole, and a black 1x2 brick with a hole.

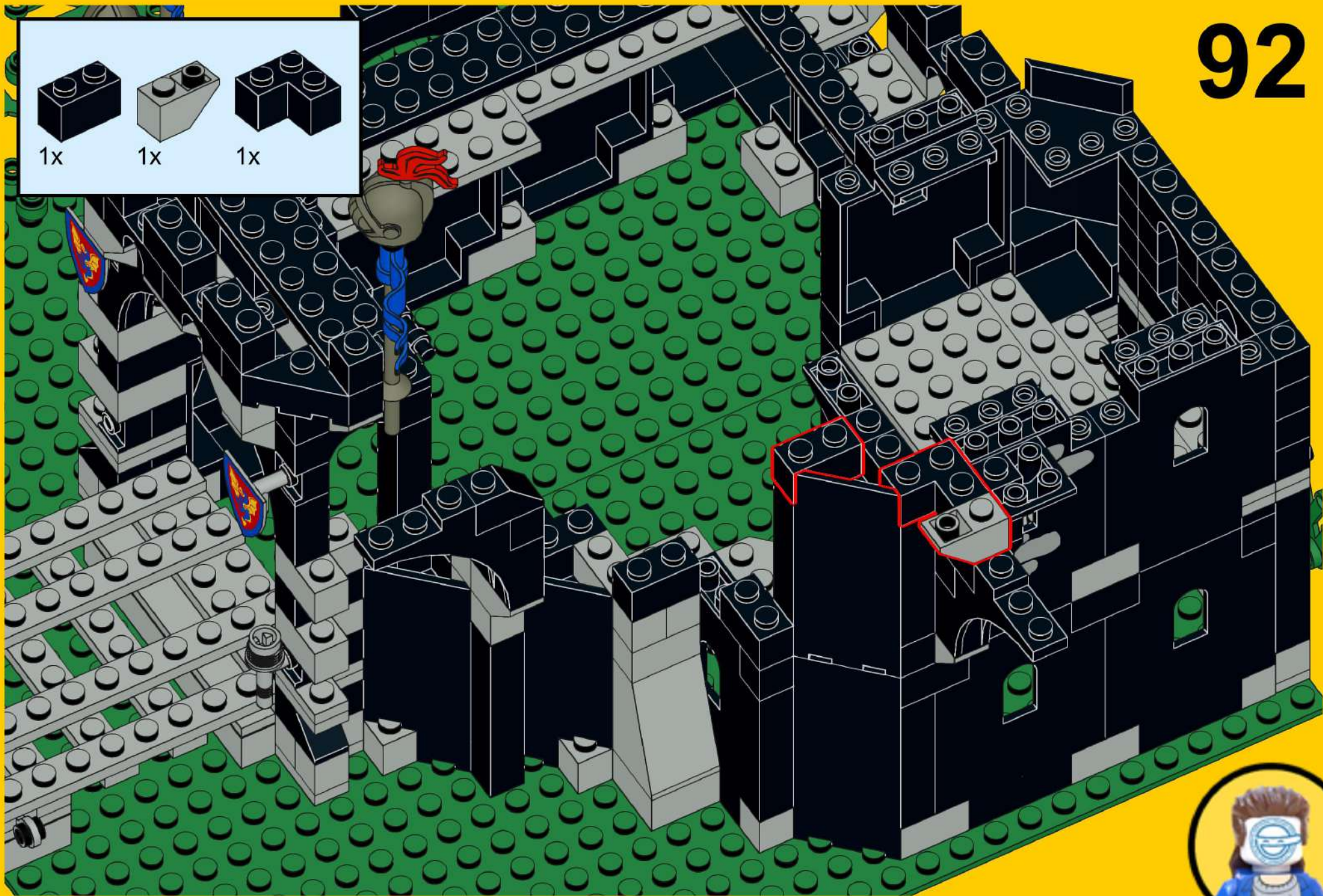



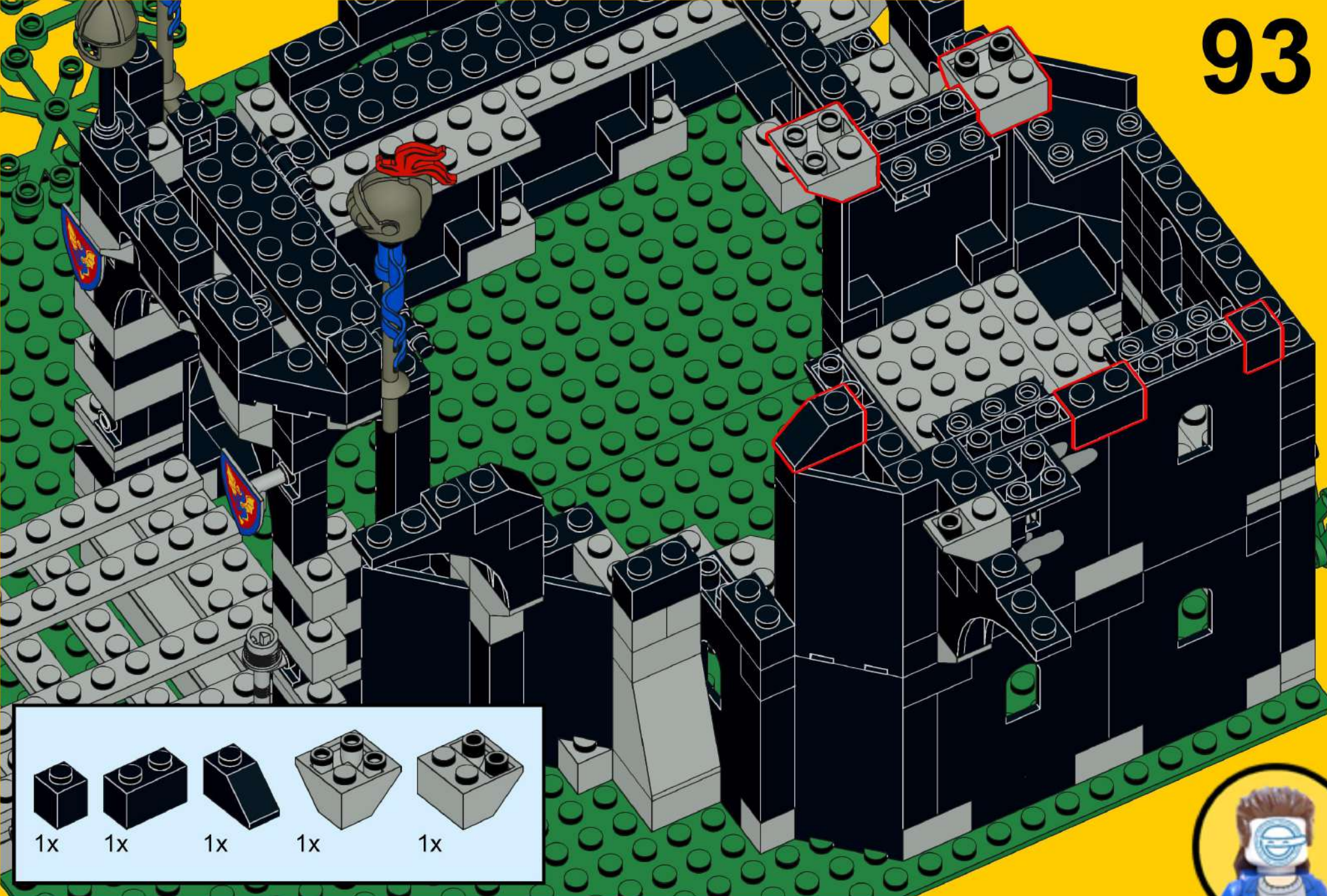

- 1x [black 1x1 brick]
- 1x [black 1x2 brick]
- 1x [black 1x2 wedge]
- 1x [grey 1x2 brick with 4 holes]
- 1x [grey 1x2 brick with 4 holes and notch]



# 94

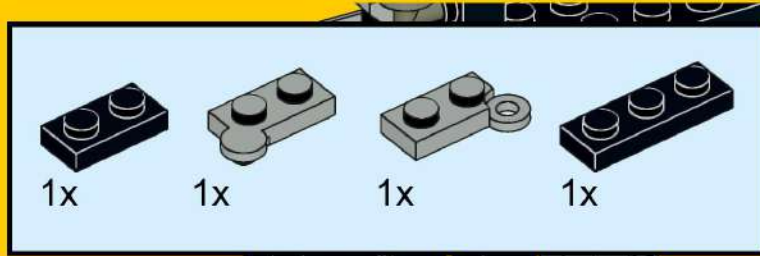

# 95

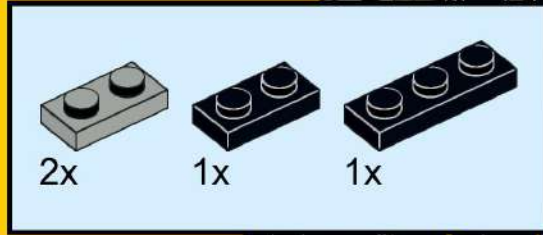

# 96

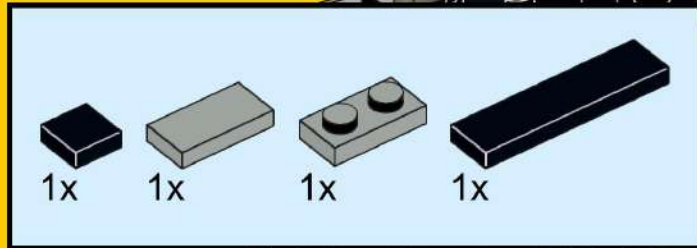

# 97

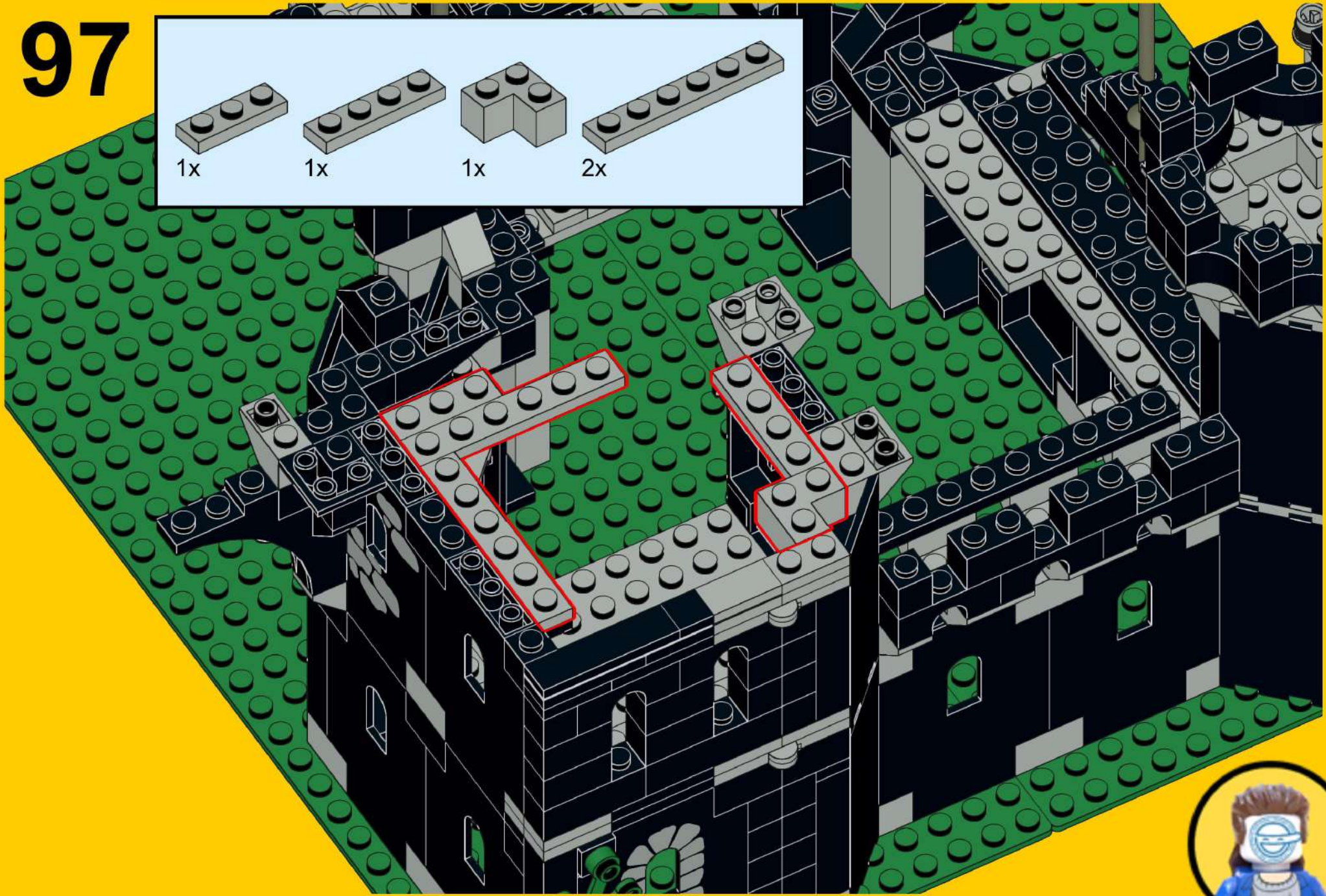
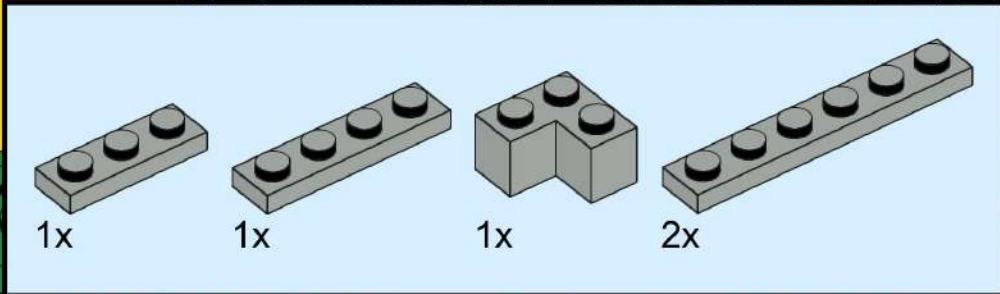

# 98

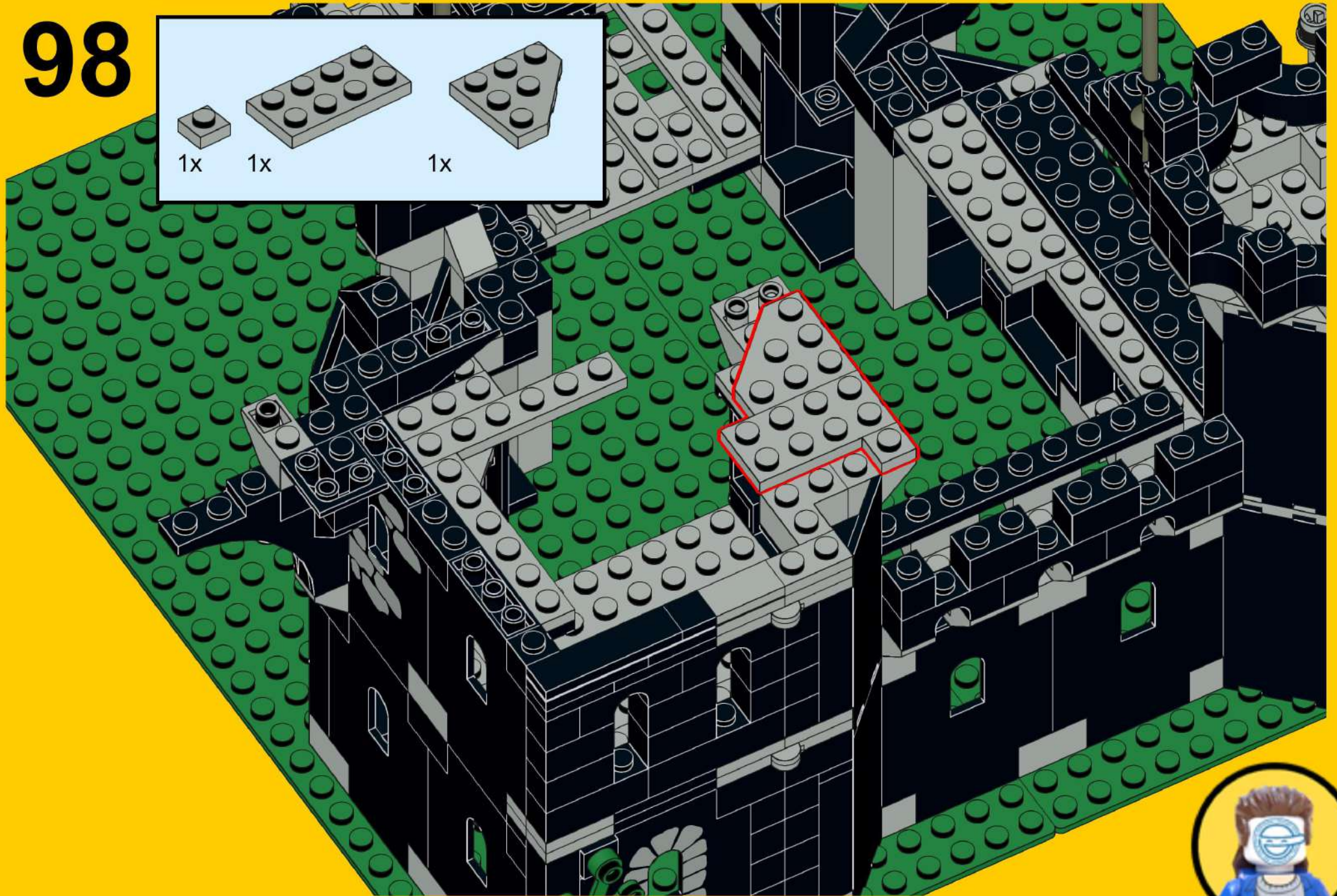
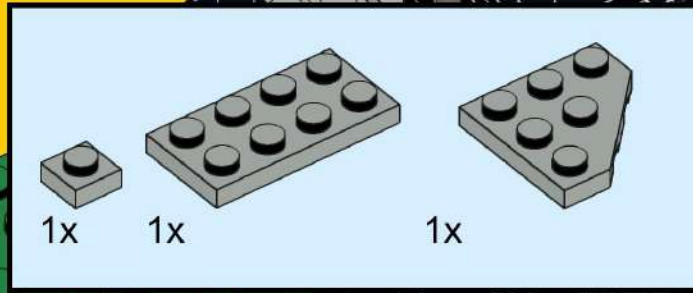

# 99

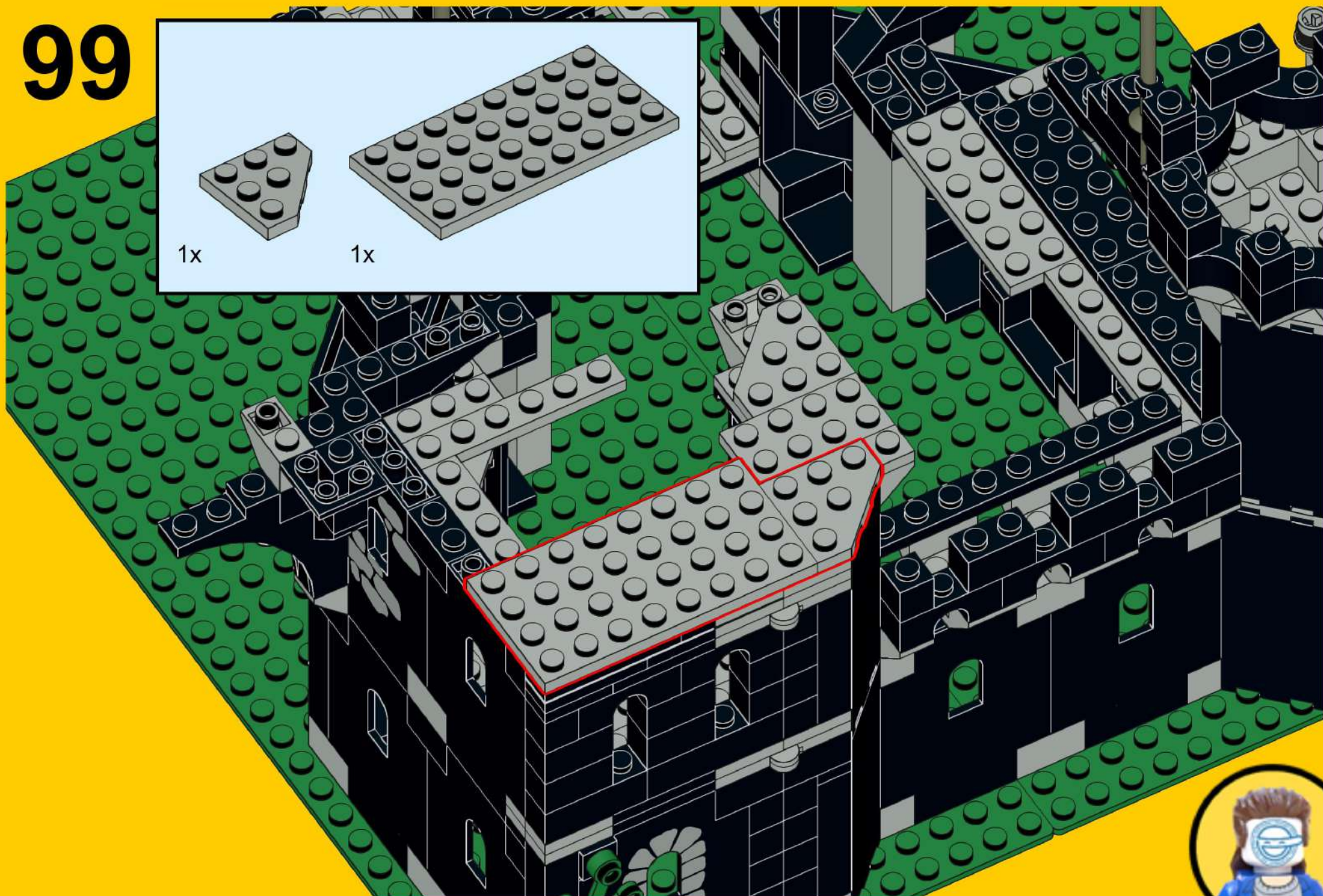
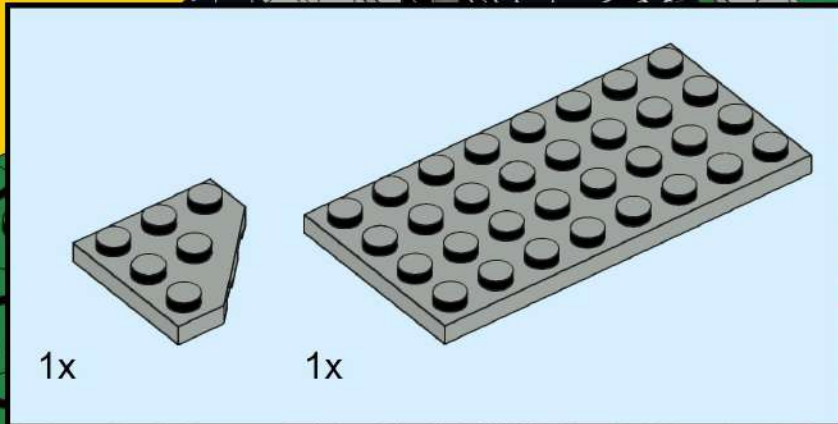

# 100

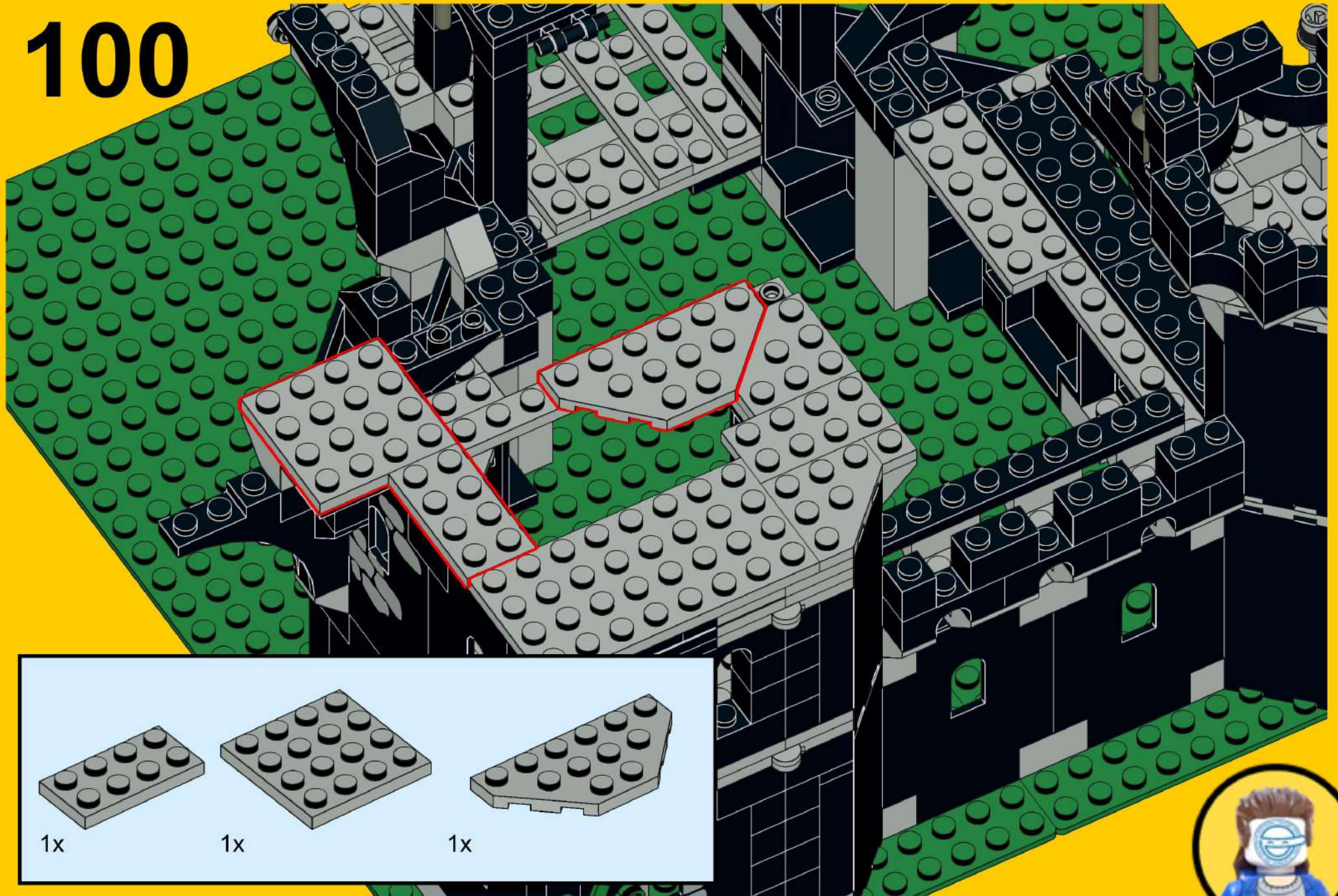



# 101

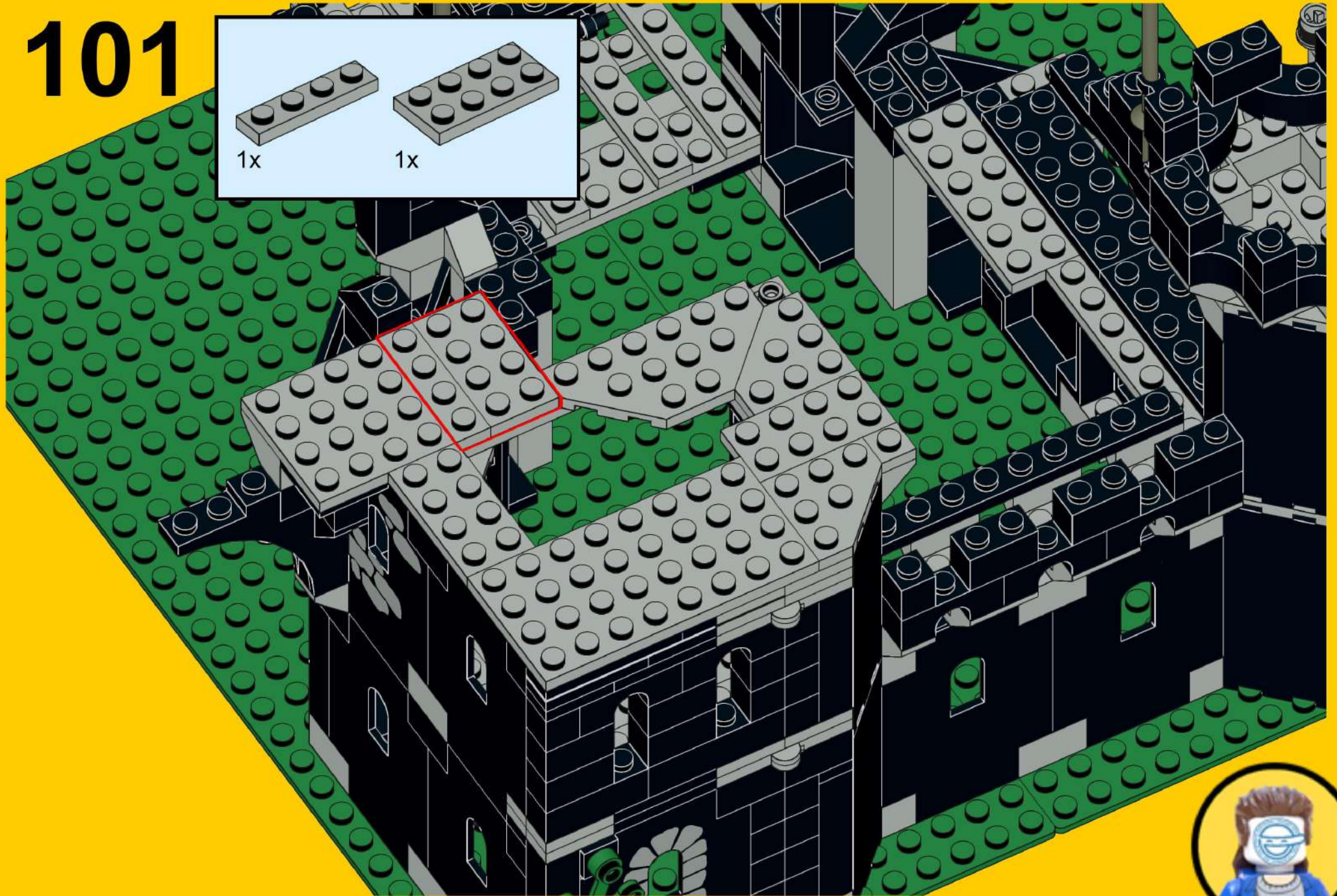
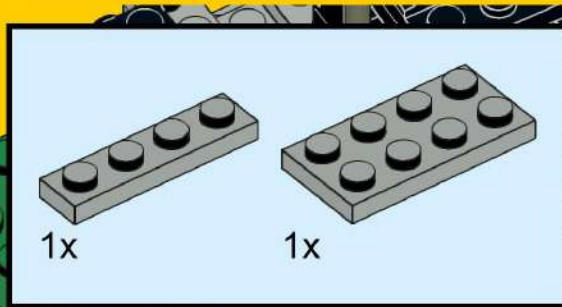

# 102

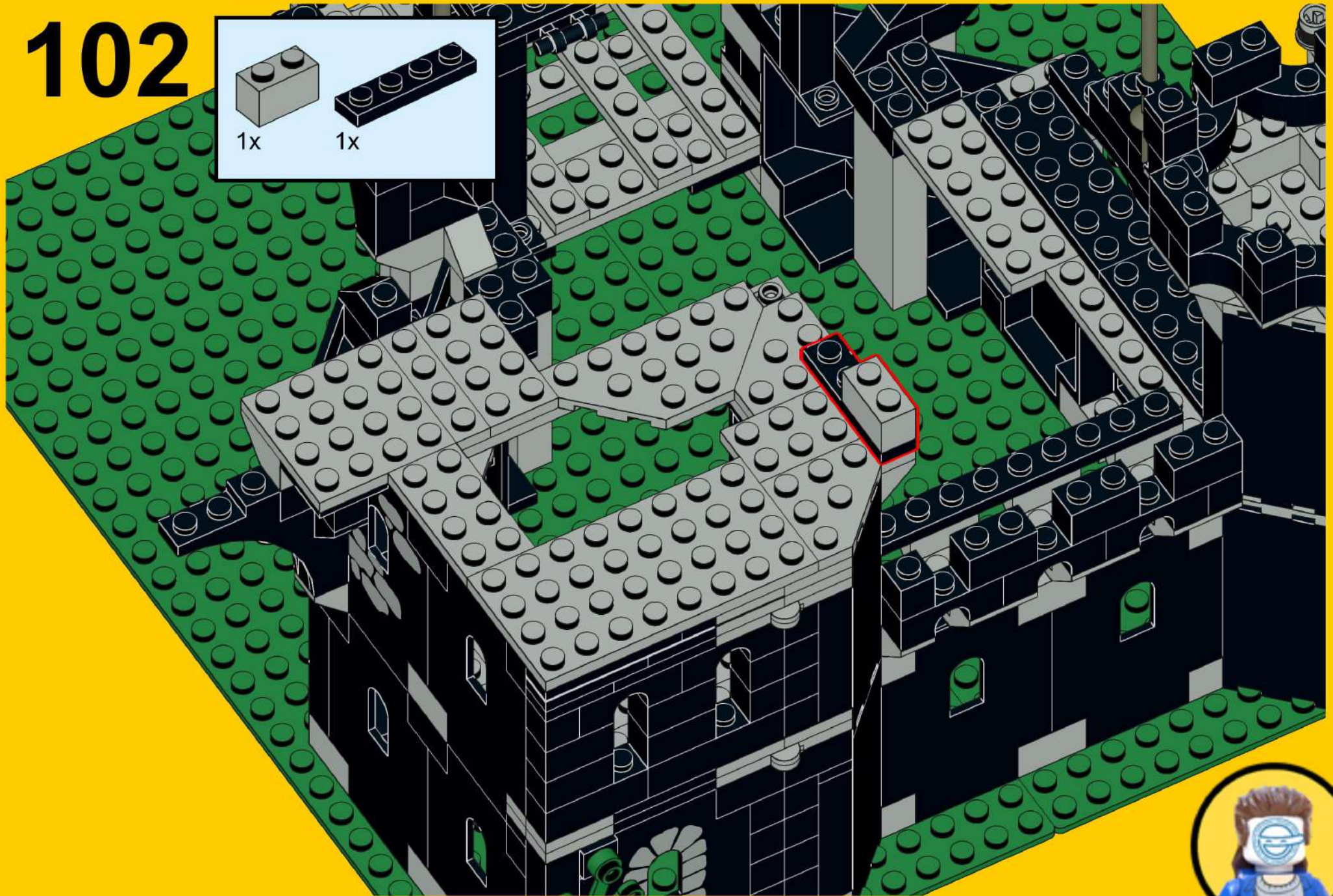
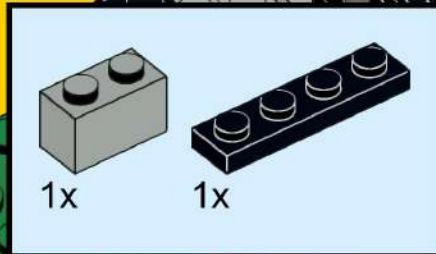

# 103

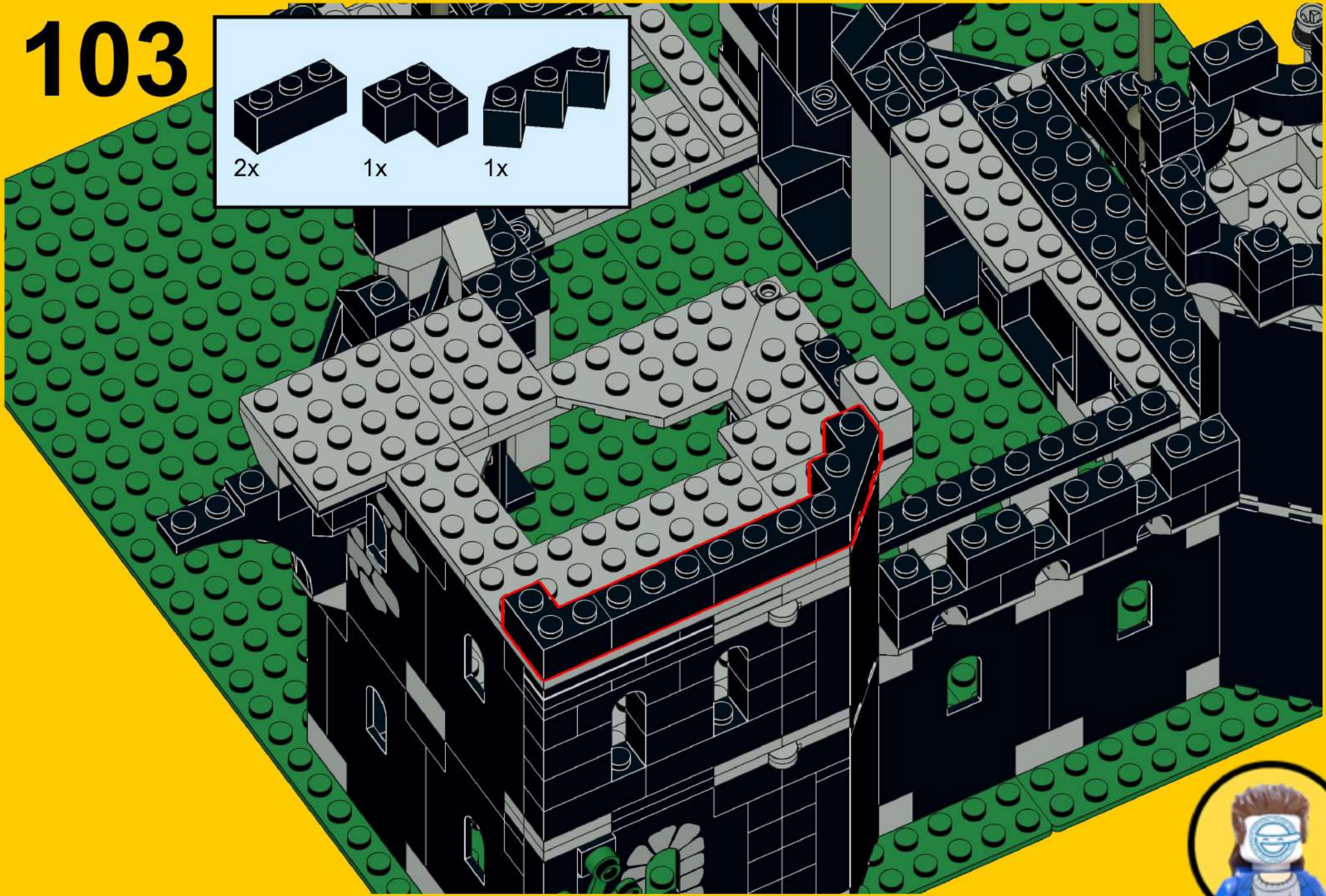
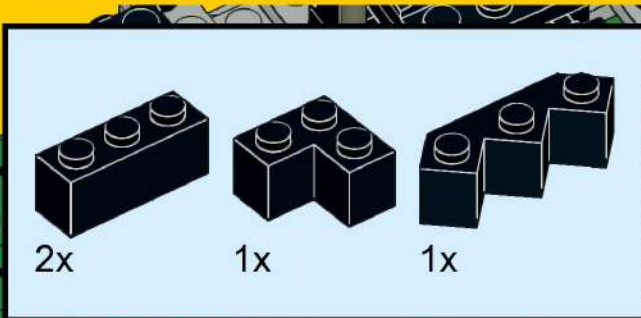

# 104

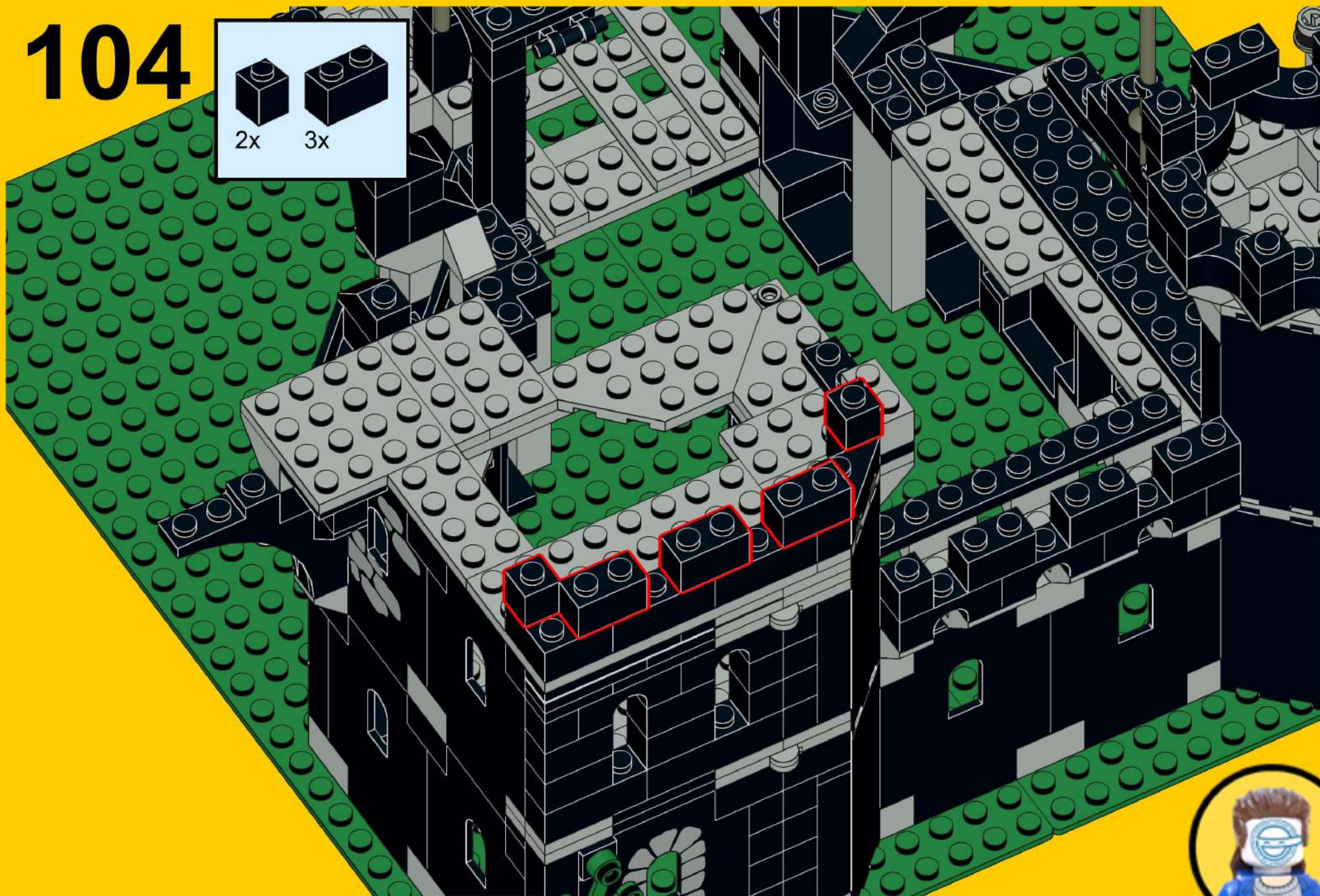
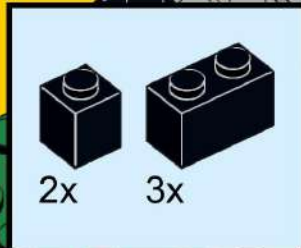

# 105

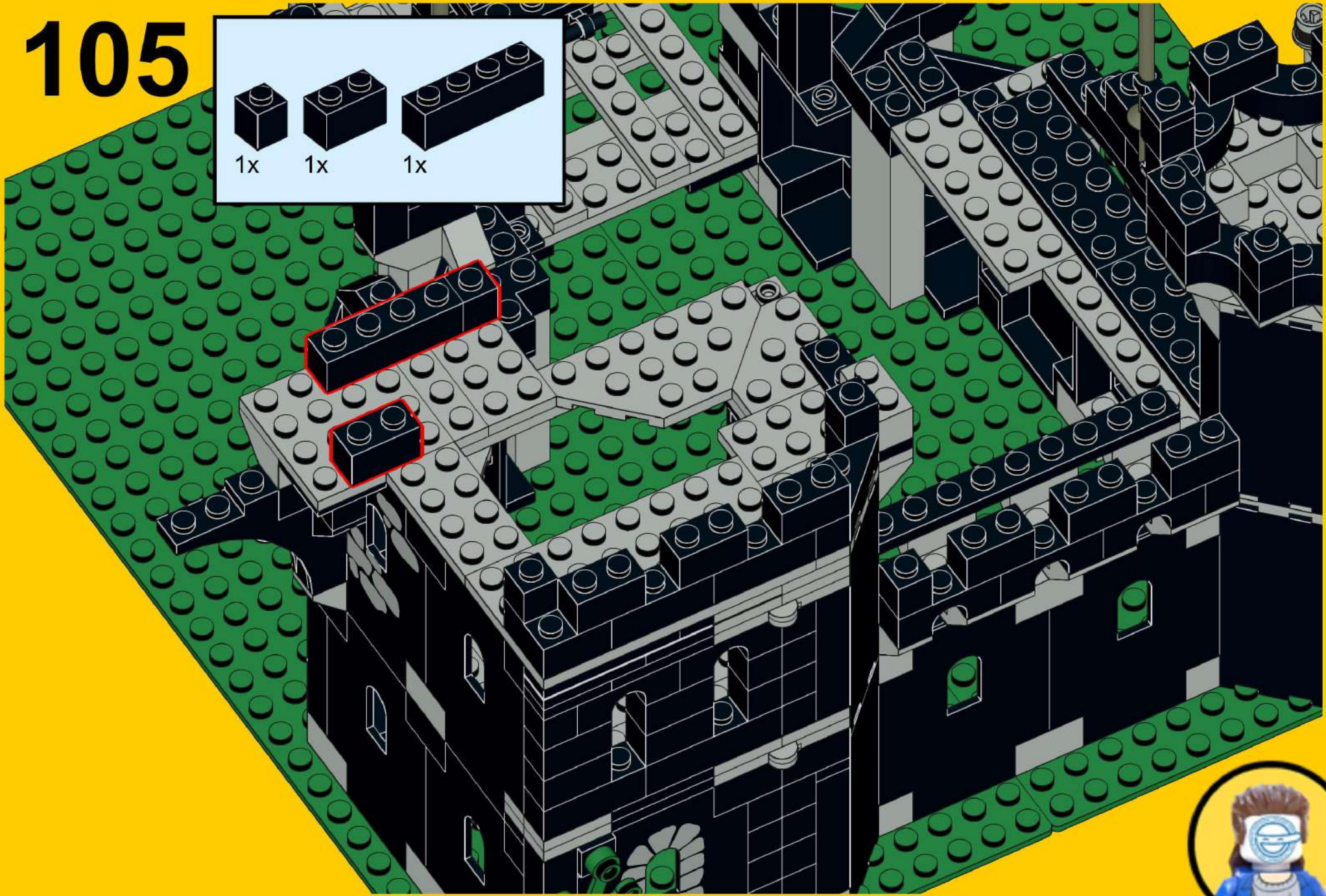
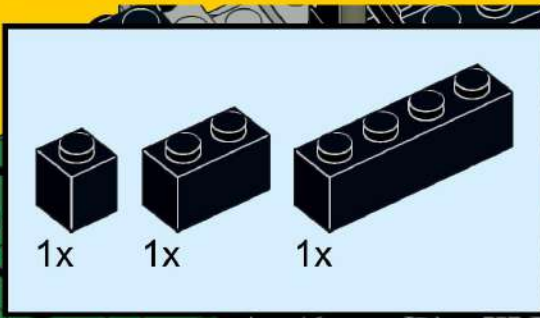

# 106

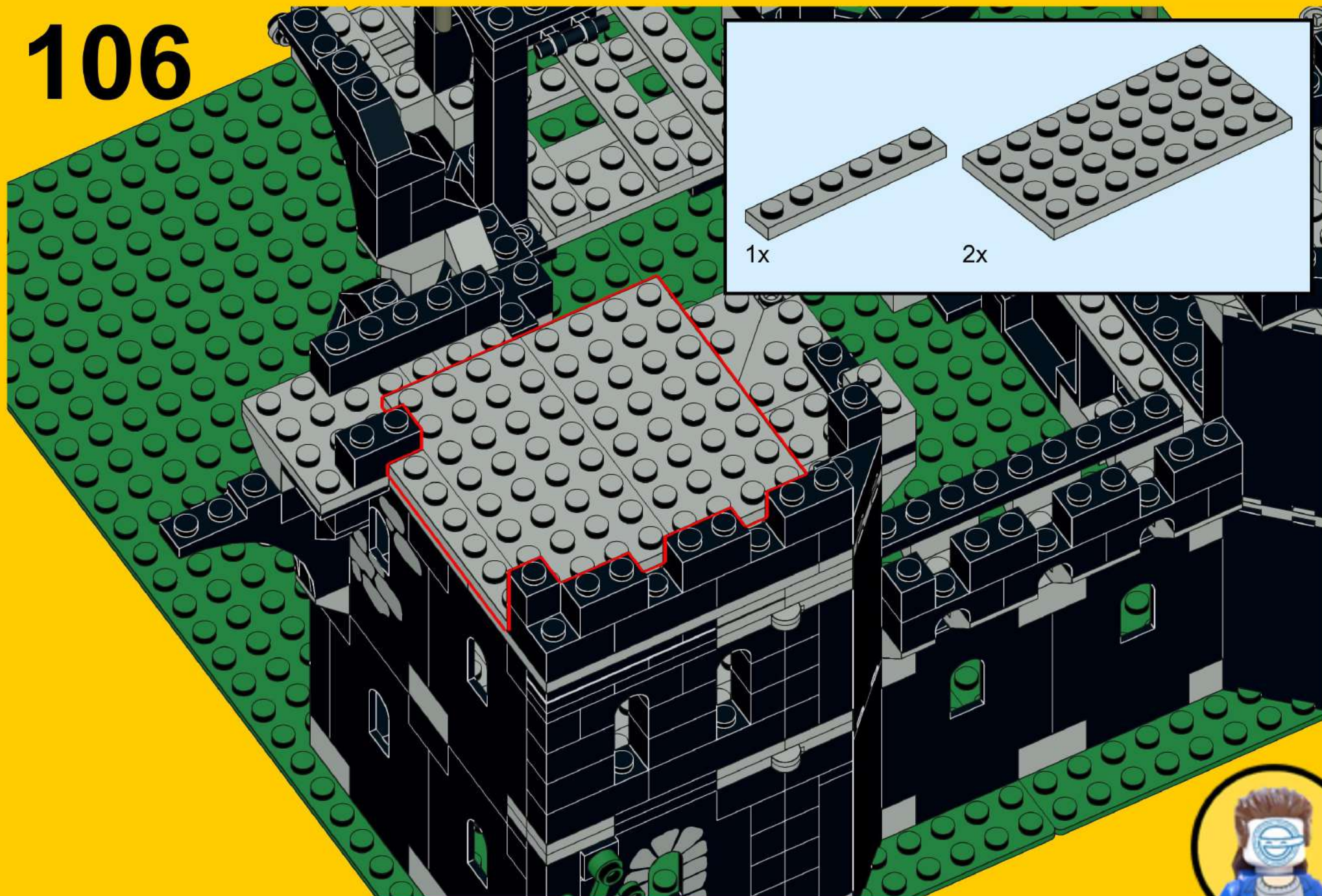

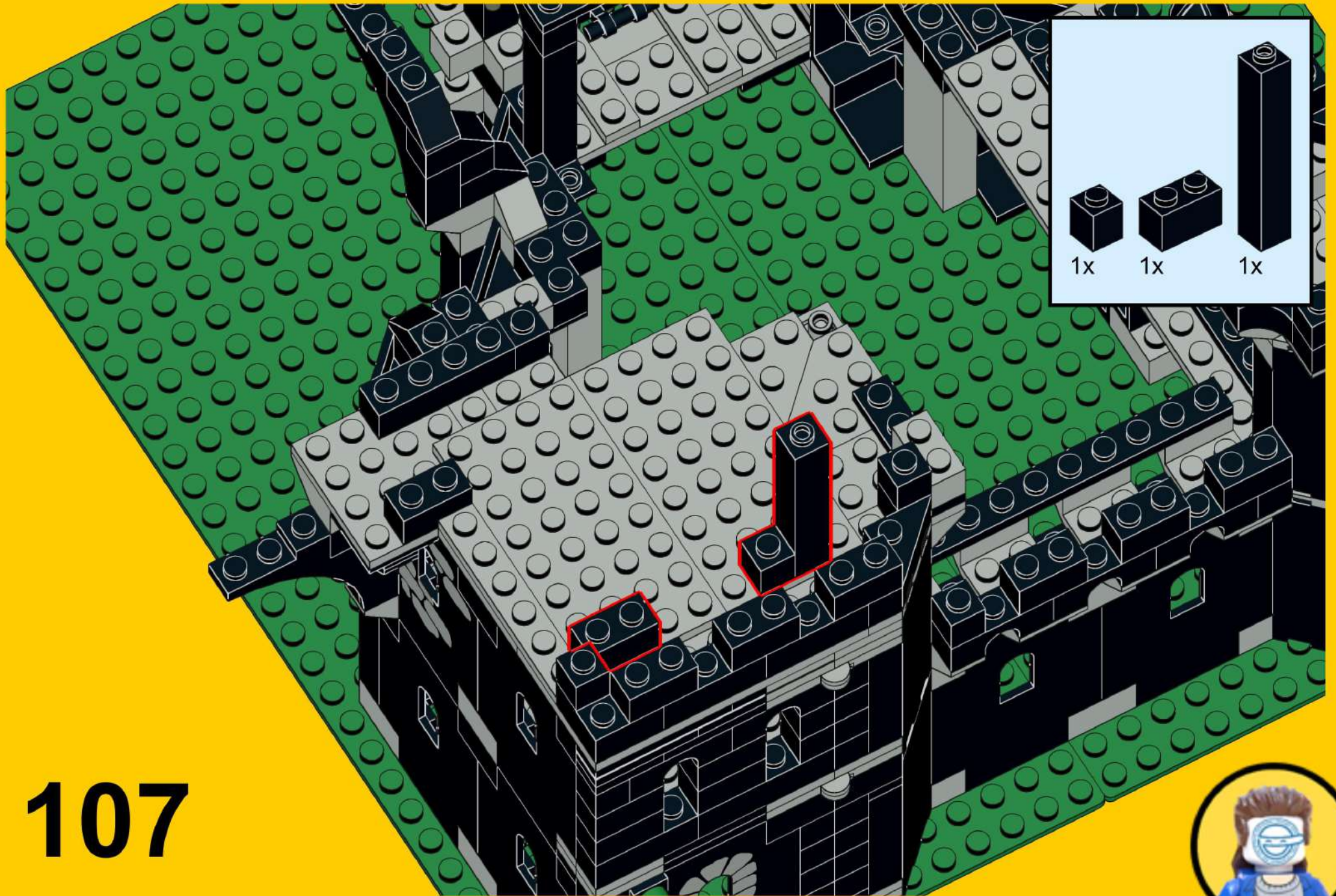

107



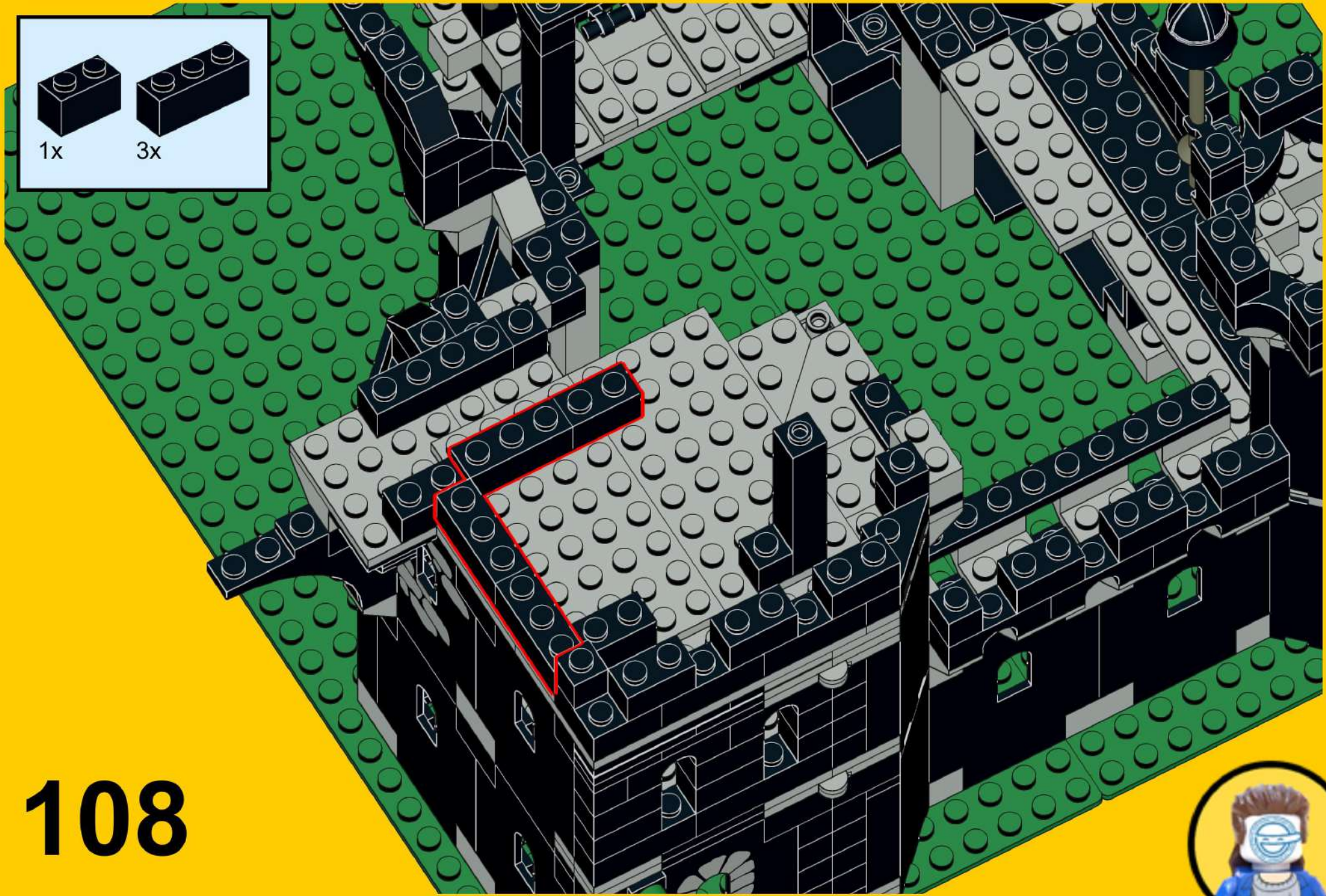
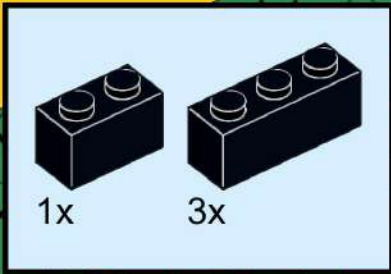

108





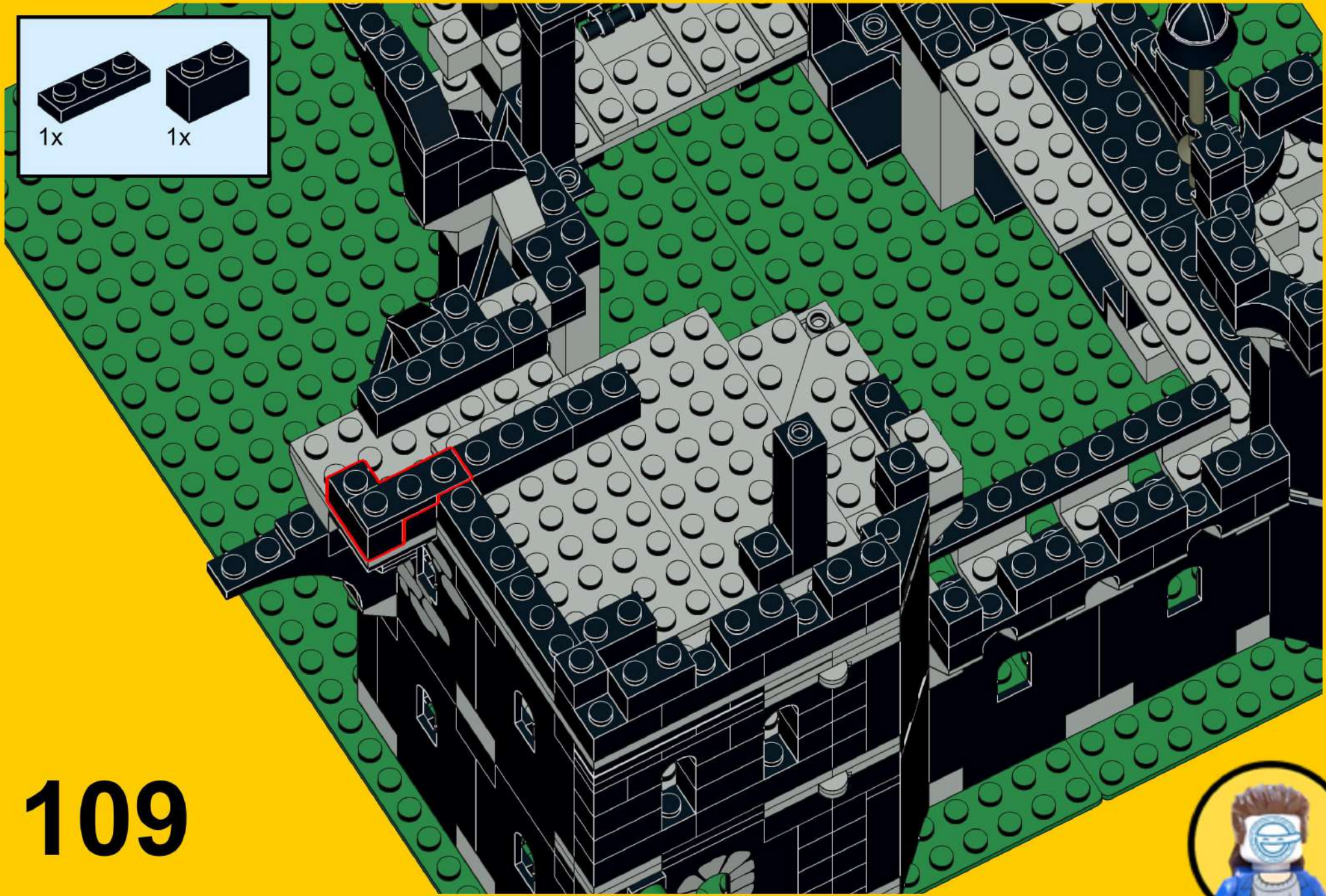
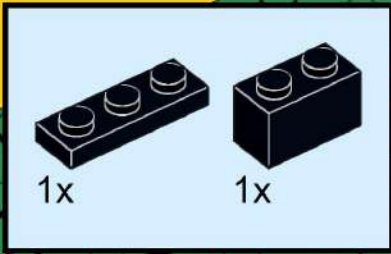

109



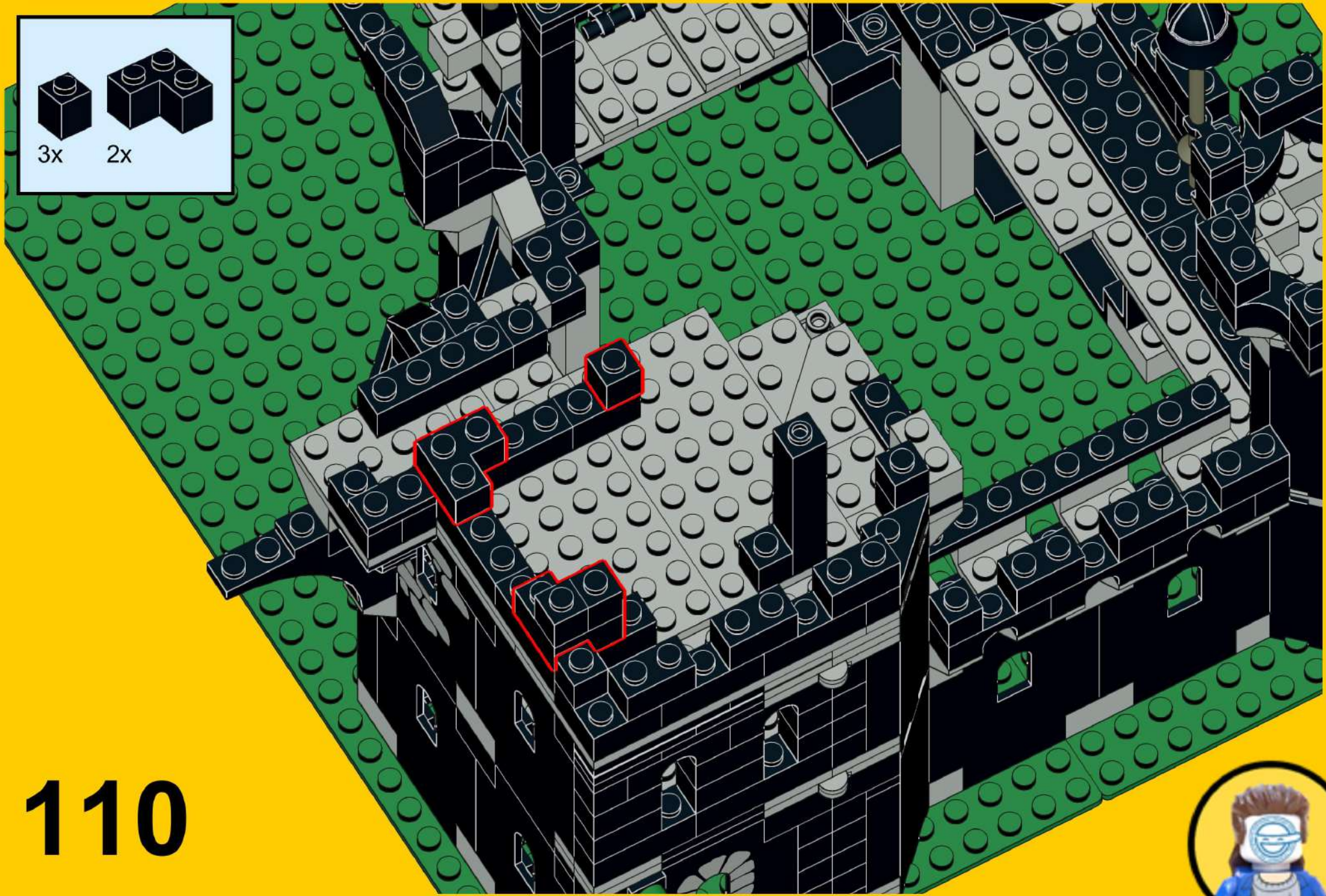
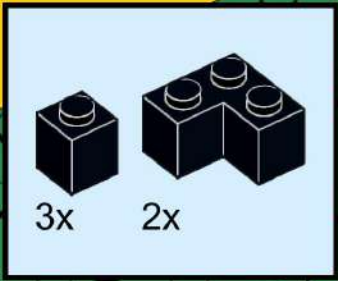

110



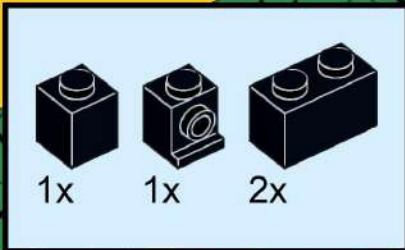

1x 1x 2x

This inset box shows the parts required for step 111: one 1x1 black brick, one 1x2 black brick with a hole, and two 1x2 black bricks.

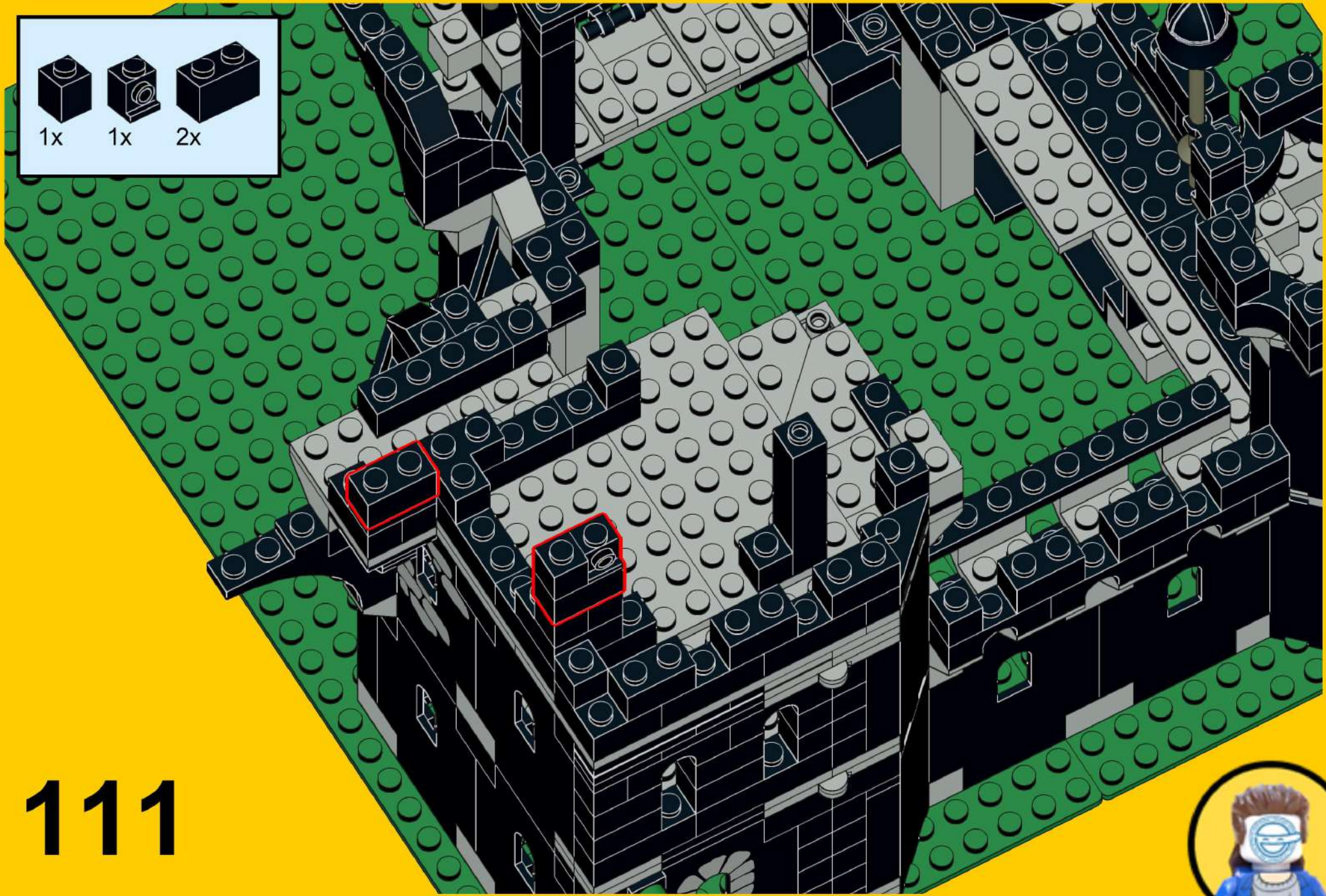

111



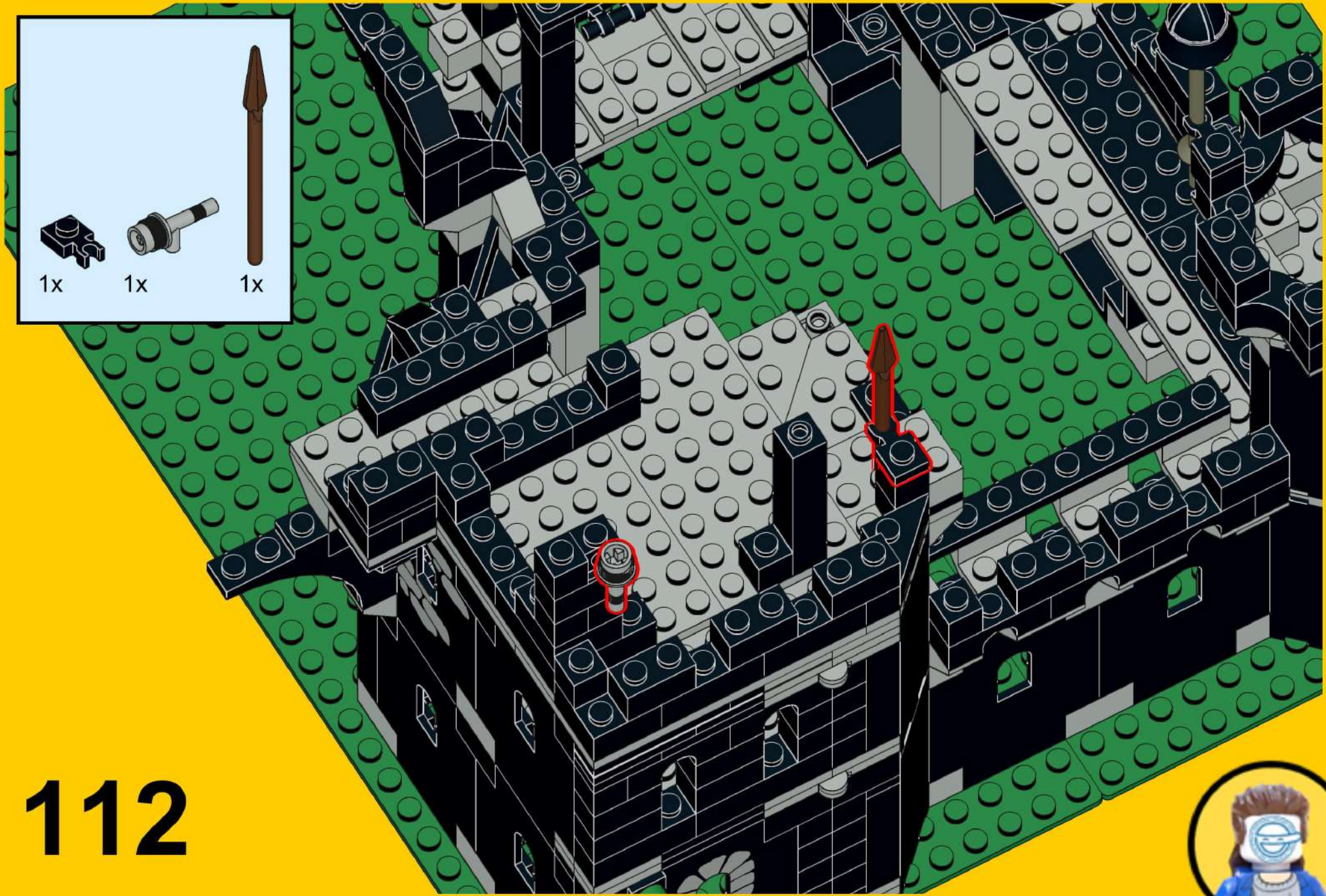
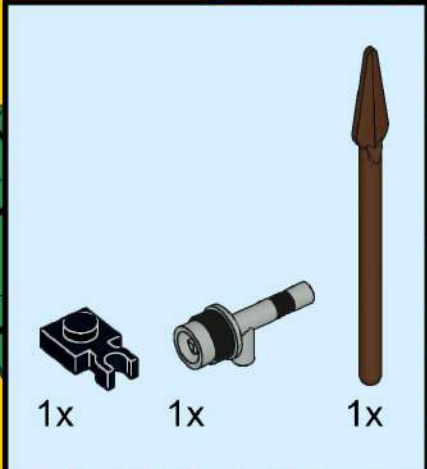

112



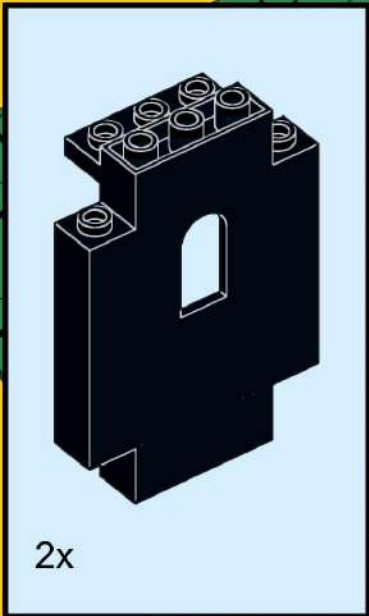

2x

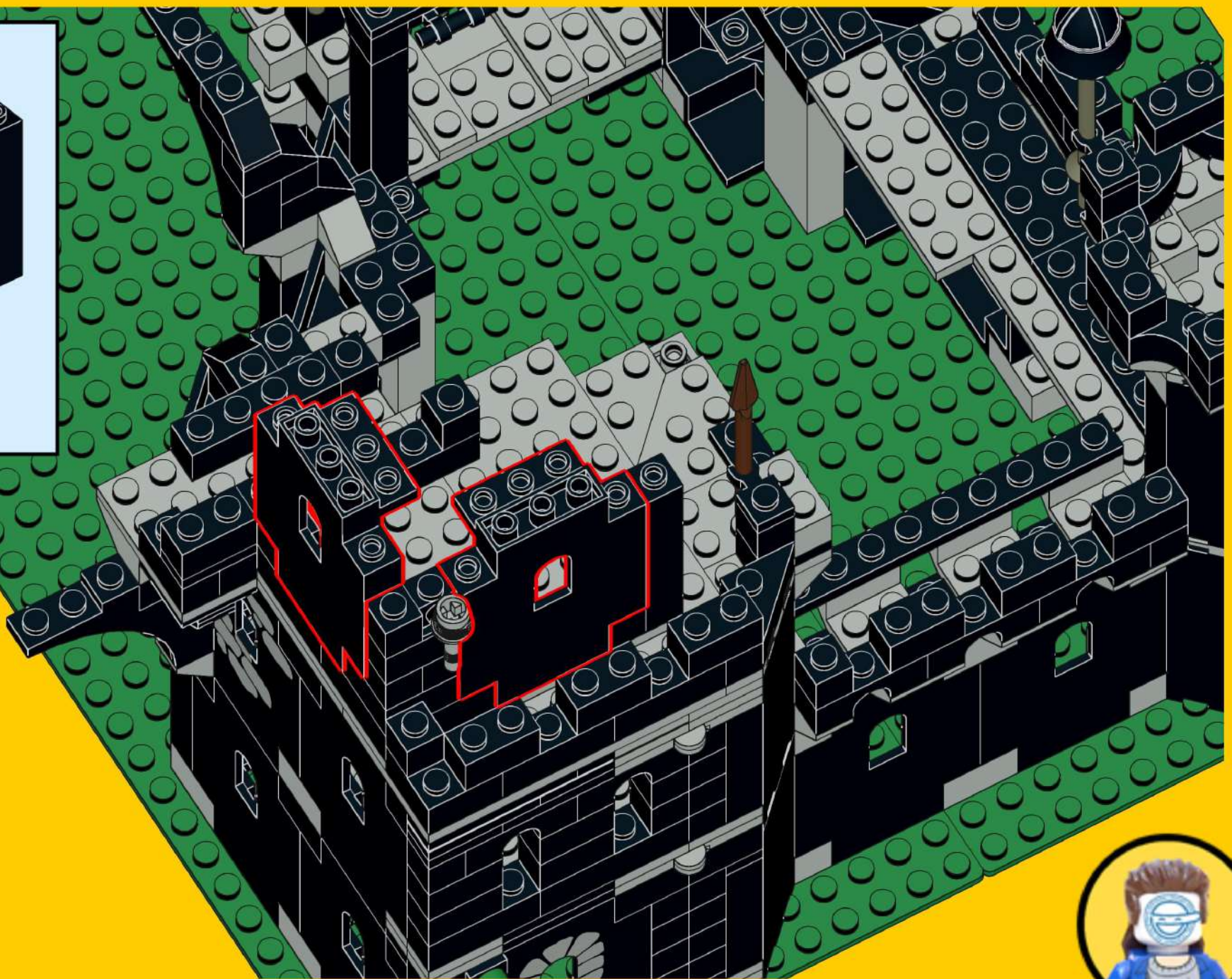

113



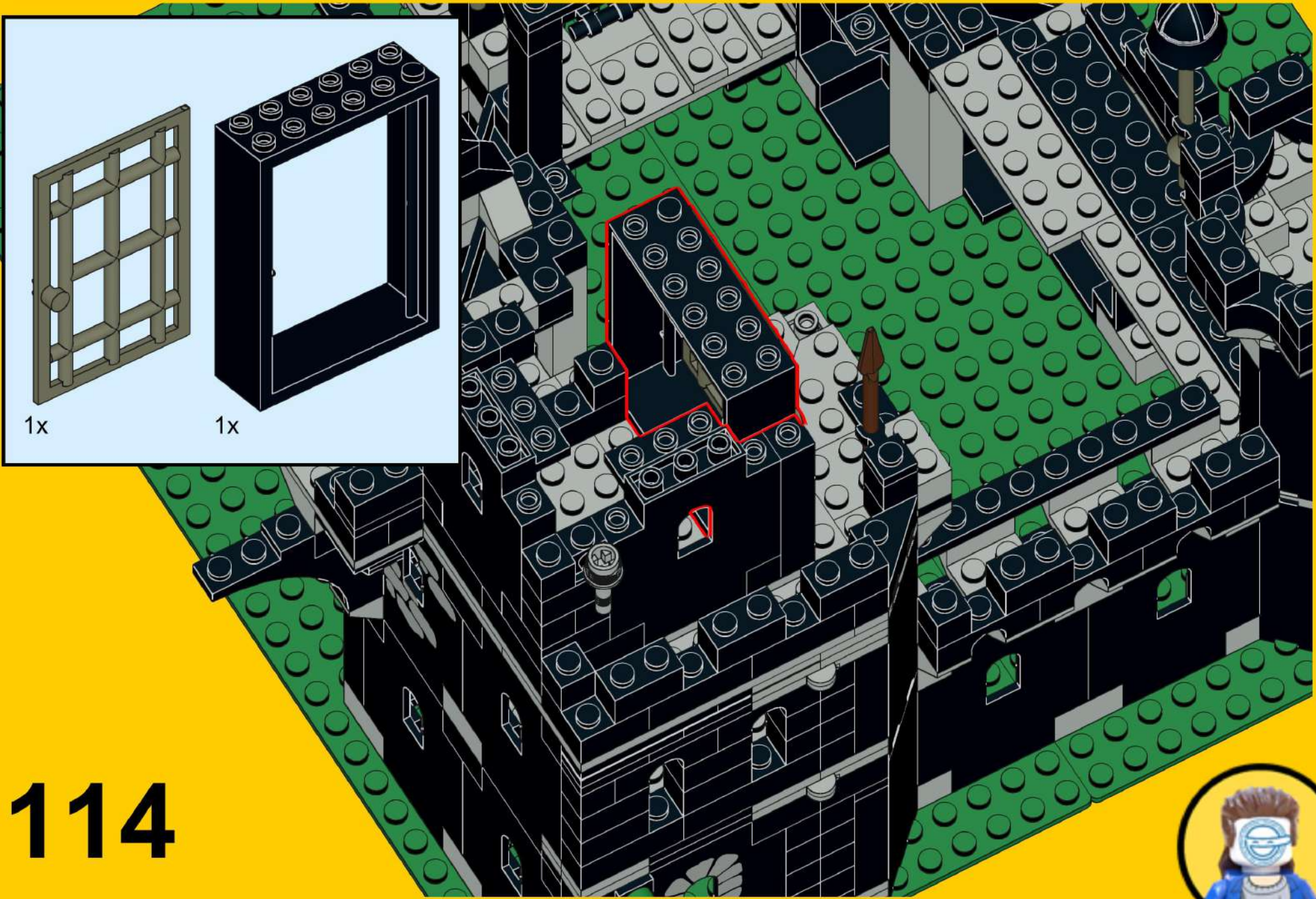

114



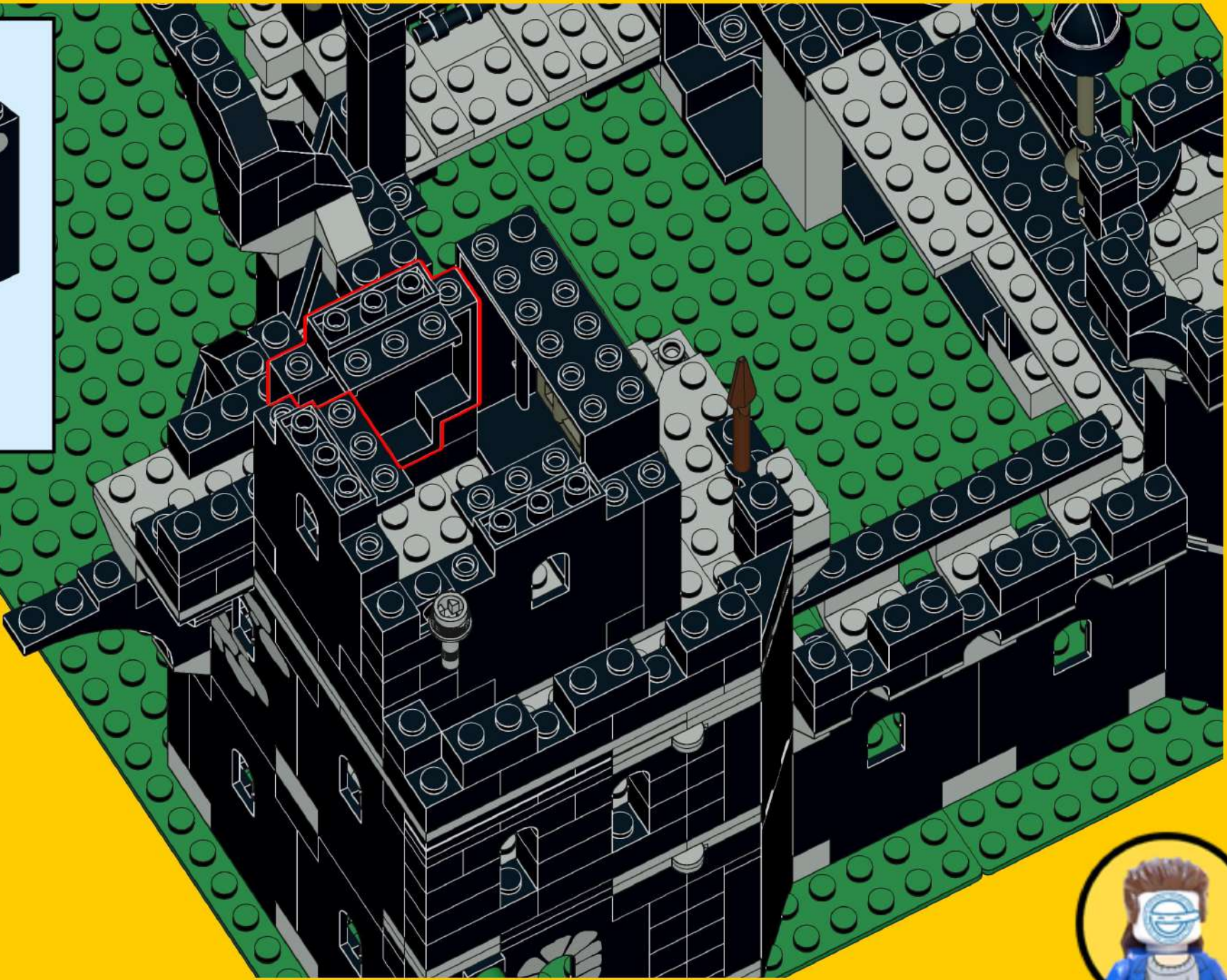
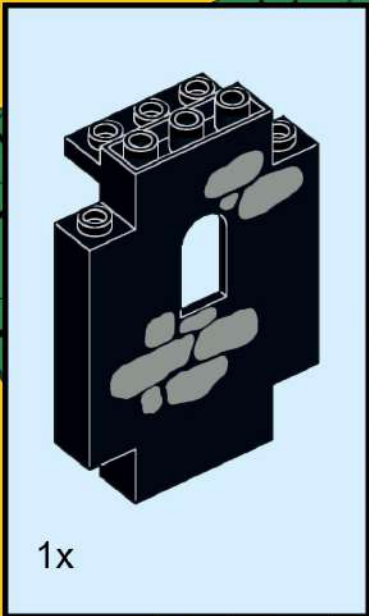

115



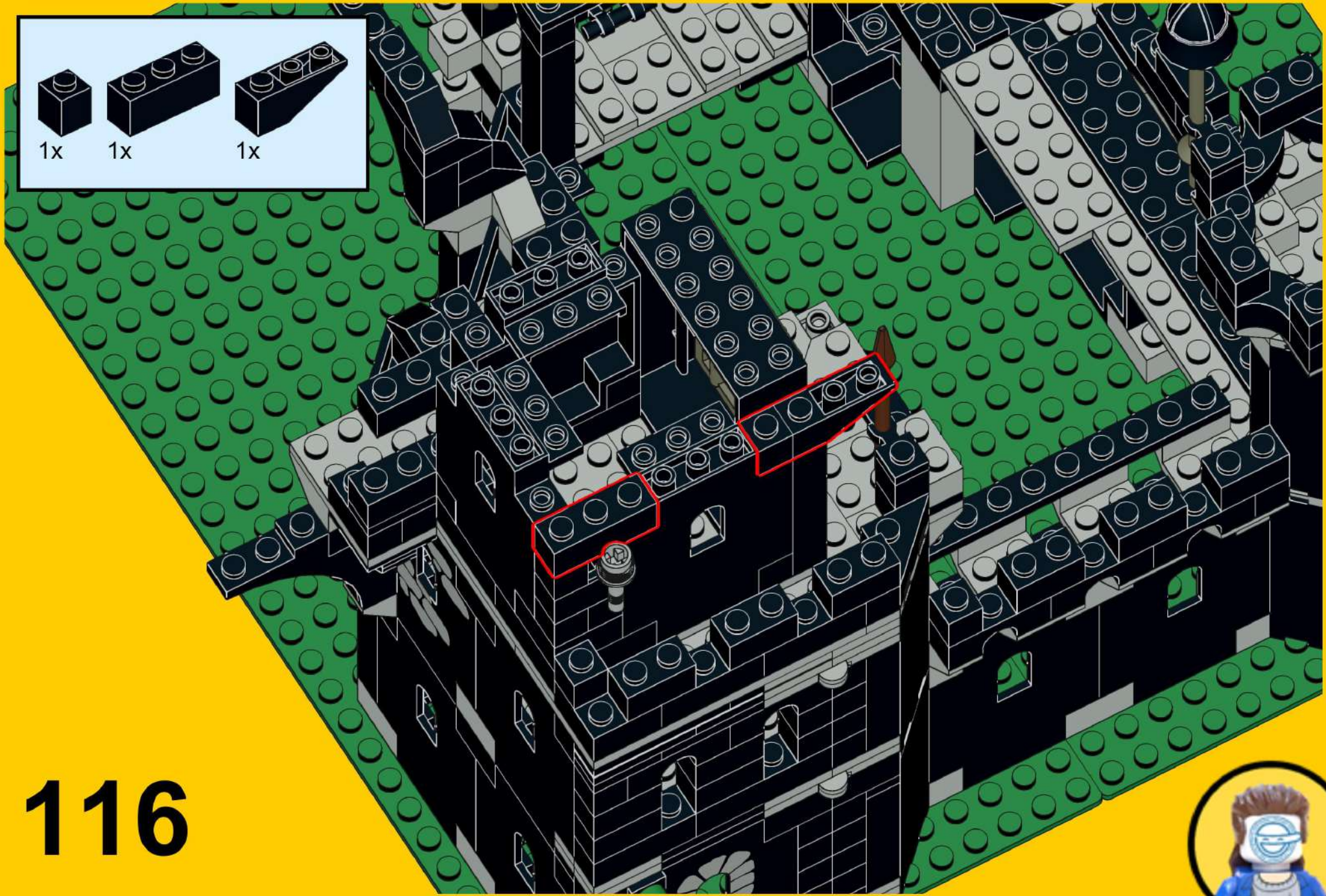
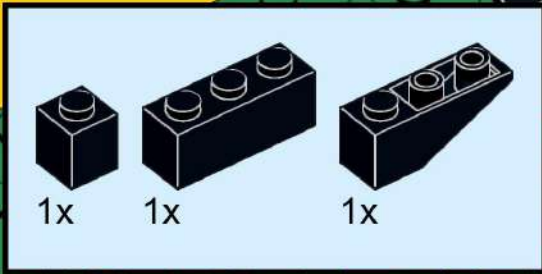

116







117

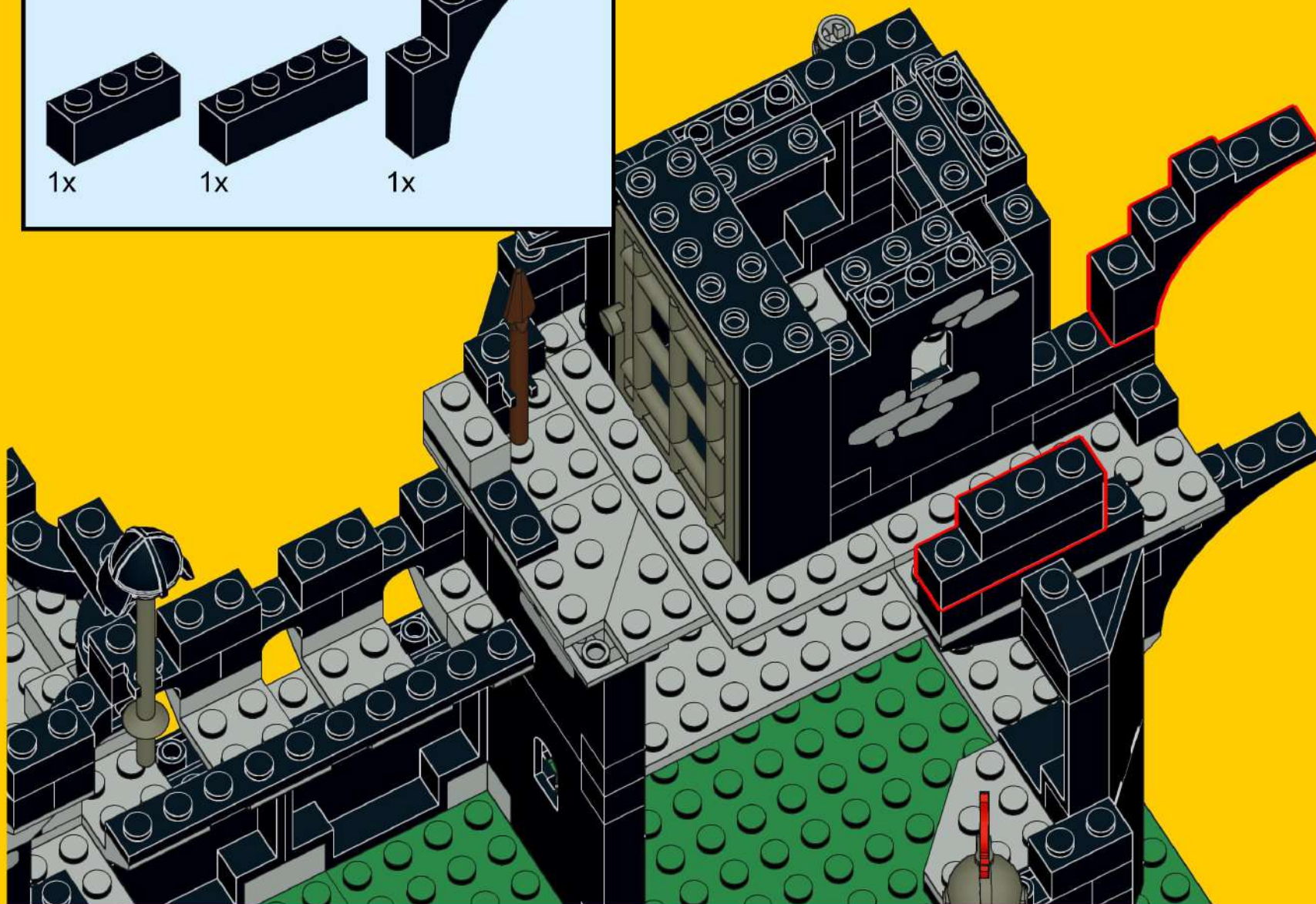
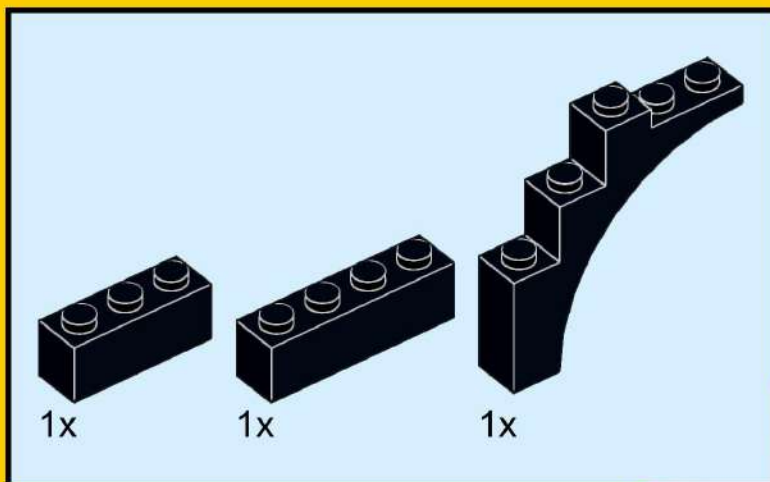

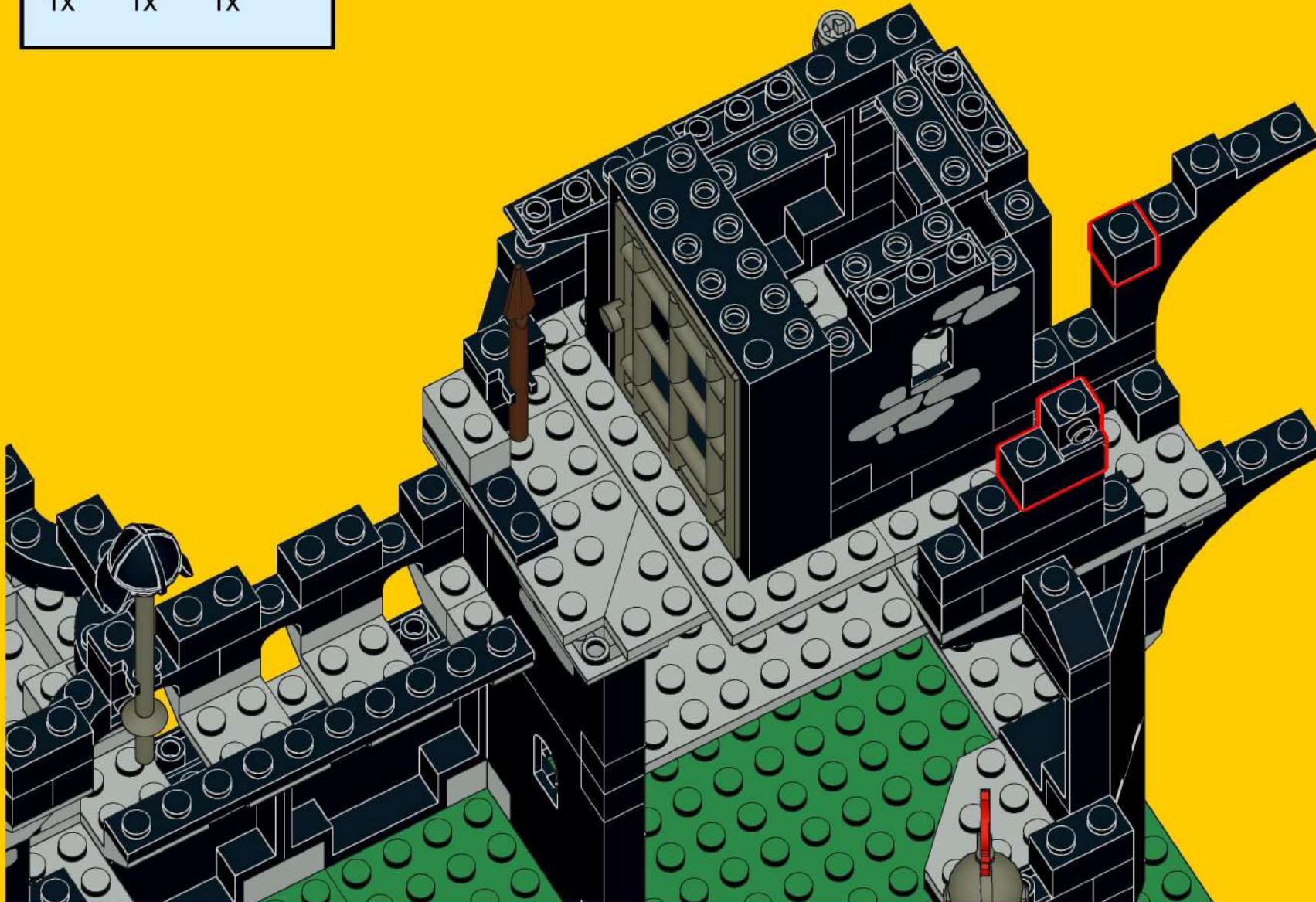
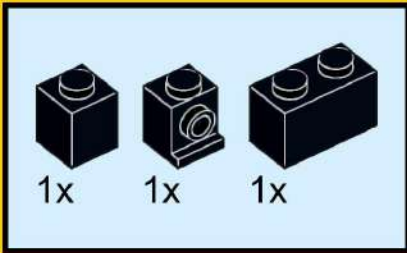

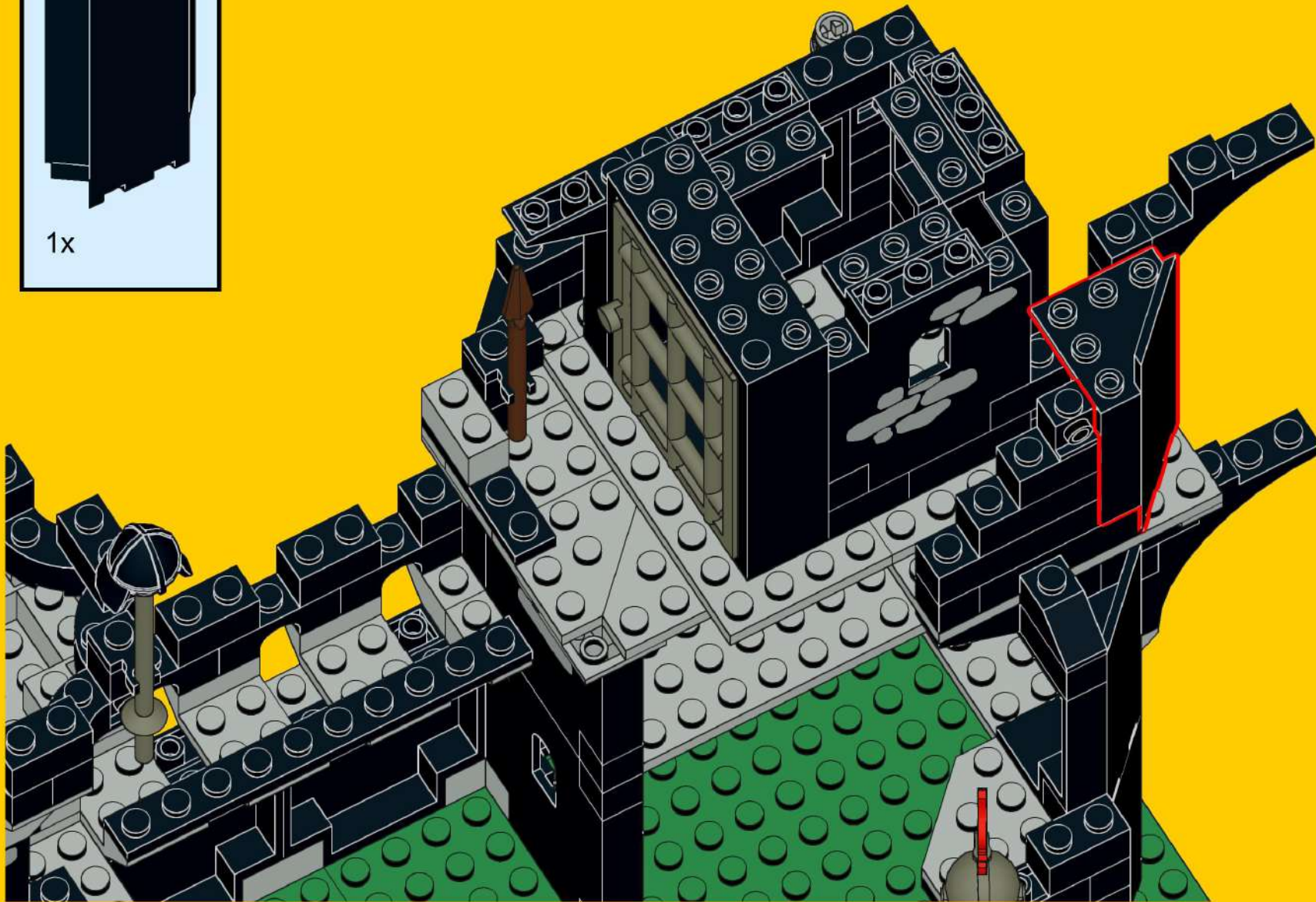
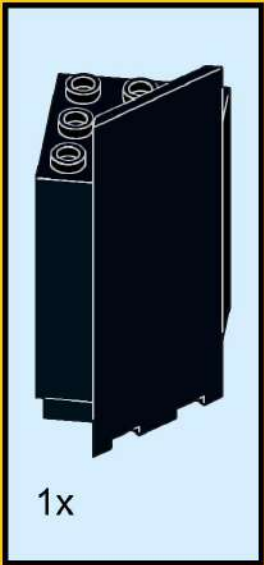

# 120

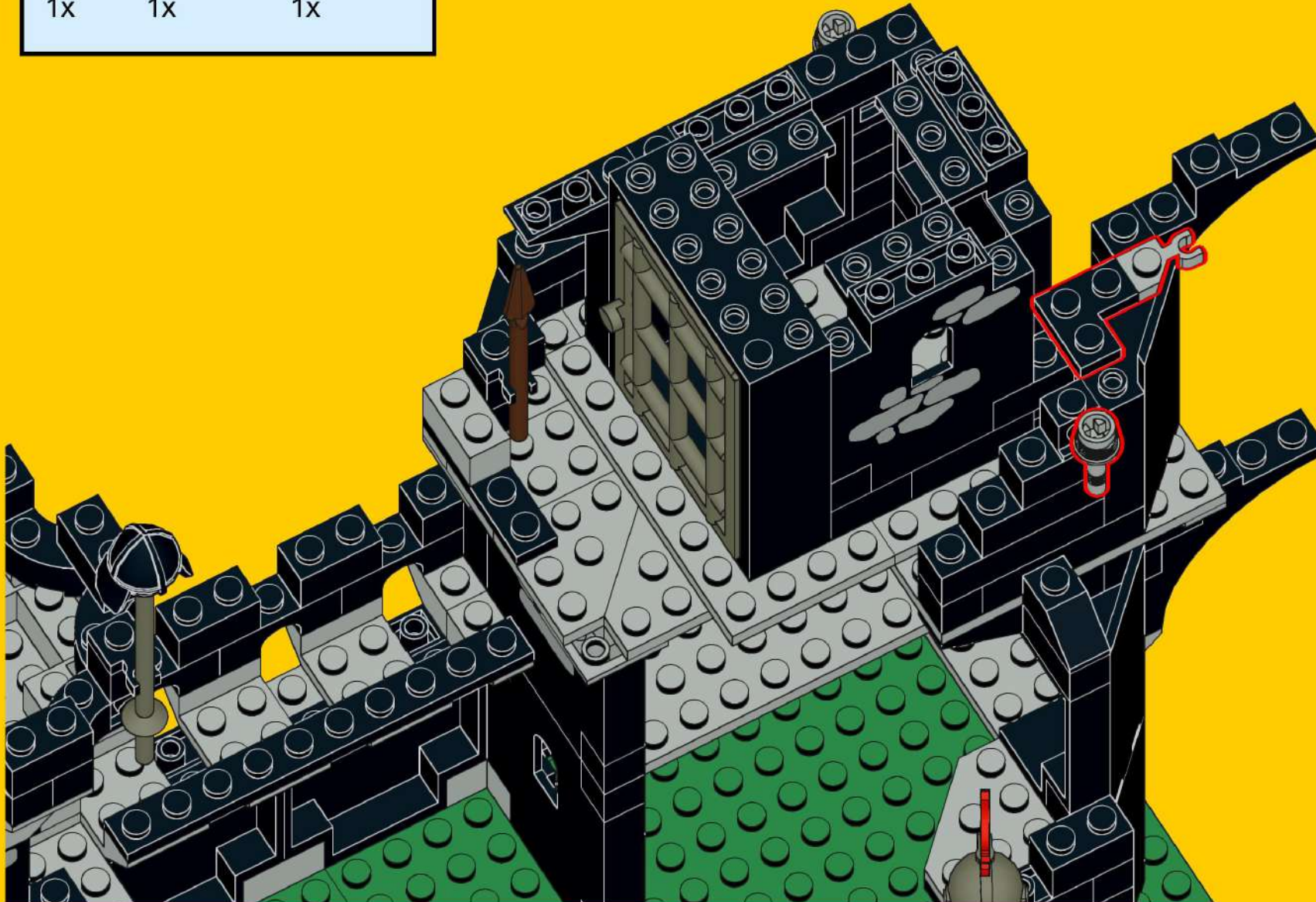
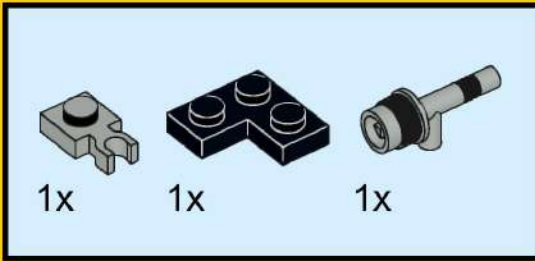

# 121

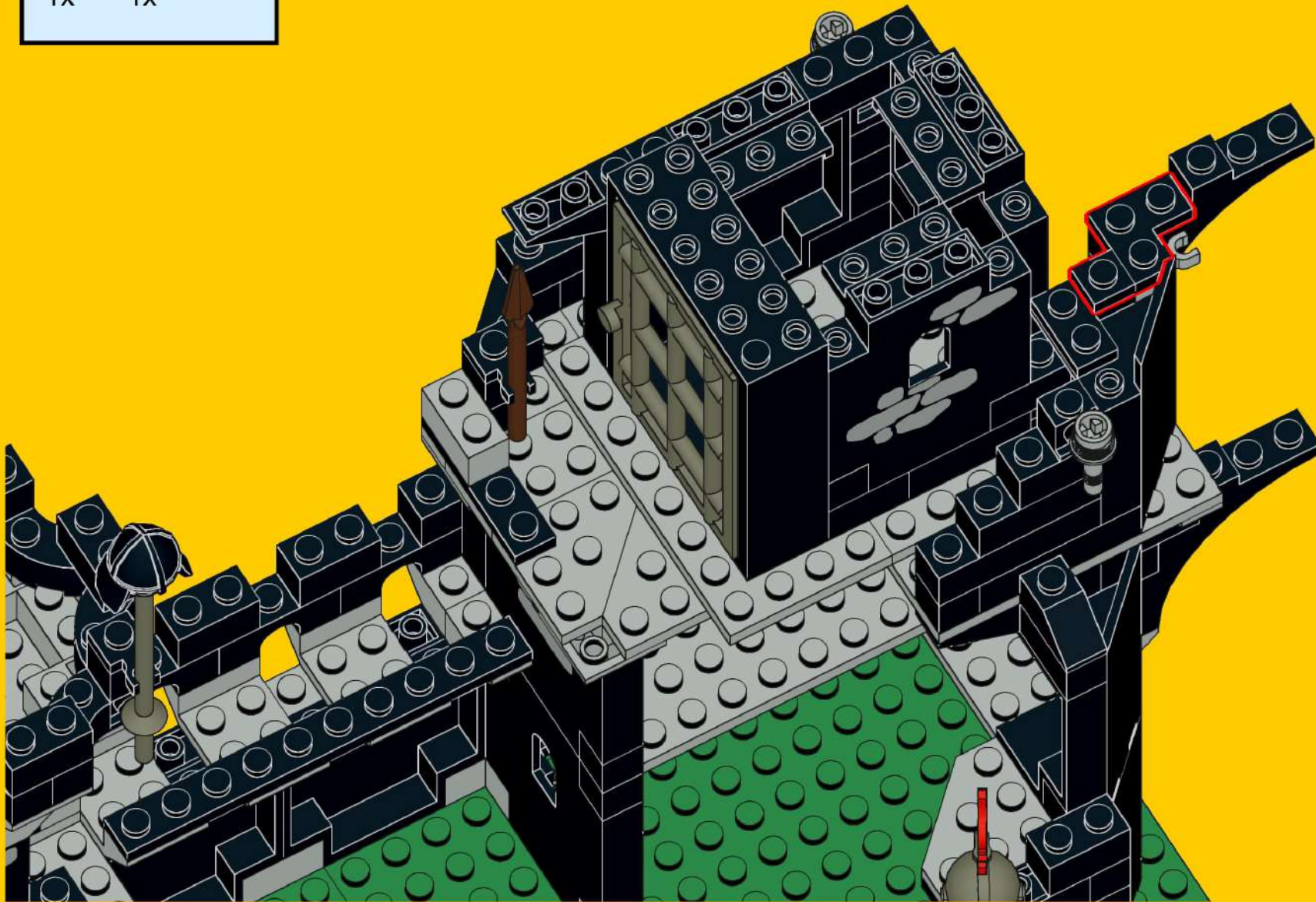
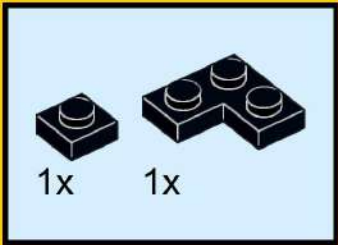

# 122

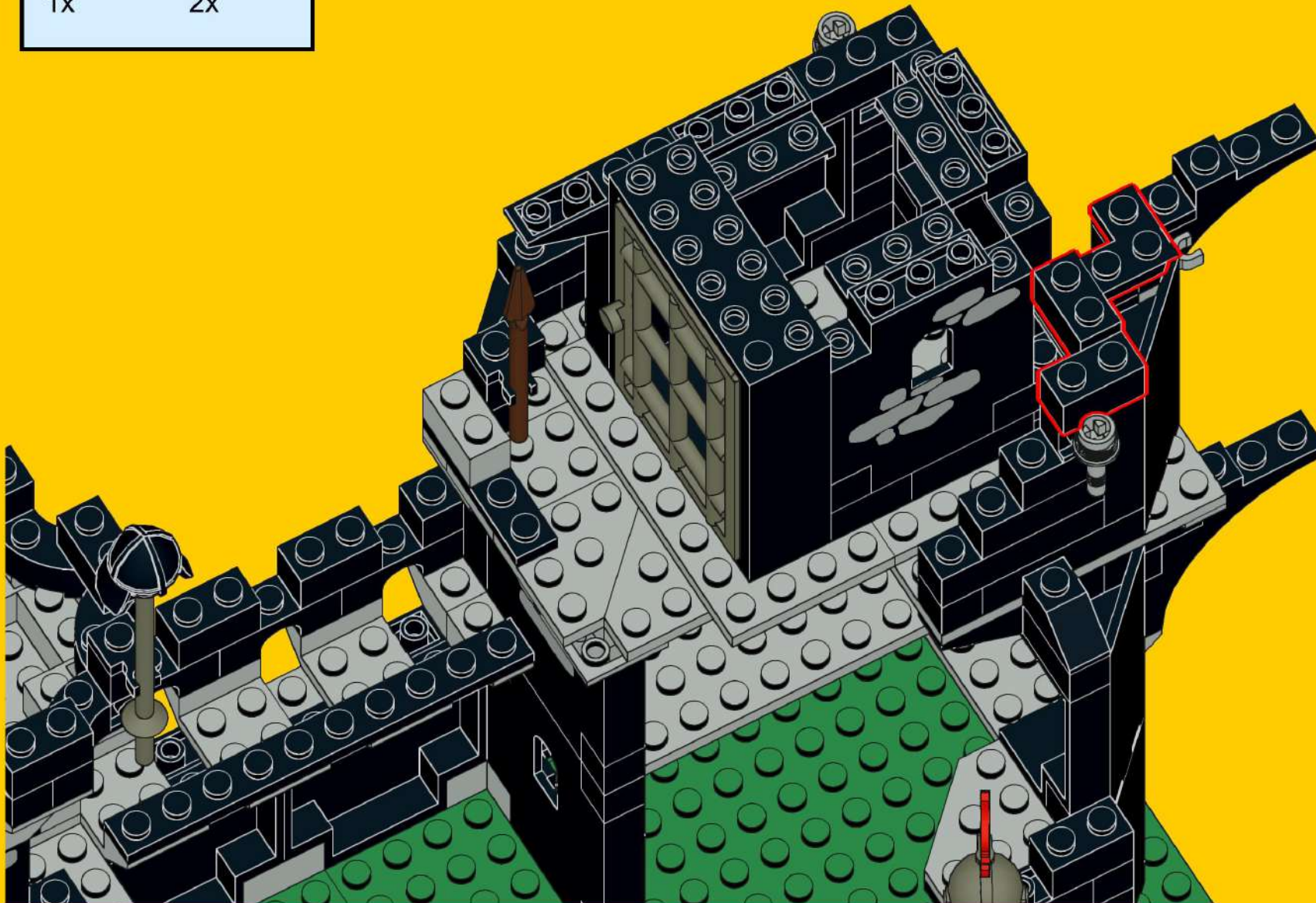
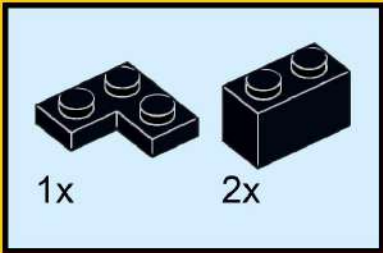

# 123

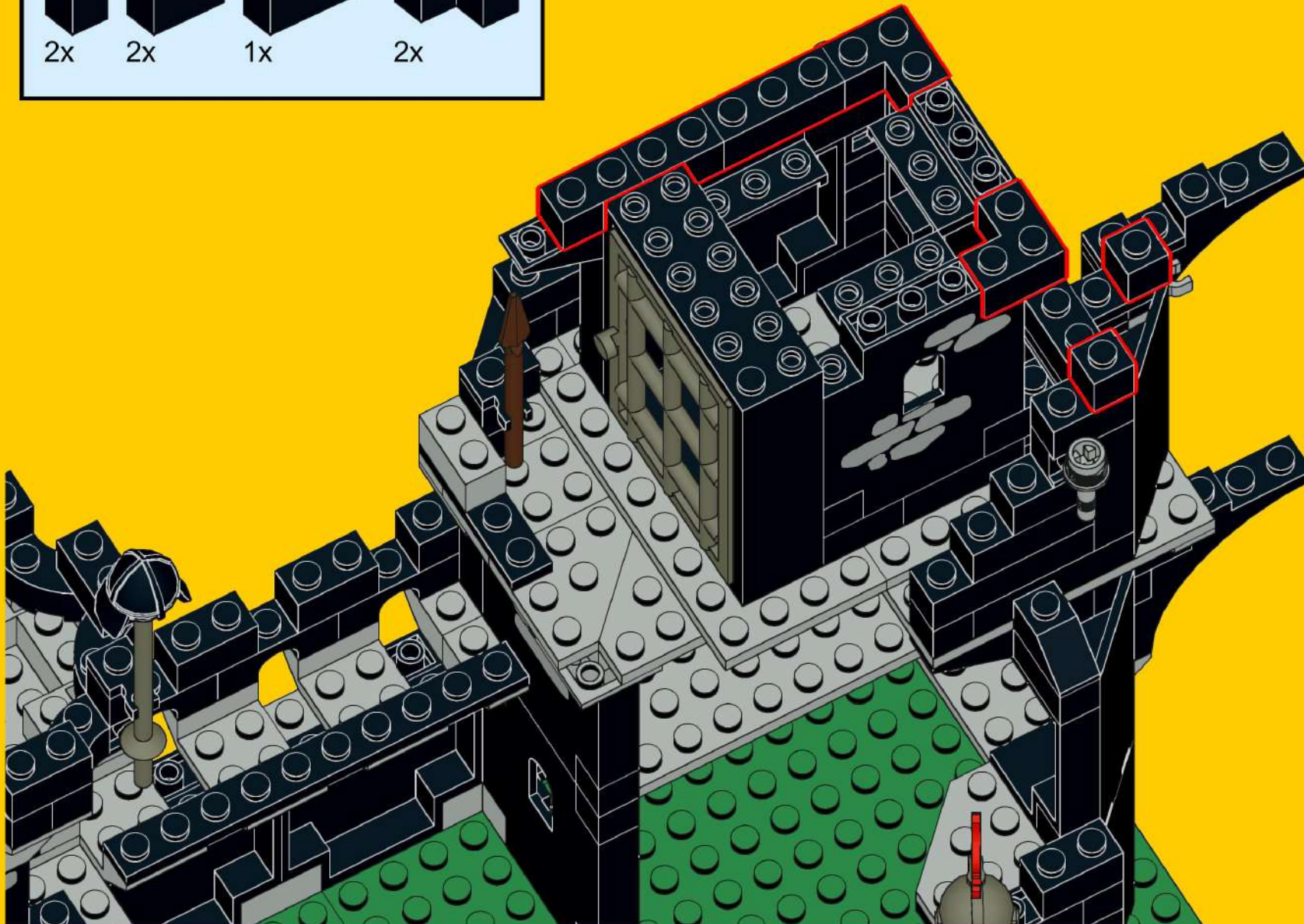
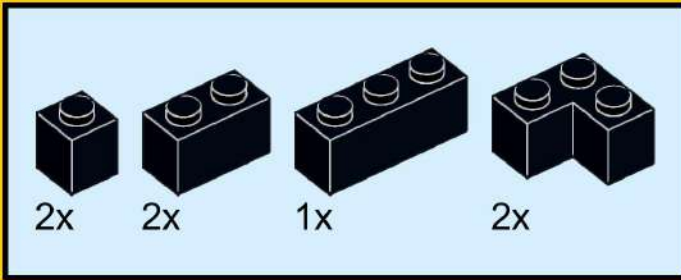

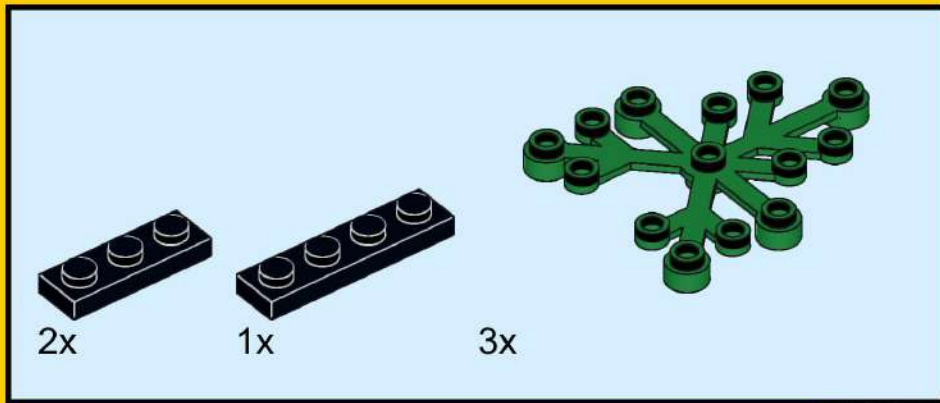



# 125

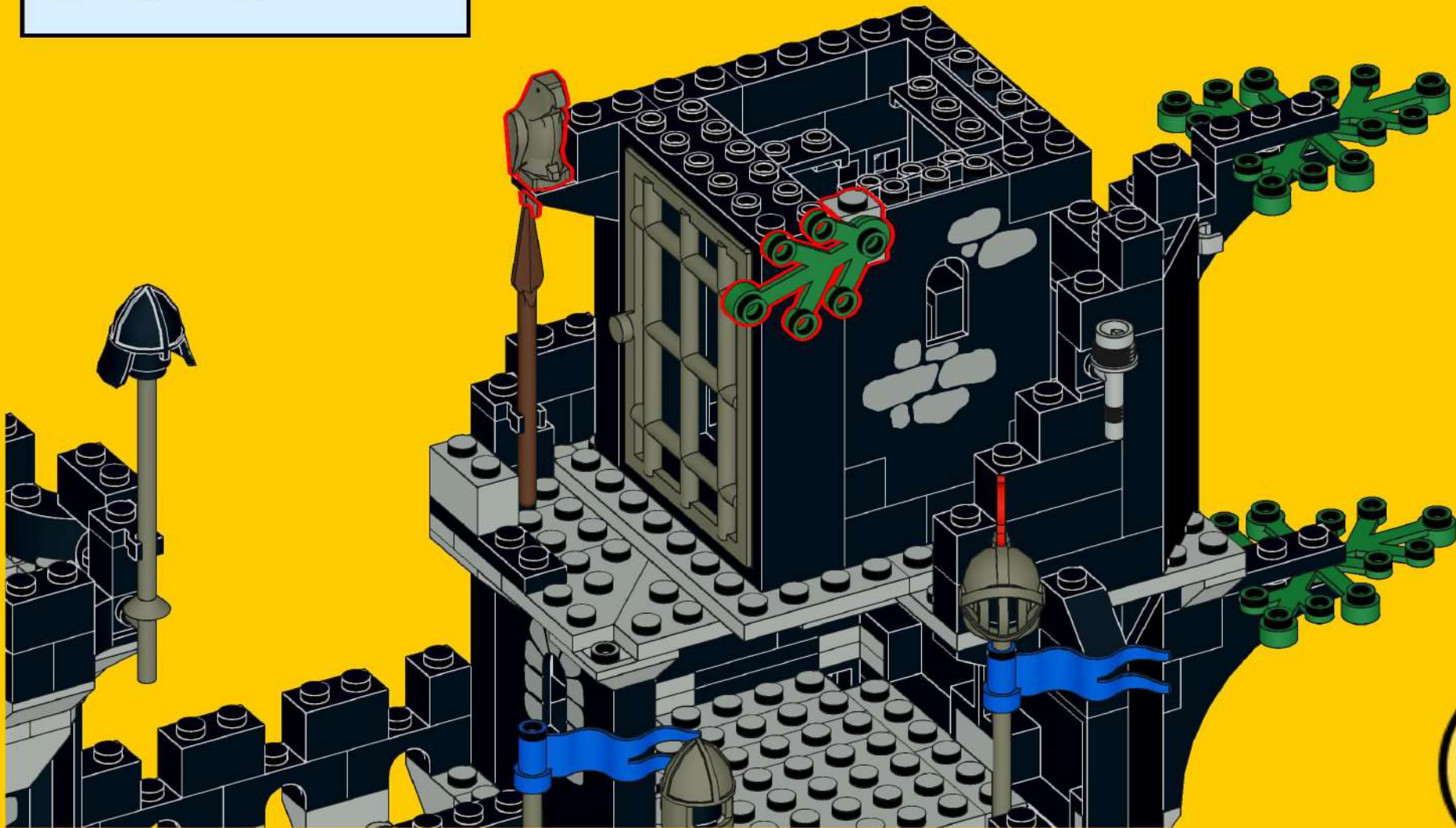
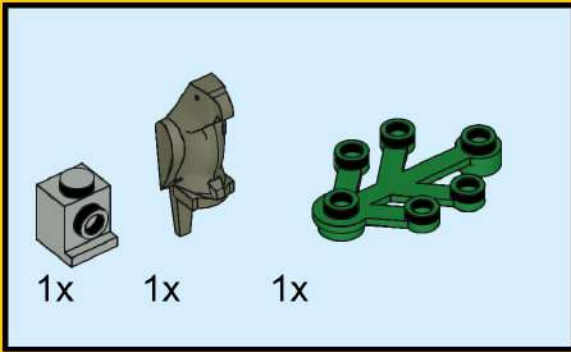

# 126

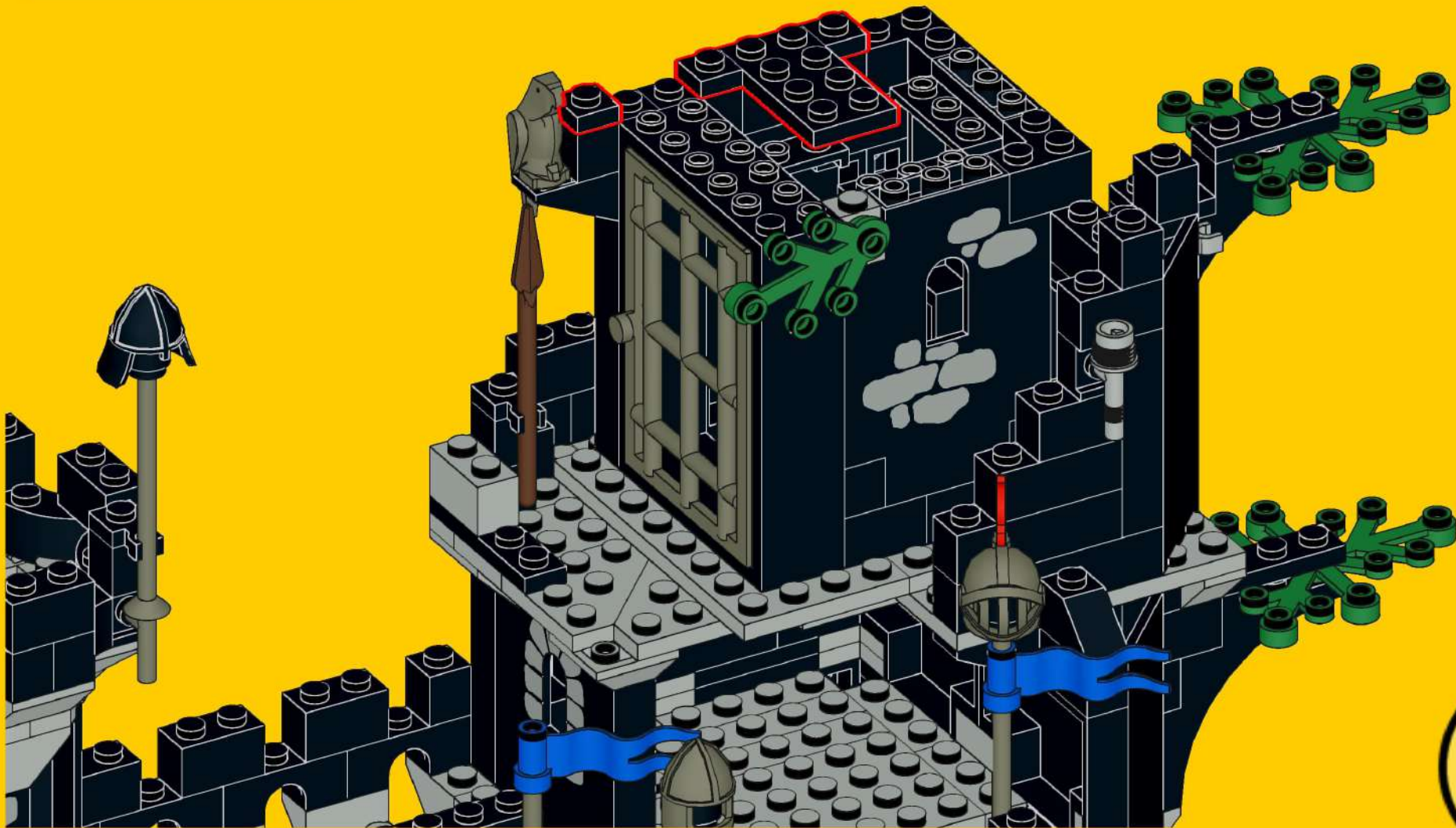
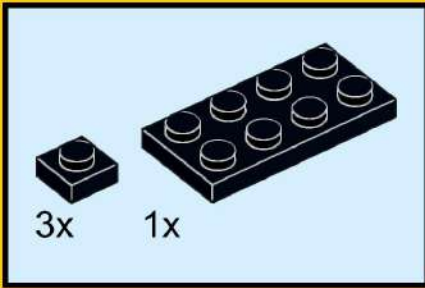

# 127

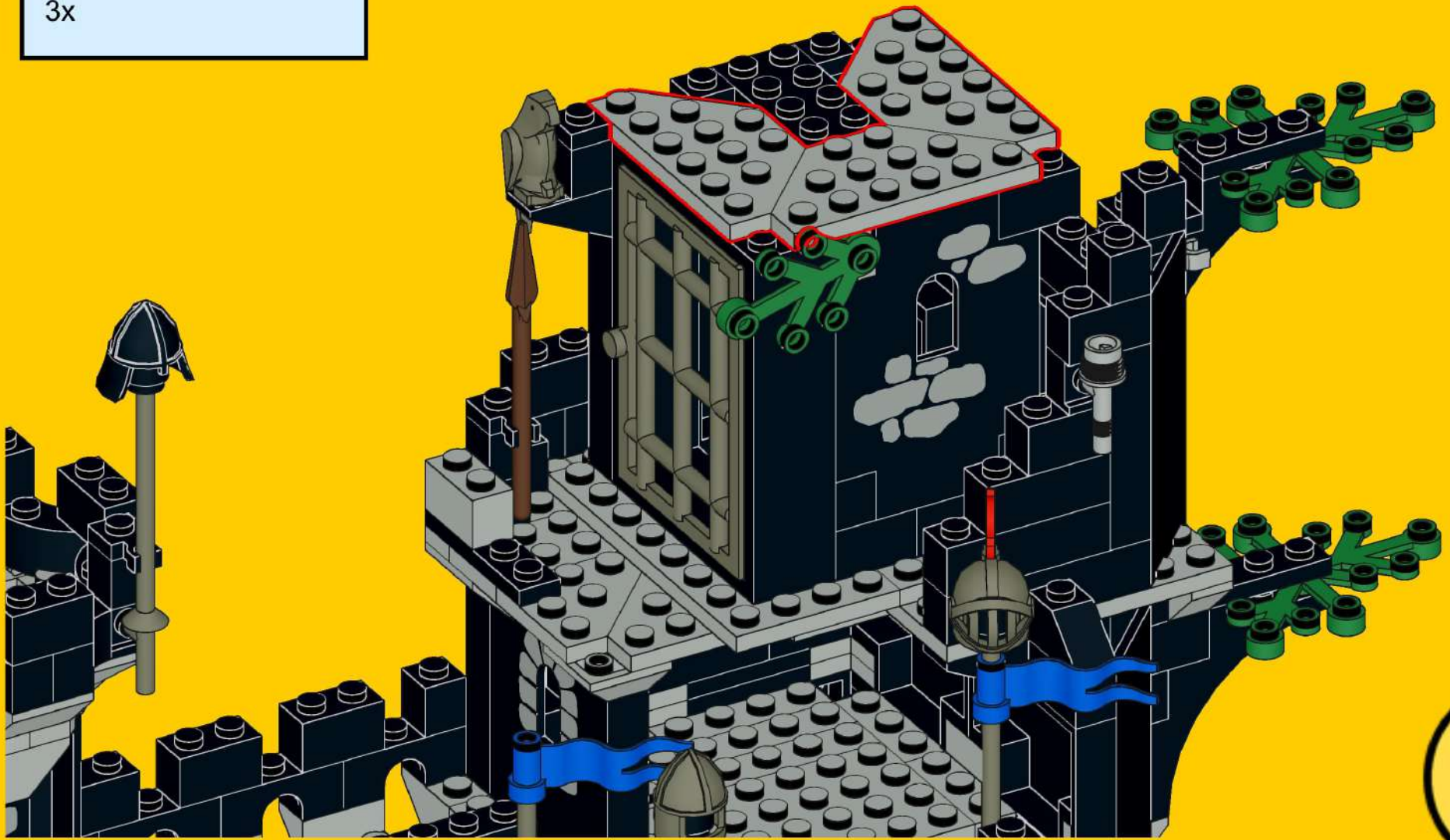
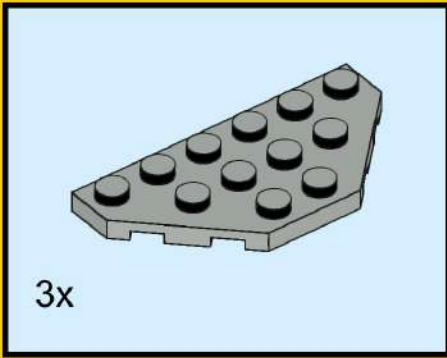

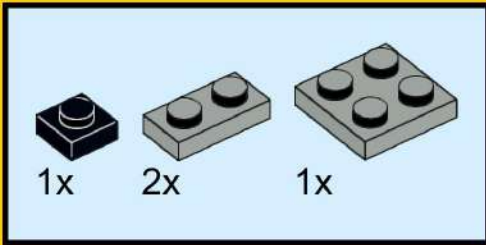

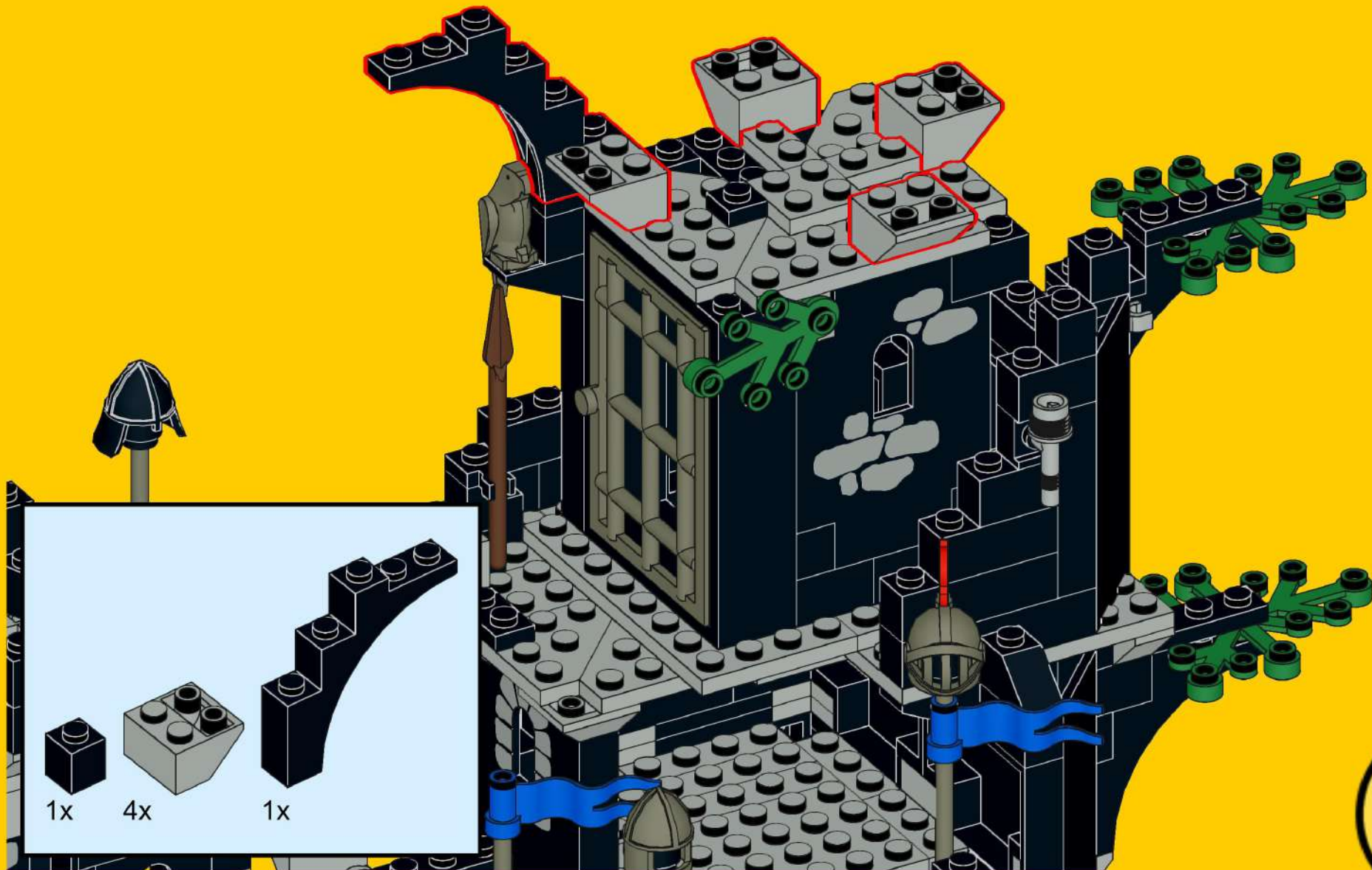

# 130

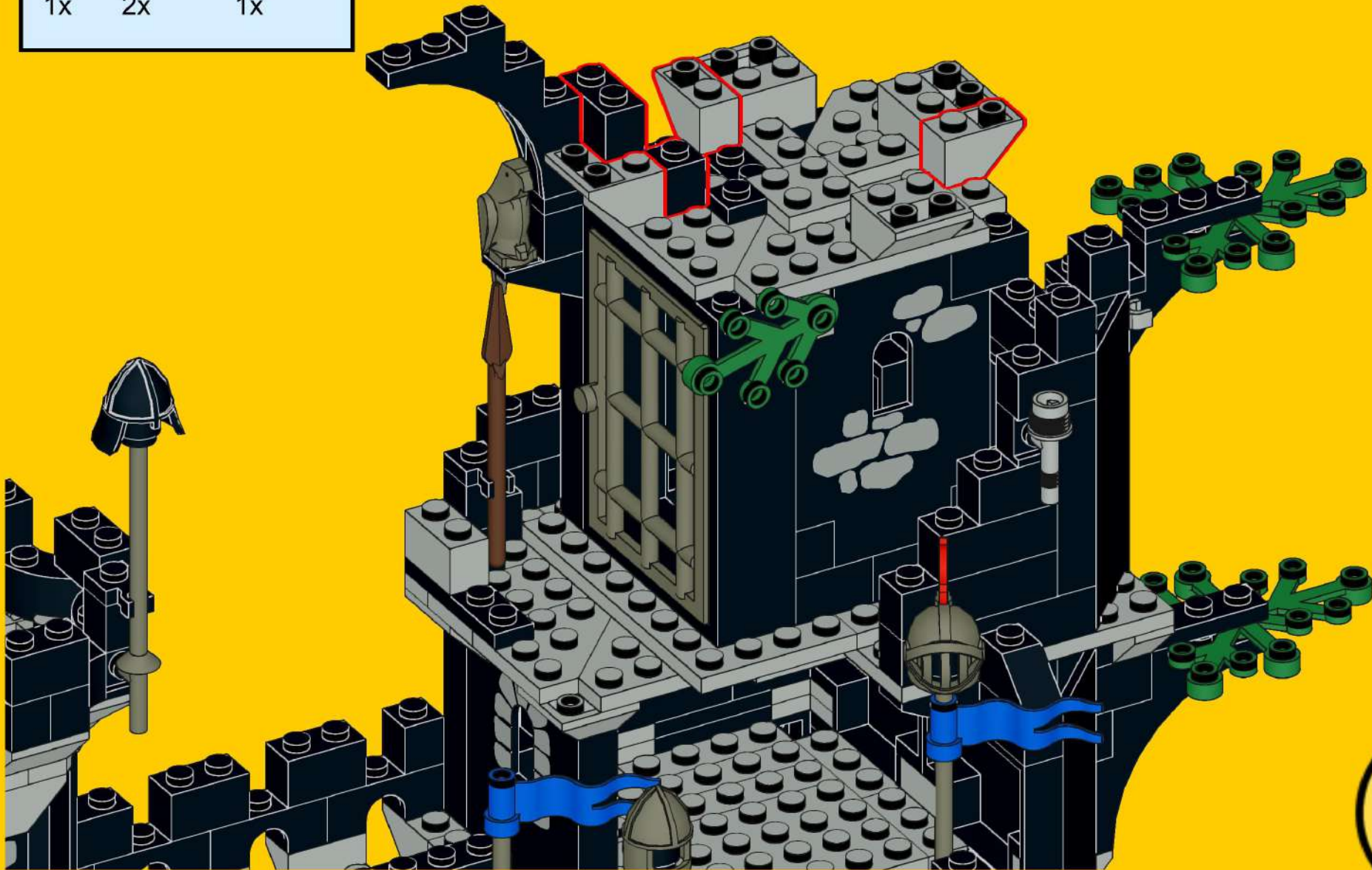
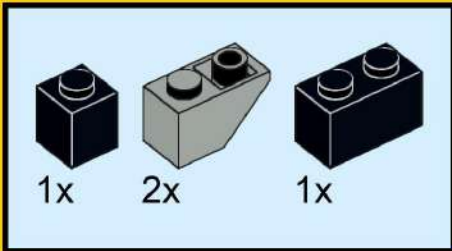

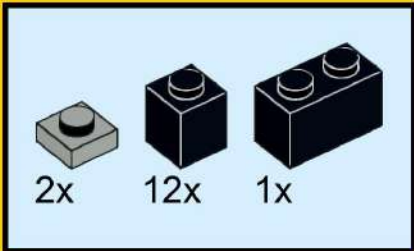

# 131

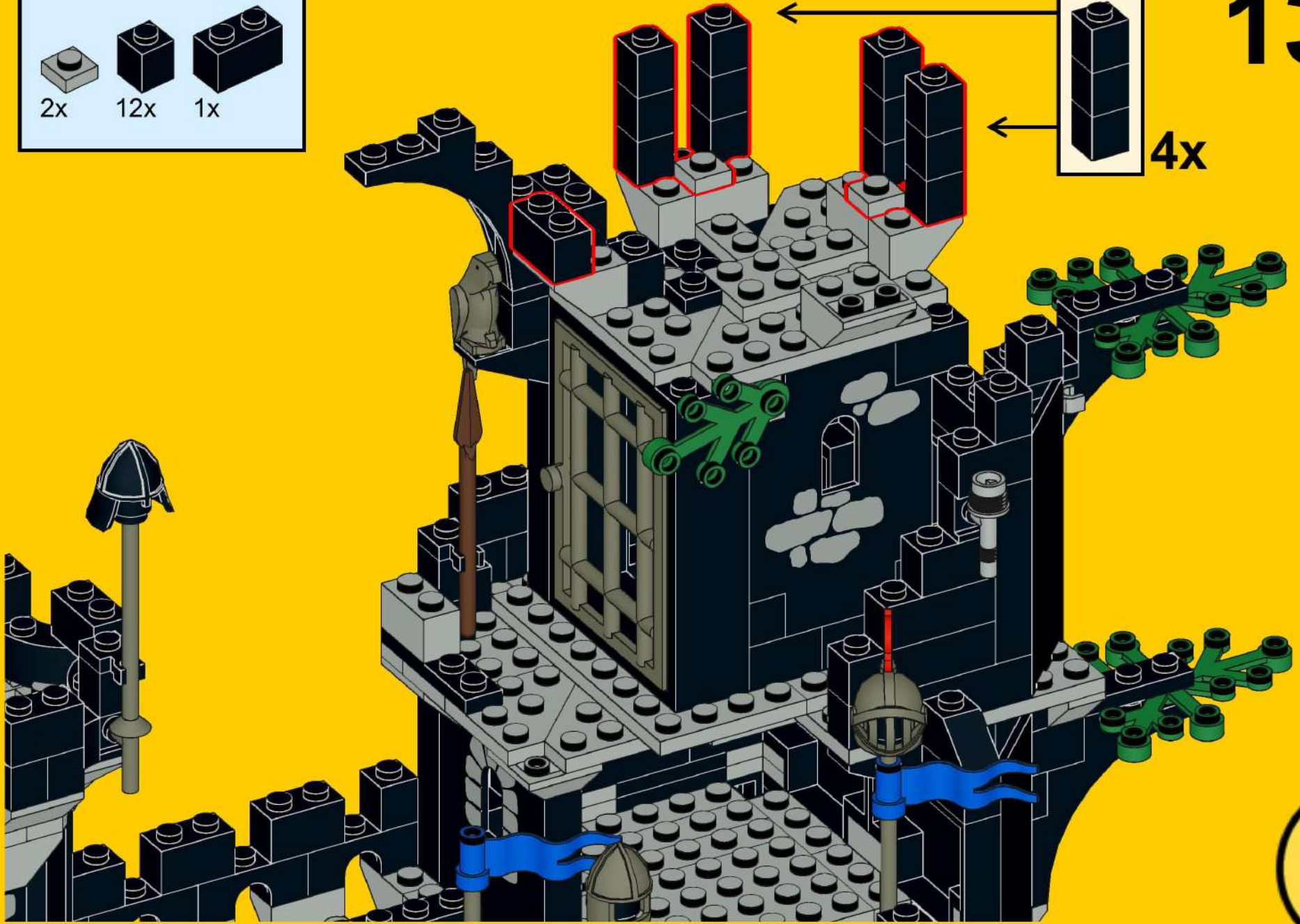
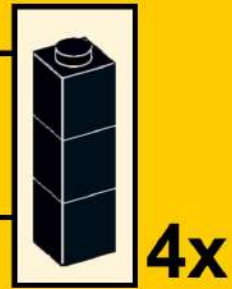

# 132

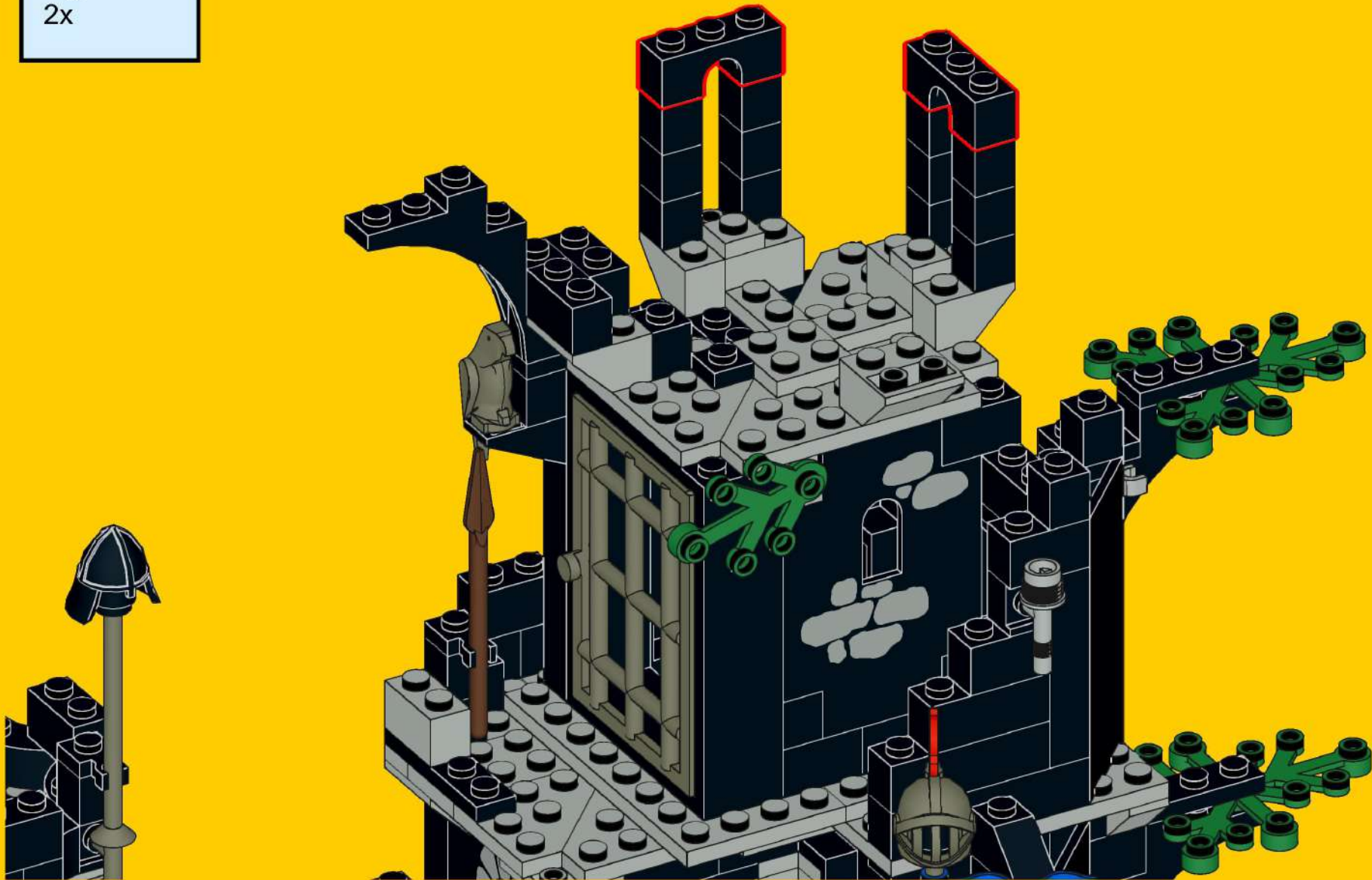
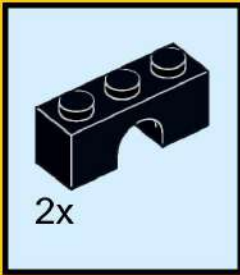



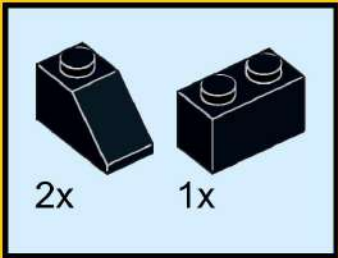

133

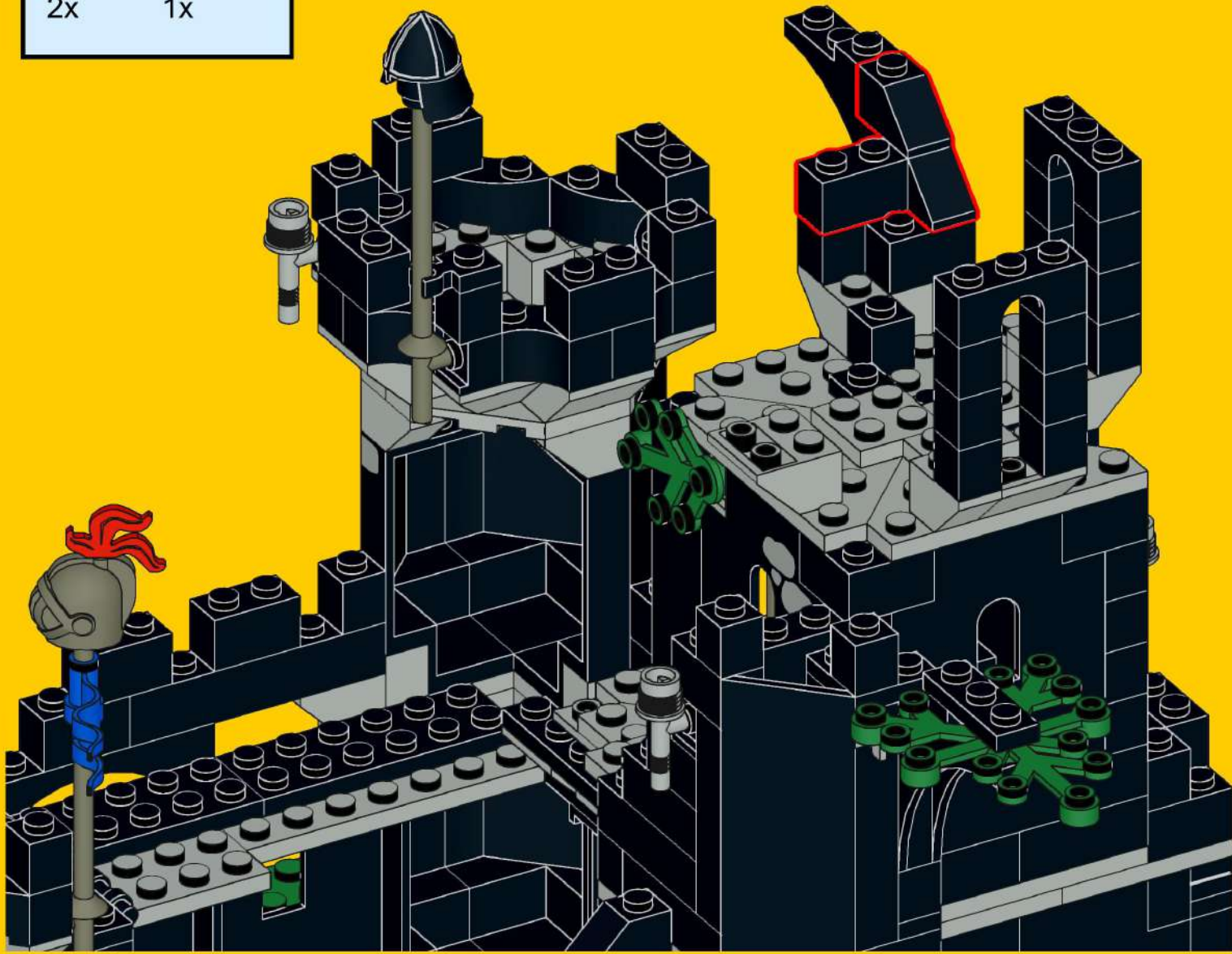

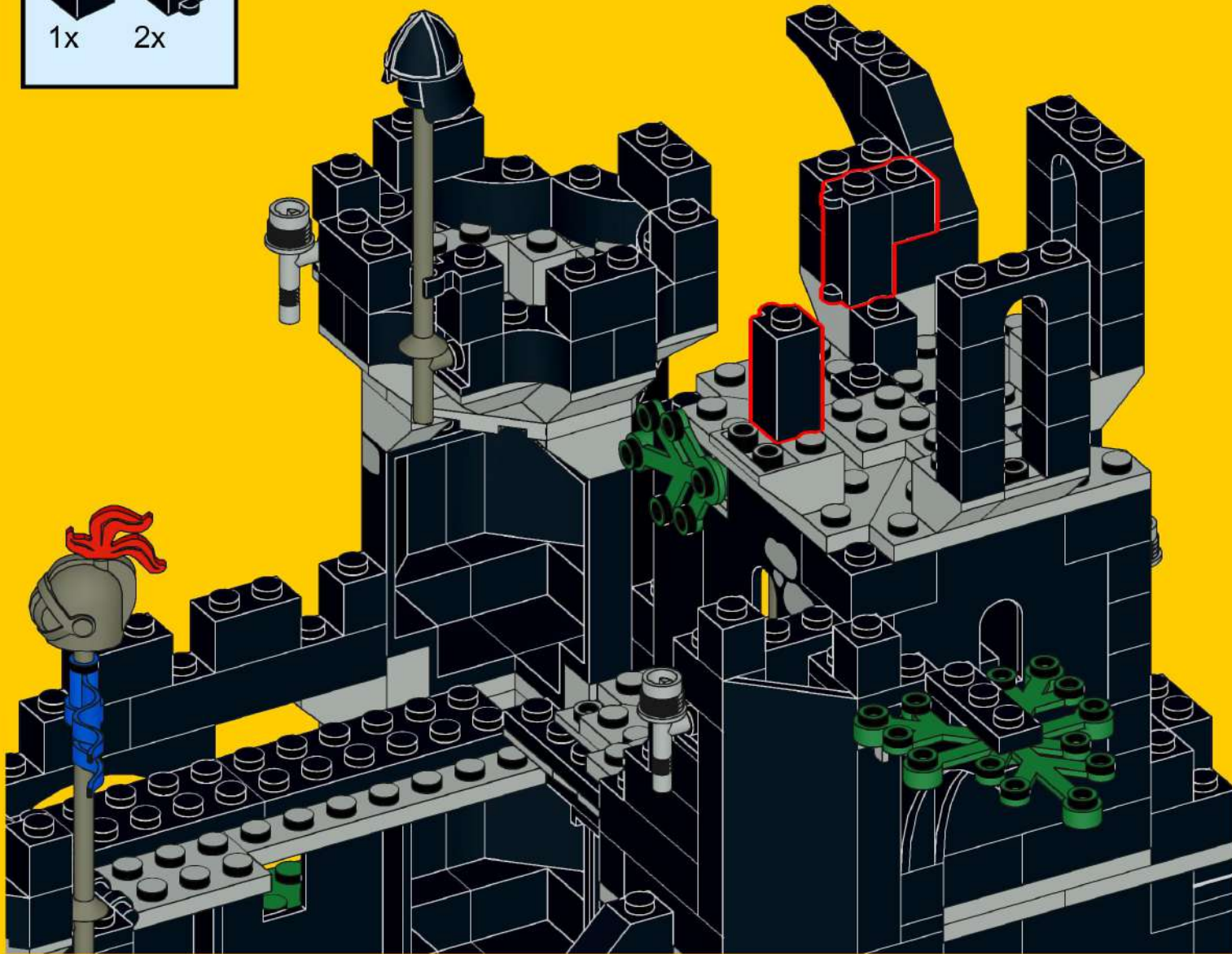
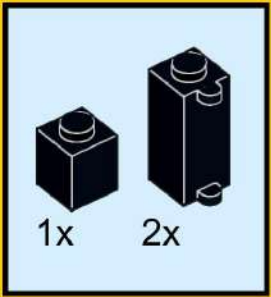

# 135

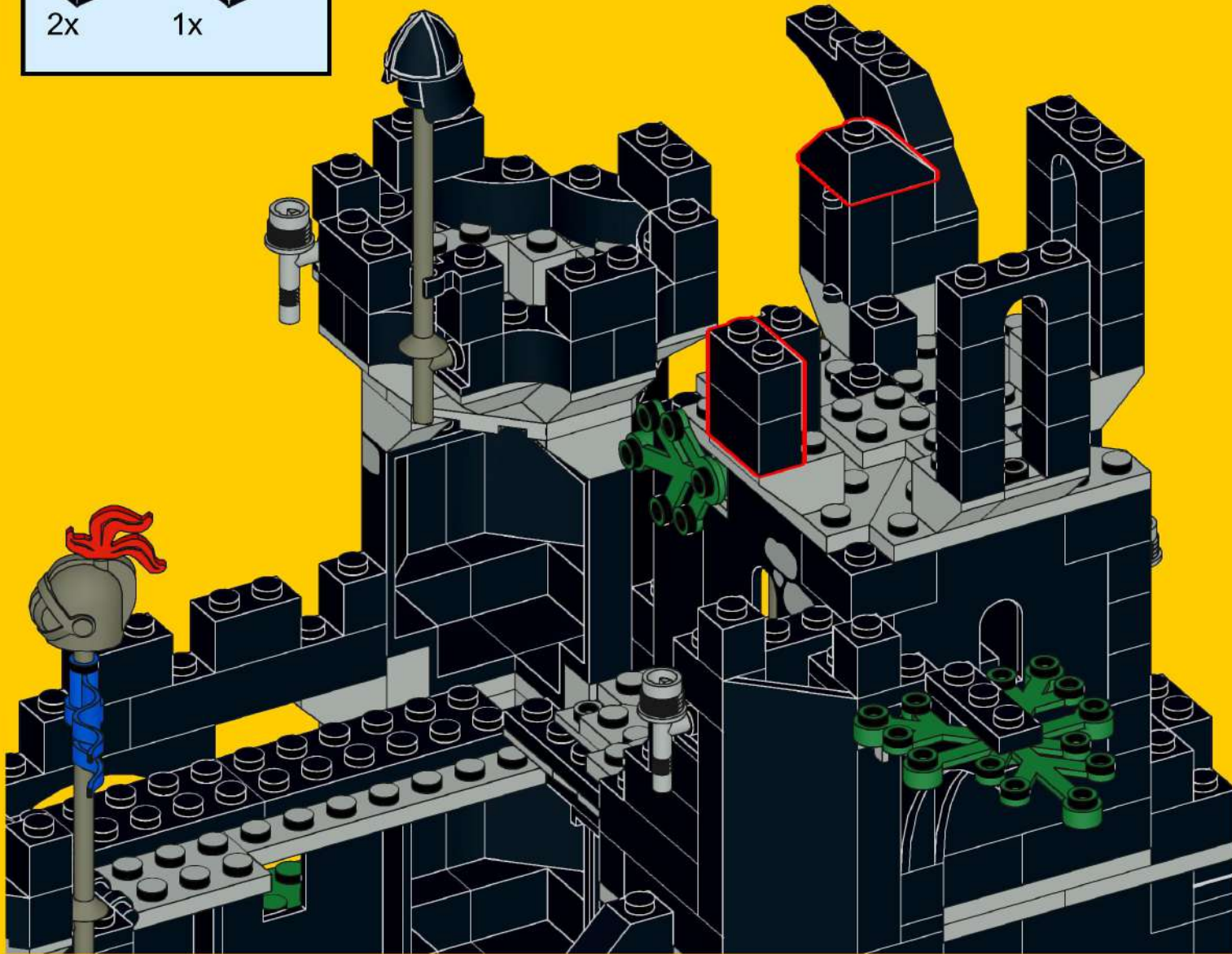
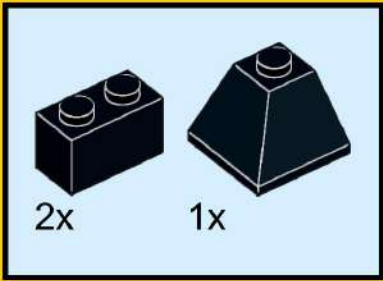

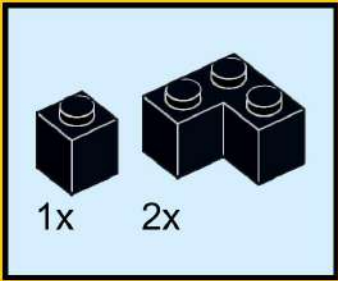

137

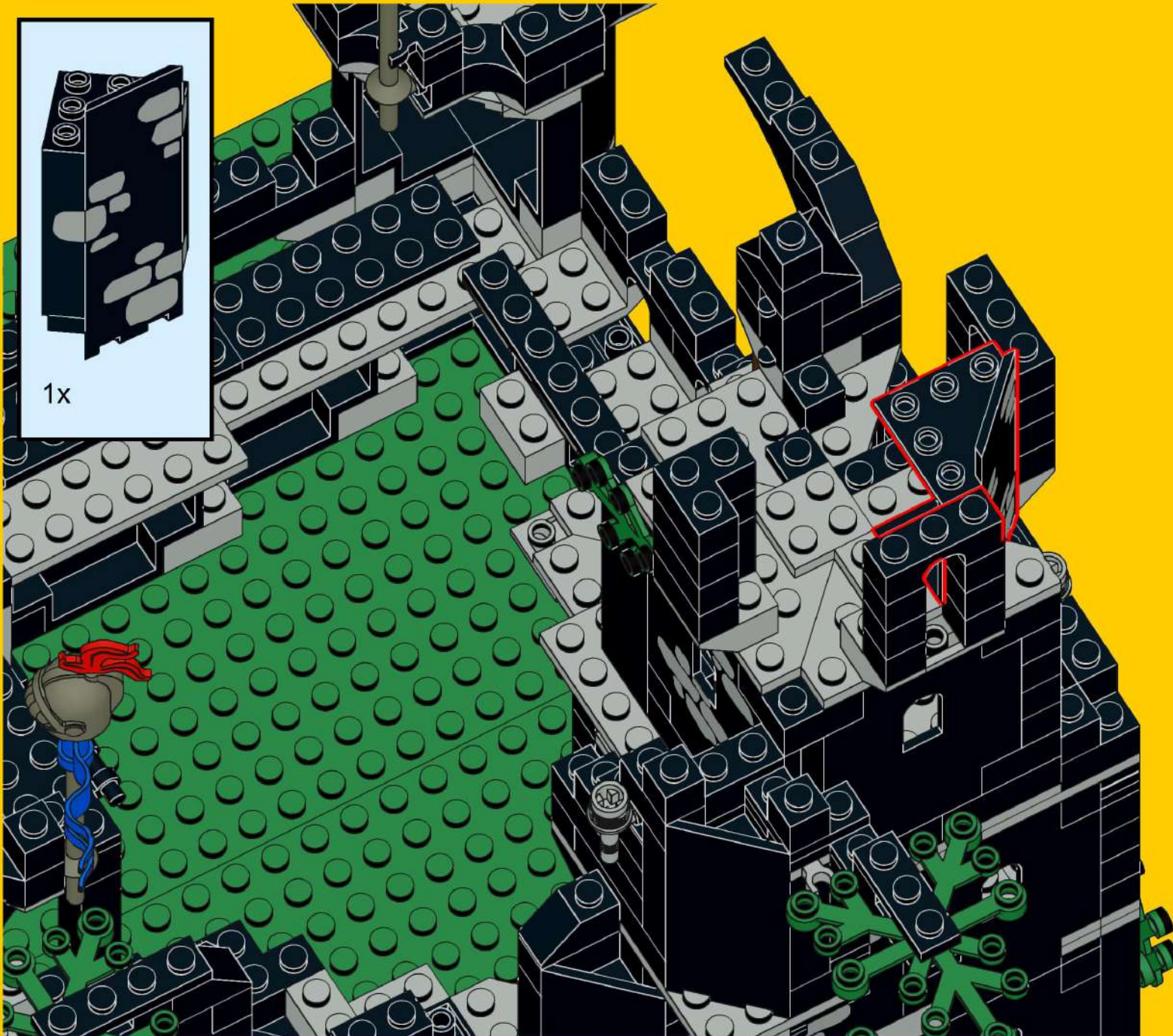

# 138

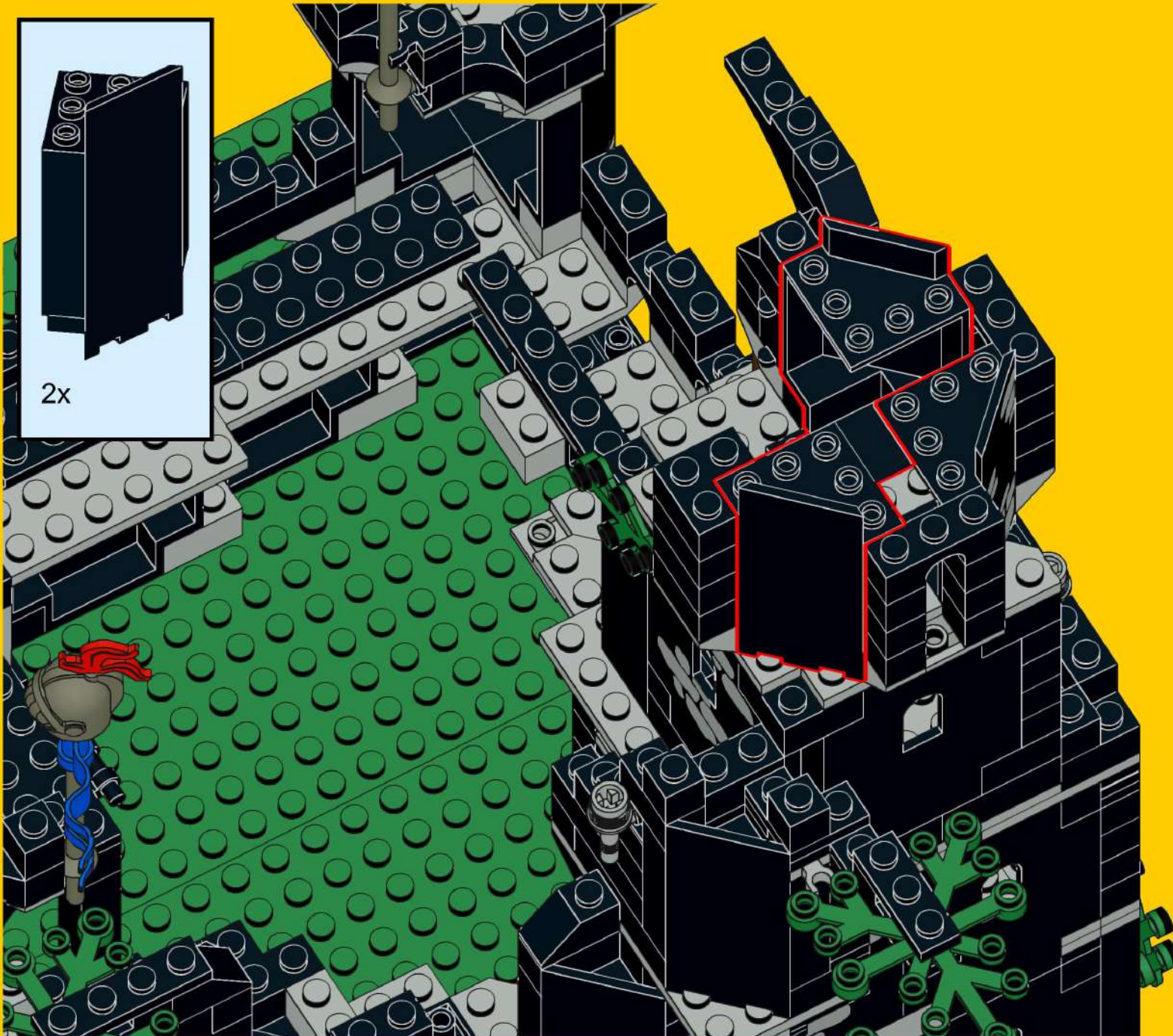

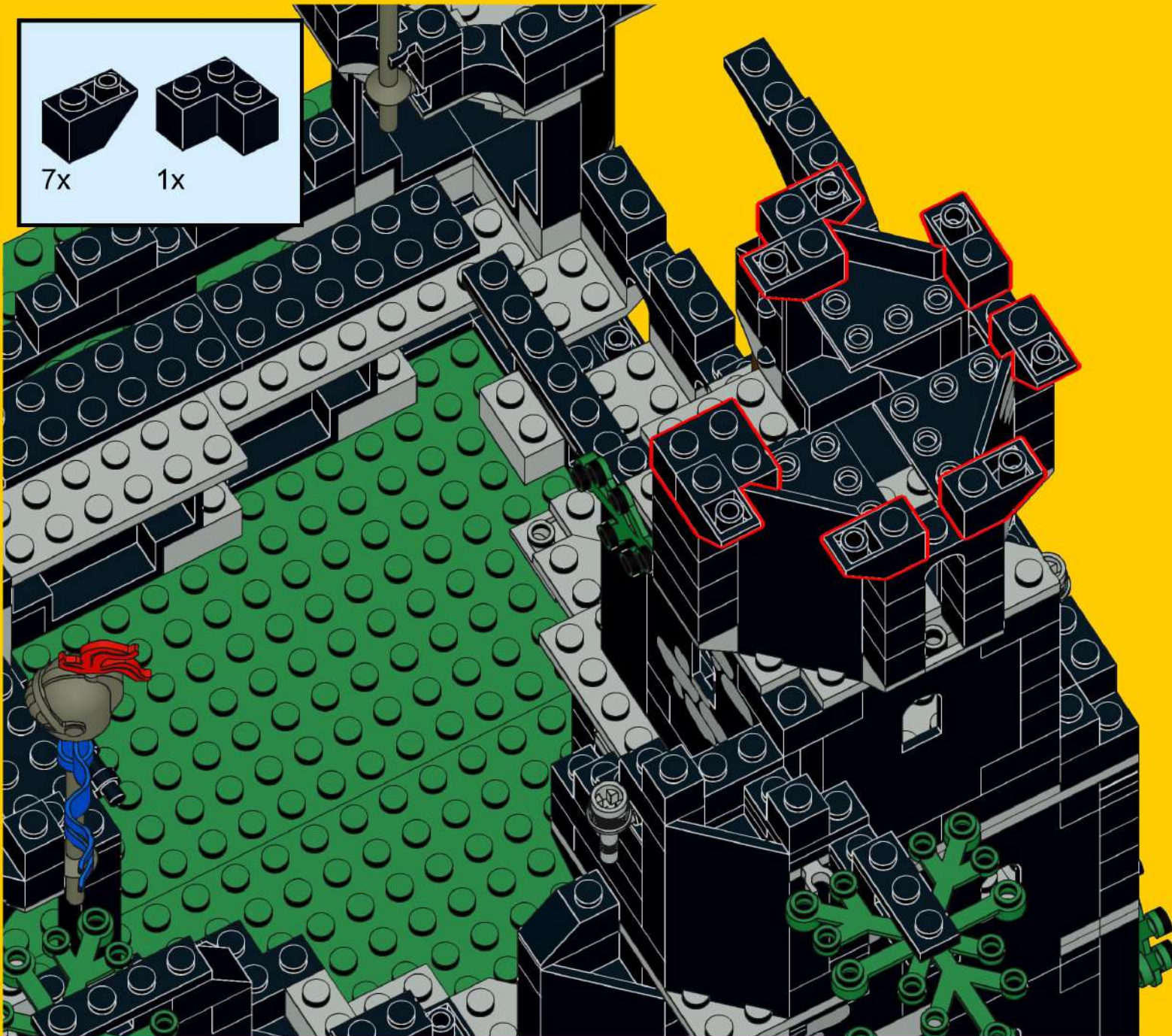
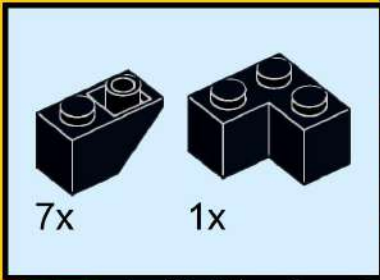

# 140

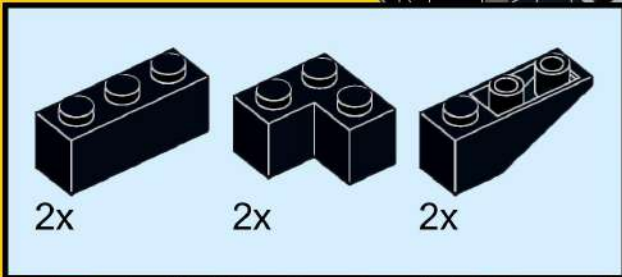
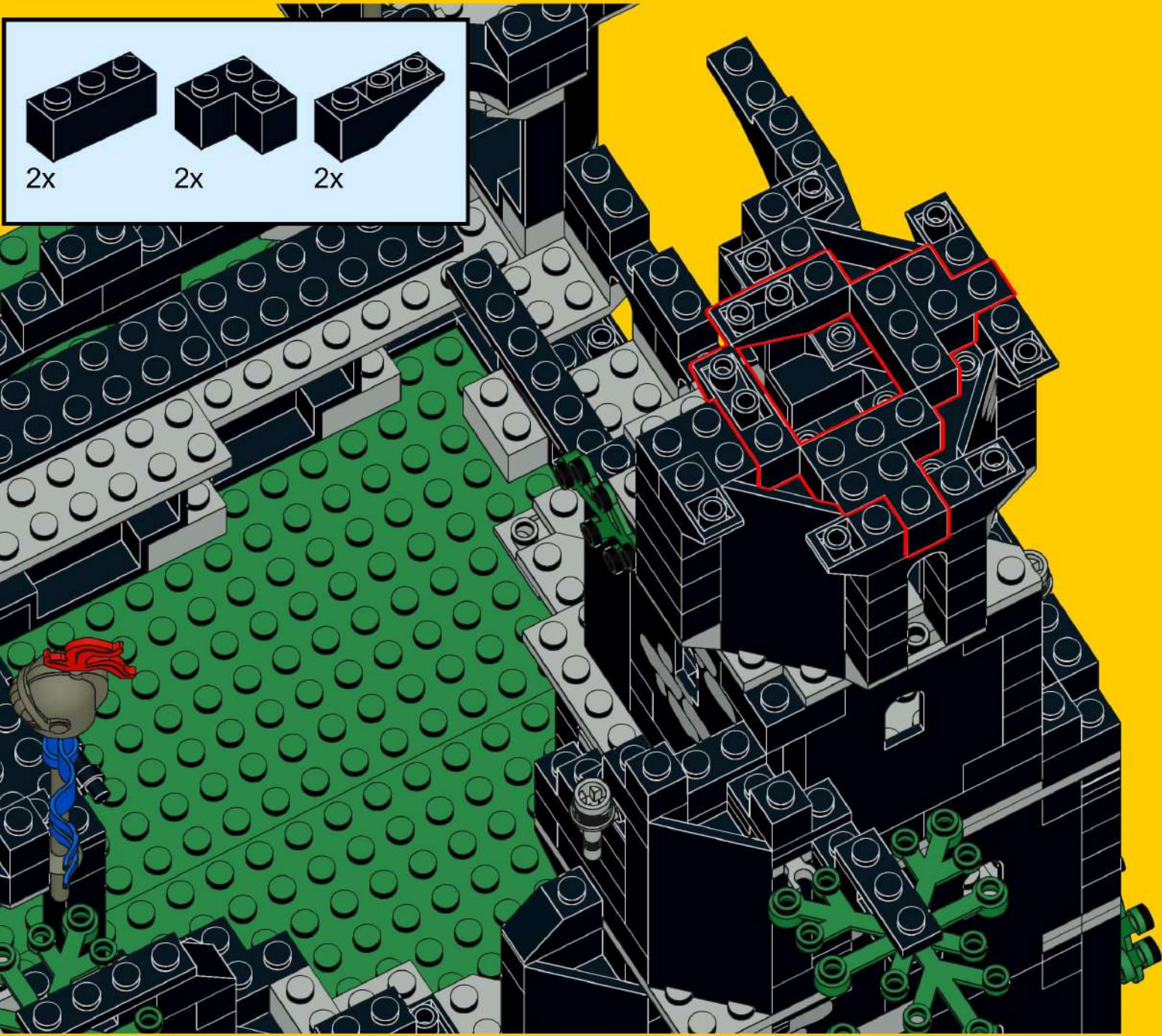



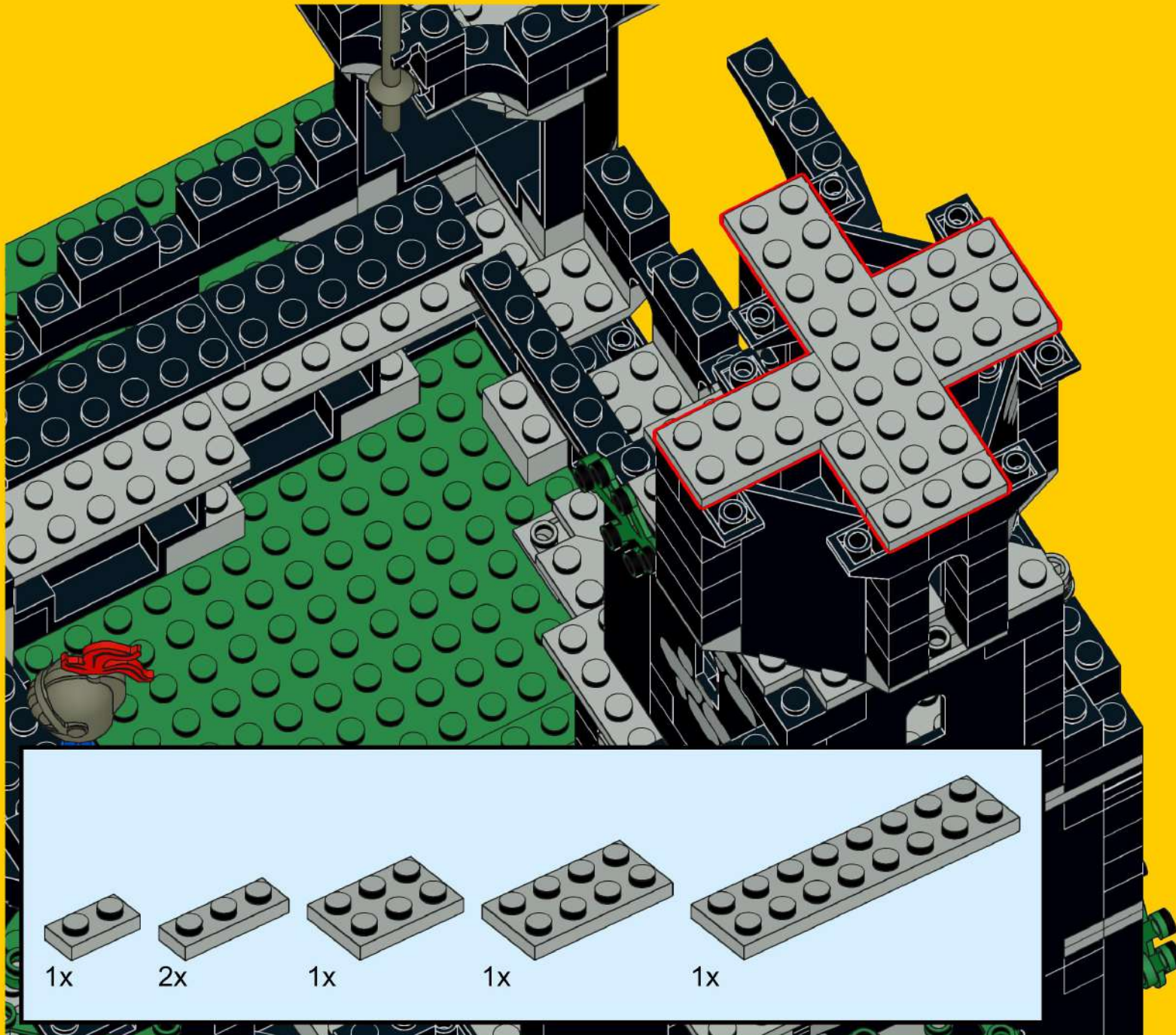

# 142

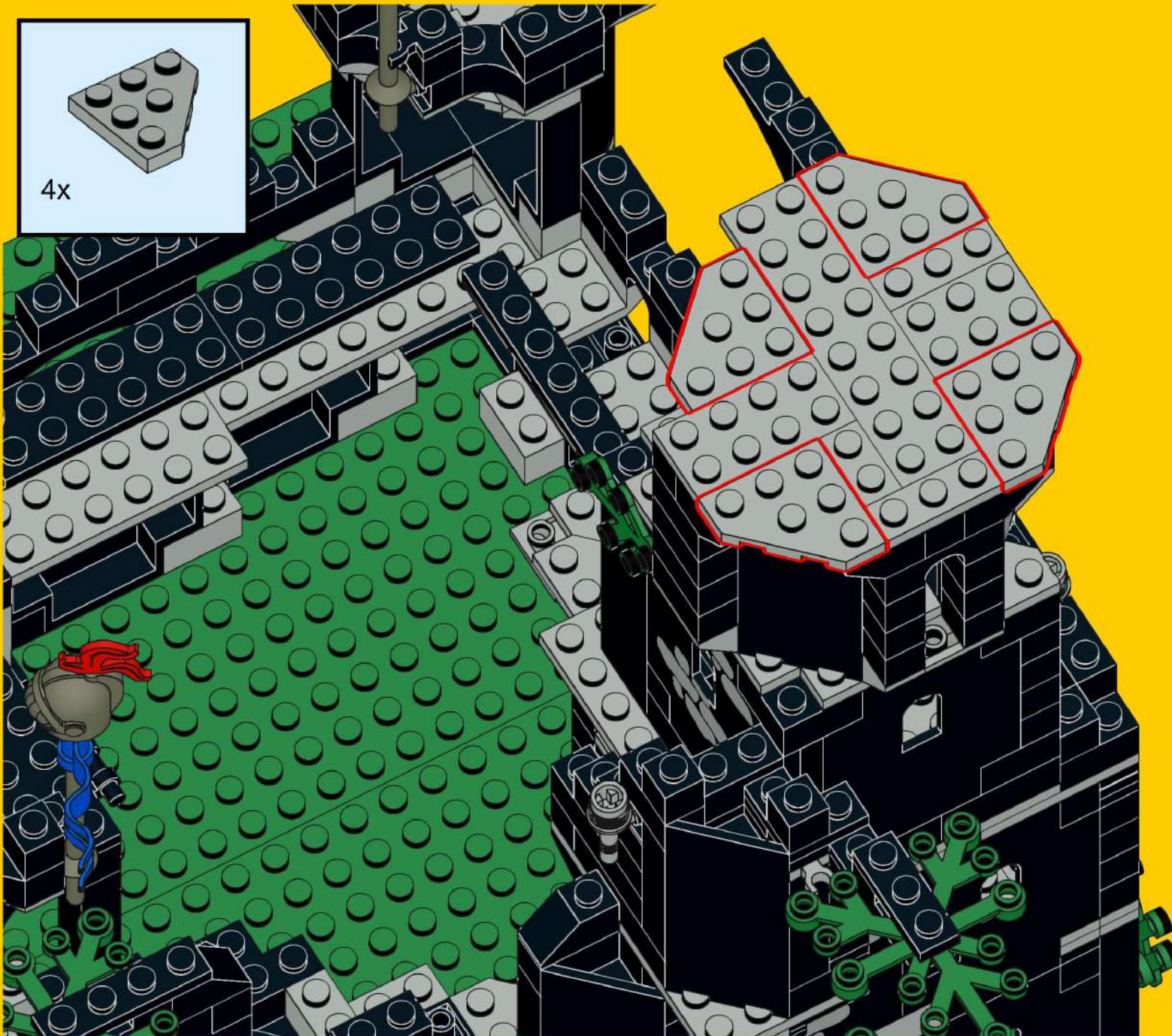
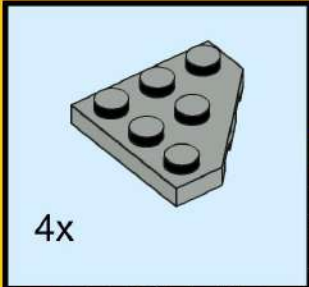

# 143

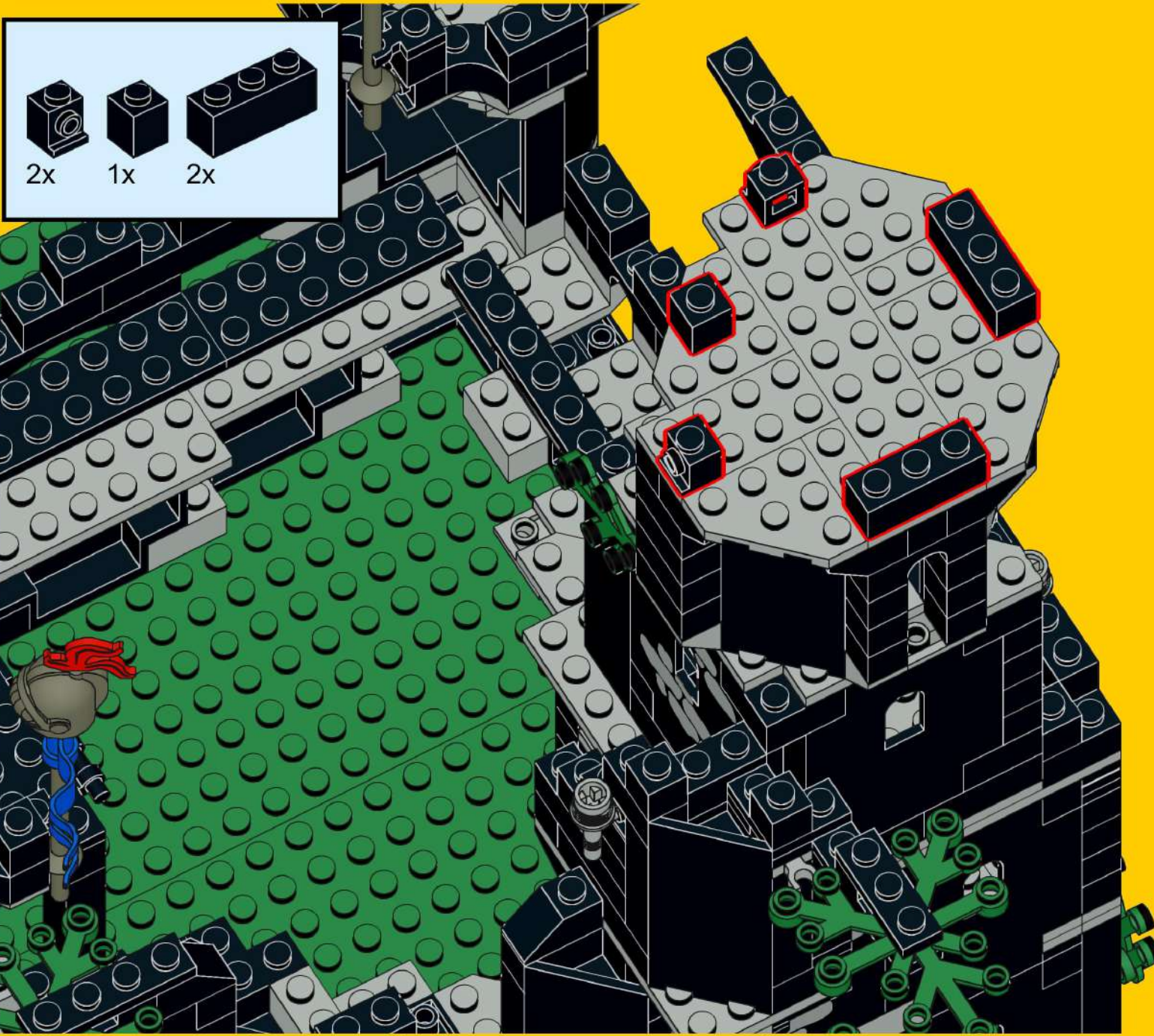

# 144

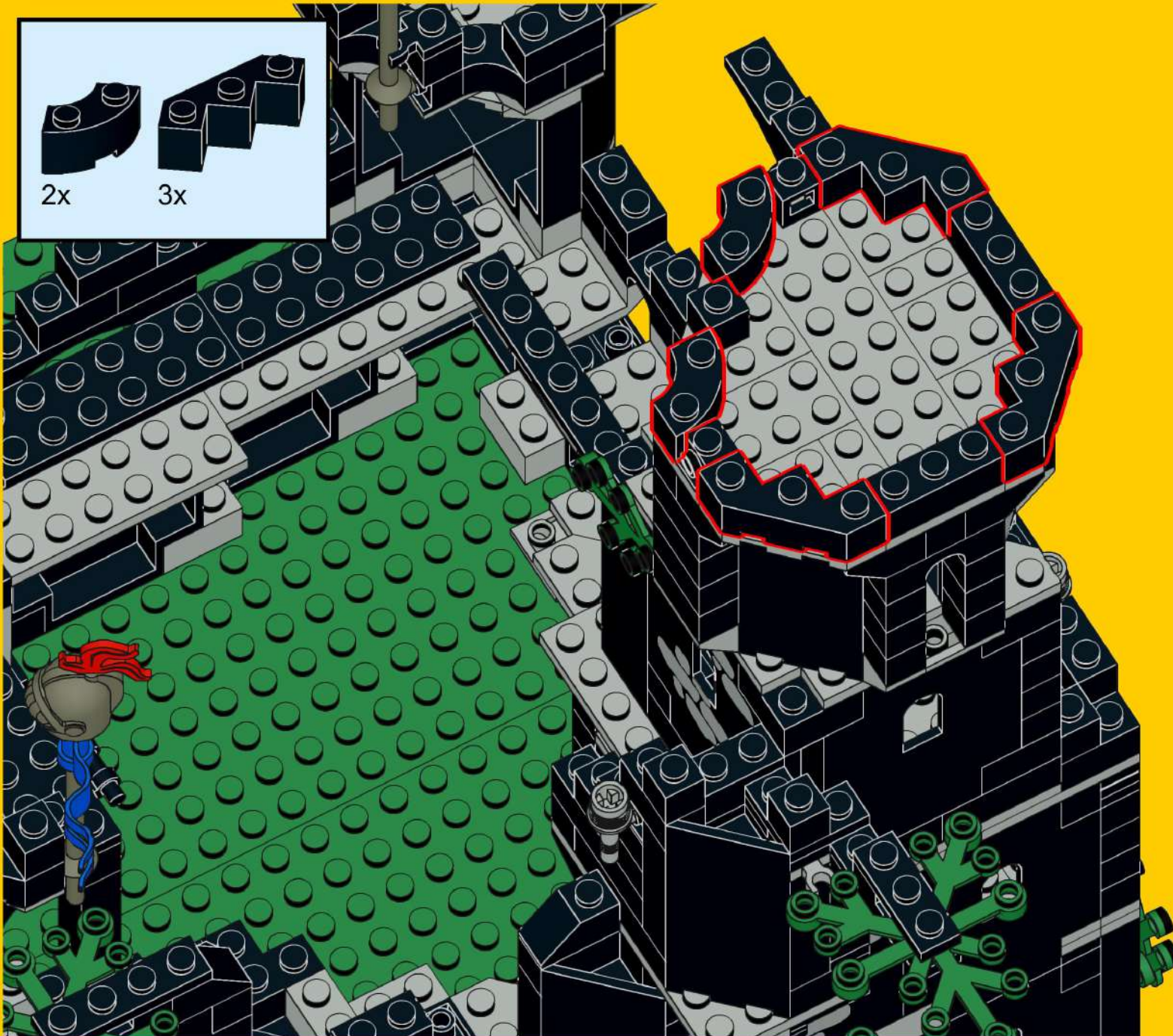
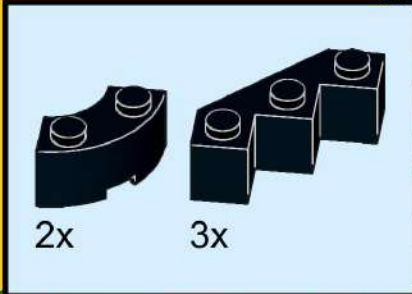

# 145

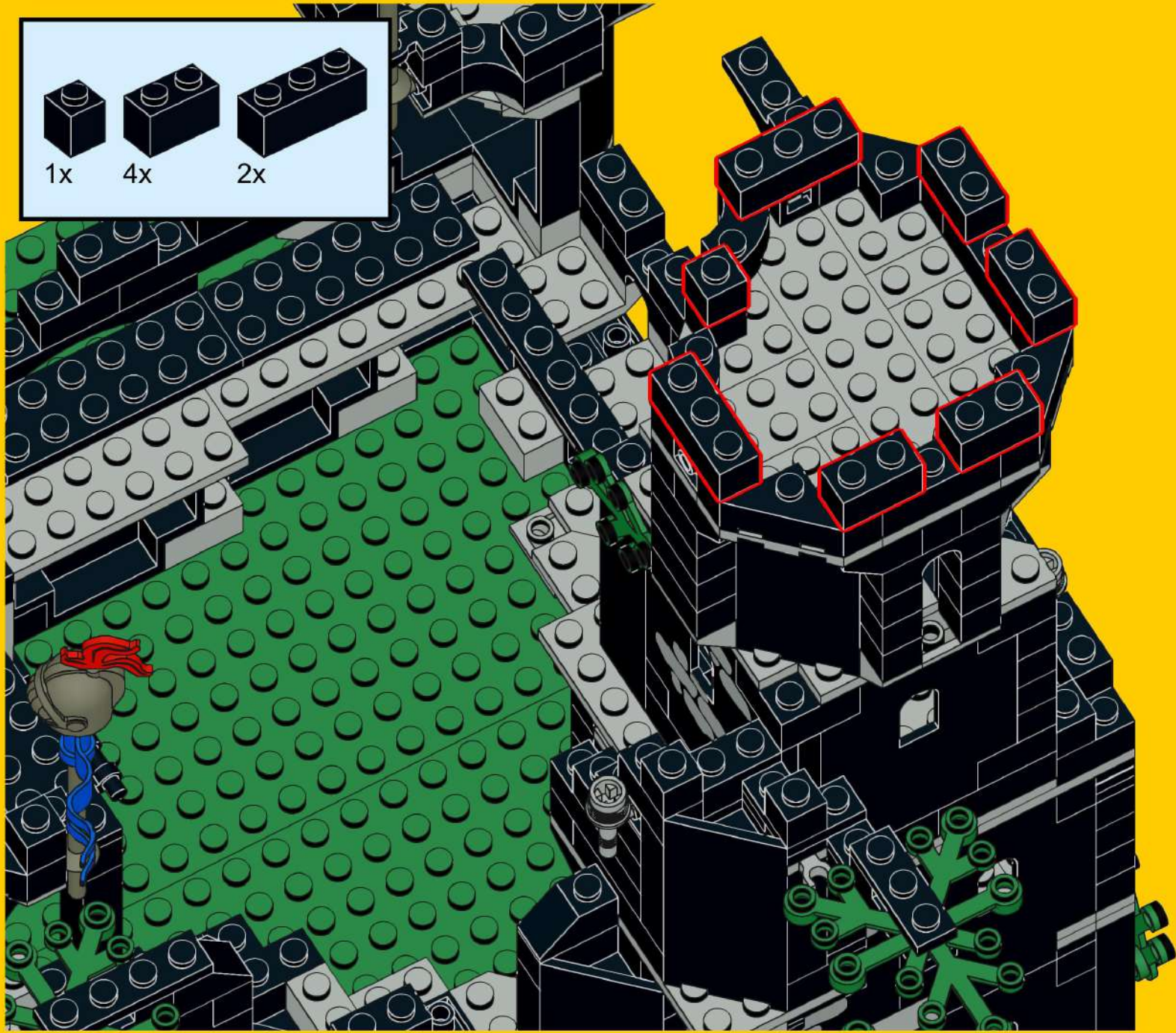
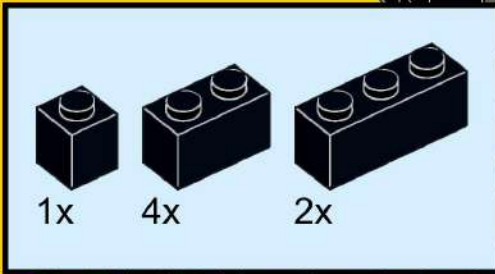

# 146

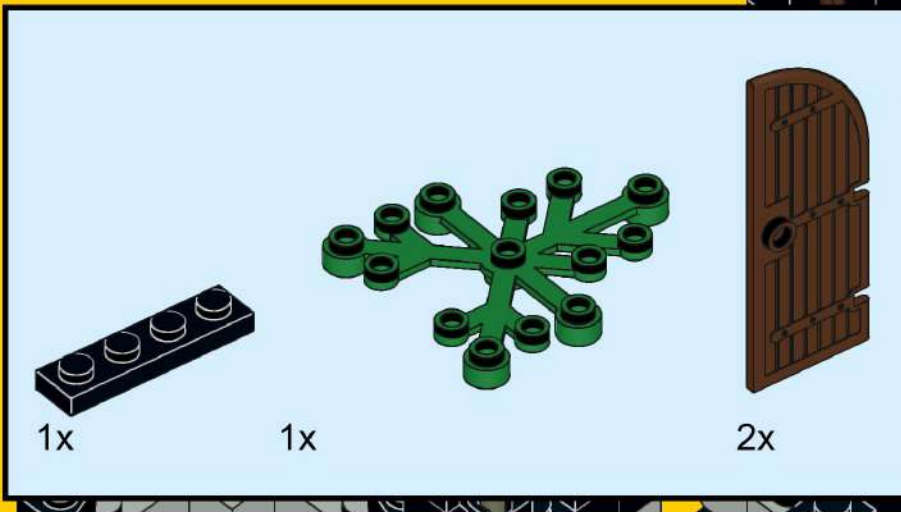
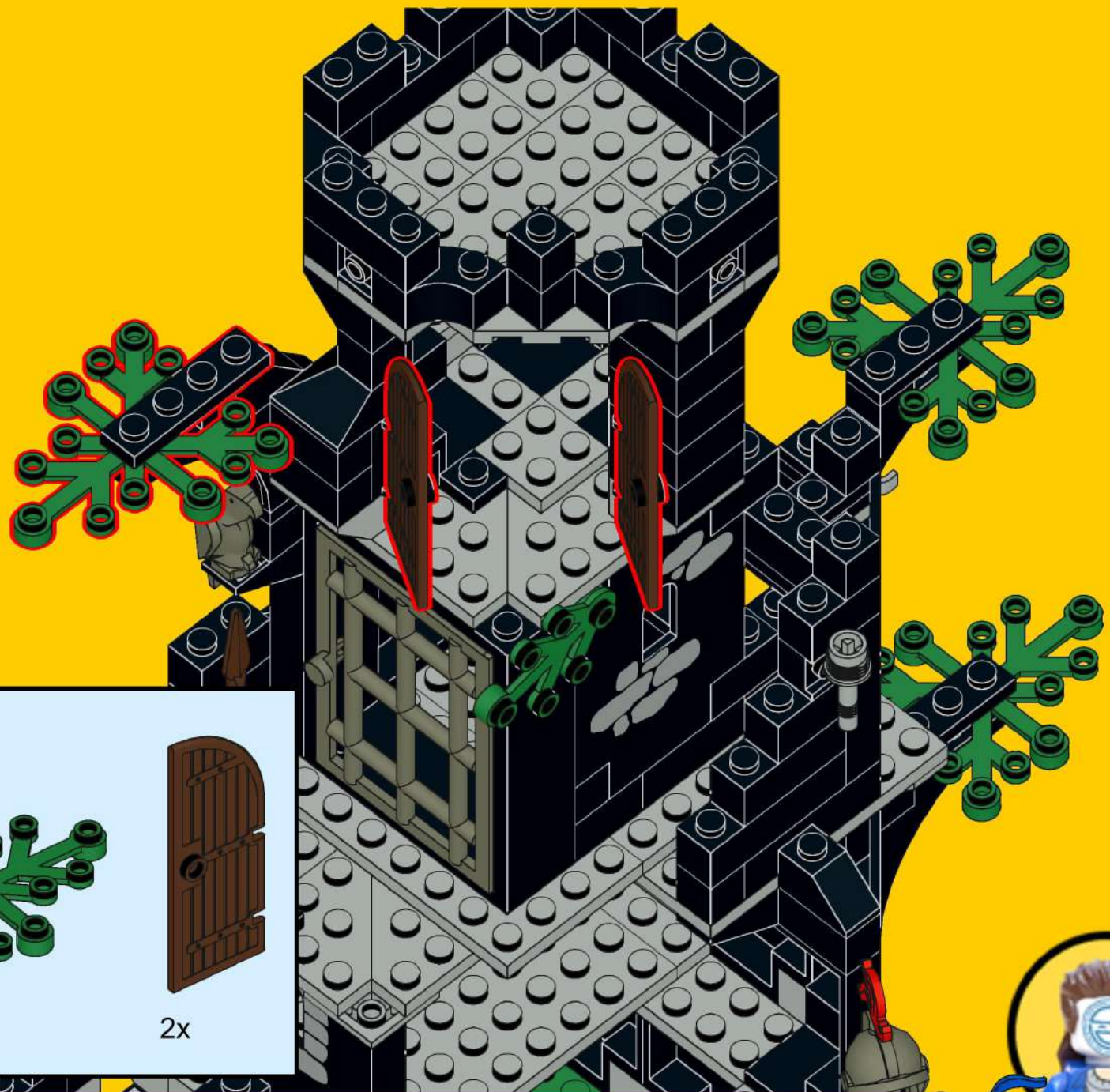

# 147

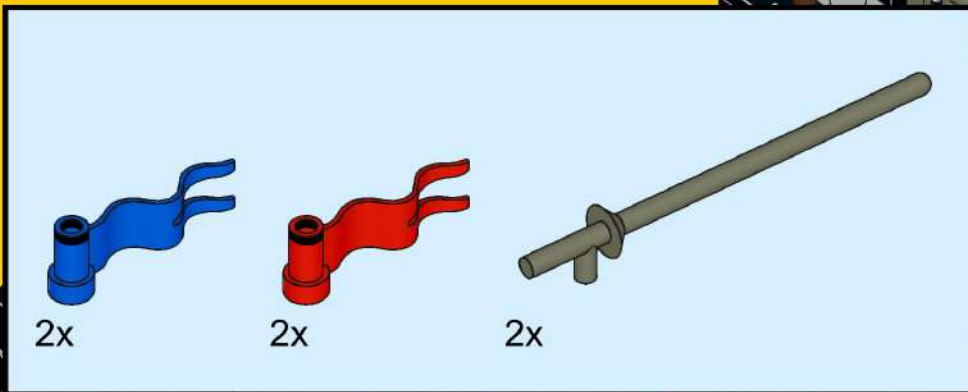
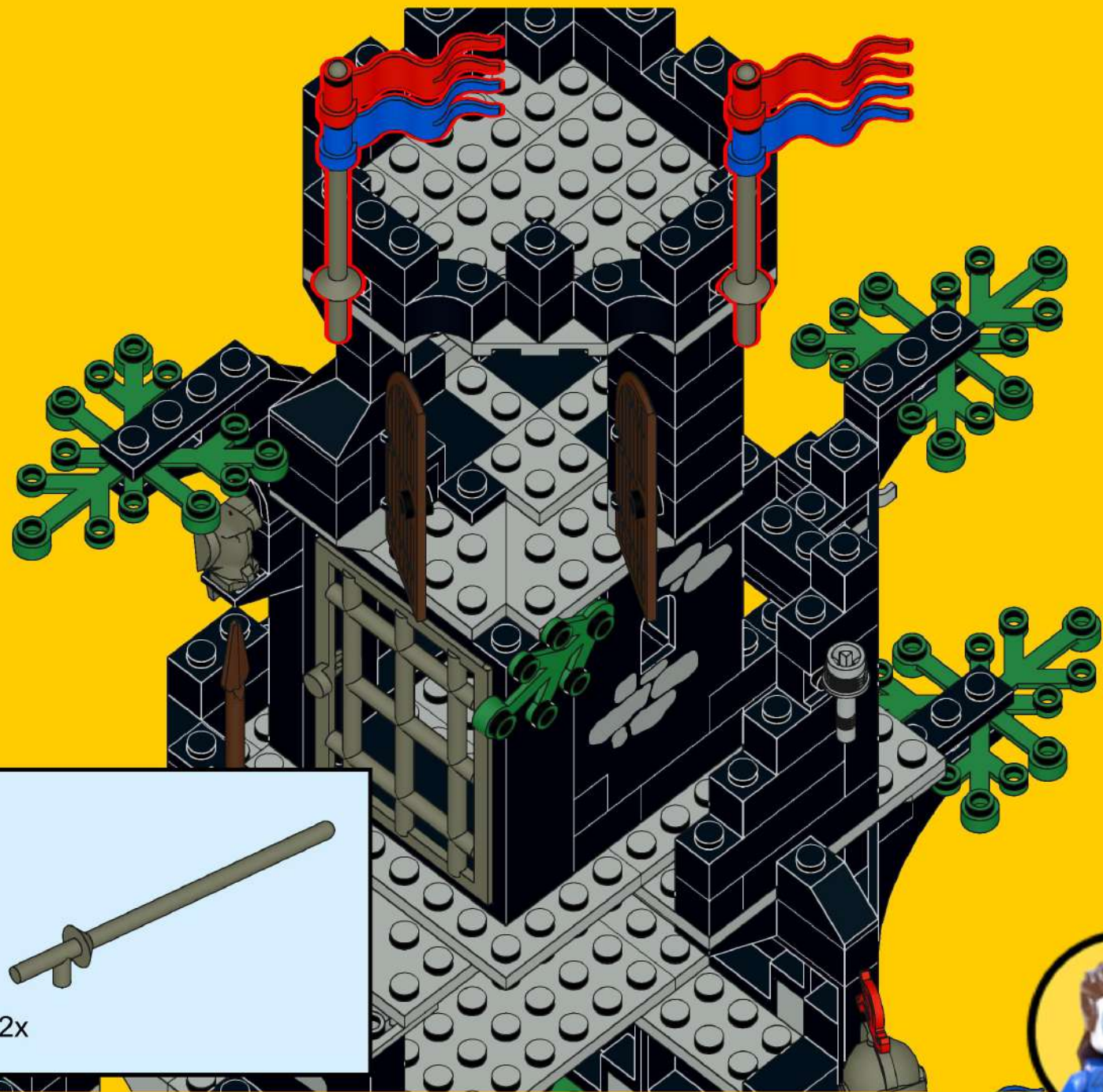

# 148

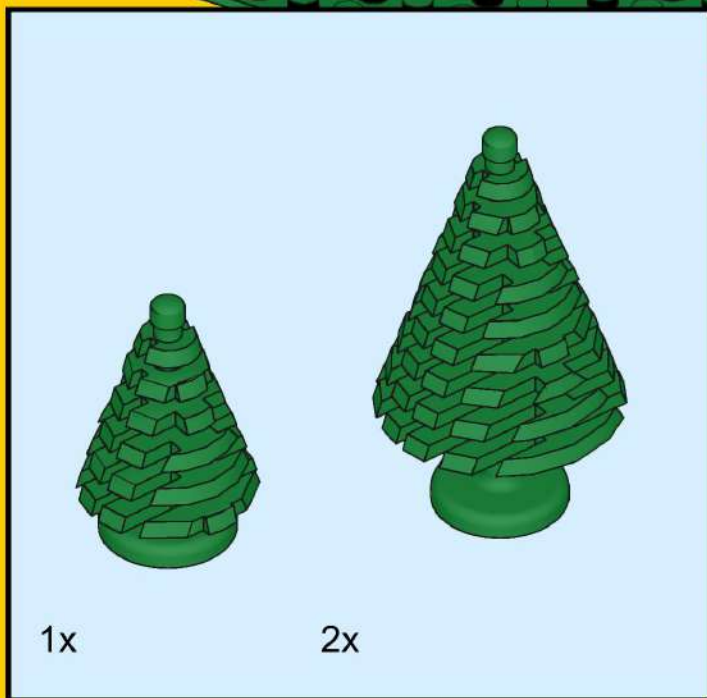
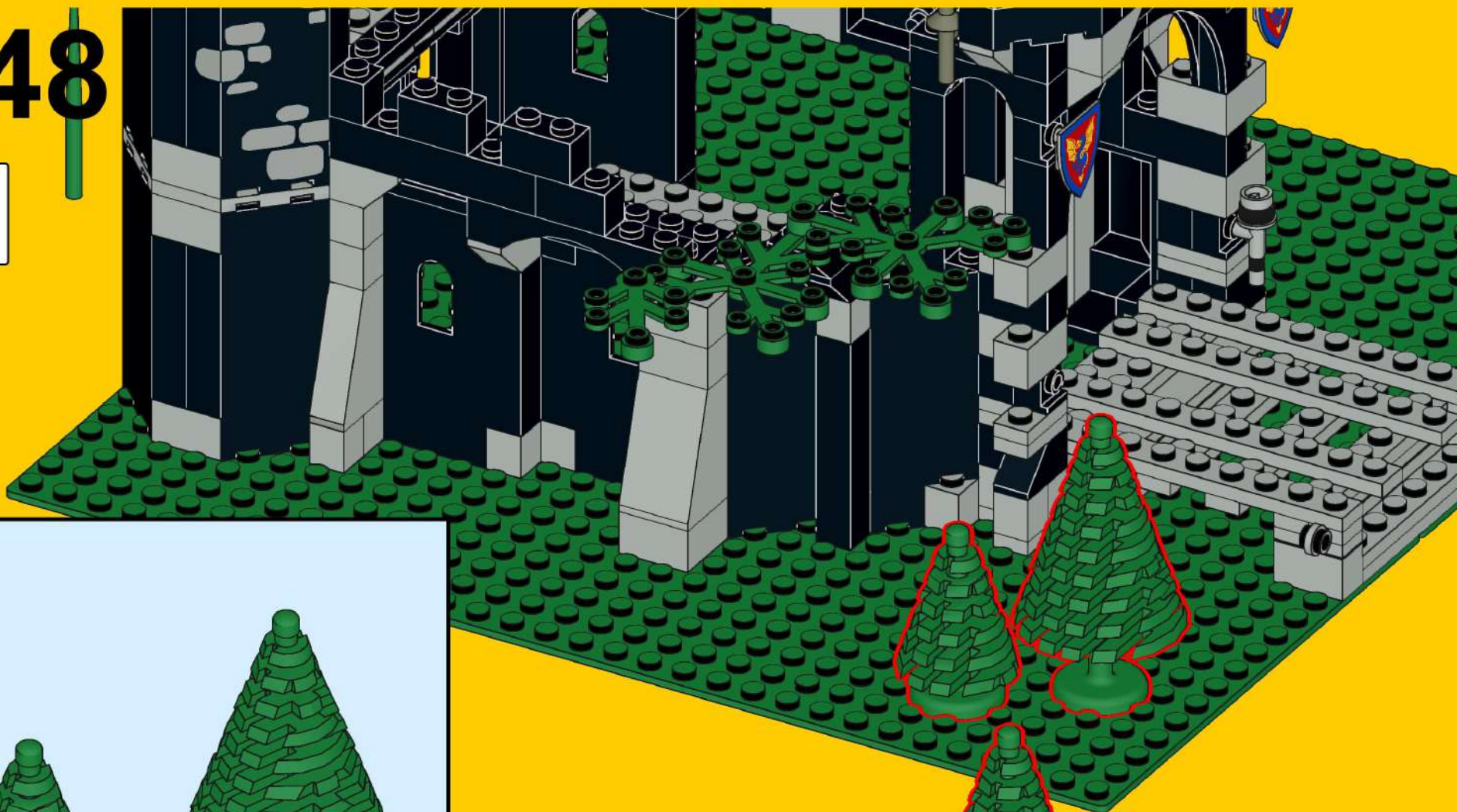



# 149

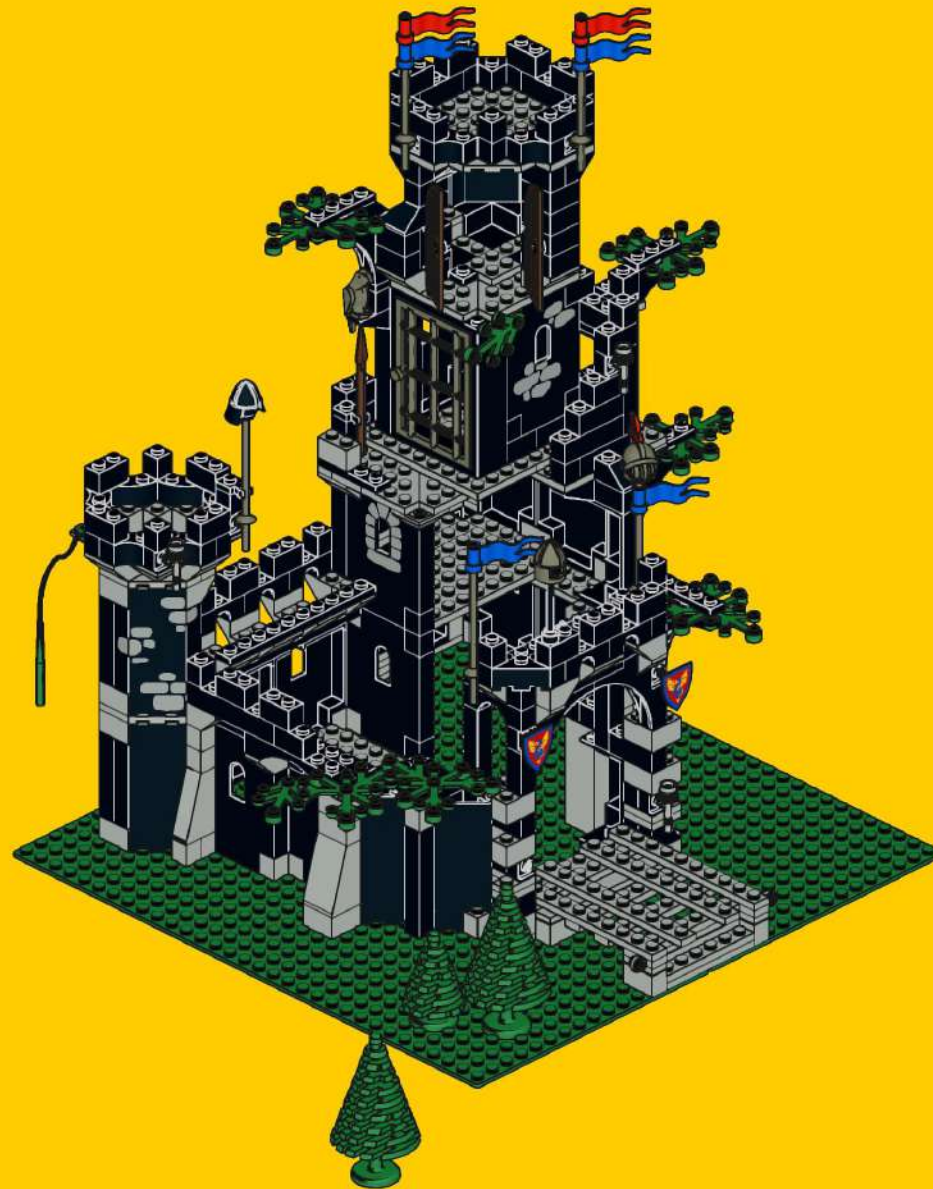

150

2x

151



152

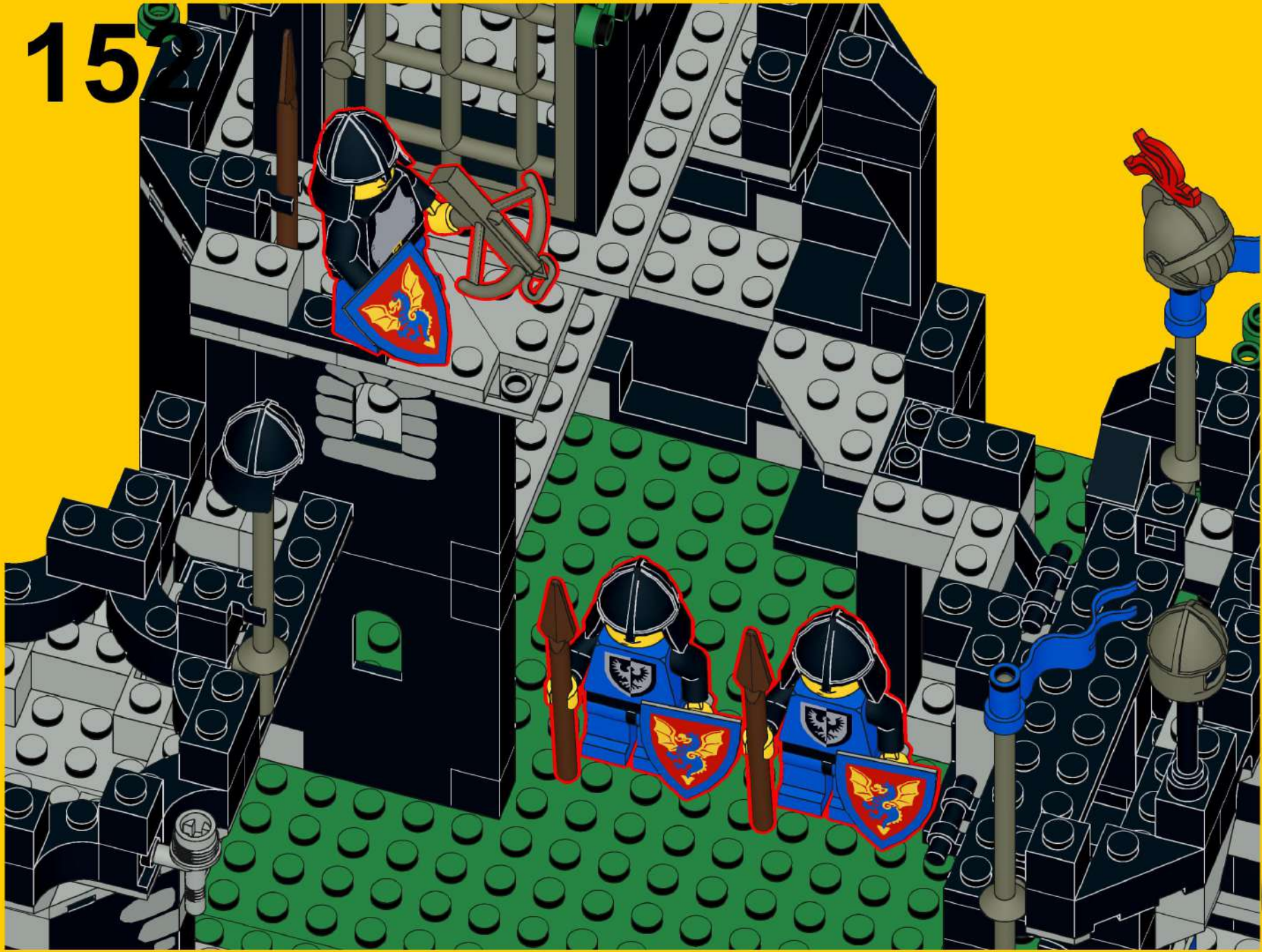

153



154



155



156



157



158



159



160



# 161





# 164

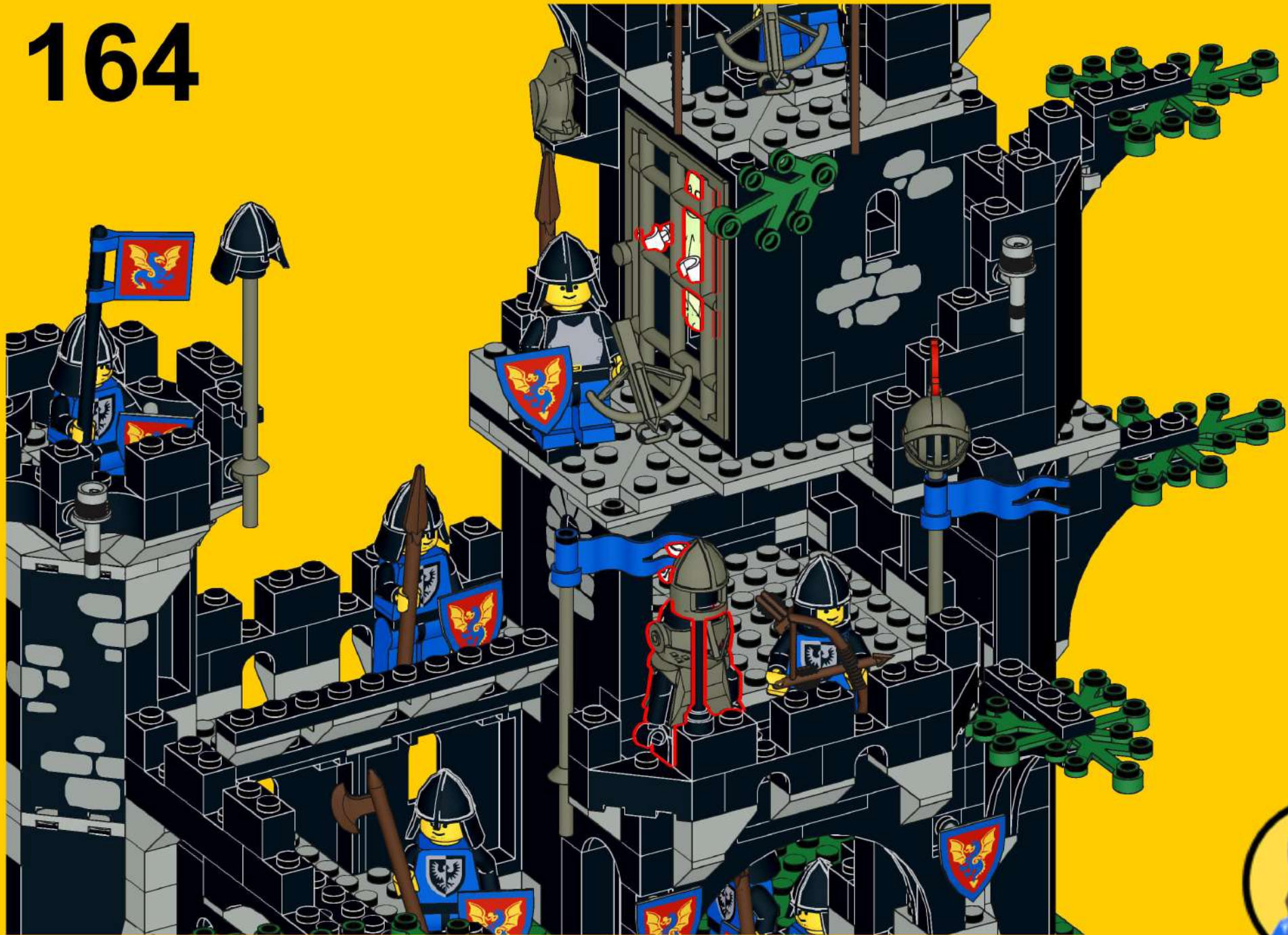



165



166



167

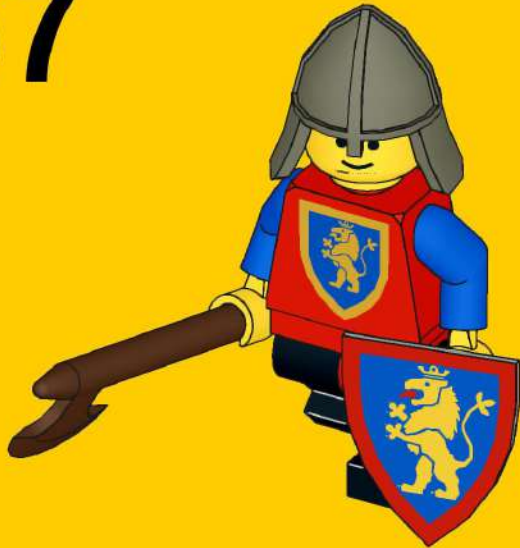

168



169

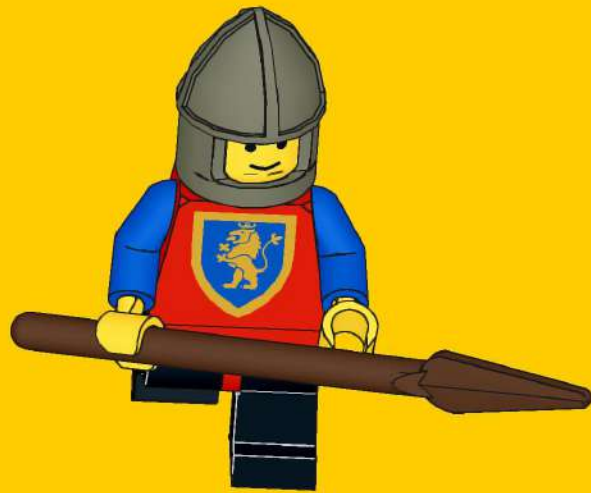

170



171



172



# 173



174

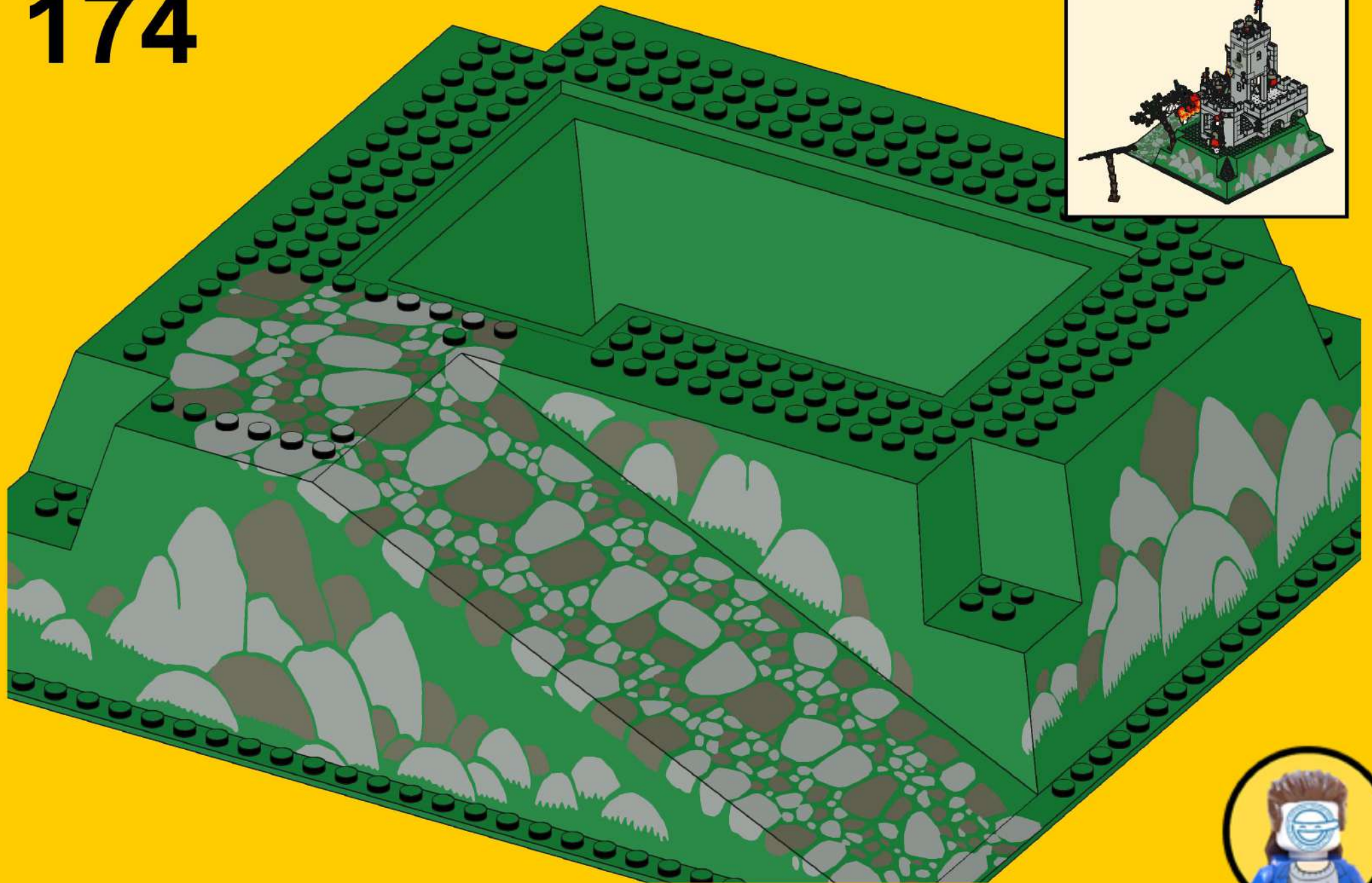

# 175

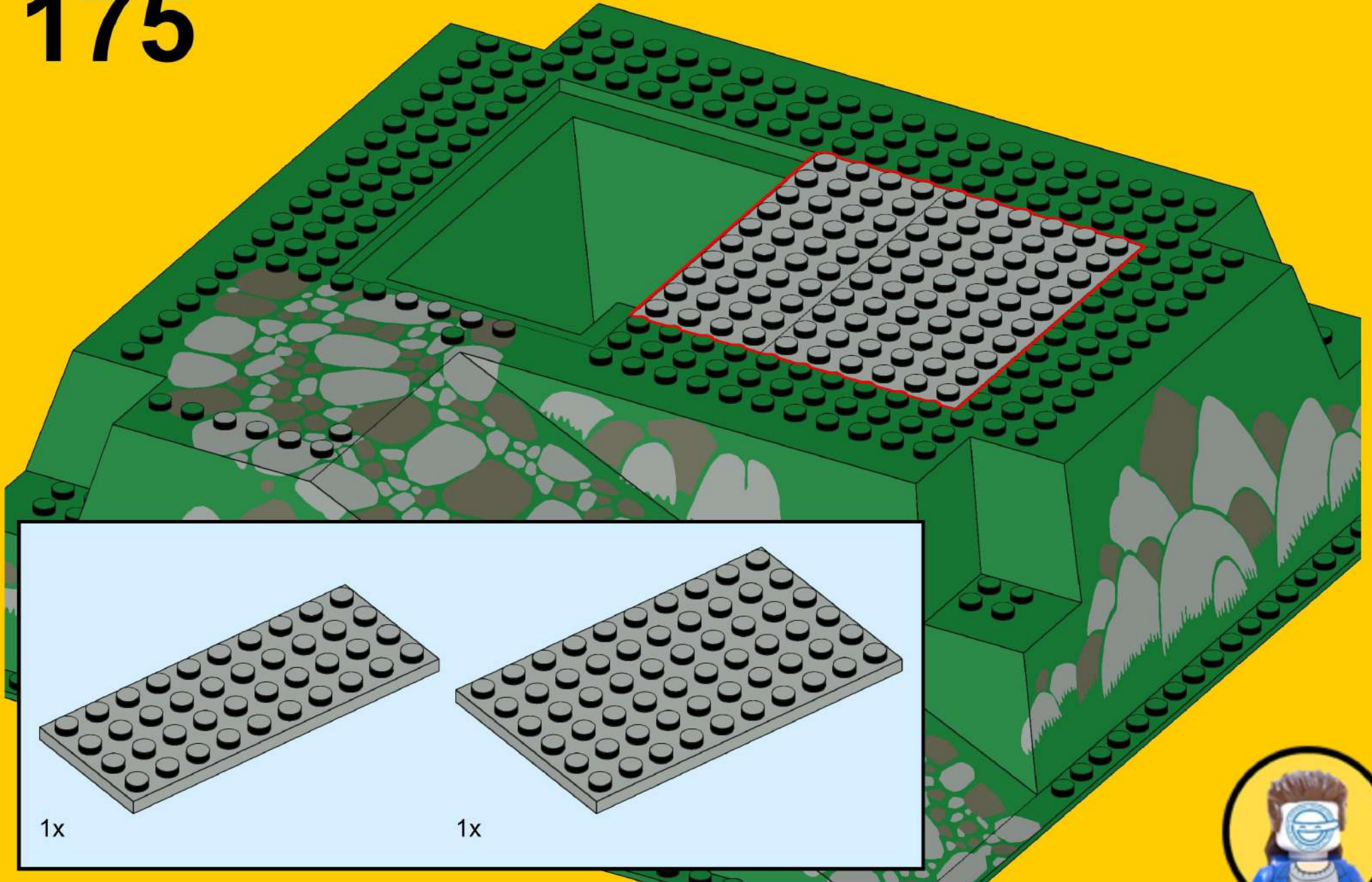

# 176

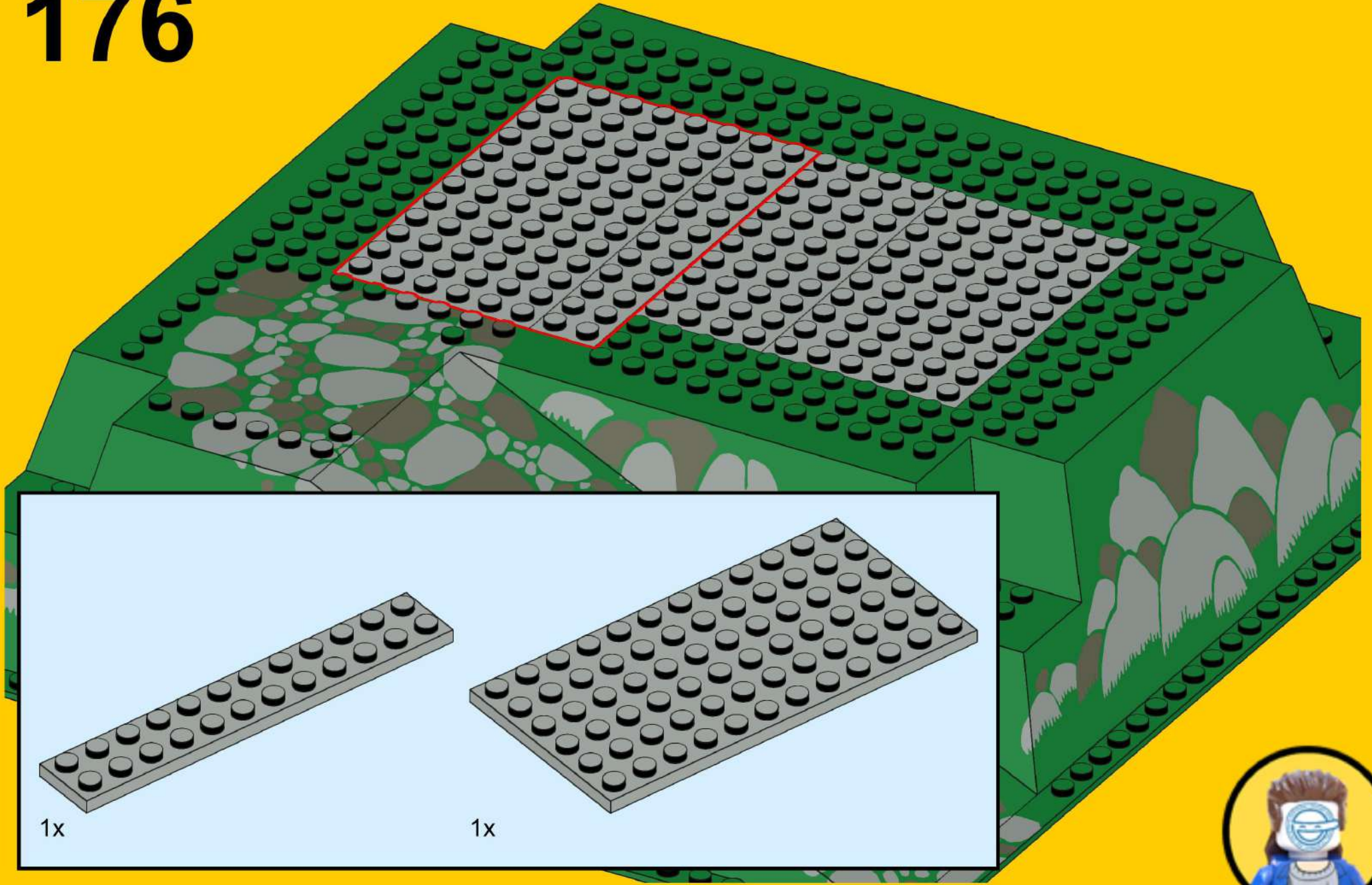

# 177

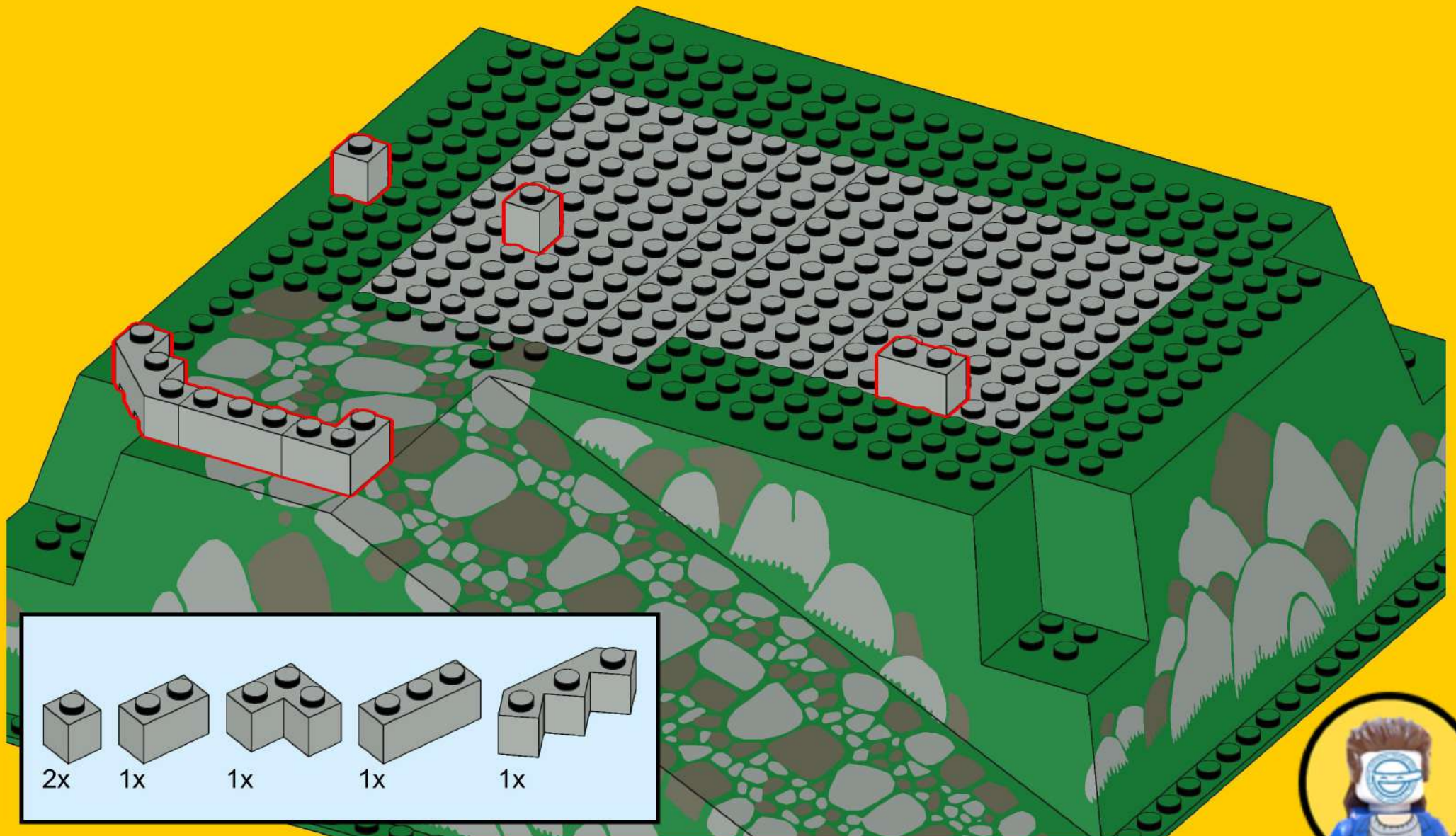



# 178

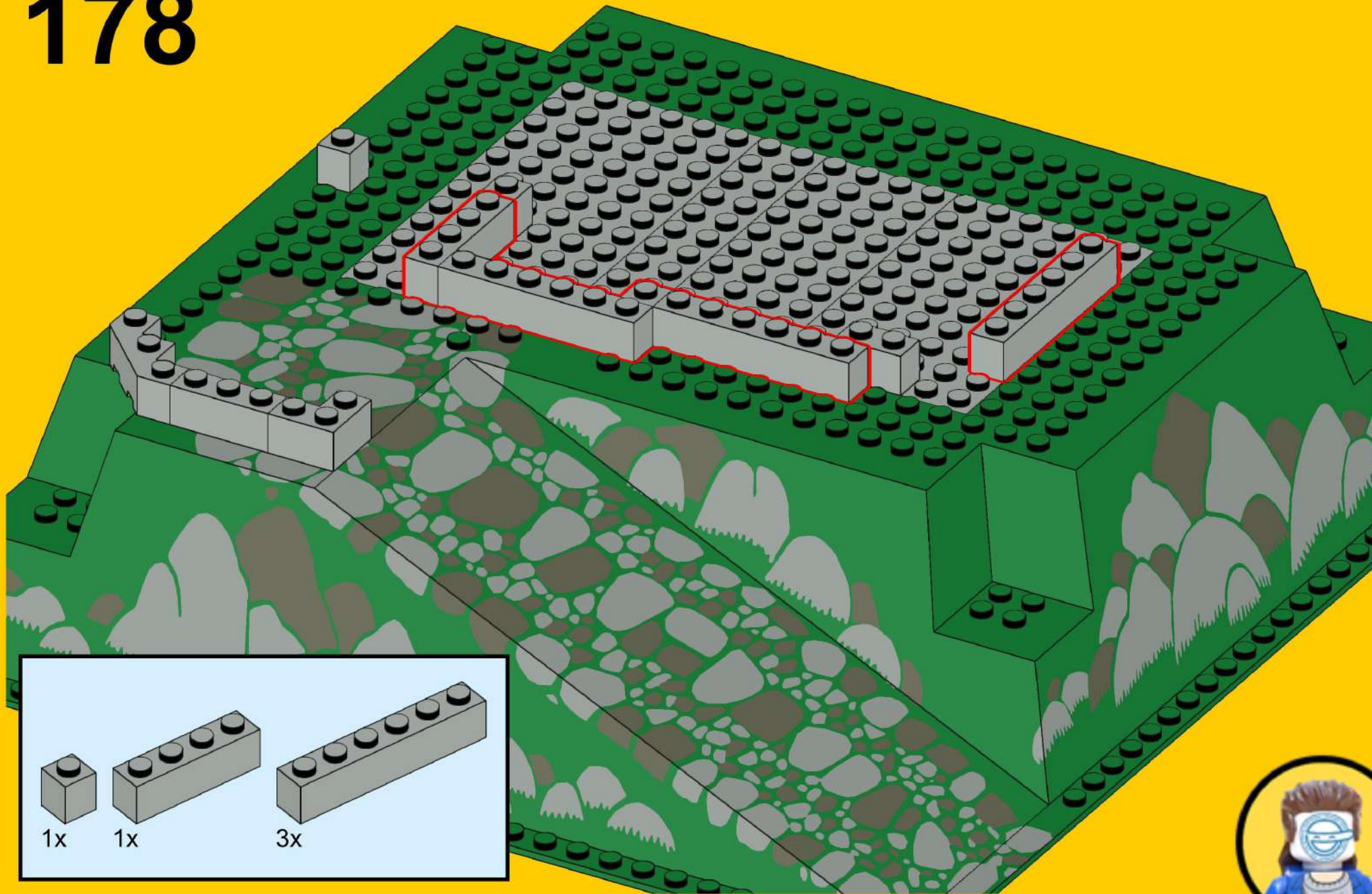

# 179

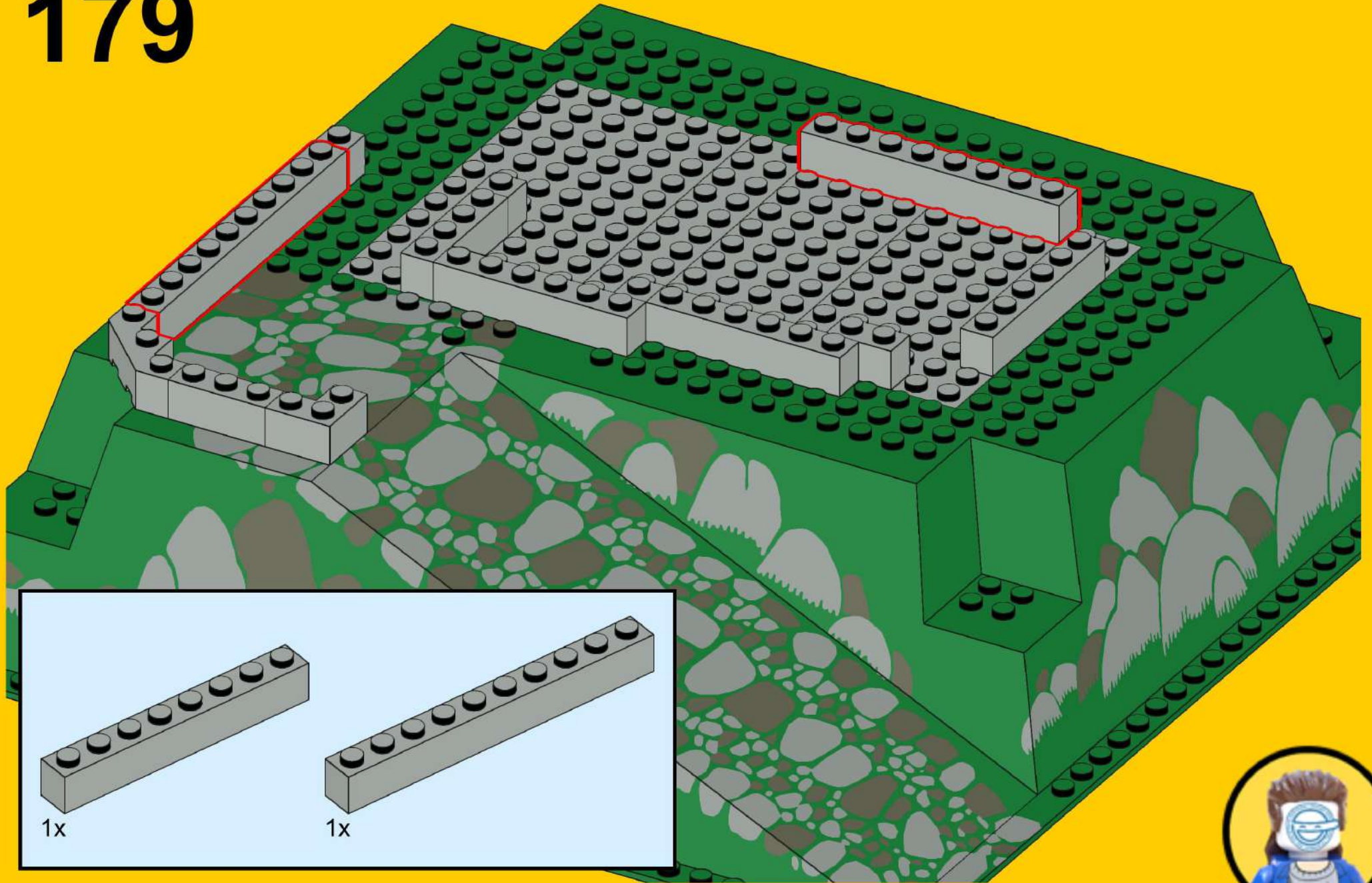

# 180

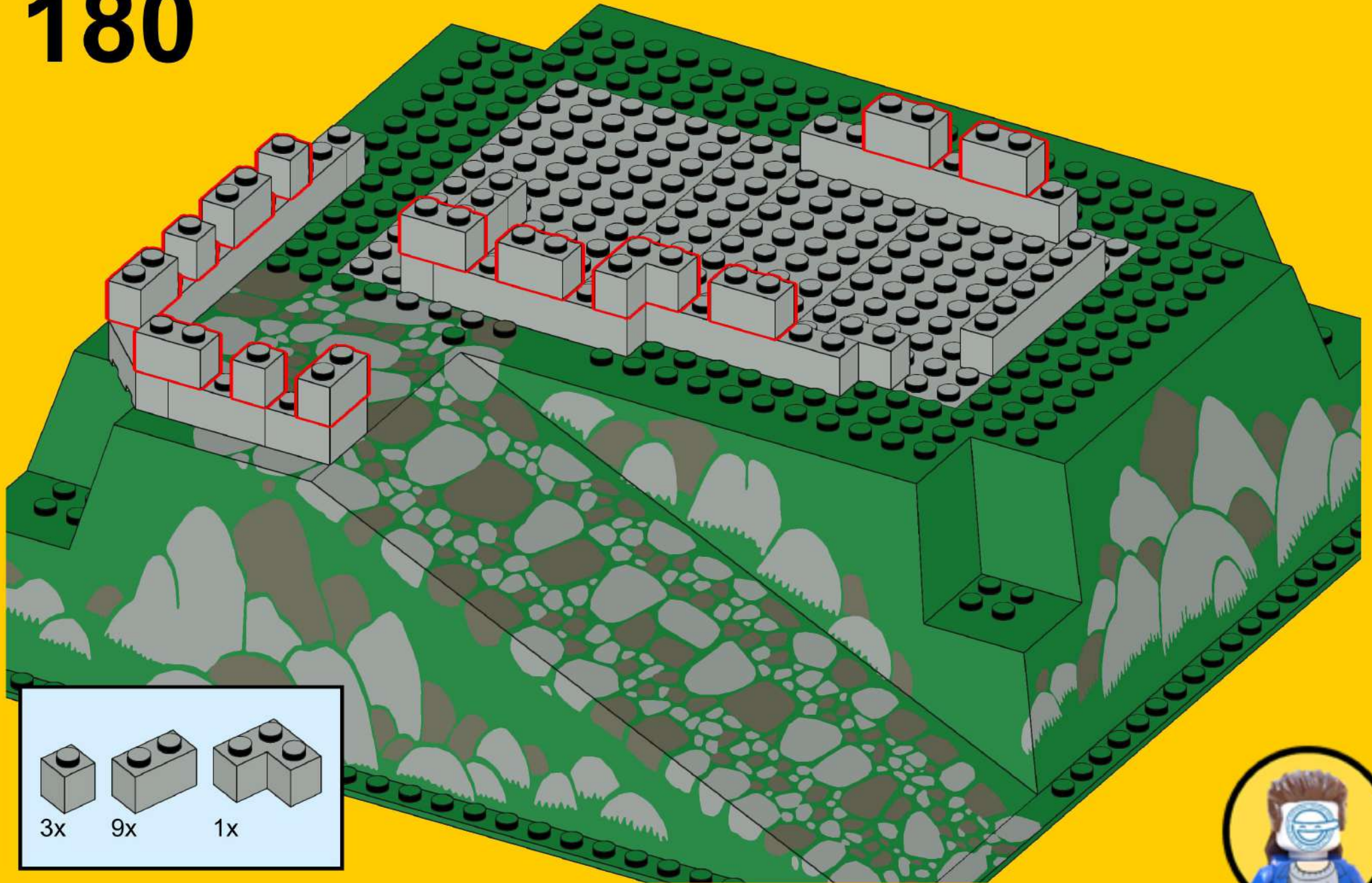

# 181

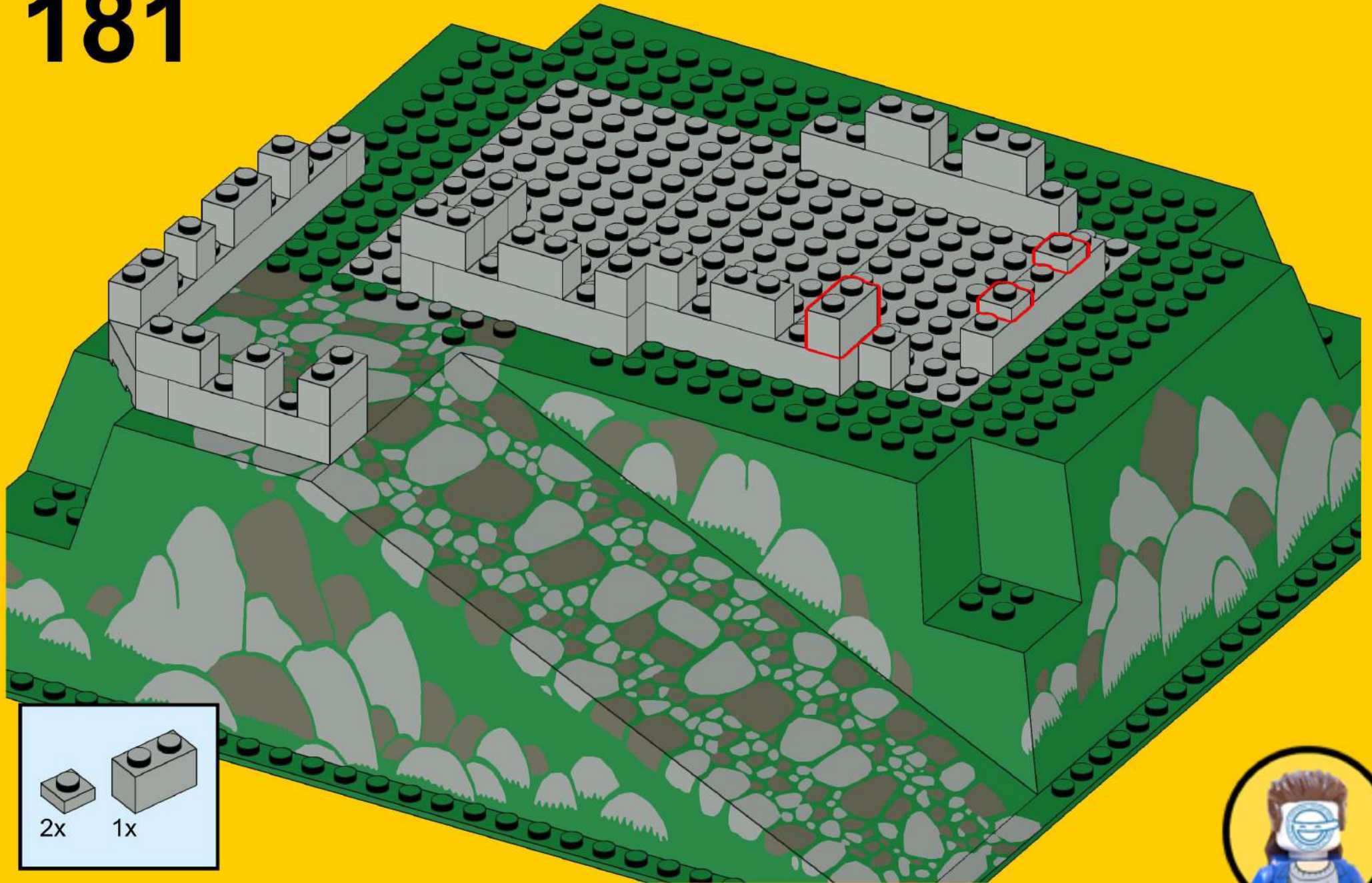

# 182

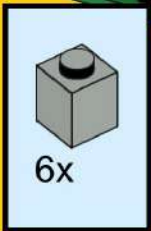
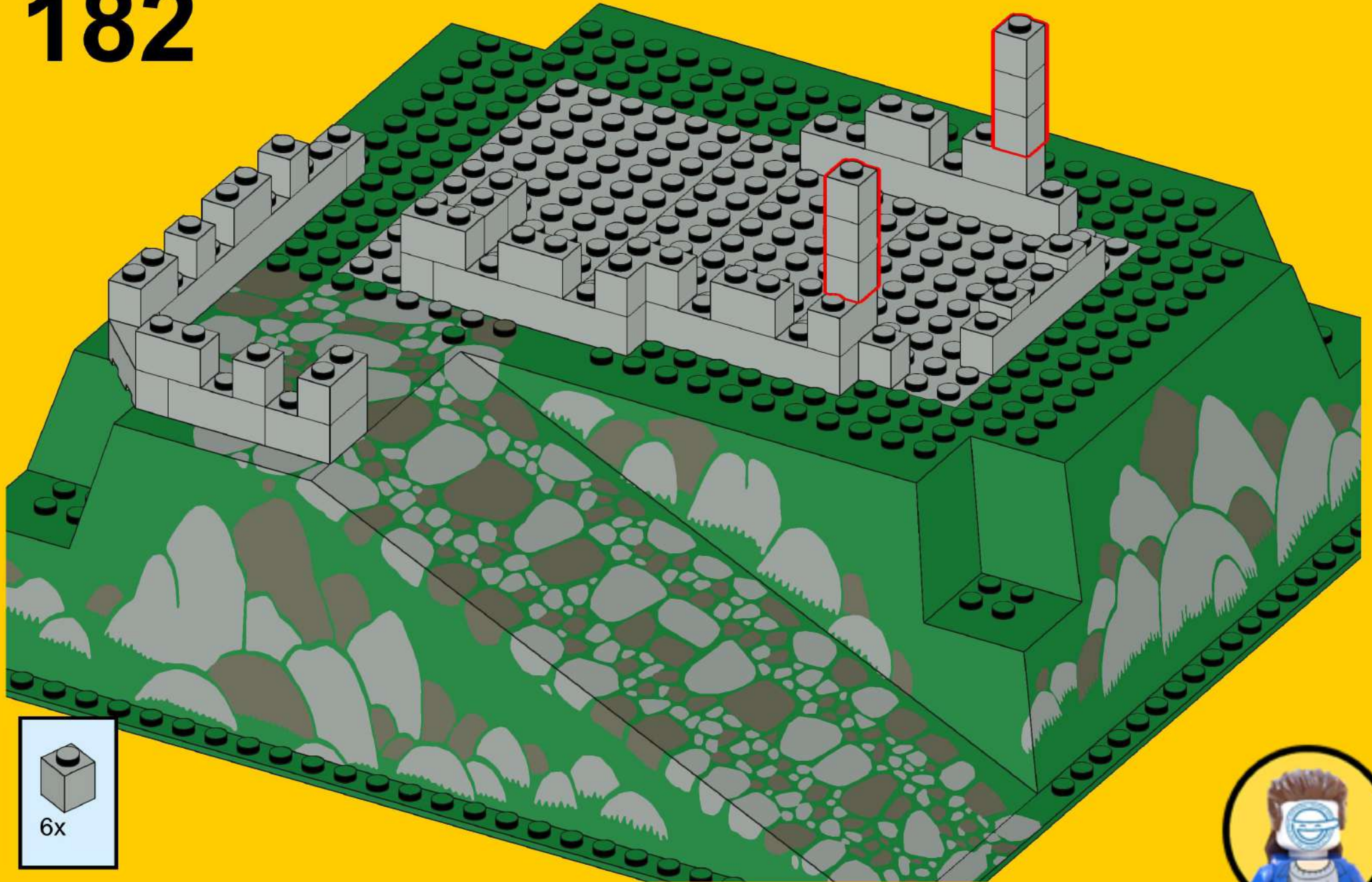

# 183

1:1

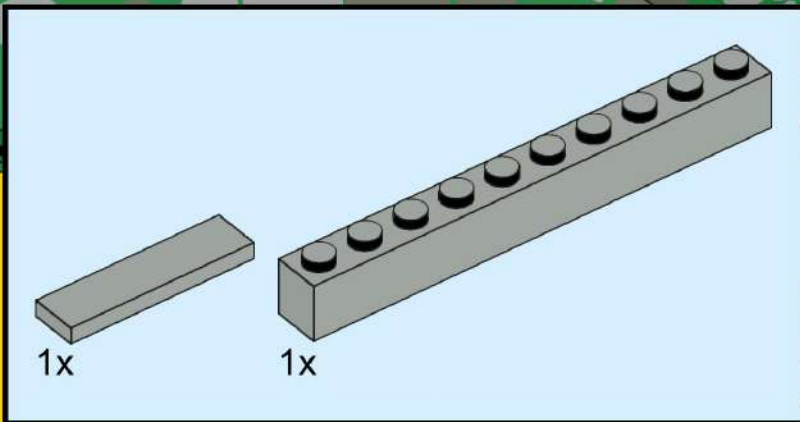
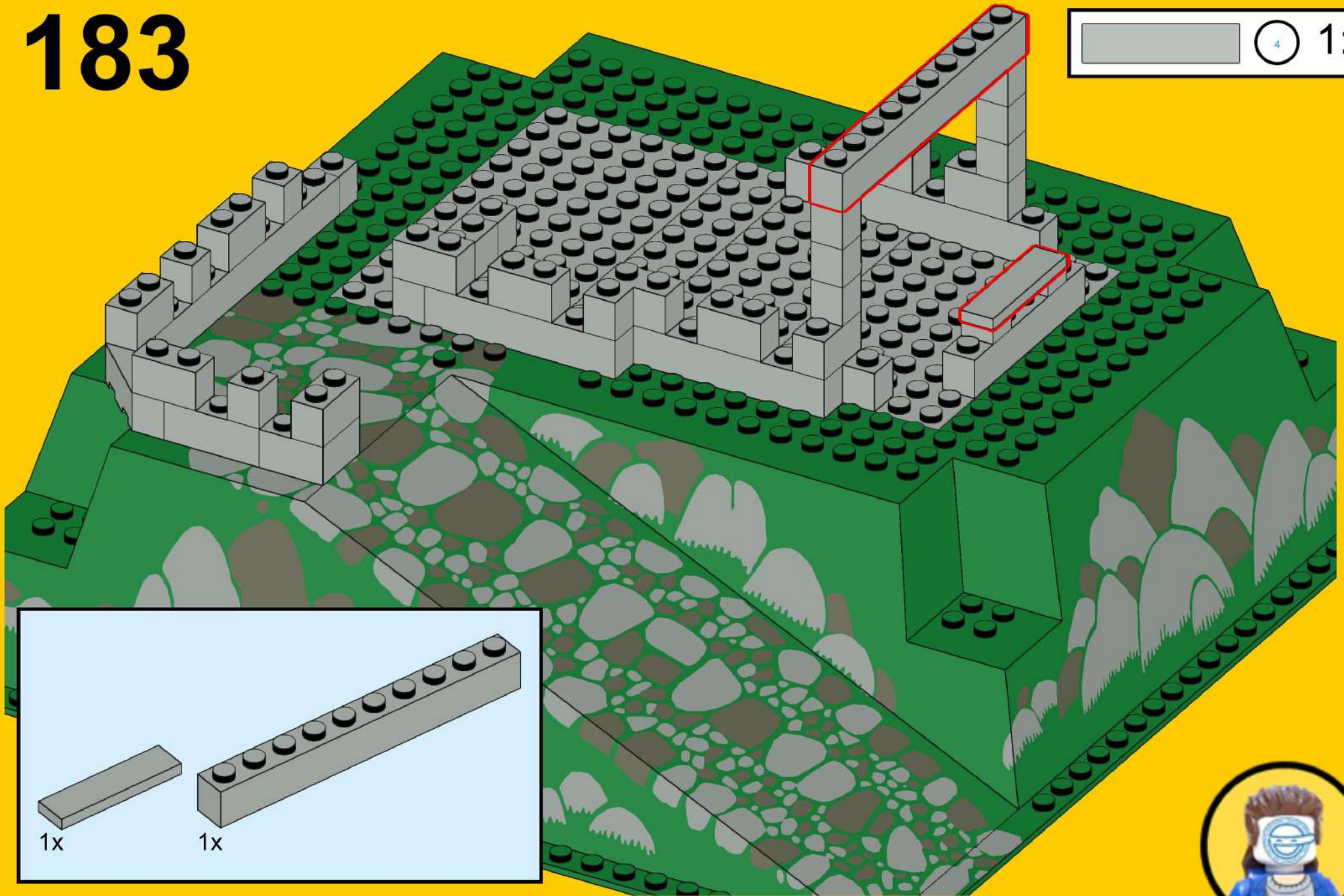

# 184

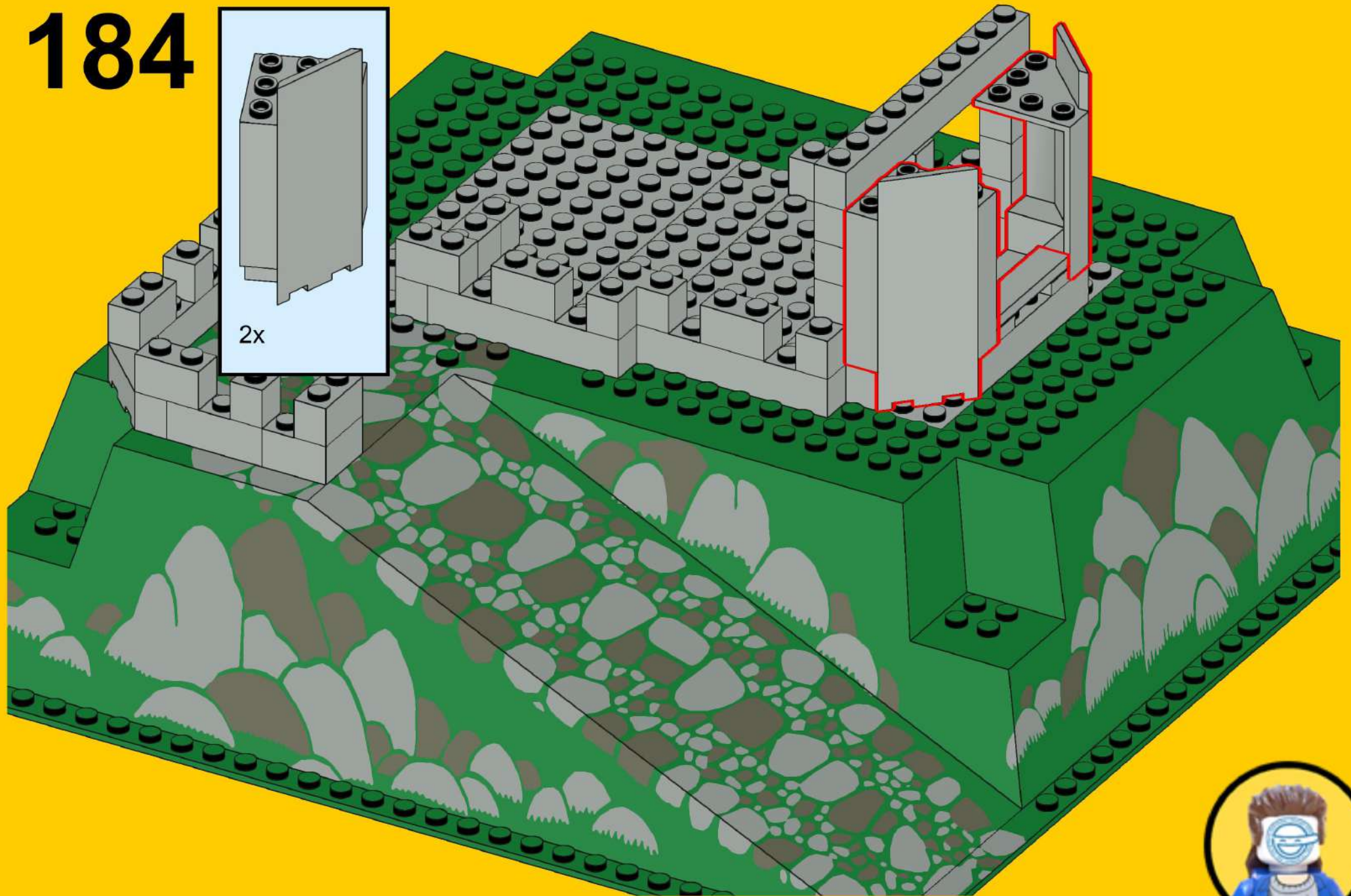
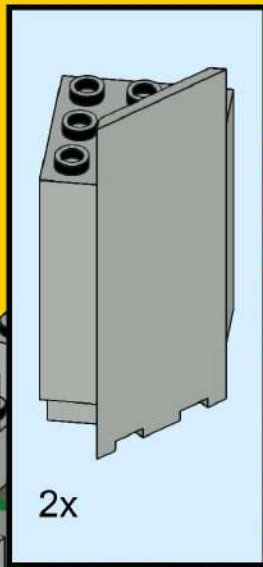

# 185

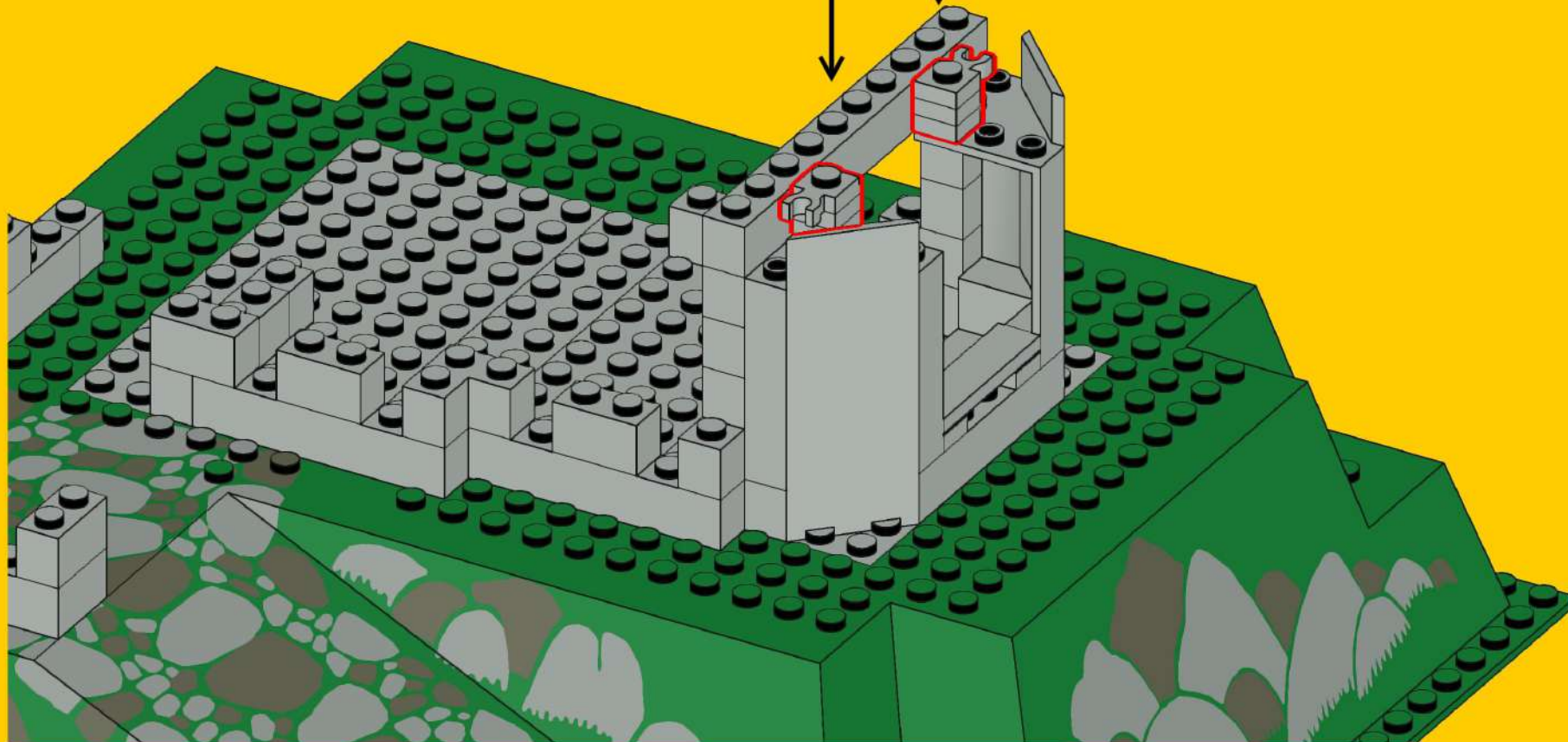
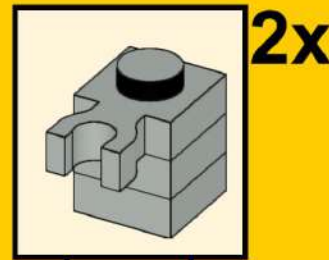
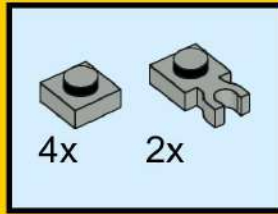



# 186

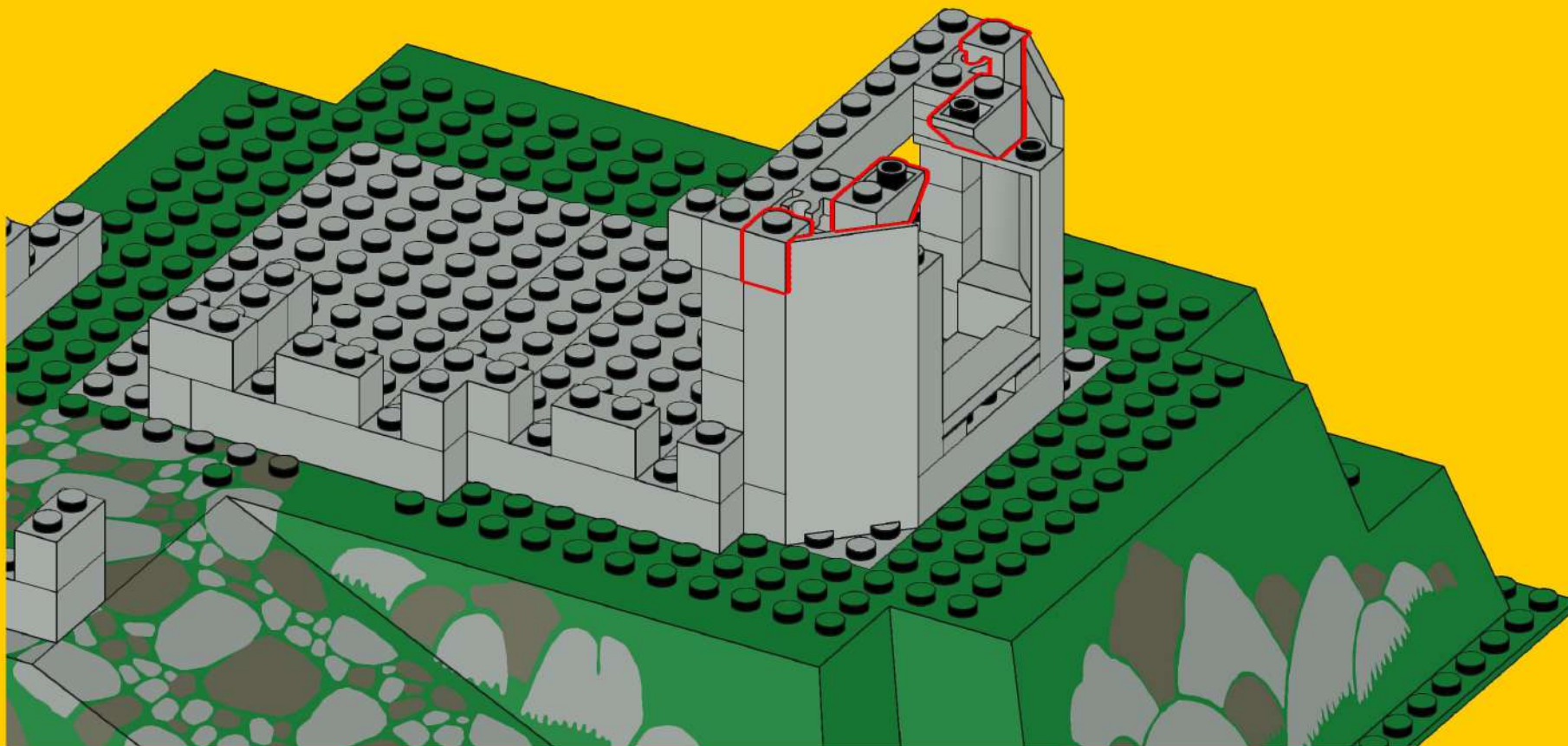
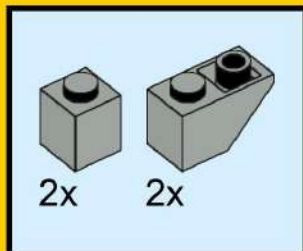

# 187

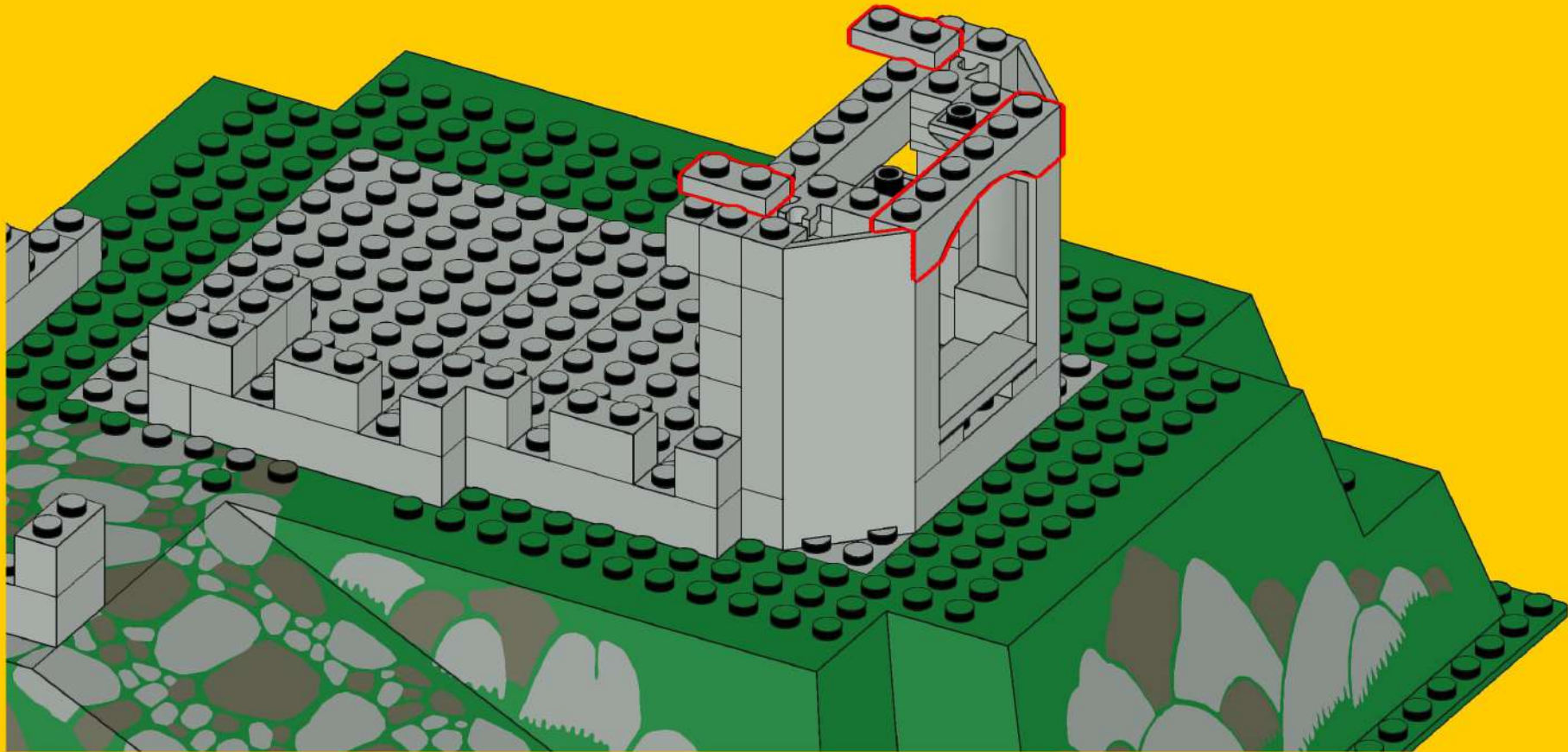
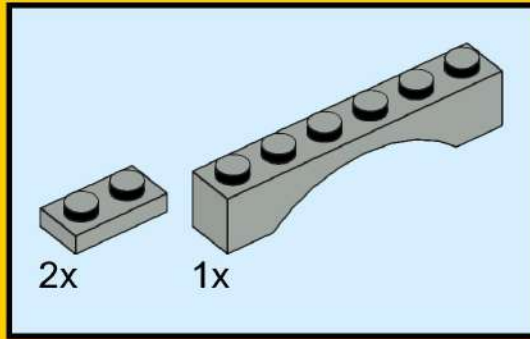

# 188

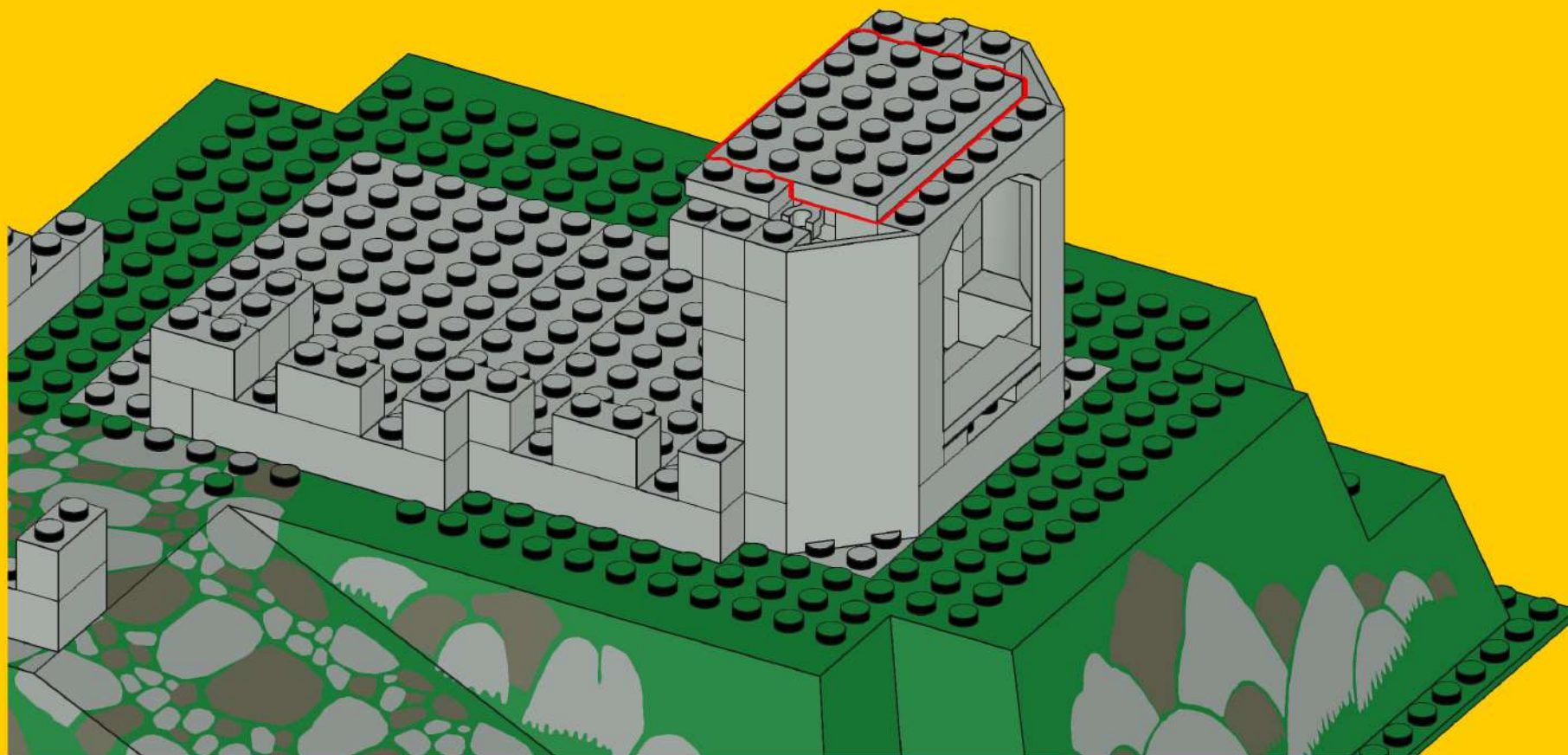
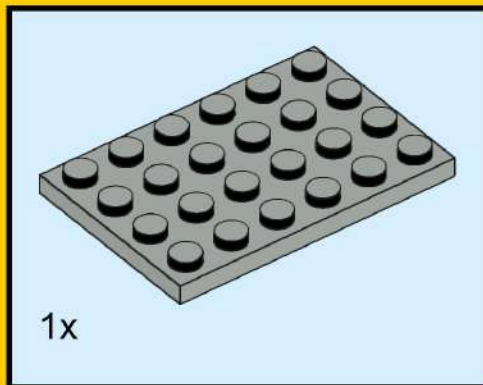

# 189

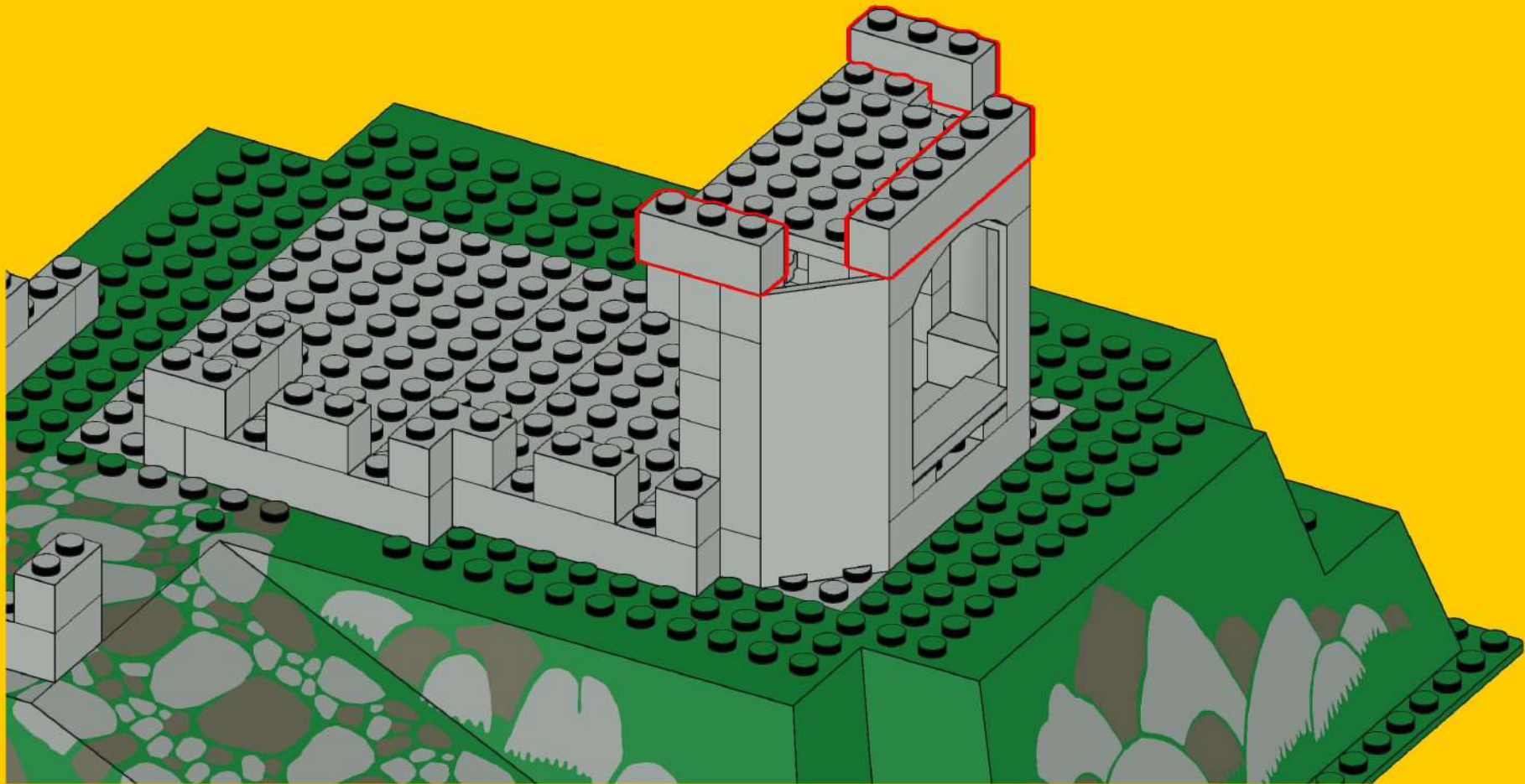
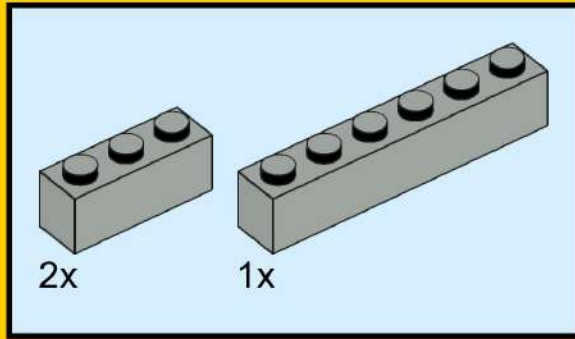

# 190

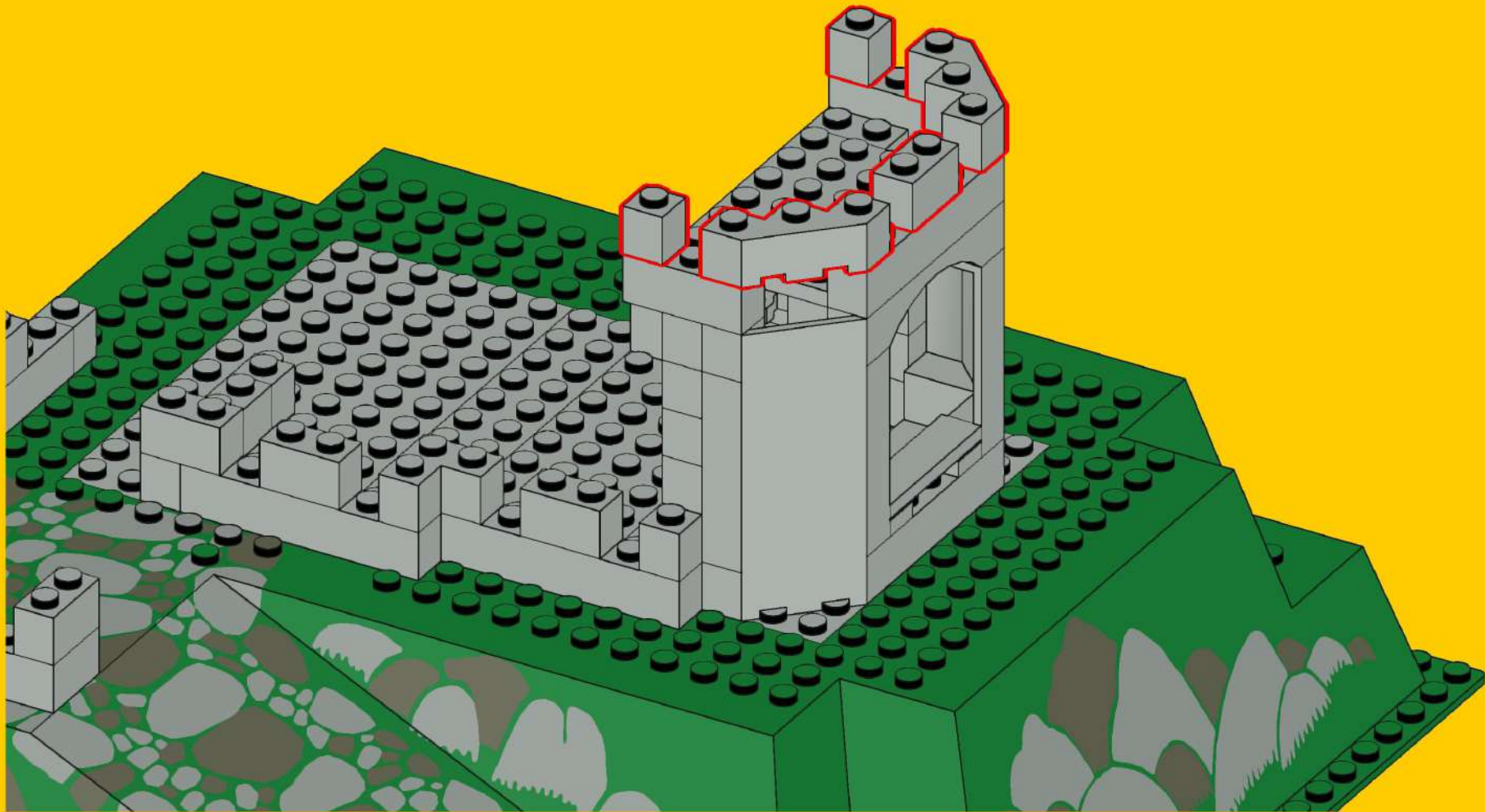
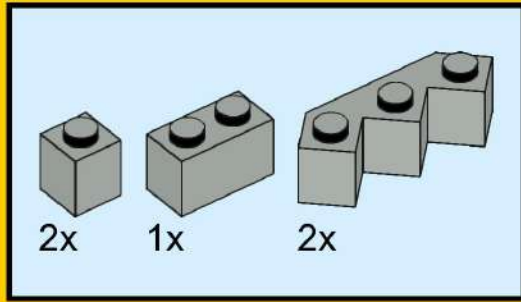

# 191

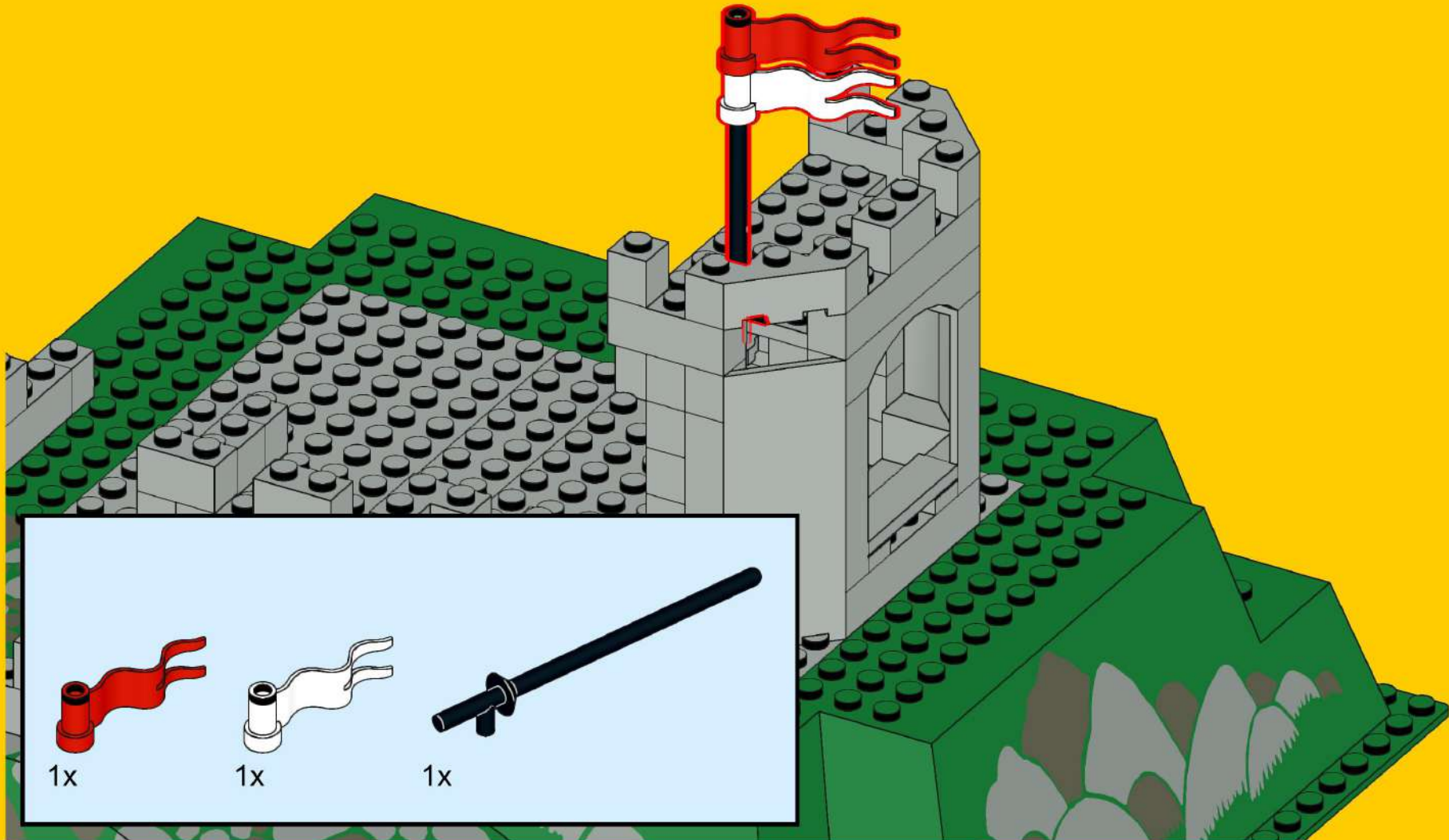

# 192

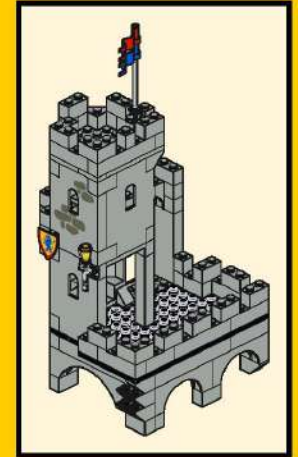

# 193

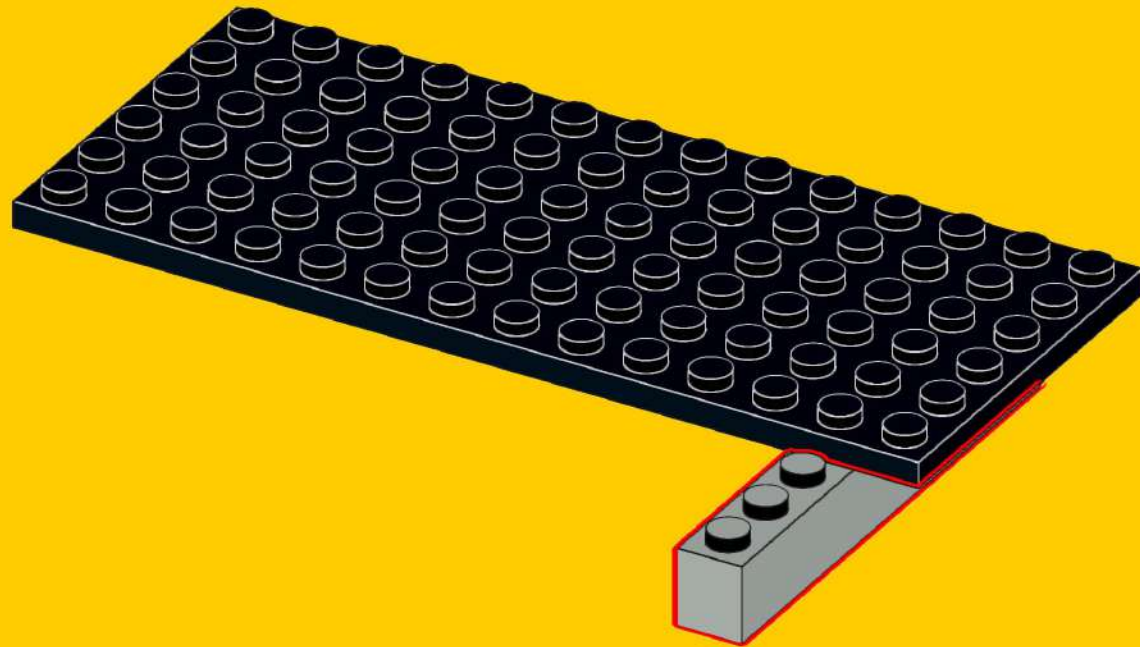
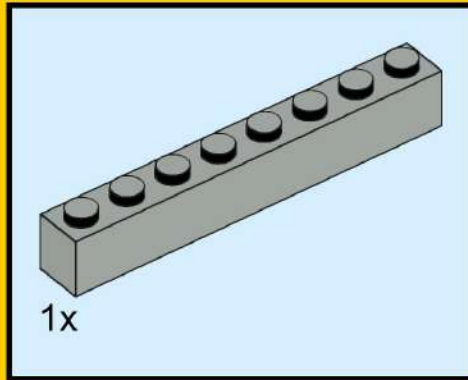



# 194

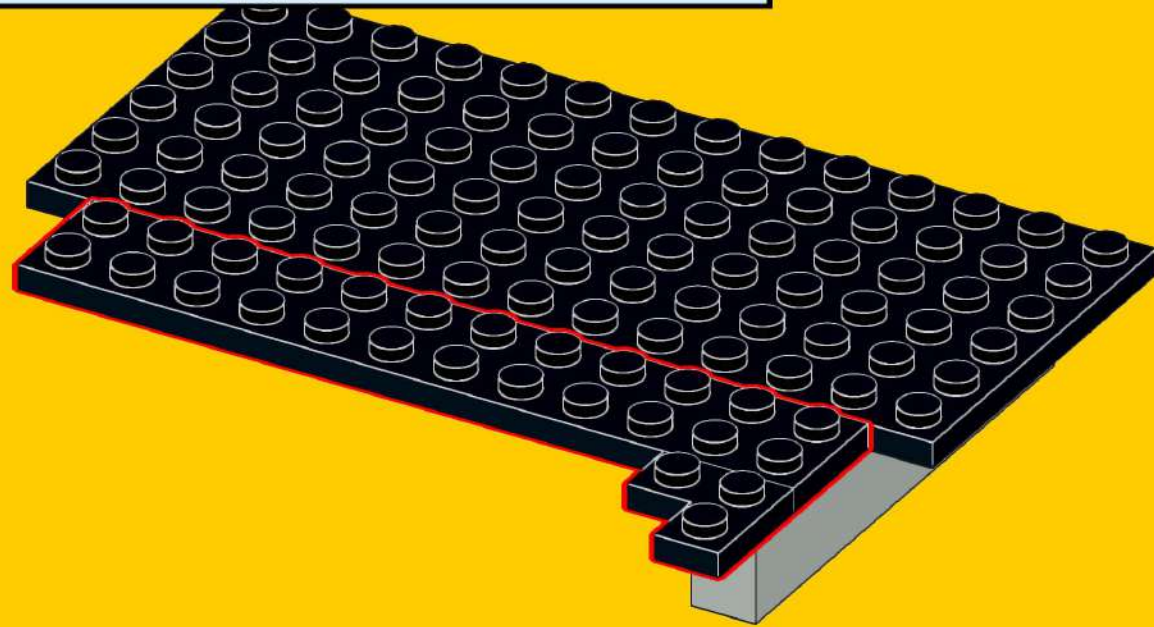
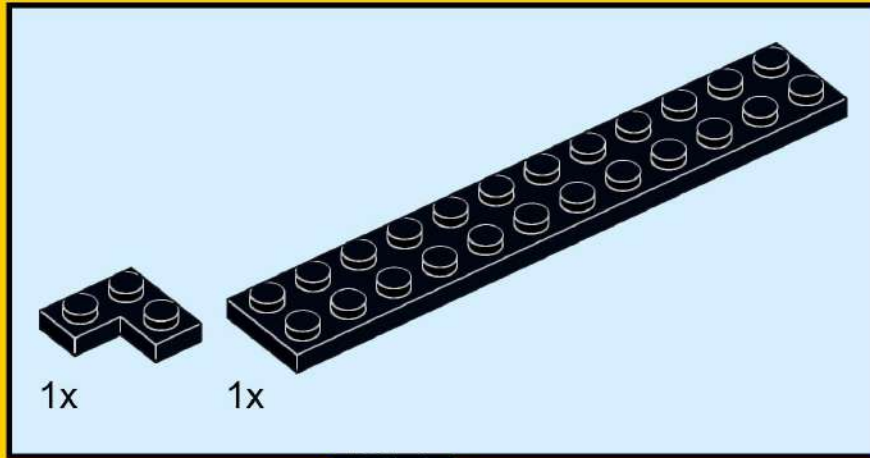

# 195

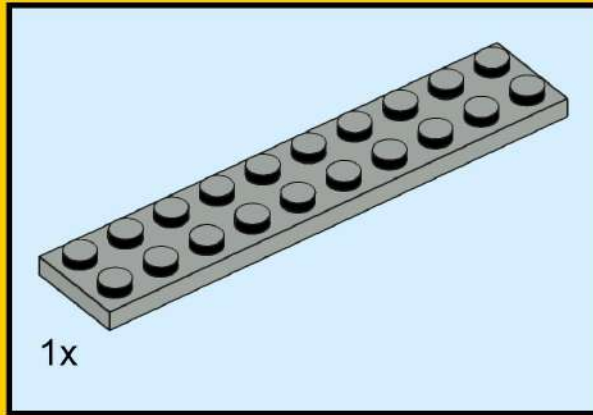

# 196

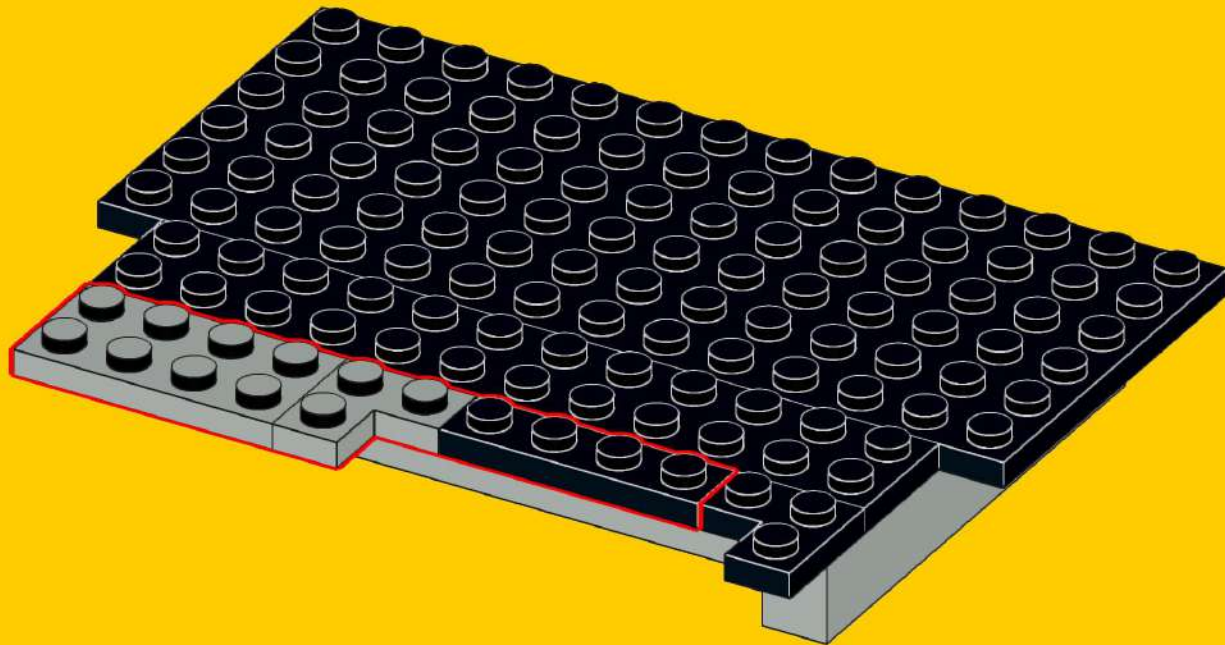
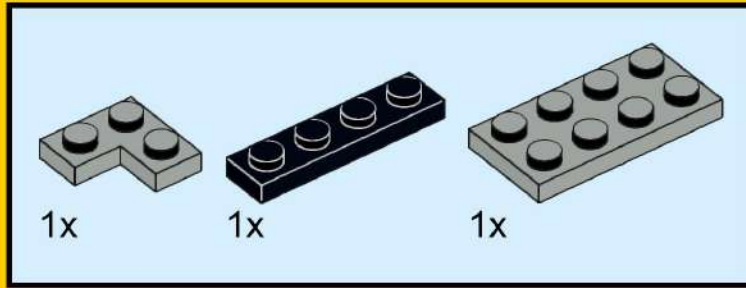

# 197

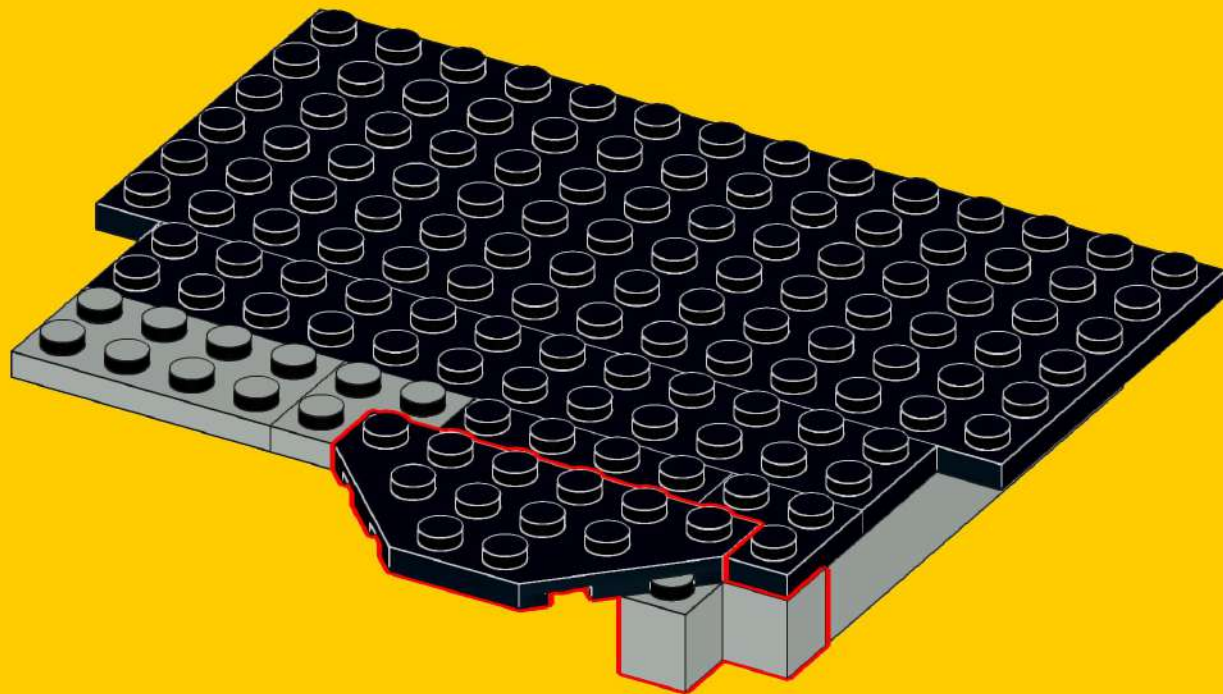
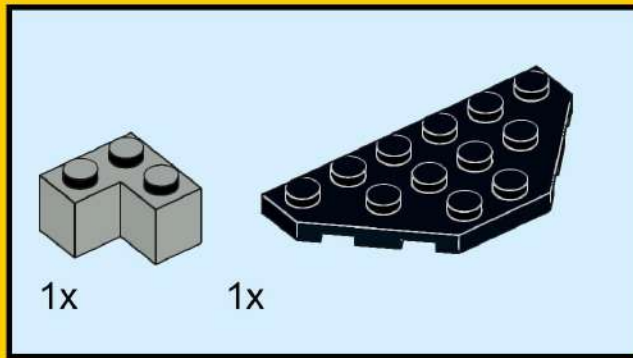

# 198

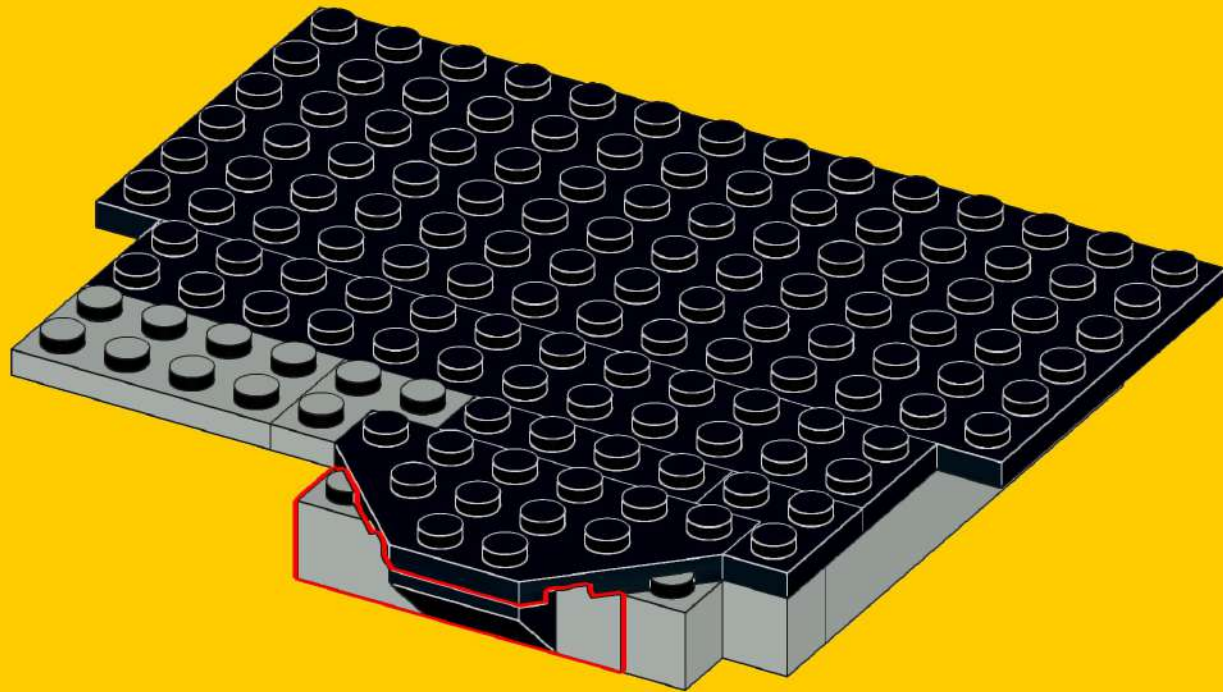
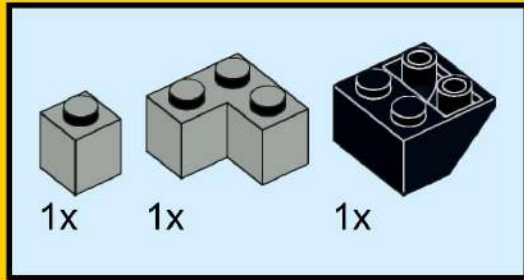

# 199

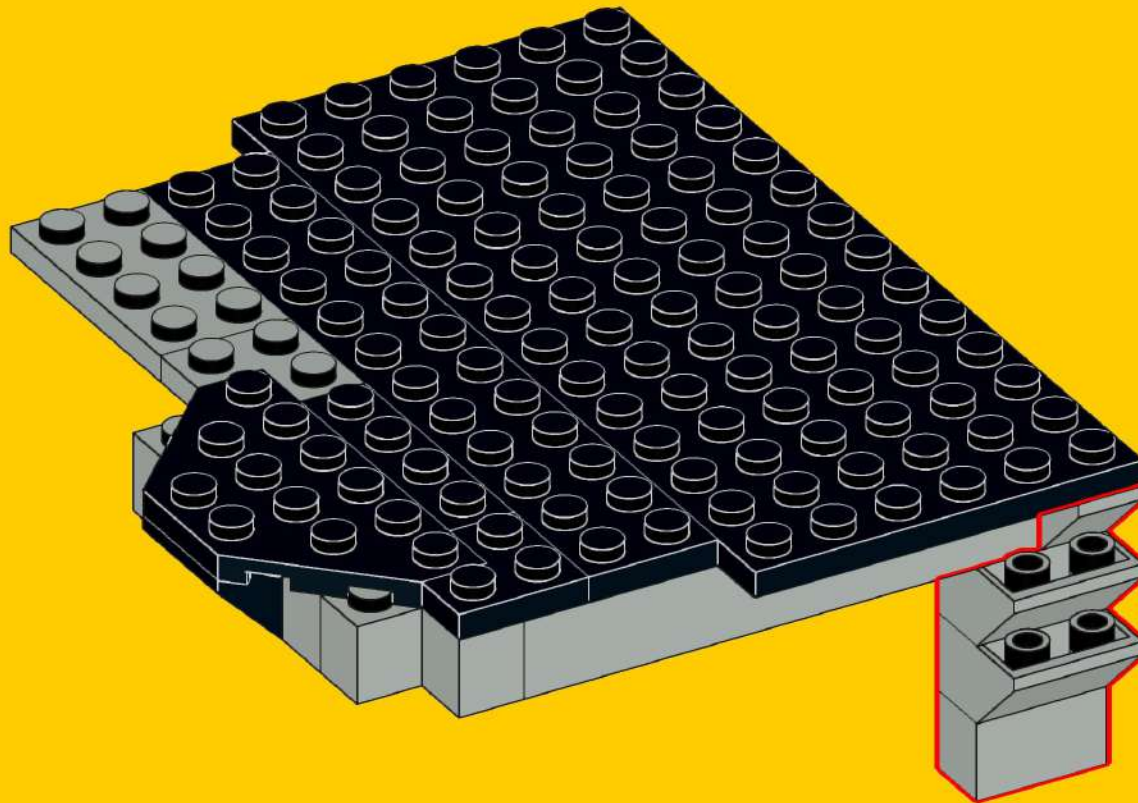
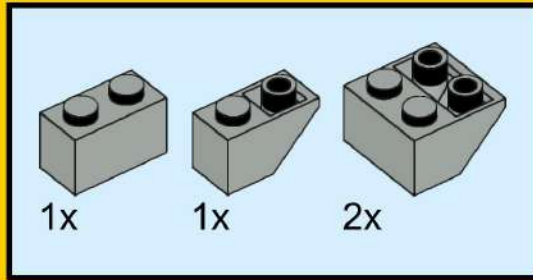

# 200

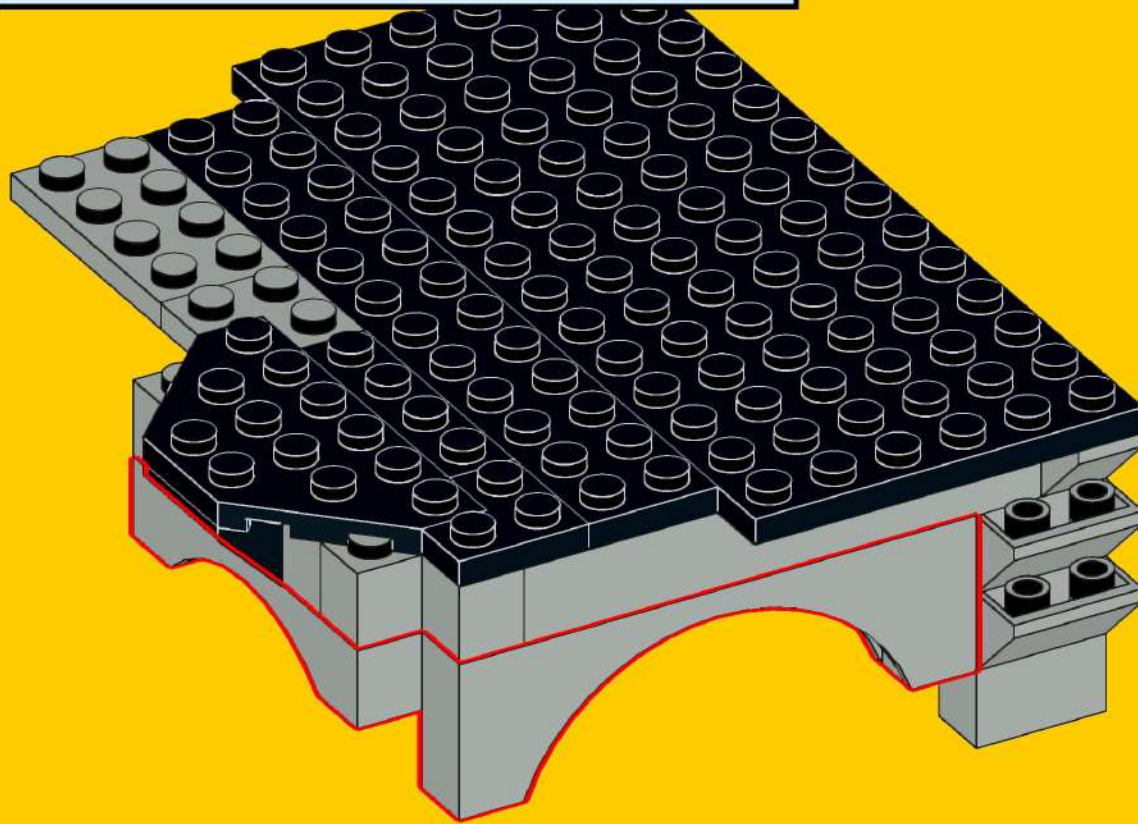
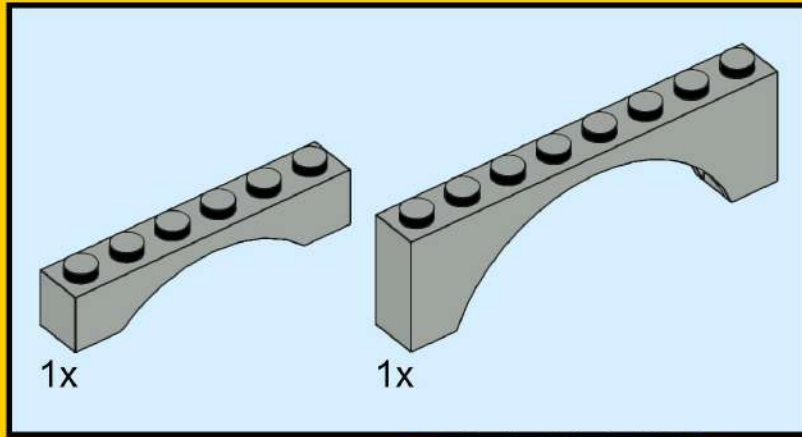

# 201

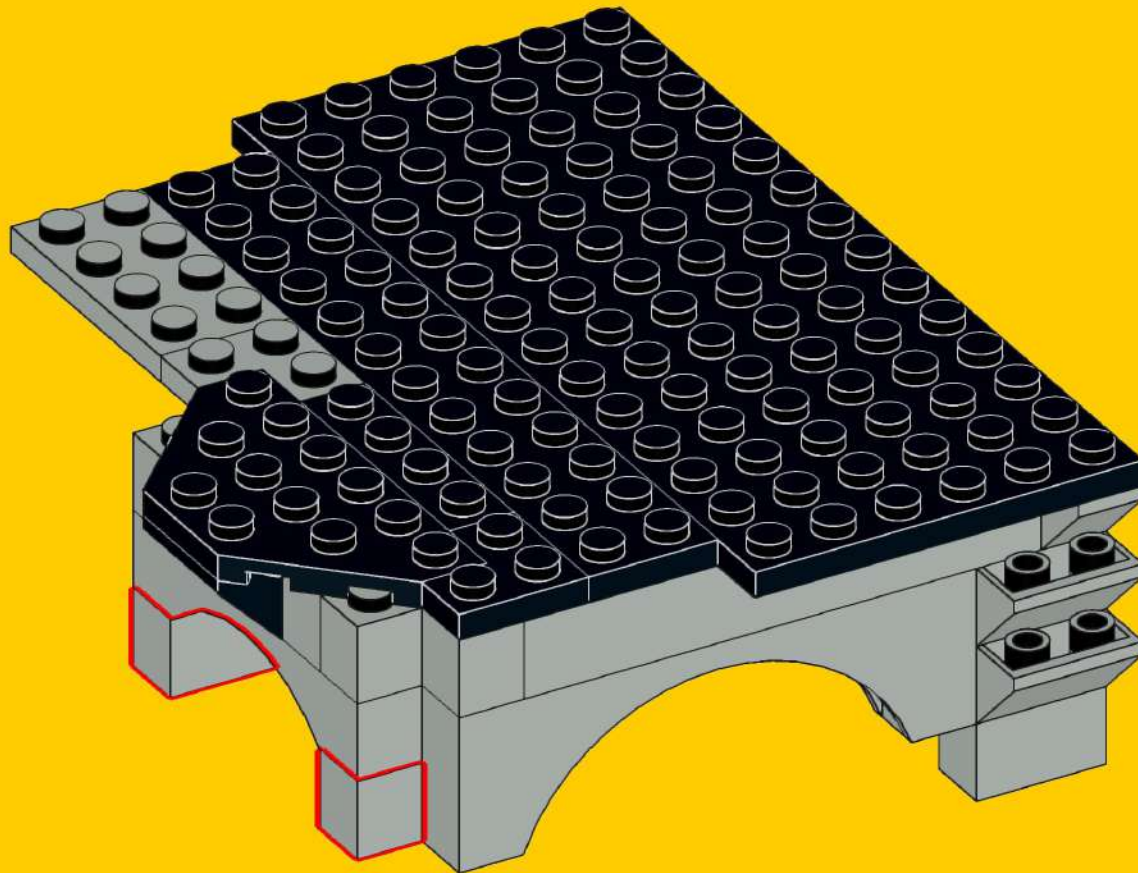
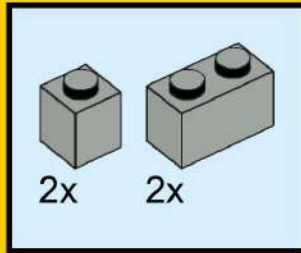



# 202

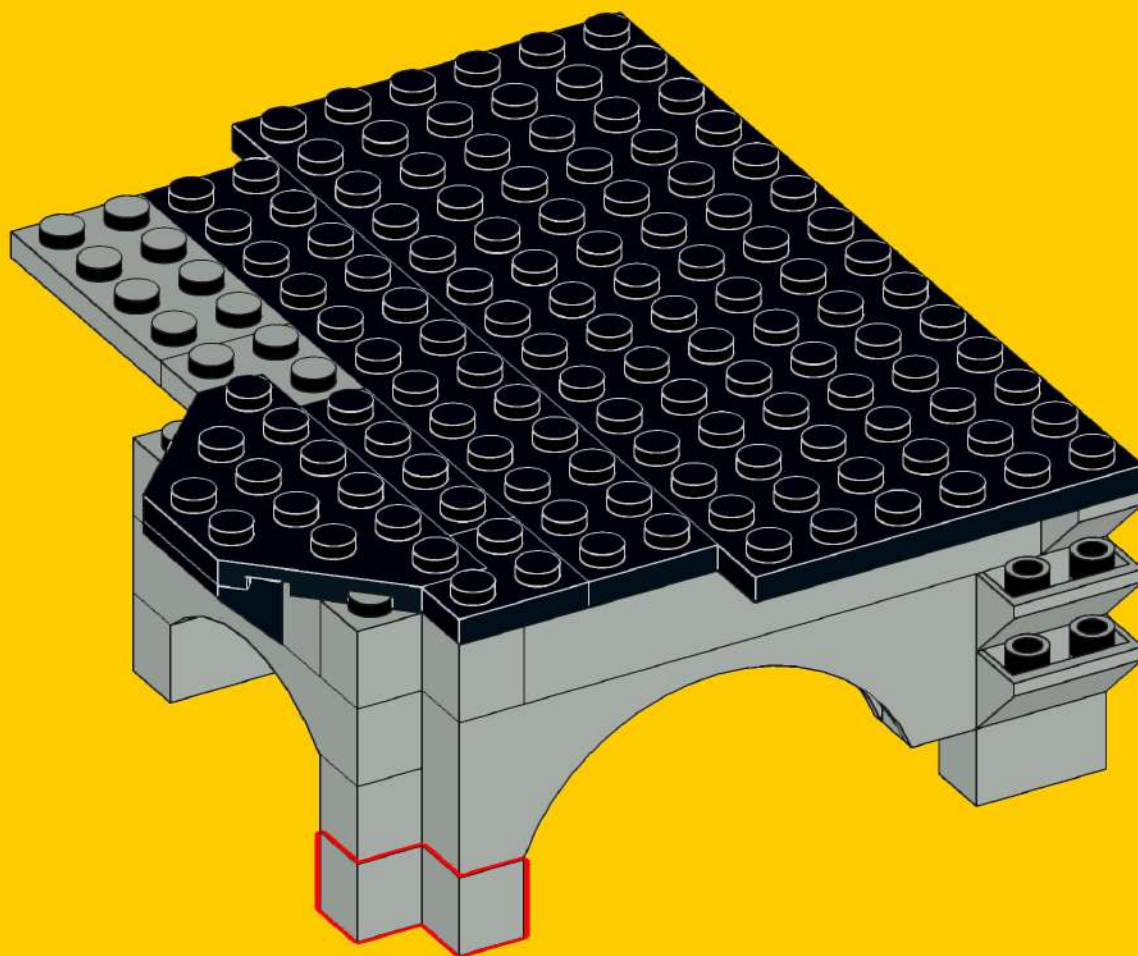
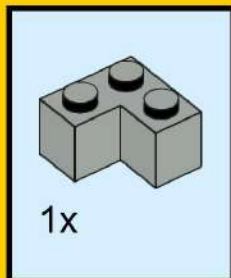

# 203

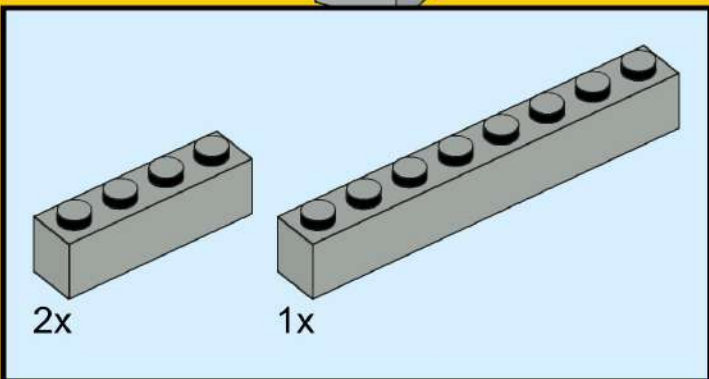

# 204

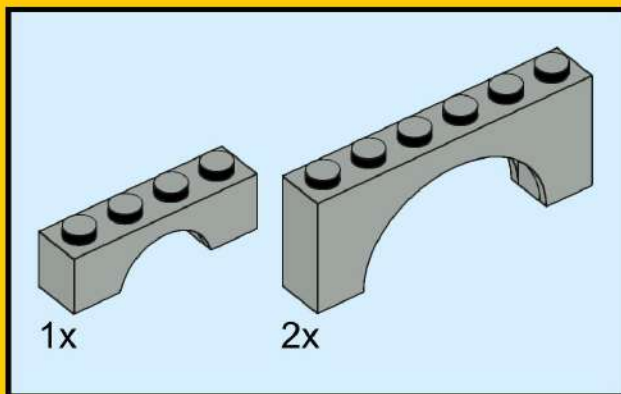
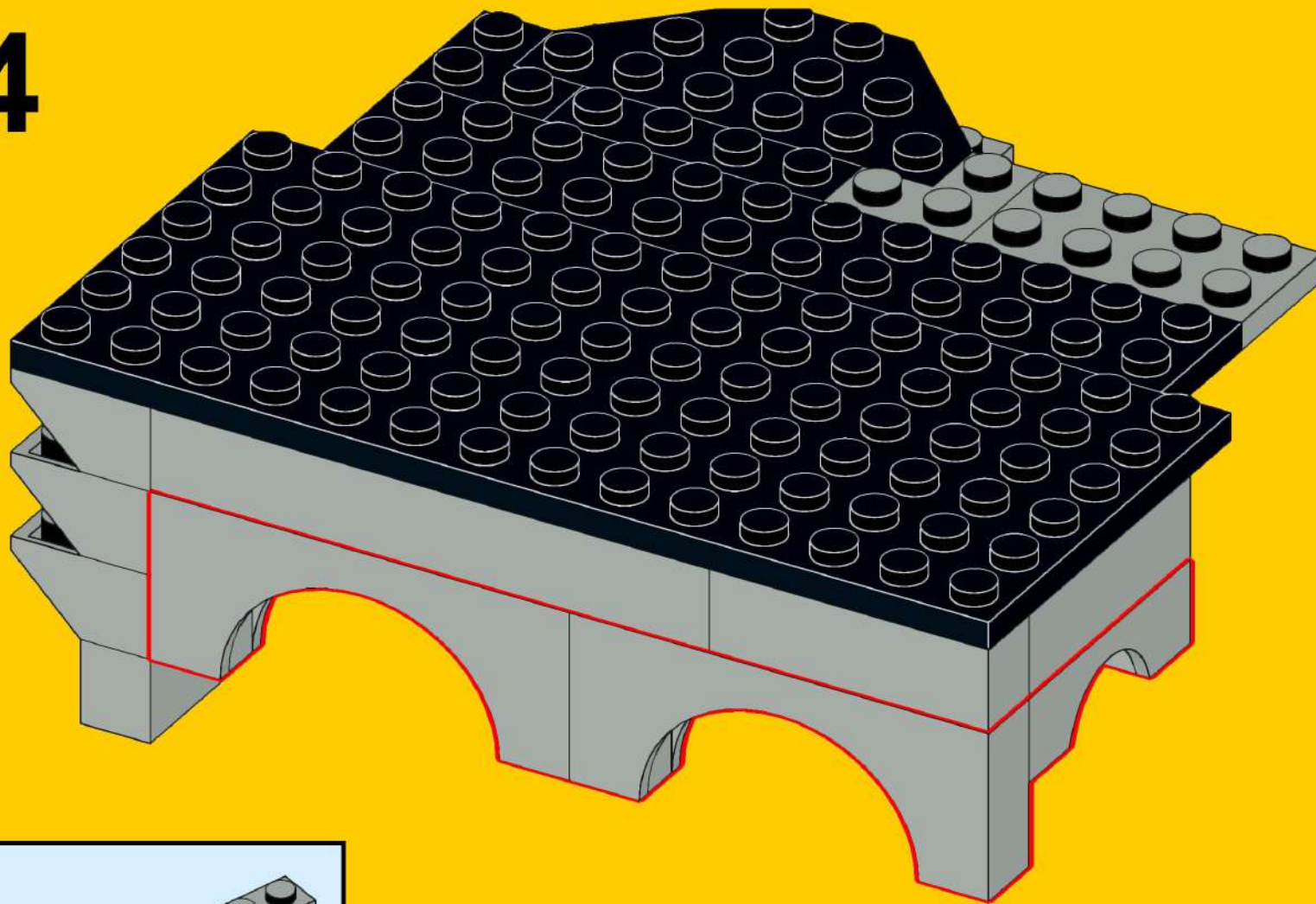

# 205

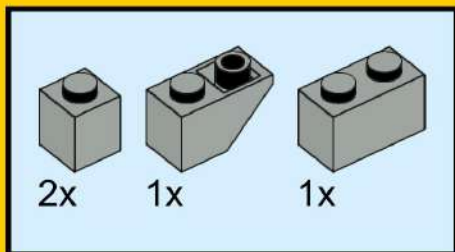
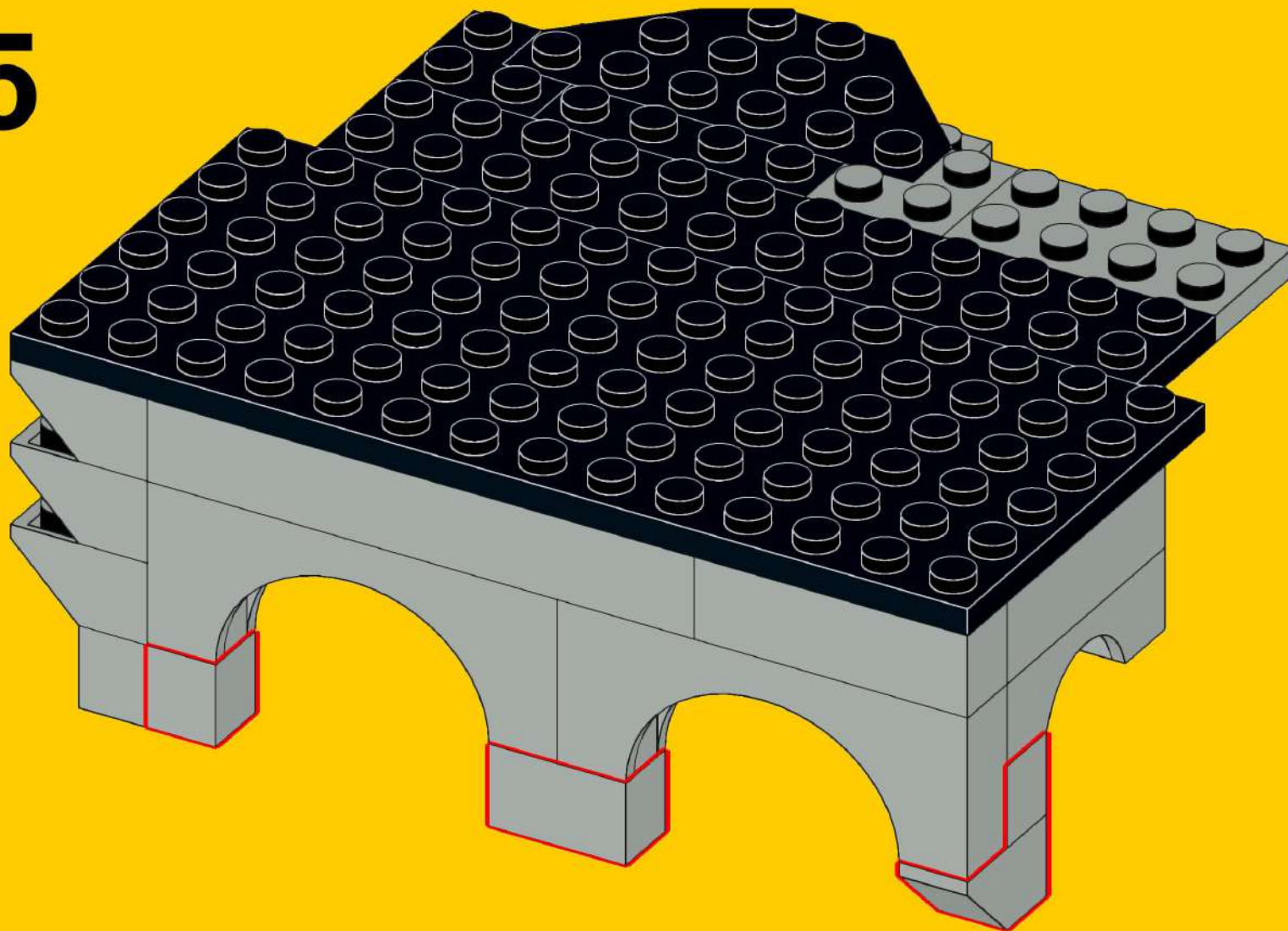

# 206

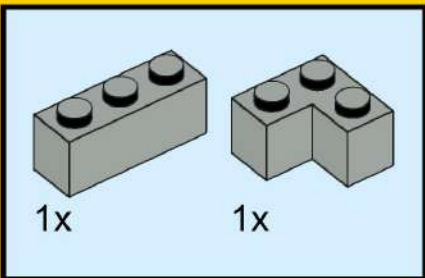
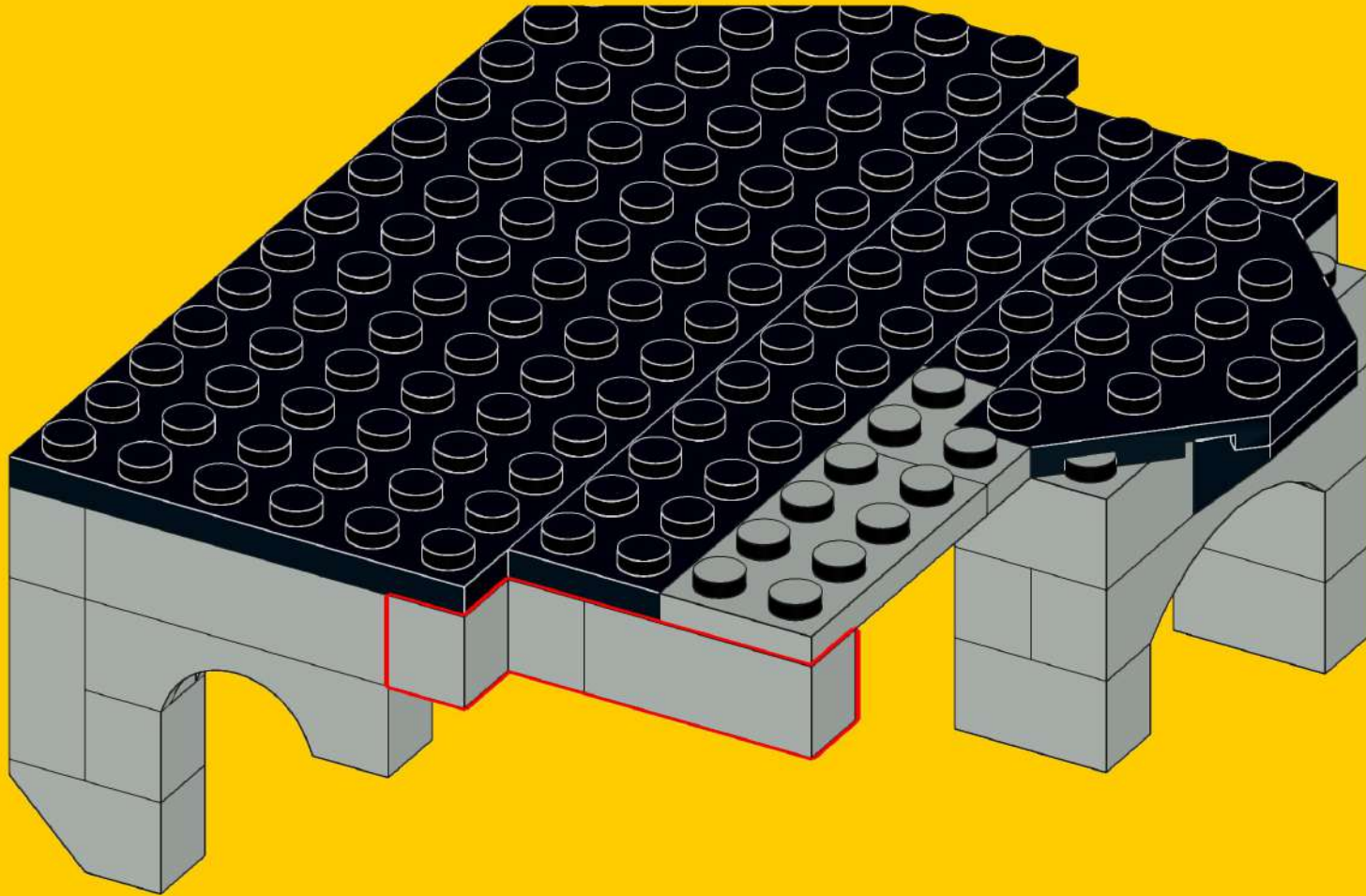

# 207

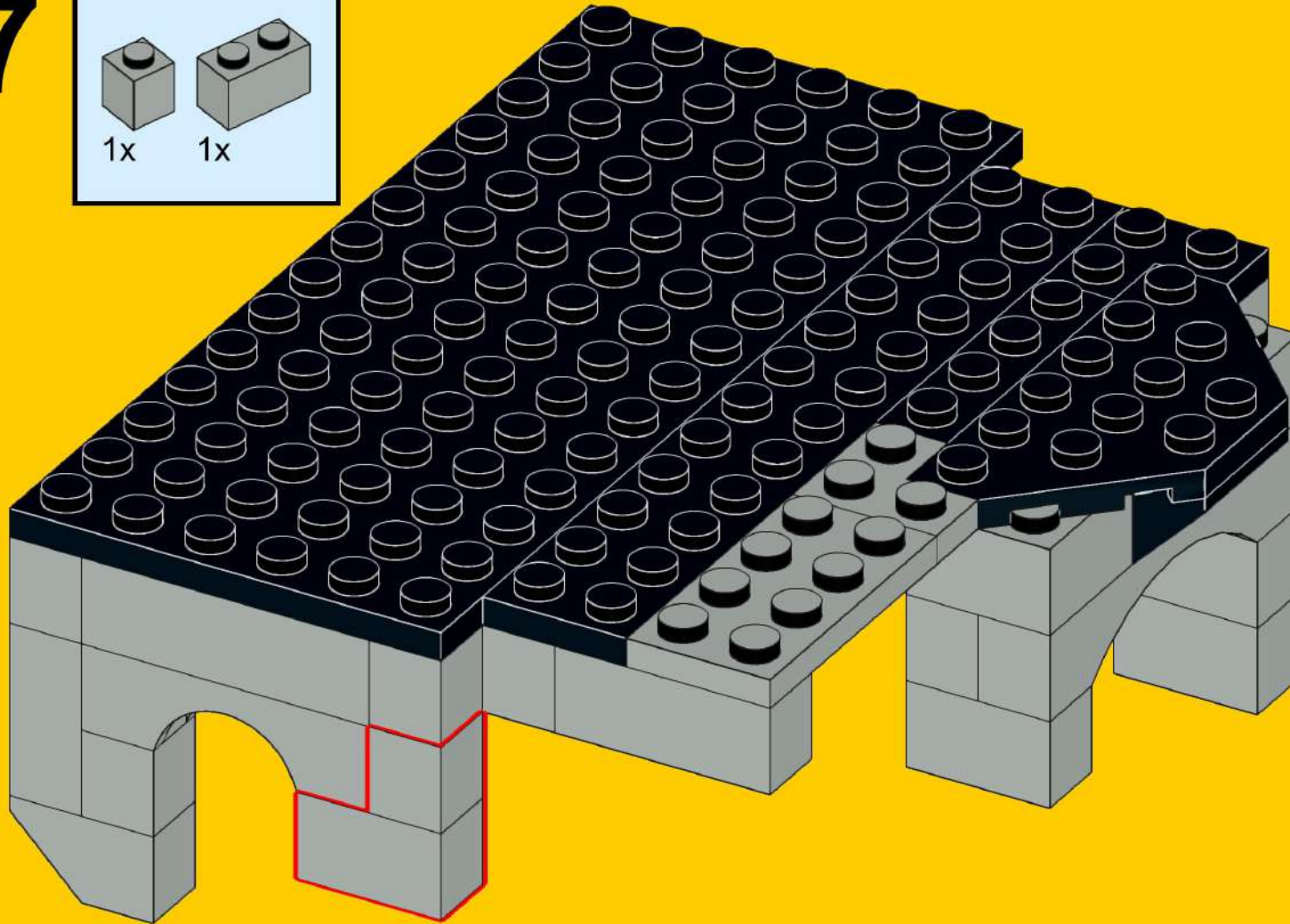
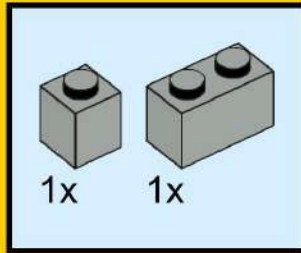

# 208

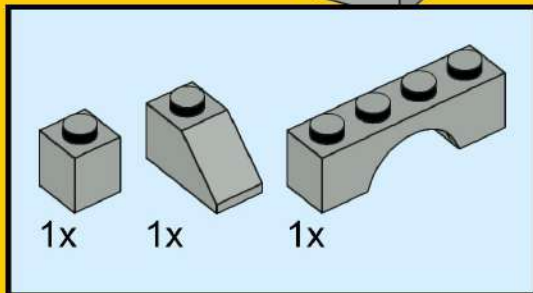
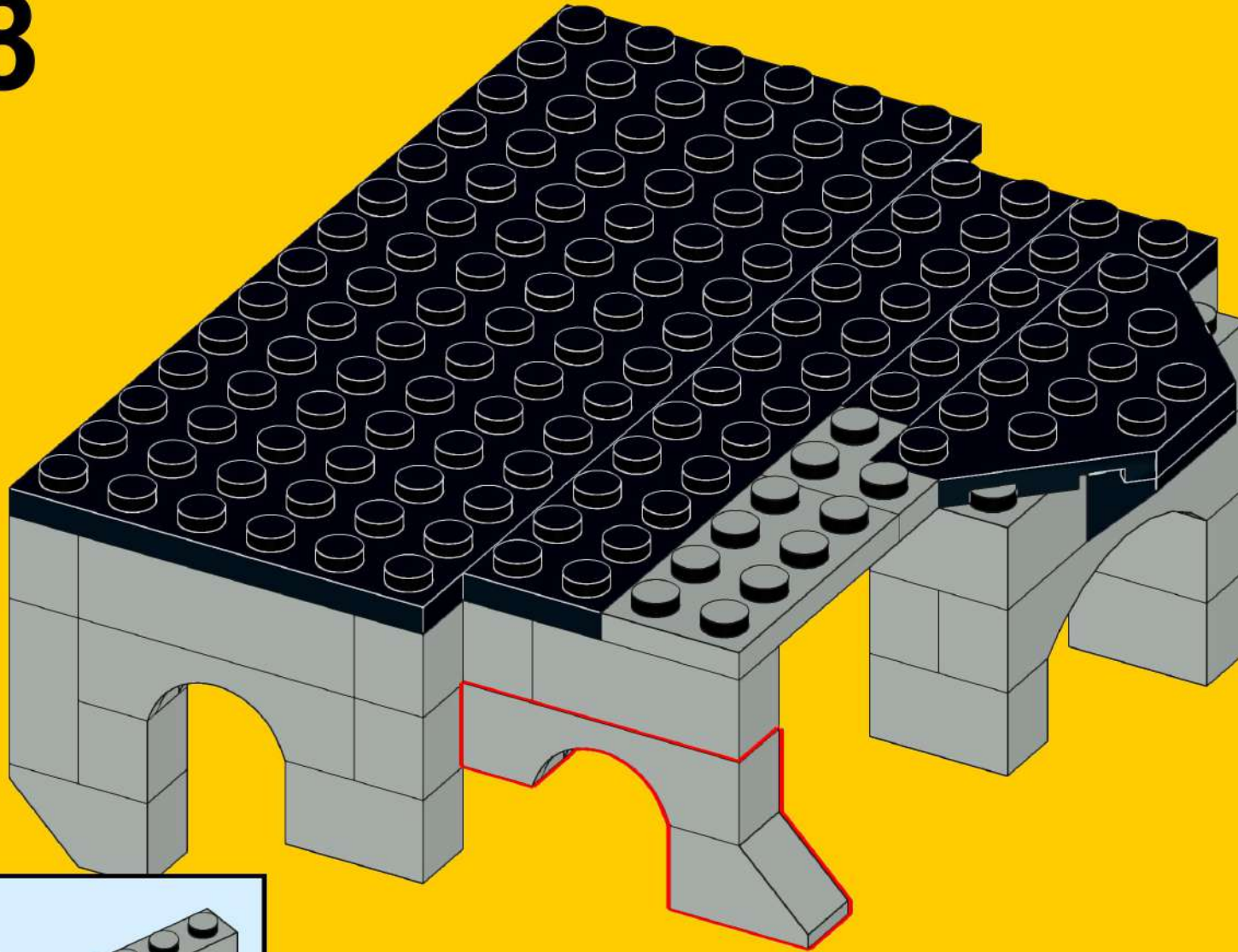

# 209

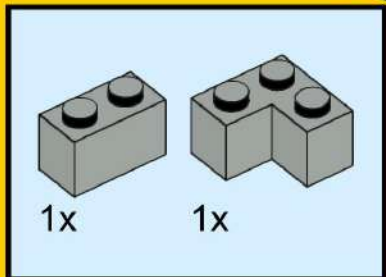
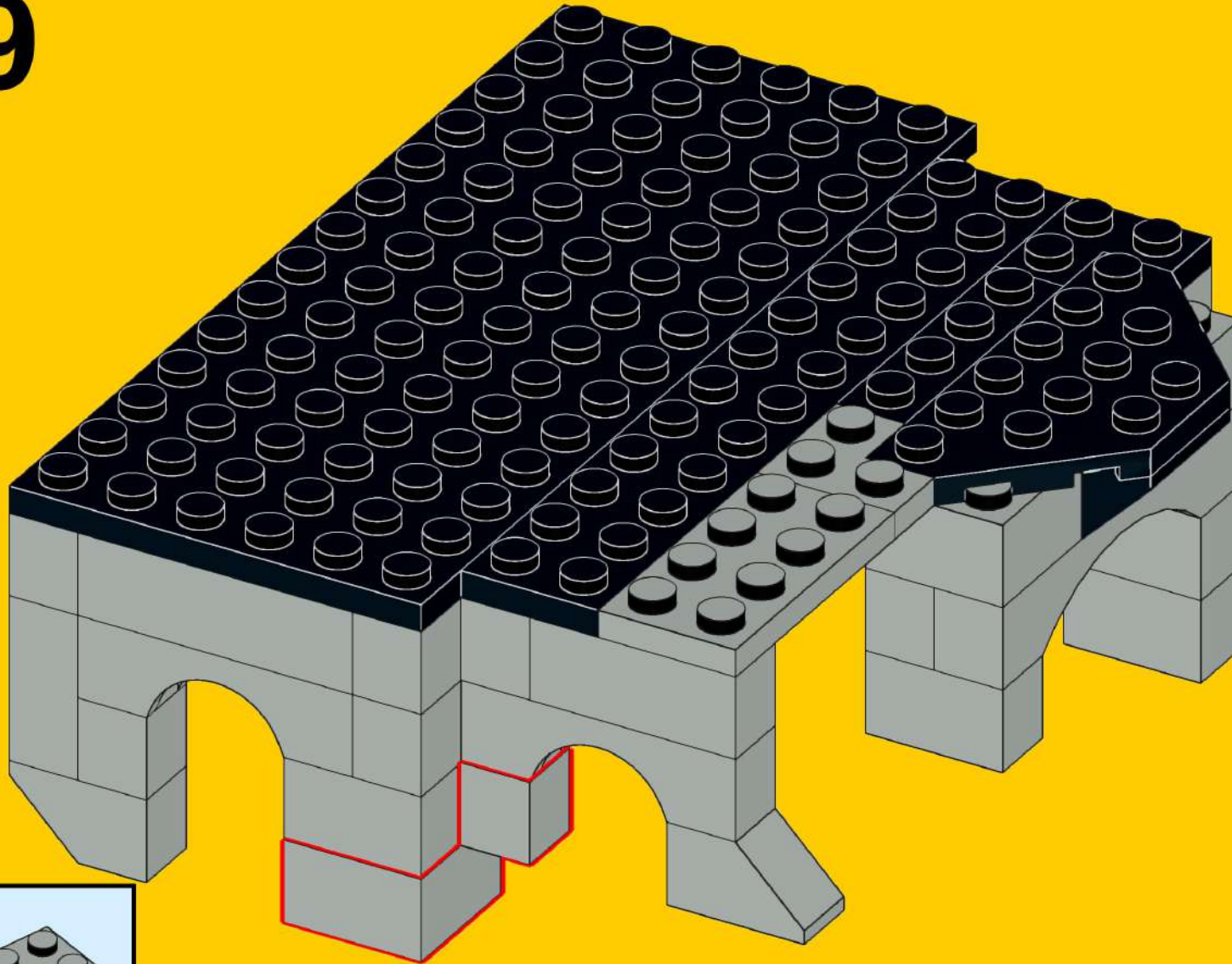



# 210

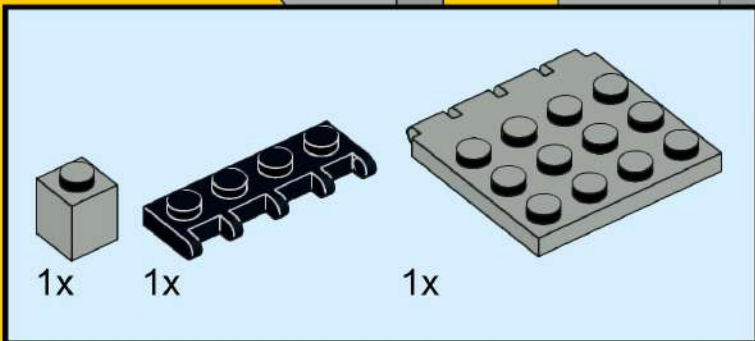
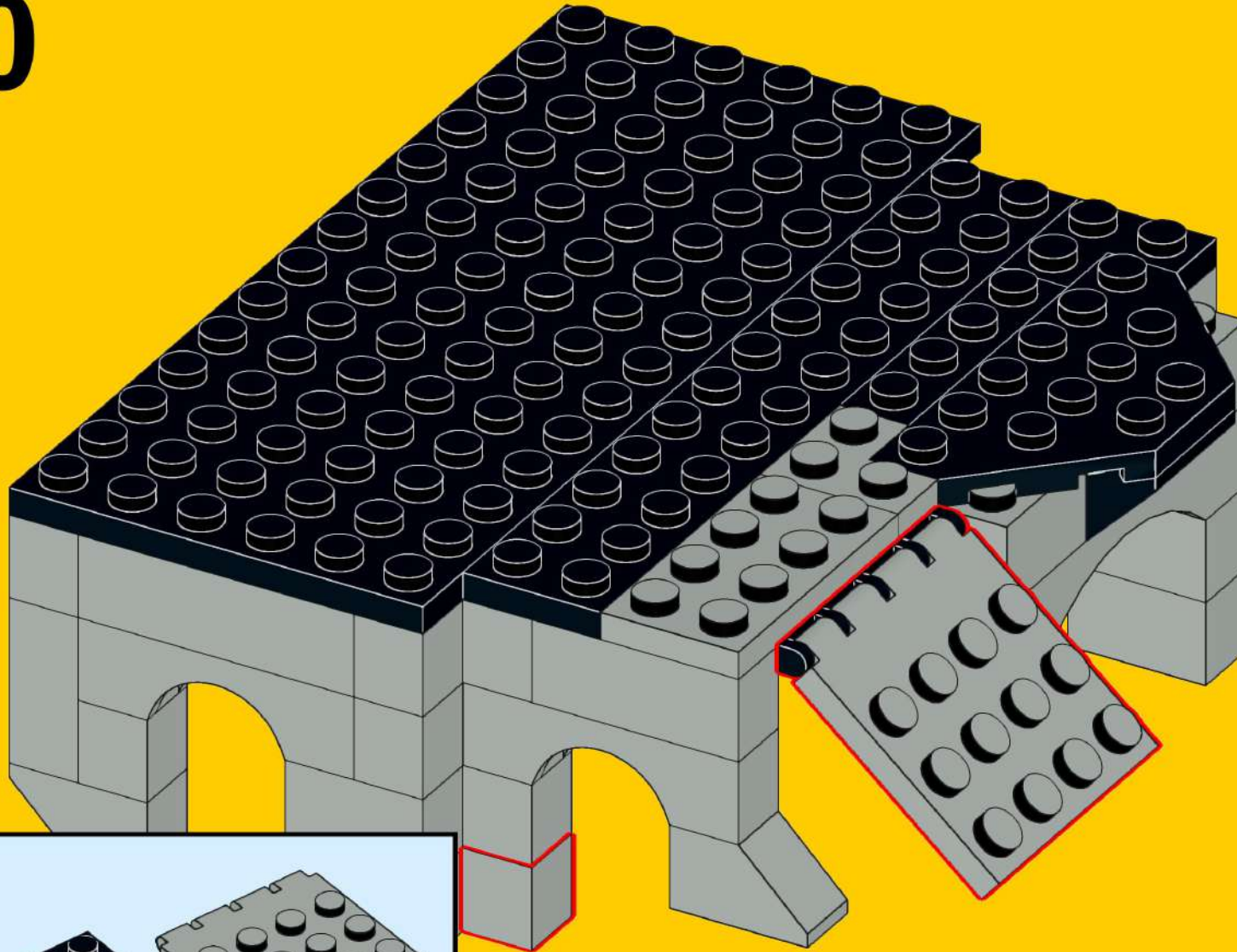

# 211

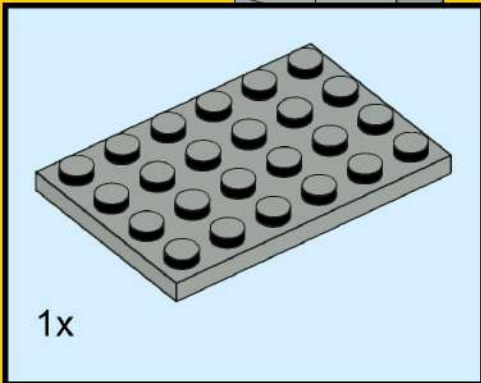
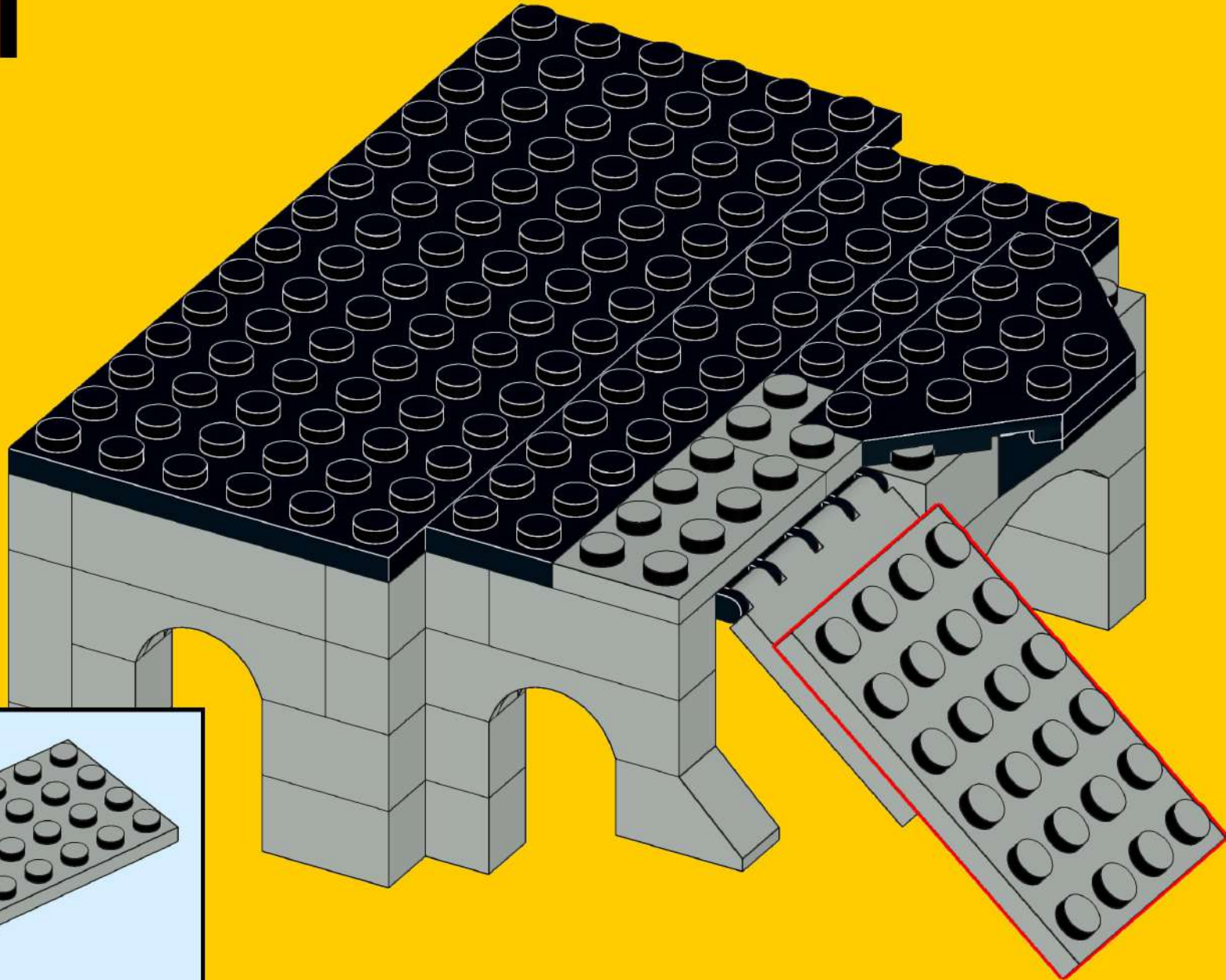

# 212

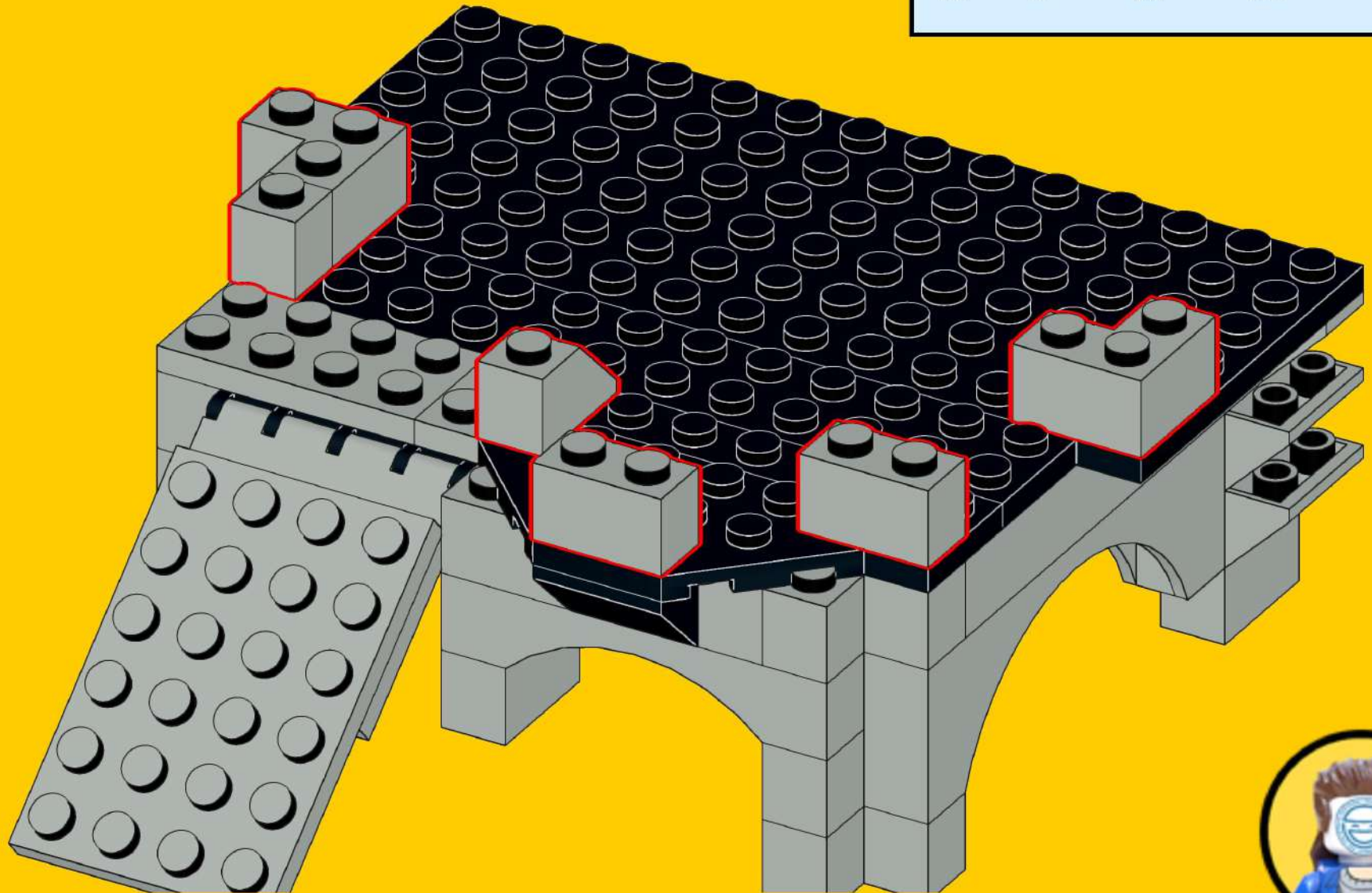
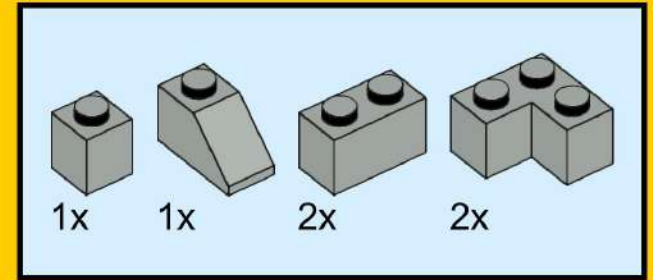

# 213

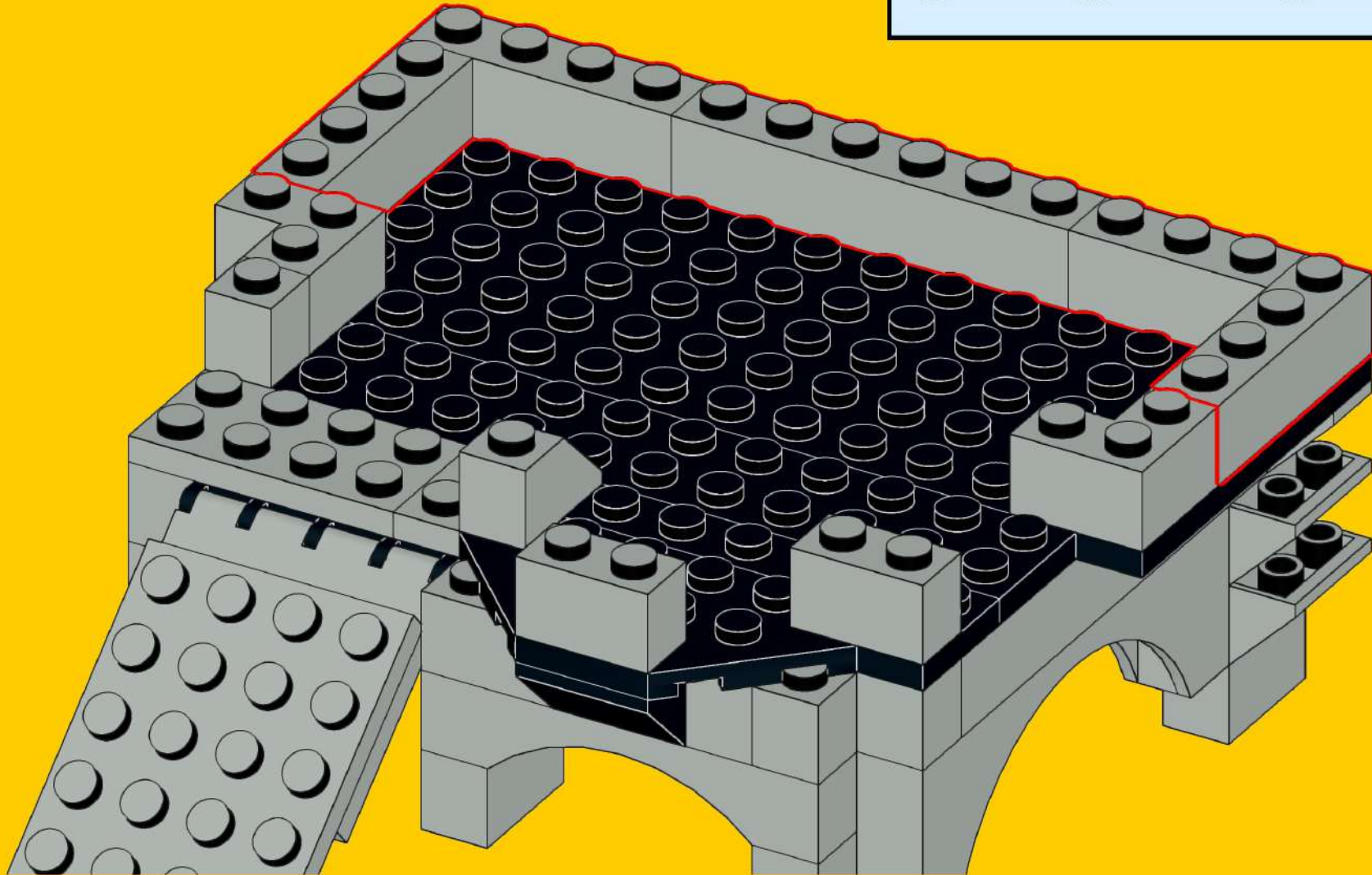
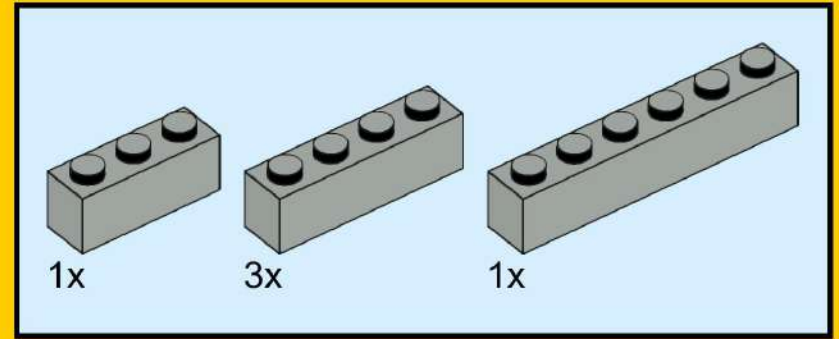

# 214

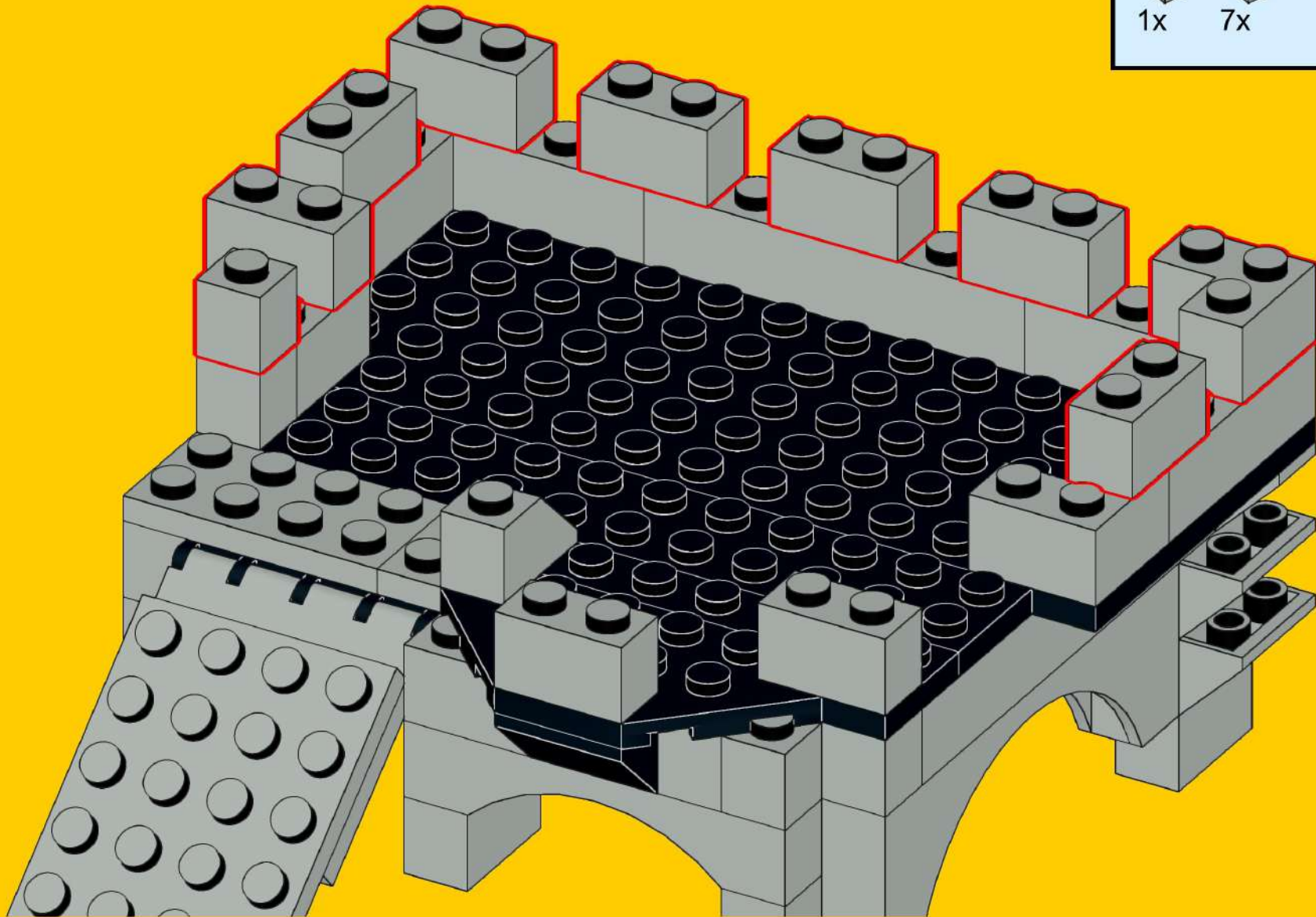
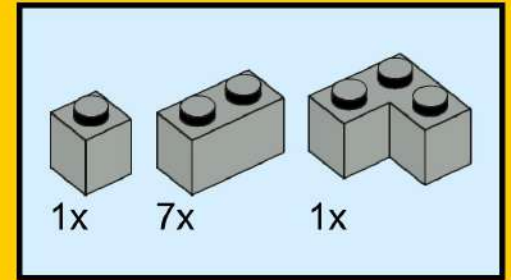

# 215

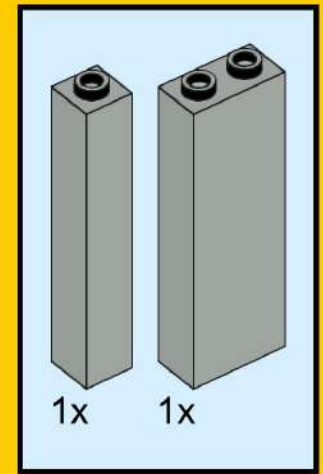
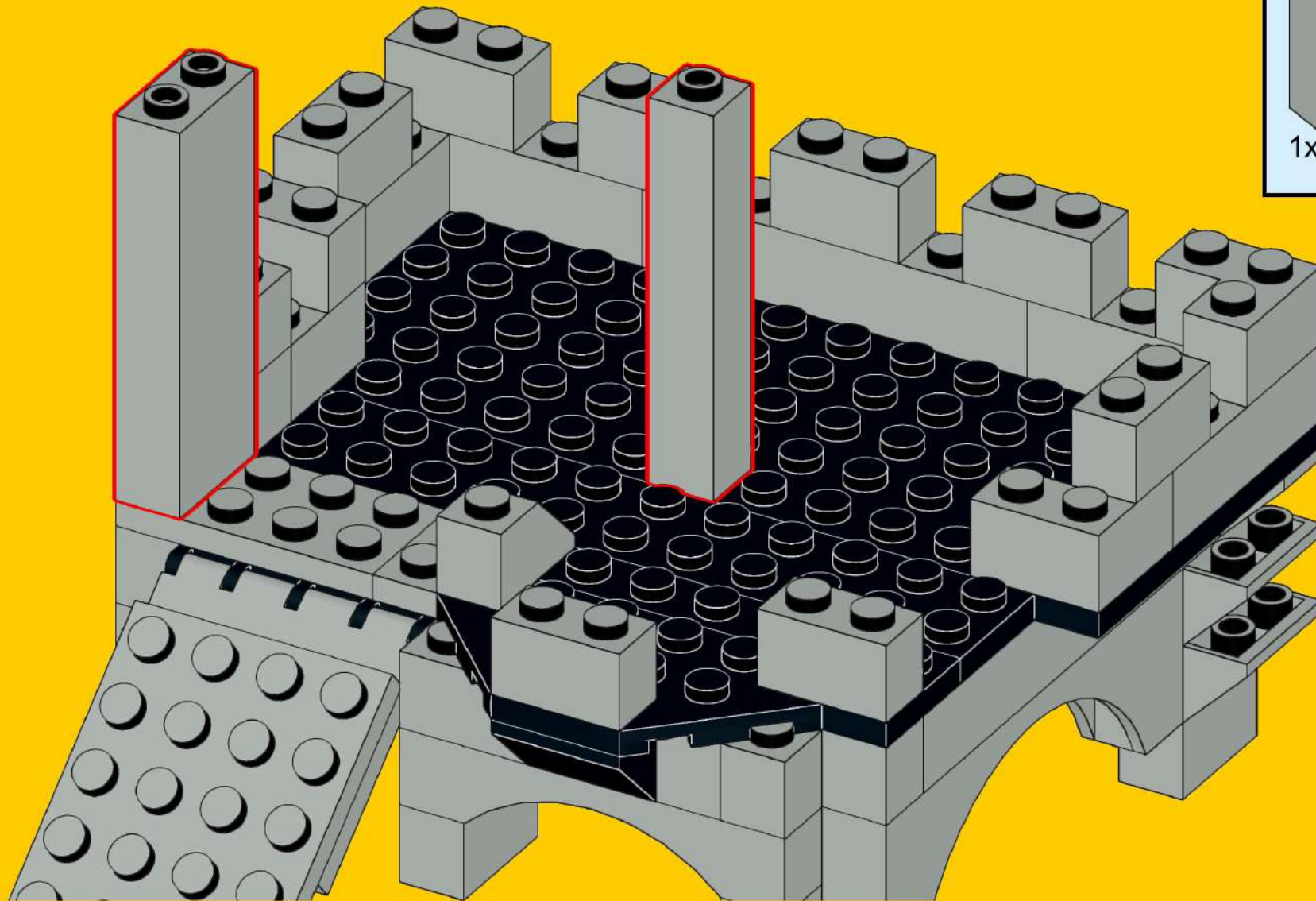

# 216

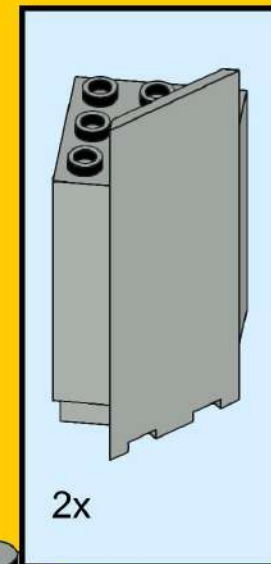
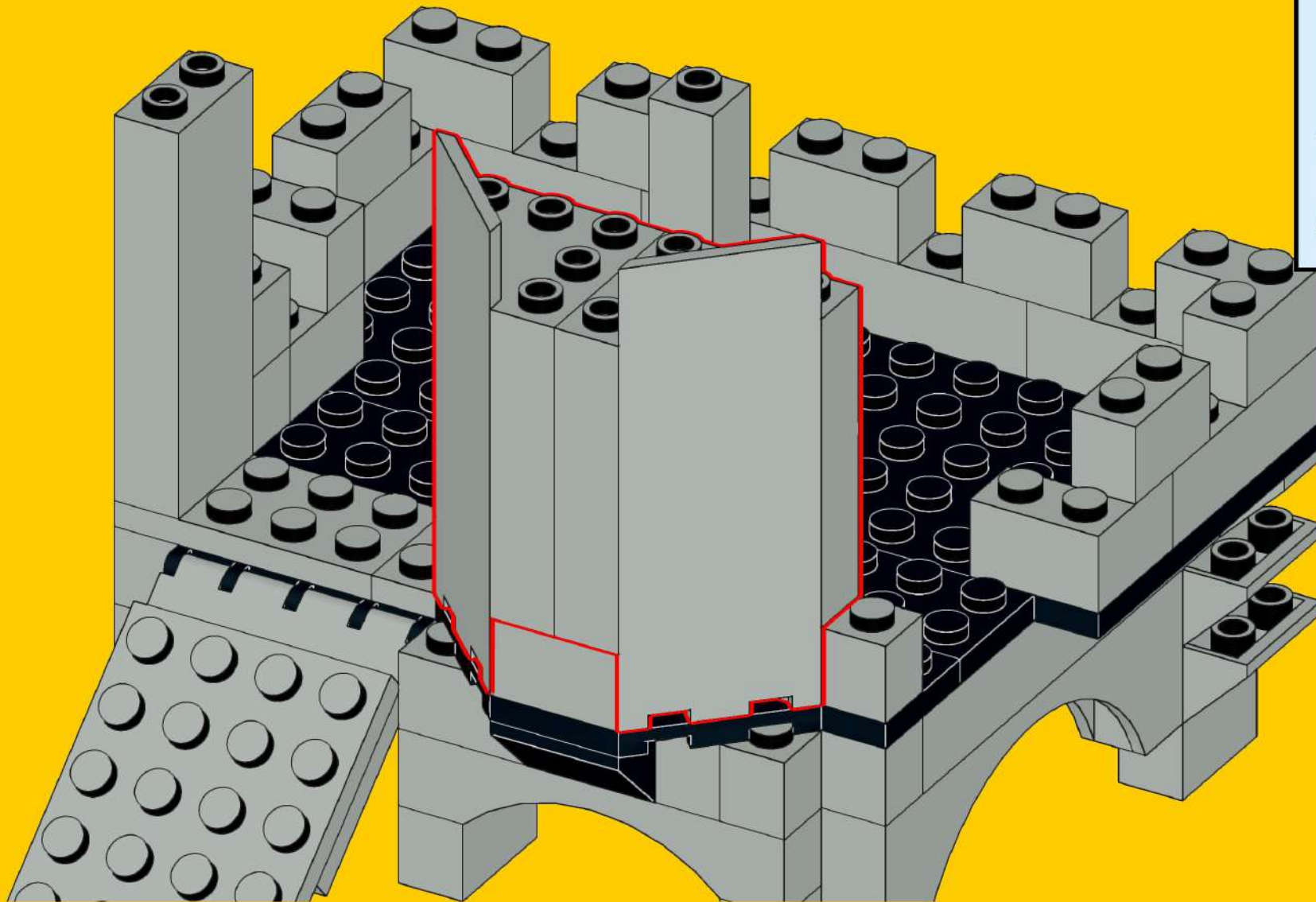

# 217

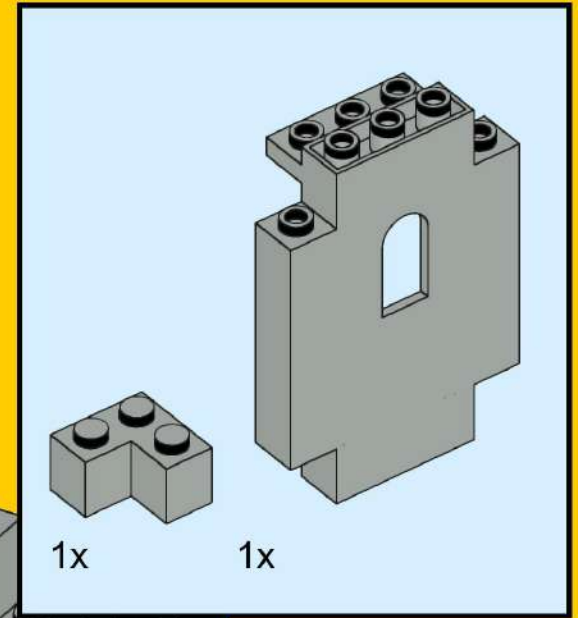
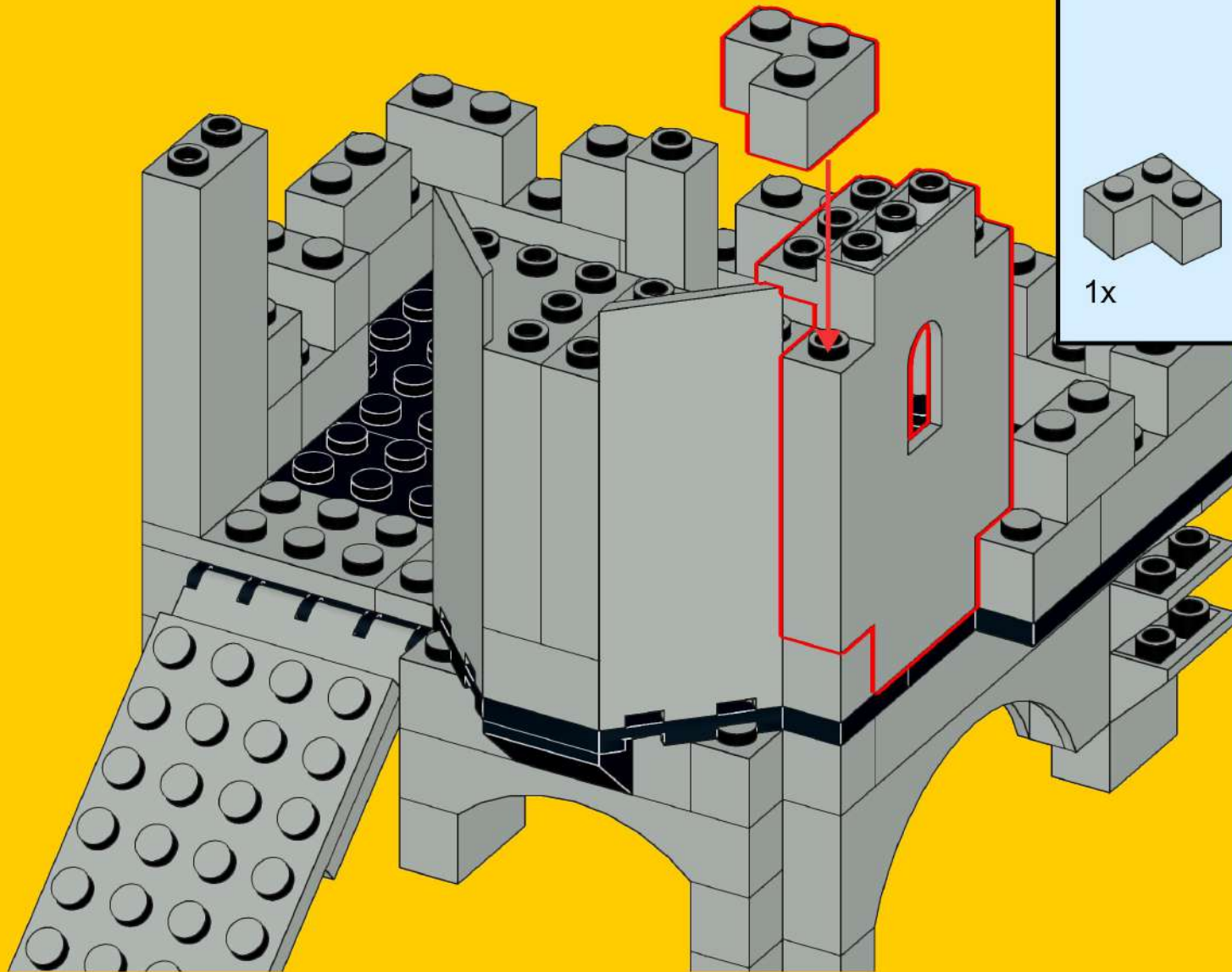



# 218

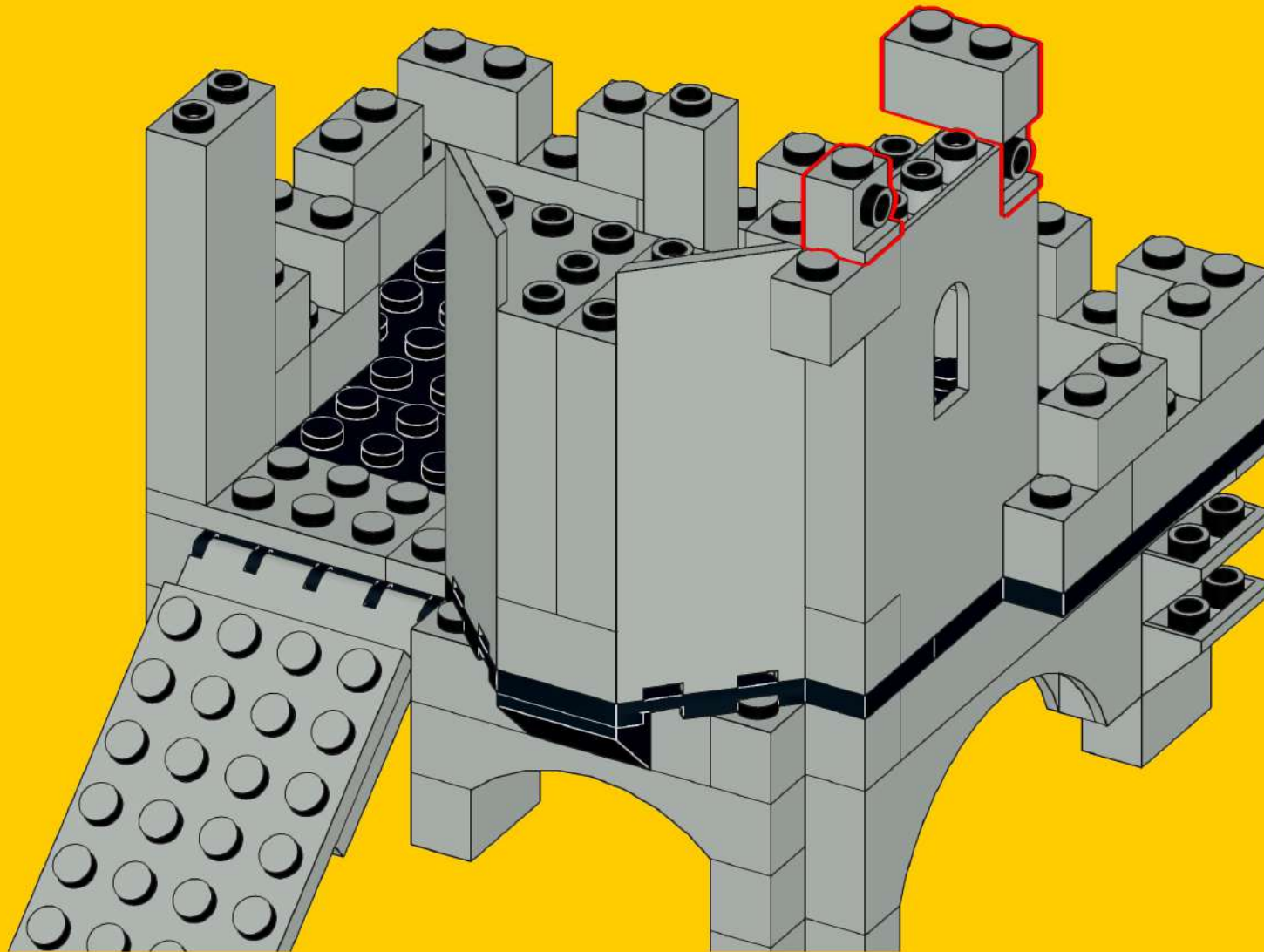
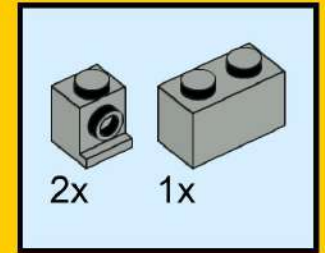

# 219

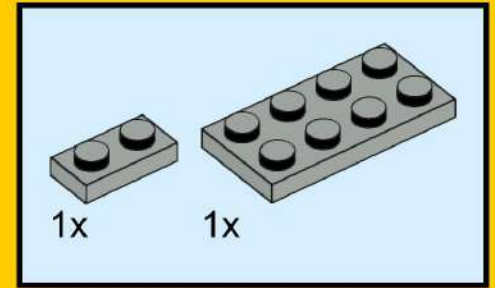
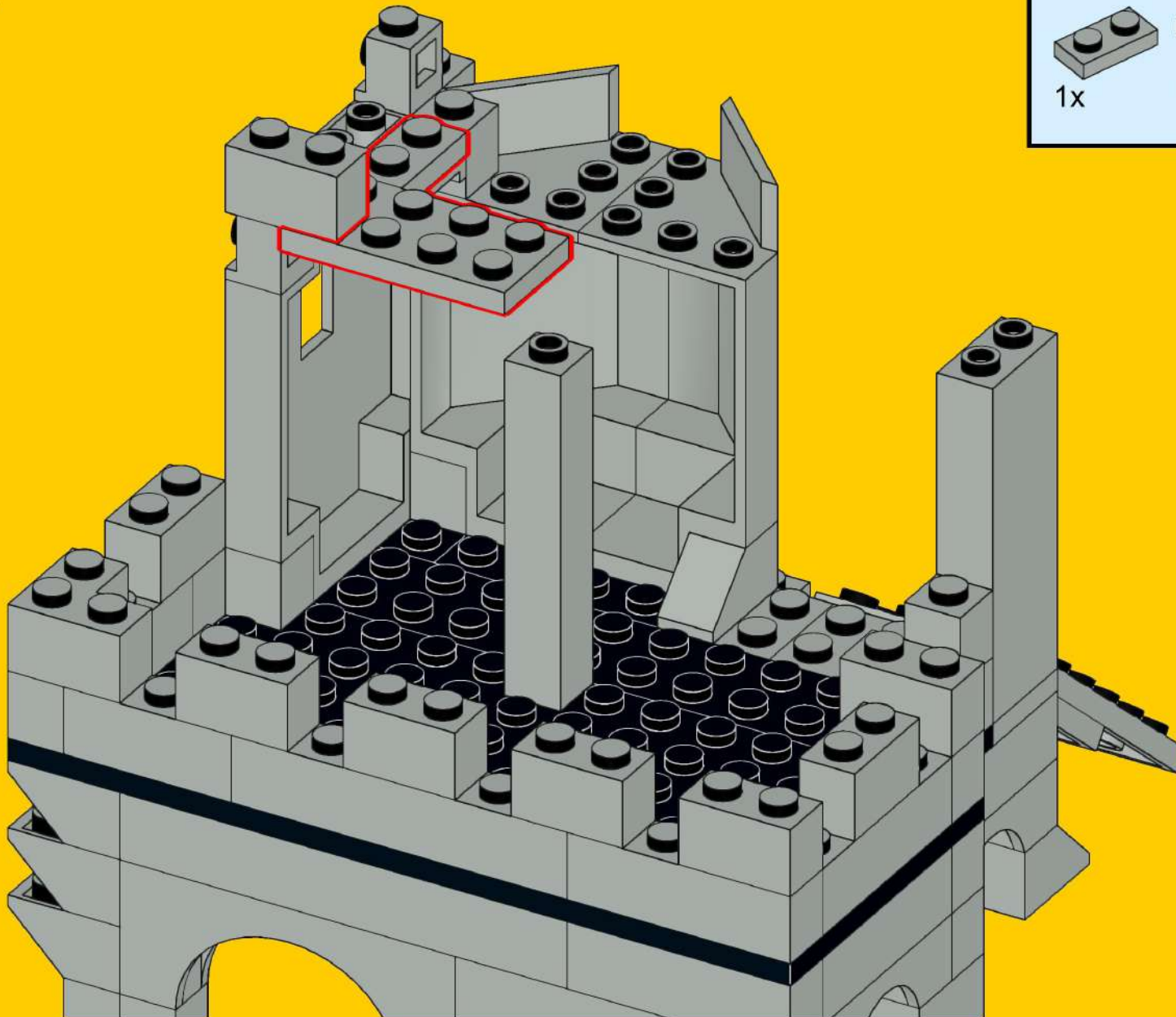

# 220

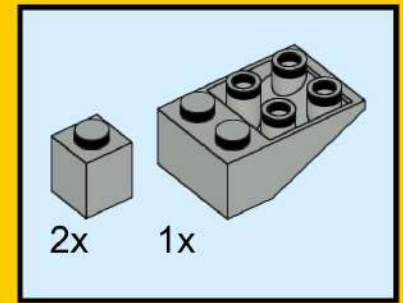
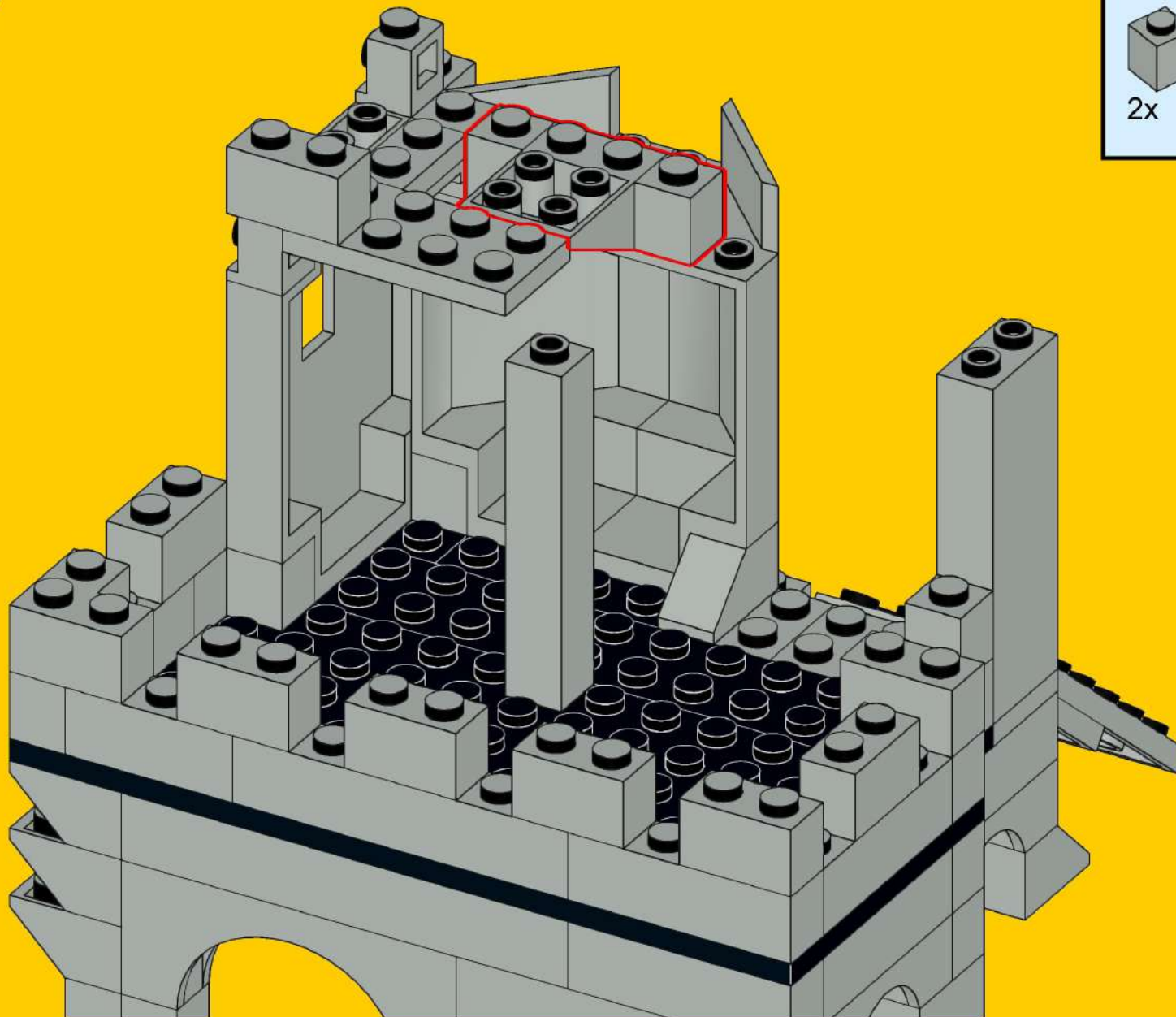

# 221

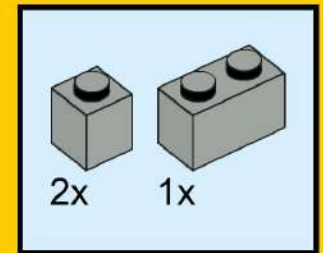
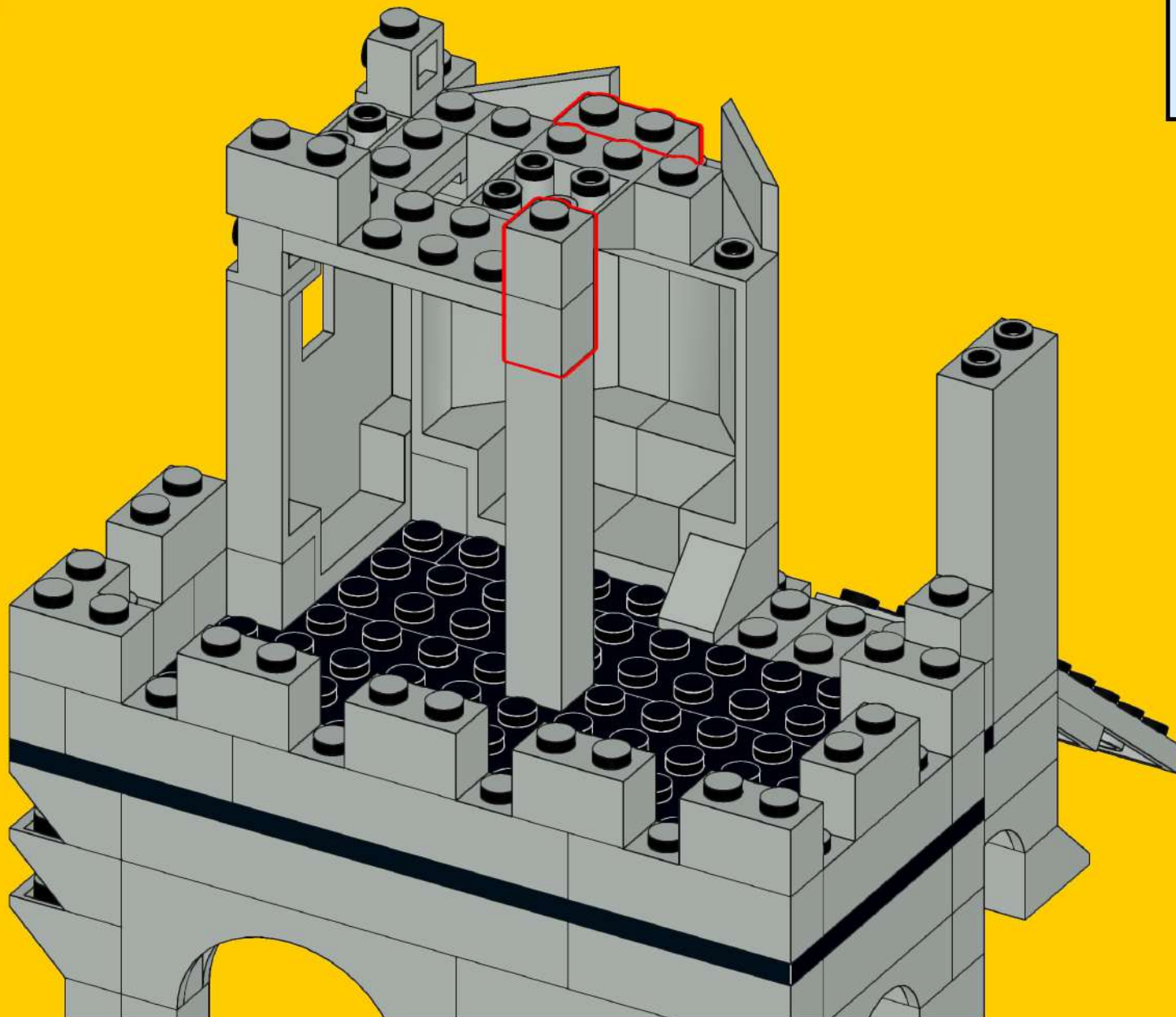

# 222

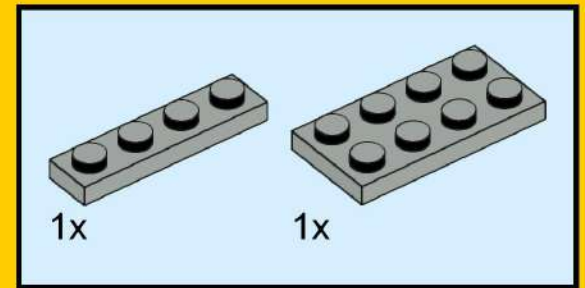
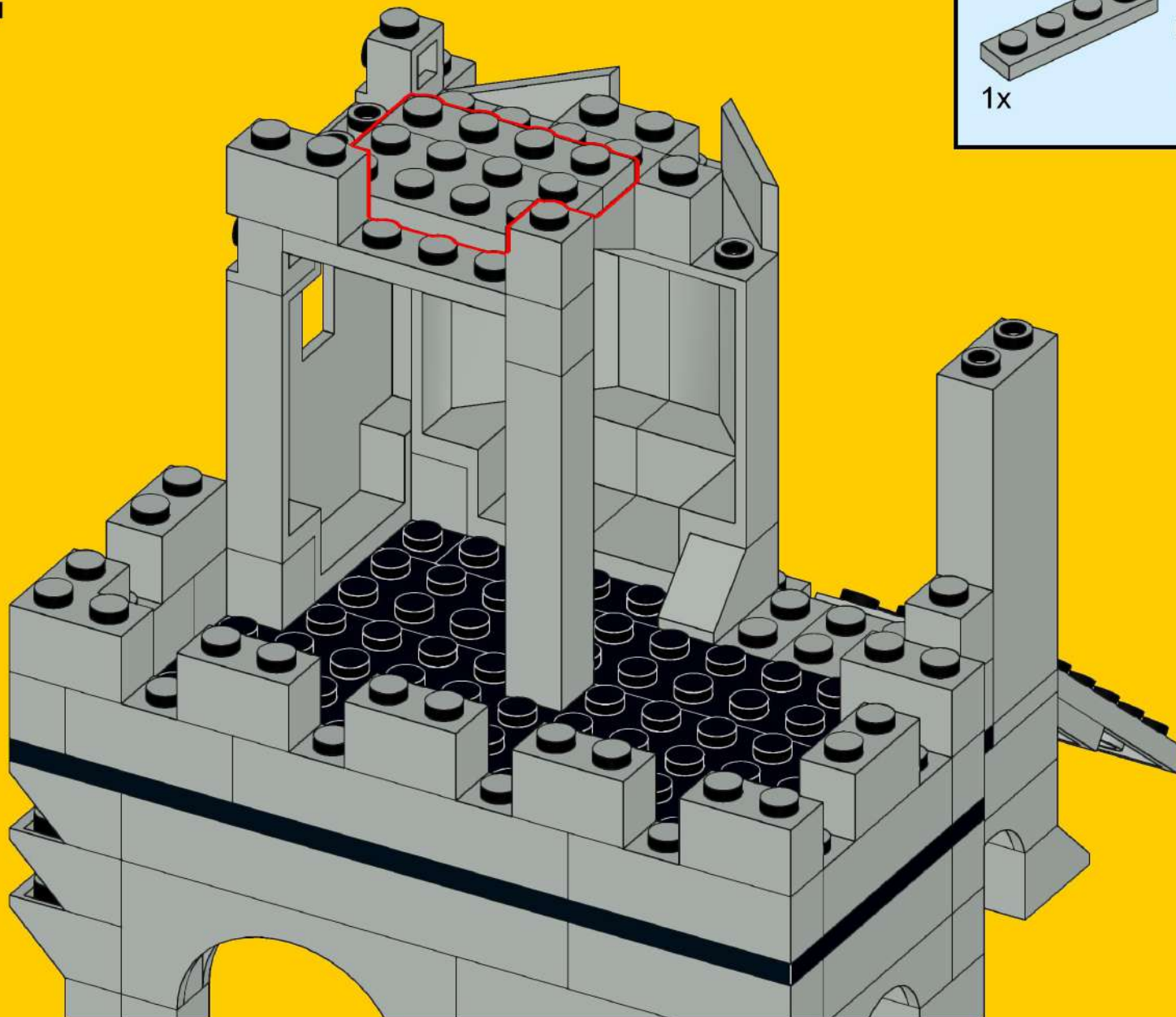

# 223

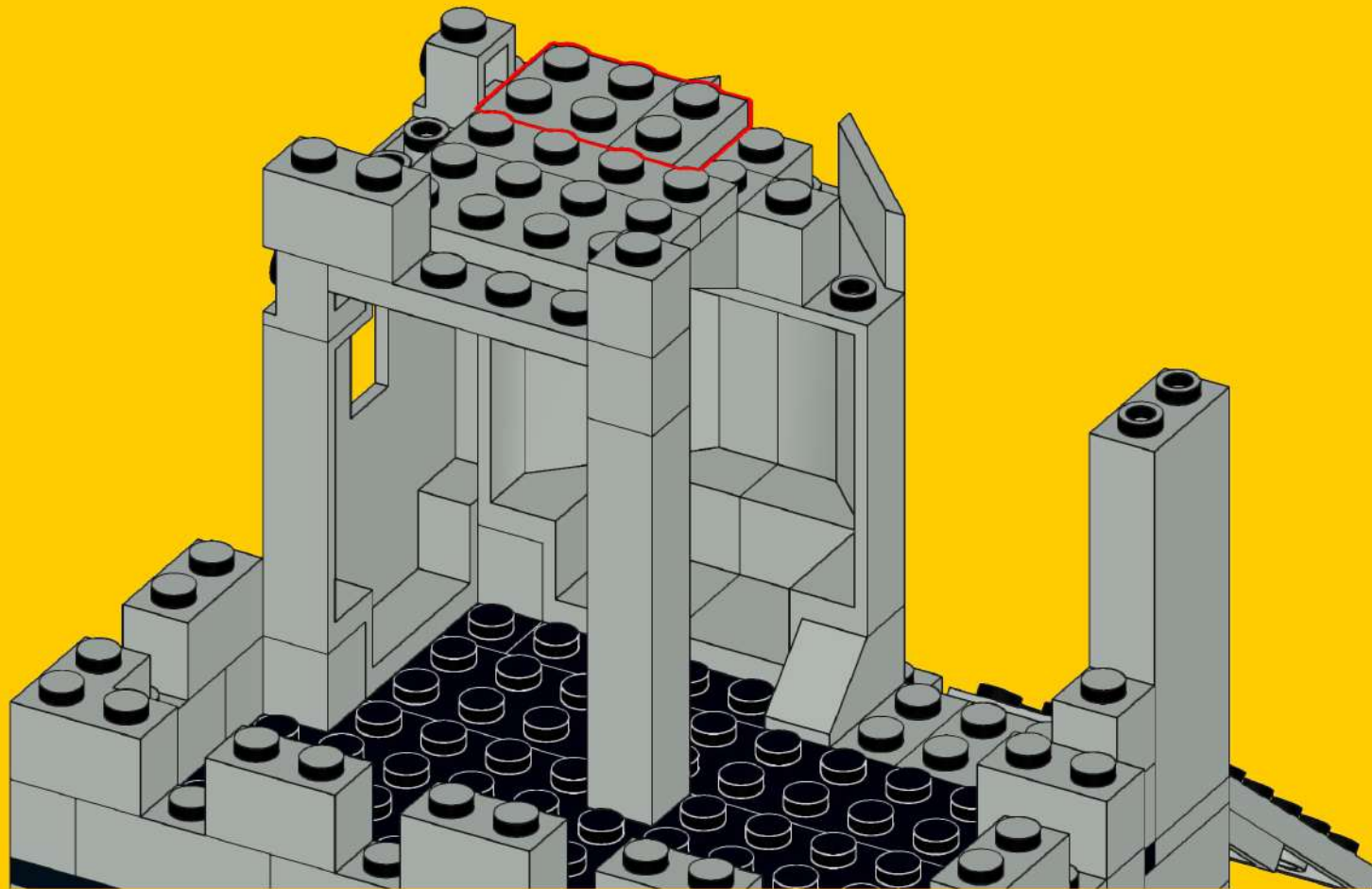
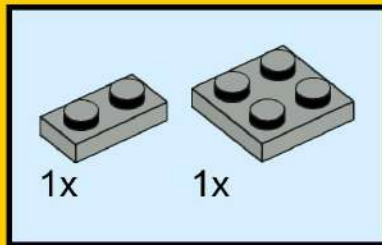

# 224

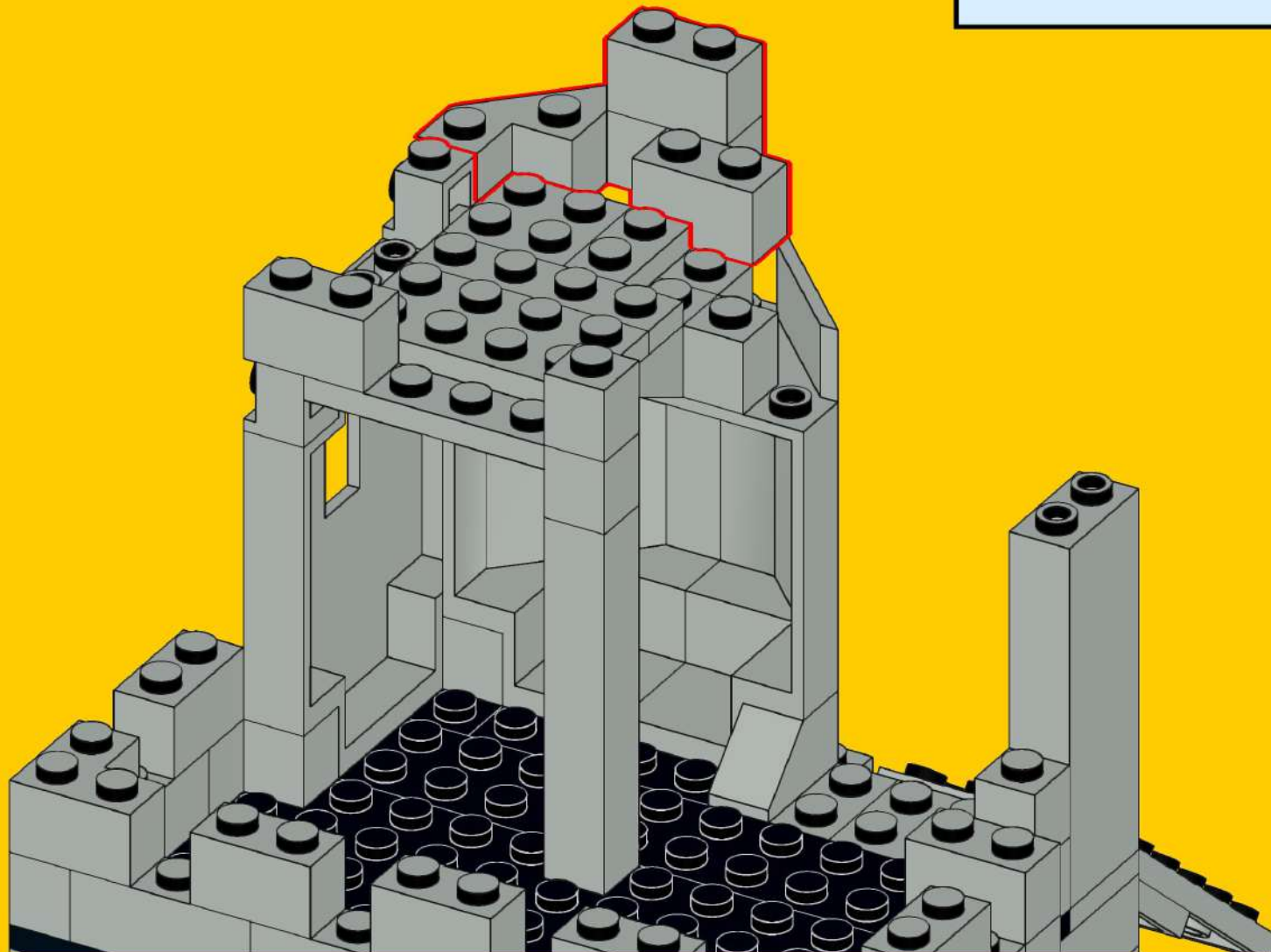
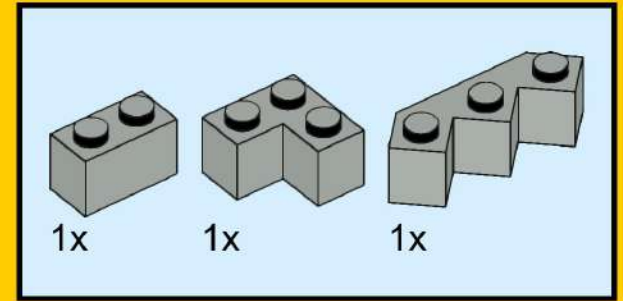

# 225

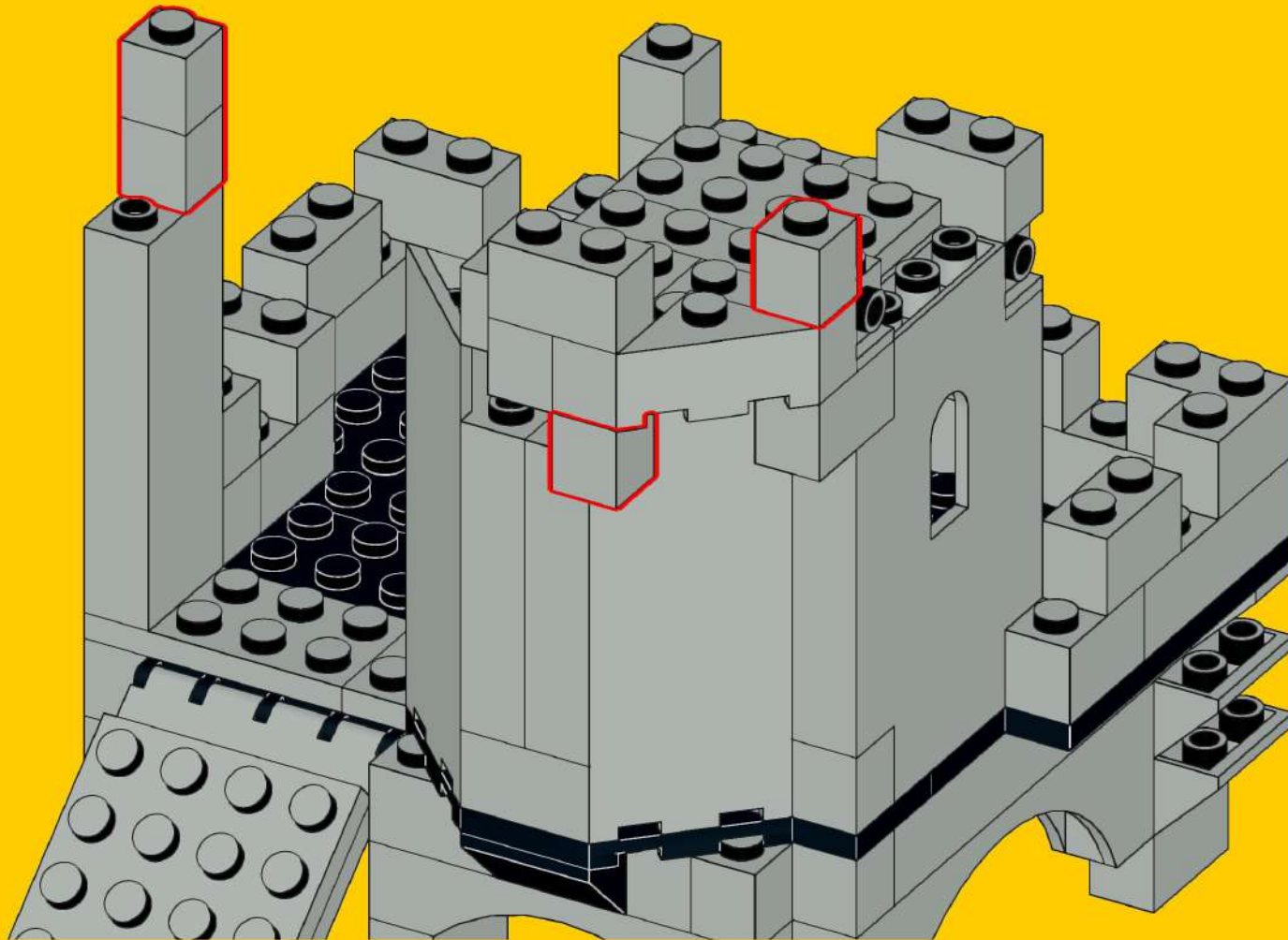
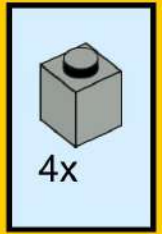



# 226

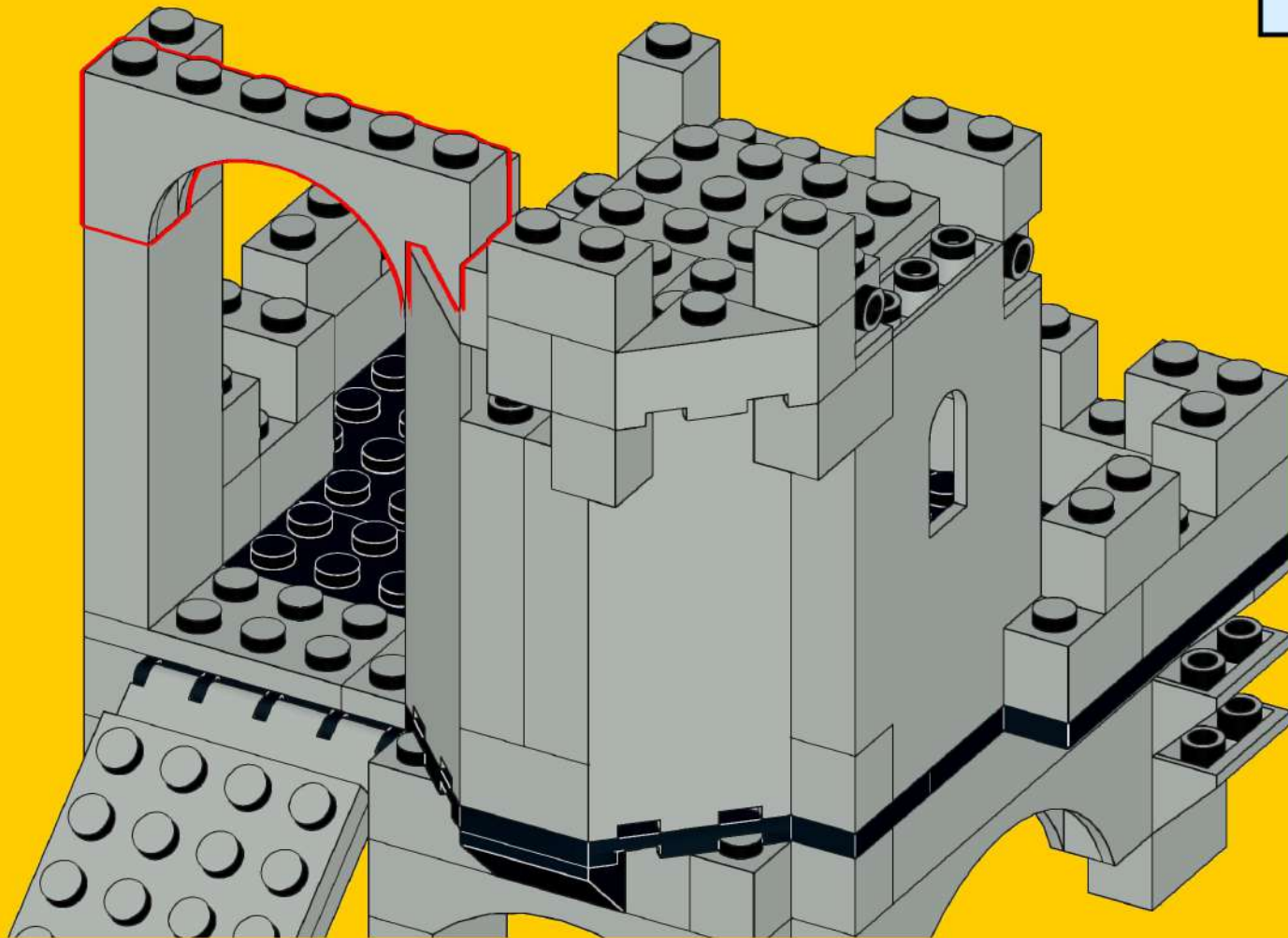
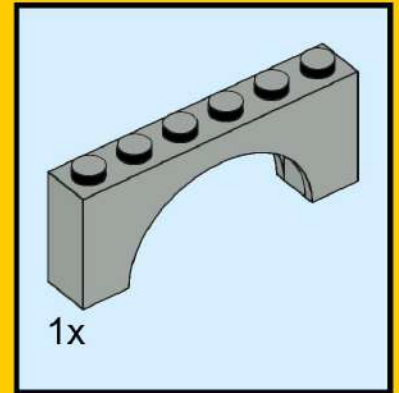

# 227

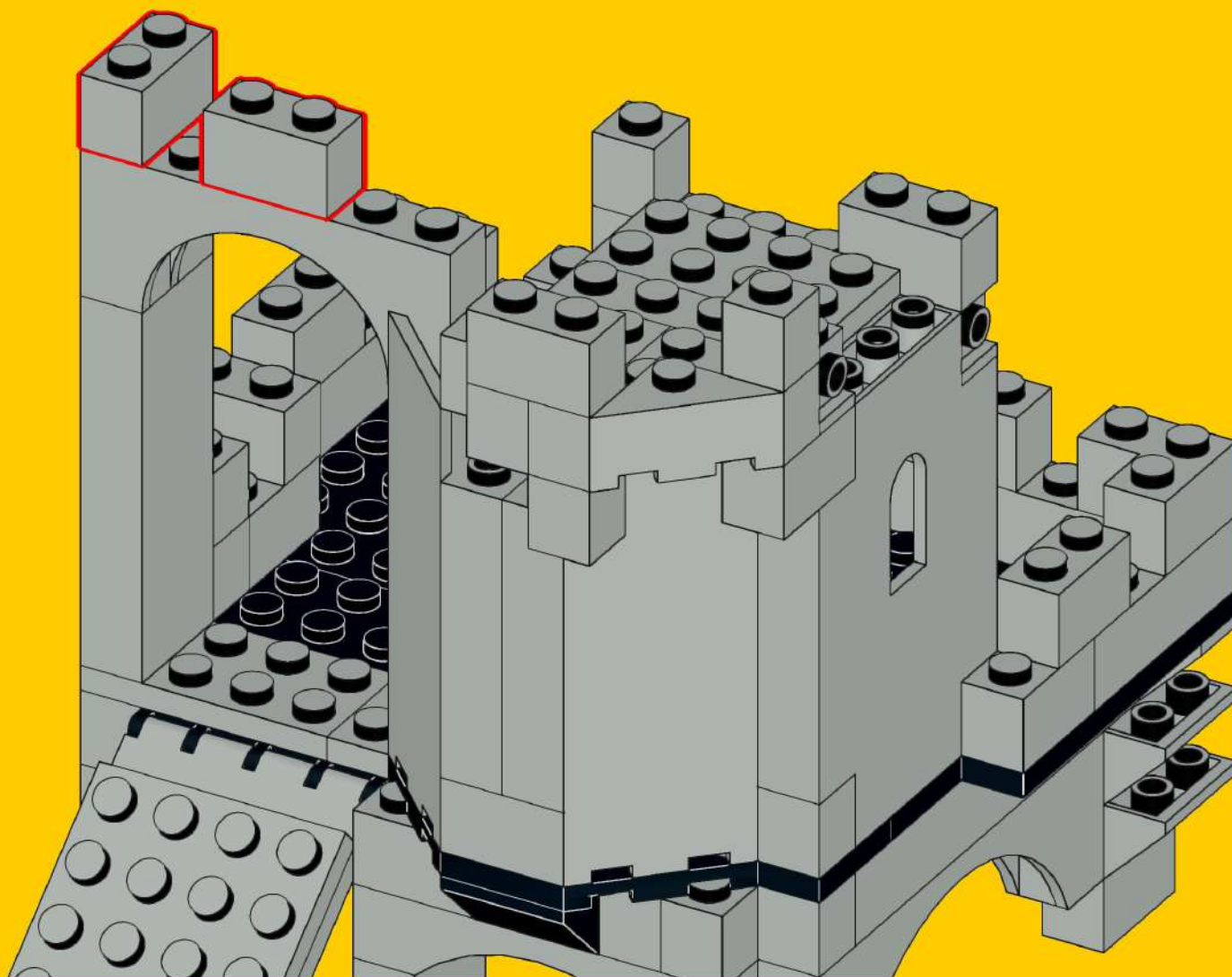
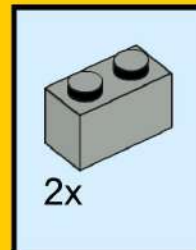

# 228

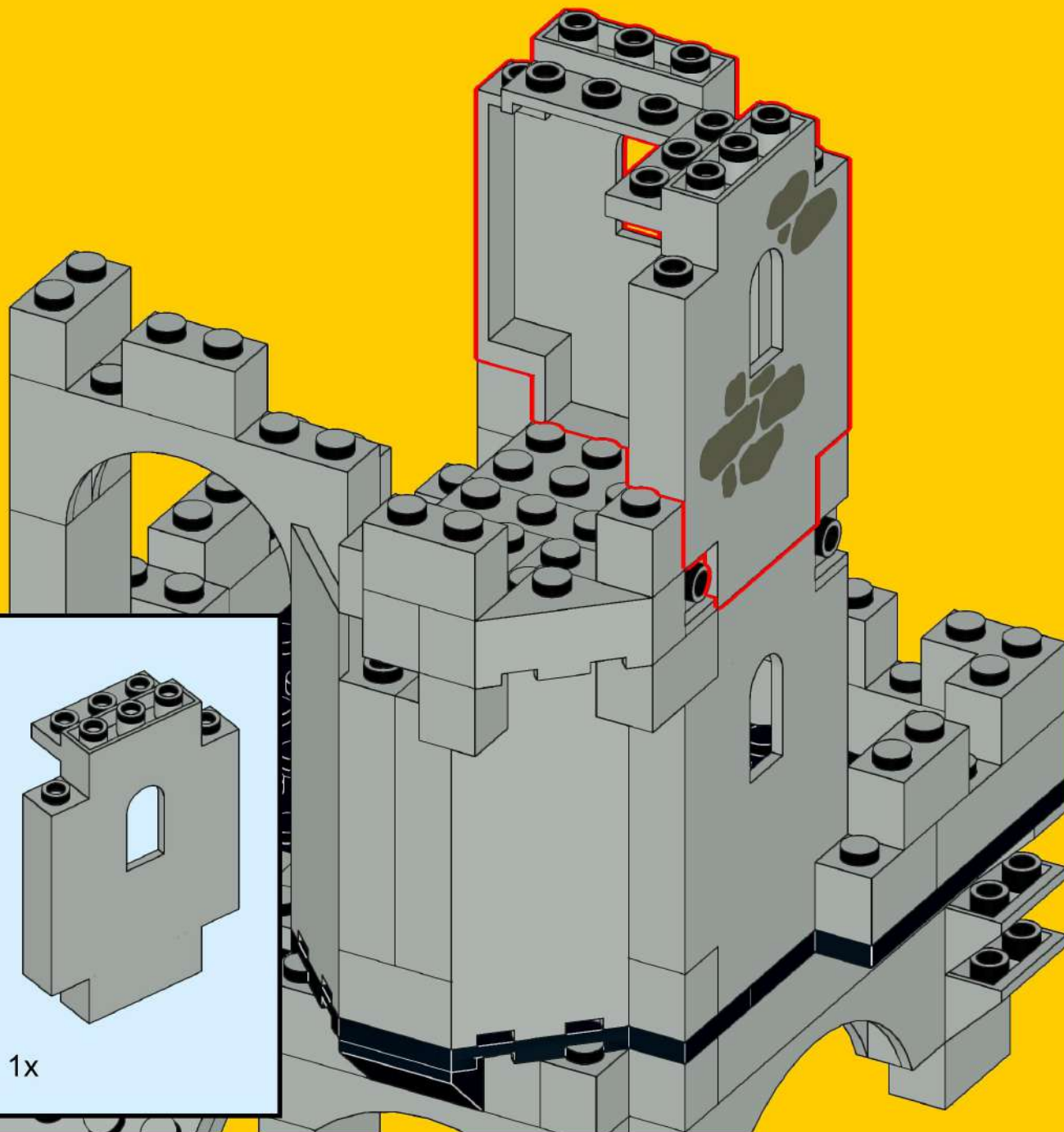
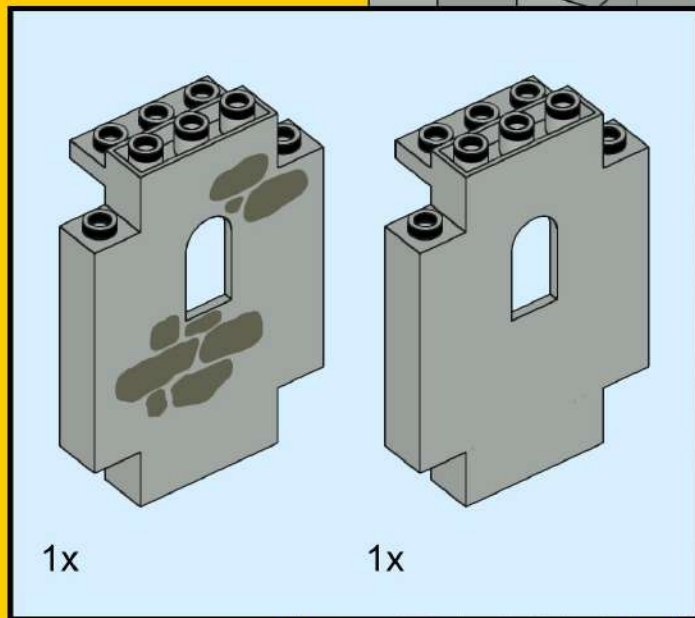

# 229

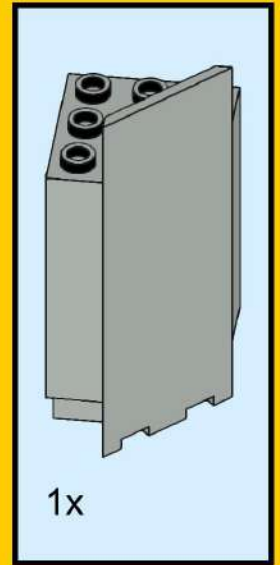
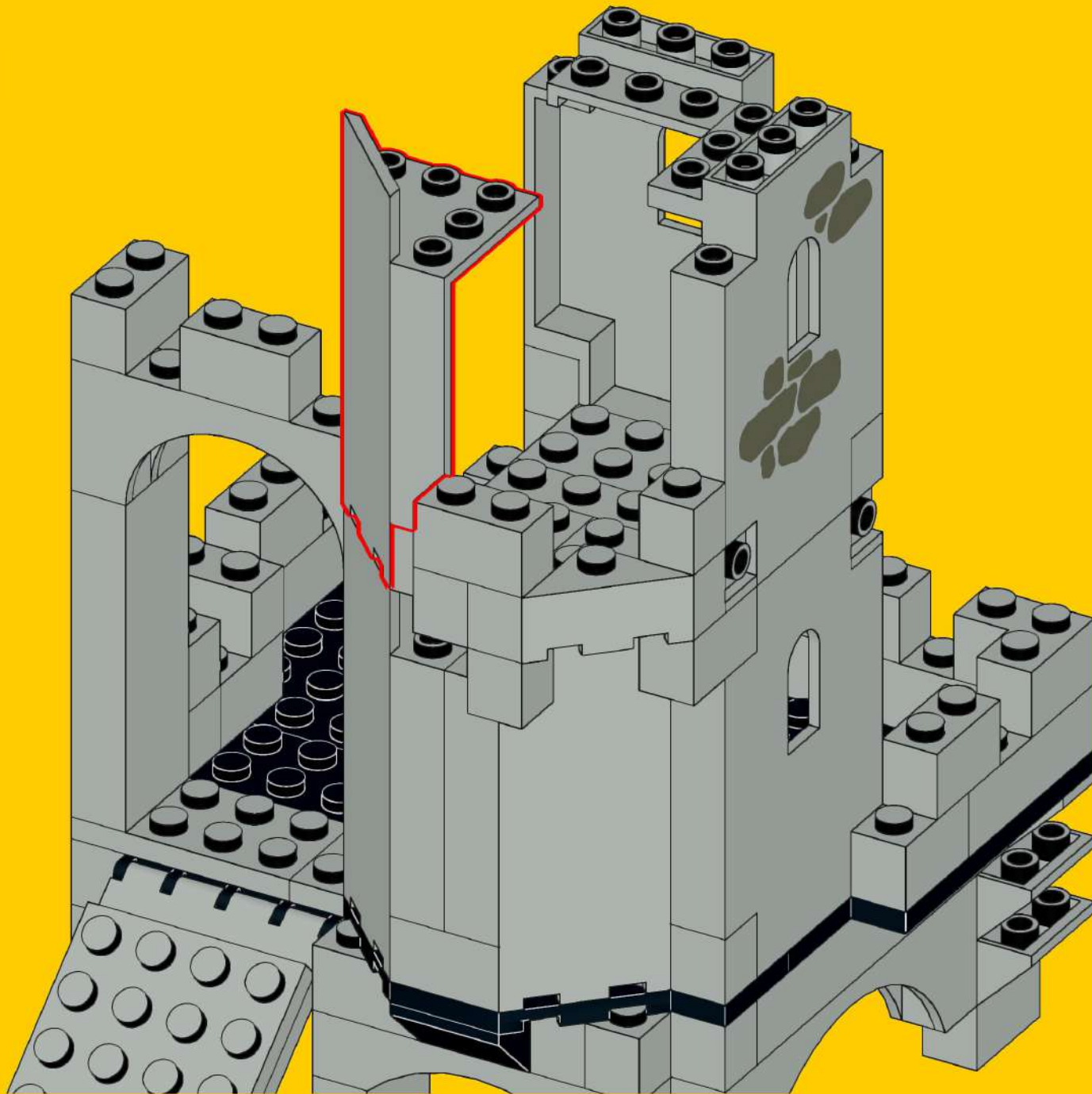

# 230

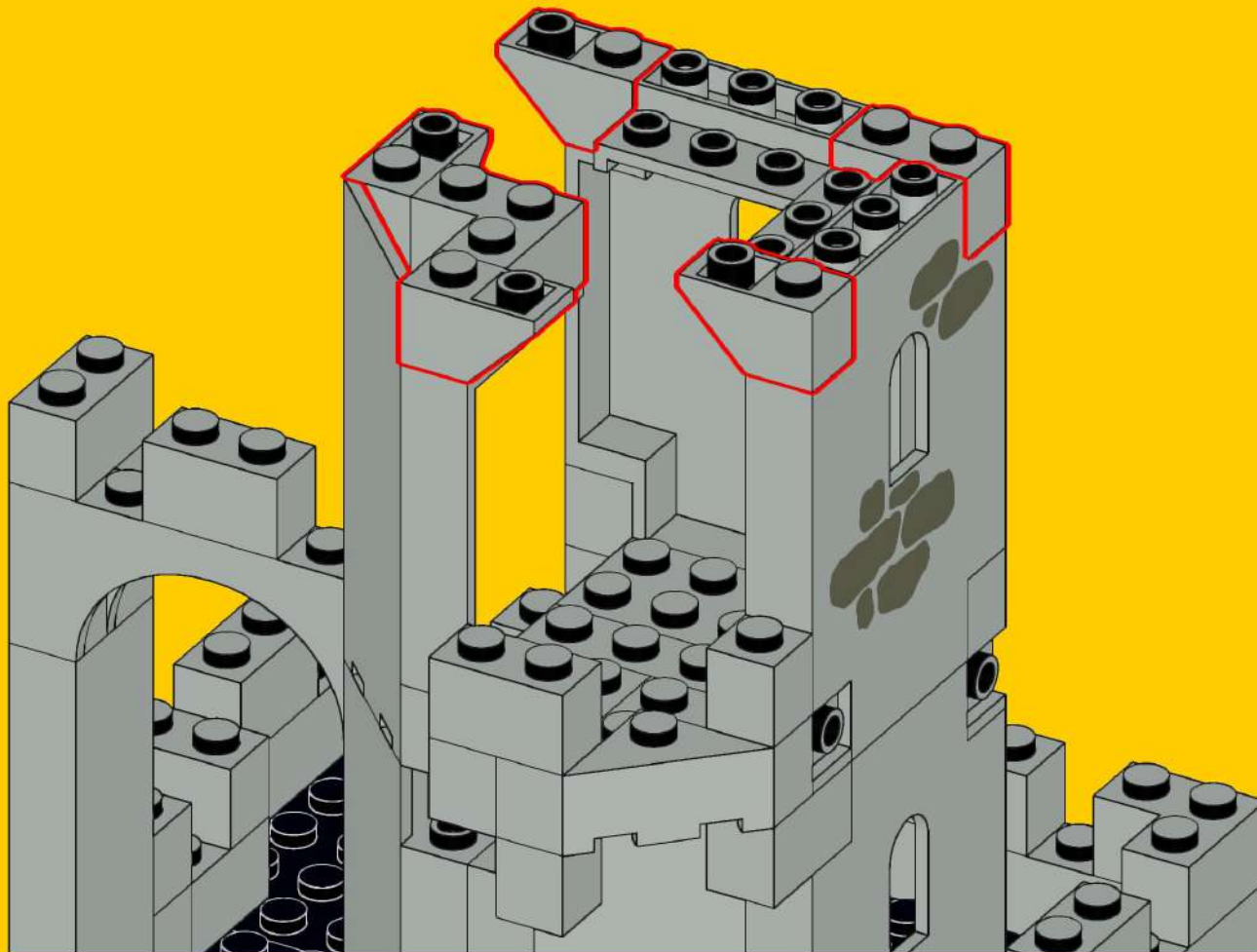
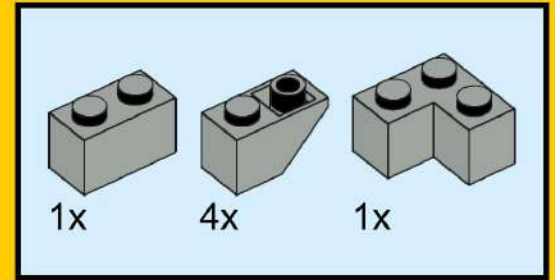

# 231

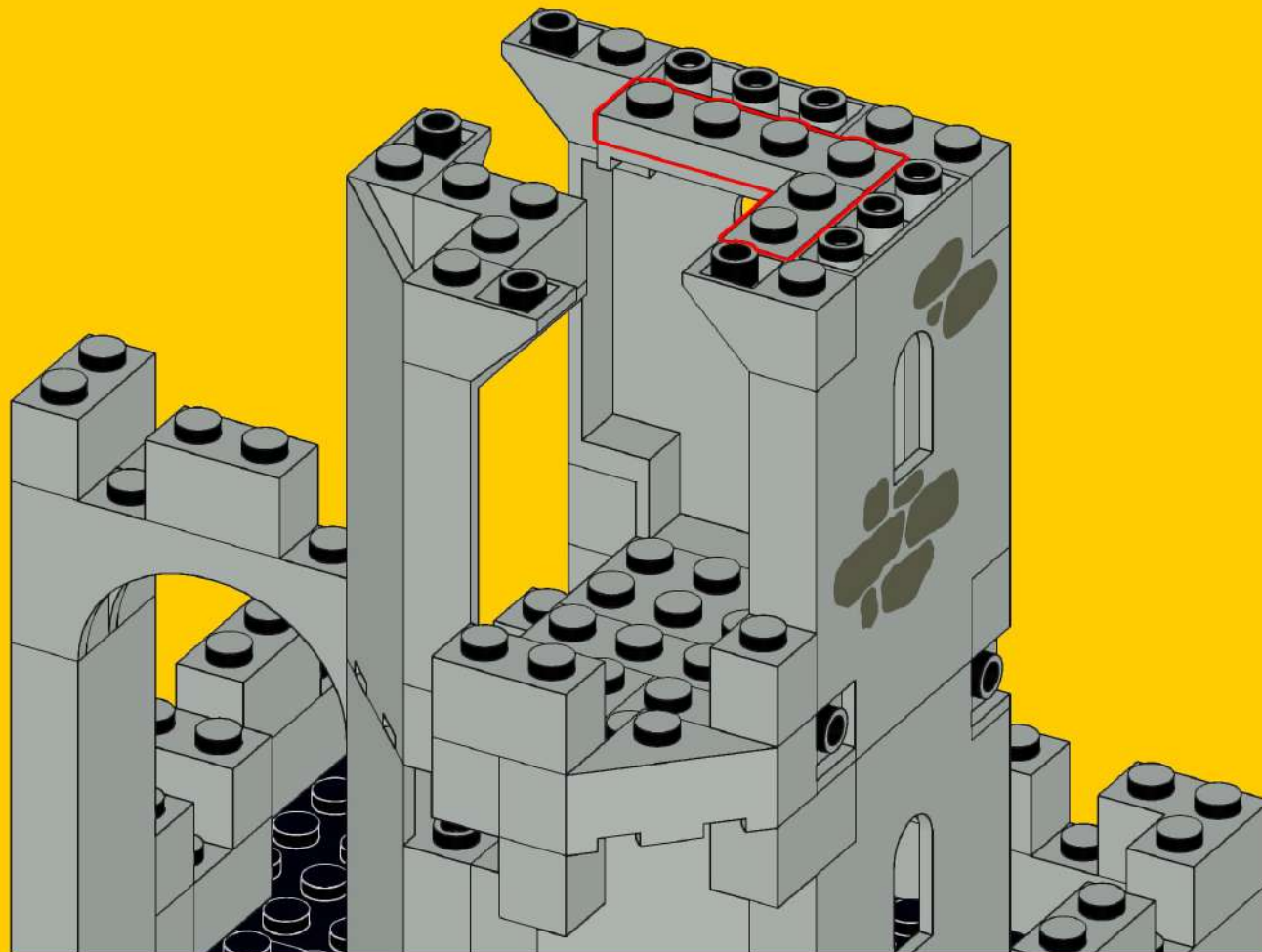
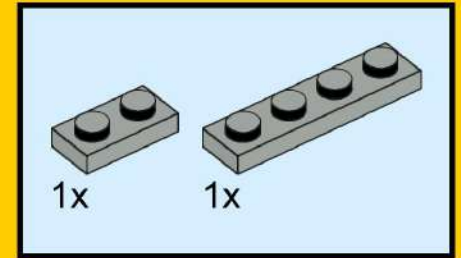

# 232

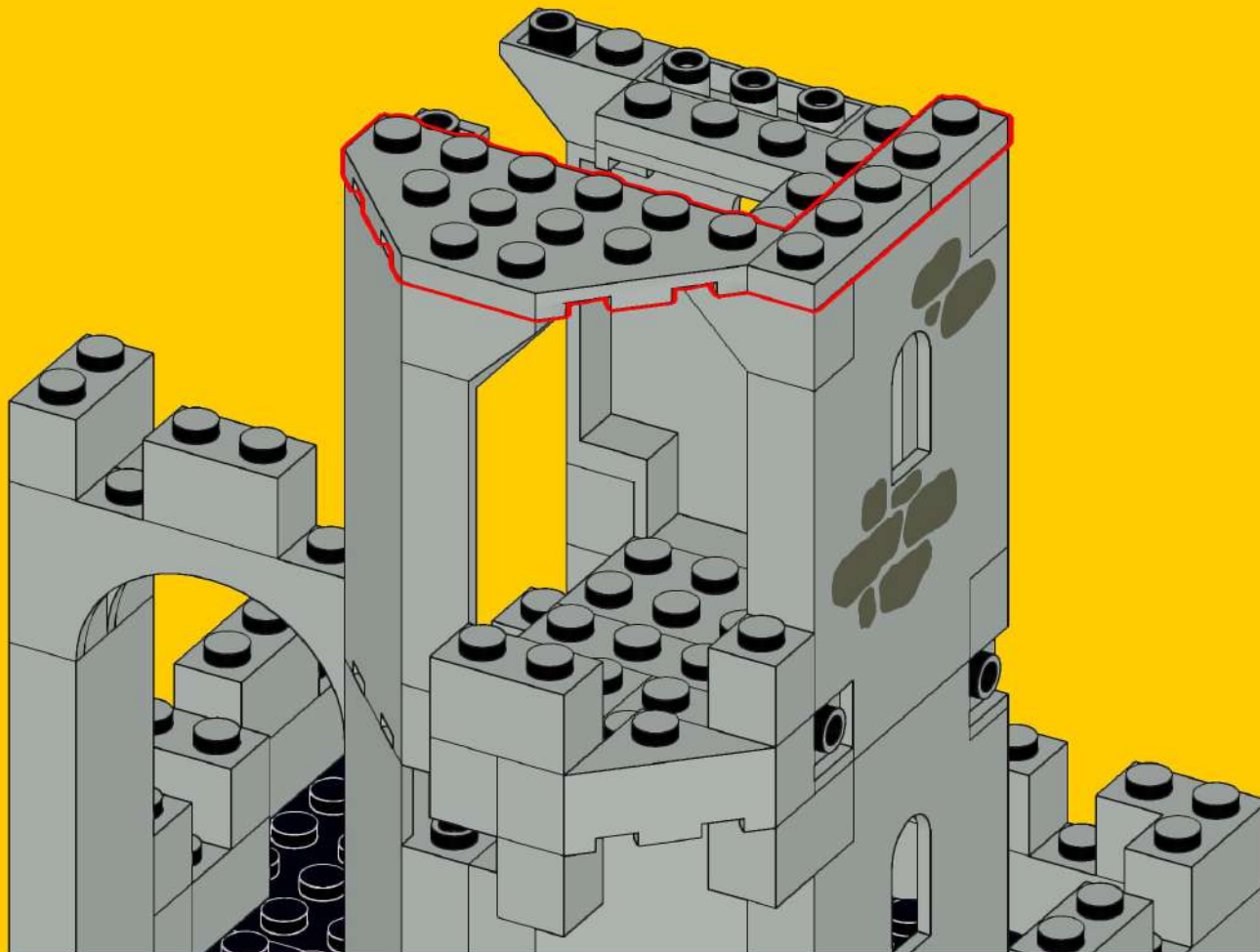
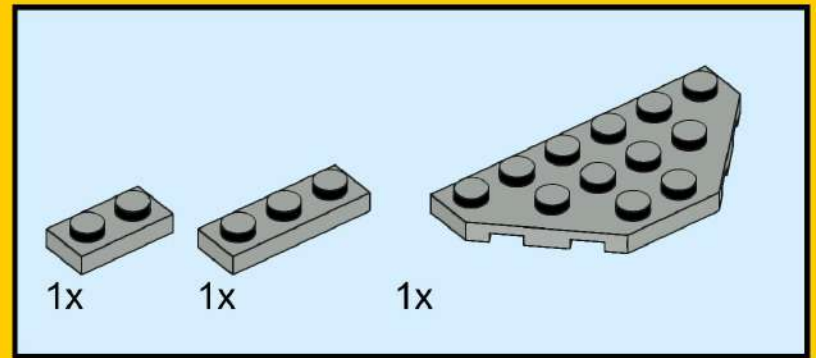

# 233

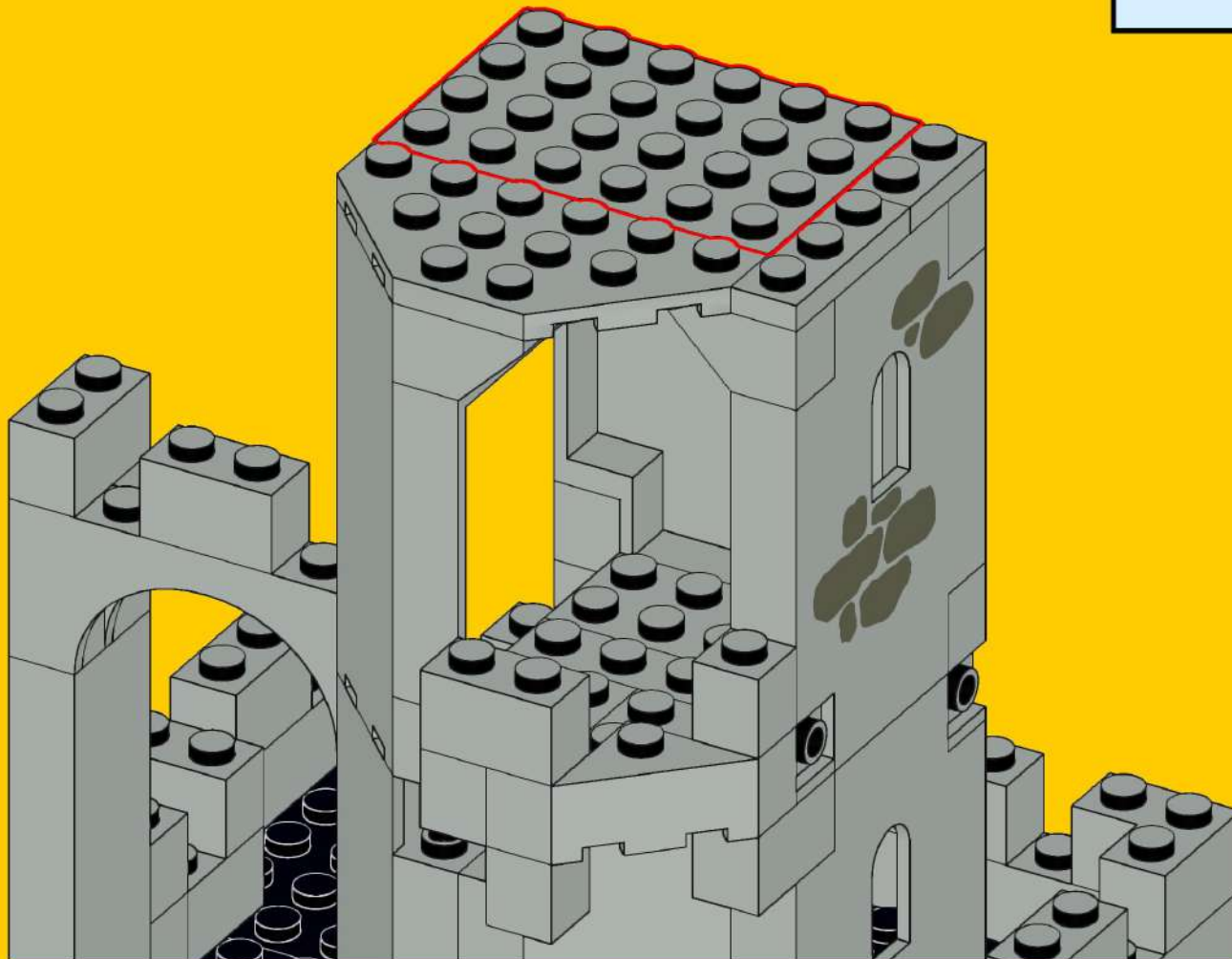
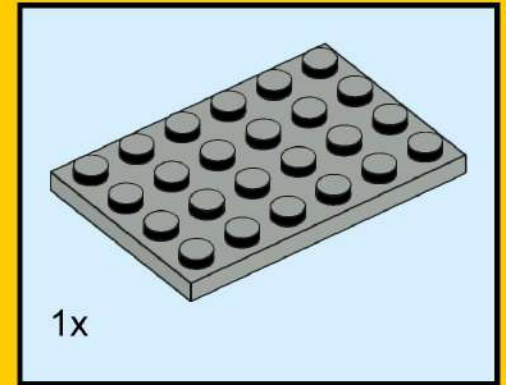



# 234

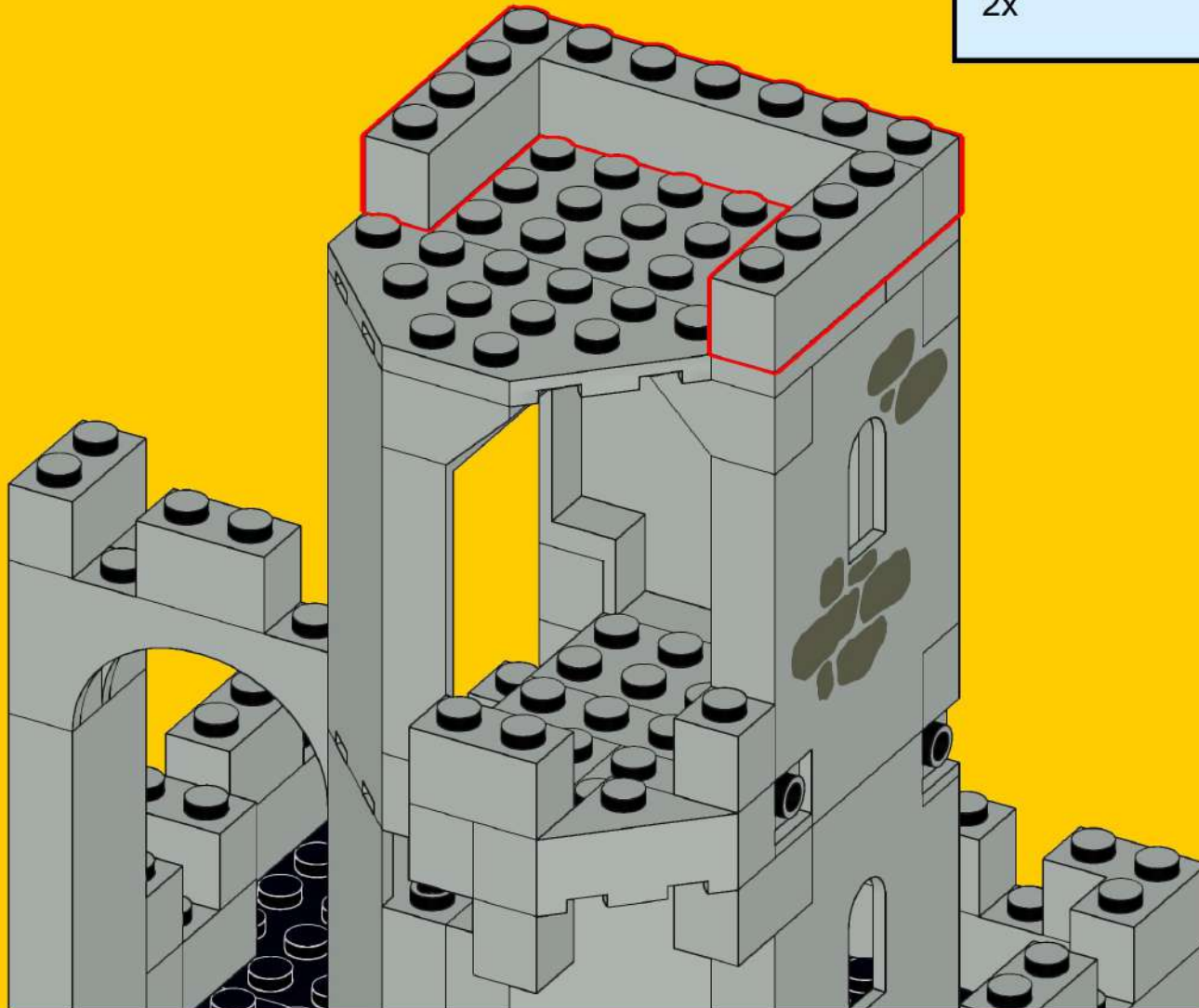
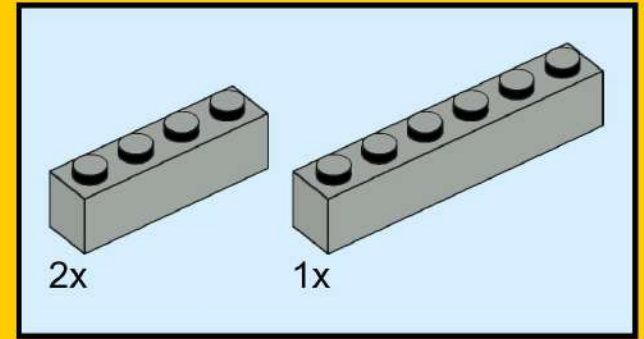

# 235

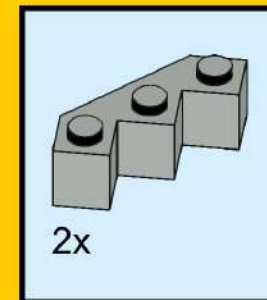

# 236

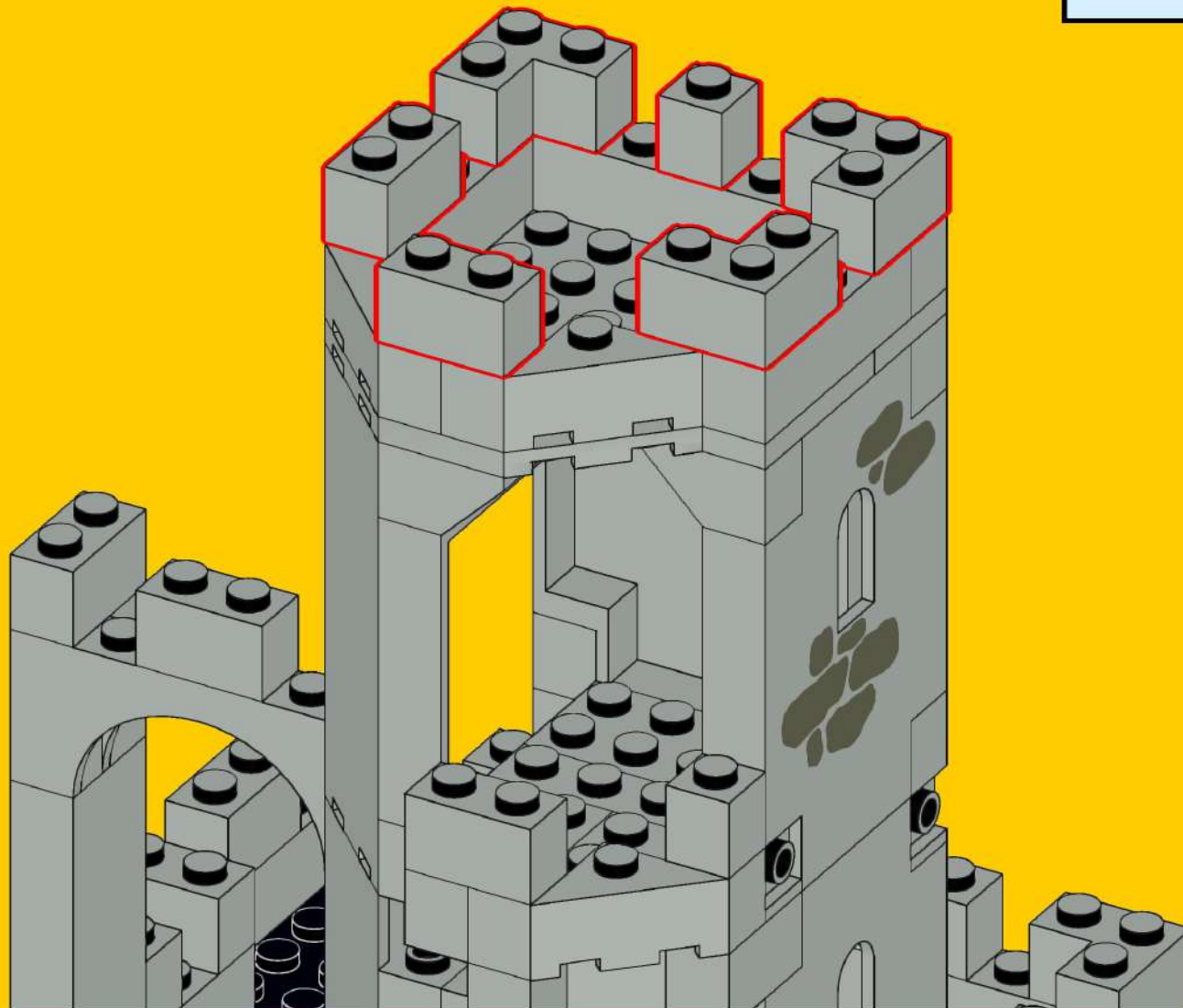
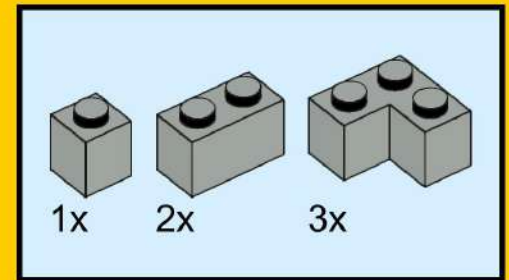

# 237

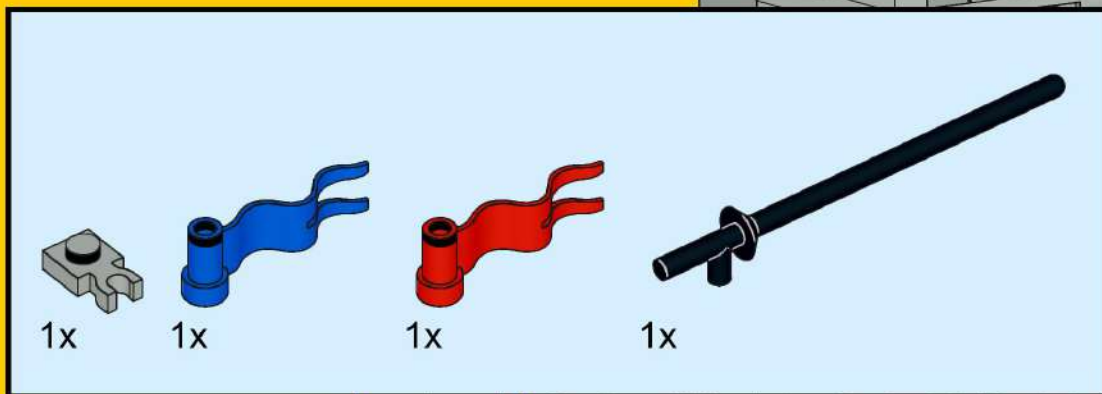
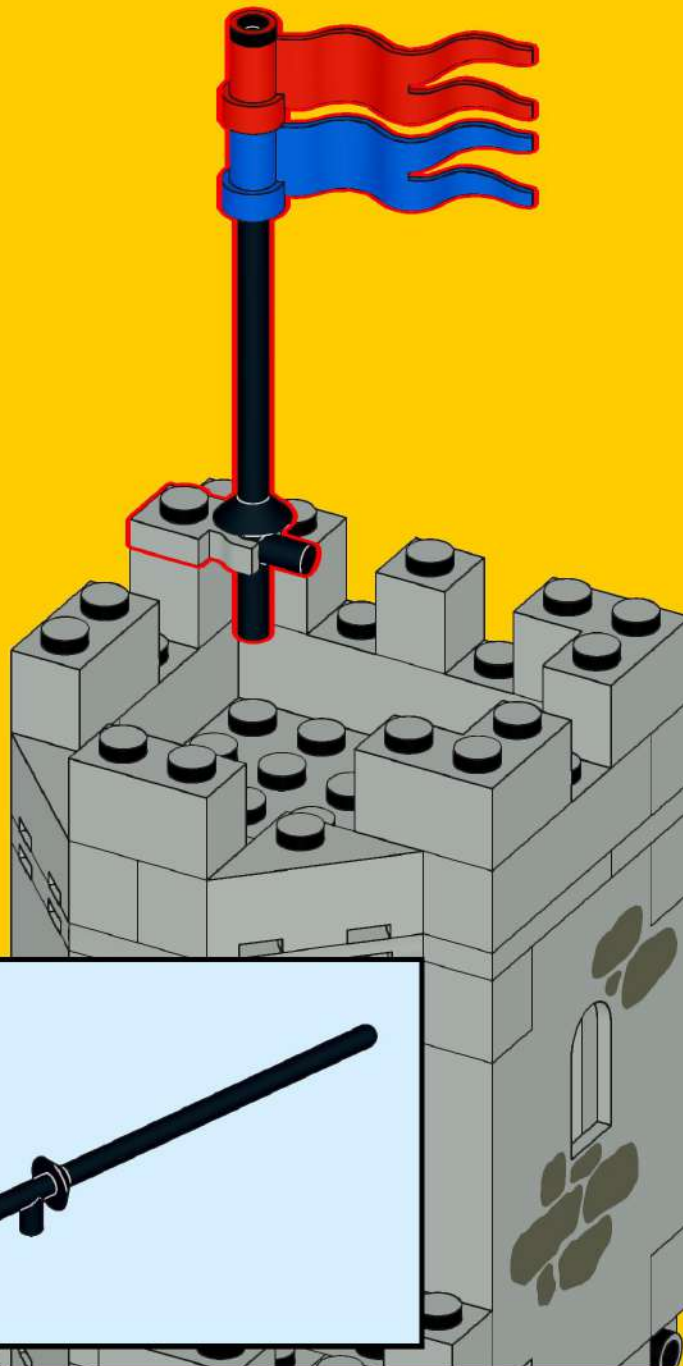

# 238

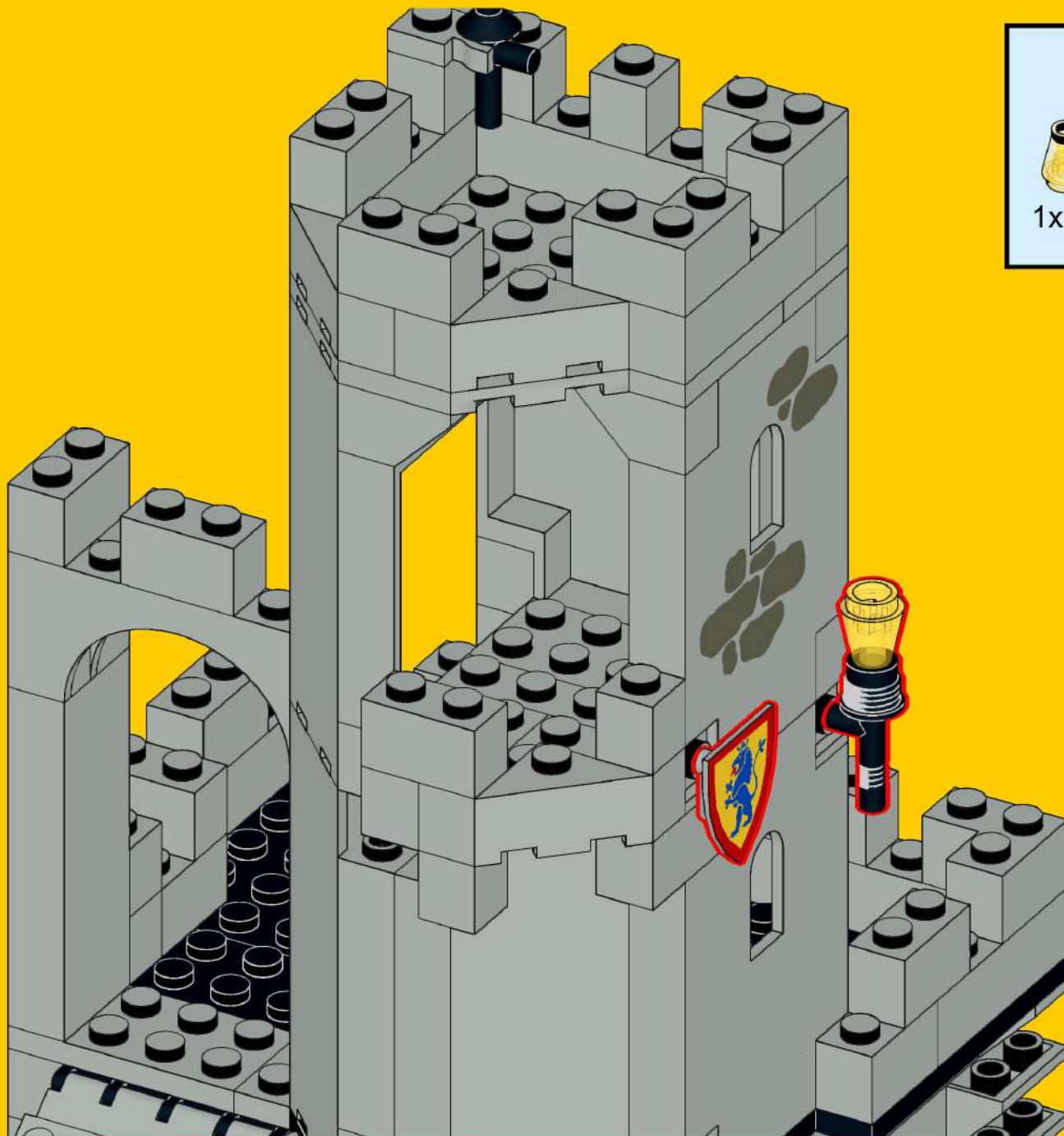

# 239

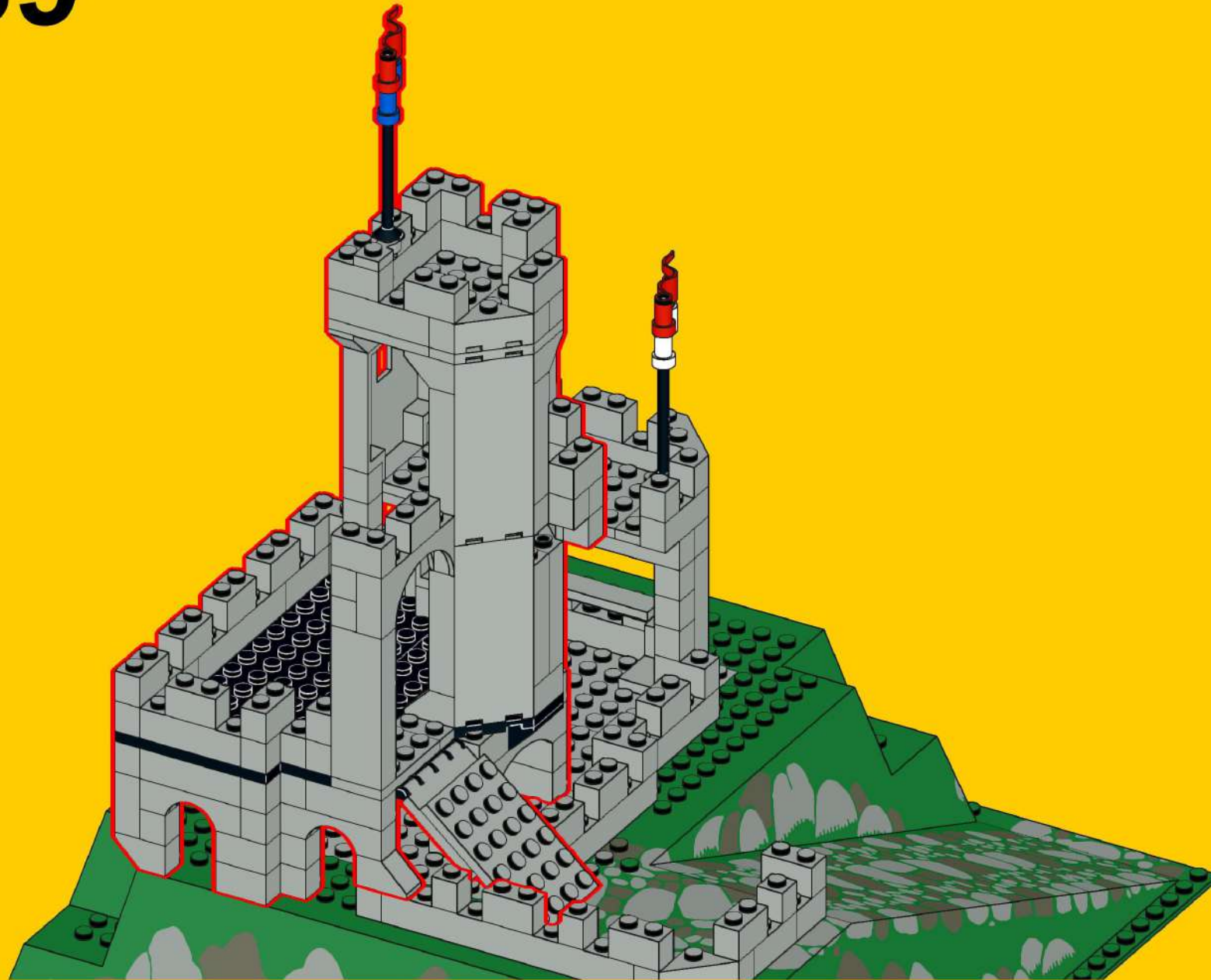

# 240

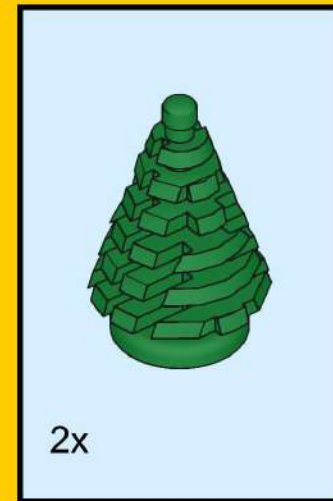

# 241



2x

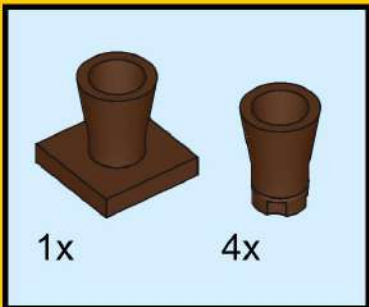

# 242

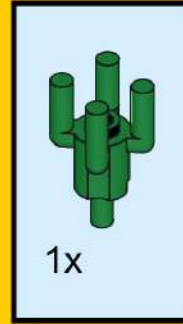

# 243

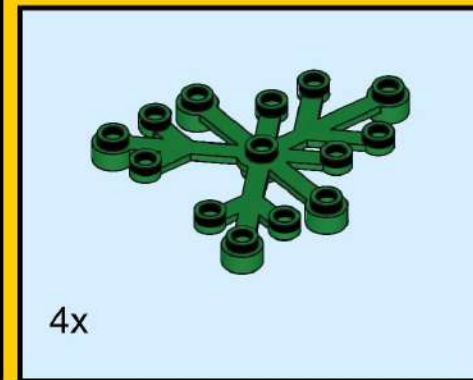



244

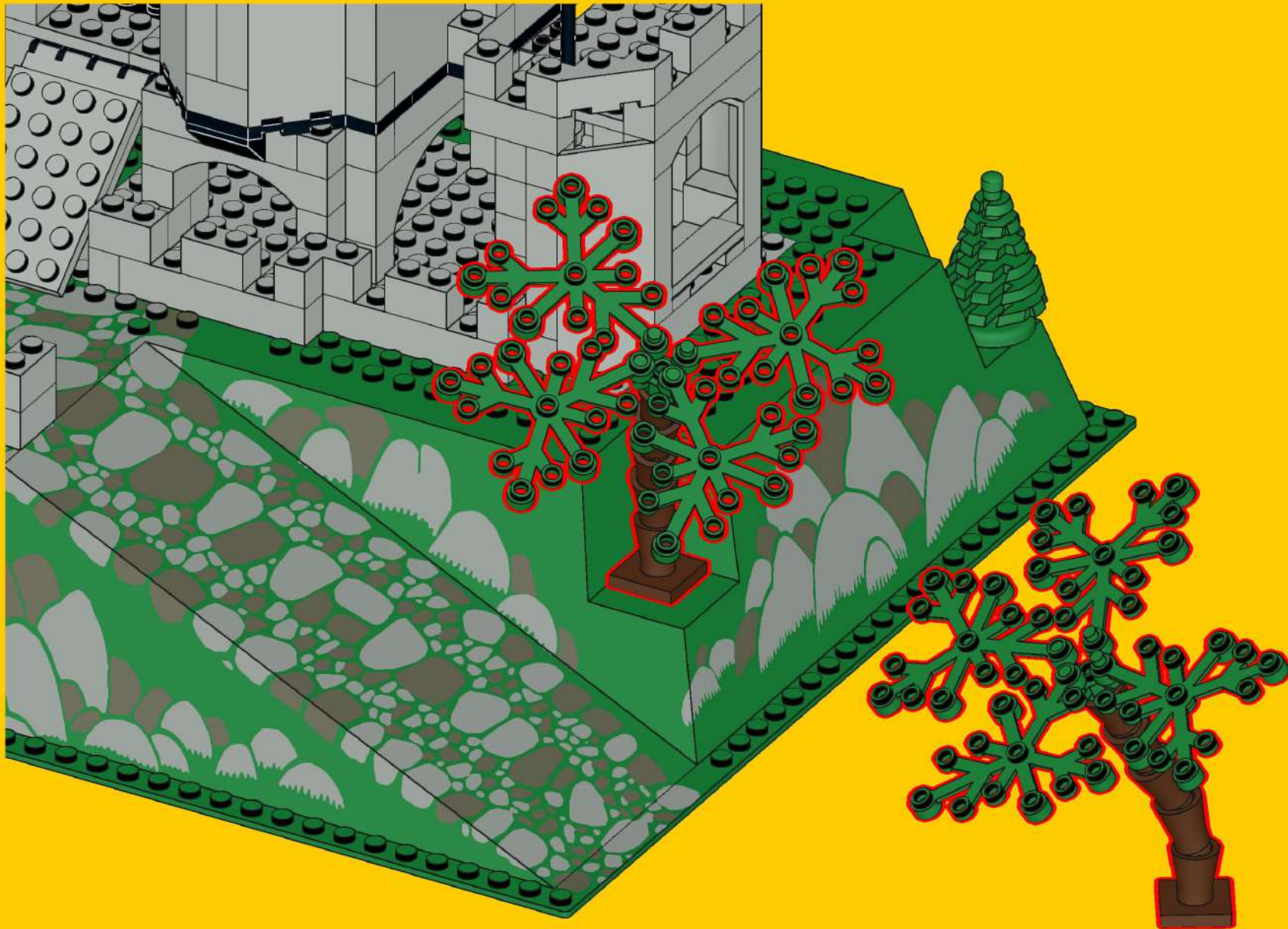

# 245



246



247



248



249

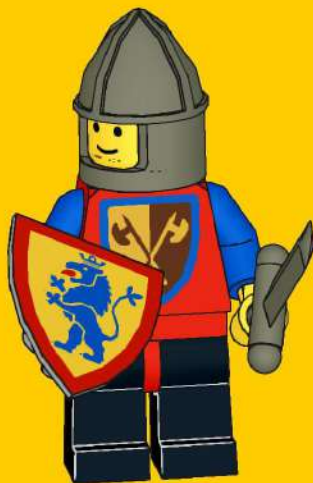

250



251



252



253



254



255



# 256



# 257





# 258



# 259



260

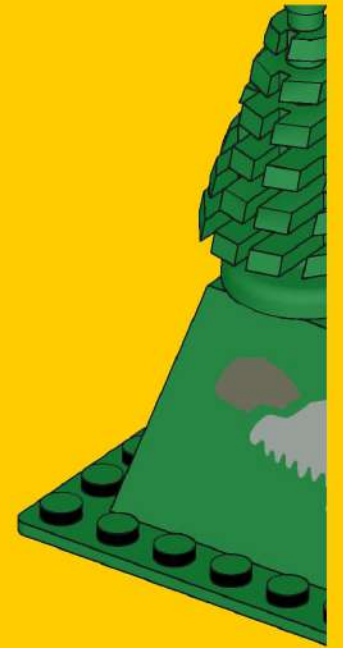

261



262



263



264



265



# 266

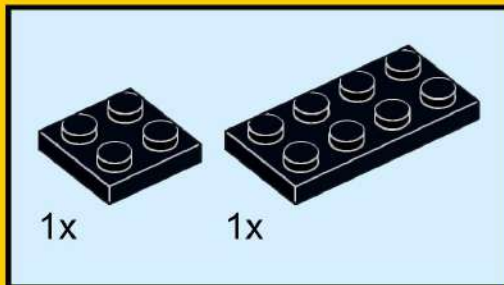
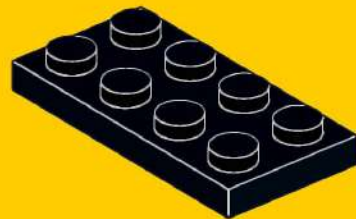
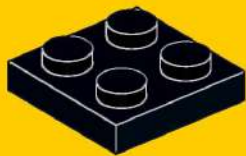
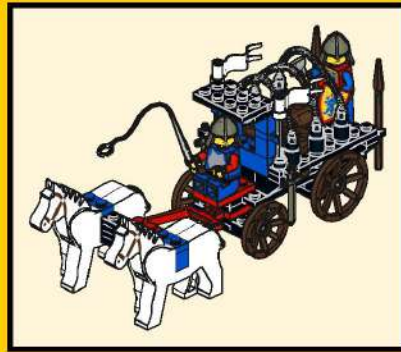

# 267

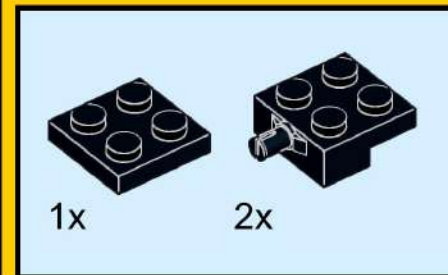
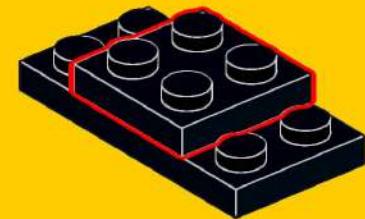
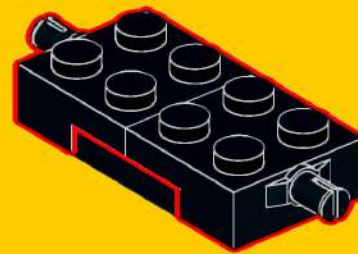

# 268

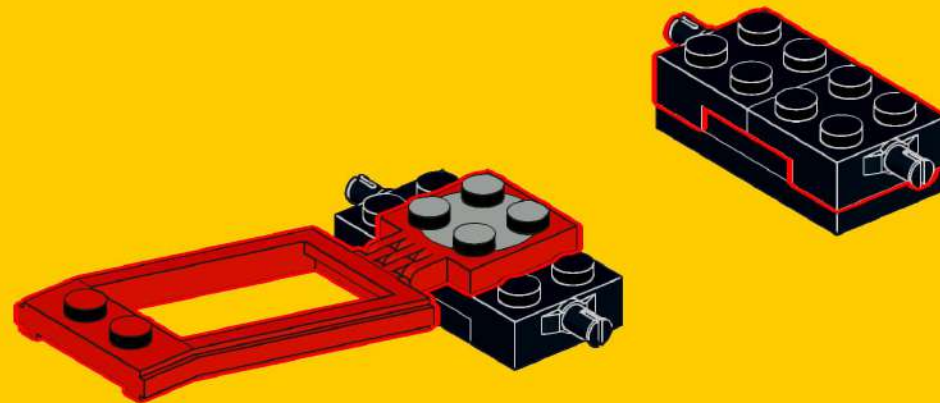
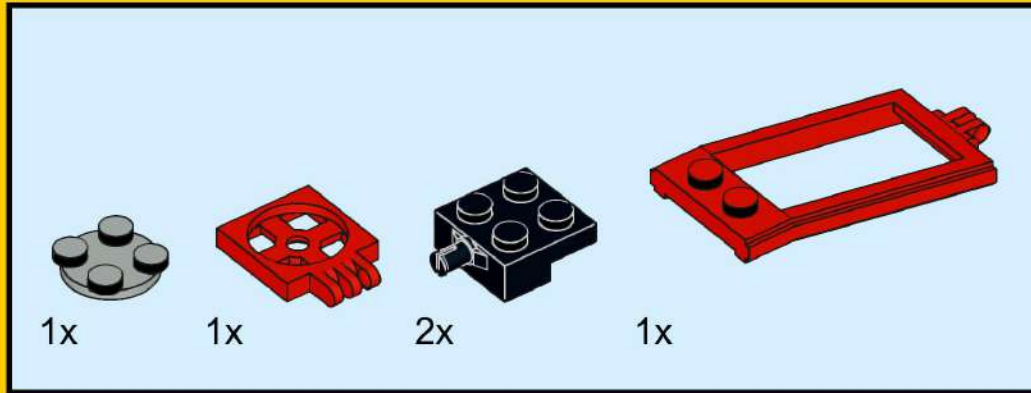

# 269

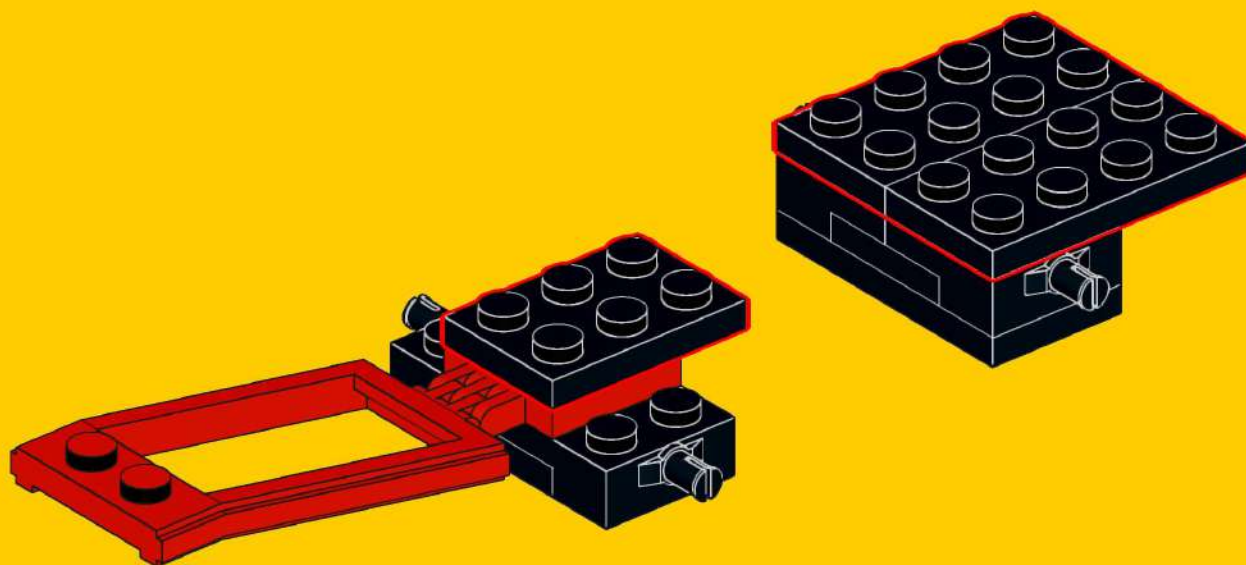
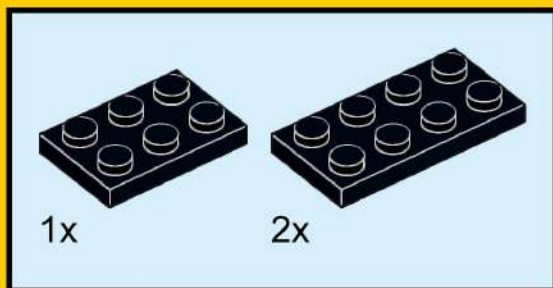

# 270

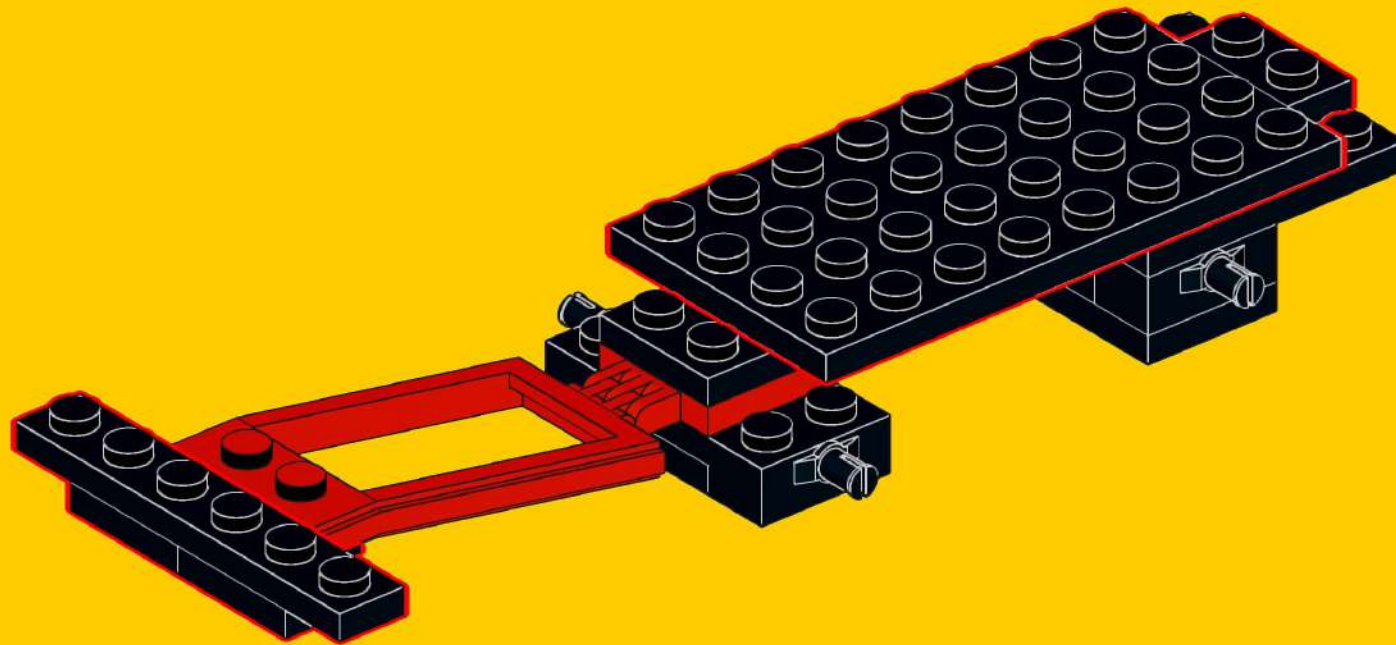
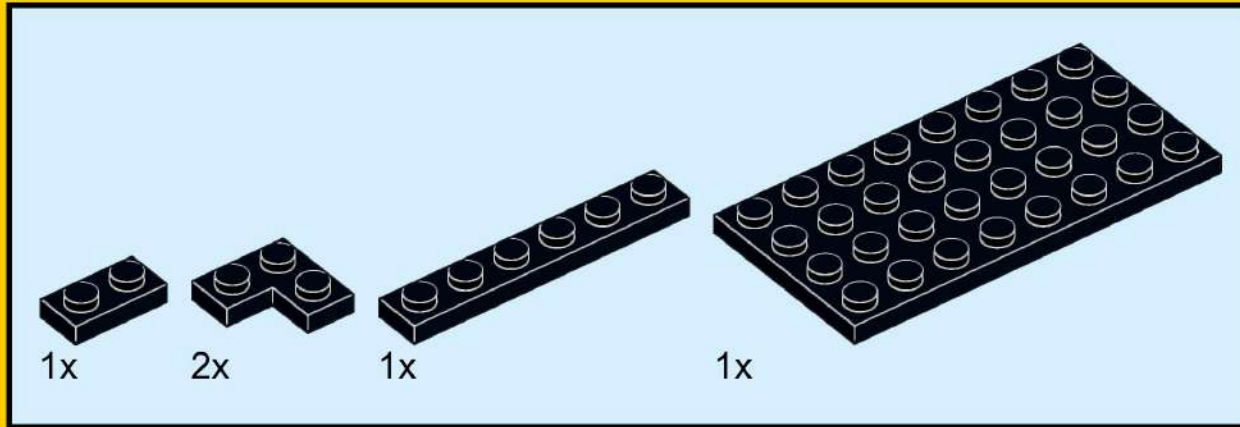



# 271

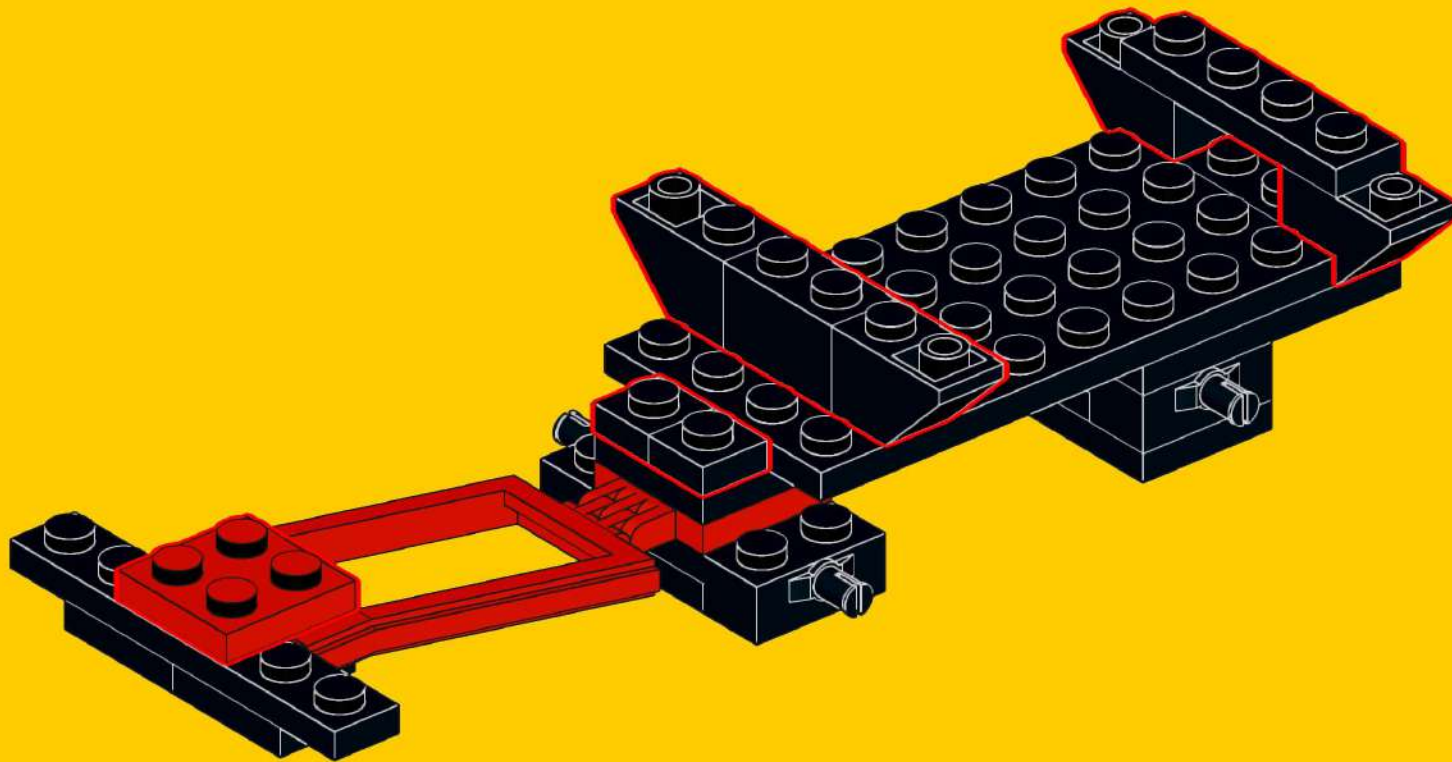
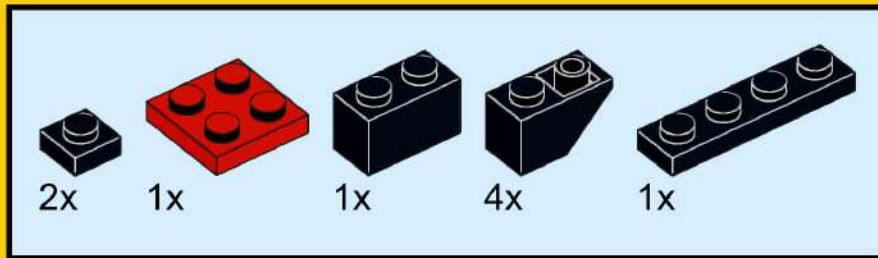

# 272

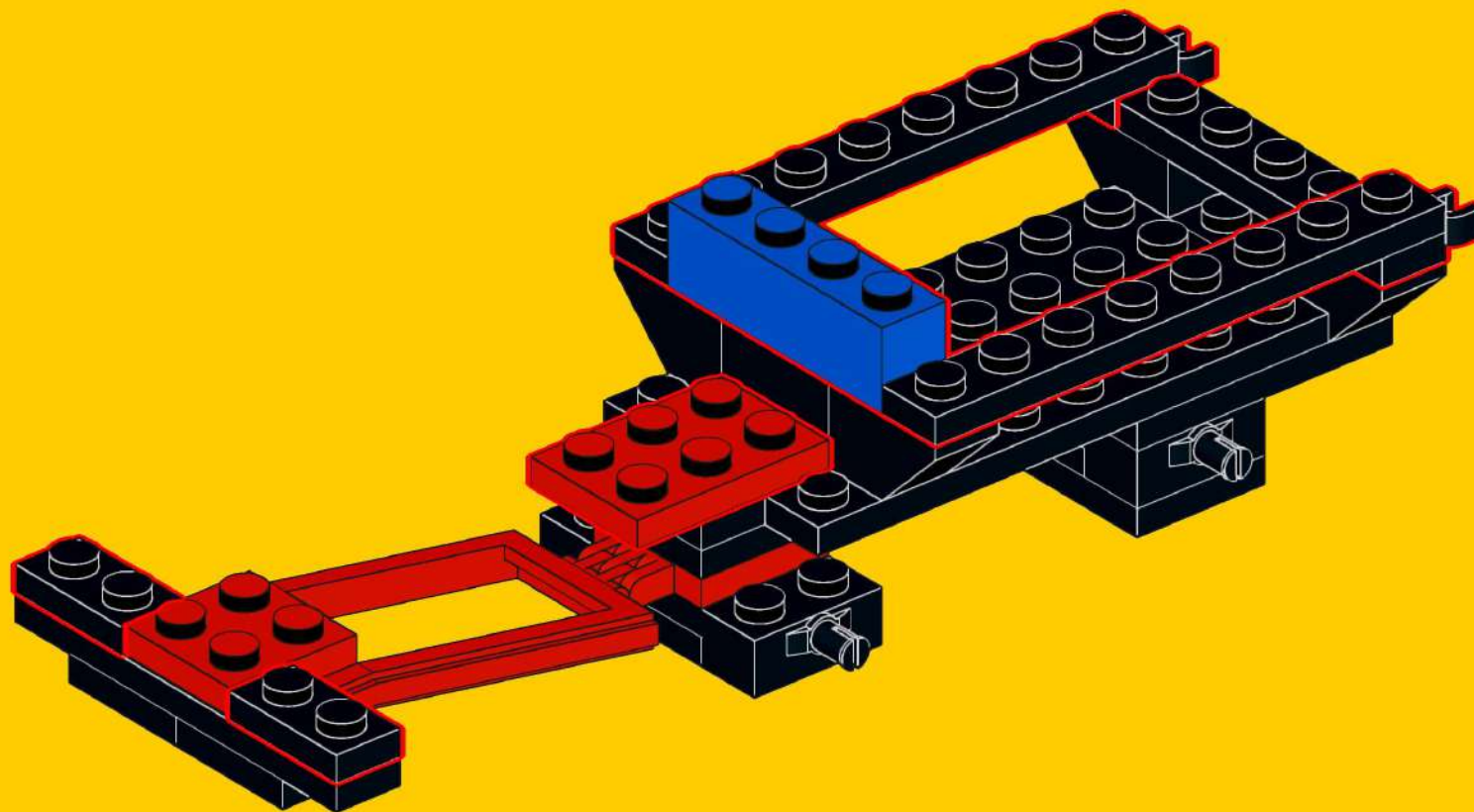
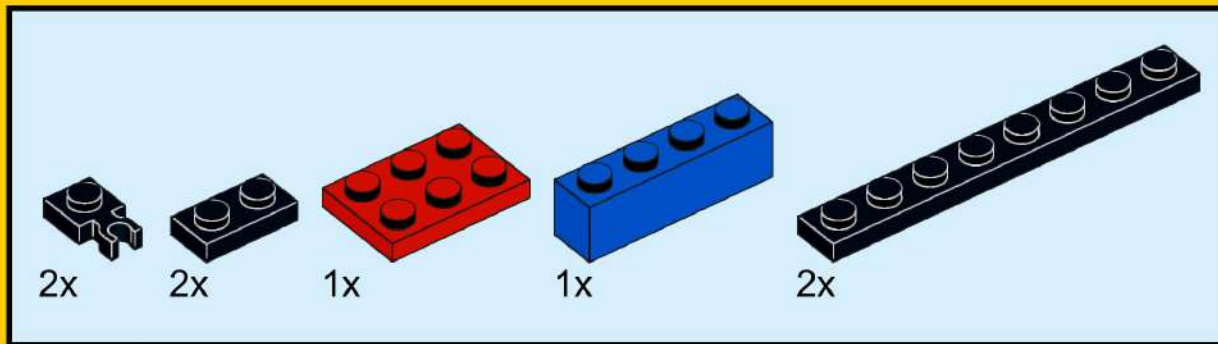



# 274

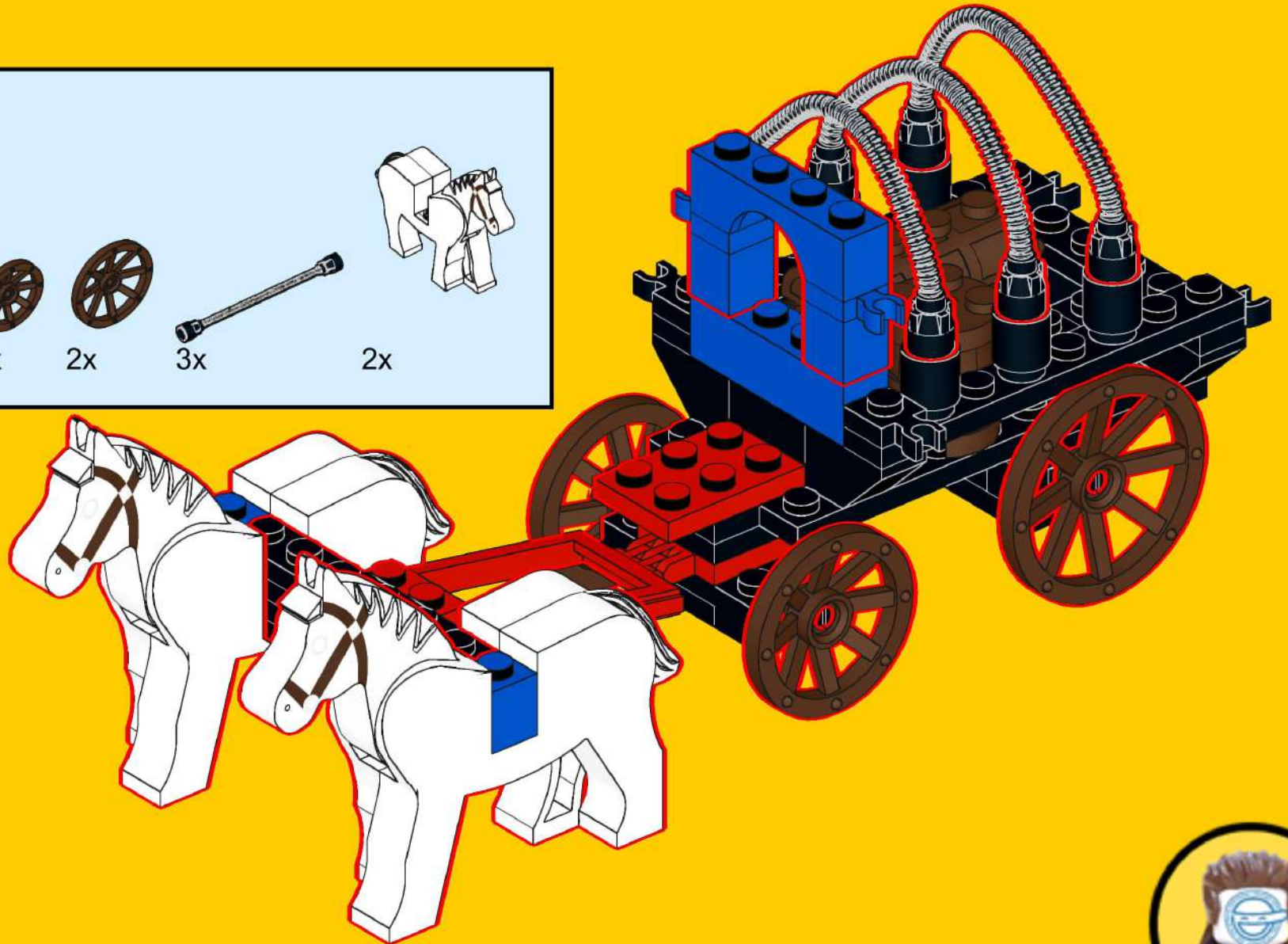
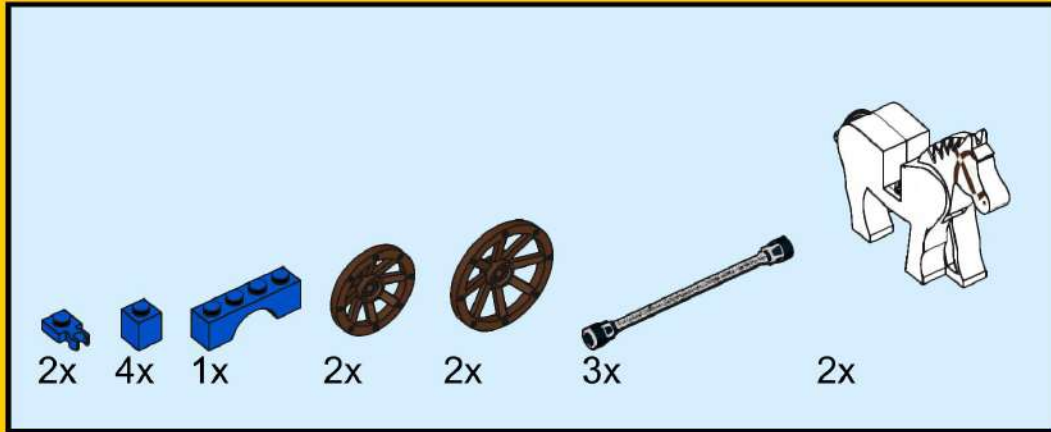

# 275

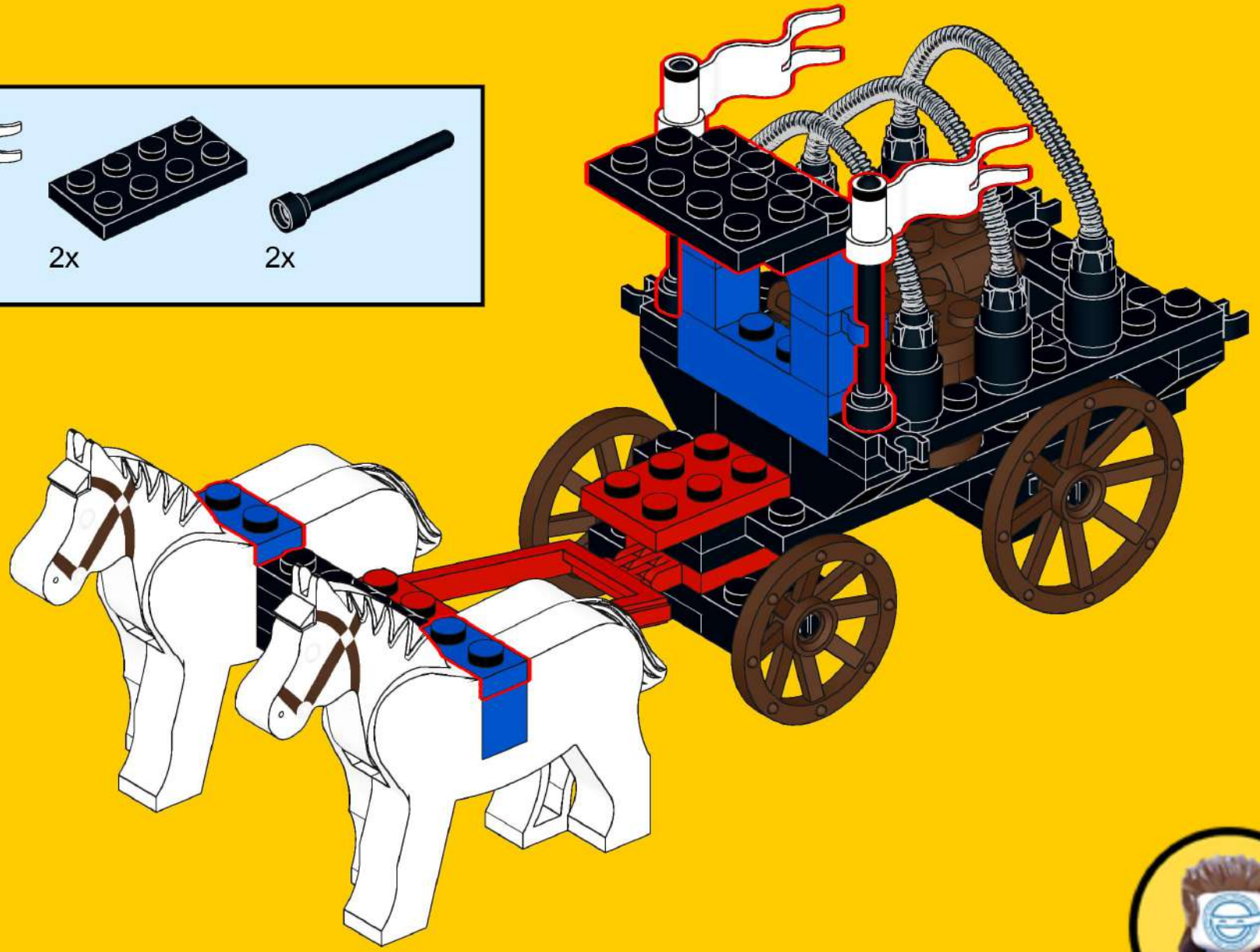
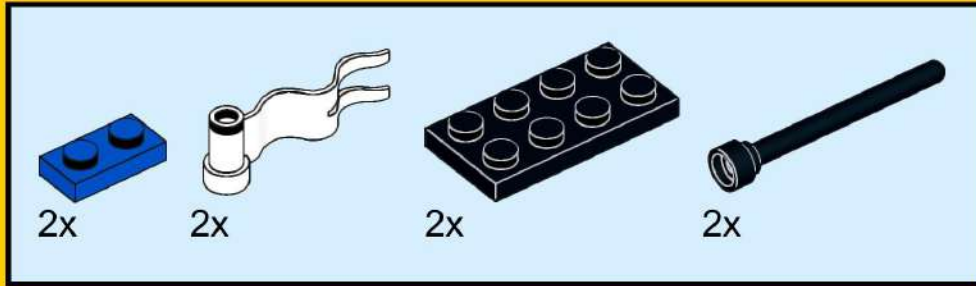

# 276

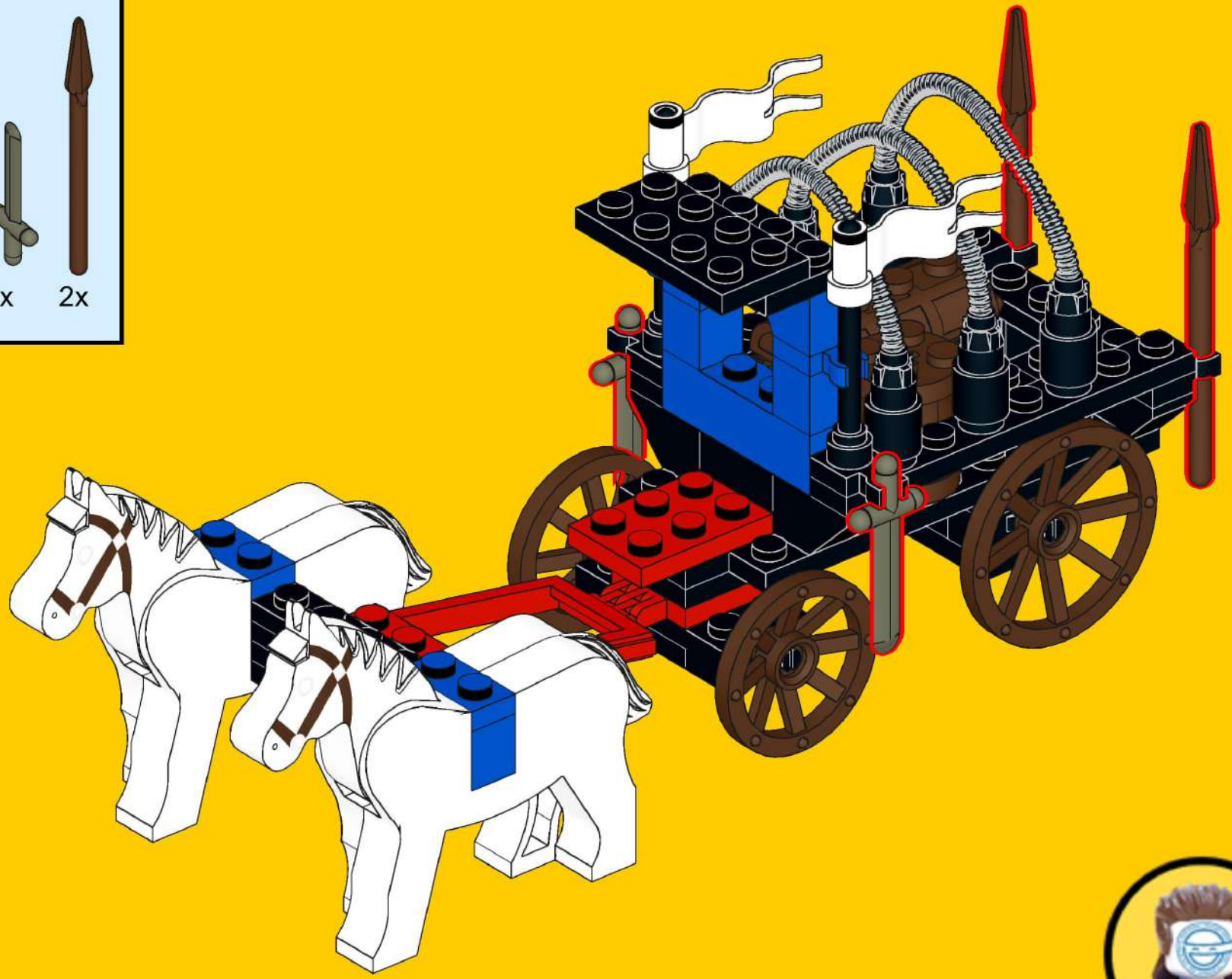
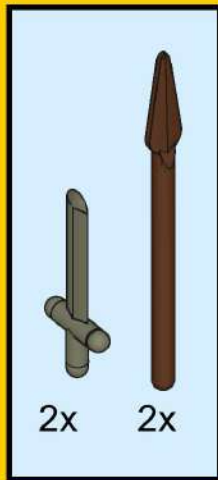

277

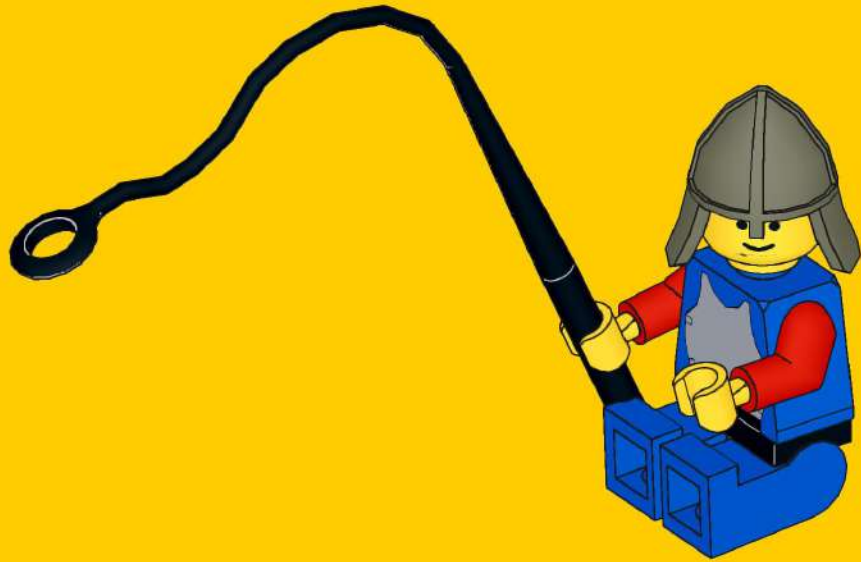

278



# 279

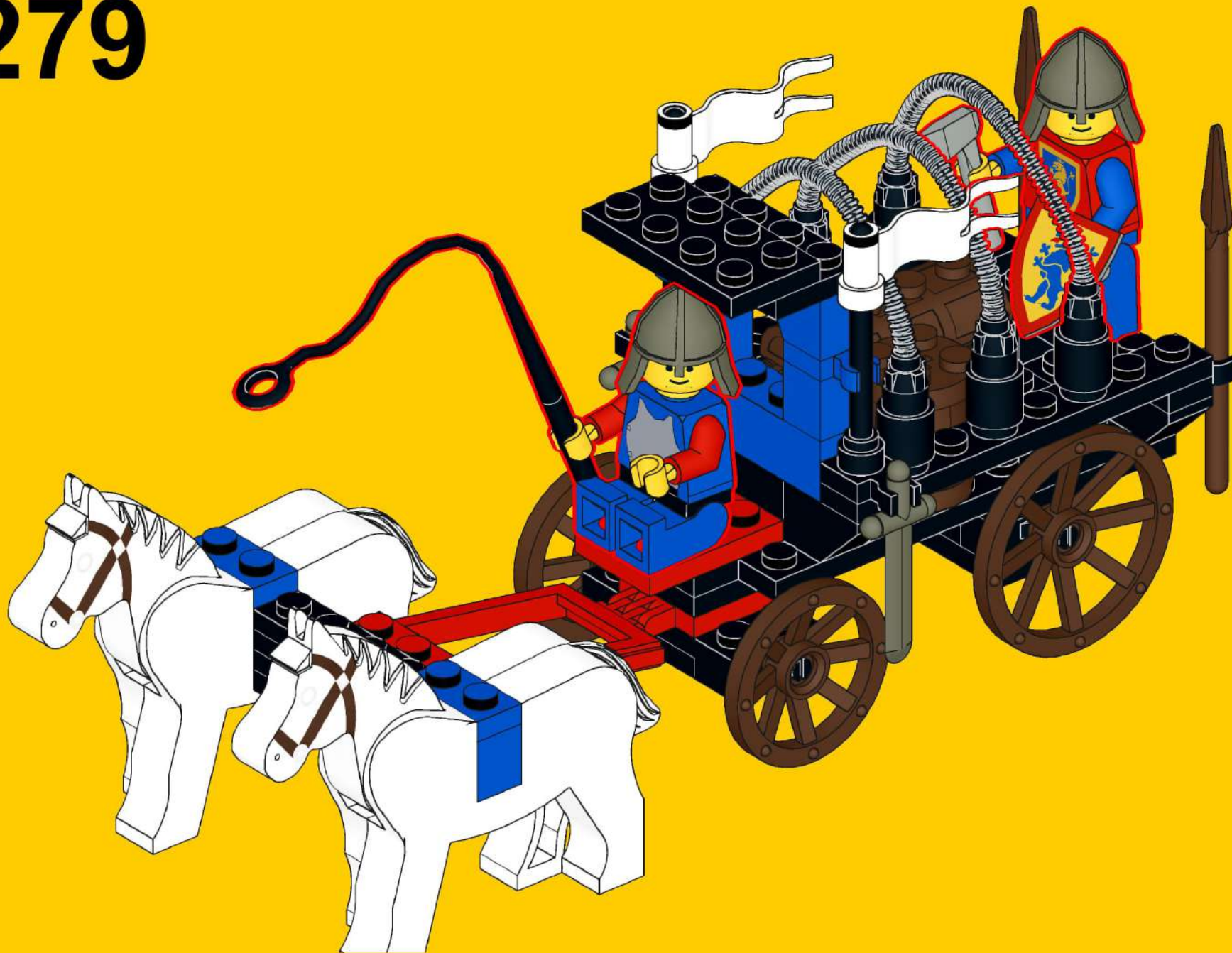



# 280

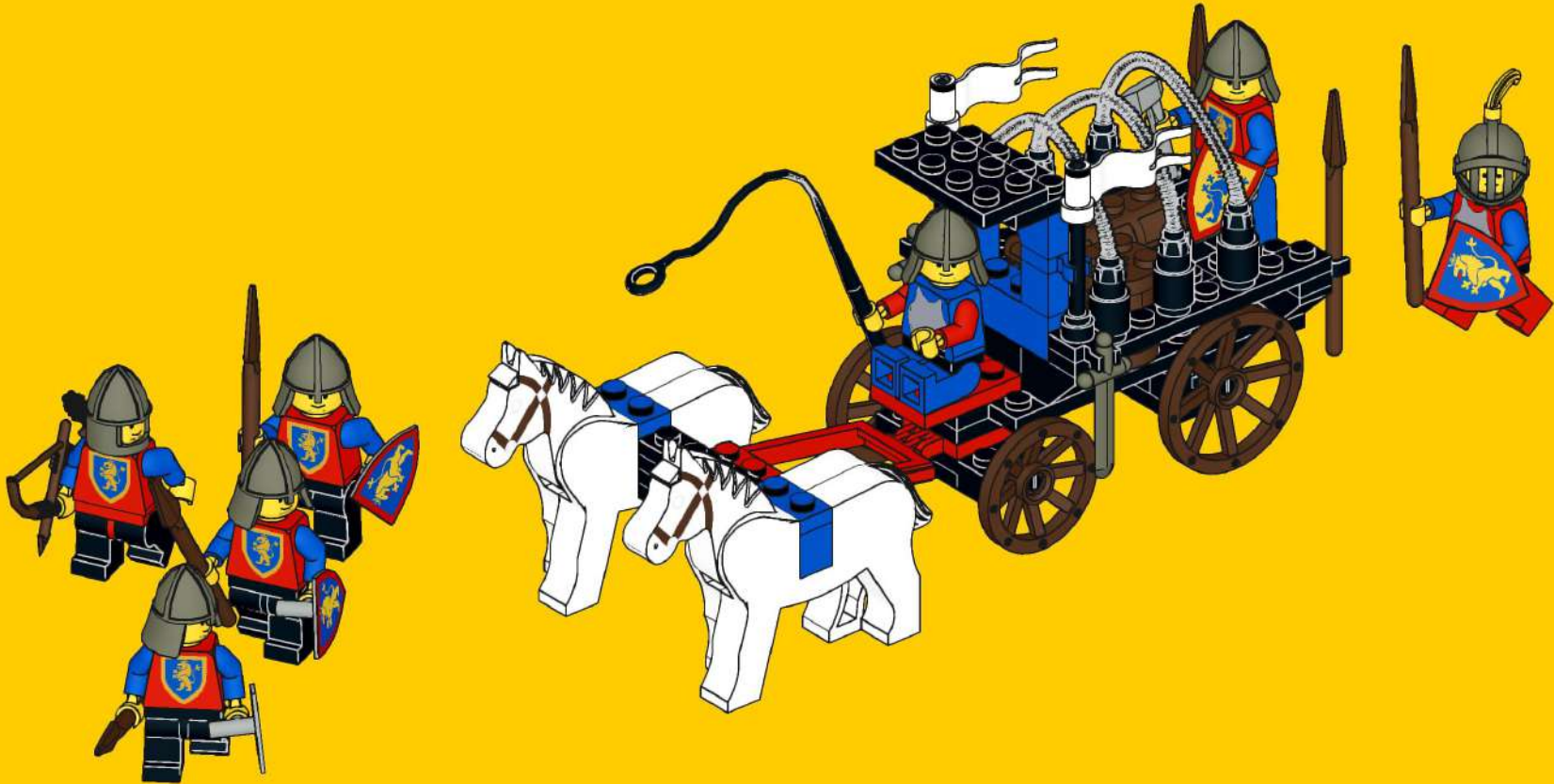

# 281







1x  
3455, 11



1x  
2419, 11

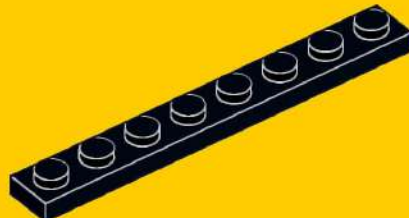

2x  
3460, 11

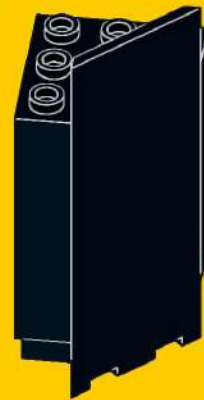

16x  
2345, 11



7x  
2453a, 11

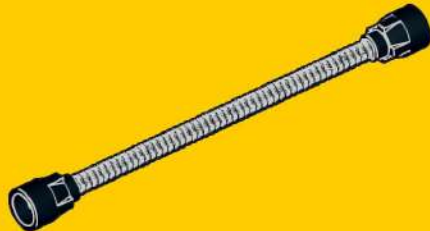

3x  
73590c02a, 11



2x  
2345pb06, 11



6x  
3849, 11

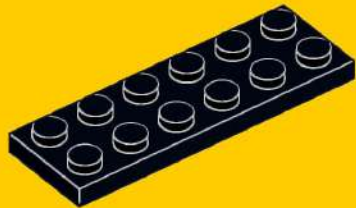

2x  
3795, 11

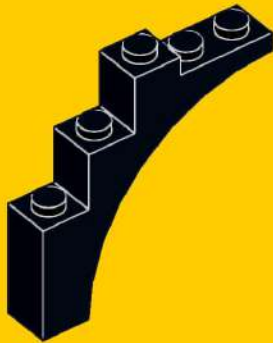

6x  
2339, 11

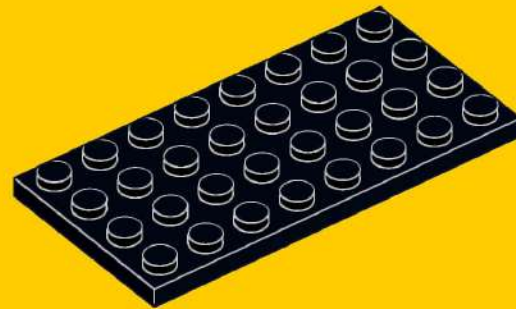

1x  
3035, 11





2x  
4444p05, 11

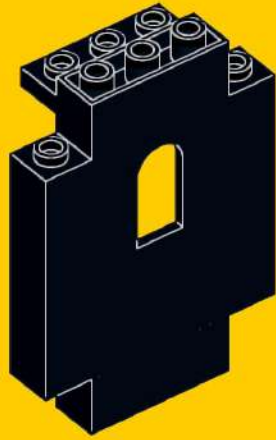

11x  
4444, 11

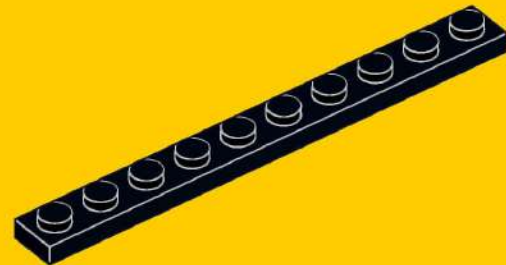

2x  
4477, 11



1x  
3832, 11

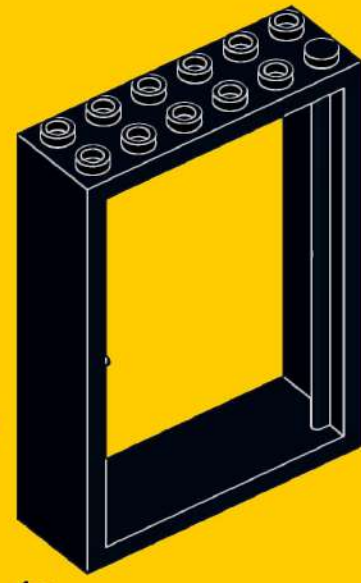

1x  
4071, 11

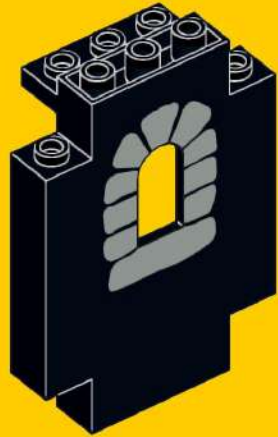

2x  
4444p04, 11



1x  
2488, 11





4x  
x167, 10



12x  
3844, 10

1x  
4493c01pb02, 11

1x  
3456, 11



7x  
3896, 10



6x  
2594, 10



1x  
2445, 11



6x  
2587, 10



1x  
2546, 10





13x  
3847, 10



2x  
2570, 10

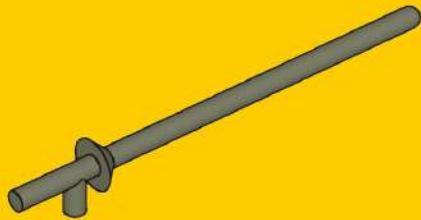

6x  
3849, 10

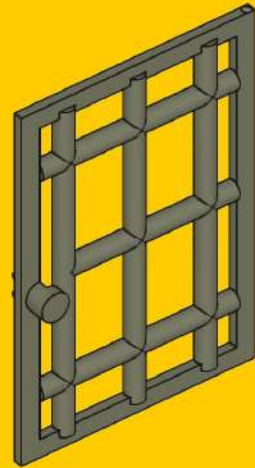

1x  
4611, 10



1x  
3070b, 9



13x  
3024, 9



42x  
3005, 9



3x  
4070, 9



1x  
4085b, 9



3x  
4085c, 9



2x  
4081a, 9



2x  
3673, 9

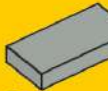

3x  
3069b, 9



20x  
3023, 9



1x  
3679, 9



2x  
3700, 9

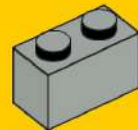

59x  
3004, 9



25x  
3665, 9



3x  
3040, 9



2x  
3022, 9

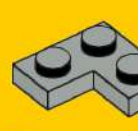

9x  
2420, 9



3x  
2430, 9



3x  
2429, 9



4x  
3959, 9



12x  
3660, 9



5x  
3676, 9

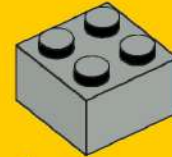

4x  
3003, 9



29x  
2357, 9



6x  
3623, 9



12x  
3846px10, 9



9x  
3846p4g, 9



9x  
3846p4h, 9



1x  
3835, 9

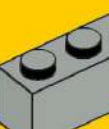

6x  
3622, 9



2x  
3021, 9



1x  
3747a, 9



6x  
3710, 9

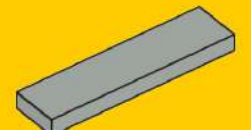

1x  
2431, 9



8x  
2450, 9



9x  
3010, 9



2x  
3659, 9



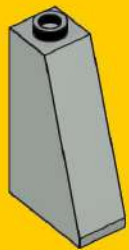

1x  
4460a, 9

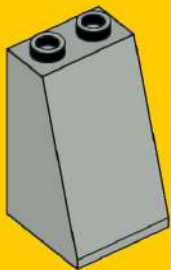

2x  
3684a, 9

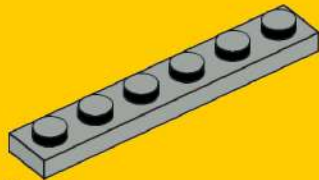

6x  
3666, 9

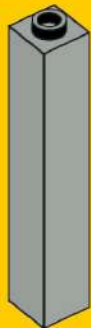

1x  
2453a, 9

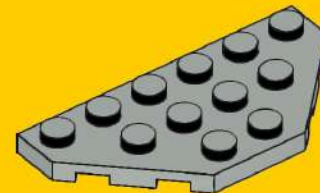

8x  
2419, 9



7x  
3020, 9



1x  
3031, 9

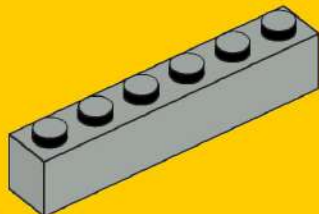

7x  
3009, 9



3x  
3032, 9

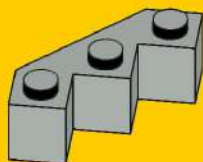

6x  
2462, 9



2x  
3455, 9



3x  
2454, 9

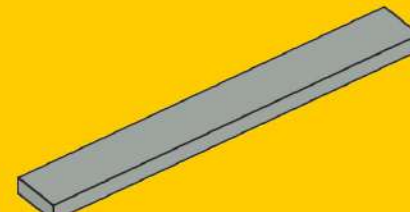

1x  
4162, 9

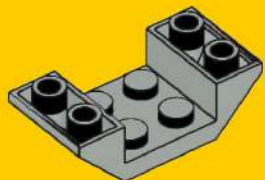

3x  
4871, 9

1x  
4213, 9

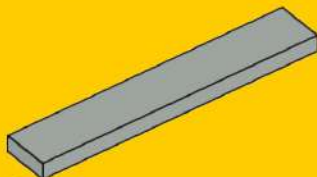

2x  
6636, 9

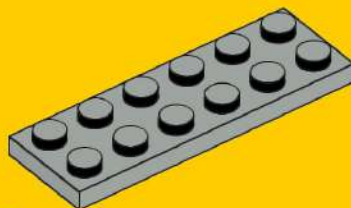

2x  
3795, 9

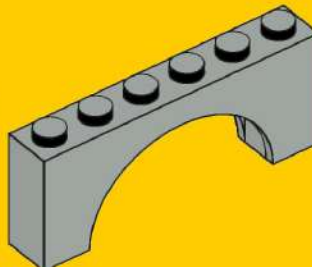

3x  
3307, 9

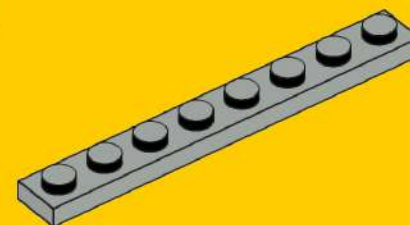

5x  
3460, 9





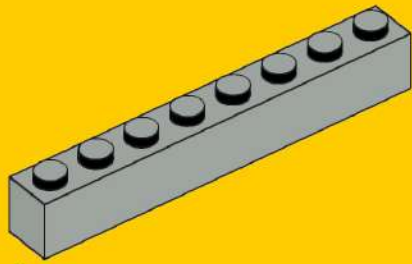

4x  
3008, 9

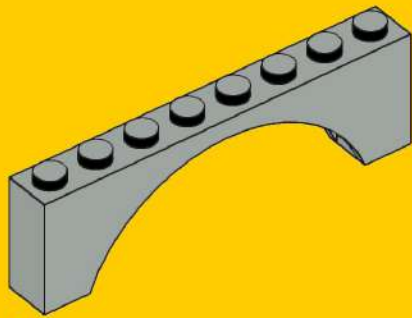

1x  
3308, 9

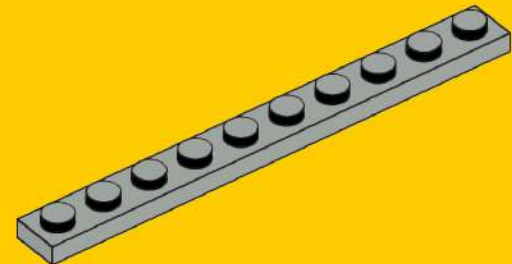
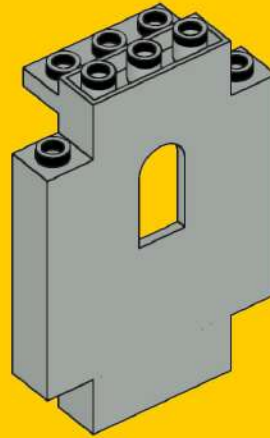

4x  
4477, 9

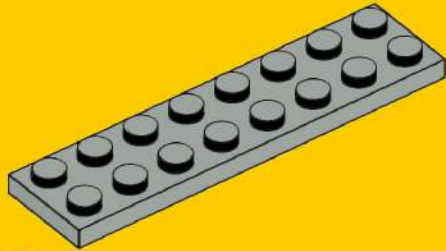

3x  
3034, 9

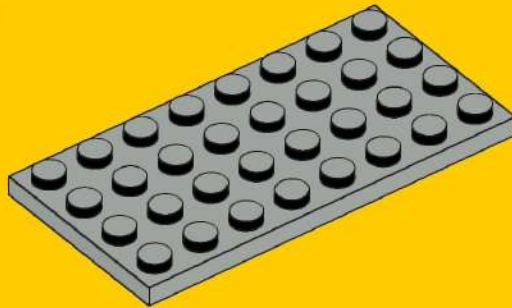

2x  
4444, 9

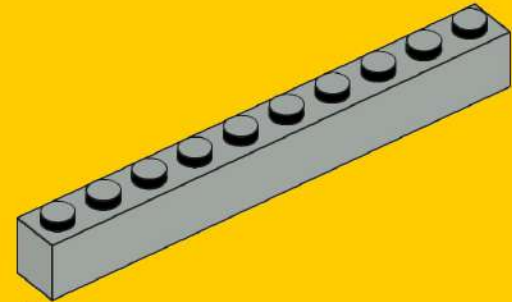

2x  
6111, 9

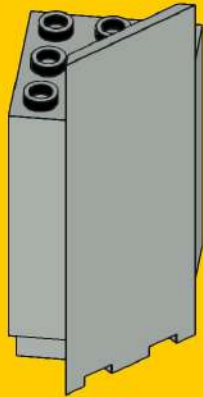

5x  
2345, 9

4x  
3035, 9

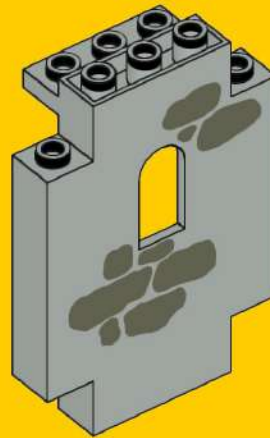

1x  
4444p02, 9

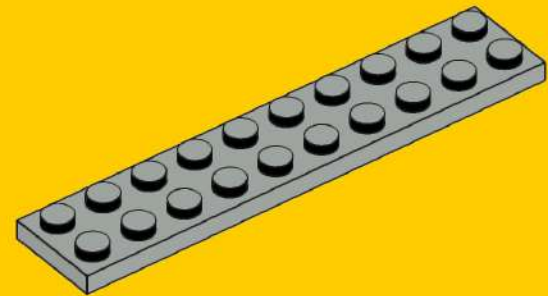

1x  
3832, 9



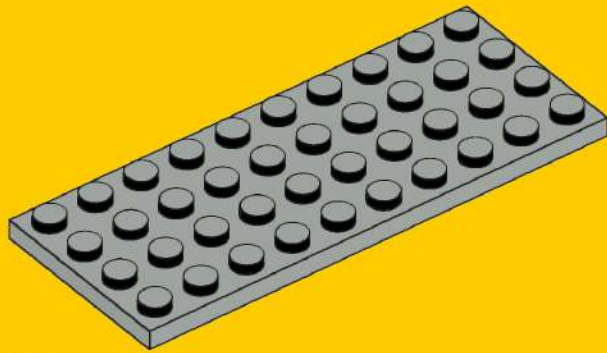

1x  
3030, 9

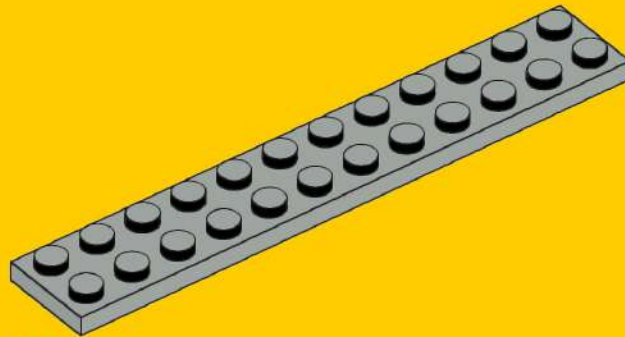

1x  
2445, 9

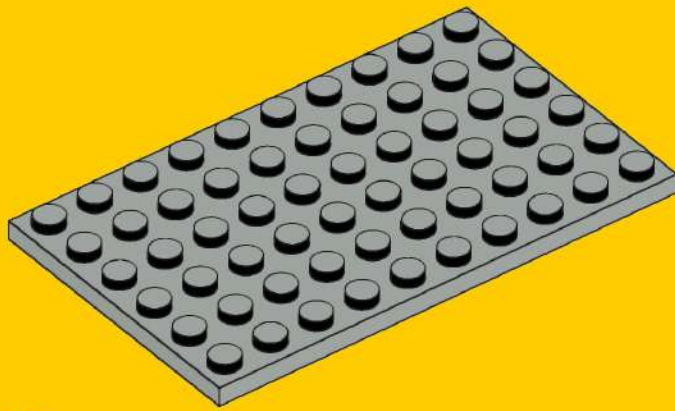

1x  
3033, 9

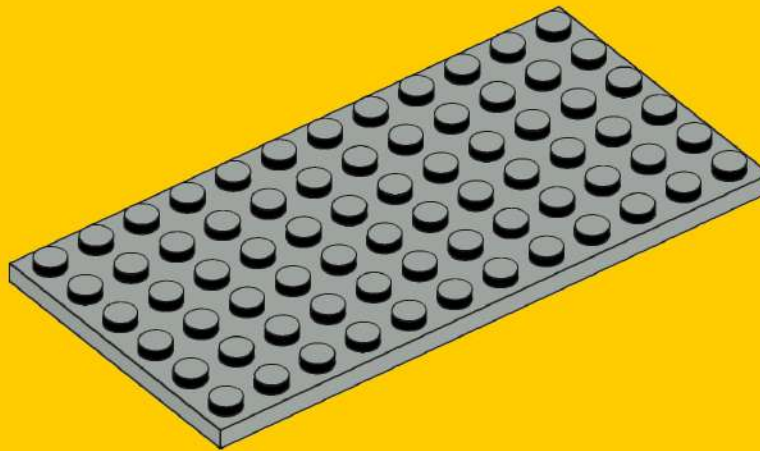

1x  
3028, 9



2x  
983, 1



1x  
982, 1



1x  
981, 1



1x  
3023, 1



1x  
4502b, 1

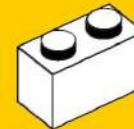

1x  
3004, 1



1x  
973, 1



4x  
4495a, 1



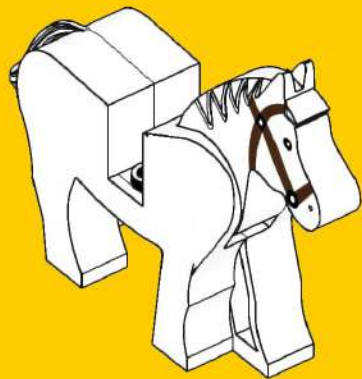

2x  
4493c01pb04, 1

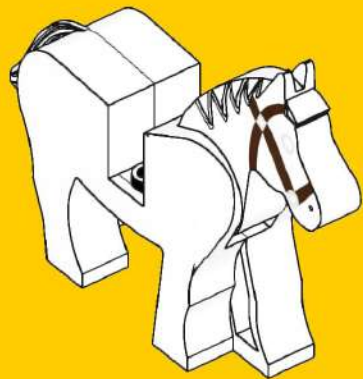

2x  
4493c01pb02, 1



3x  
982, 5



3x  
981, 5



4x  
972, 5



4x  
971, 5



3x  
4502b, 5



13x  
970, 5



1x  
3022, 5



6x  
973p40, 5



15x  
973px138, 5



2x  
973p42, 5



1x  
973p41, 5



1x  
251, 5



1x  
3021, 5



7x  
4495a, 5

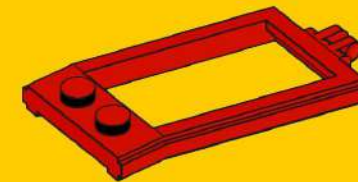

1x  
4587, 5





2x

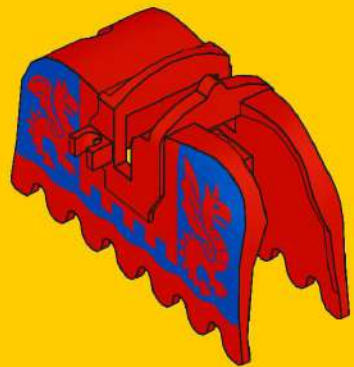

1x  
2490pb02, 5



8x  
2536d, 8



5x  
4498, 8

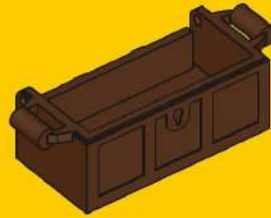

1x  
4738a, 8



2x  
2554, 8



7x  
3626bp01, 3



1x  
4032, 8



1x  
4739a, 8



29x  
3626ap01, 3



2x  
2563, 8



2x  
4489a, 8



13x  
4497, 8



3x  
4502b, 3



1x  
2489, 8

2x  
2470, 8



4x  
3848, 8



72x  
983, 3

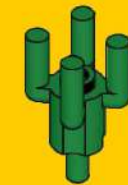

2x  
2566, 6



5x  
4499, 8



1x  
4502a, 3



3x  
2423, 6



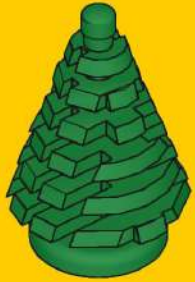

3x  
2435, 6

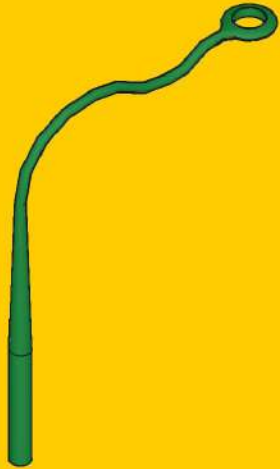

1x  
2488, 6

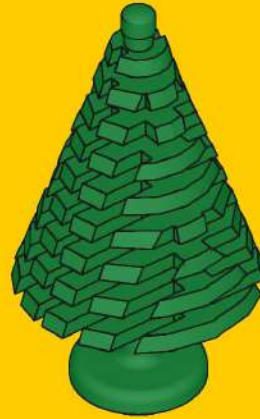

2x  
3471, 6

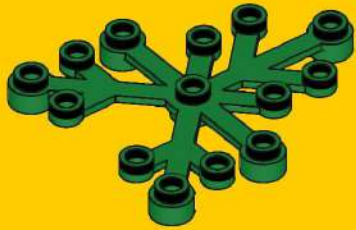

14x  
2417, 6

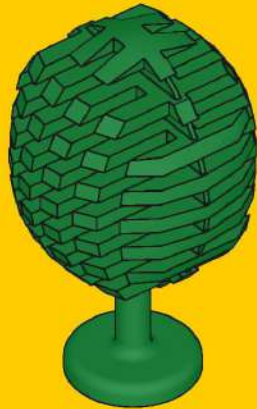

2x  
3470, 6



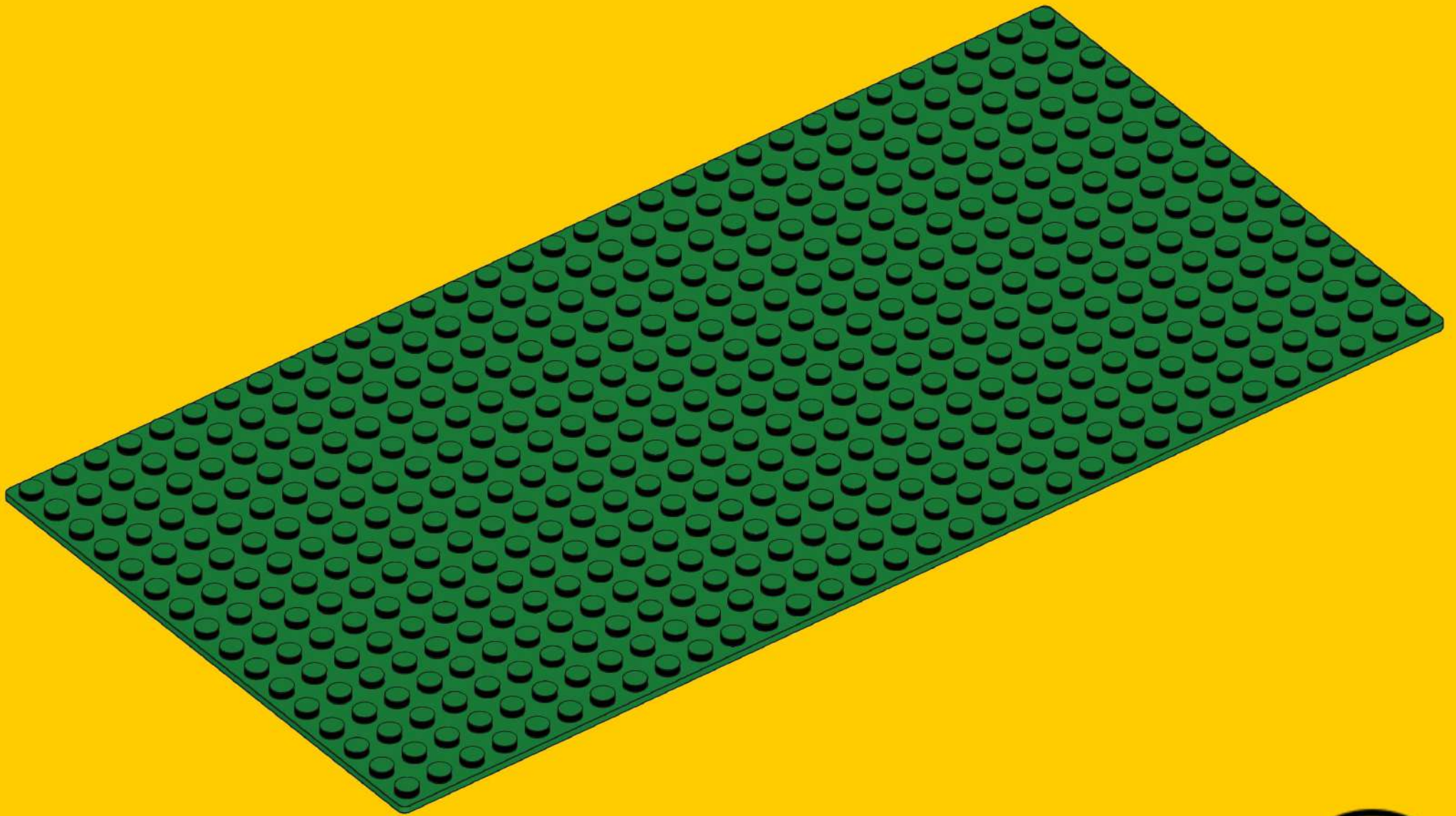

2x  
3857, 6



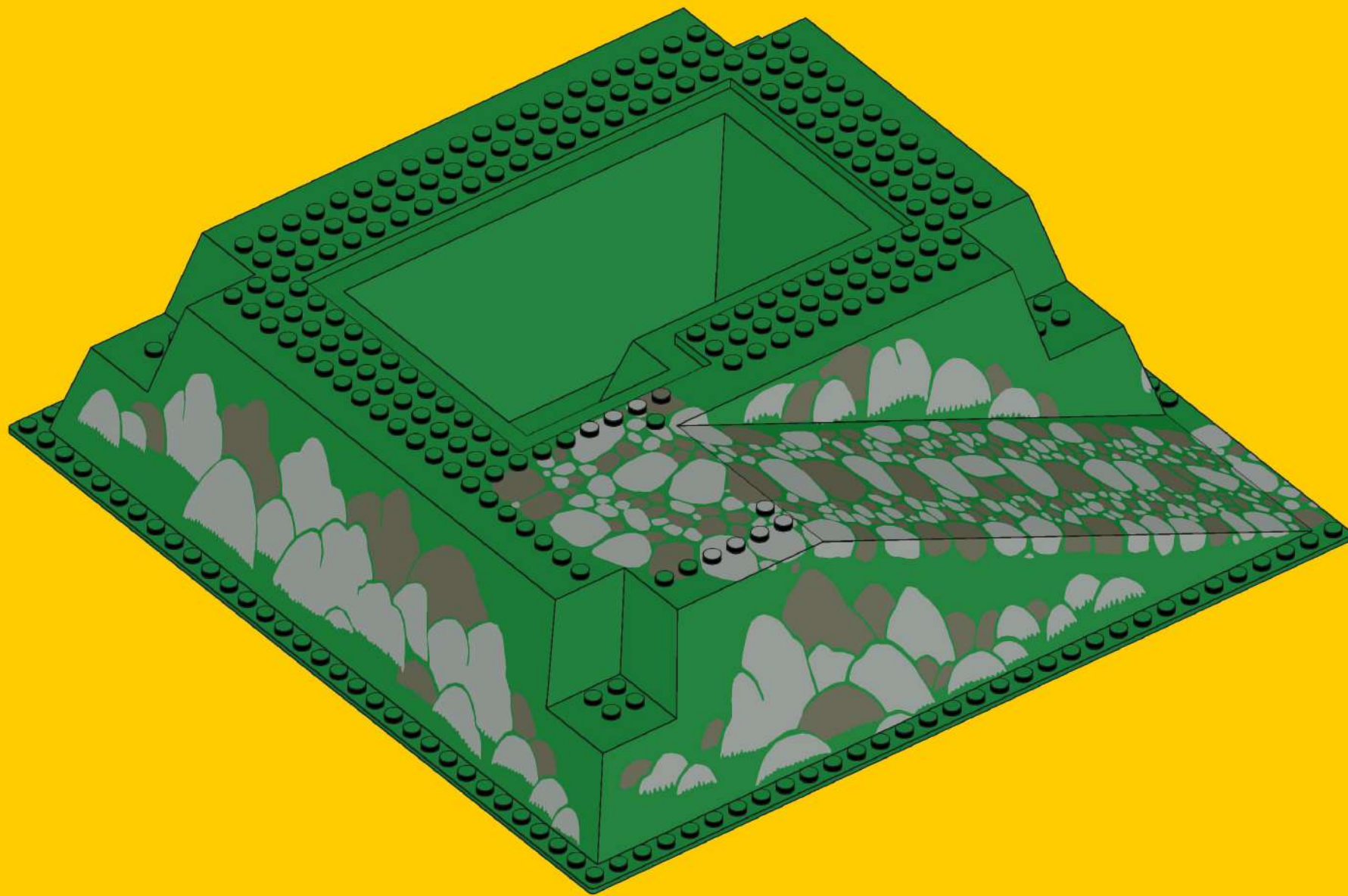

4x  
3005, 7



22x  
981, 7



22x  
982, 7



2x  
4085a, 7



2x  
3023, 7



15x  
972, 7



15x  
971, 7



1x  
4502b, 7



1x  
2552px6, 6



1x  
970, 7

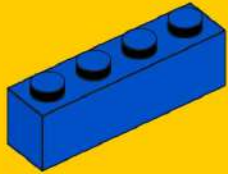

1x  
3010, 7



3x  
973p40, 7

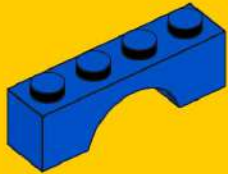

1x  
3659, 7



7x  
973p43, 7



1x  
4589, 19



1x  
2335px9, 7

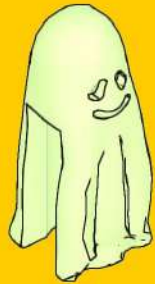

1x  
2888, 46



7x  
4495a, 7

