

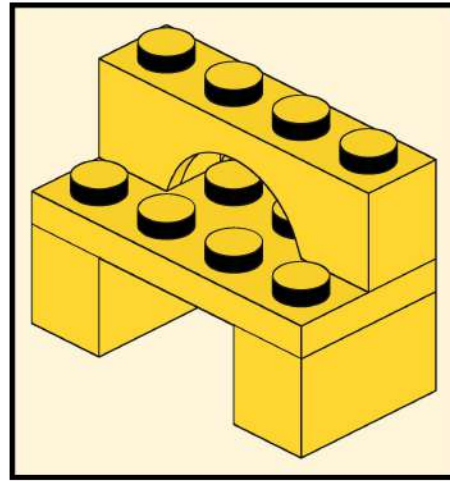

1

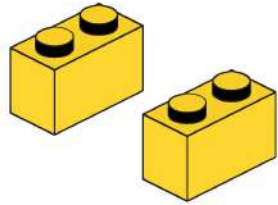
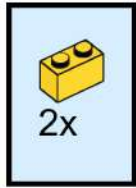

2x

3

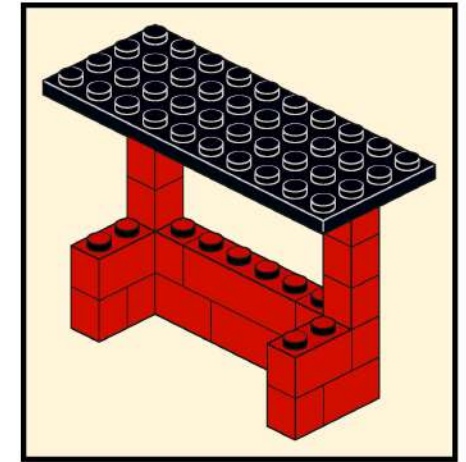
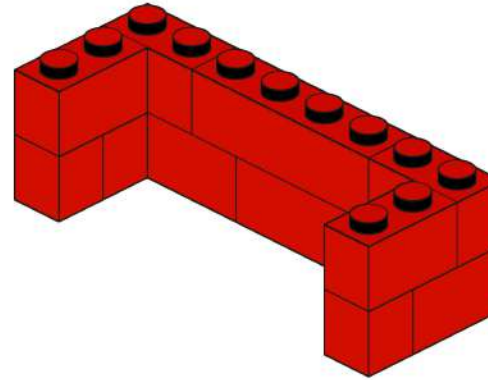
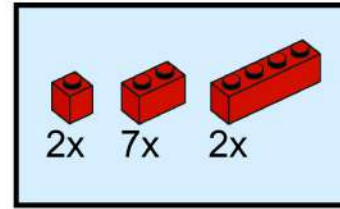

2

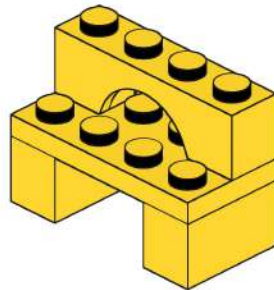
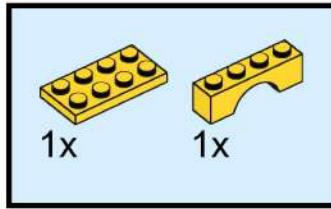

4

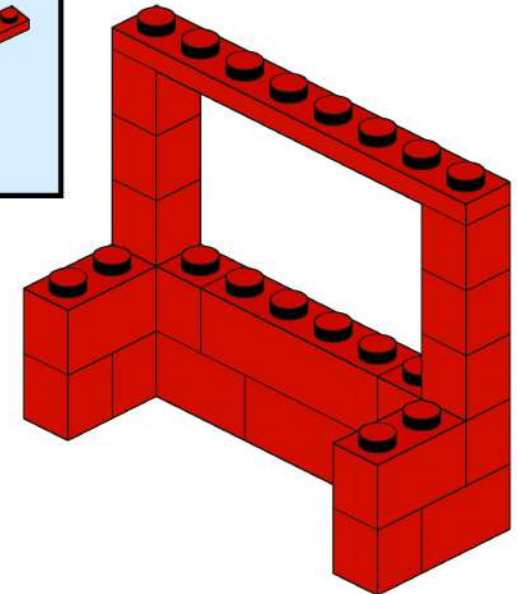
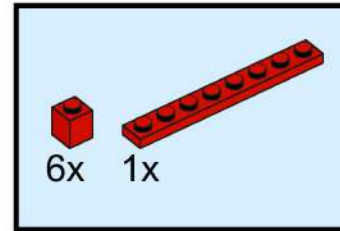

5

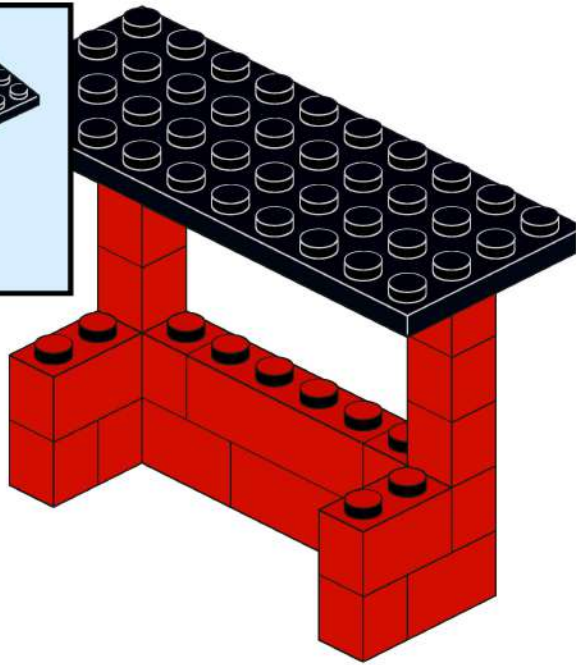
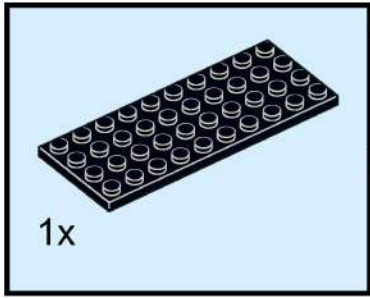

7



6

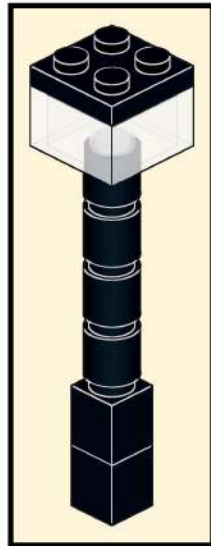
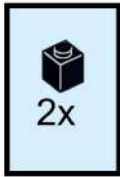

3x

8

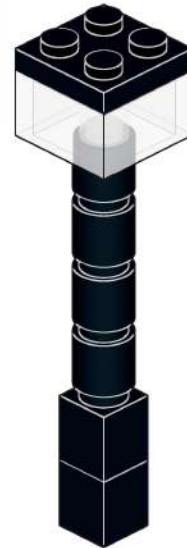
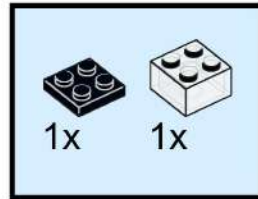

9

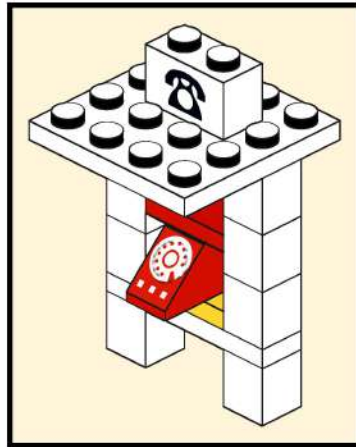
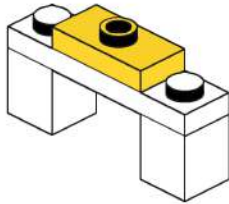
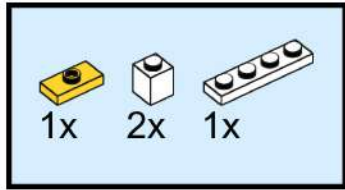

11

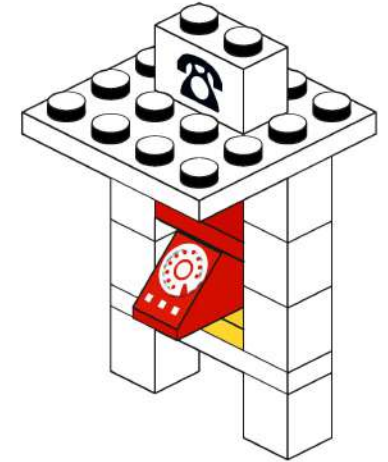
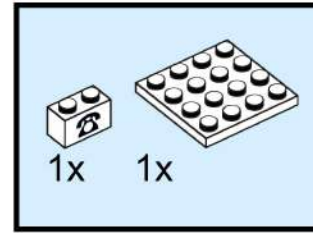

10

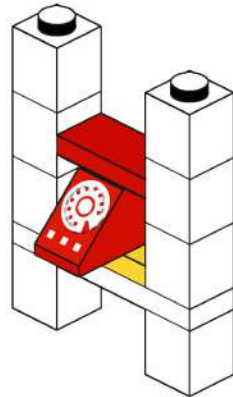
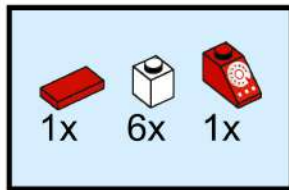

12

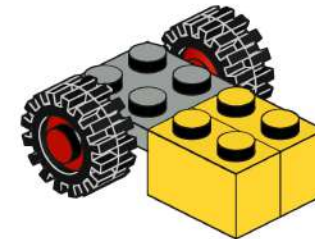
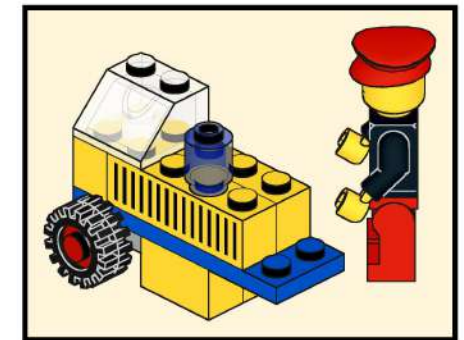
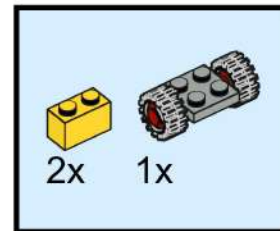

13

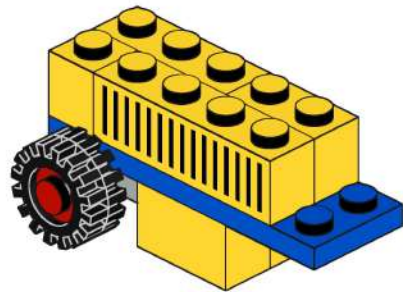
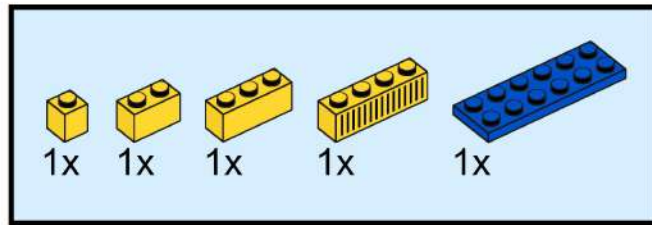

15

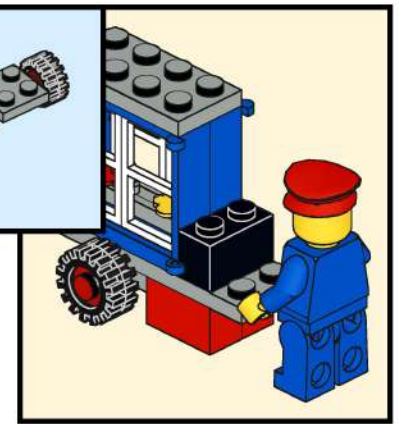
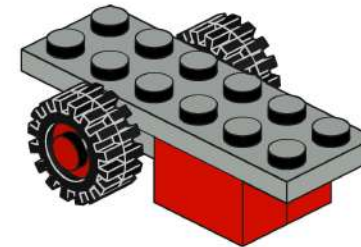
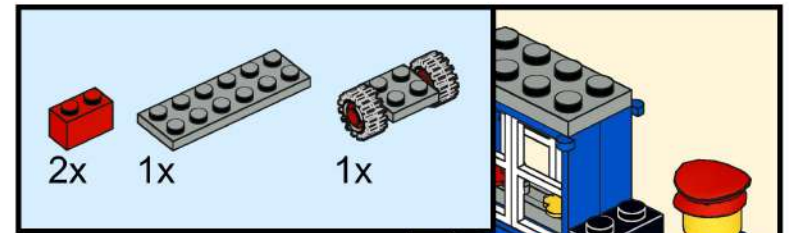

14

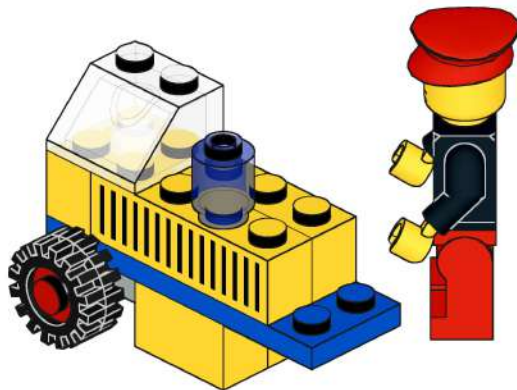
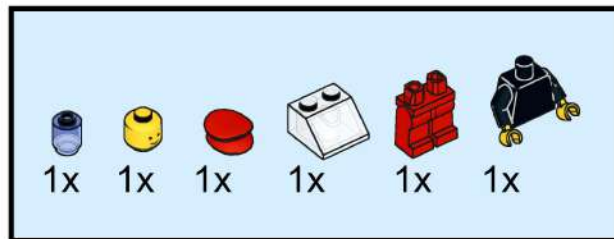

16

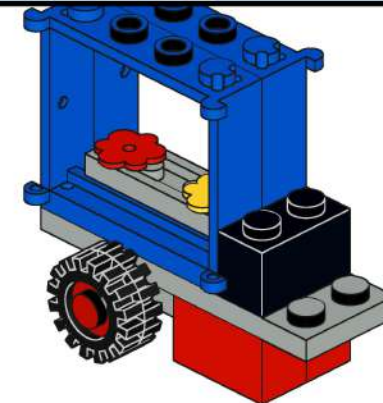
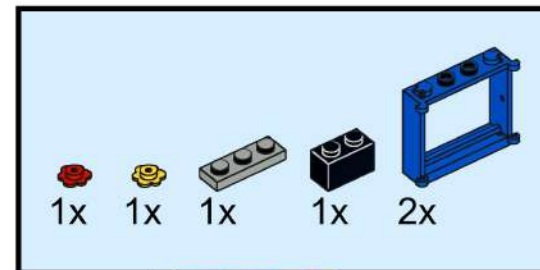

17

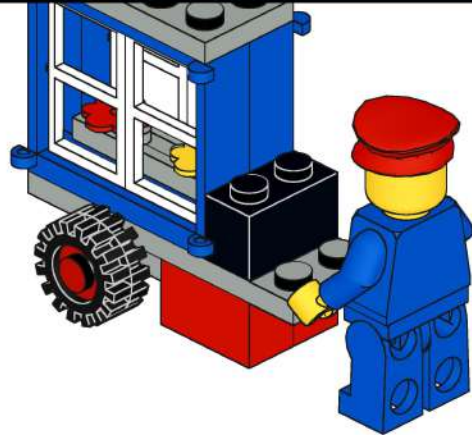
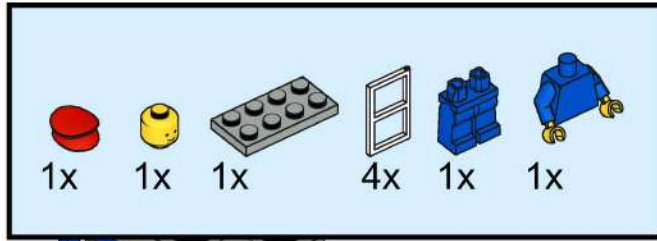

19

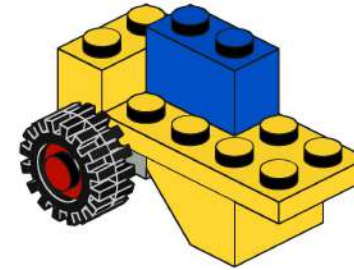
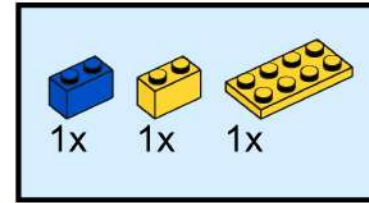

18

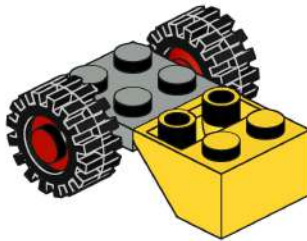
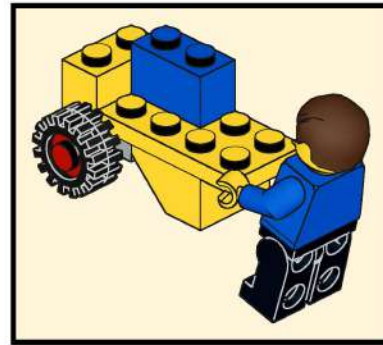
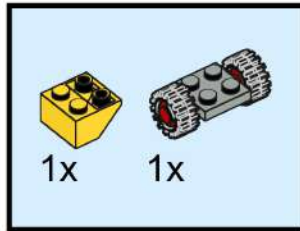

20

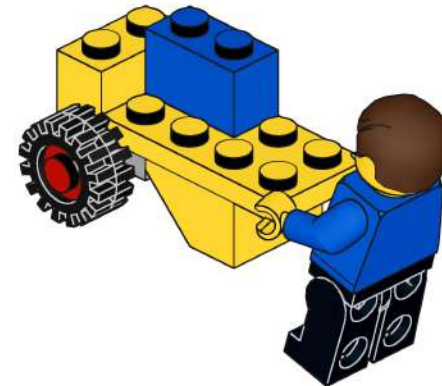
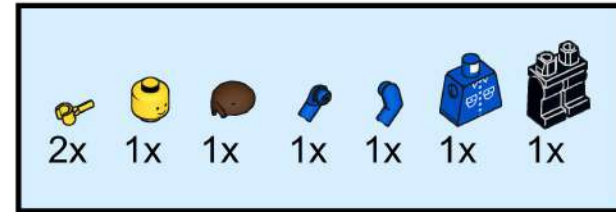

21

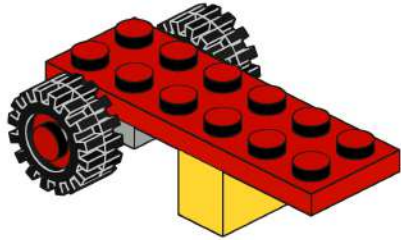
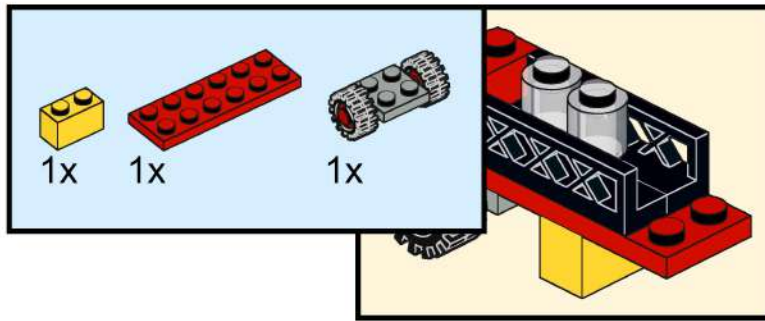

23

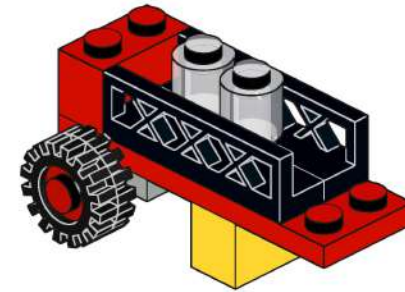

22

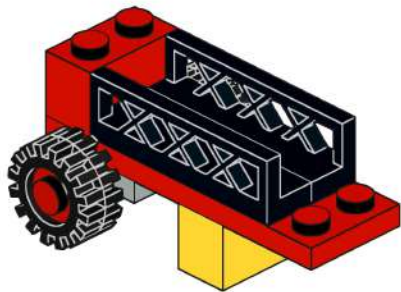
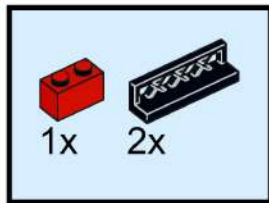

24

