

1

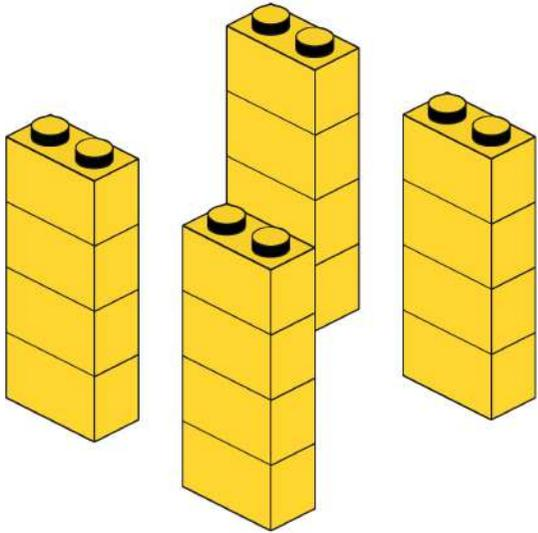

2

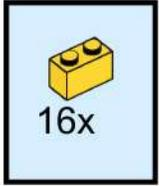
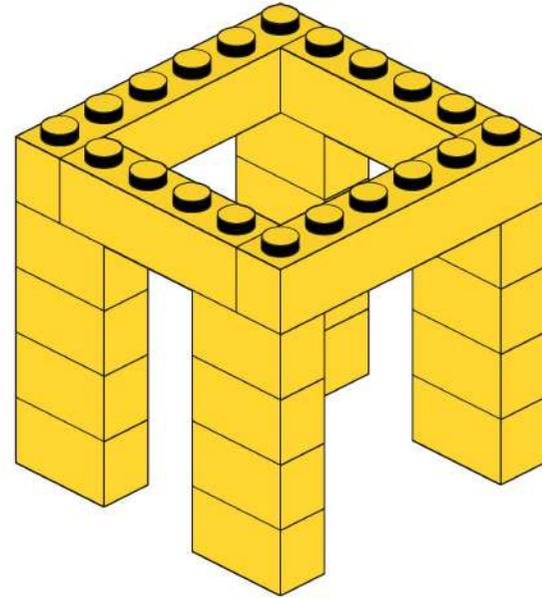
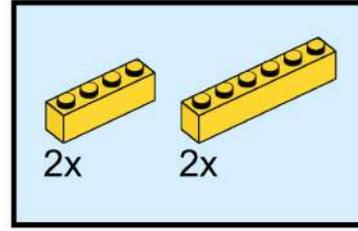

3

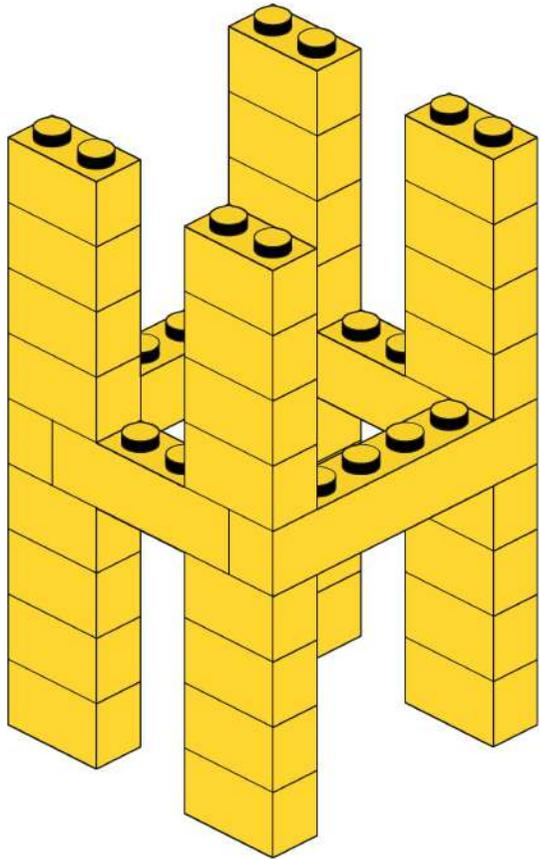
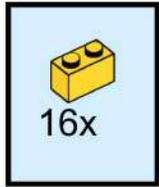

4

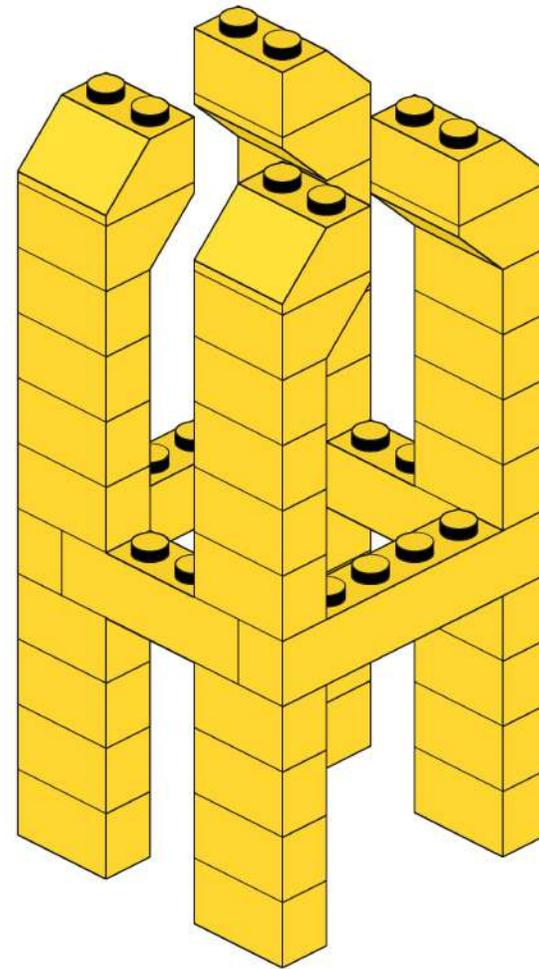
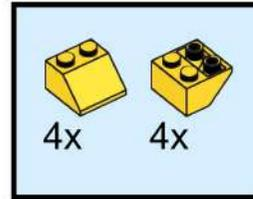

5

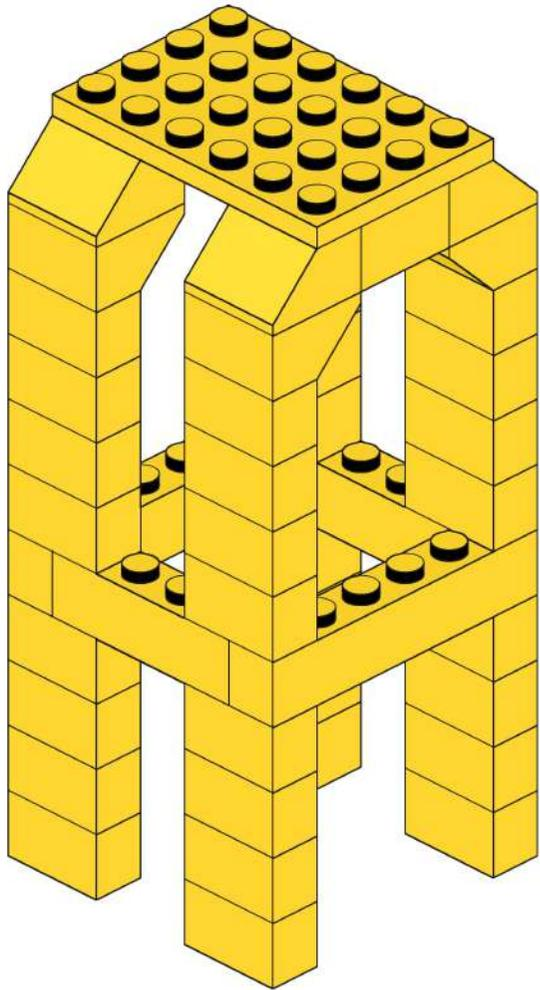
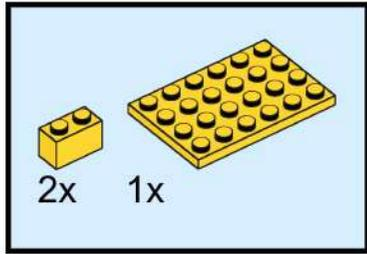

6

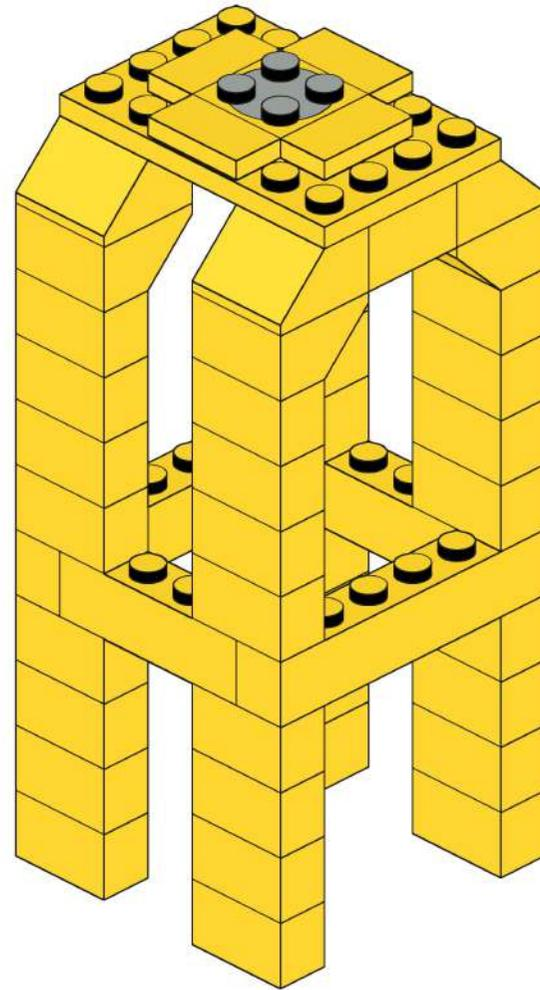
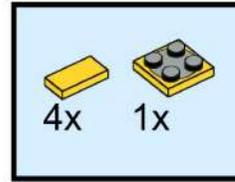

7

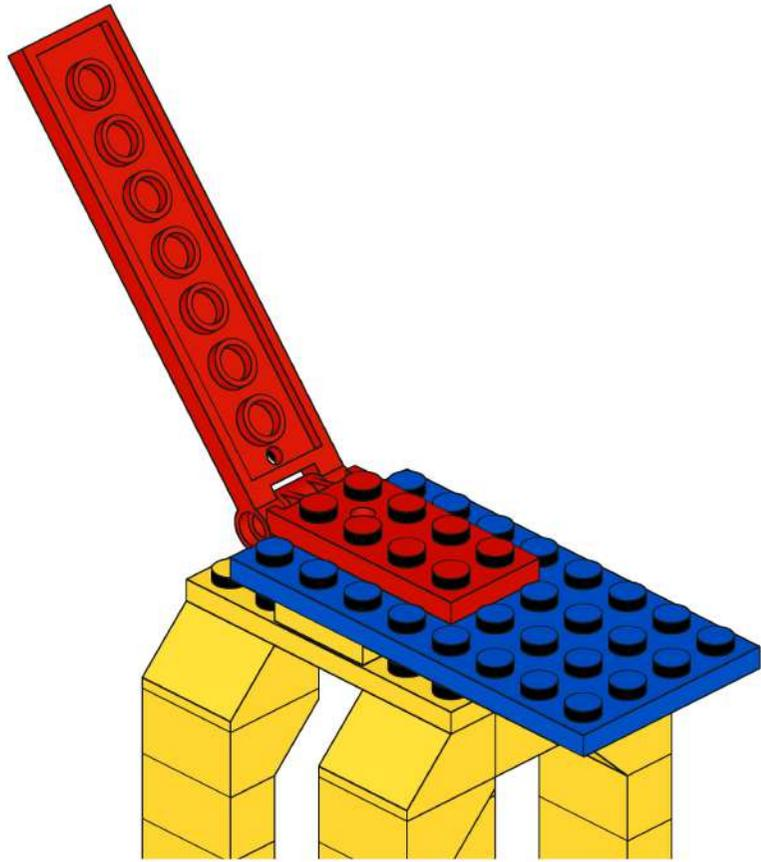
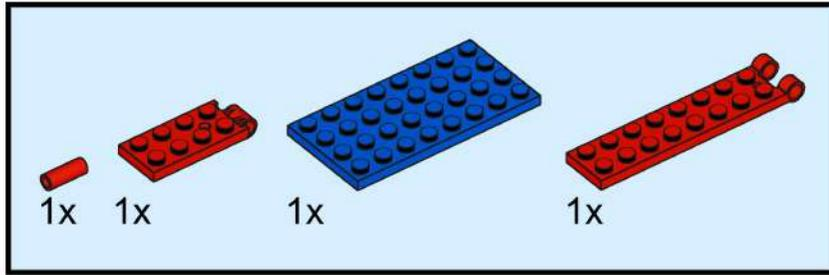

8

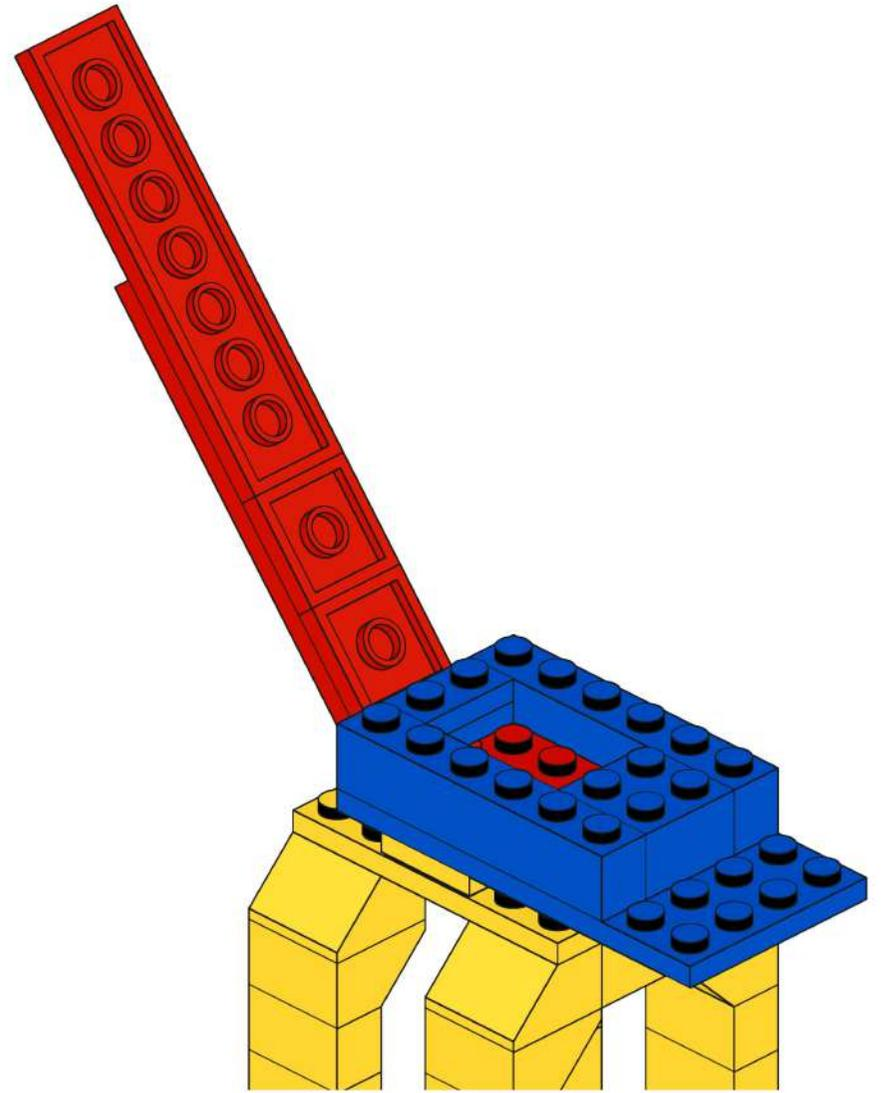
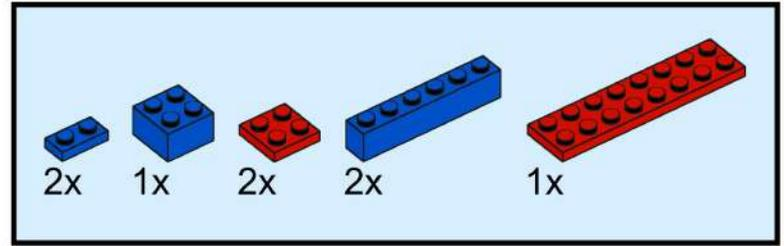

# 9

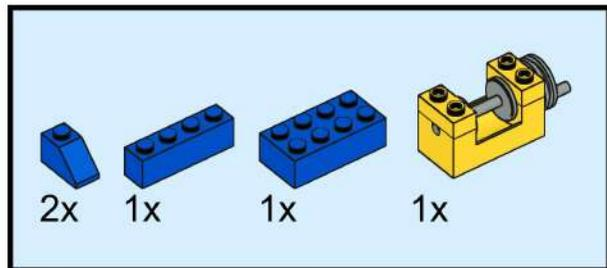

Tie the string to the drum. String is not shown in these instructions because it is not available in Studio. See photo on page 28 of Idea Book 6000 to find out where to attach the string.

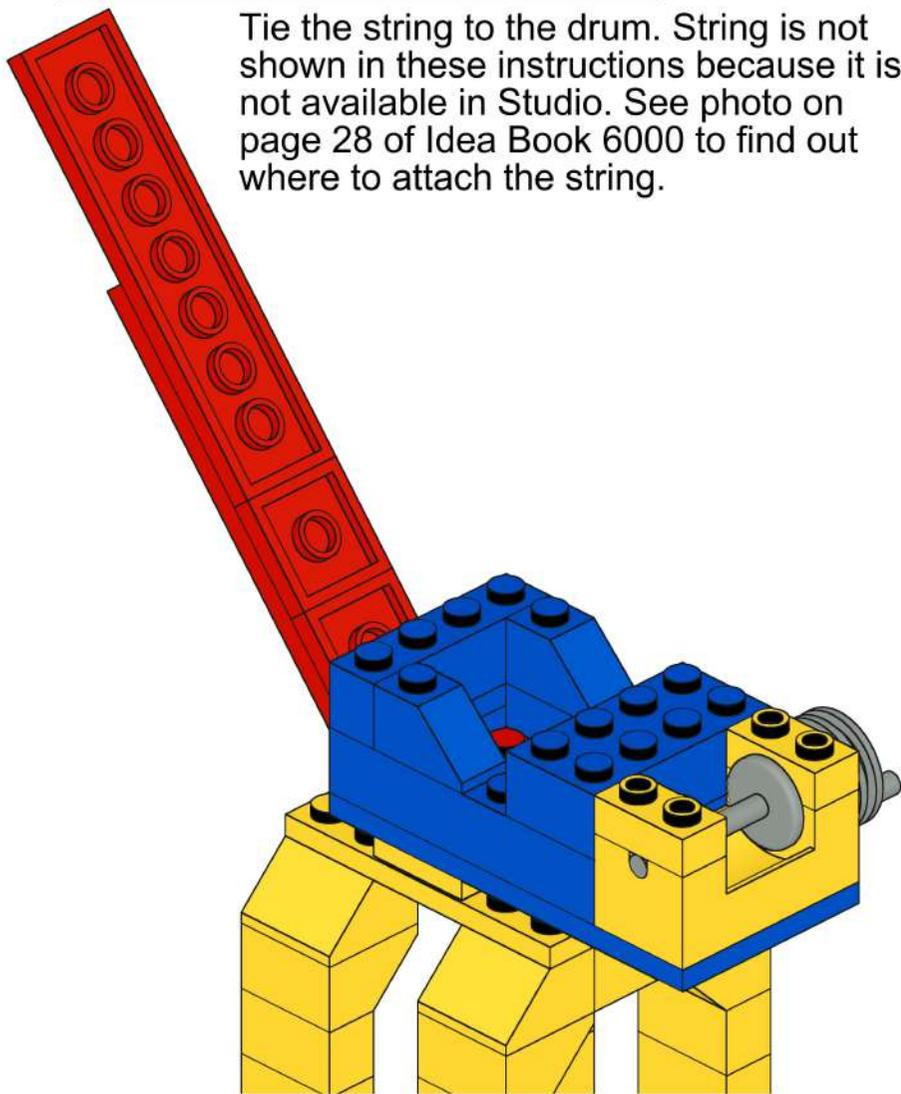

# 10

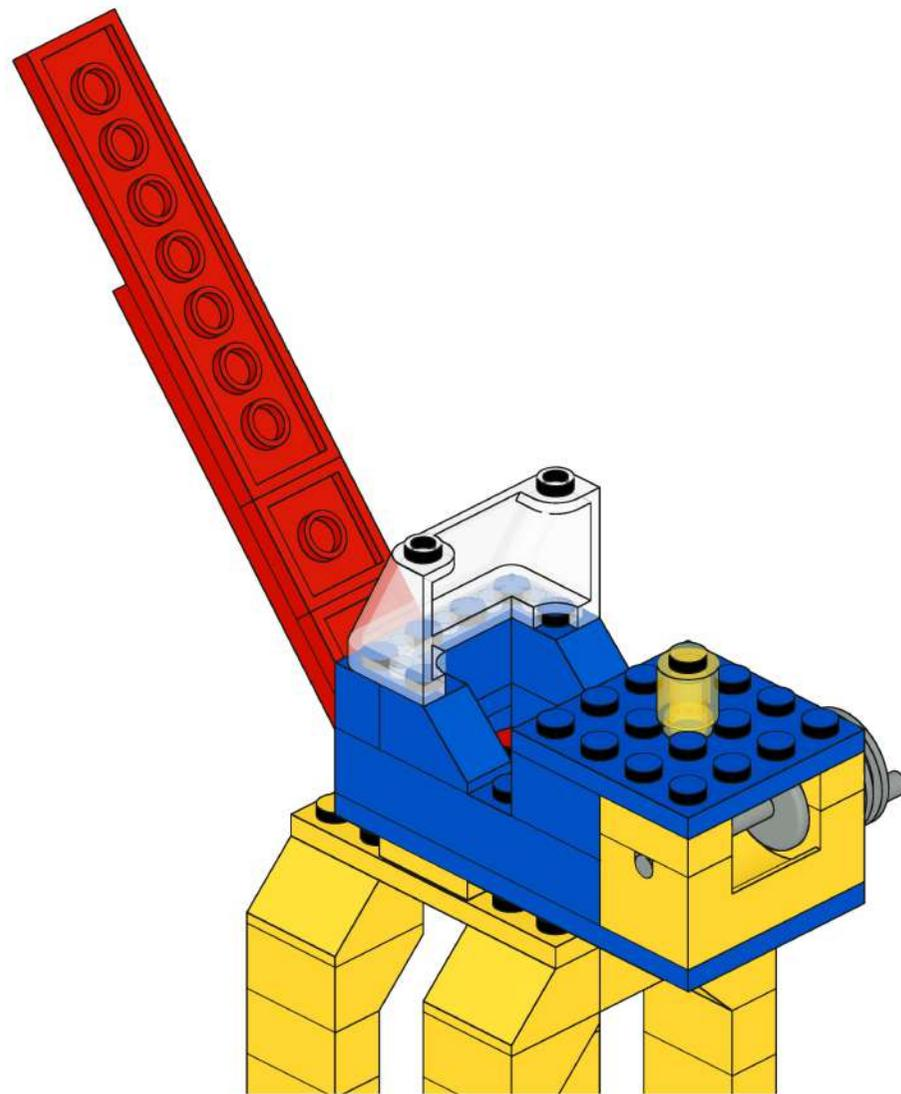
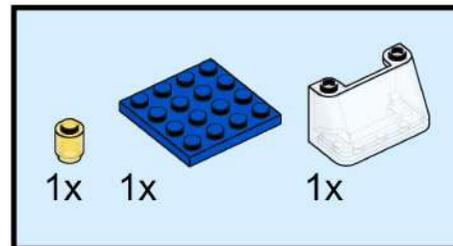

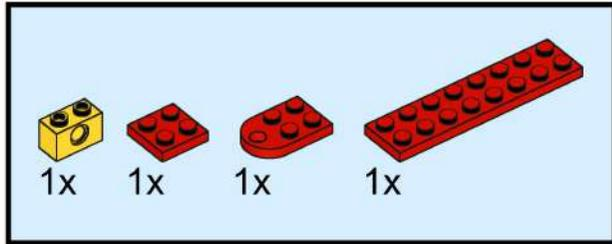

Loop the string through the hole at the top and tie it to the technic brick. See photo on page 28 of Idea Book 6000.

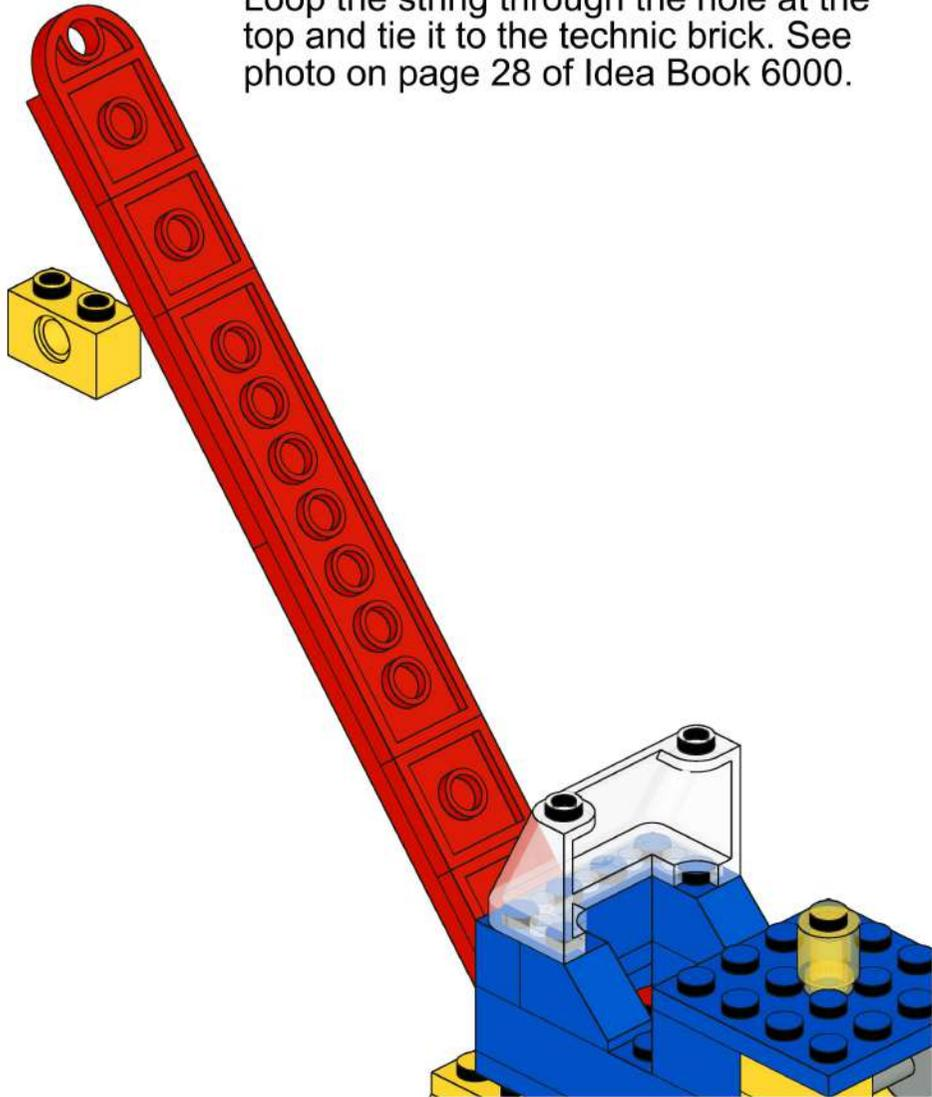

- |                 |                   |                 |                       |
|-----------------|-------------------|-----------------|-----------------------|
| 1x 313 Red      | 34x 3004 Yellow   | 1x 73037 Yellow | 1x 3031 Blue          |
| 3x 3022 Red     | 1x 3700 Yellow    | 1x 3032 Yellow  | 2x 3009 Blue          |
| 1x 3176 Red     | 1x 3680c01 Yellow | 1x 3035 Blue    | 1x 3823 Trans-Clear   |
| 1x 314 Red      | 4x 3039 Yellow    | 2x 3023 Blue    | 1x 3062a Trans-Yellow |
| 2x 3034 Red     | 4x 3660 Yellow    | 2x 3040 Blue    |                       |
| 1x 3324 Red     | 2x 3010 Yellow    | 1x 3003 Blue    |                       |
| 4x 3069b Yellow | 2x 3009 Yellow    | 1x 3010 Blue    |                       |
|                 |                   | 1x 3001 Blue    |                       |