

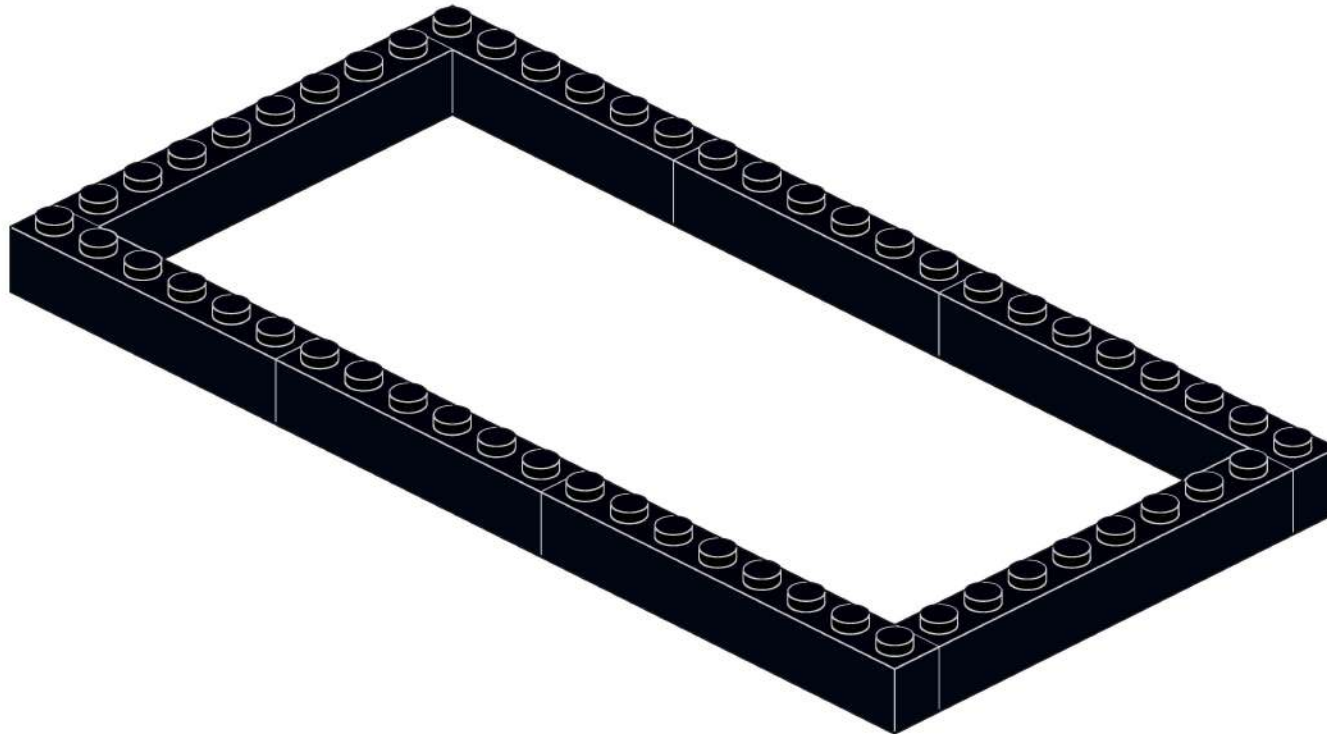

1

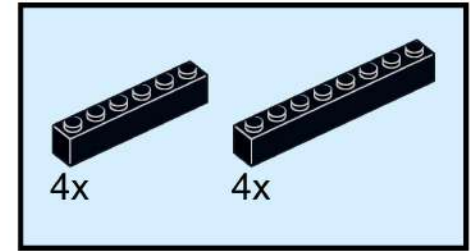

2

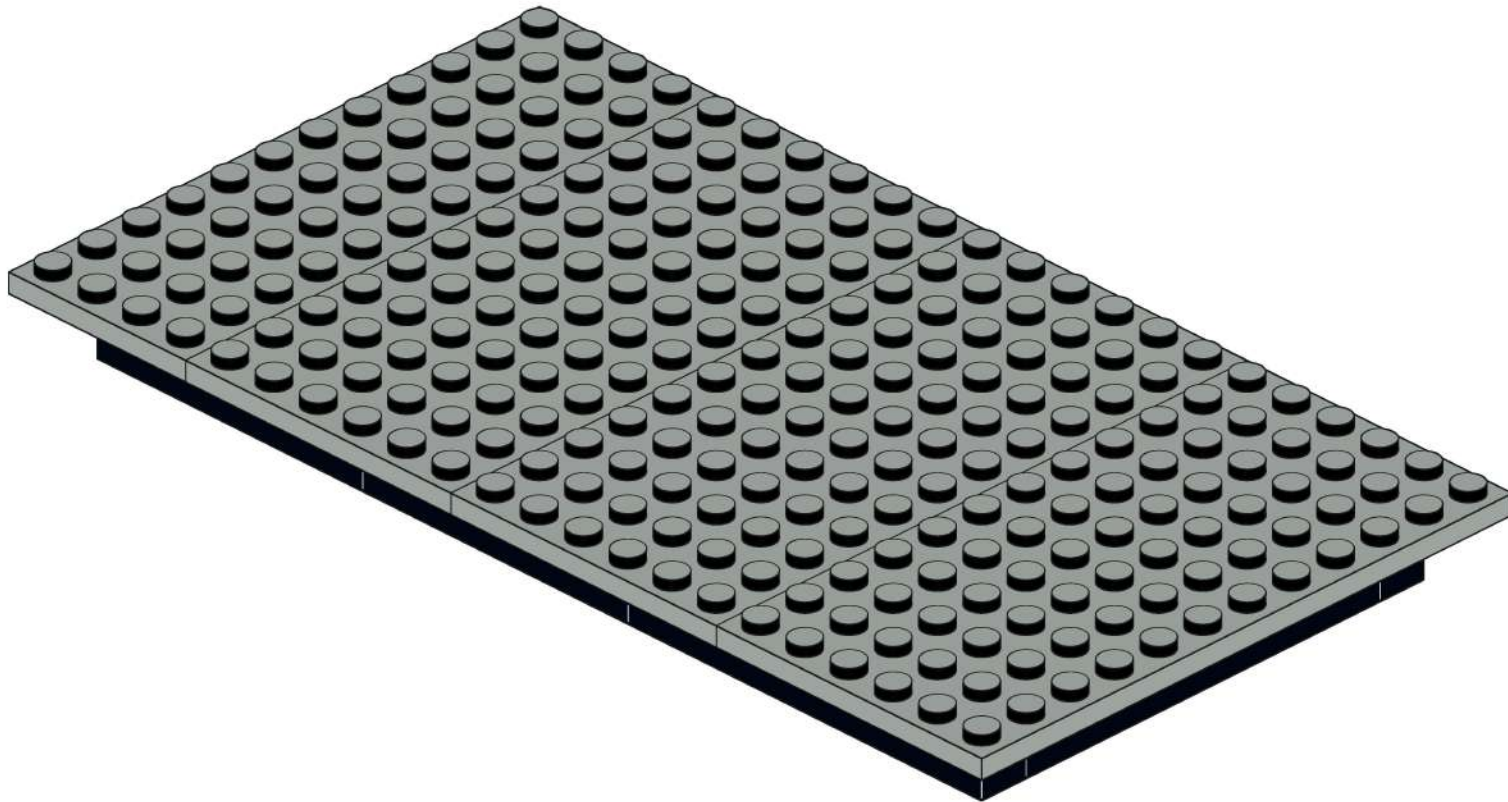
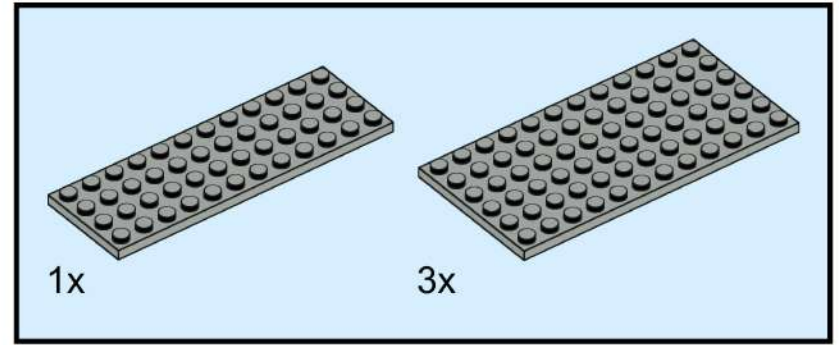

3

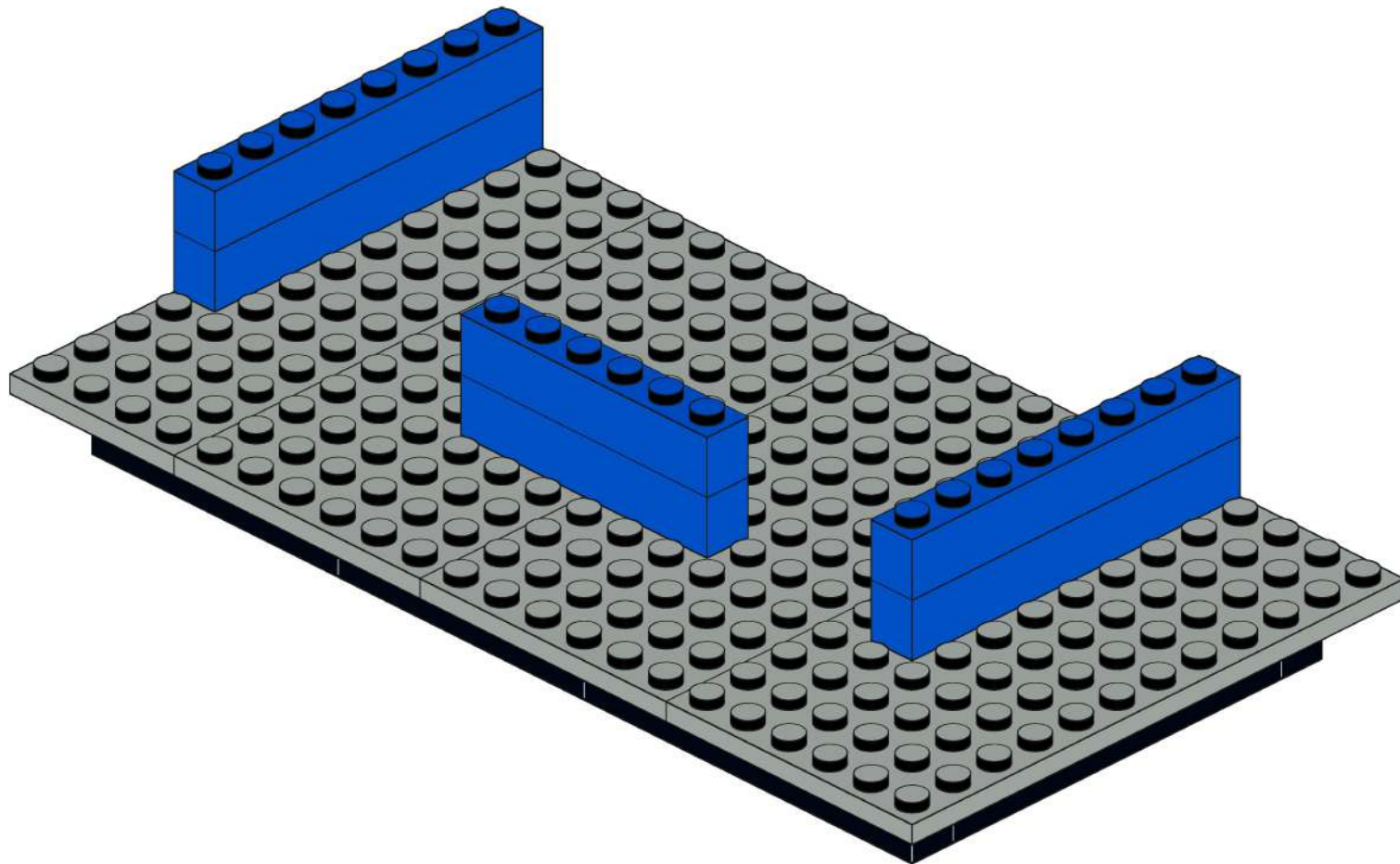
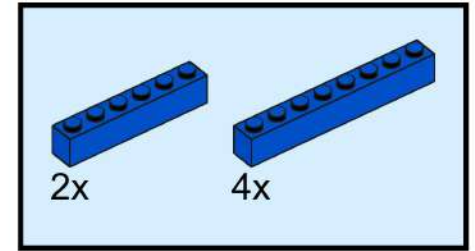

4

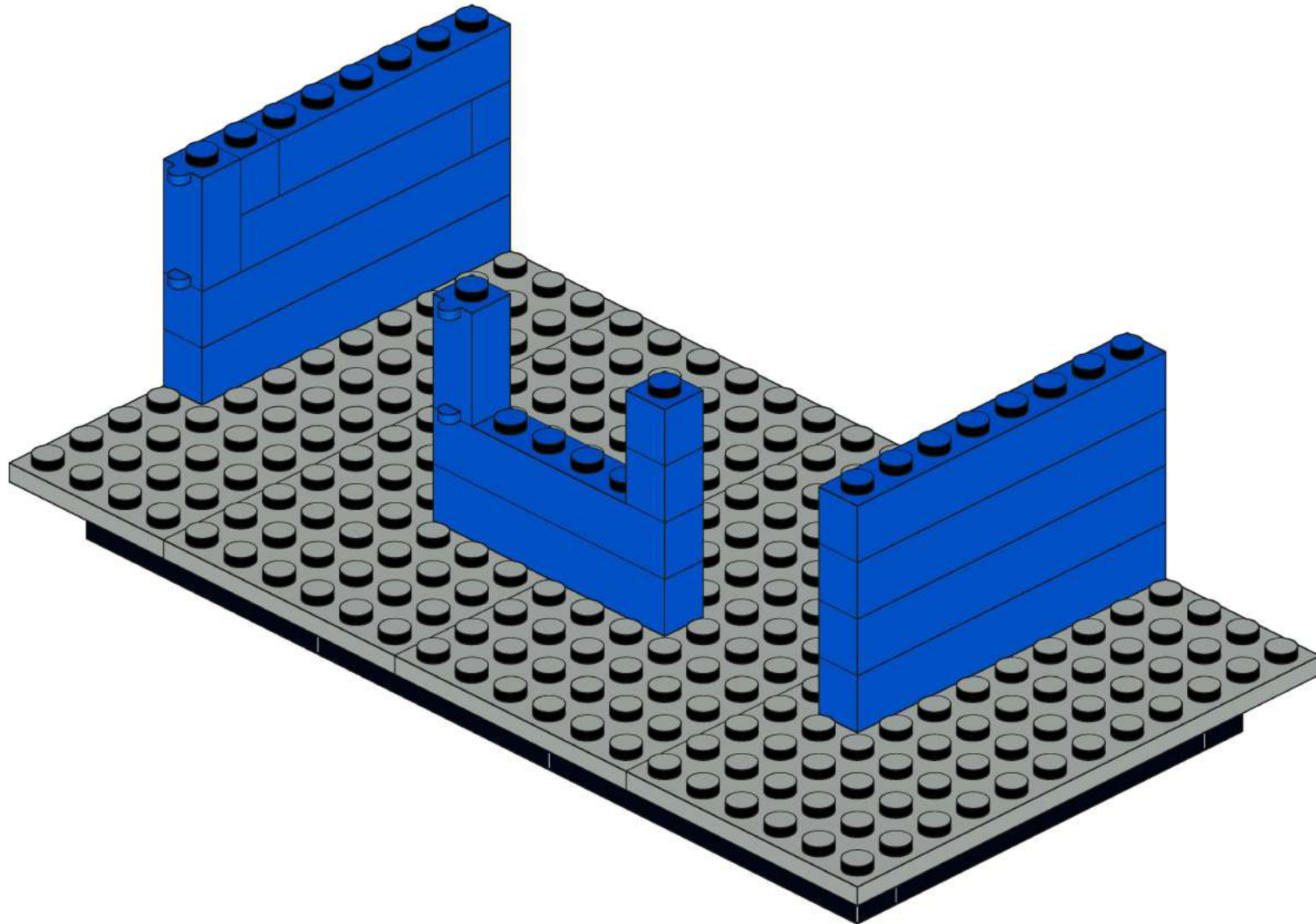
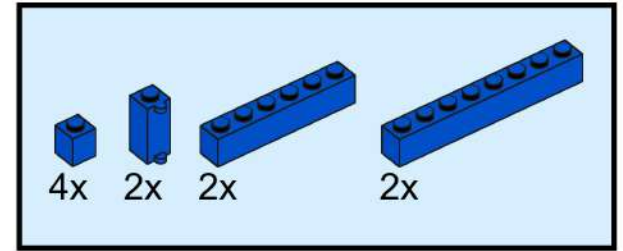

5

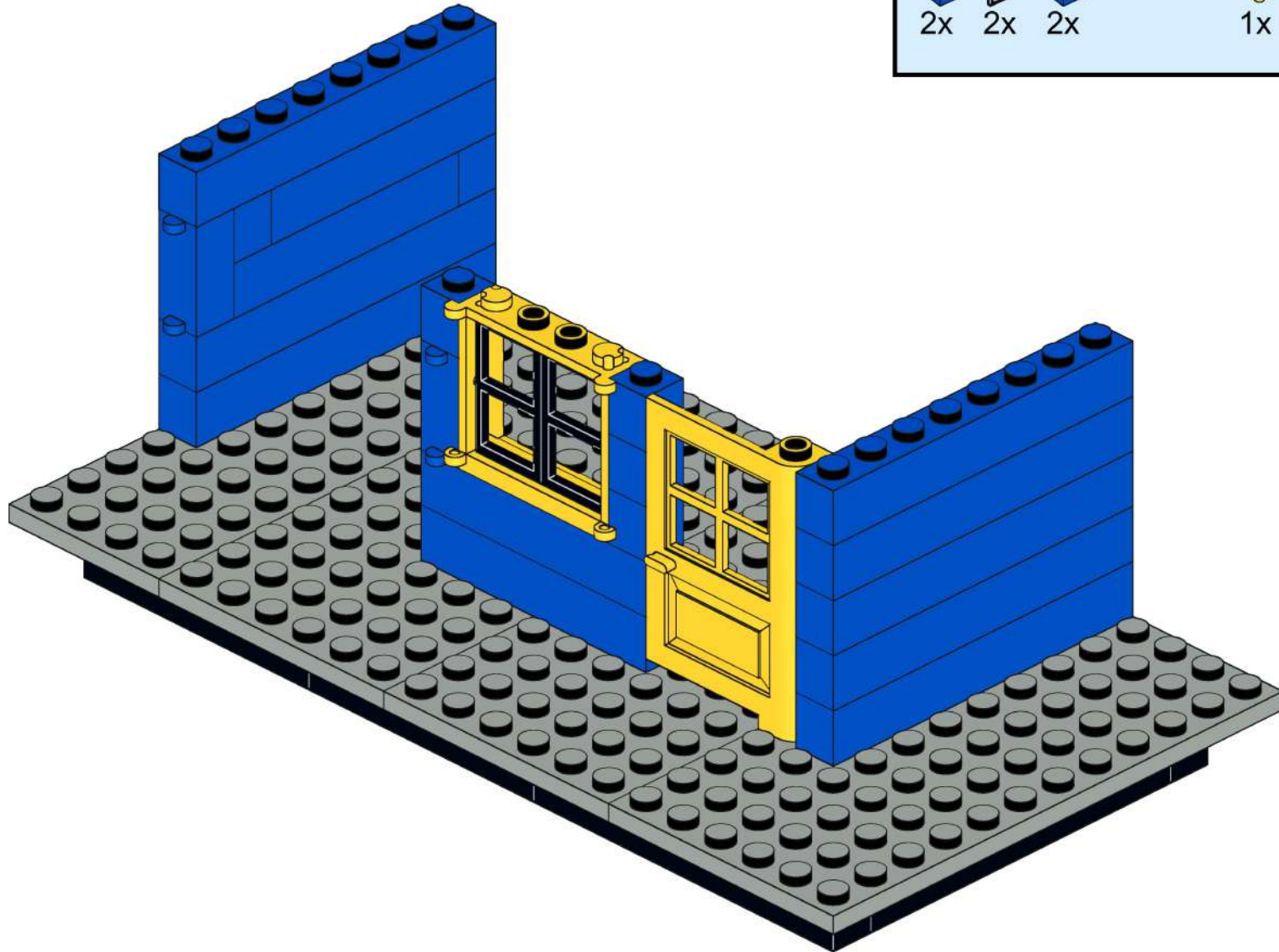
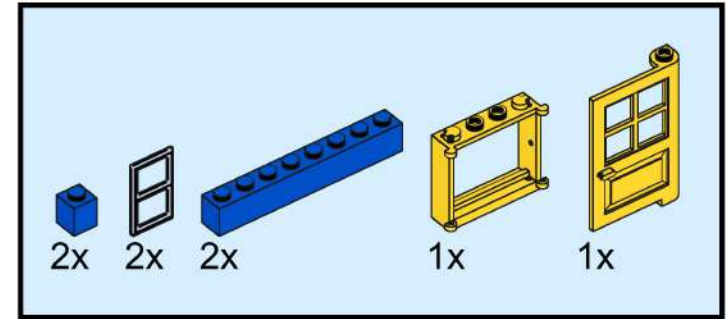

6

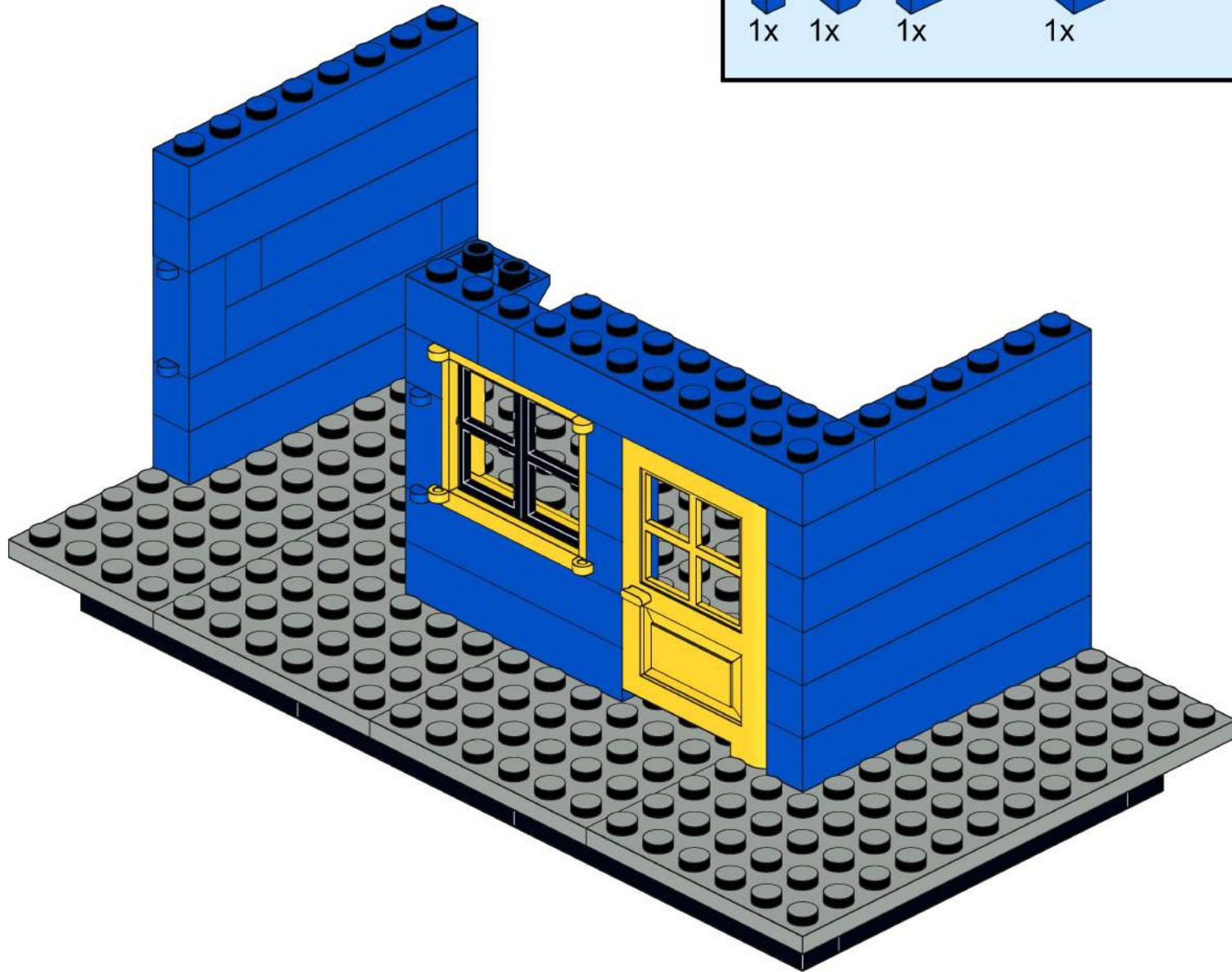
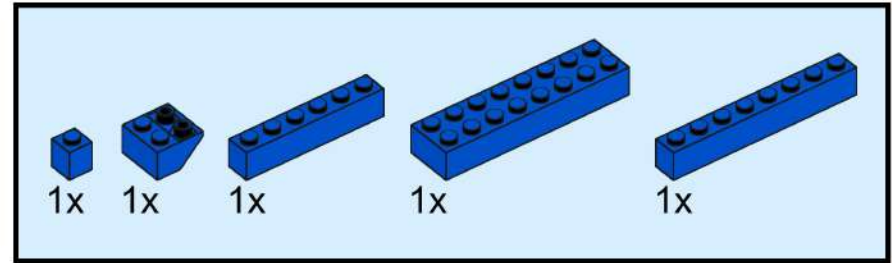

7

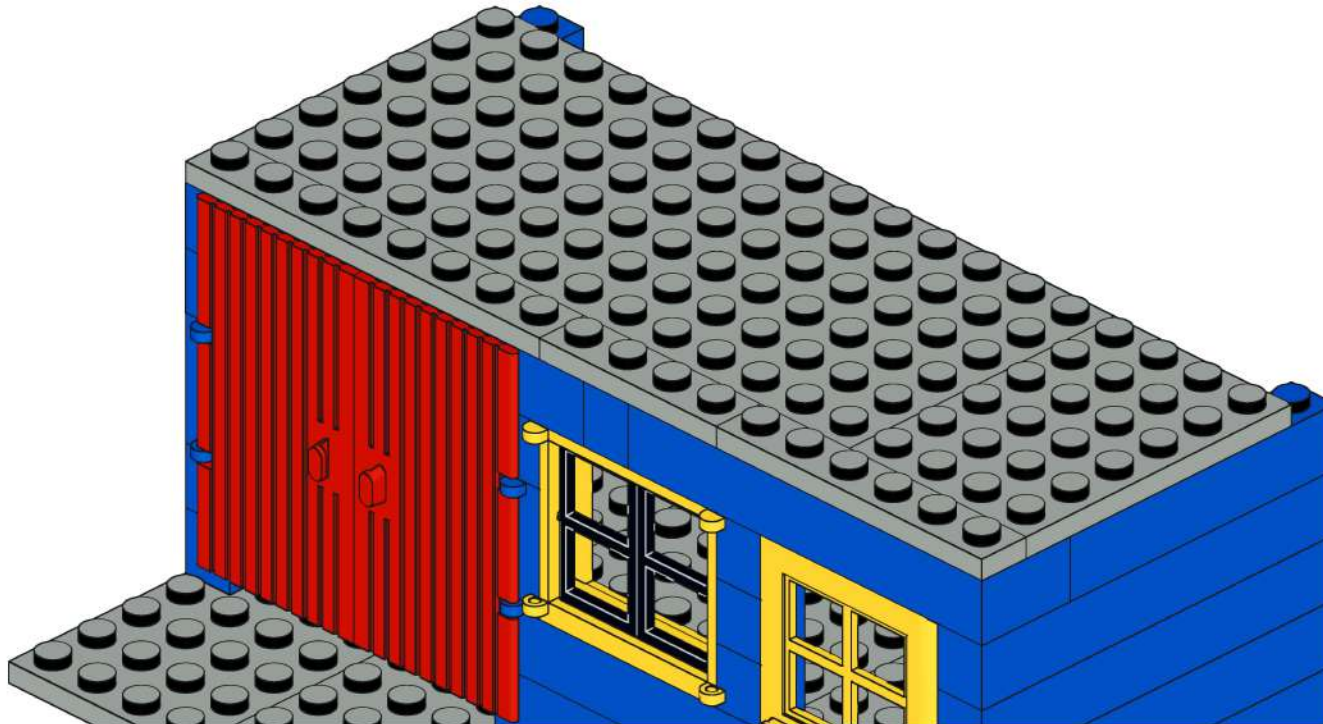
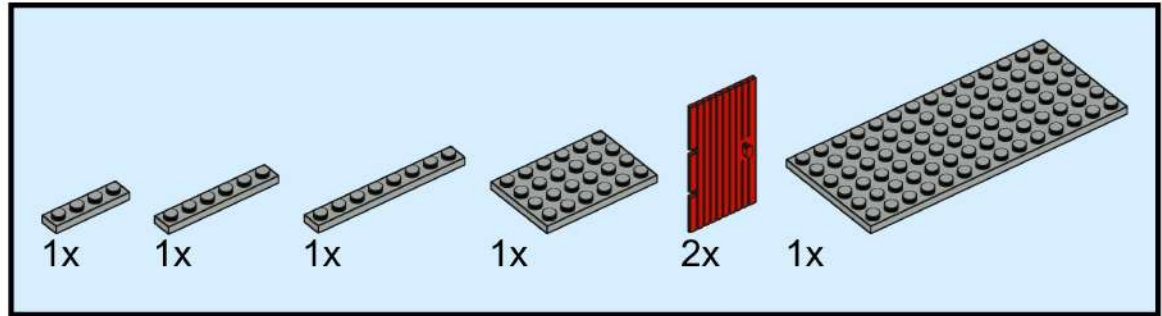

8

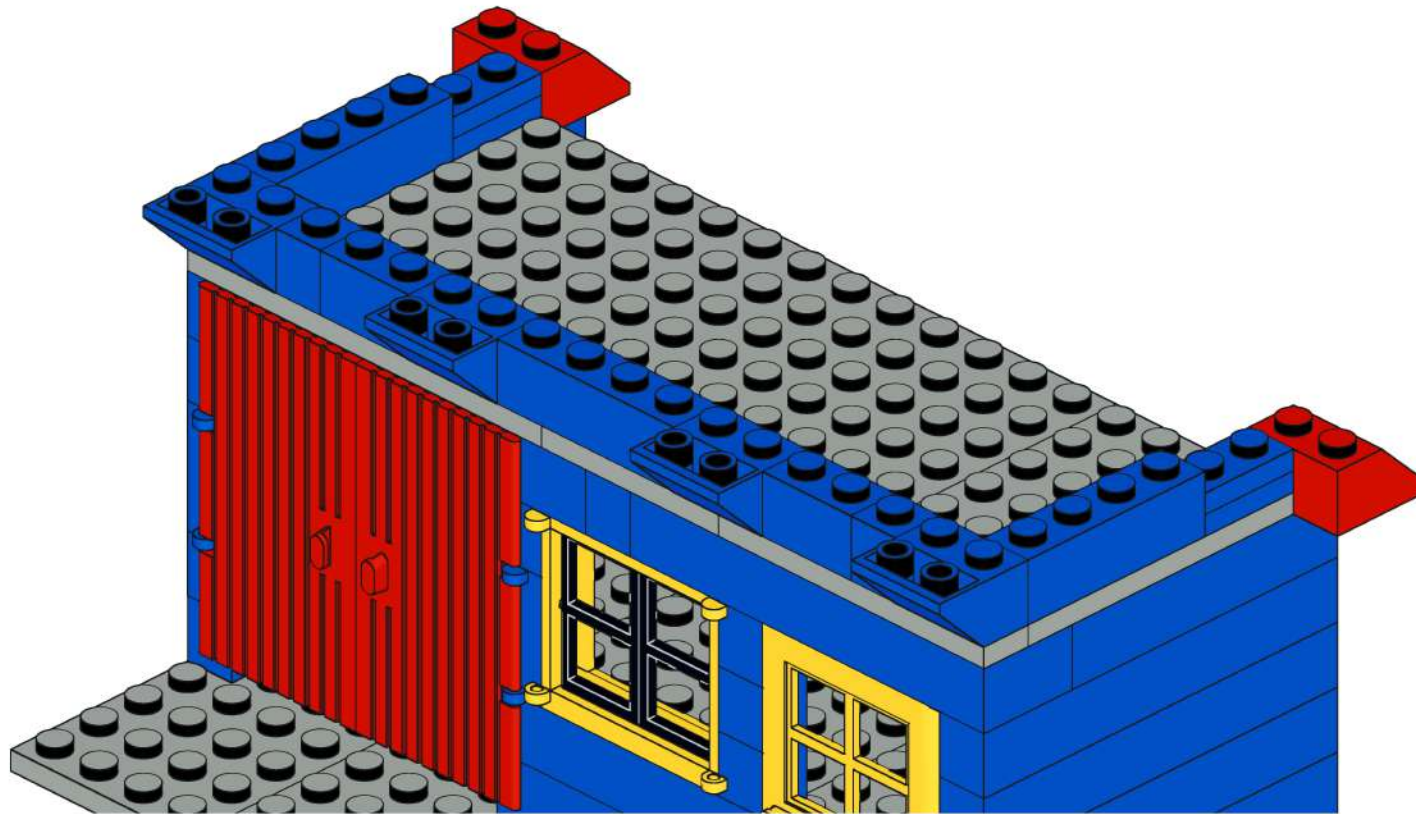
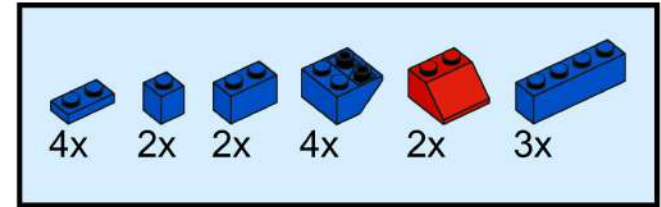

9

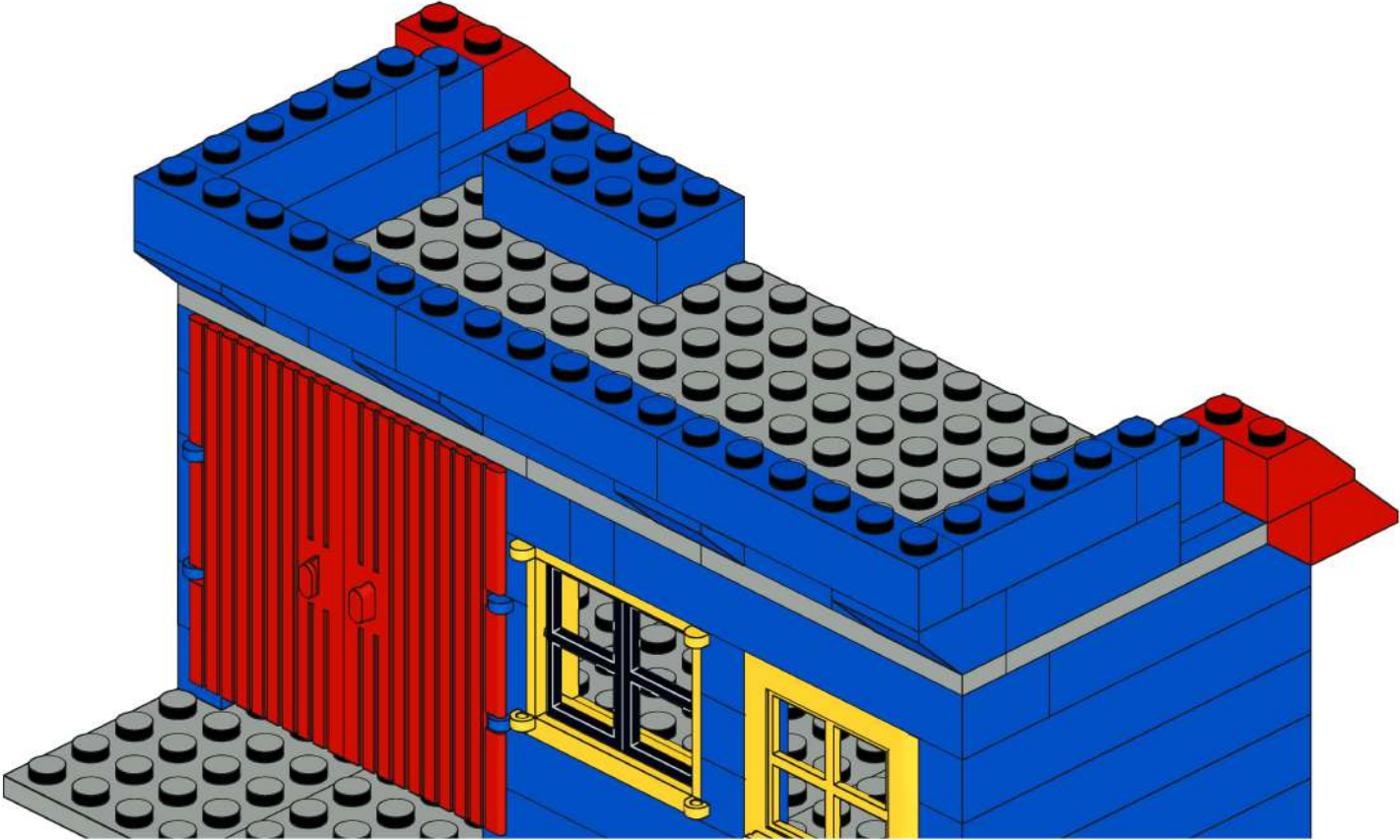
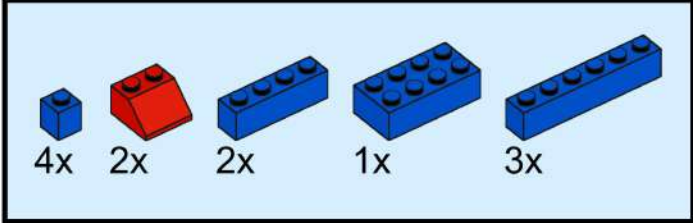

10

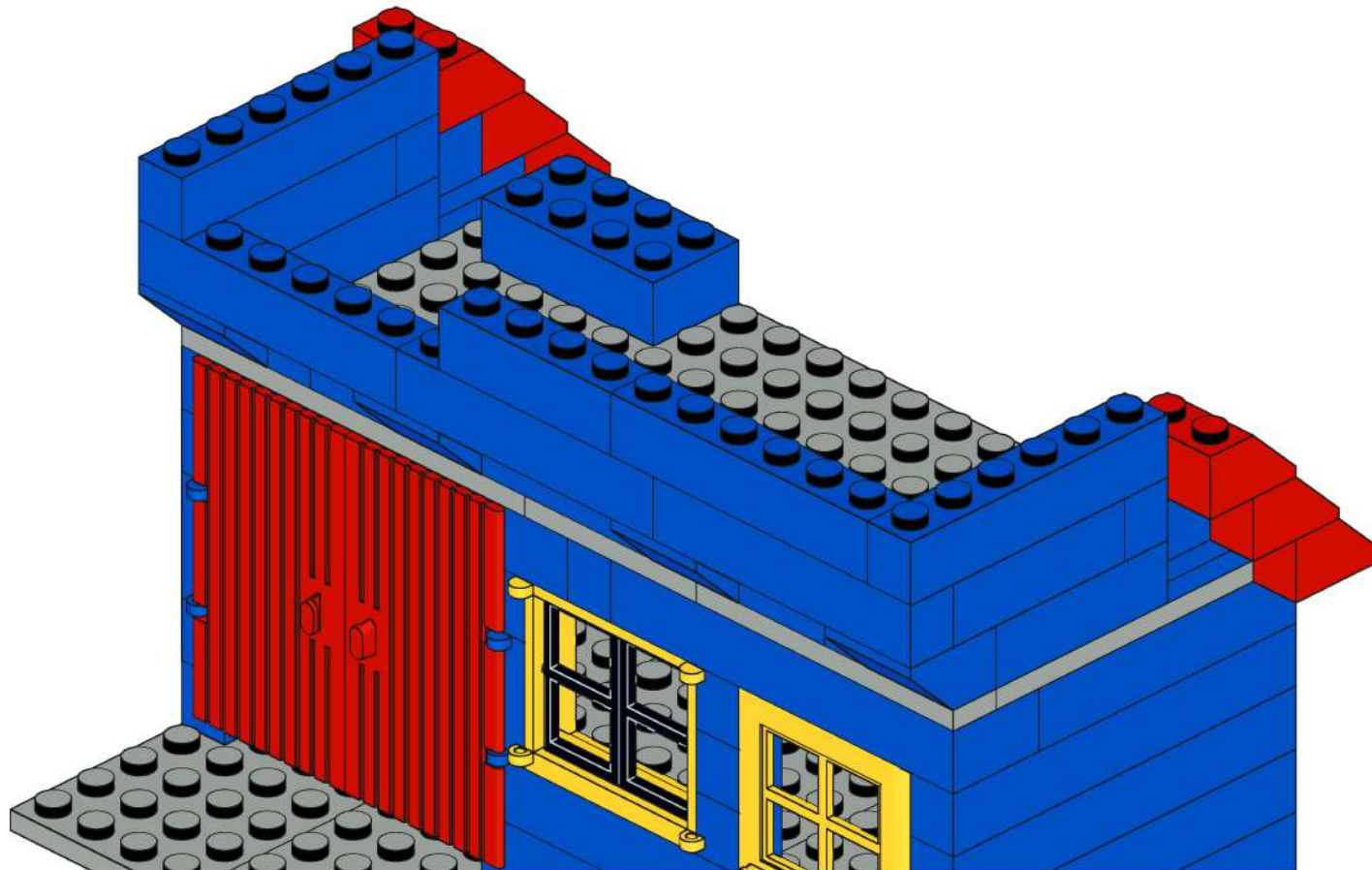
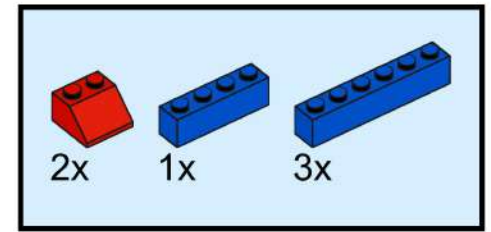

11

Tie the string to the drum reel. String is not shown in these instructions because it is not available in Studio.

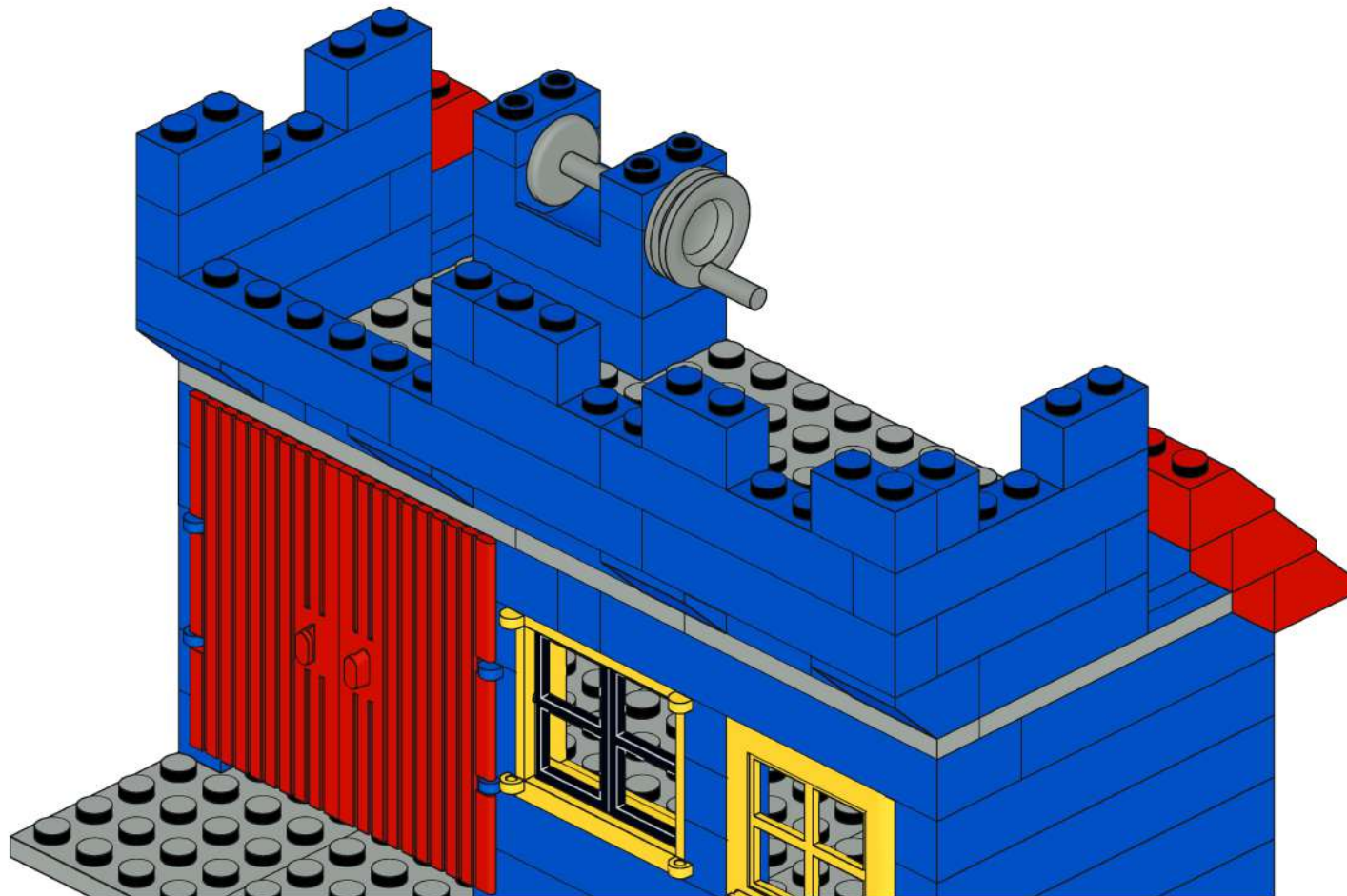
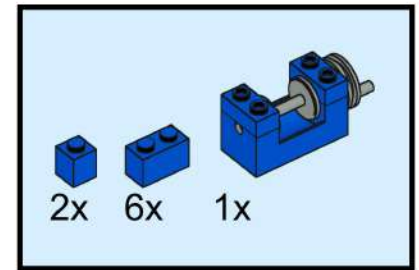

12

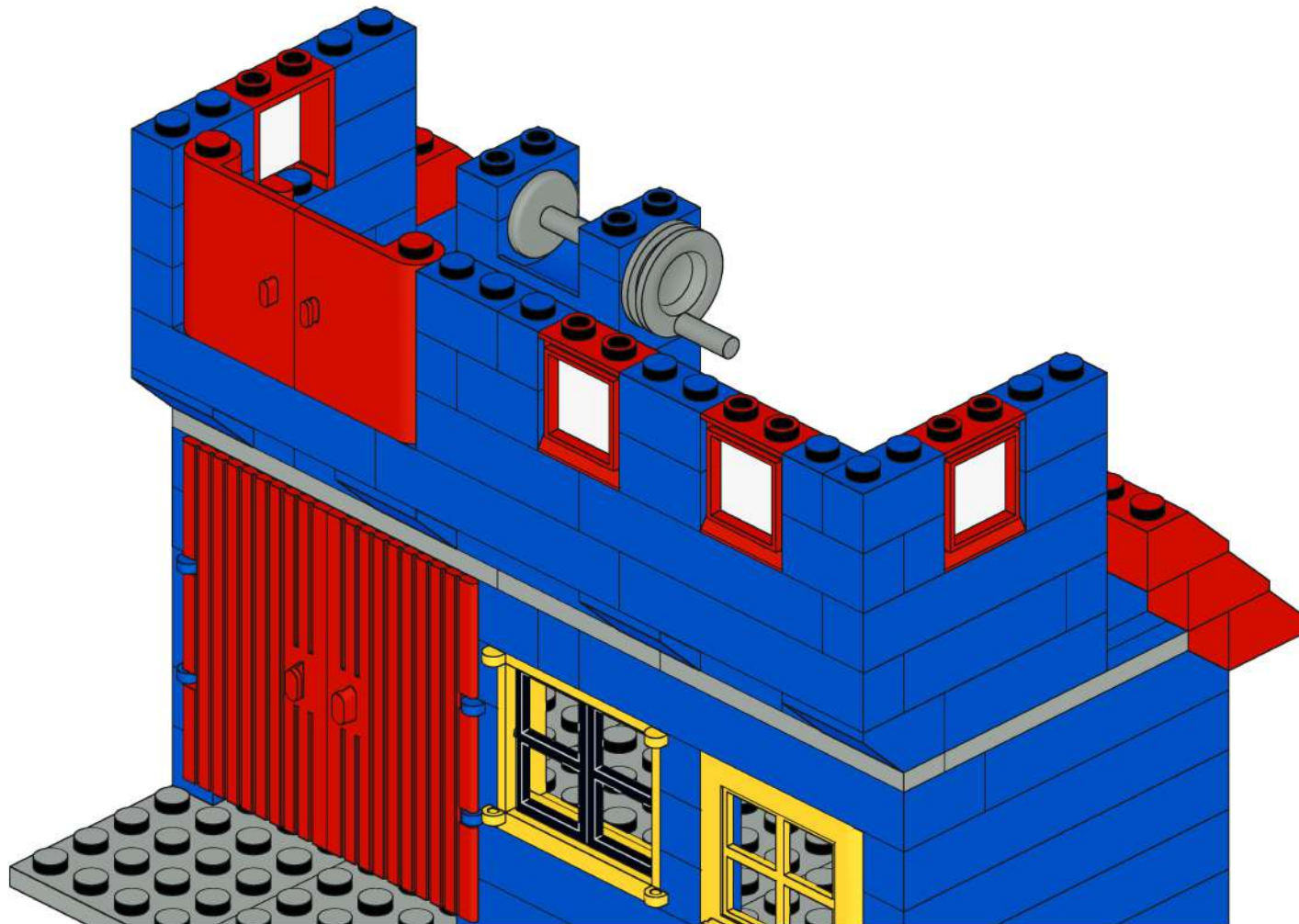
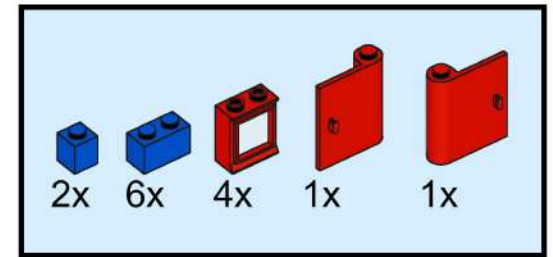

13

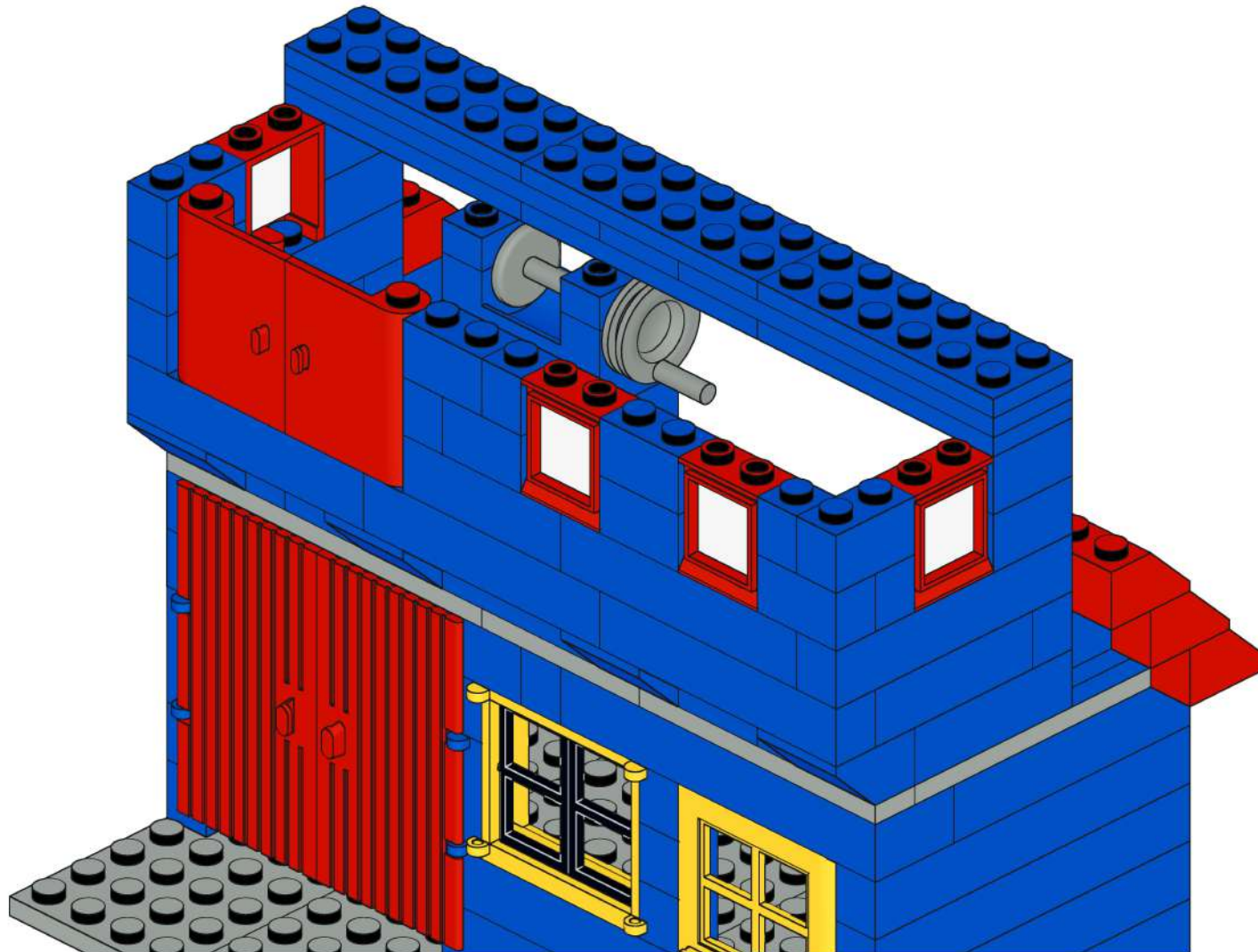
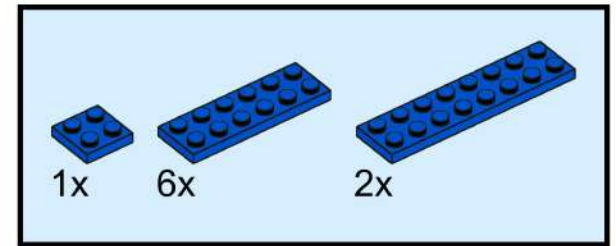

14

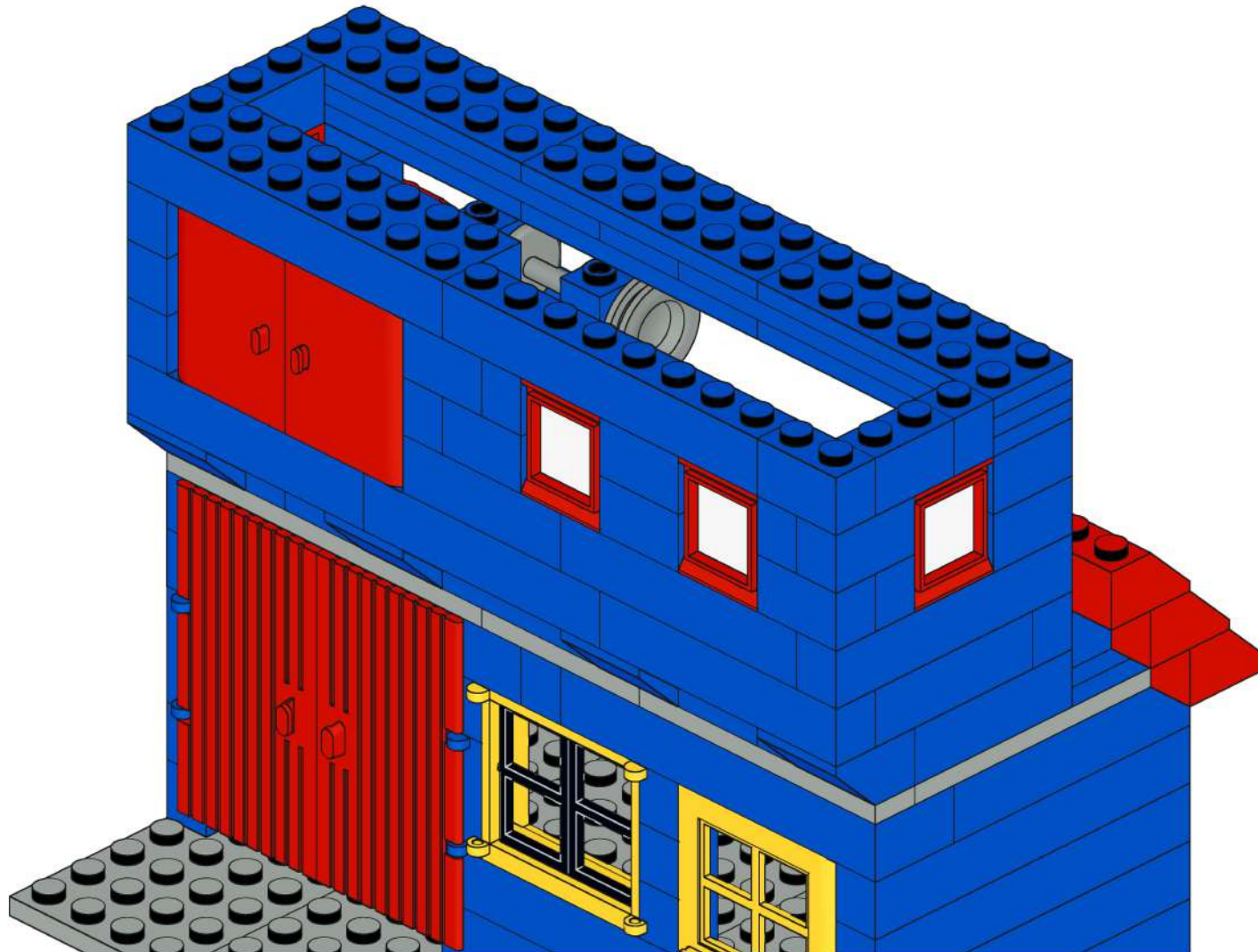
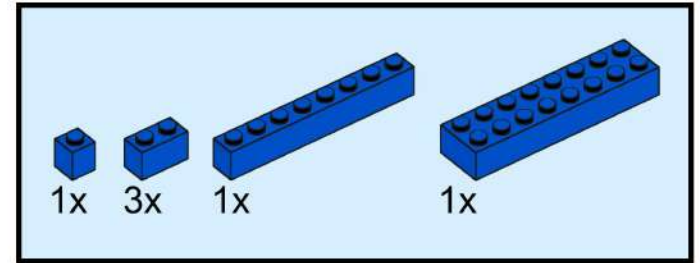

15

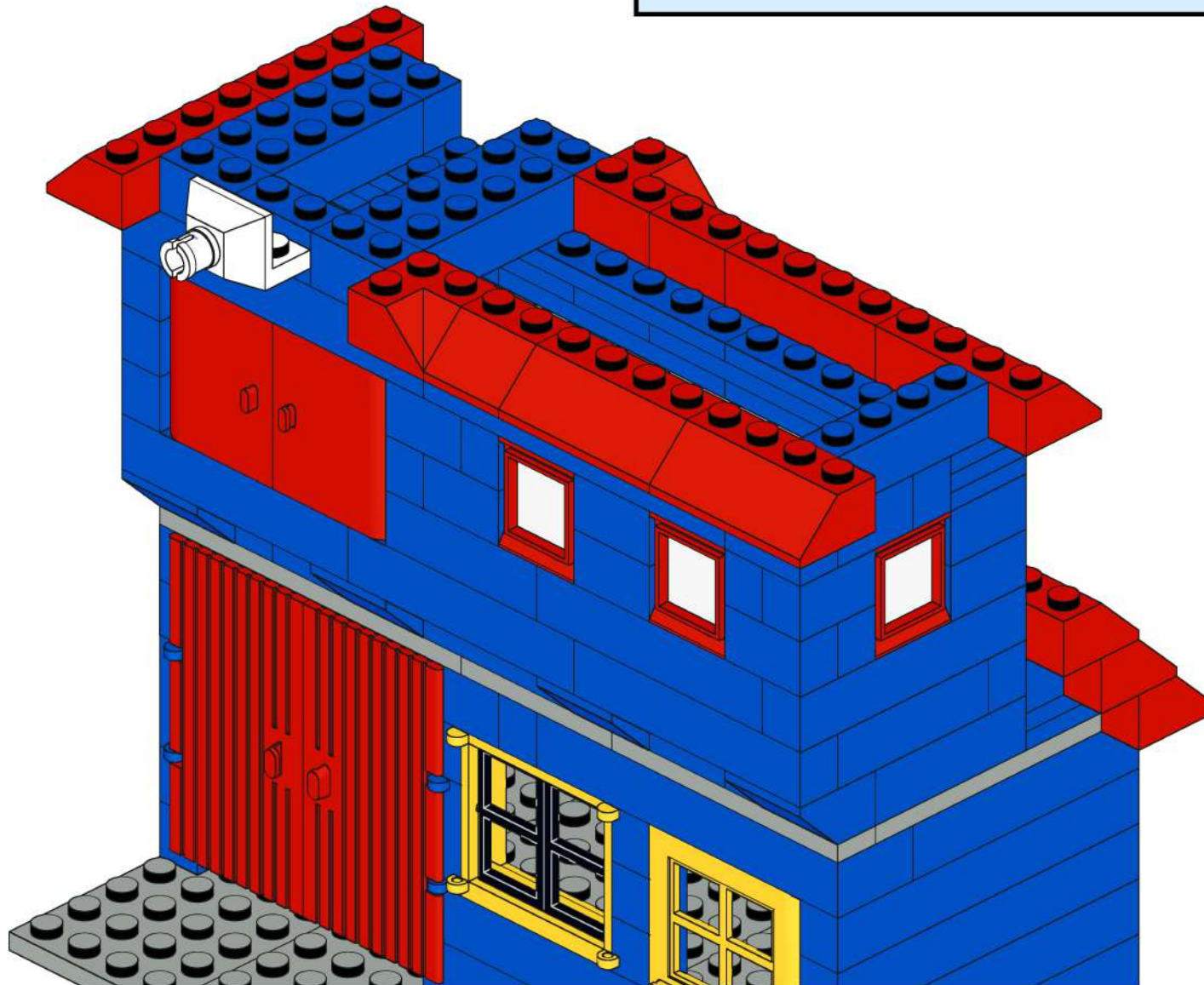
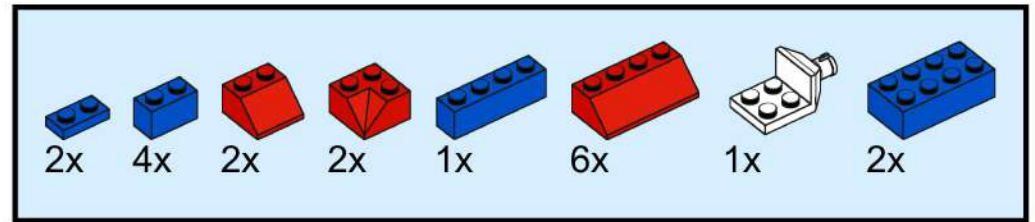

16

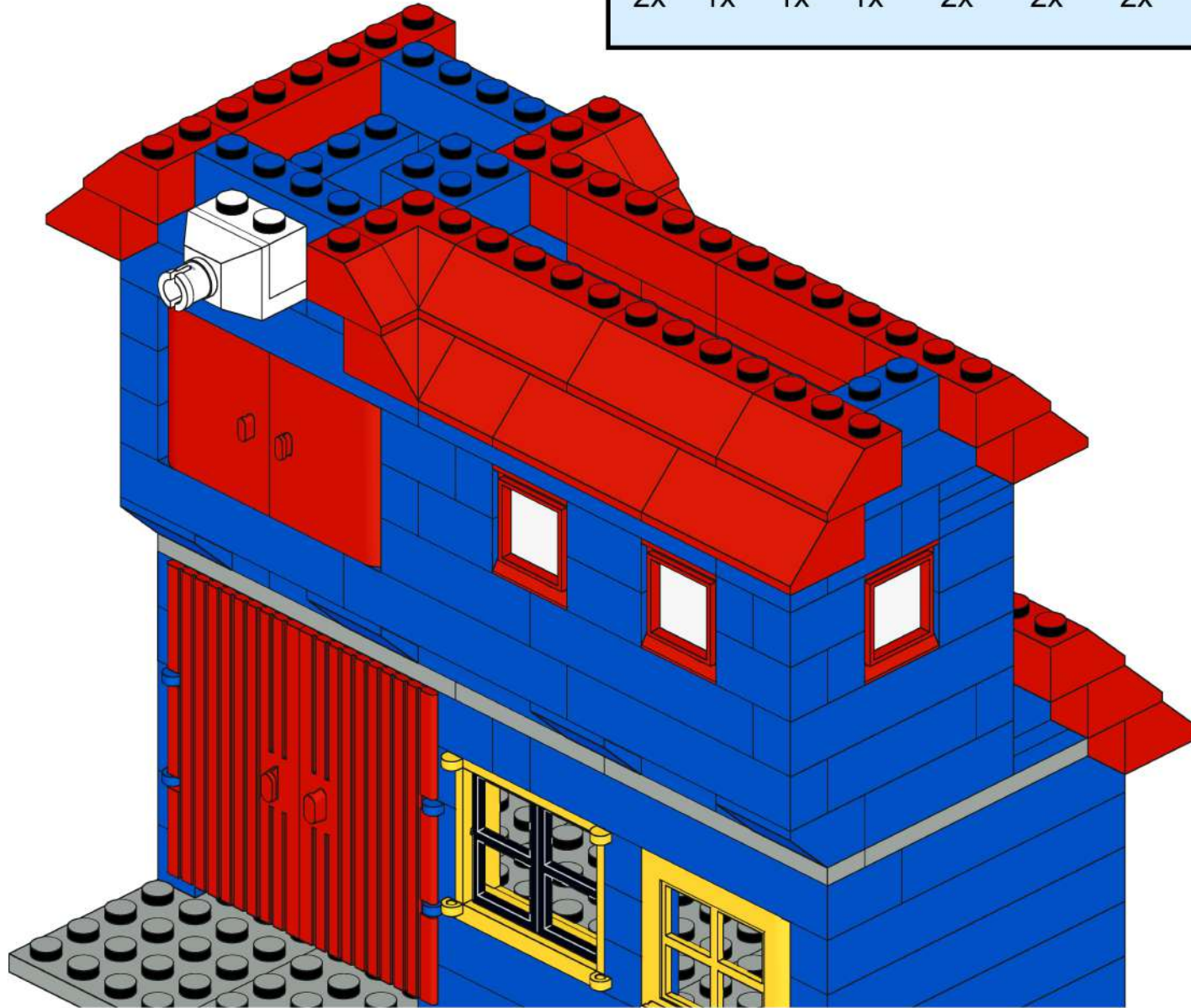
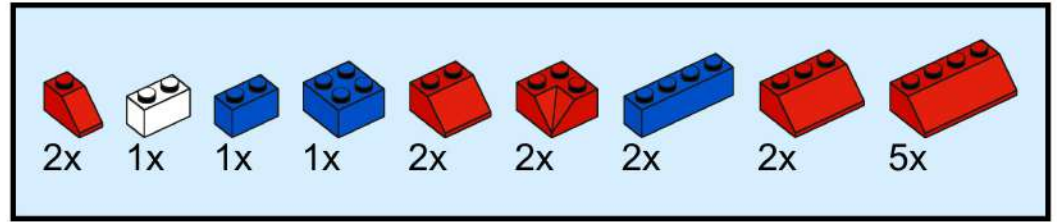

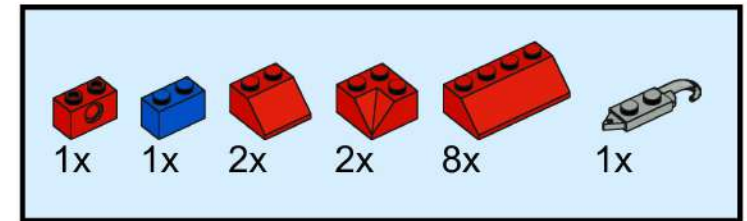
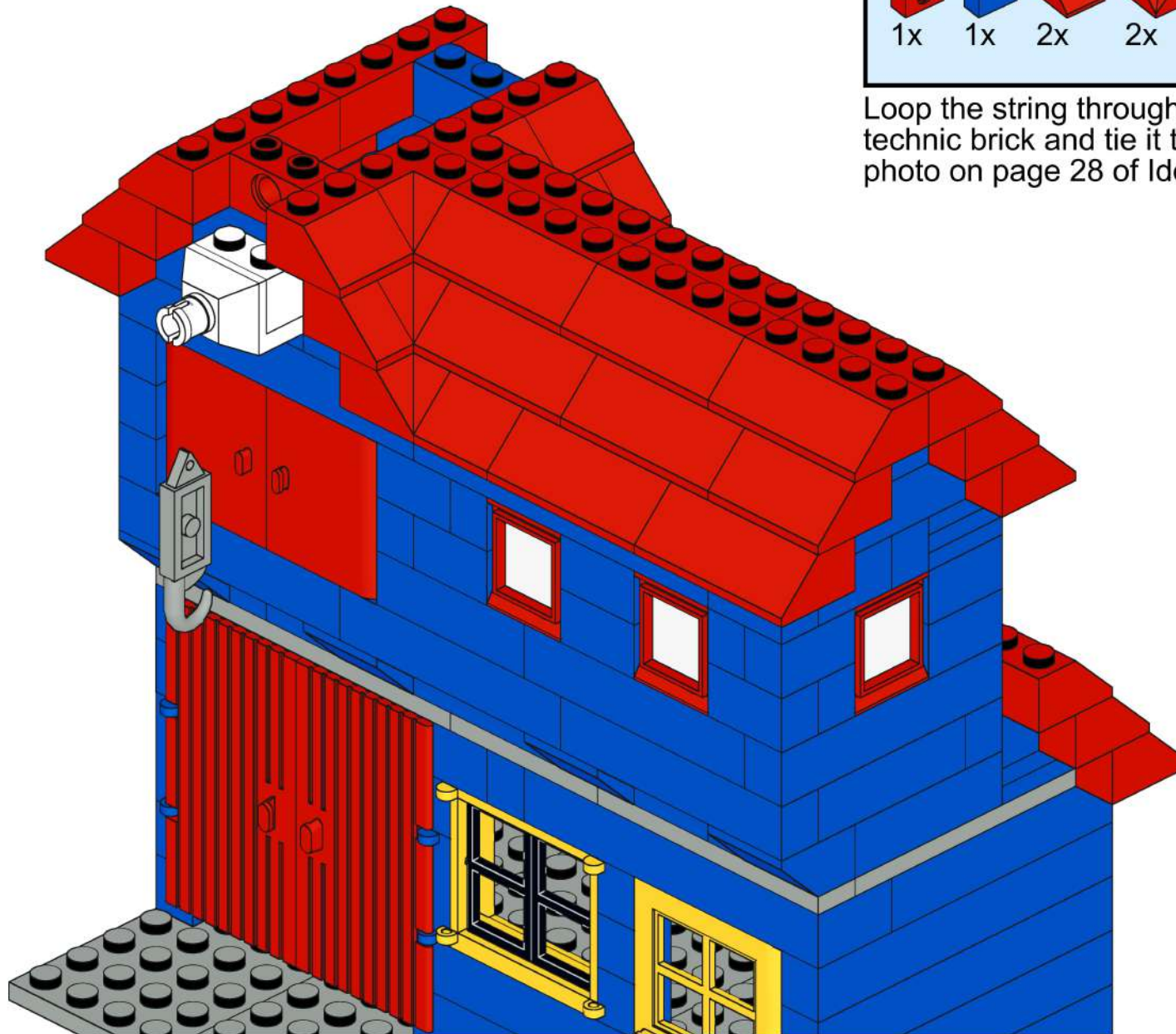

Loop the string through the hole in the technic brick and tie it to the hook. See photo on page 28 of Idea Book 6000.

18

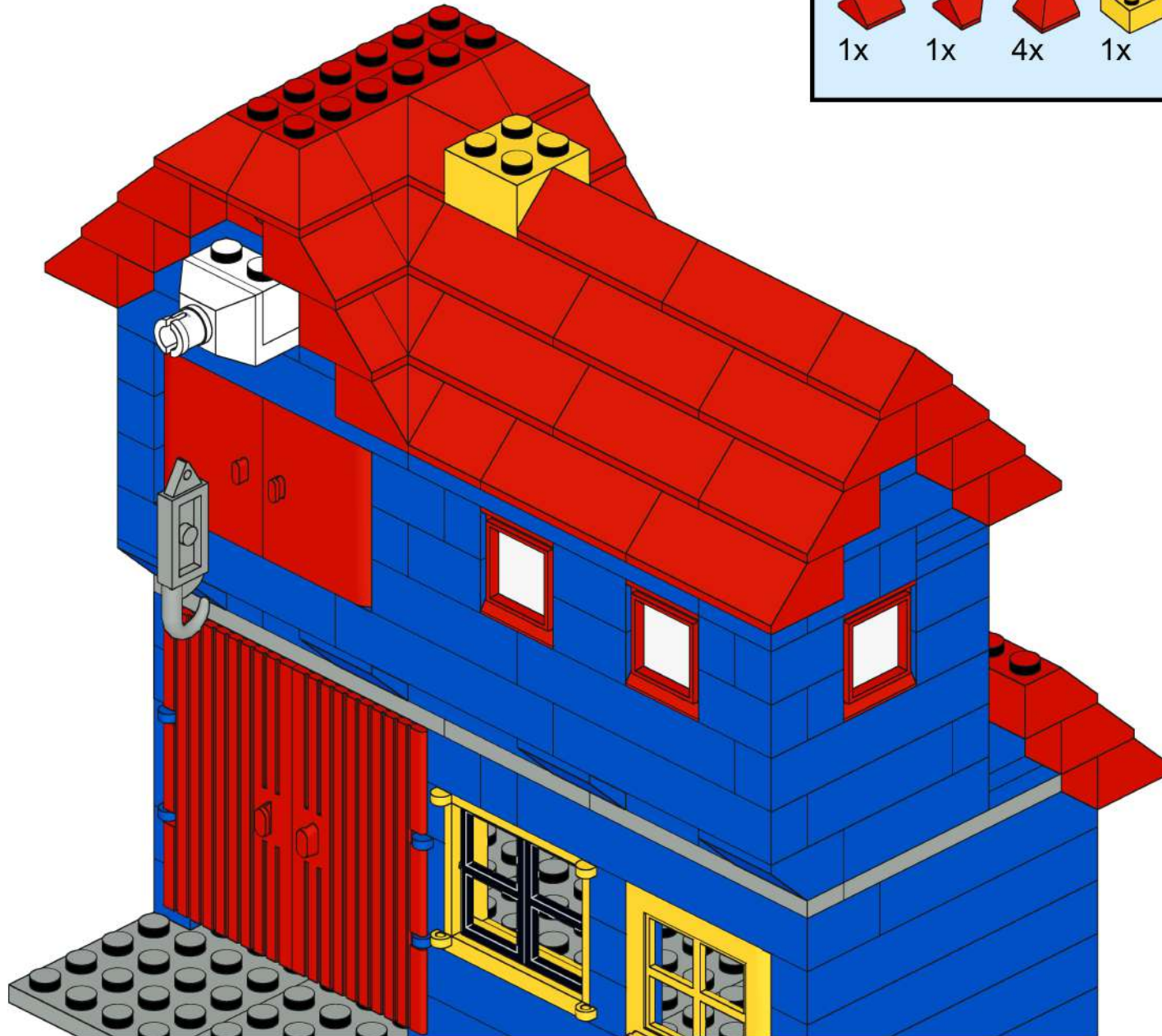
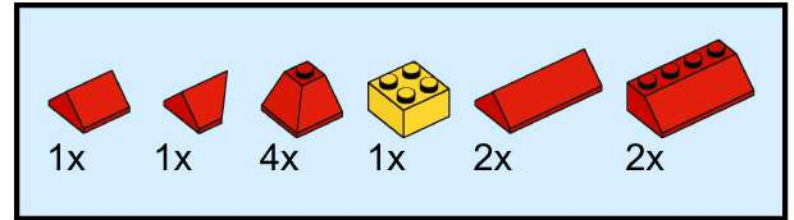

19

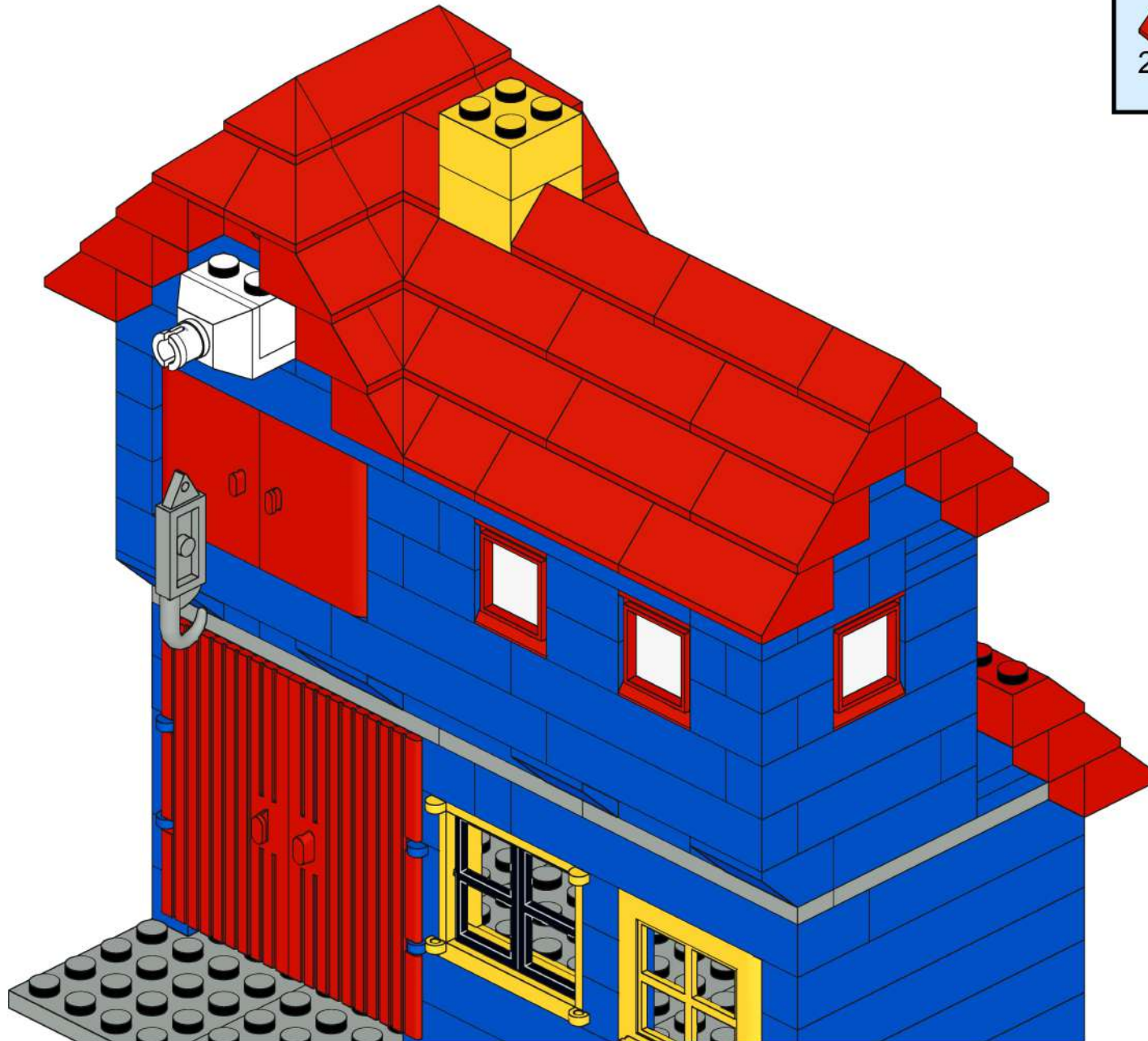
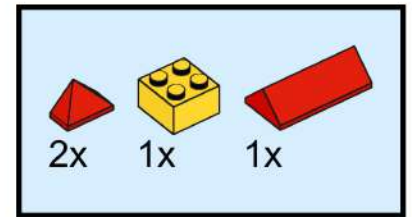



2x
3854
Black



1x
3460
Light Gray



1x
3481
White



6x
3046a
Red



1x
3192
Red



18x
3005
Blue



3x
3001
Blue

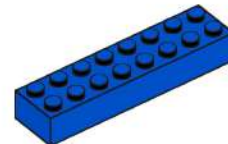

2x
3007
Blue



4x
3009
Black

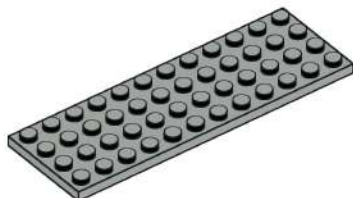

1x
3029
Light Gray



2x
3048a
Red



4x
7026
Red



6x
3023
Blue



11x
3009
Blue



4x
3008
Black

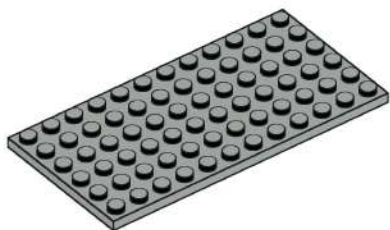

3x
3028
Light Gray



2x
3040
Red



2x
3038
Red



2x
3644
Red



23x
3004
Blue



6x
3795
Blue



1x
3710
Light Gray

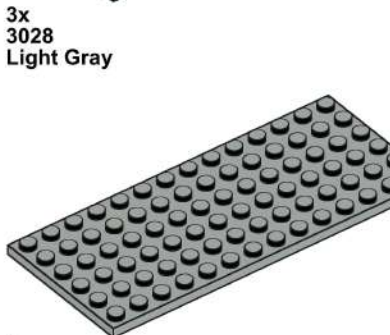

1x
3028
Light Gray



1x
3700
Red



3x
3041
Red



2x
3003
Yellow



1x
3022
Blue

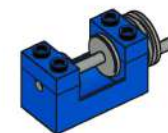

1x
73037
Blue



1x
3127
Light Gray



1x
3049b
Red



21x
3037
Red



1x
3853
Yellow



2x
3581
Blue



1x
3003
Blue



1x
3666
Light Gray

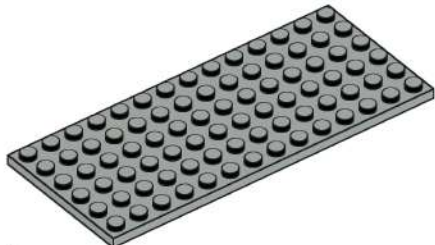

1x
3456
Light Gray



1x
3043
Red



1x
3193
Red



1x
3861
Yellow



1x
3003
Blue



10x
3008
Blue



1x
3032
Light Gray



1x
3004
White



12x
3039
Red



12x
3039
Red



5x
3660
Blue



2x
3034
Blue



4x
3045
Red



9x
3010
Blue