

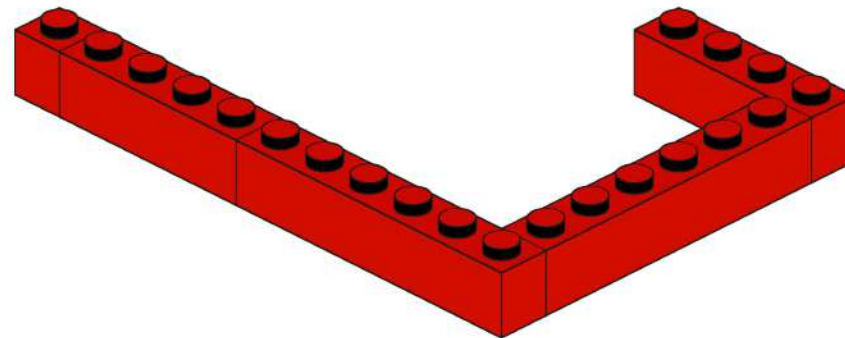

1

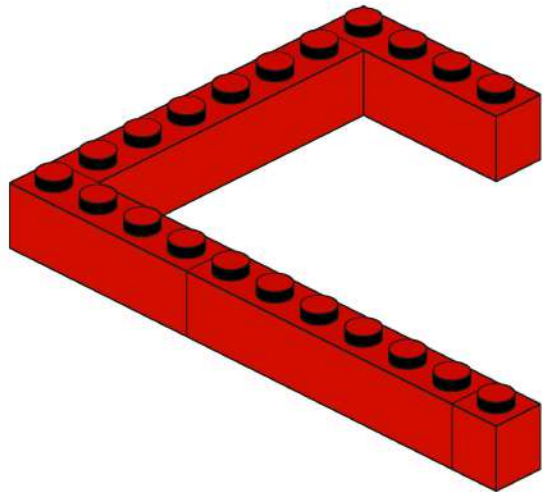

2

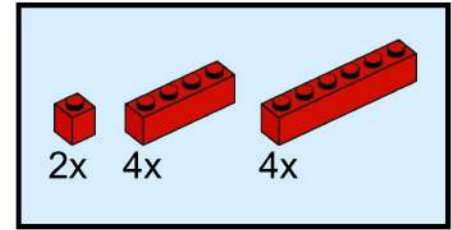
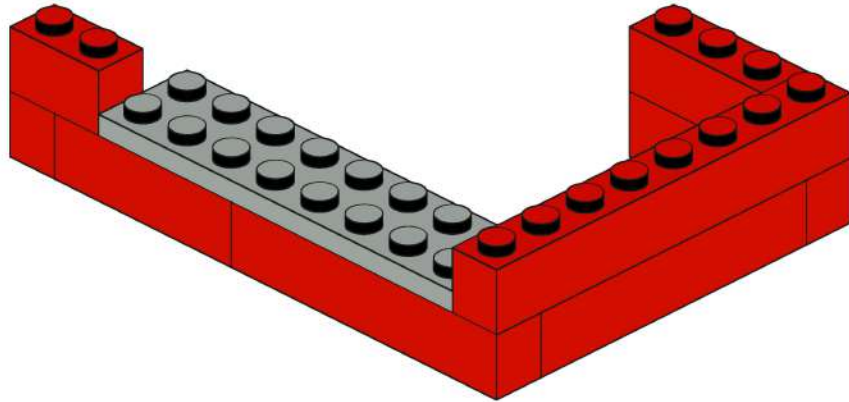
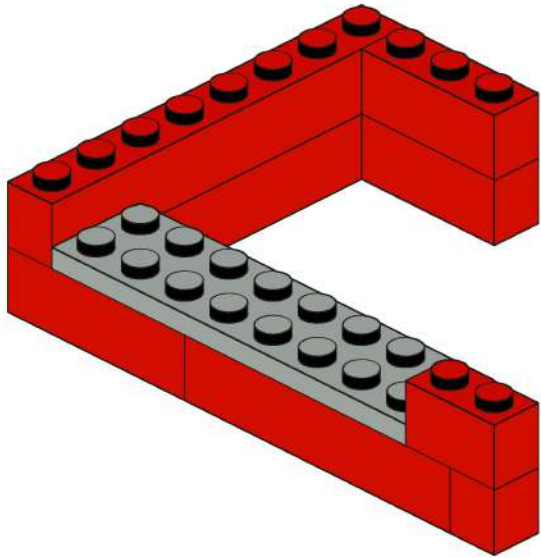
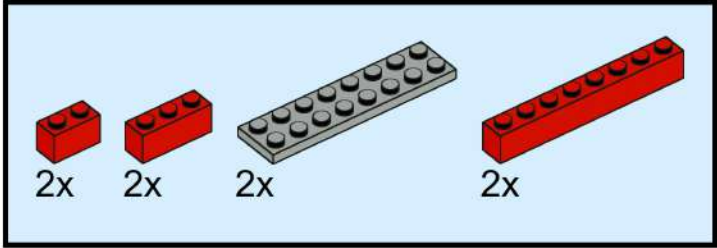

3

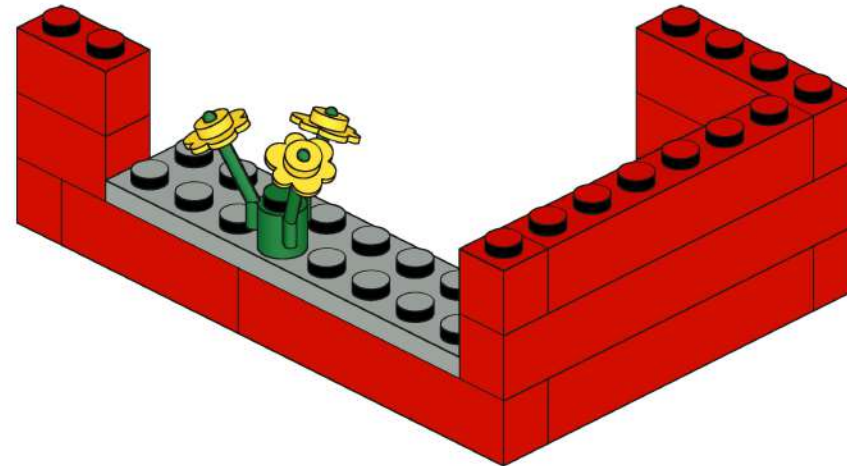
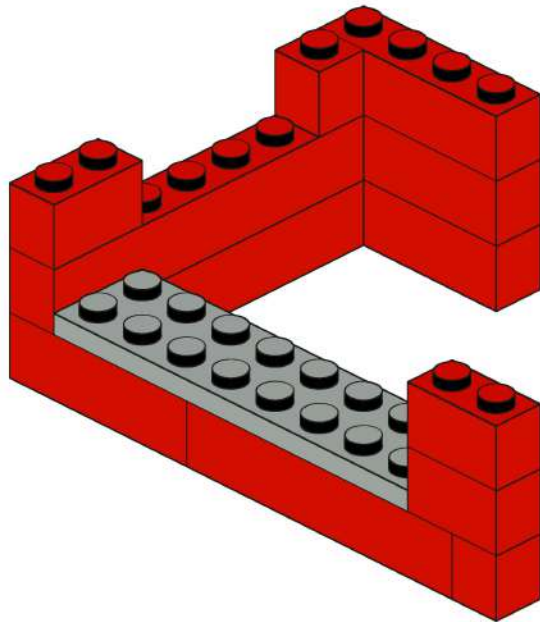
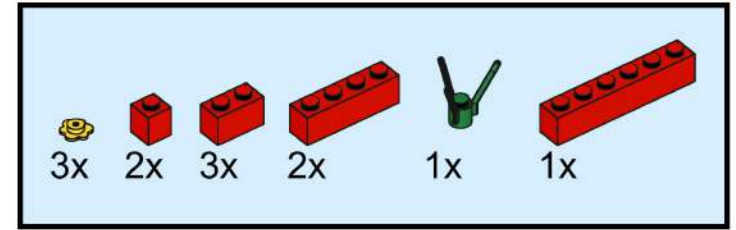

4

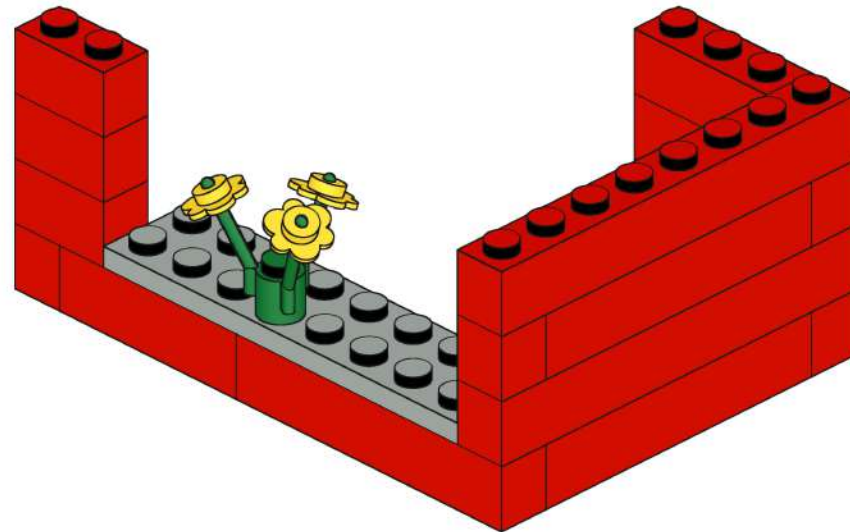
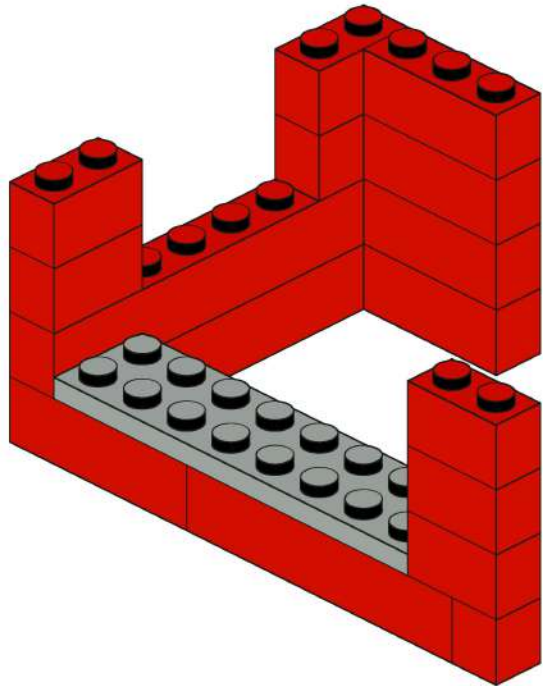
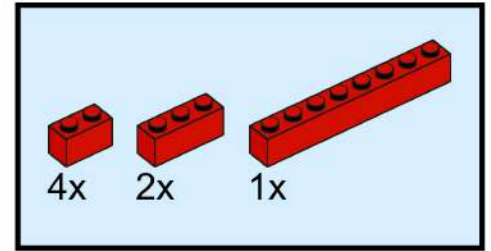

5

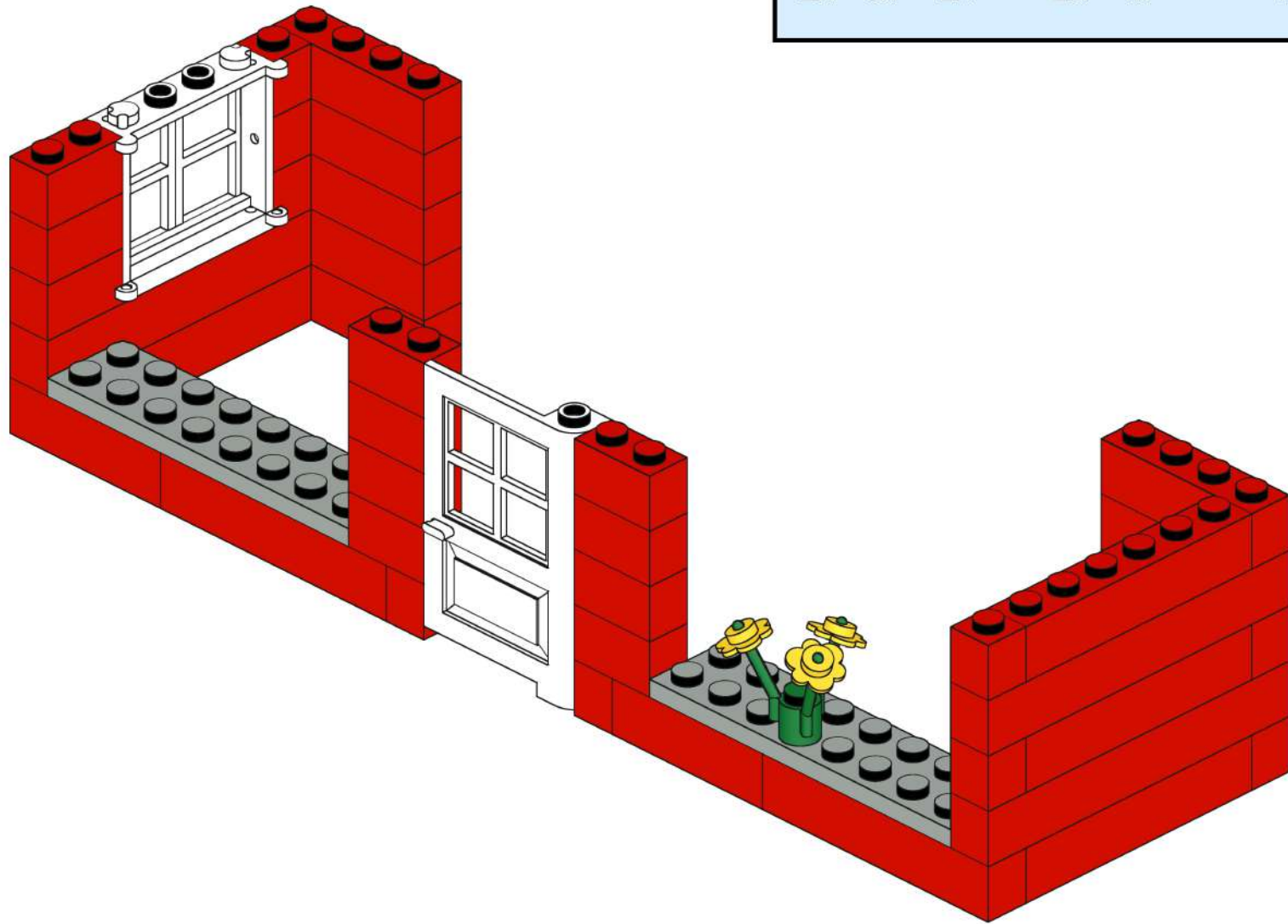
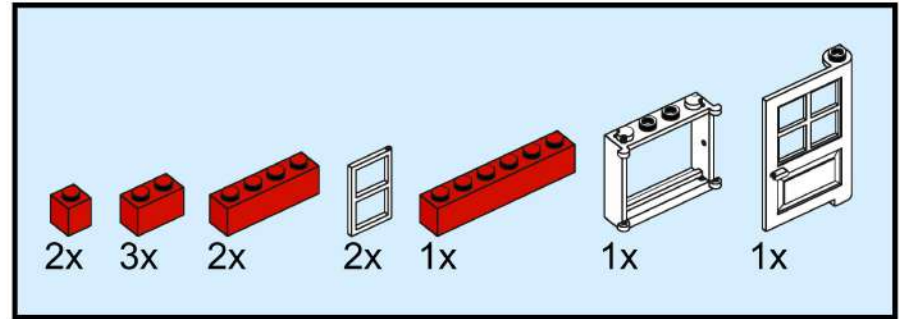

6

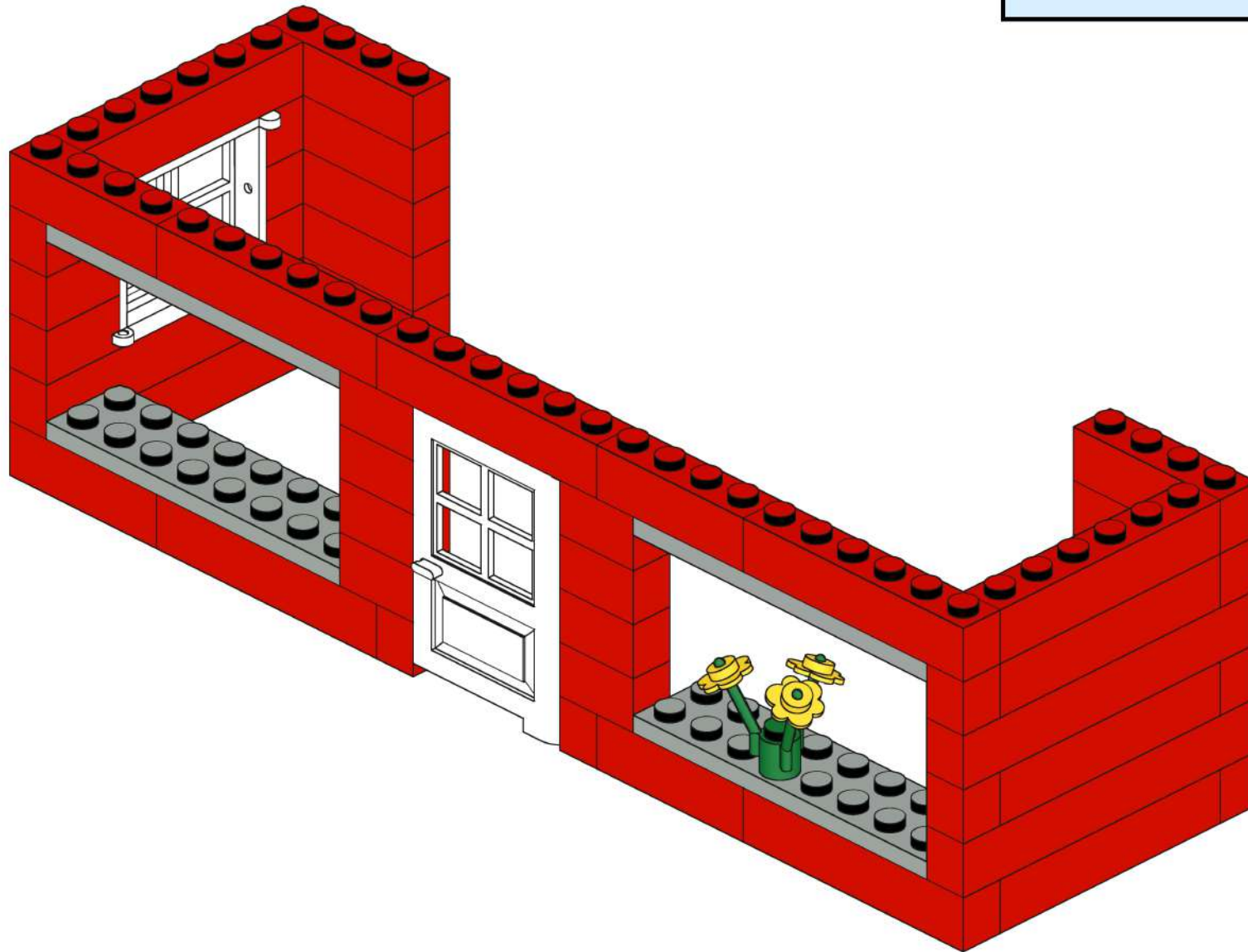
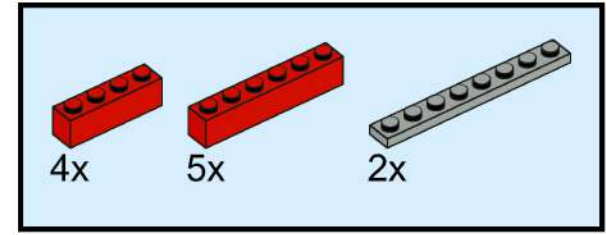

7

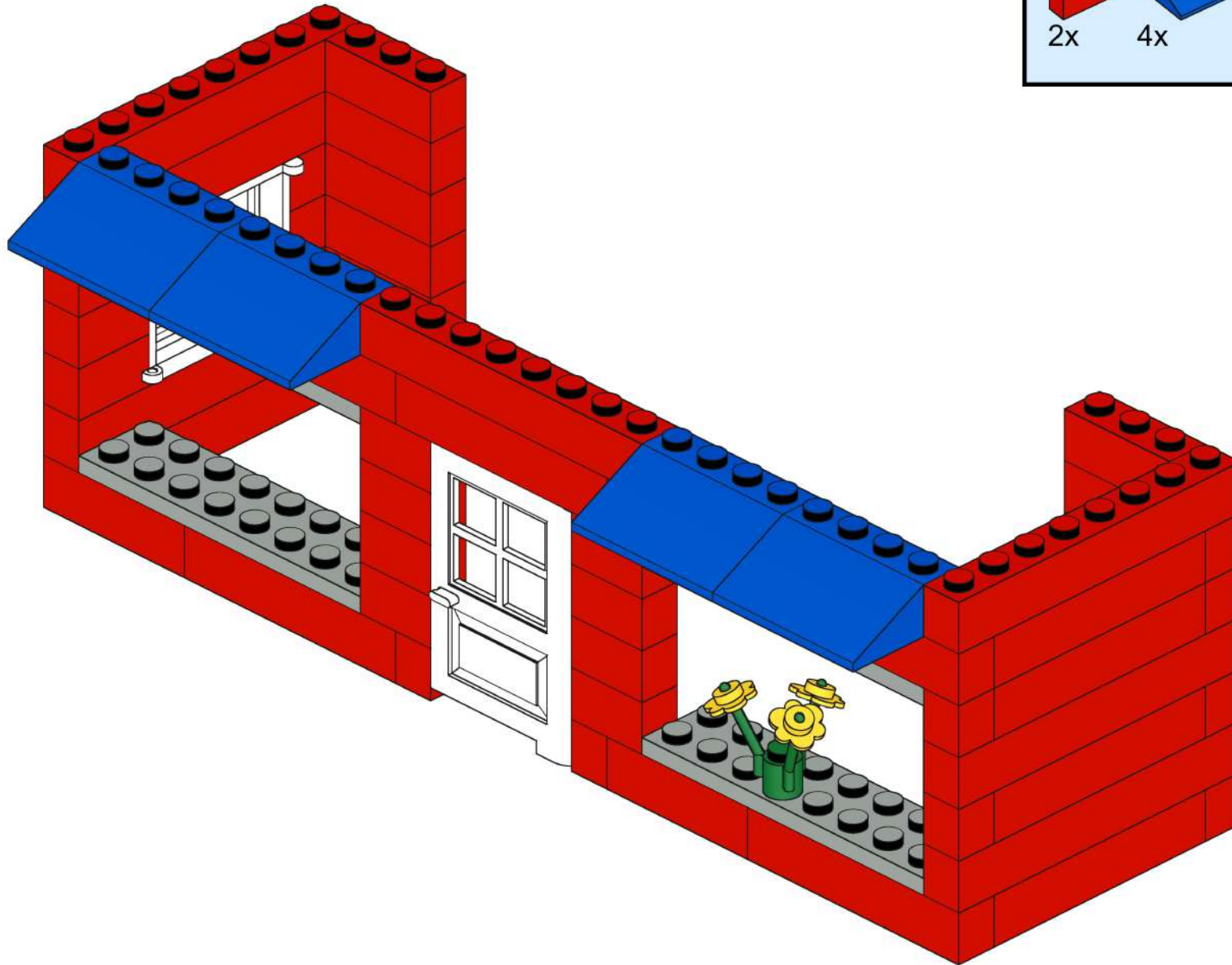
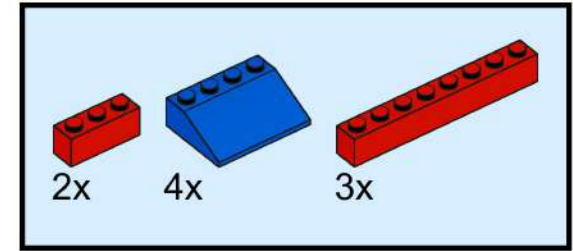

8

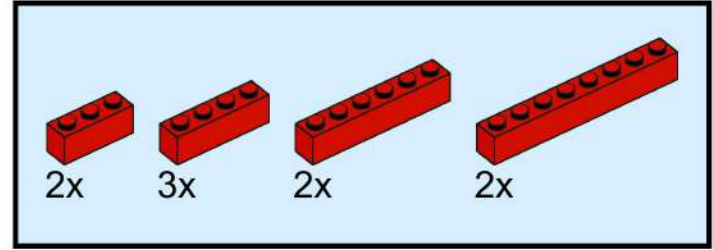
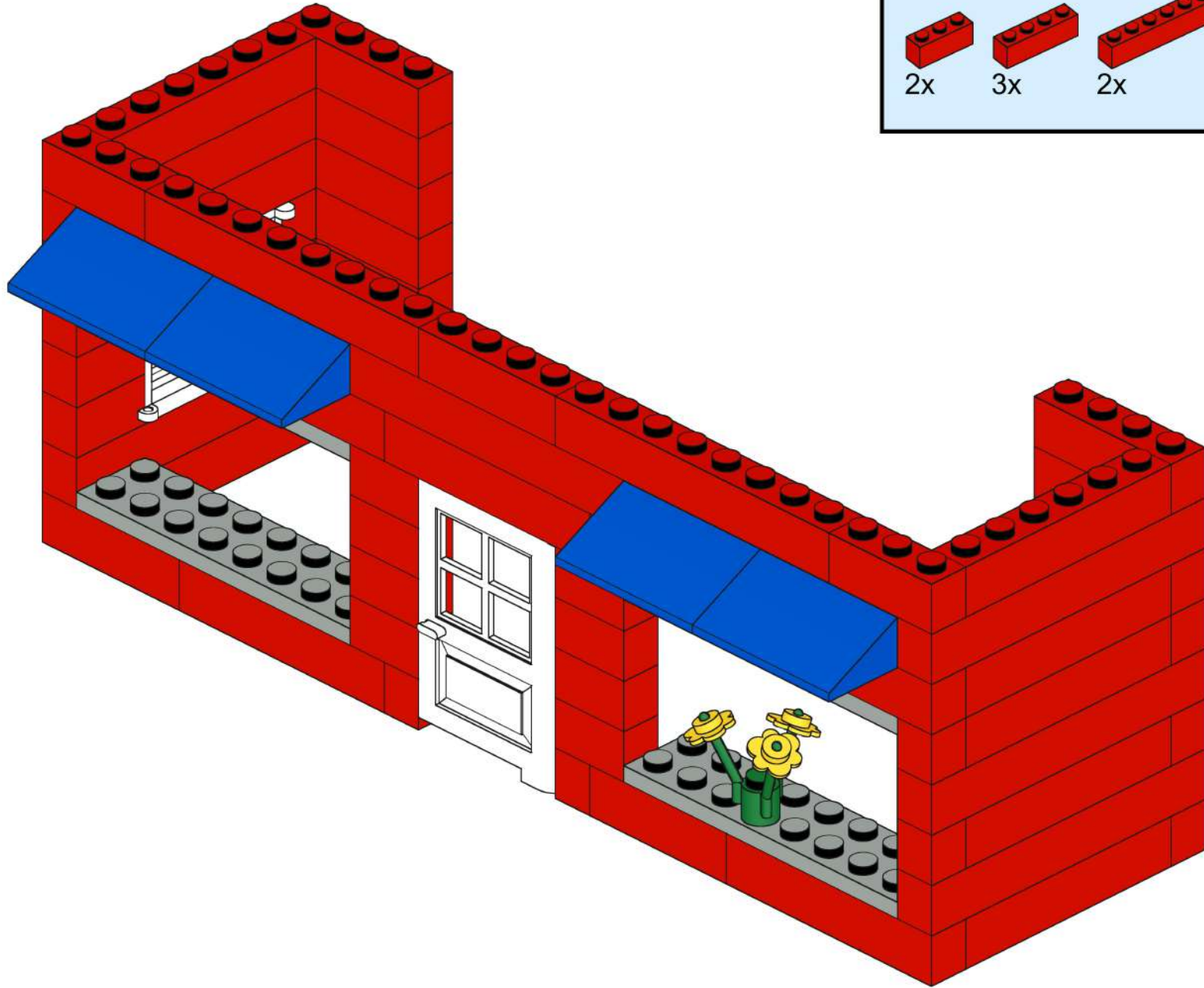

9

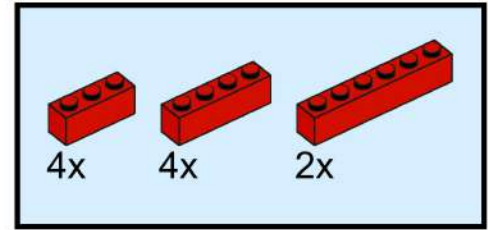
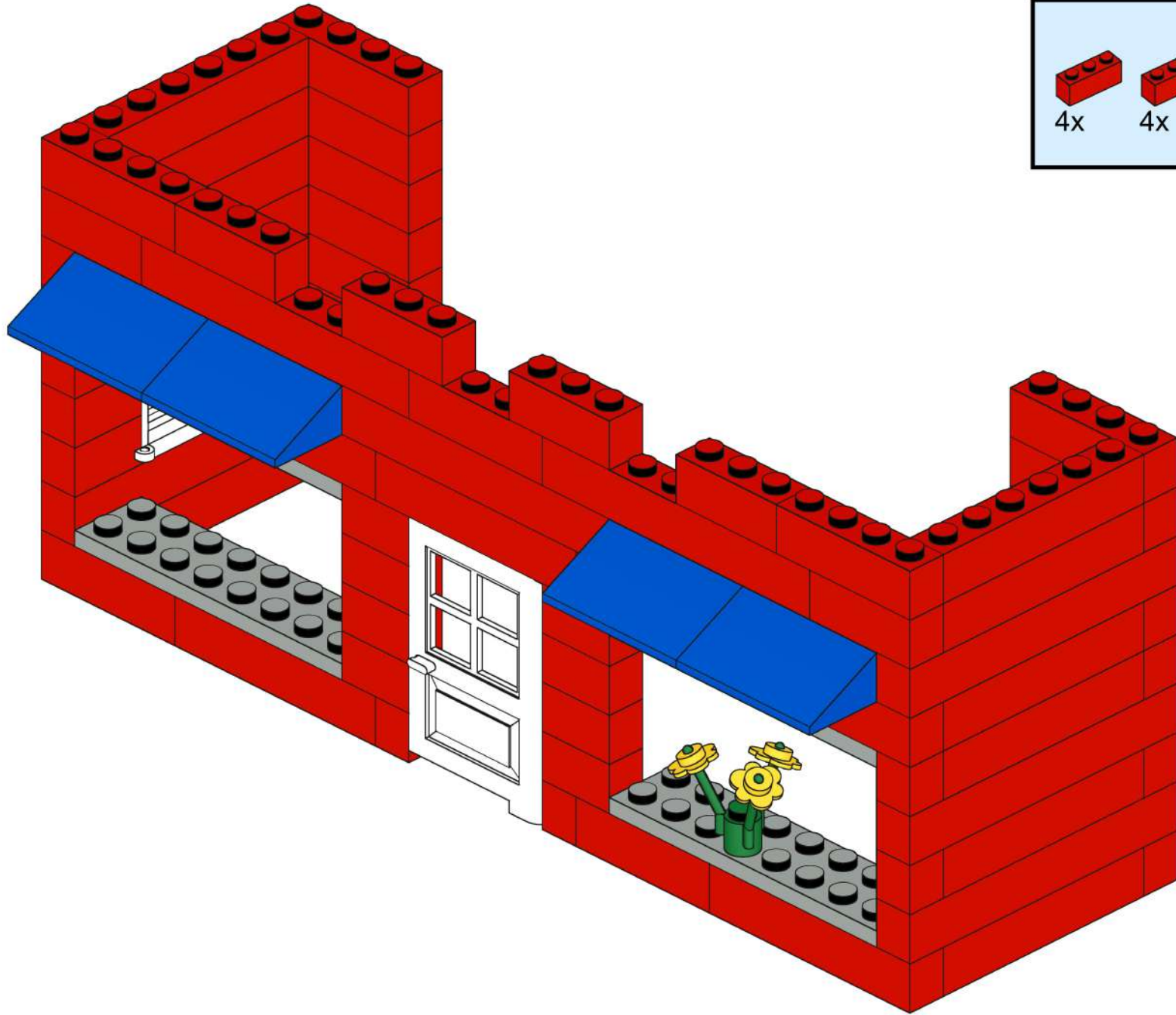

10

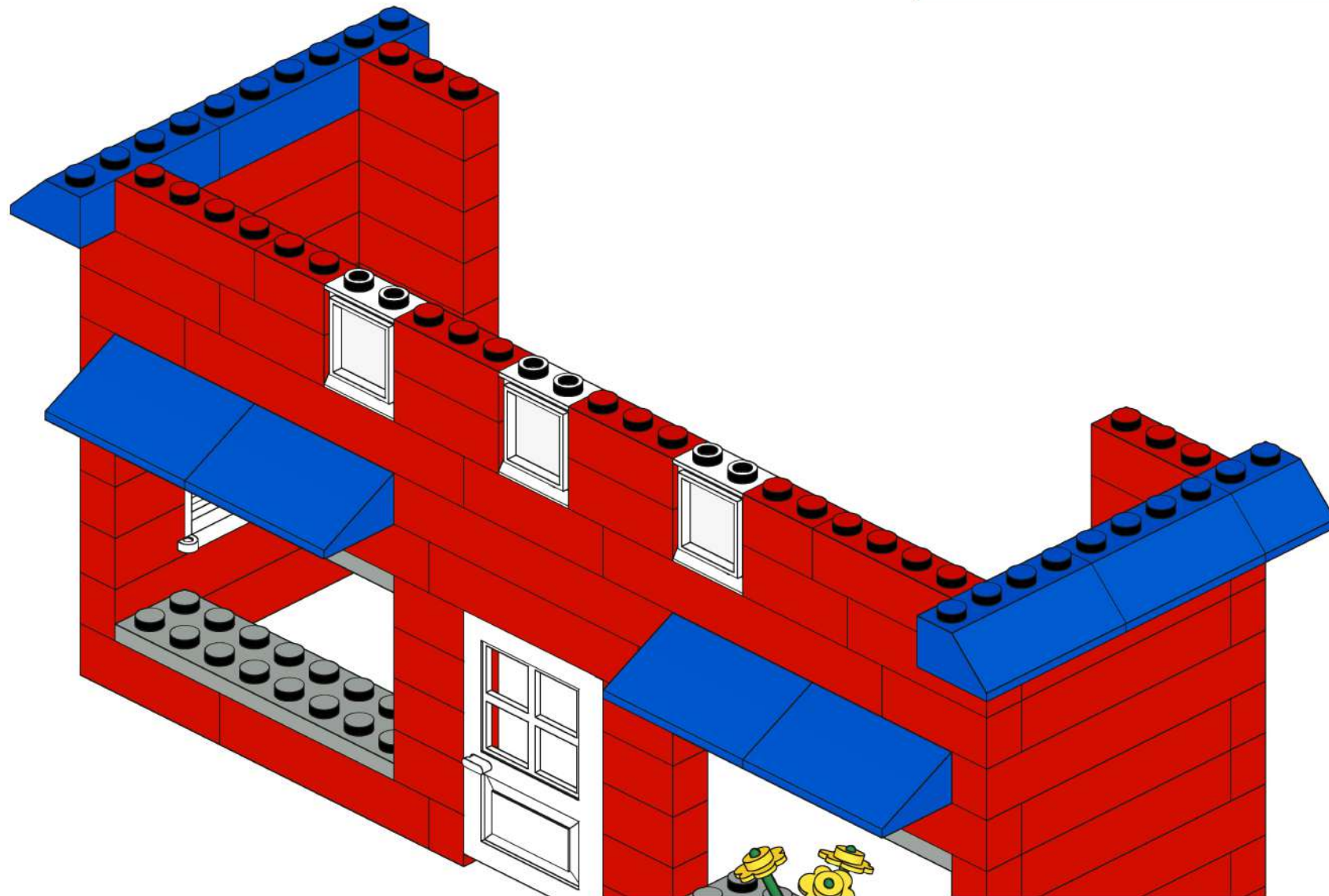
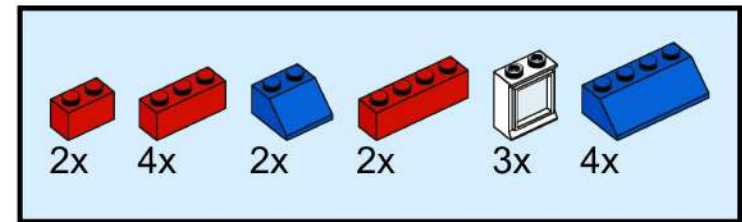

11

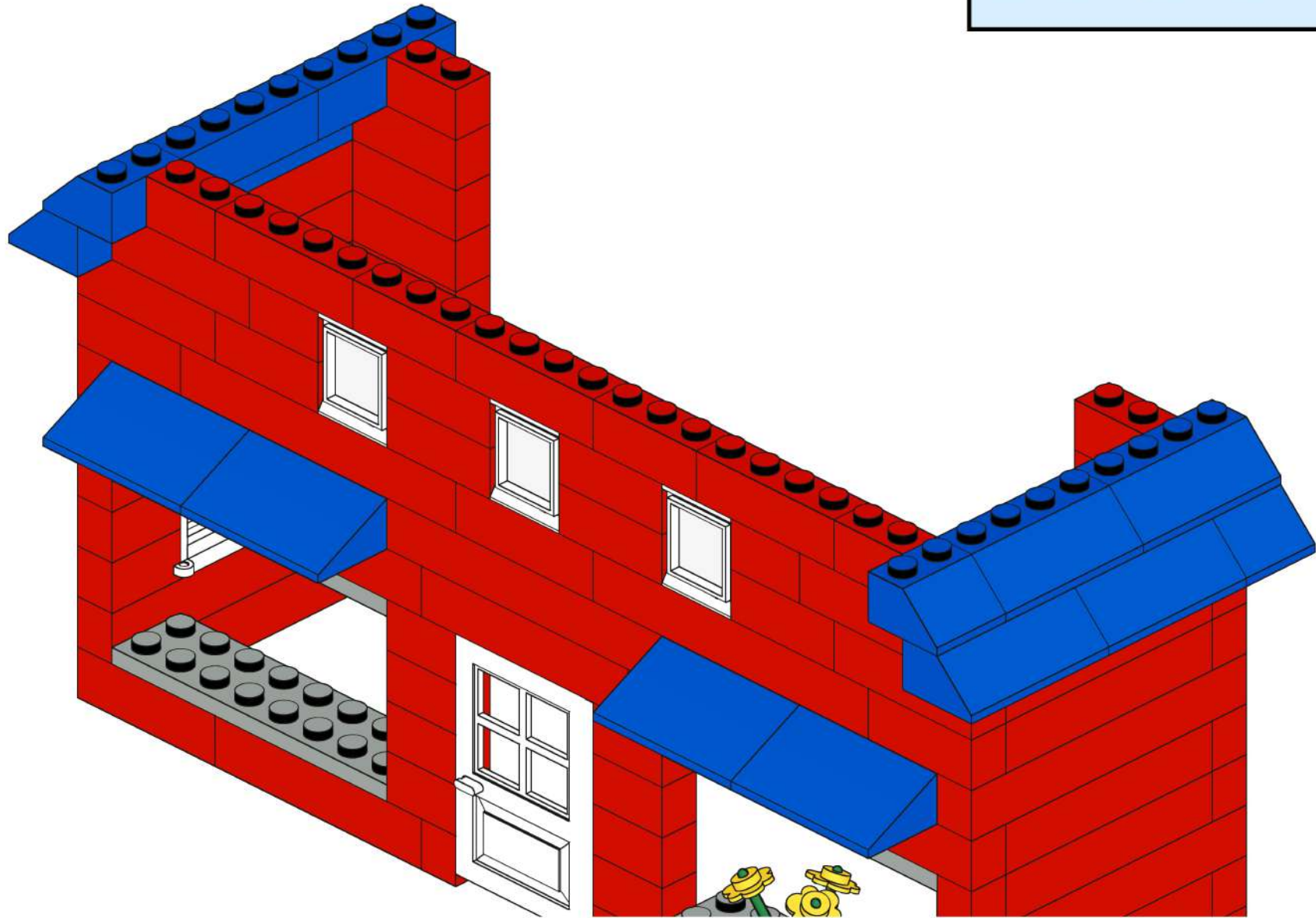
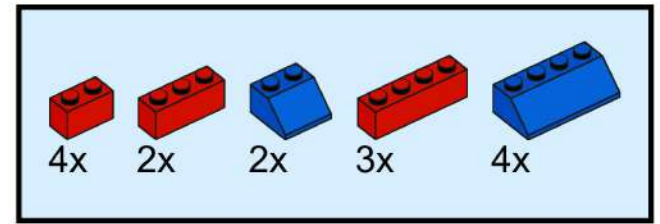

12

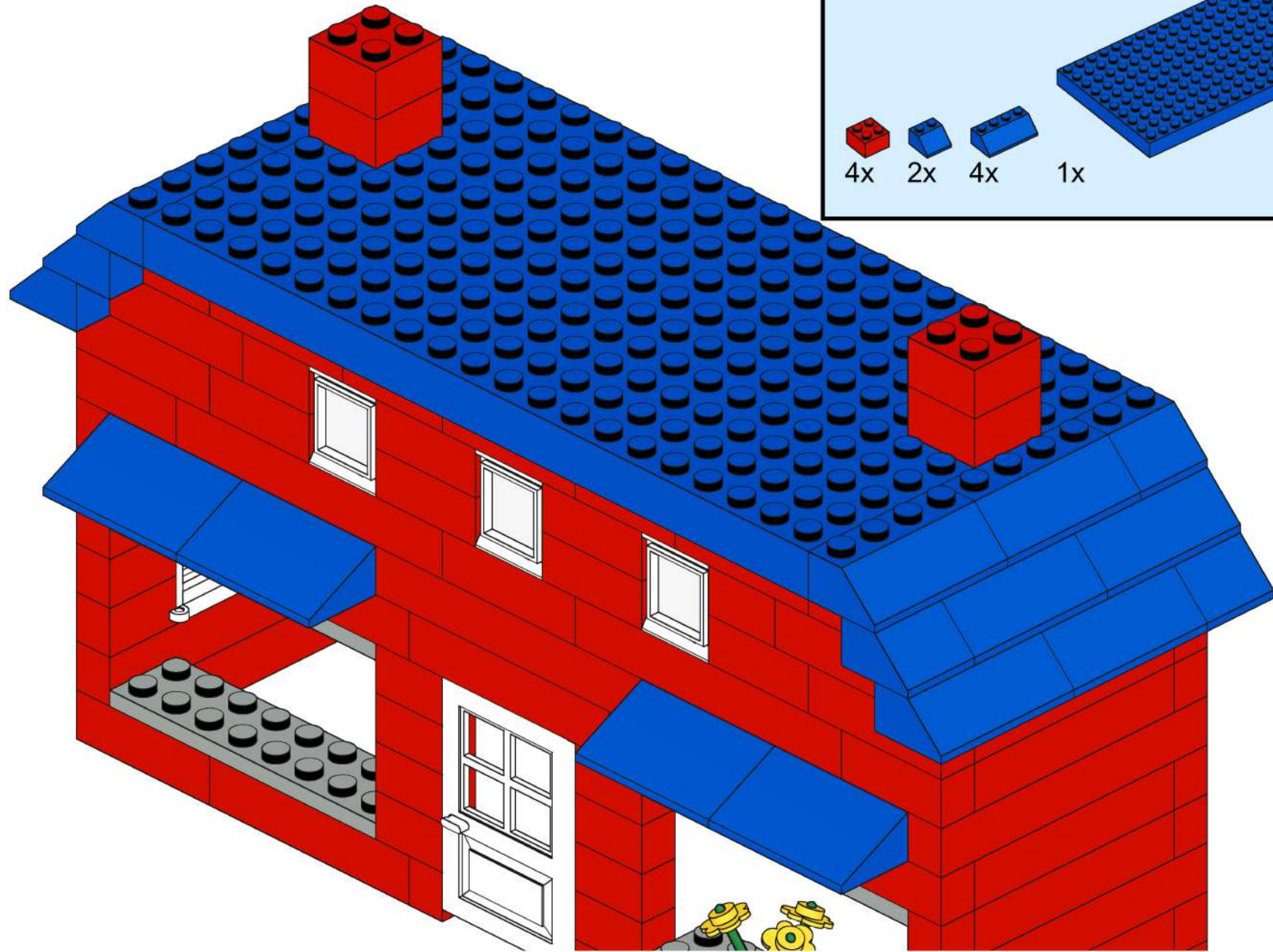



2x
3460
Light Gray

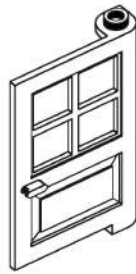

1x
3861
White

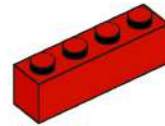

24x
3010
Red



12x
3037
Blue



2x
3034
Light Gray

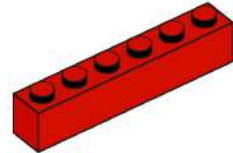

15x
3009
Red

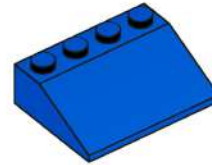

4x
3297
Blue

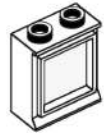

3x
7026
White



6x
3005
Red

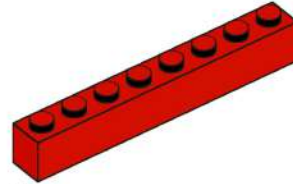

8x
3008
Red

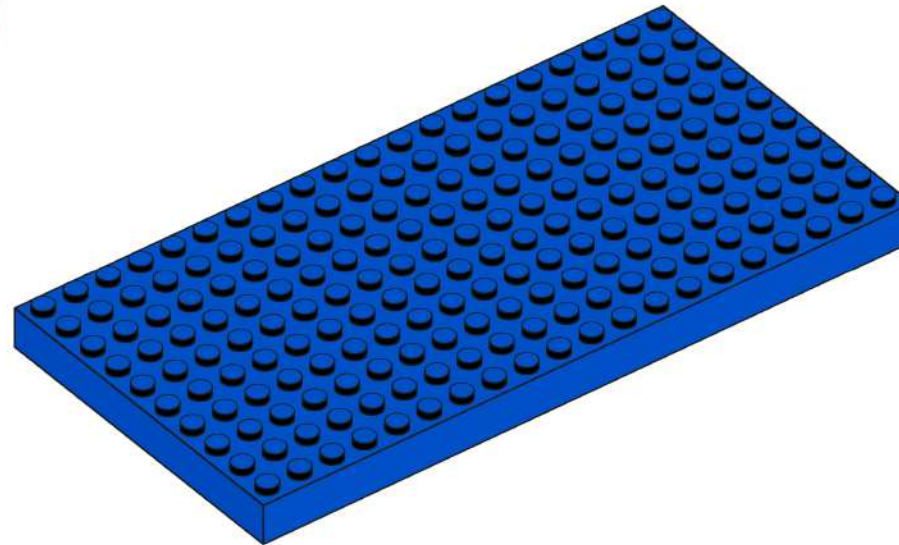

1x
700ex
Blue



2x
3854
White



18x
3004
Red



3x
3742
Yellow



4x
3003
Red



1x
3741
Green

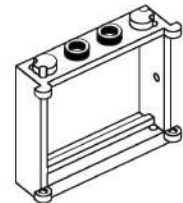

1x
3853
White

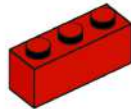

18x
3622
Red



6x
3039
Blue

The parts list shows 700eX because it is the only 700e version that is available in Studio. You should use one of the versions with bottom tubes 700eD or 700eD2