

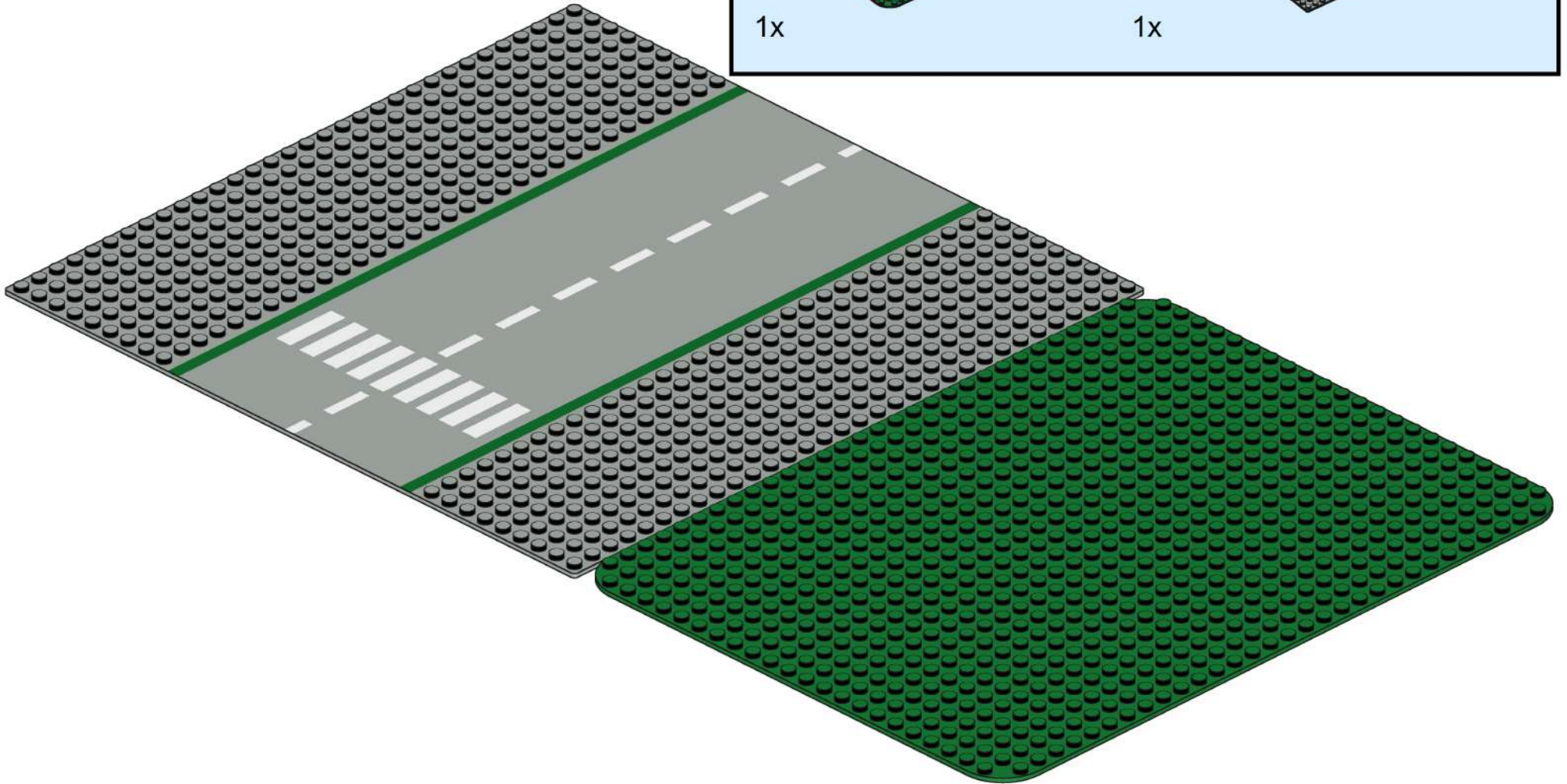

1

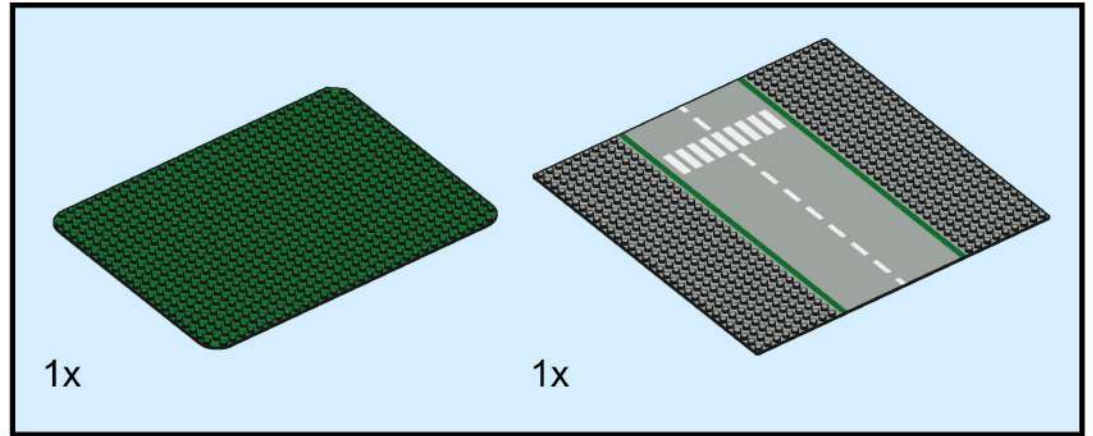

2

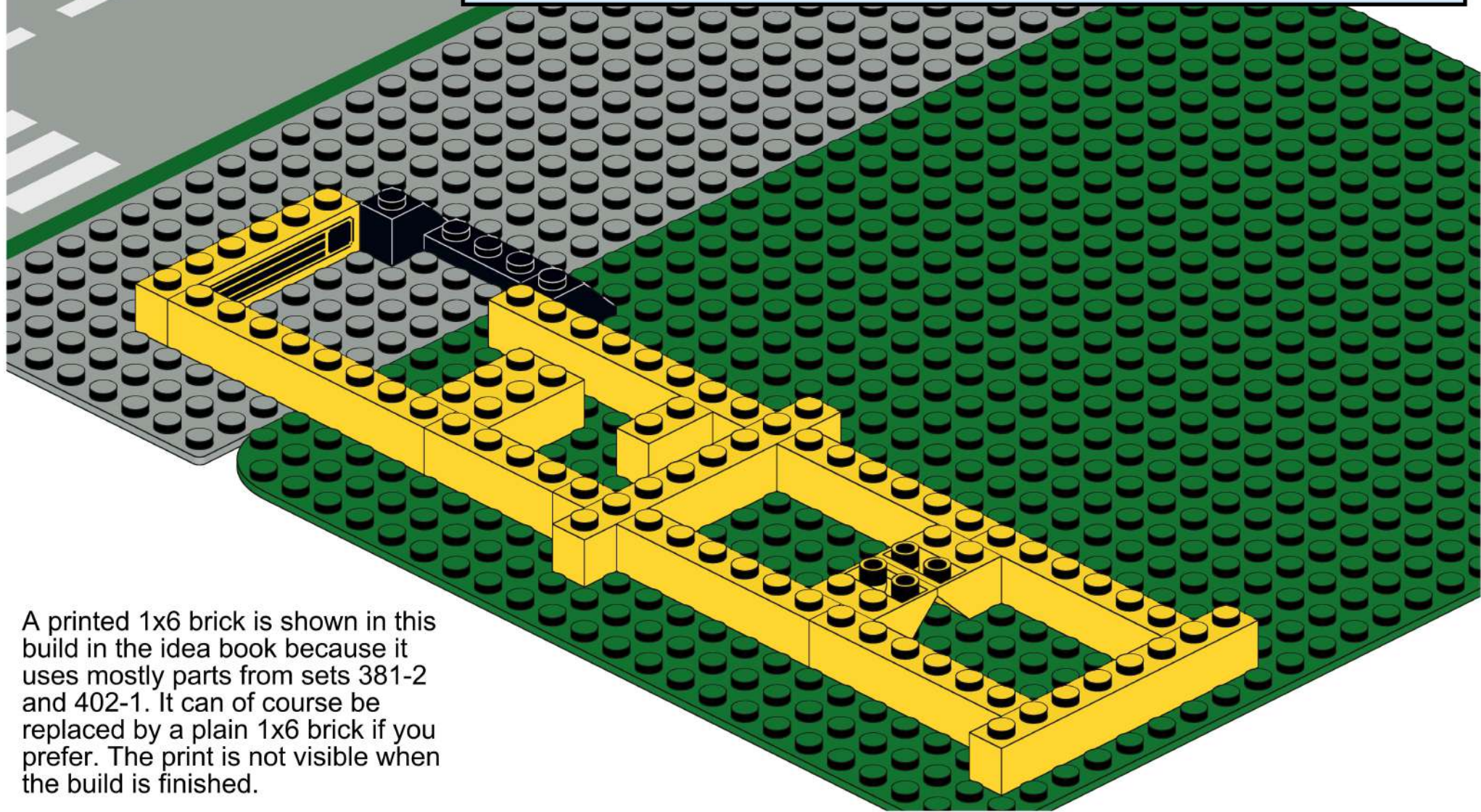
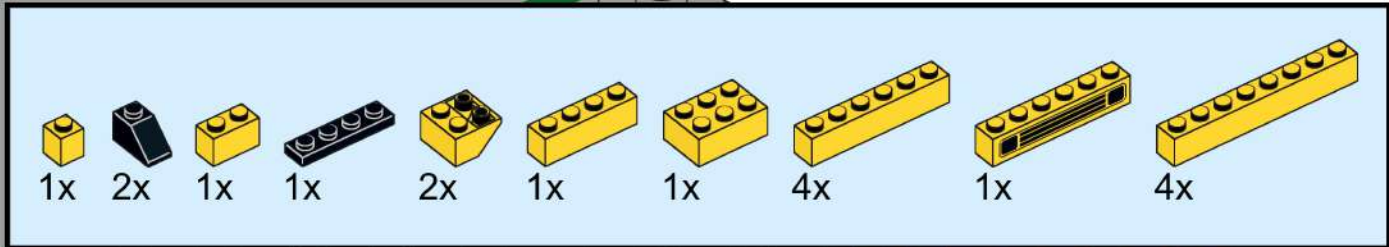

A printed 1x6 brick is shown in this build in the idea book because it uses mostly parts from sets 381-2 and 402-1. It can of course be replaced by a plain 1x6 brick if you prefer. The print is not visible when the build is finished.

3

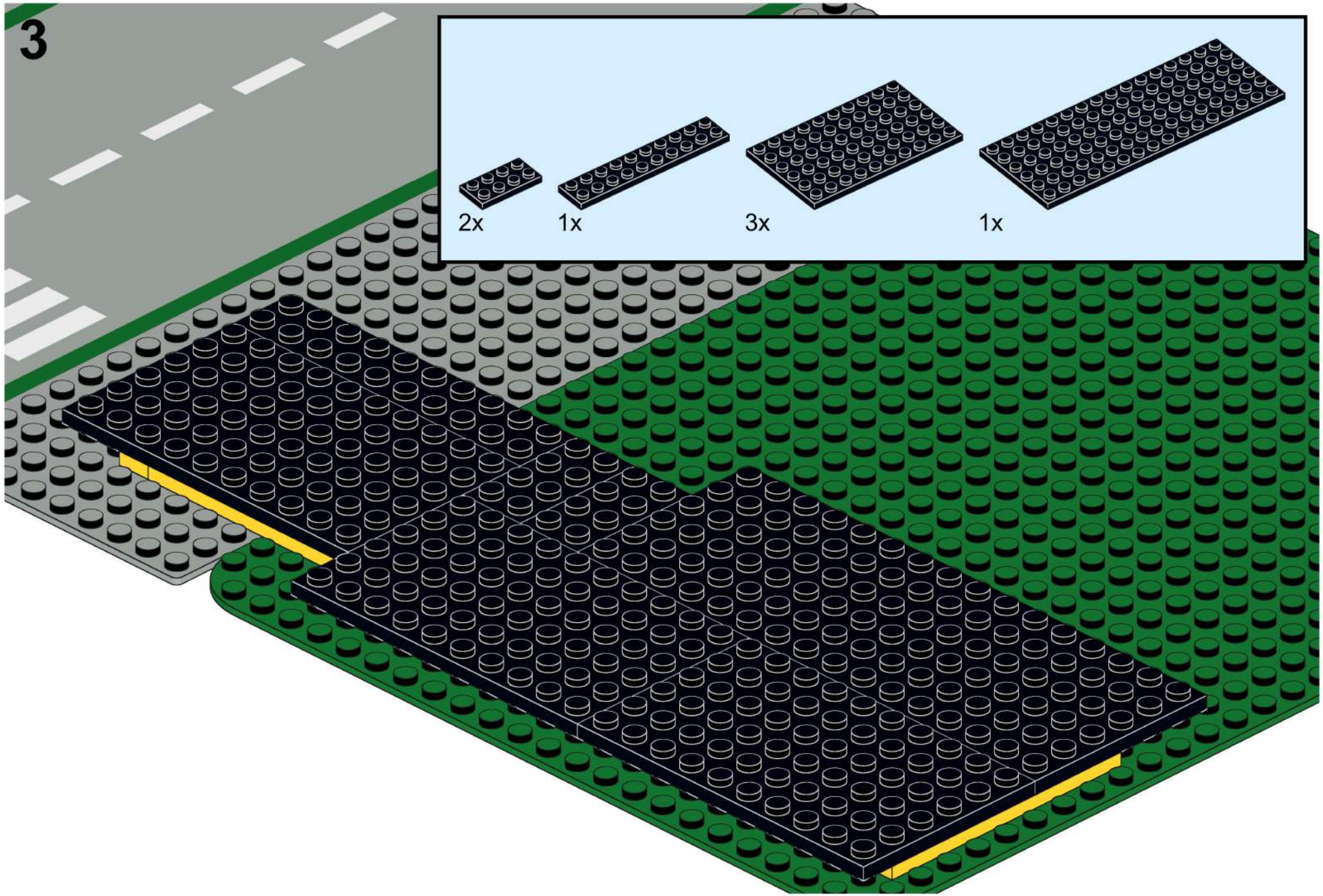
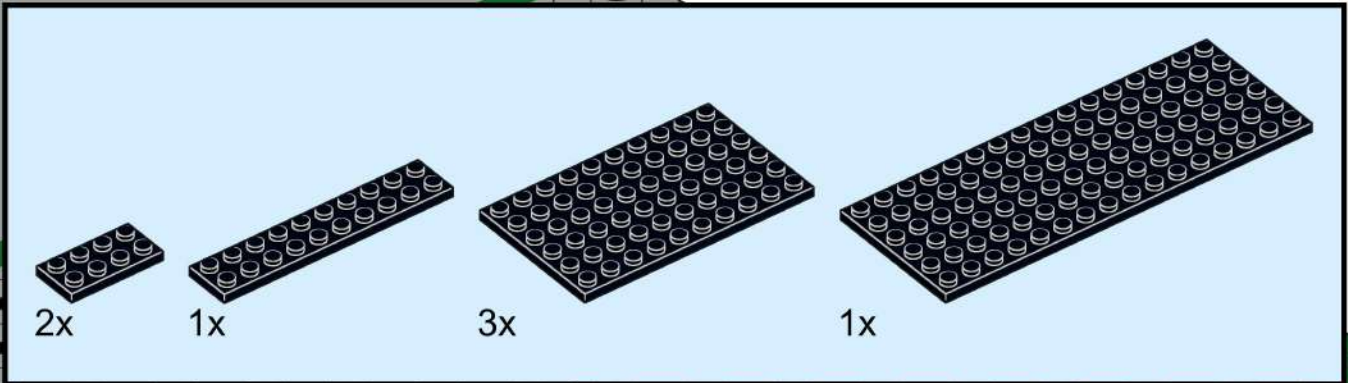

4

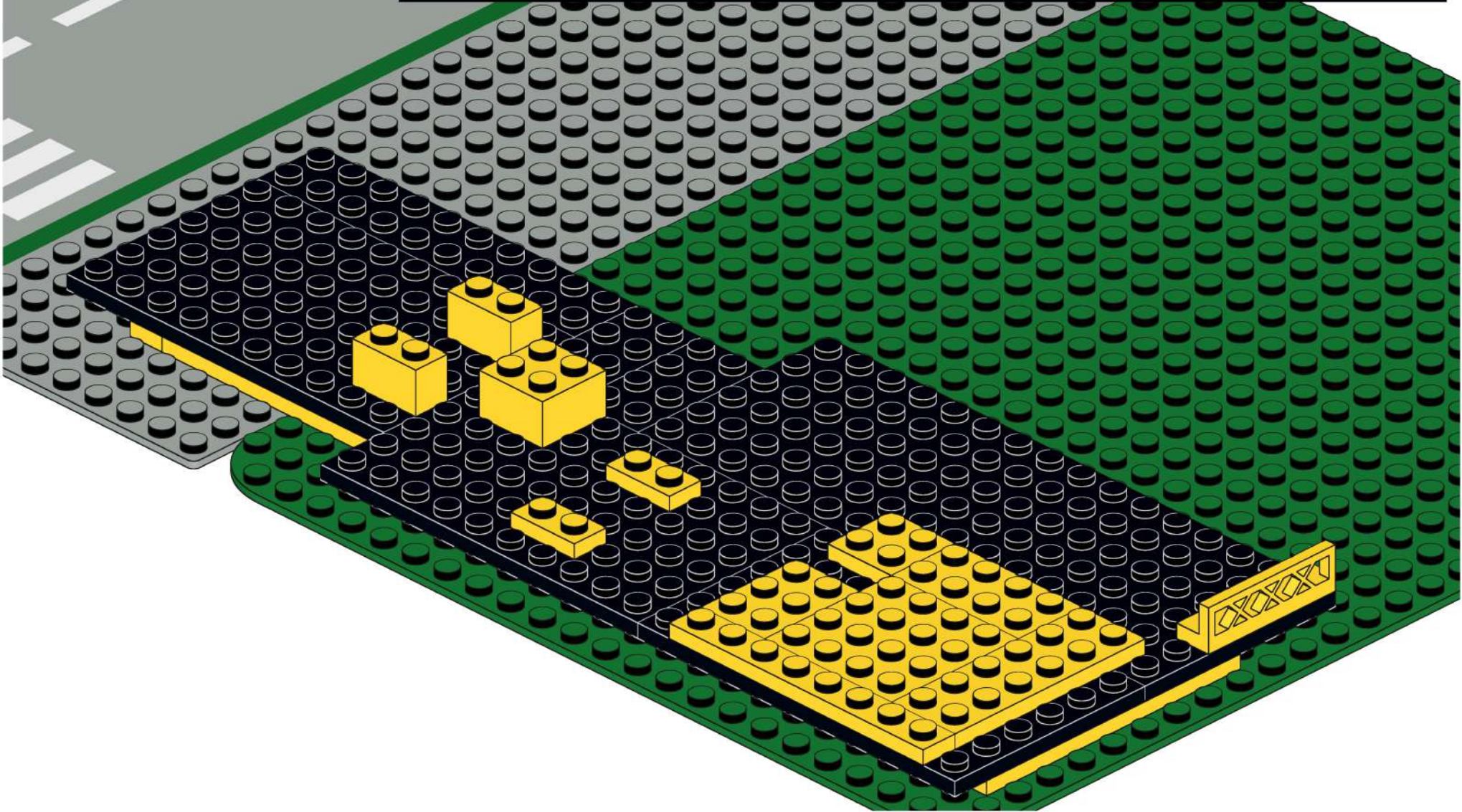
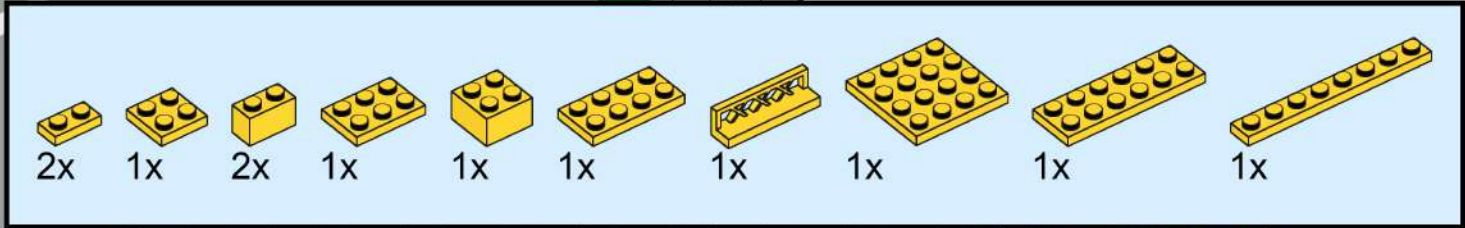

5

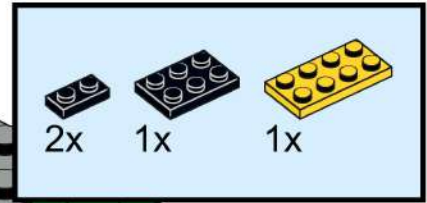

2x 1x 1x

This inset box lists the parts required for step 5: two black 1x2 Technic bricks, one black 1x4 Technic brick, and one yellow 1x4 Technic brick.

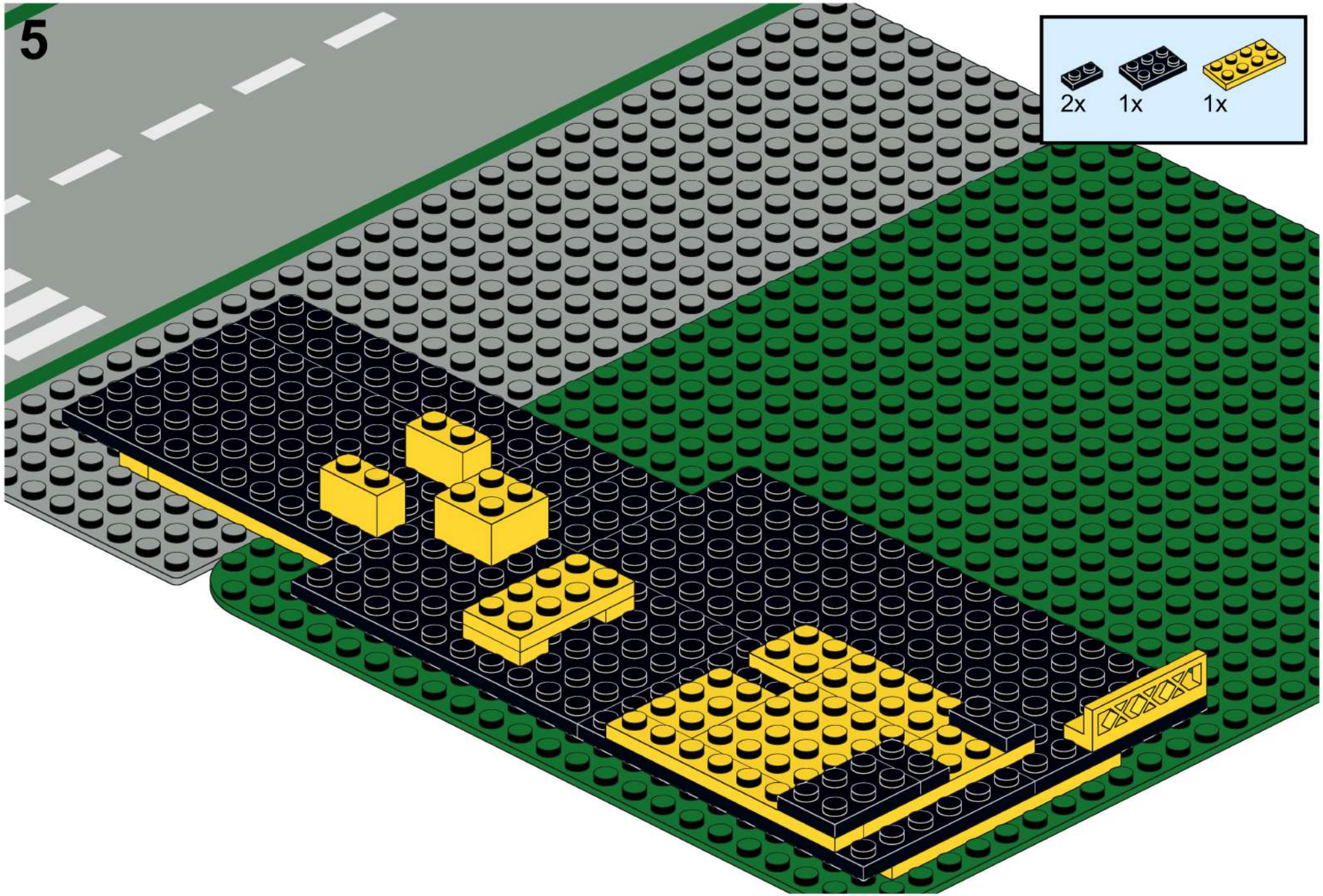

6

3x 6x 2x 1x 1x 1x 2x

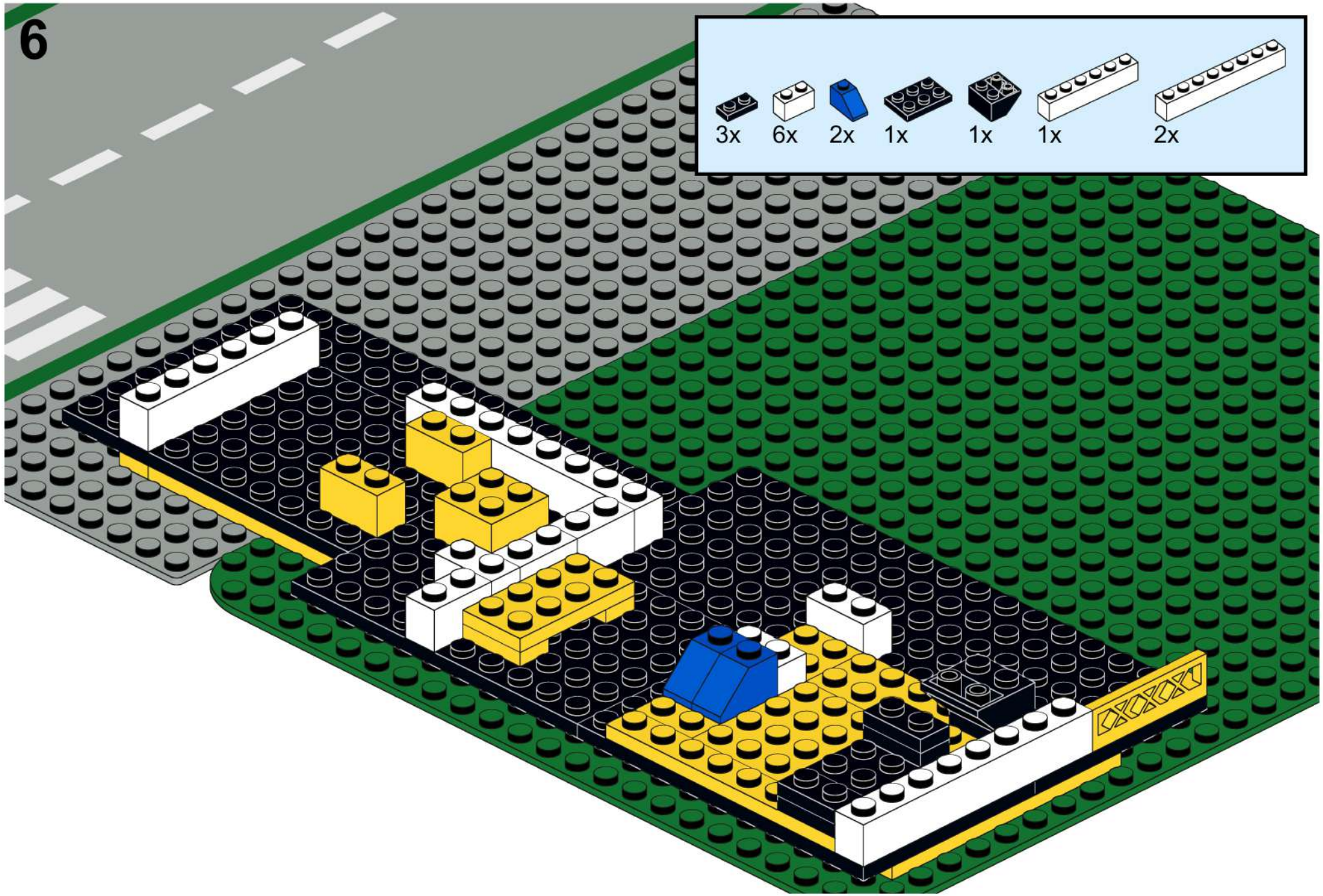

7

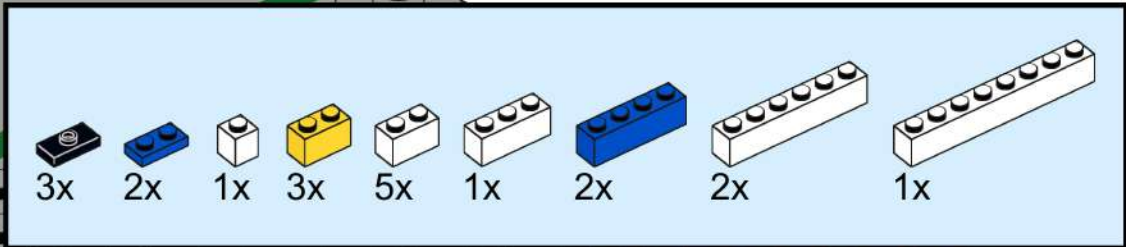





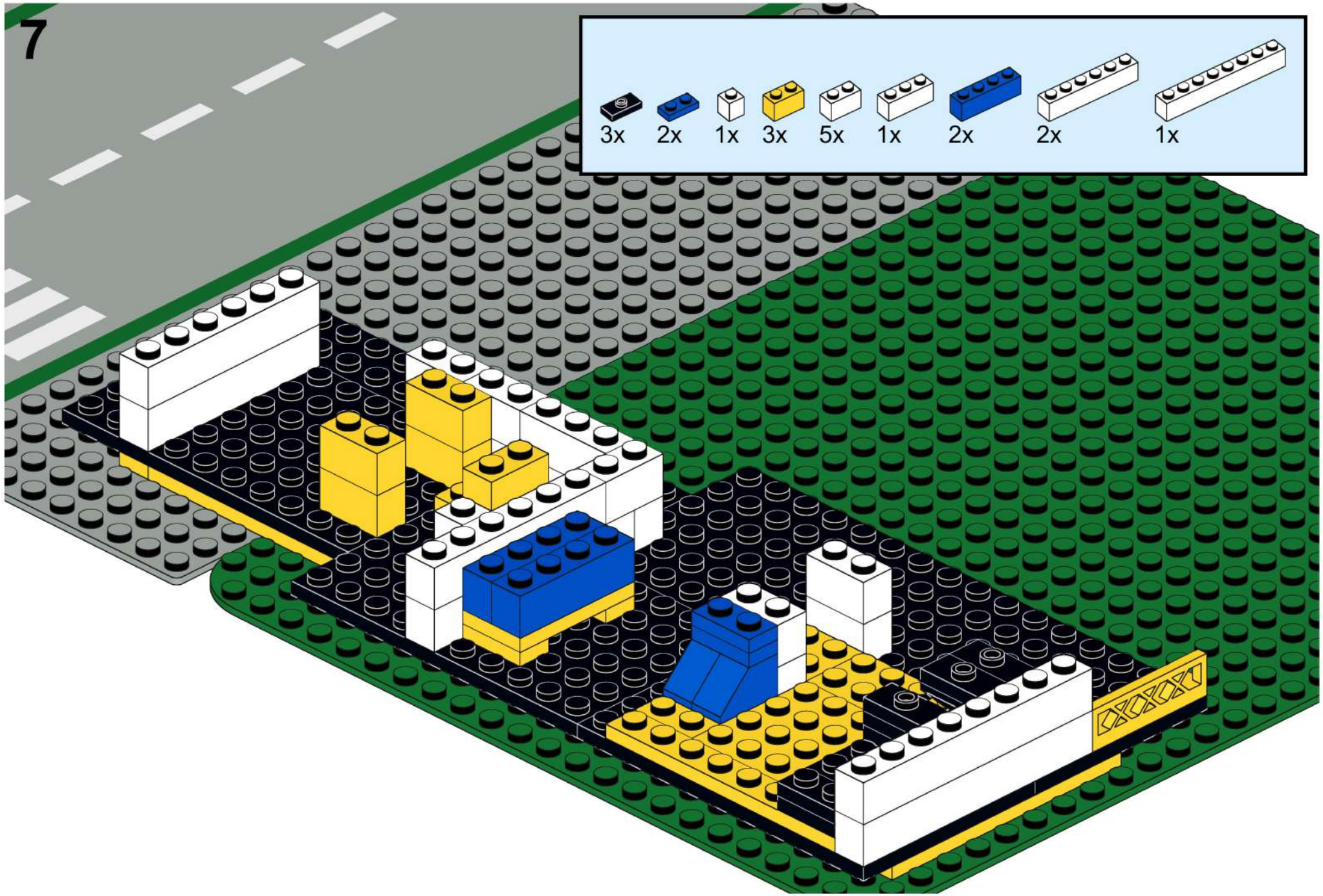

3x 2x 1x 3x 5x 1x 2x 2x 1x

This block contains a list of LEGO parts with their respective quantities. From left to right: a black 1x2 Technic brick with a hole (3x), a blue 1x2 Technic brick (2x), a white 1x1 Technic brick (1x), a yellow 1x2 Technic brick (3x), a white 1x2 Technic brick (5x), a white 1x3 Technic brick (1x), a blue 1x3 Technic brick (2x), a white 1x5 Technic brick (2x), and a white 1x7 Technic brick (1x).



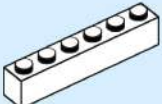

8

						
2x	6x	1x	1x	1x	2x	1x

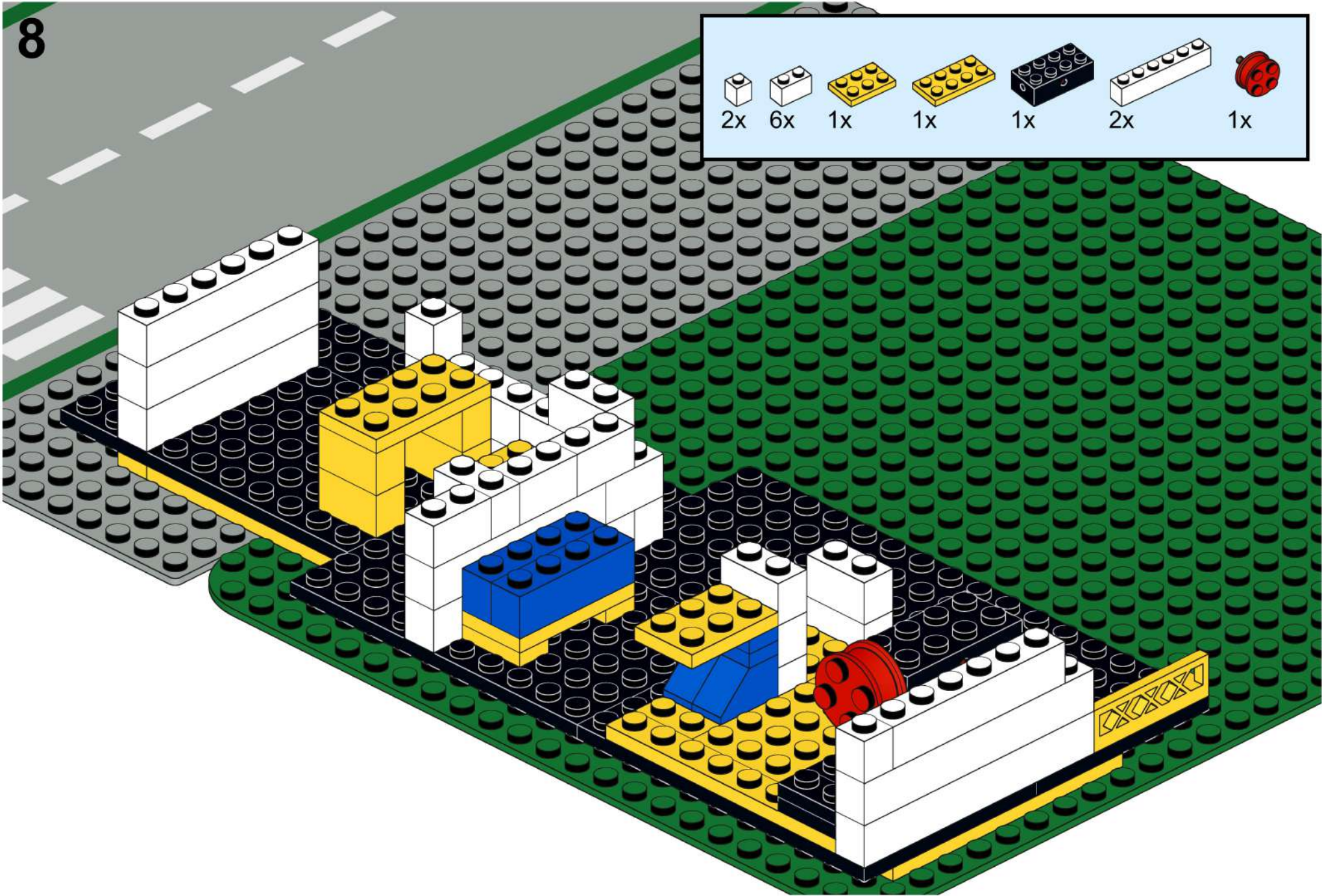

9

1x	4x	1x	1x	1x	1x	2x	4x	3x

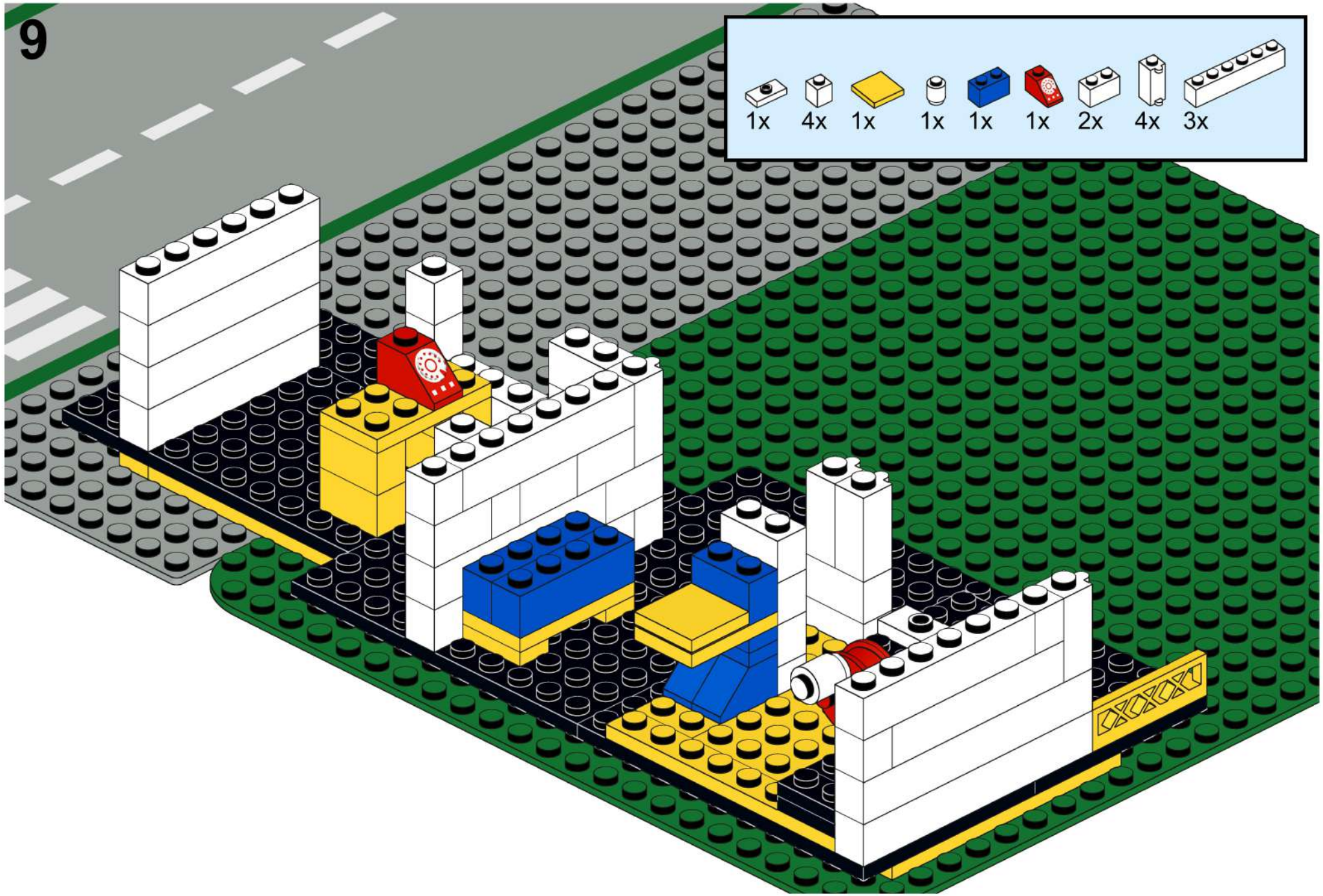

10

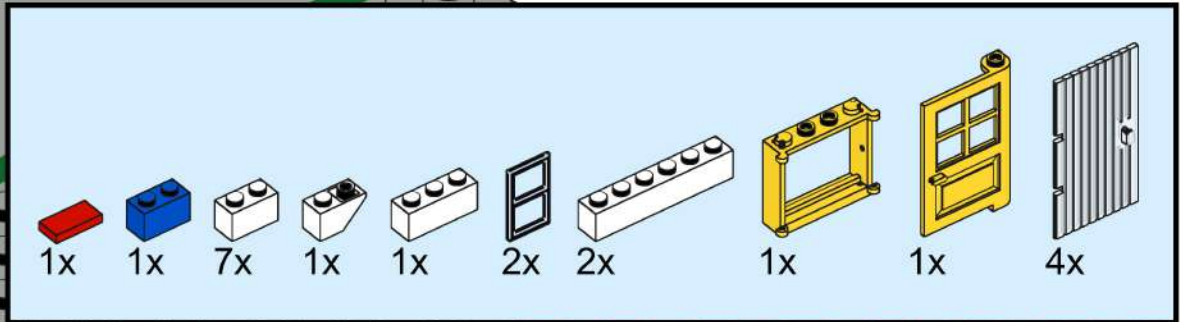

1x 1x 7x 1x 1x 2x 2x 1x 1x 4x

This block contains a parts list for step 10. It lists ten items with their respective quantities: a red 1x1 brick (1x), a blue 1x2 brick (1x), seven white 1x2 bricks (7x), one white 1x2 brick with a hole (1x), one white 1x3 brick (1x), two white 1x2 window panes (2x), two white 1x4 Technic bricks (2x), one yellow window frame (1x), one yellow door frame (1x), and four white vertical window blinds (4x).

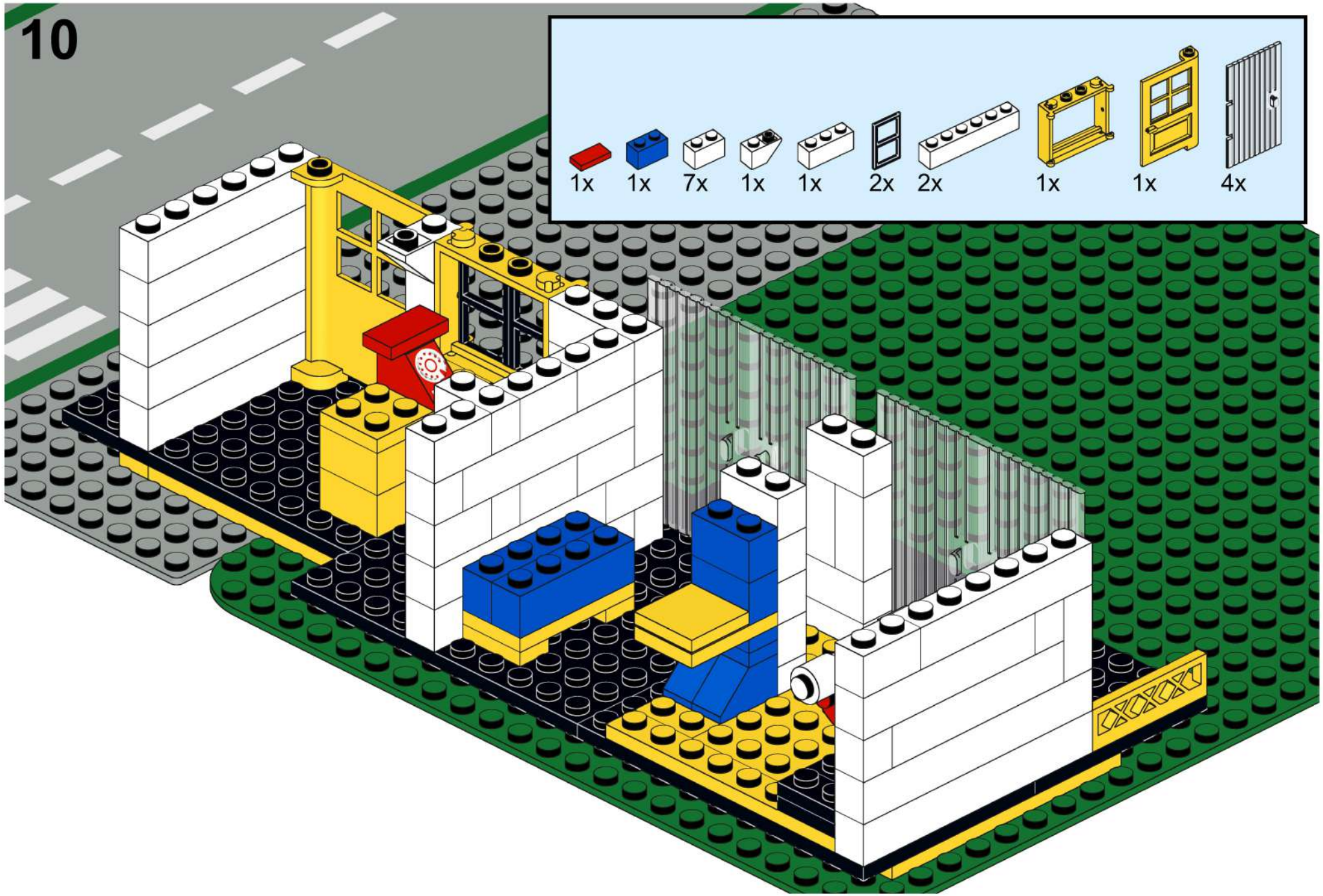

11

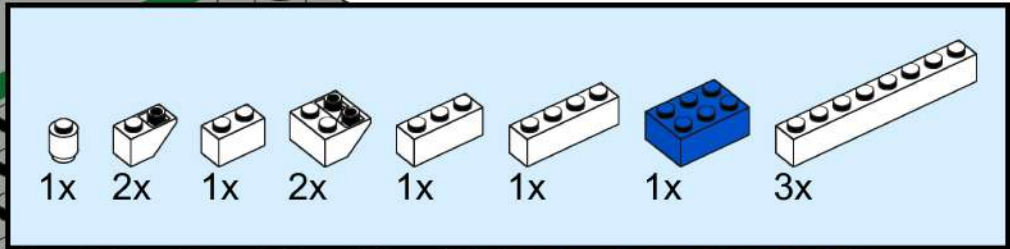

1x 2x 1x 2x 1x 1x 1x 3x

This block contains a parts list for step 11. It features eight items with their respective quantities: a white 1-hole Technic pin (1x), a white 1-hole Technic axle (2x), a white 1-hole Technic brick (1x), a white 1-hole Technic brick with a hole (2x), a white 1-hole Technic brick (1x), a white 1-hole Technic brick (1x), a blue 1-hole Technic brick (1x), and a white 1-hole Technic long brick (3x).

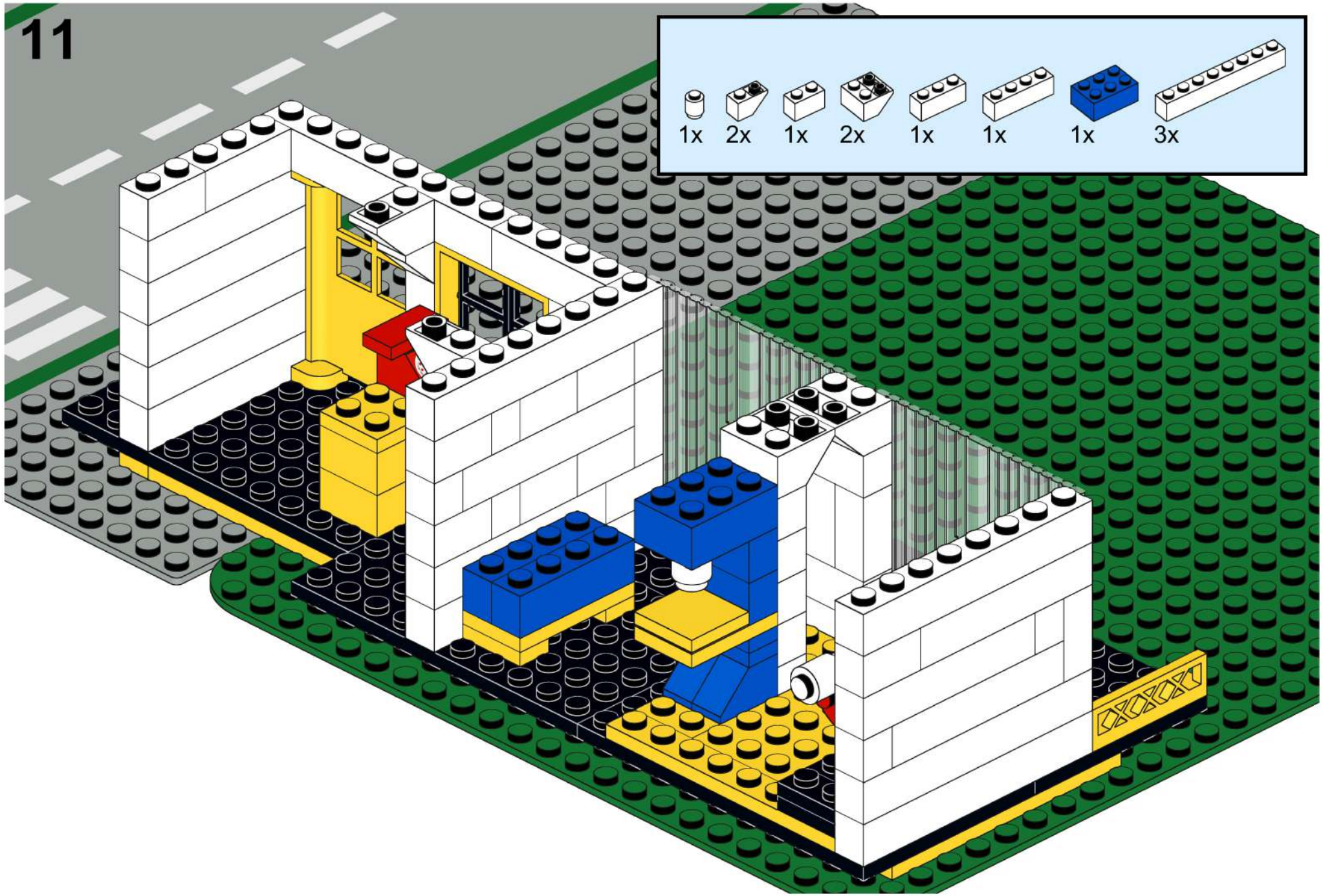

12

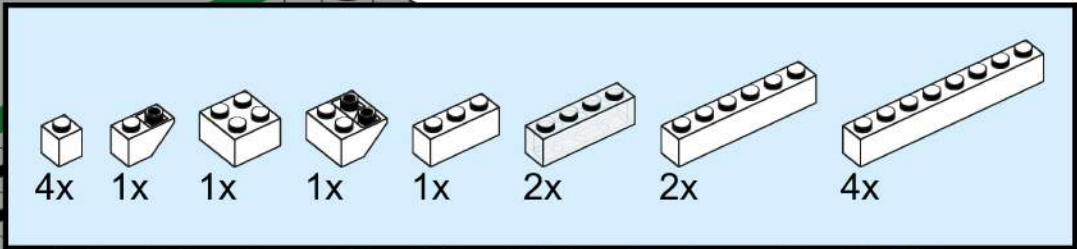

4x 1x 1x 1x 1x 2x 2x 4x

This block contains a parts list for step 12. It lists eight different white LEGO Technic parts with their respective quantities: 4x 1-hole Technic brick, 1x 1-hole Technic brick with a hole, 1x 2-hole Technic brick, 1x 2-hole Technic brick with a hole, 1x 3-hole Technic brick, 2x 4-hole Technic brick, 2x 5-hole Technic brick, and 4x 6-hole Technic brick.

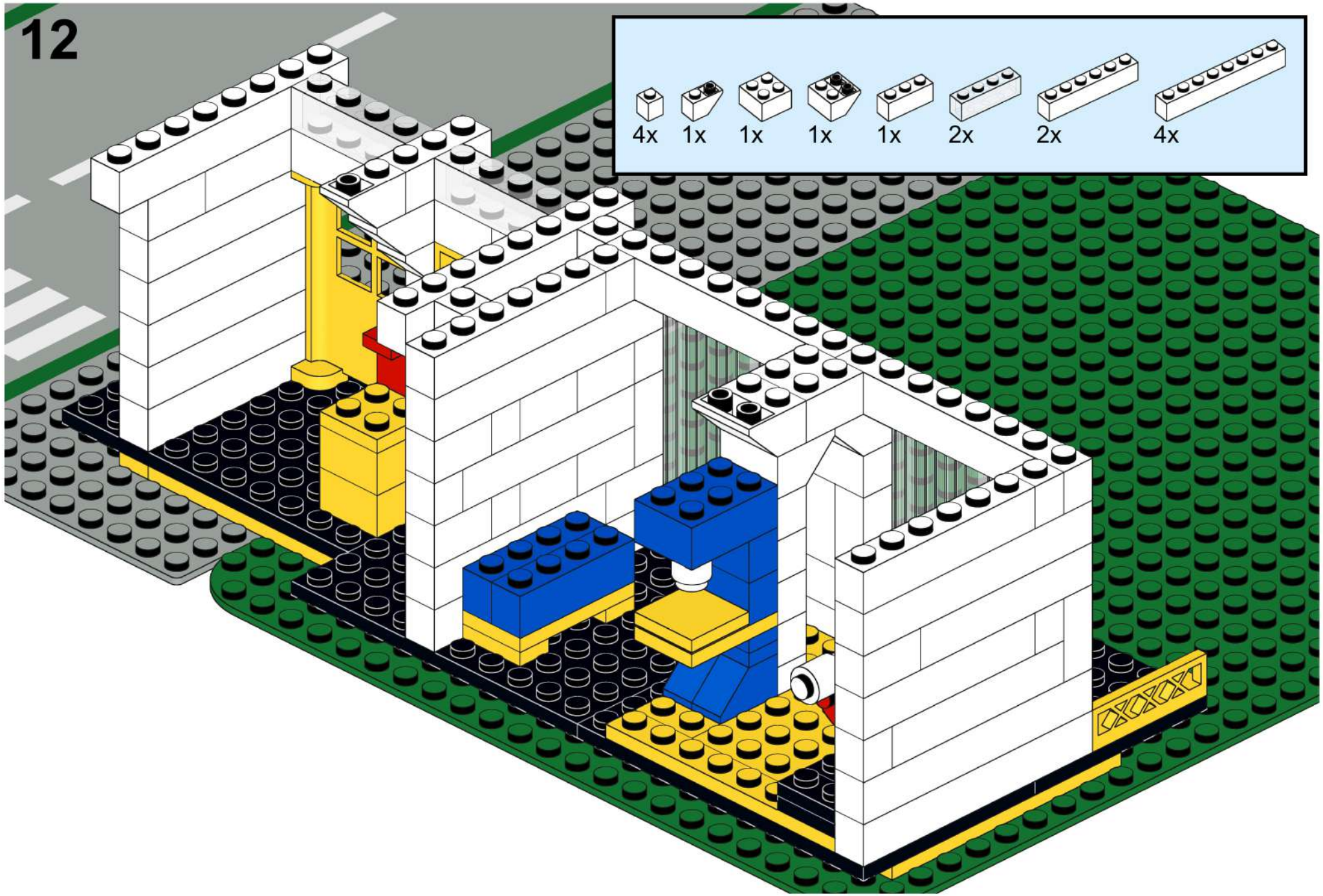

13

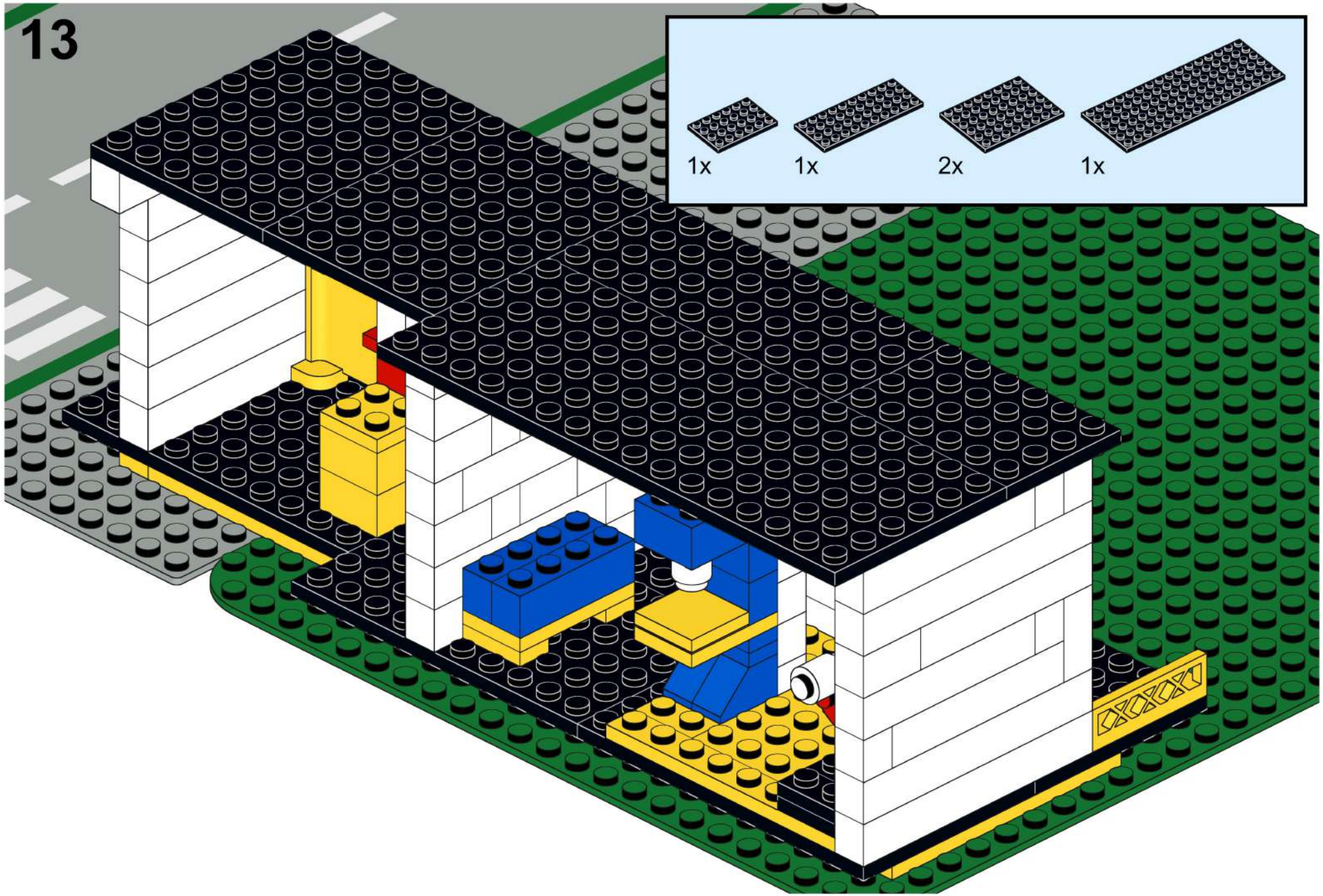
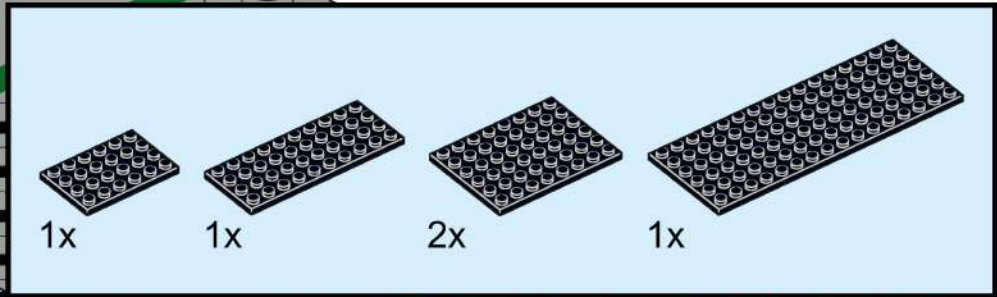

14

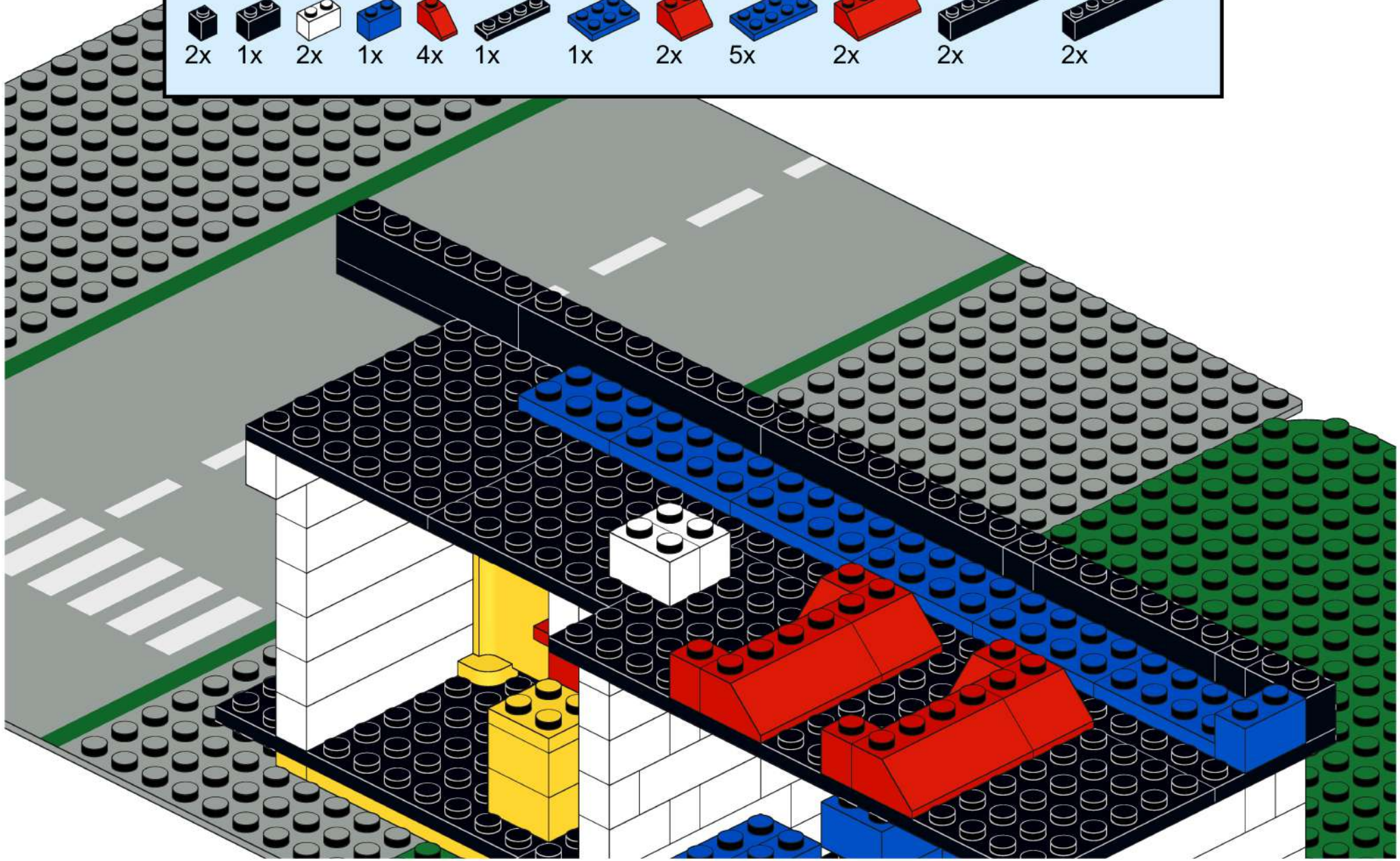
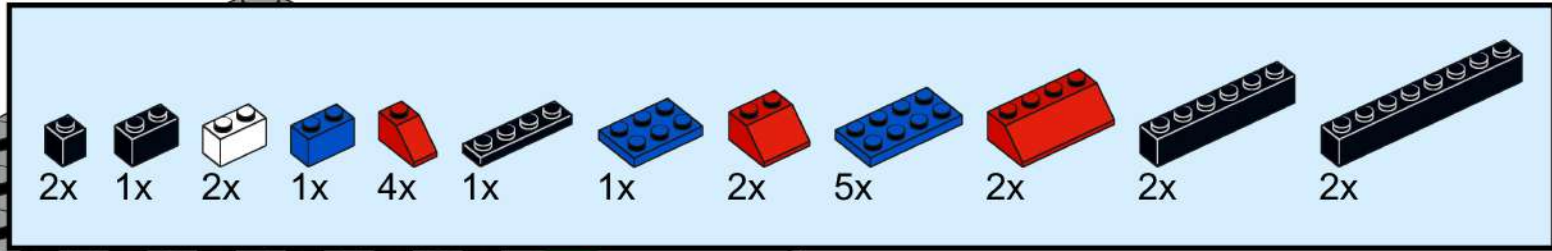

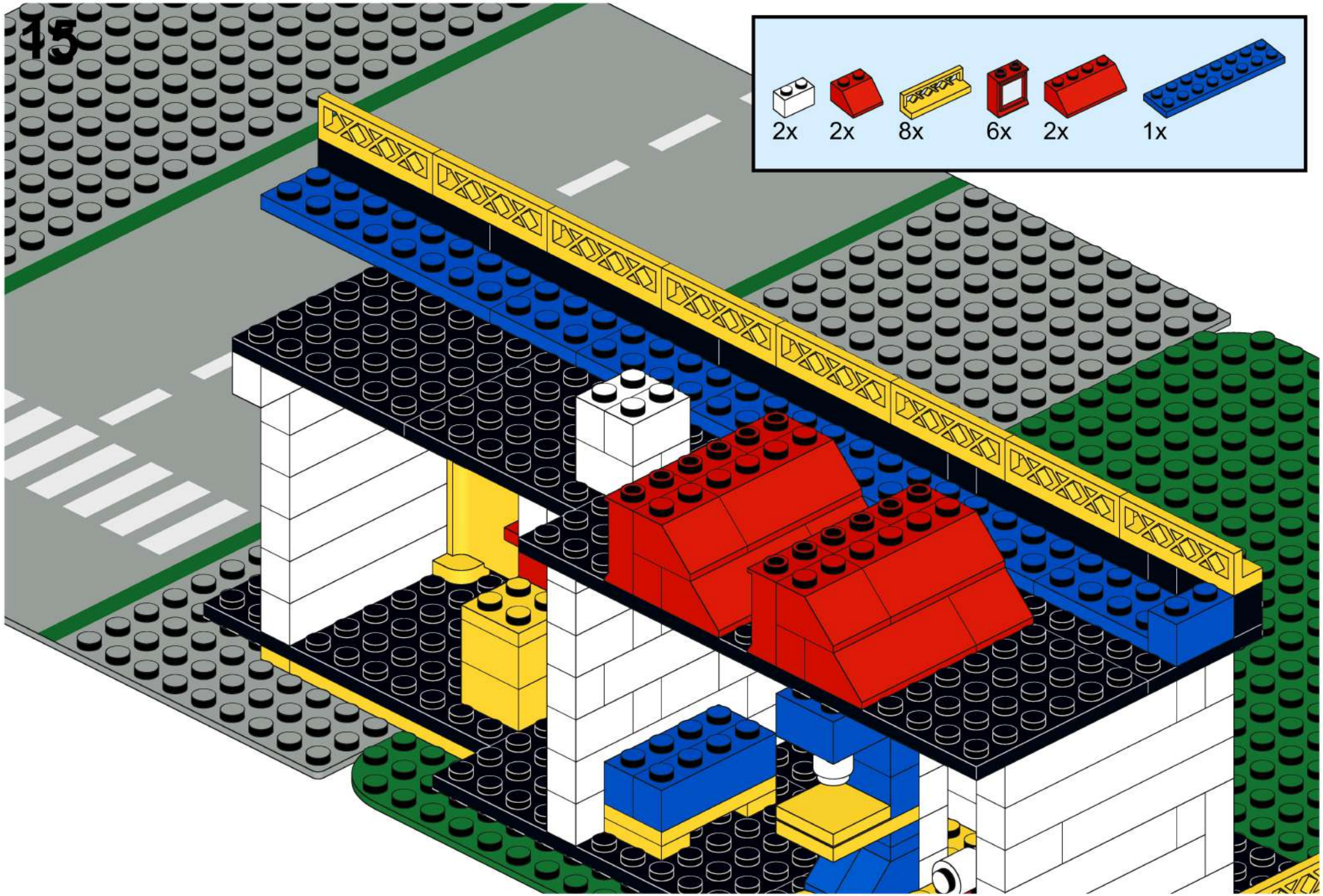



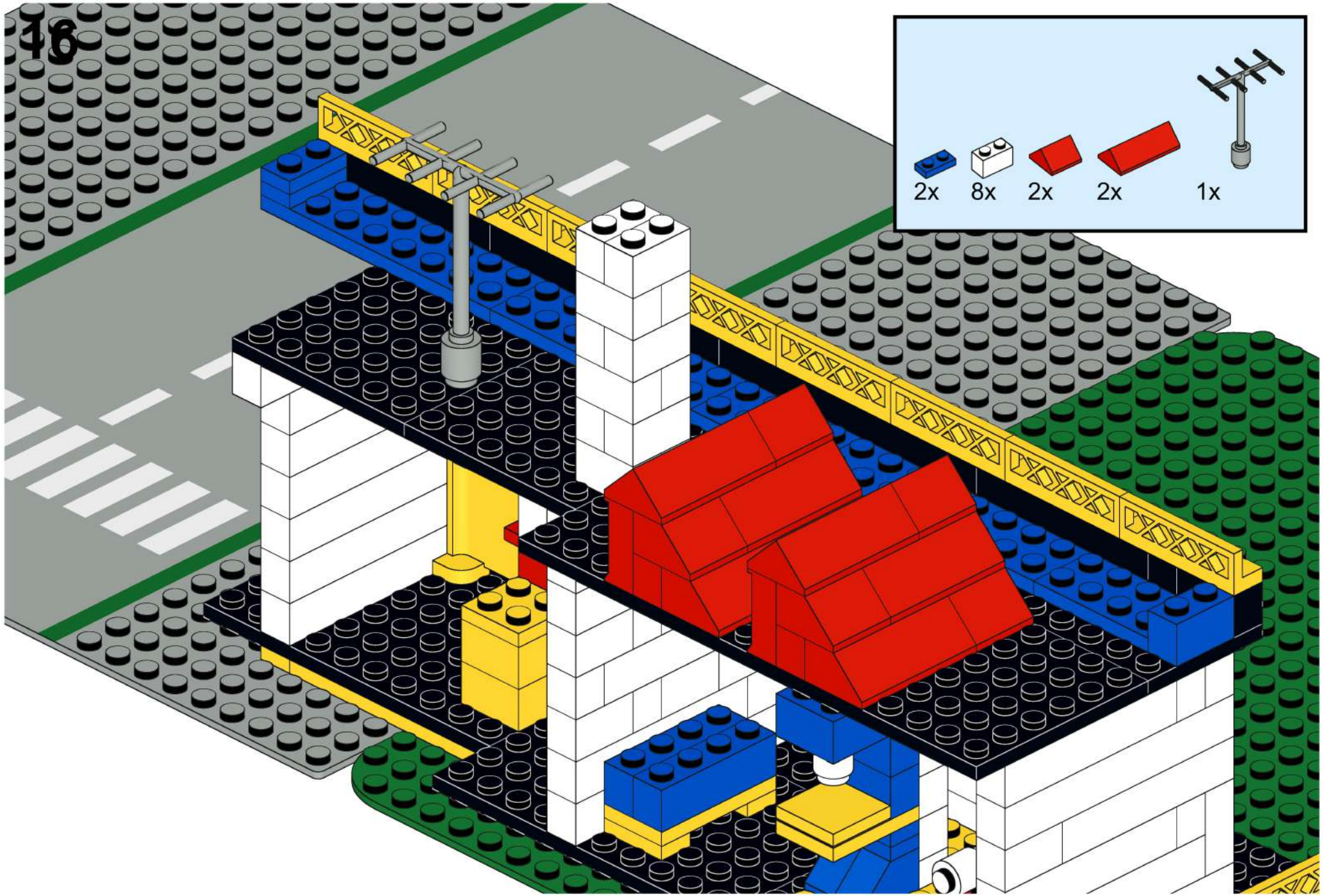

45

- 2x
- 2x
- 8x
- 6x
- 2x
- 1x



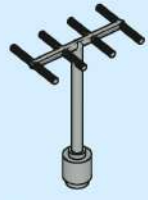

46

				
2x	8x	2x	2x	1x

17

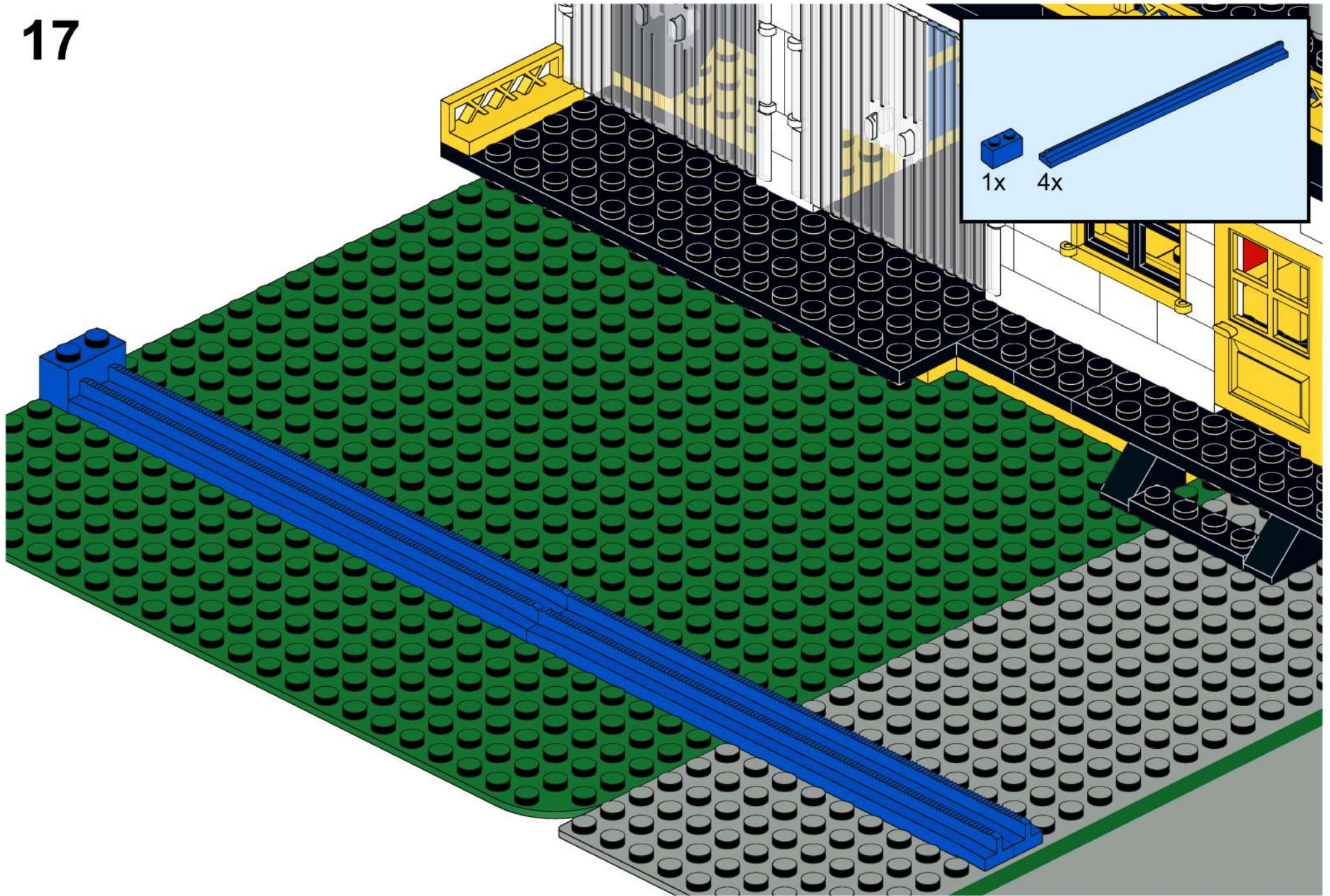

18

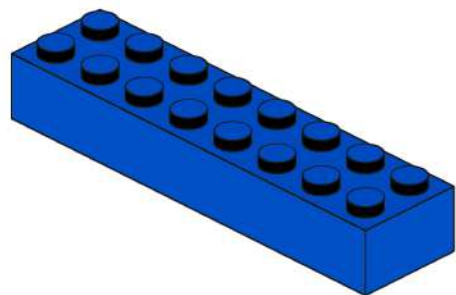
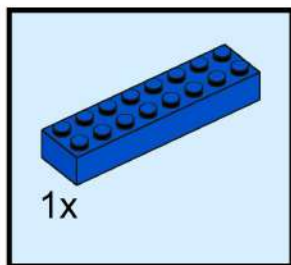

20

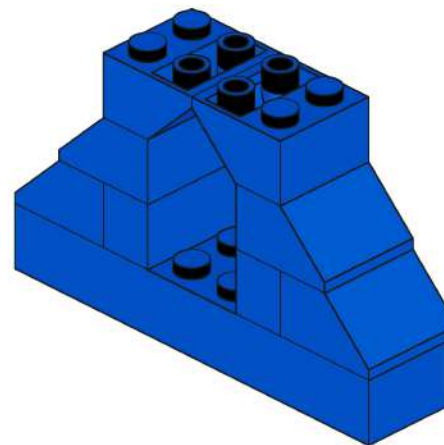
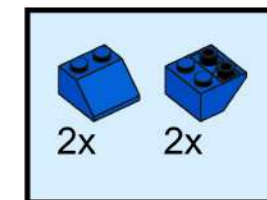
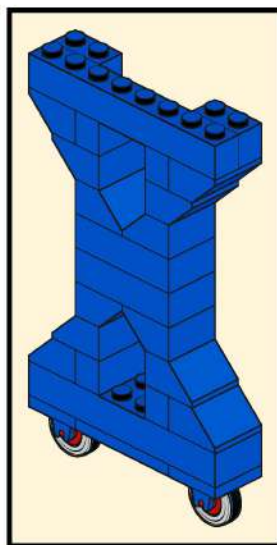

19

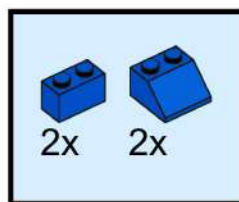

21

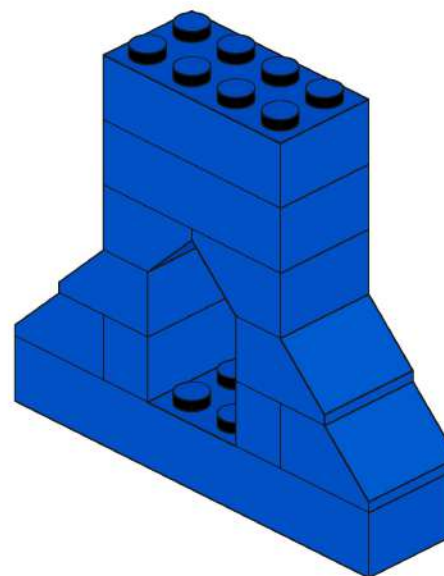
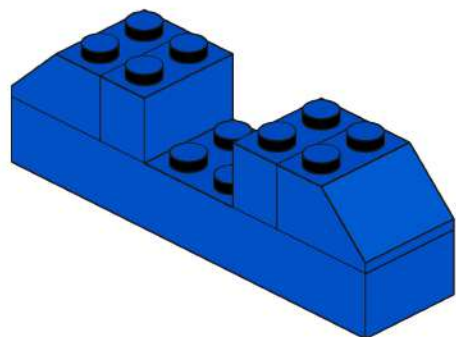
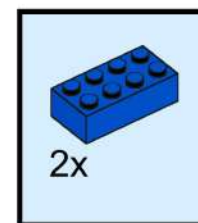

22

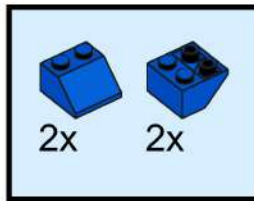
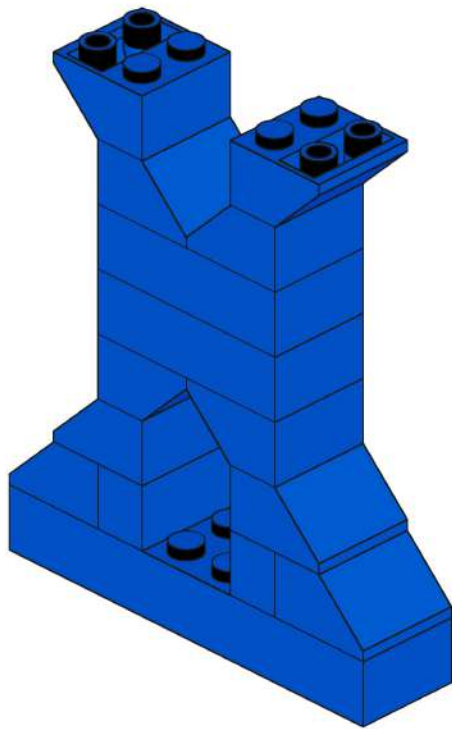

23

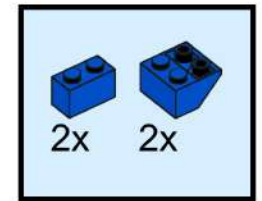
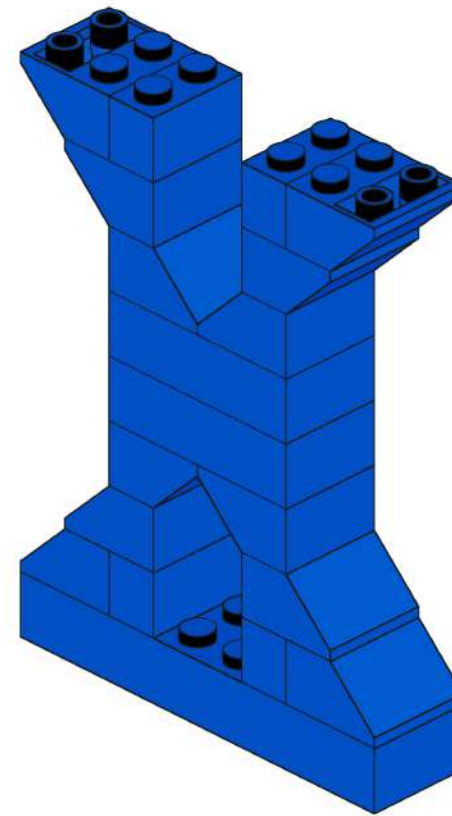

24

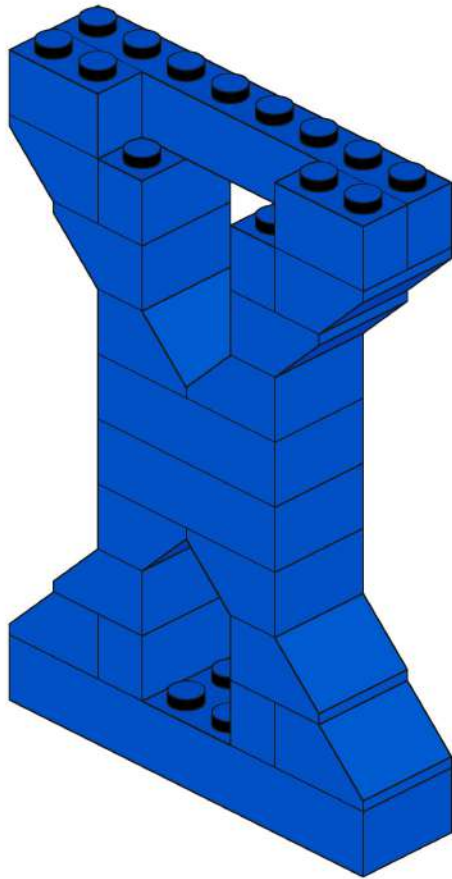
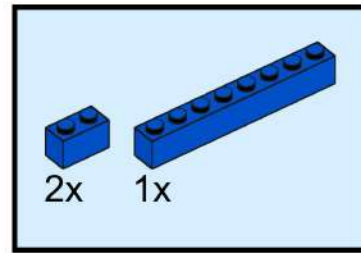

25

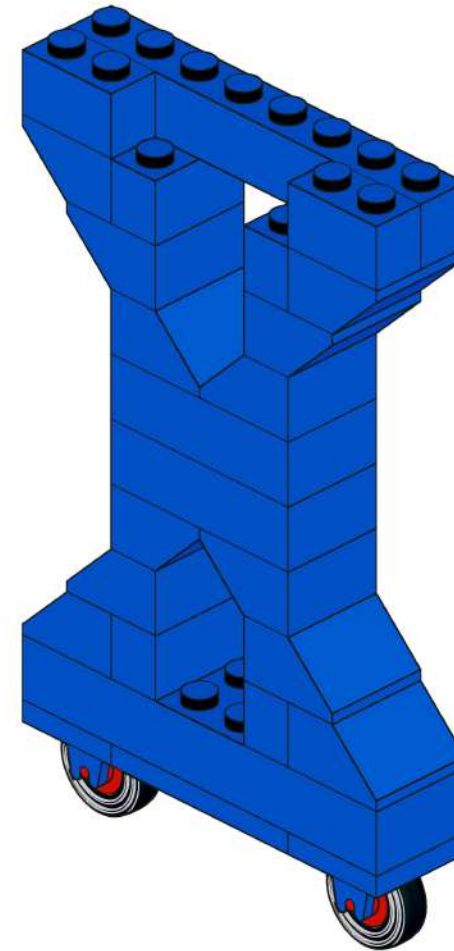
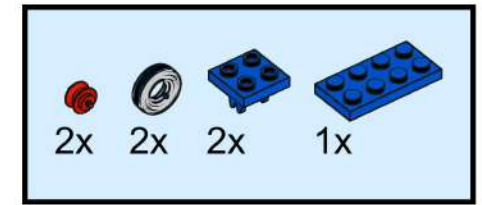

26

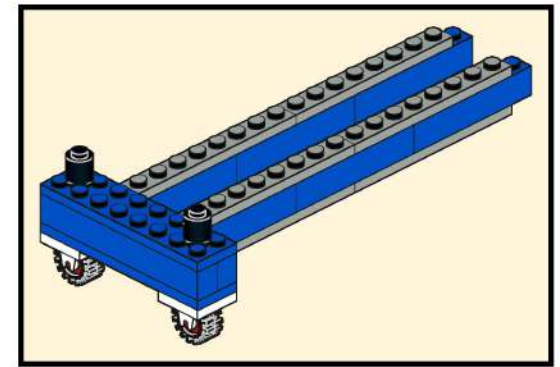
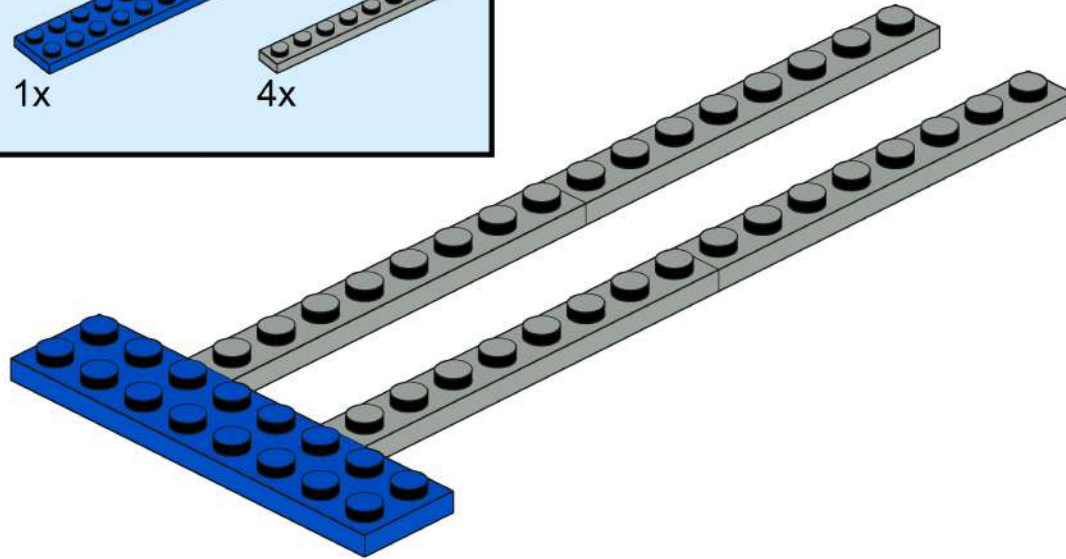
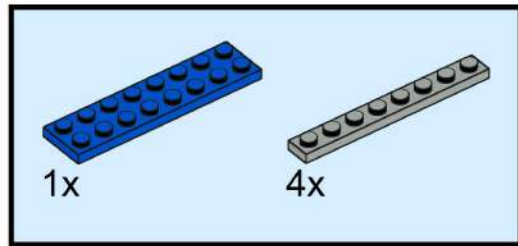

27

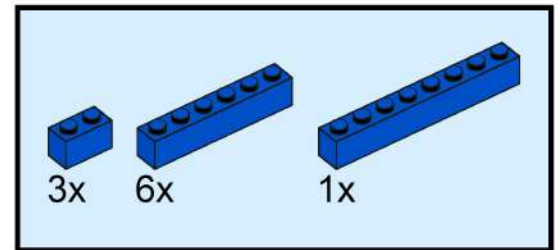
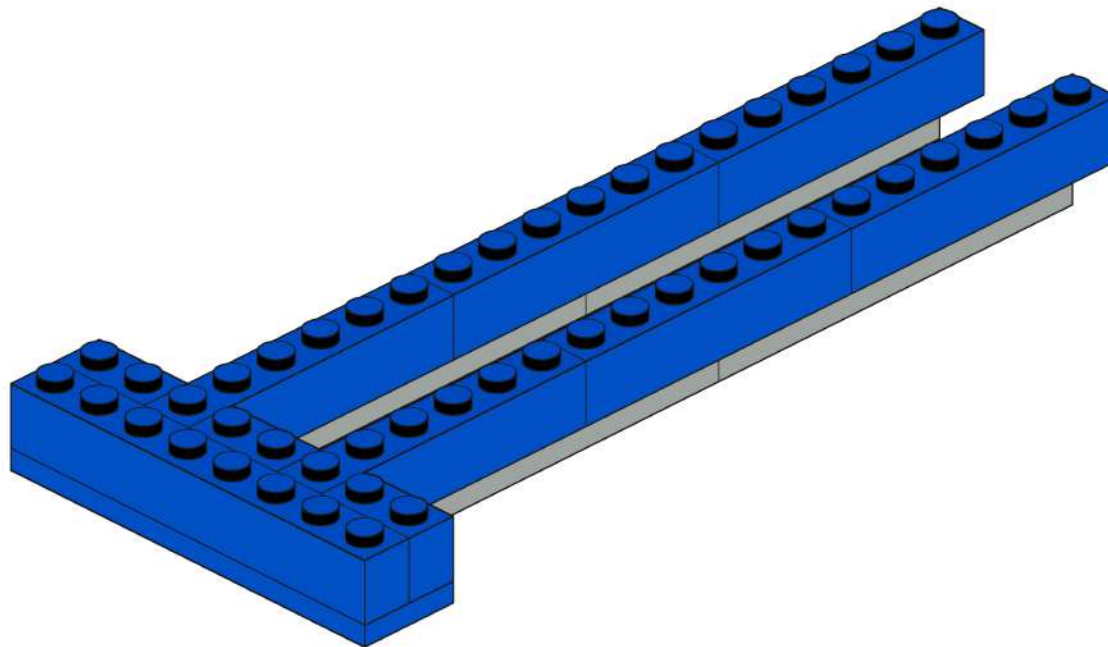

28

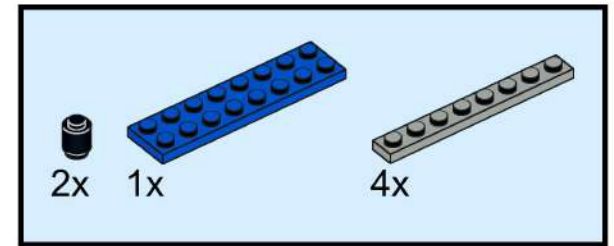
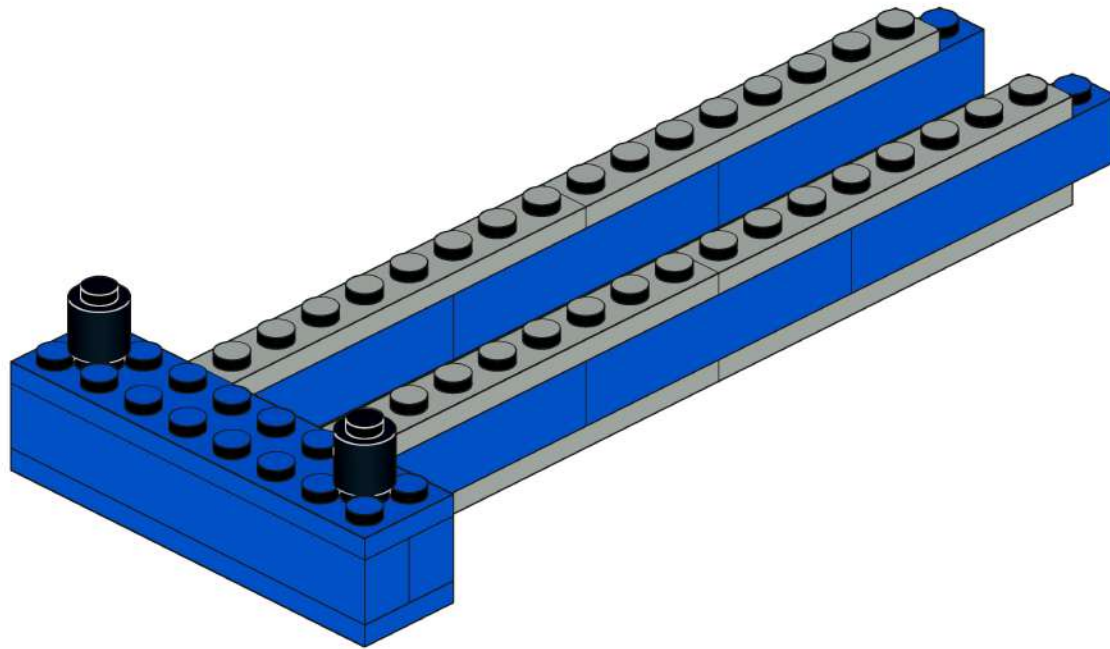

29

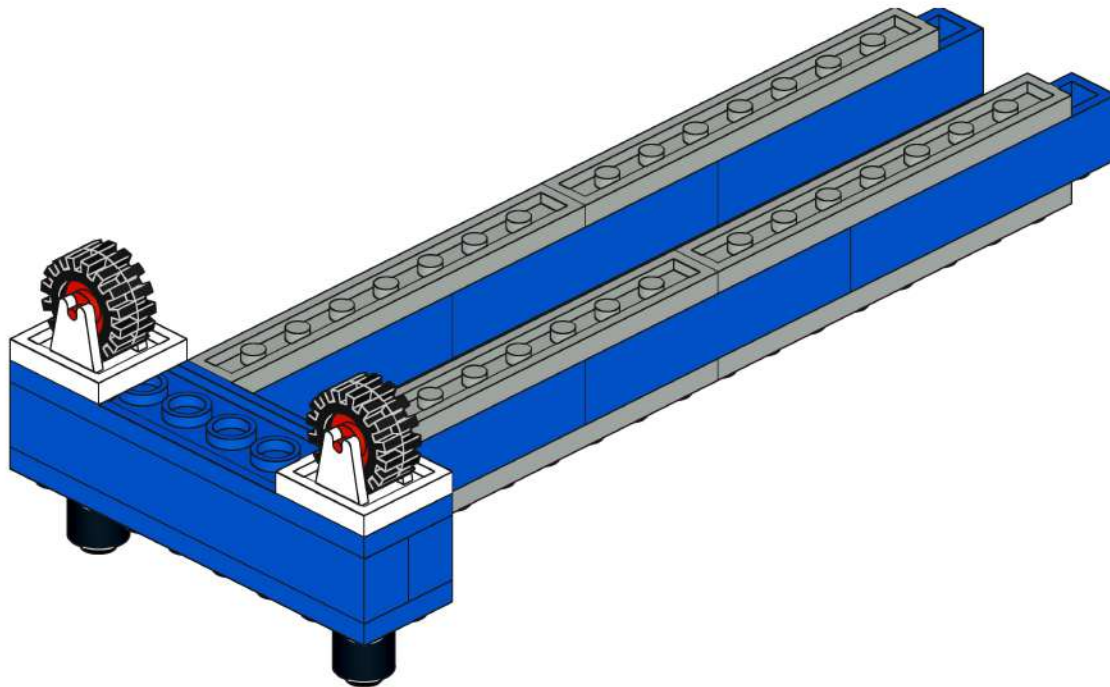

30

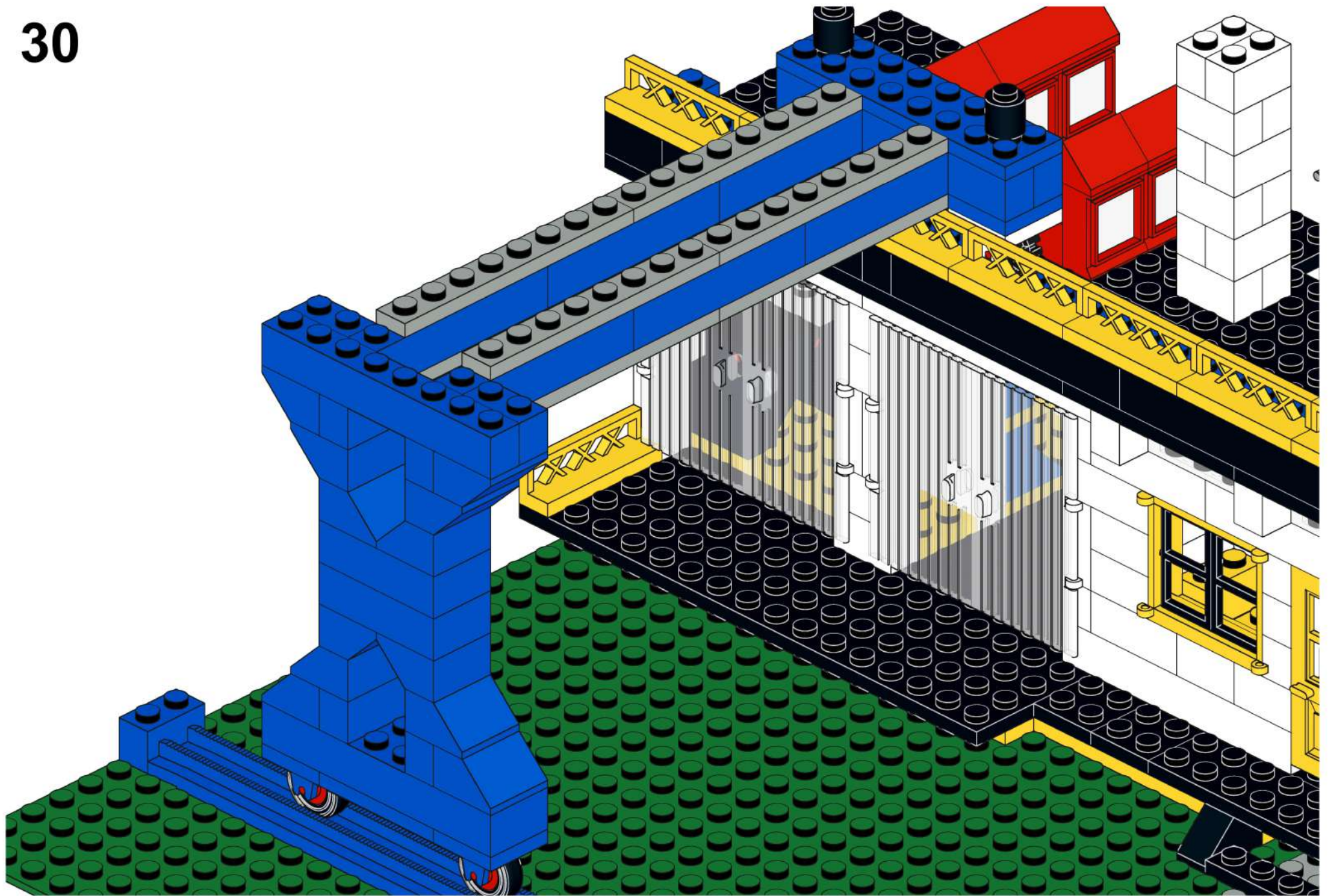



31

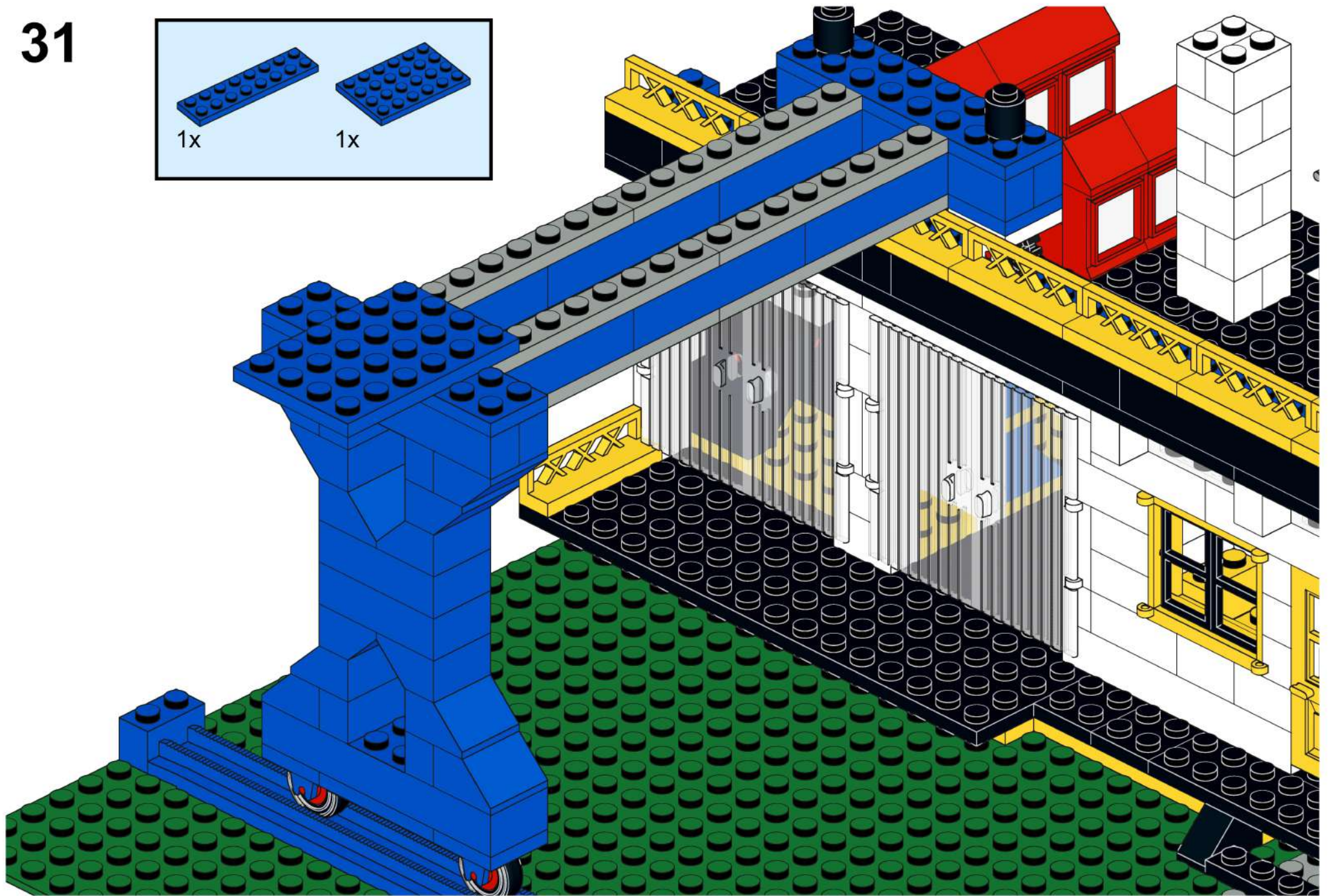
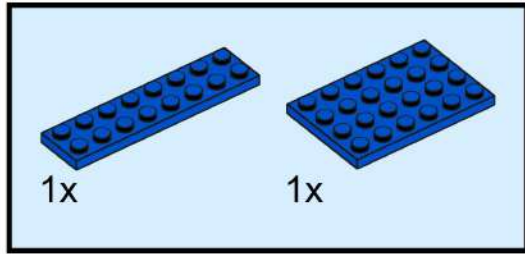

32

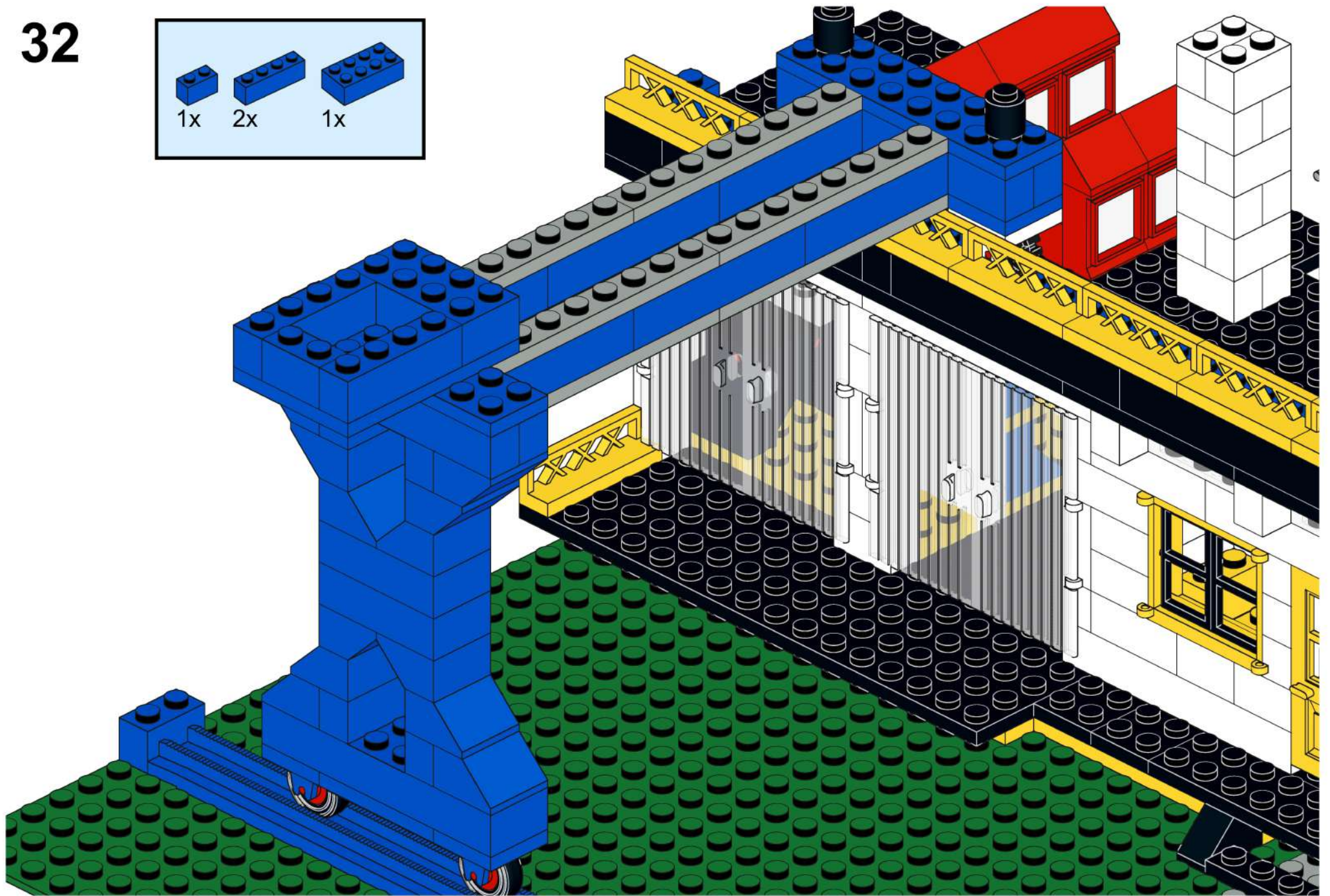
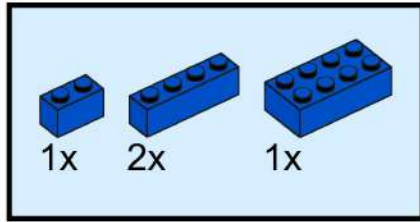

33

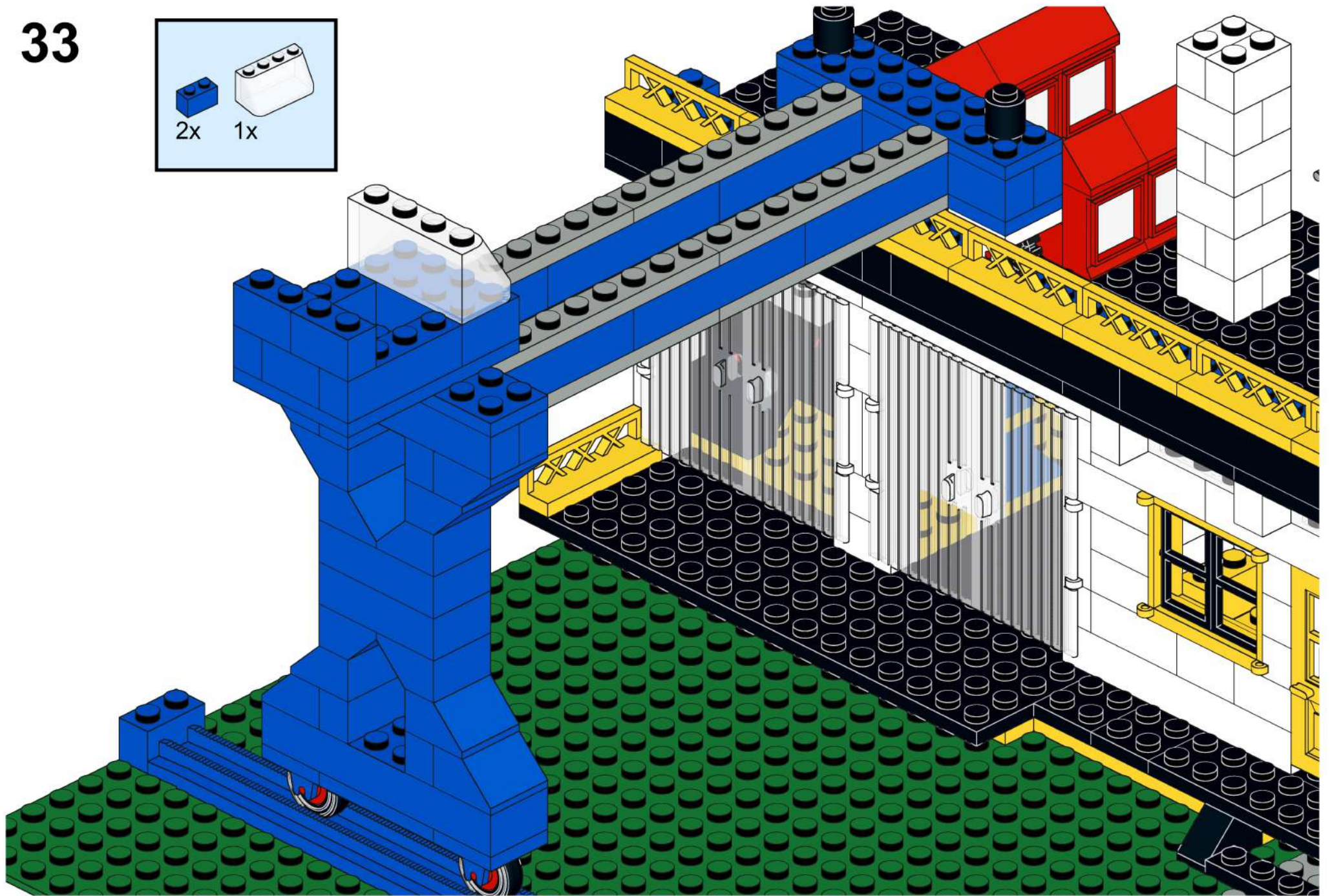
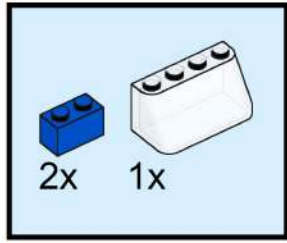

# 34

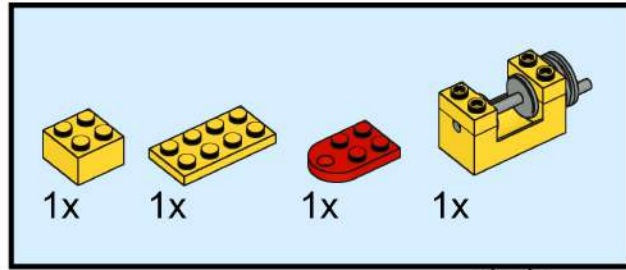

Tie string to drum real and plate with hole. See photo on page 38 of Idea Book 6000. String is not shown in these instructions because it is not included in Studio.

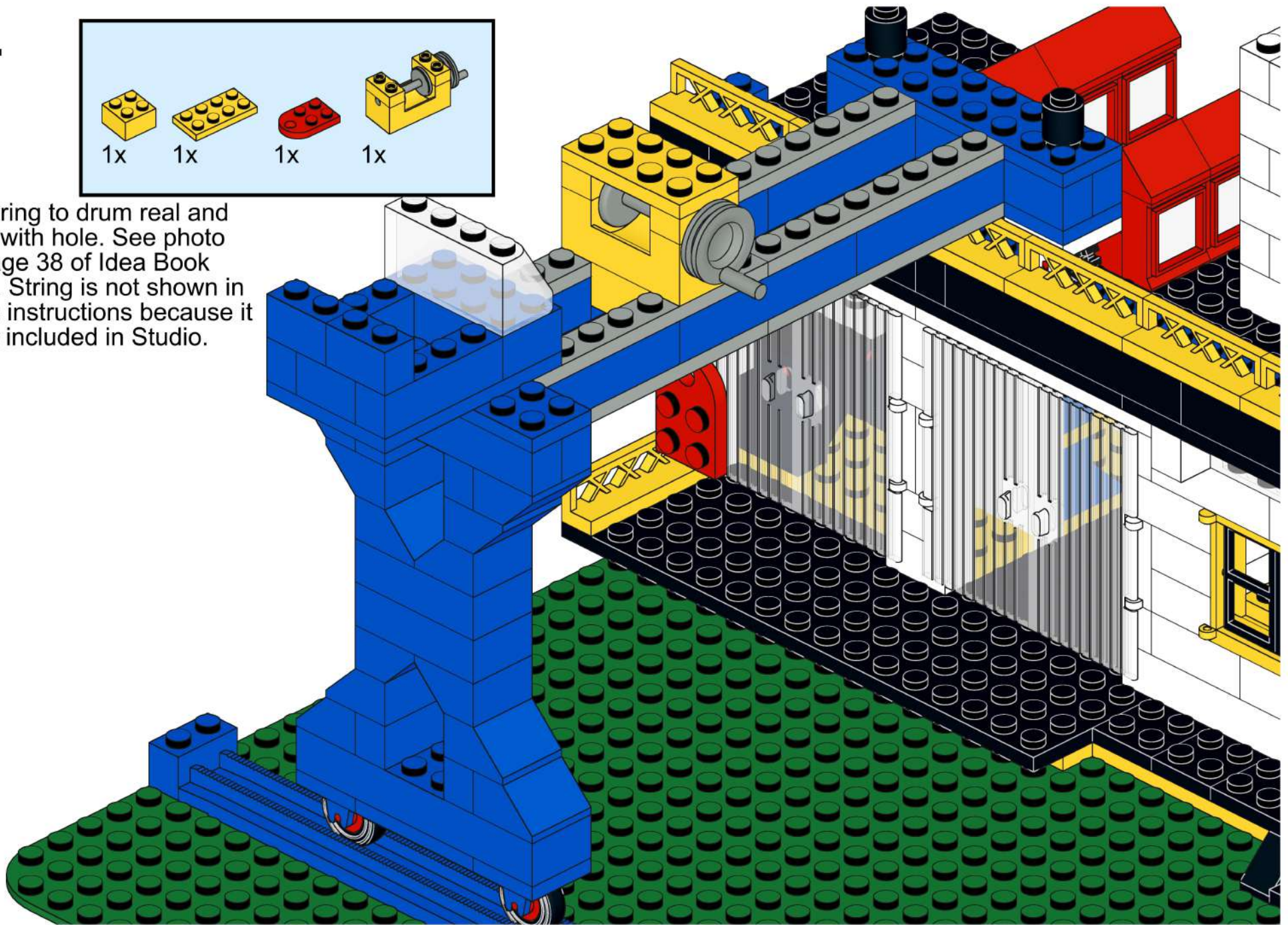

35

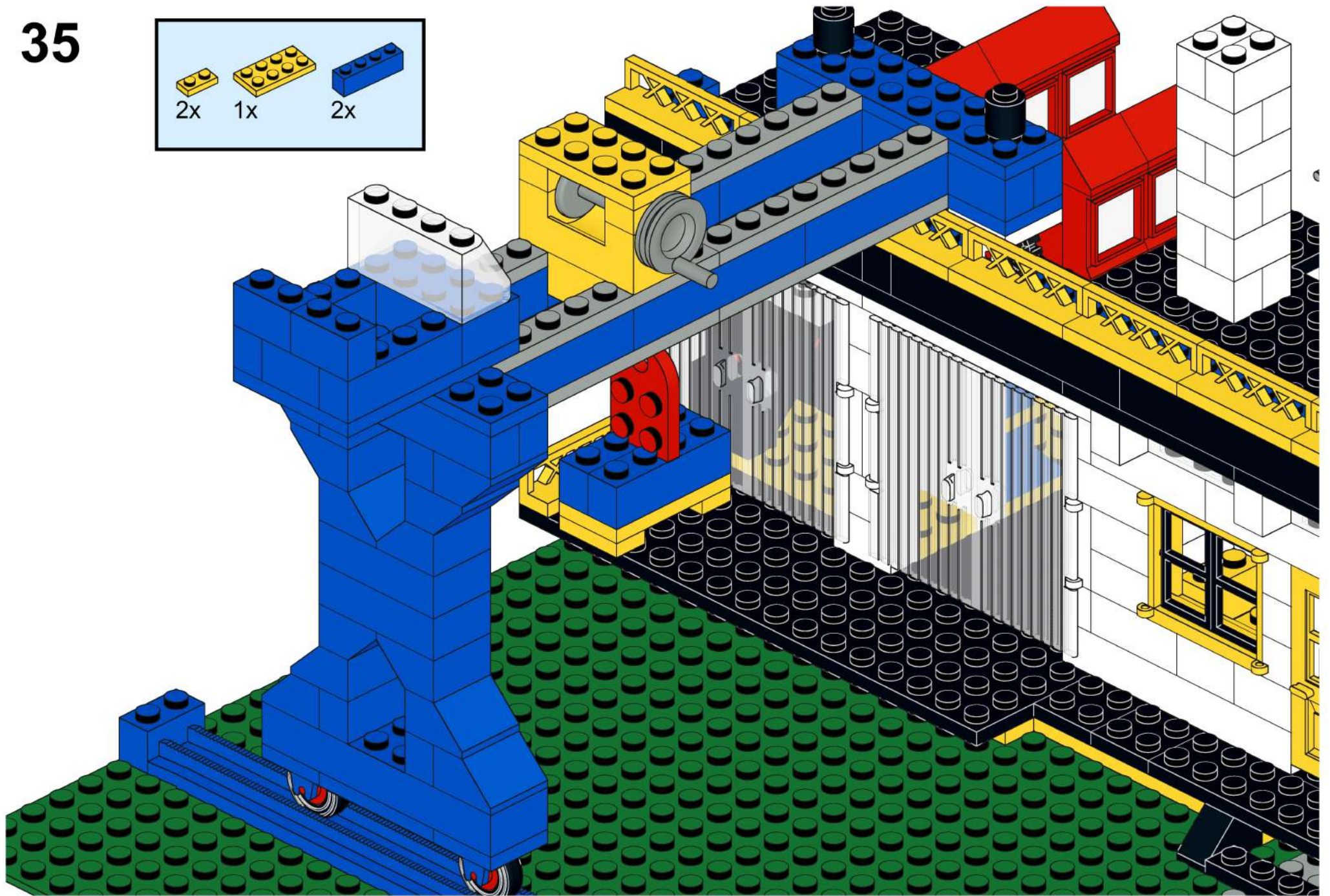
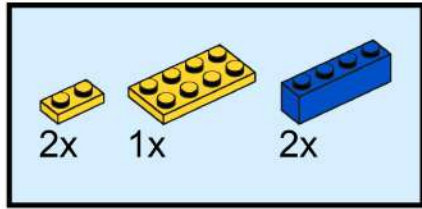

- 2x 3062a Black
- 2x 3021 Black
- 2x 3005 Black
- 5x 3023 Black
- 3x 3794a Black
- 2x 3139 Black
- 1x 3004 Black
- 2x 3040 Black
- 1x 3660 Black
- 2x 3854 Black
- 2x 3021 Black
- 2x 3710 Black
- 2x 3020 Black
- 1x 7049b Black
- 2x 3009 Black
- 1x 3032 Black
- 2x 3008 Black
- 2x 3036 Black
- 1x 3832 Black
- 1x 3030 Black
- 3x 3033 Black
- 2x 3027 Black



1x 3144 Light Gray



8x 3460 Light Gray

1x 606p02 Light Gray



11x 3005 White



2x 3062a White

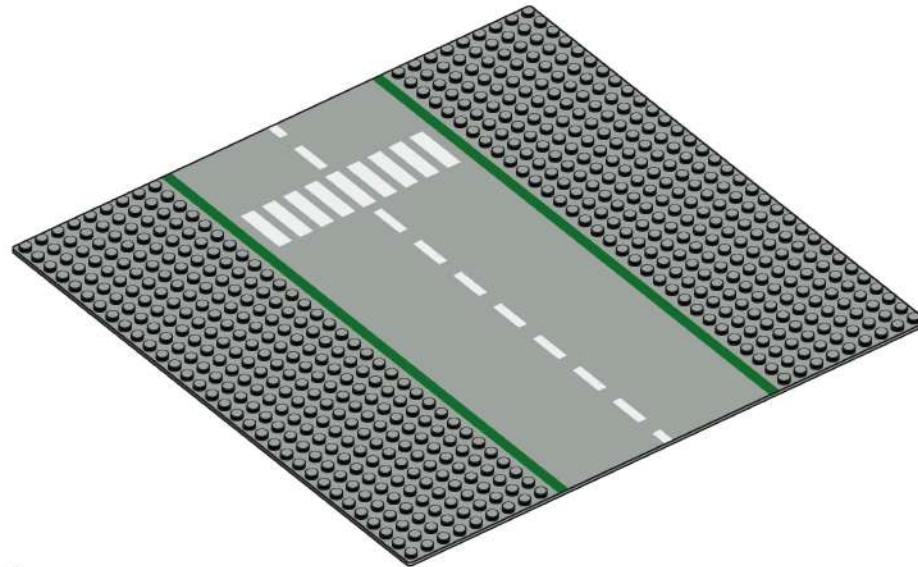

1x 3794a White

4x 3665 White

39x 3004 White

4x 3581 White

2x 8 White

1x 3003 White

3x 3660 White

4x 3622 White

1x 3010 White

12x 3009 White

10x 3008 White

2x 3464 Red

1x 3069b Red

4x 3040 Red

1x 3040p02 Red

2x 3464c02 Red

2x 3043 Red

4x 3039 Red

6x 7026 Red

1x 3176 Red

1x 7039 Red

2x 3041 Red

4x 3037 Red

1x 3005 Yellow

4x 3023 Yellow

6x 3004 Yellow

1x 3022 Yellow

- 1x 3068b Yellow
- 1x 3031 Yellow
- 1x 3460 Yellow
- 2x 3003 Yellow
- 1x 3853 Yellow
- 4x 3008 Yellow
- 2x 3660 Yellow
- 4x 3009 Yellow
- 2x 3021 Yellow
- 1x 3002 Yellow
- 1x 3009p01 Yellow
- 9x 3633 Yellow
- 1x 3795 Yellow
- 1x 3010 Yellow
- 1x 73037 Yellow
- 5x 3020 Yellow
- 1x 3861 Yellow
- 1x 10b Green
- 4x 3023 Blue
- 2x 3040 Blue
- 16x 3004 Blue

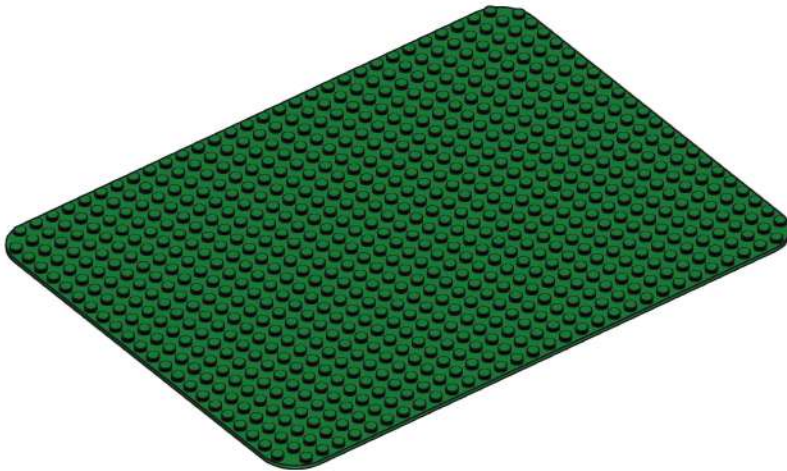

- 2x 8 Blue
- 6x 3009 Blue
- 1x 21 Trans-Clear
- 6x 3660 Blue
- 1x 3032 Blue
- 4x 3644 Trans-Clear
- 6x 3039 Blue
- 2x 3008 Blue
- 1x 3021 Blue
- 1x 3002 Blue
- 4x 3034 Blue
- 6x 3010 Blue
- 1x 3007 Blue
- 6x 3020 Blue
- 4x 3228a Blue
- 3x 3001 Blue
- 2x 3010 Trans-Clear