

1

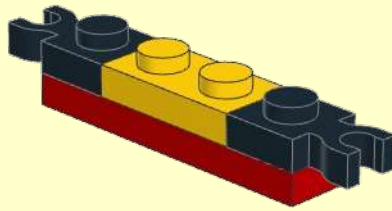

2

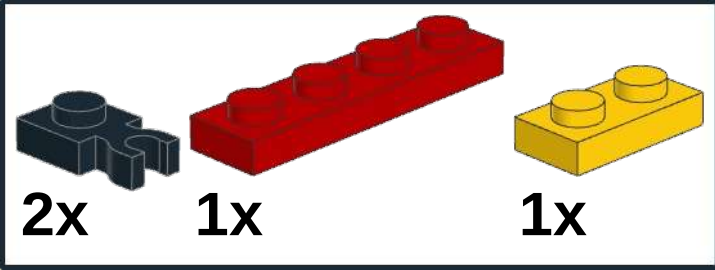
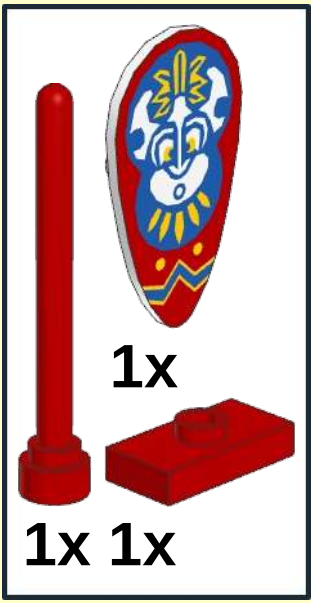

3

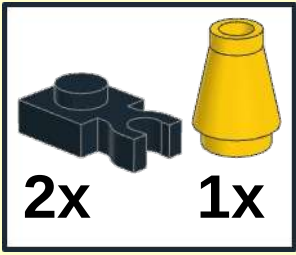

4



5



2x





1

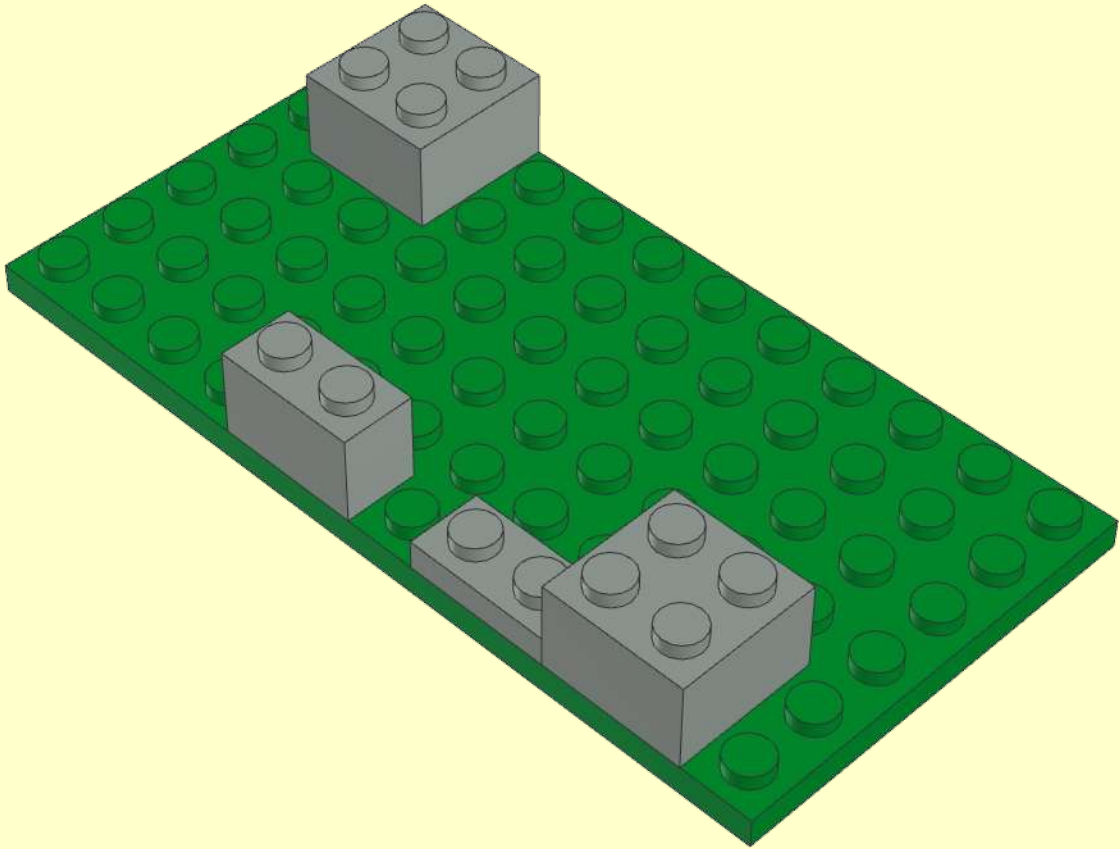
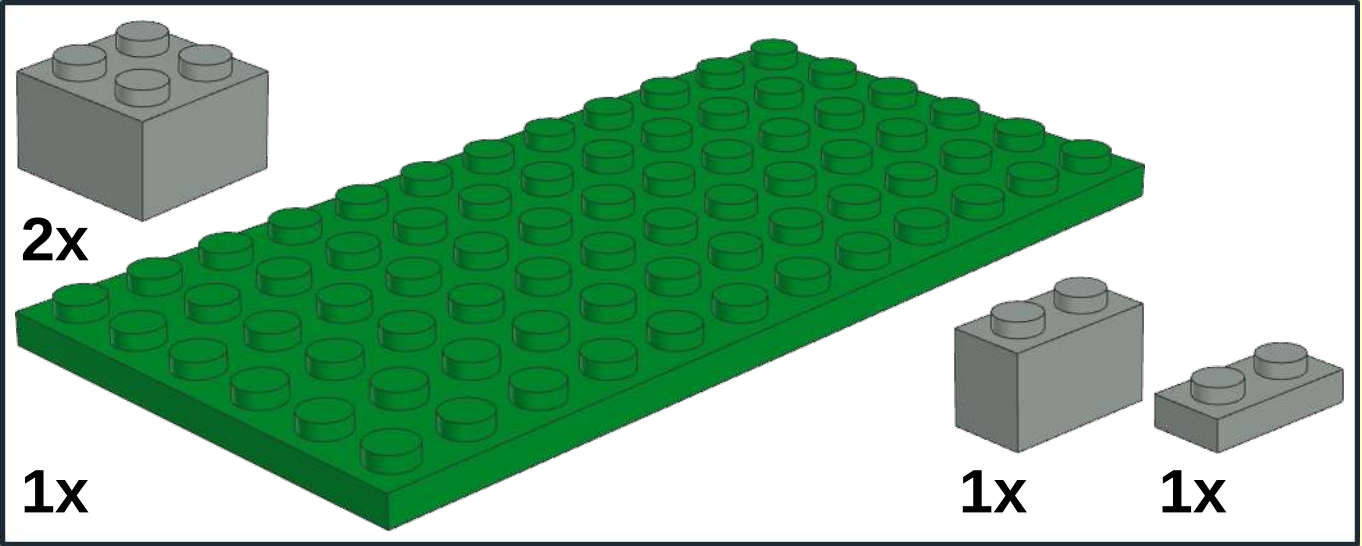
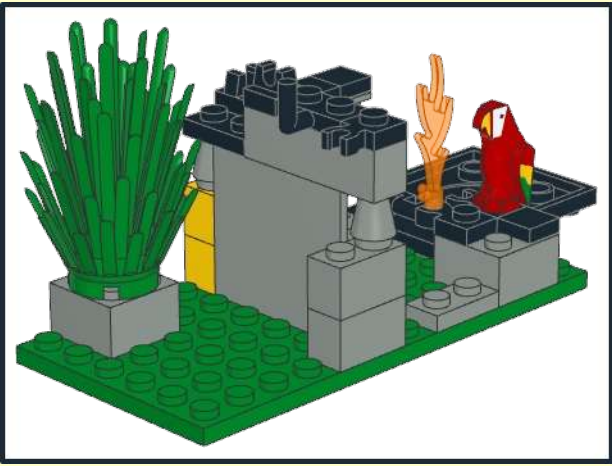

2

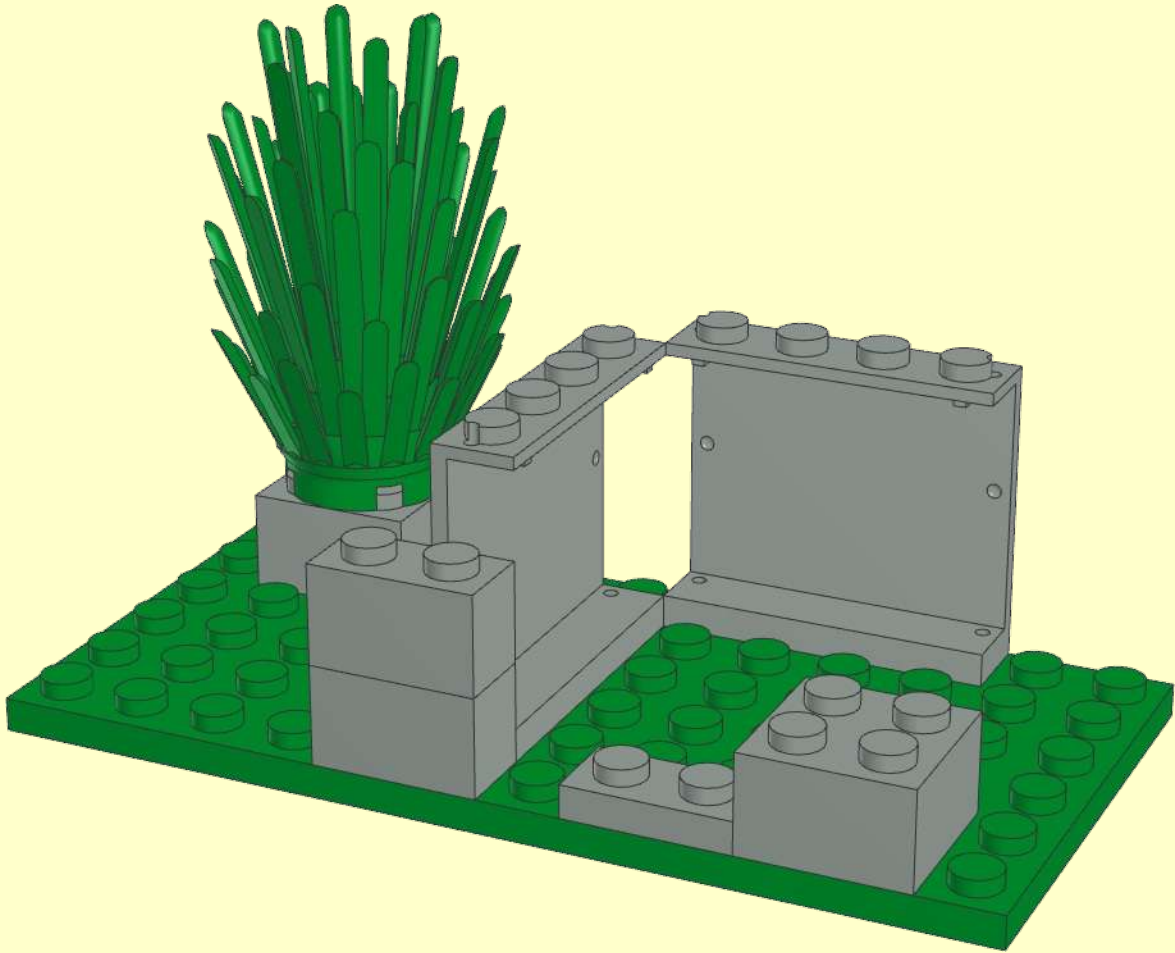
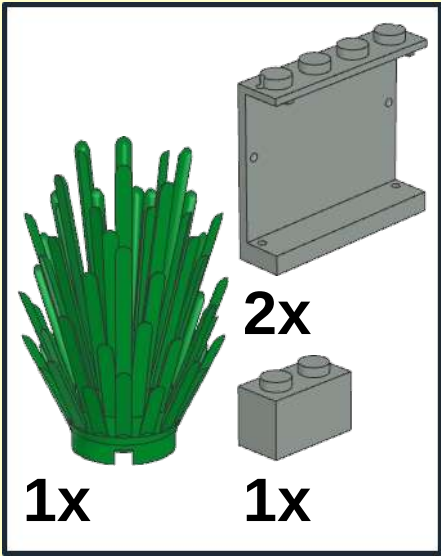

3

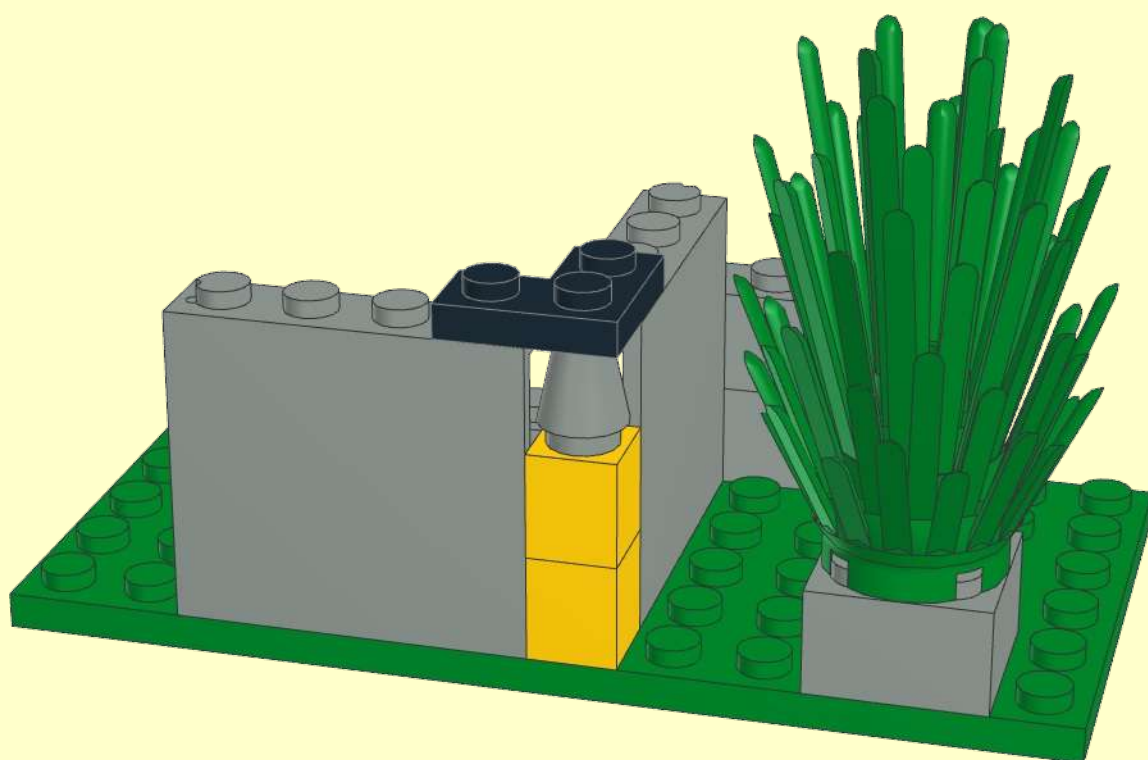
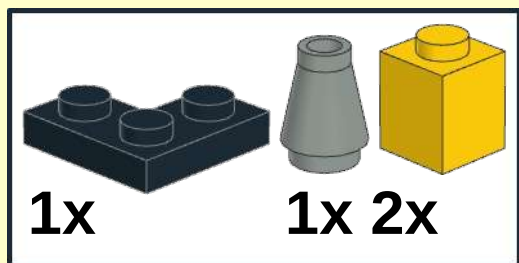

4

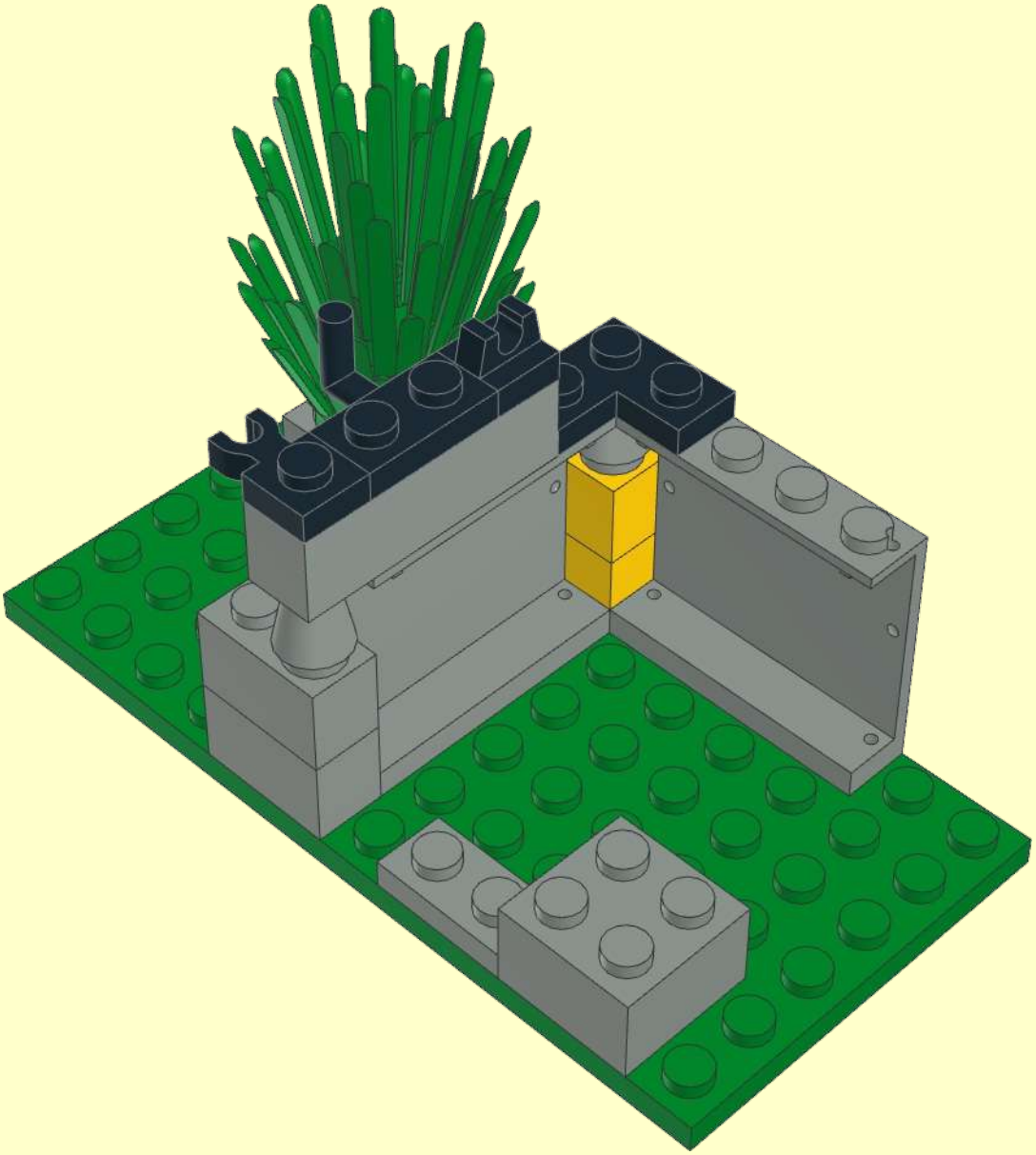
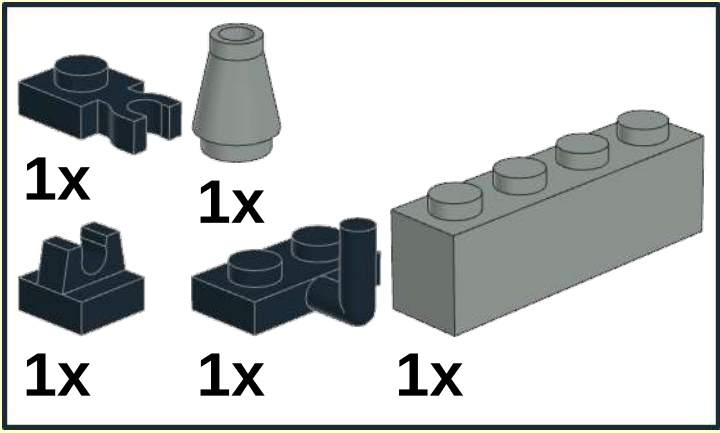

5

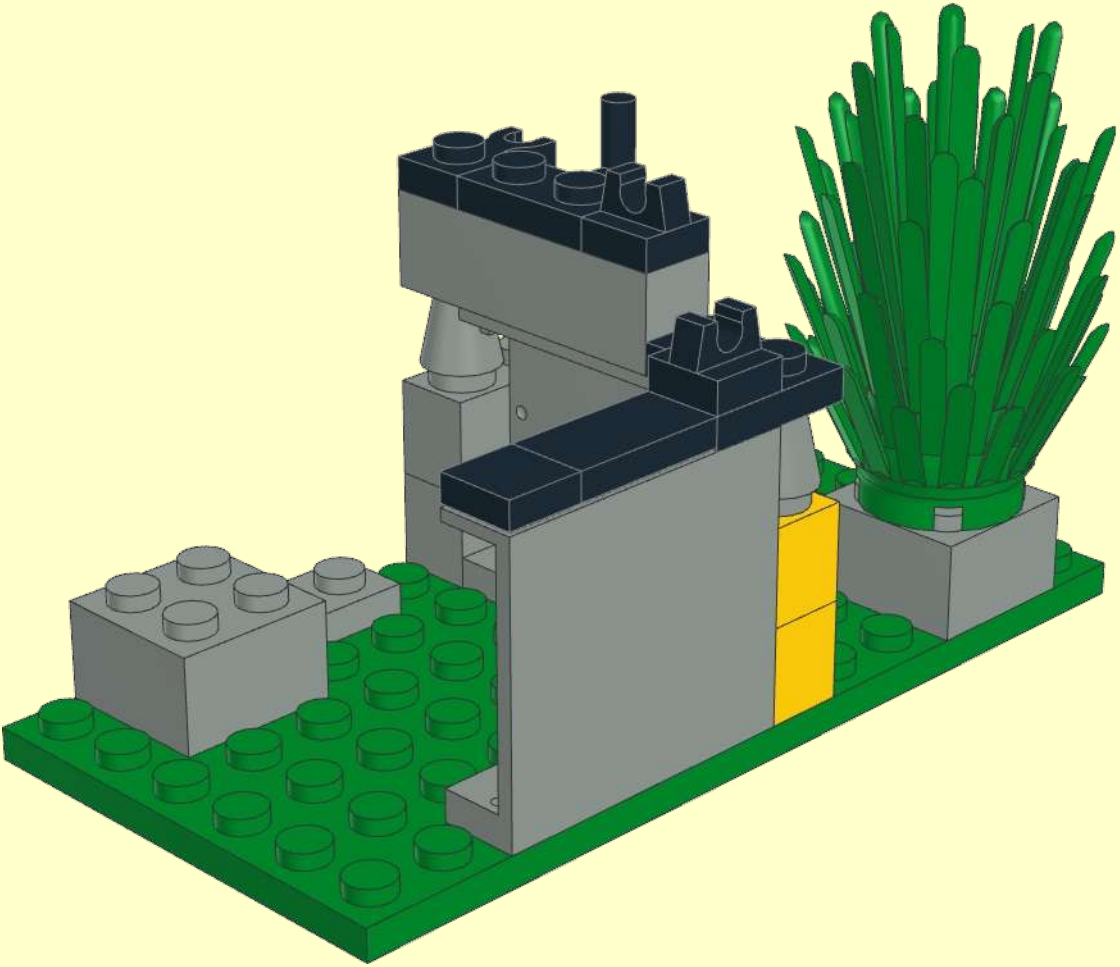
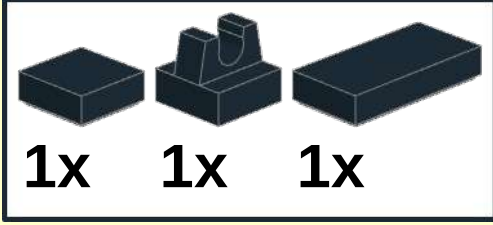

6

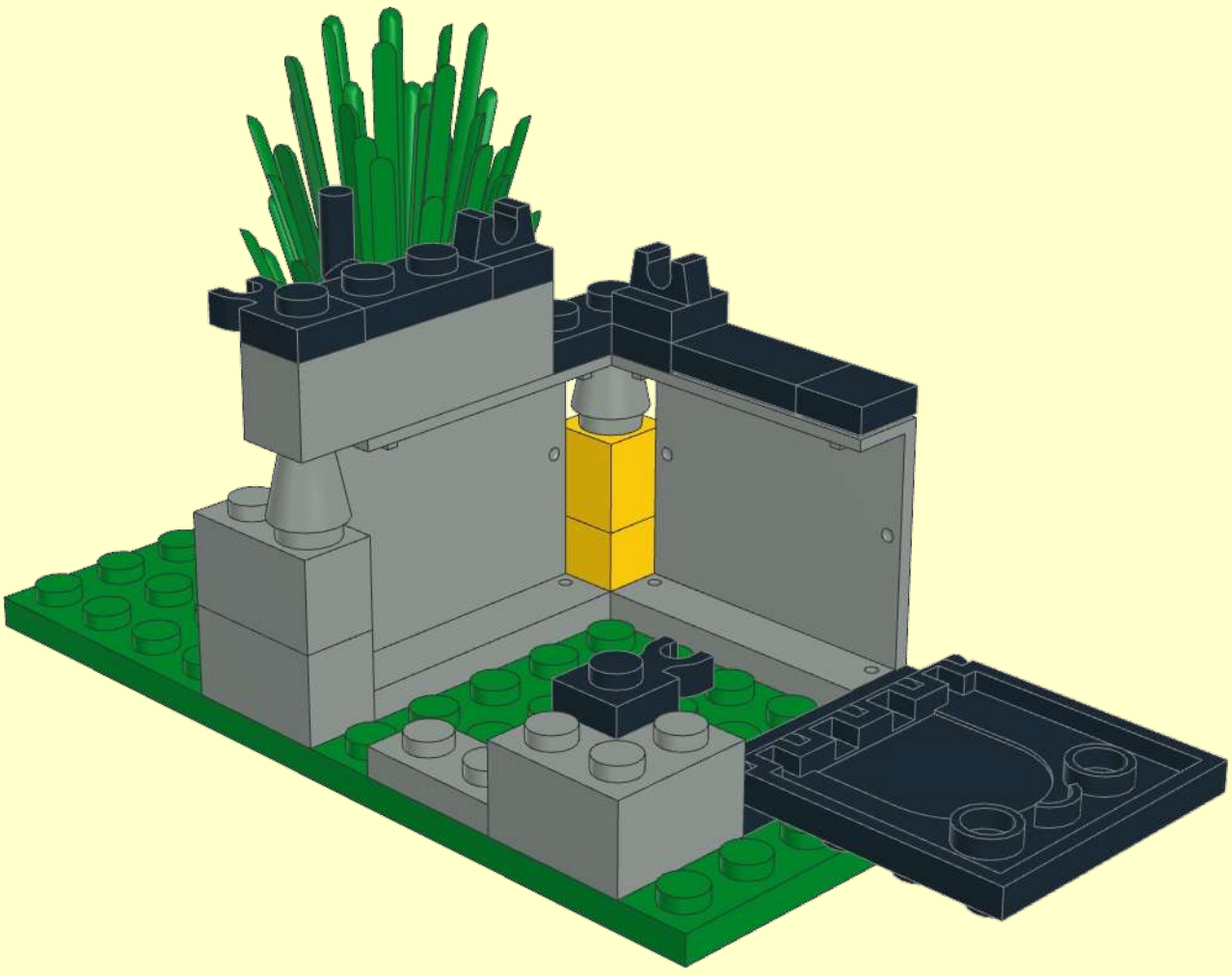
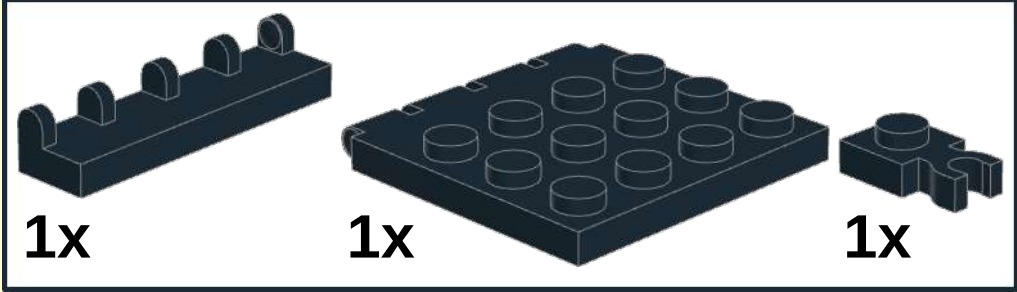

7

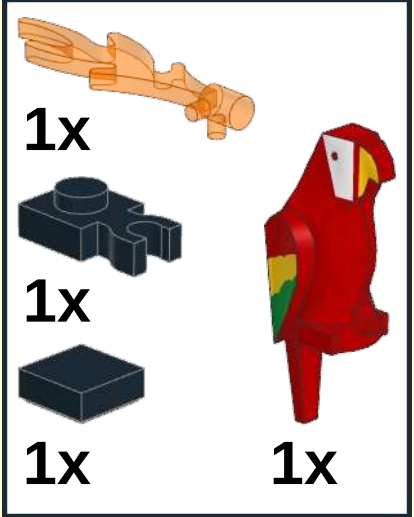

1x  
1x  
1x  
1x

1x

This block contains a list of parts for step 7. On the left, there are three items: an orange branching piece, a dark grey 1x3 Technic brick with a hole, and a dark grey 1x2 Technic plate. Each is labeled '1x'. On the right, there is a red parrot minifigure with yellow and green wings, also labeled '1x'.

