

1

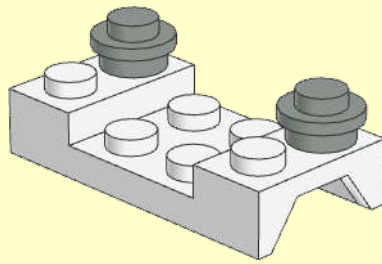

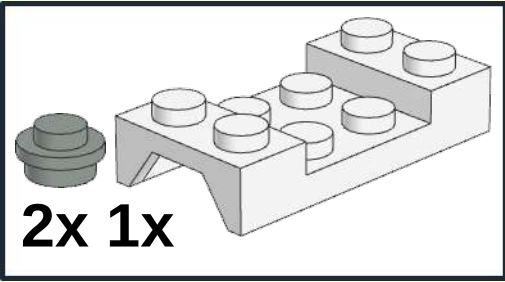

2

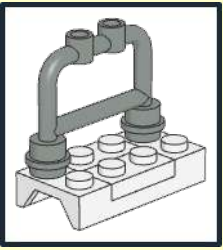
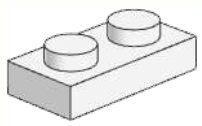

2x

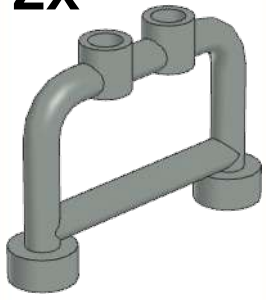

1x

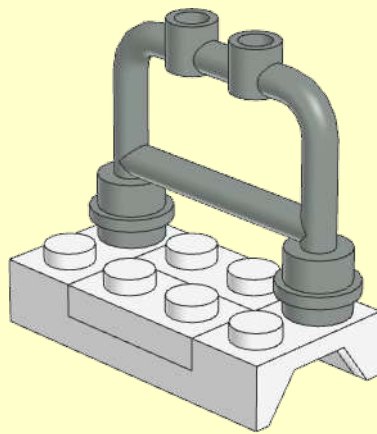

1

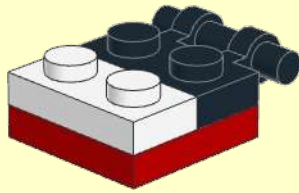
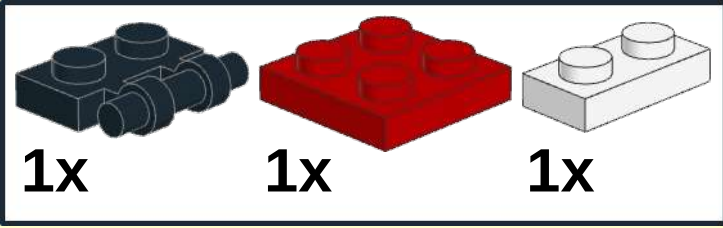
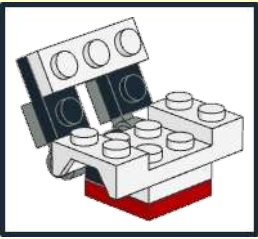

2

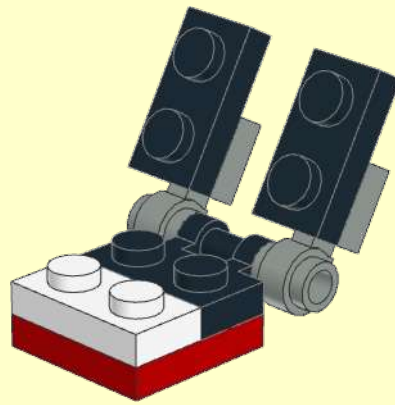
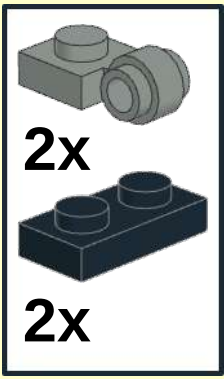



3

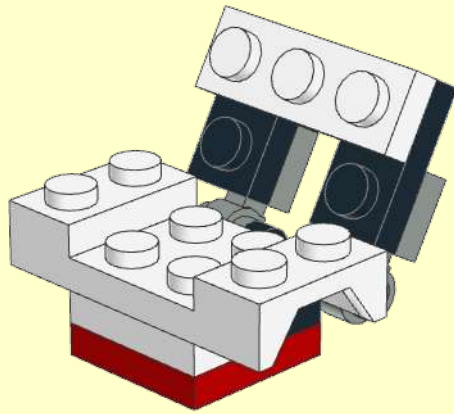
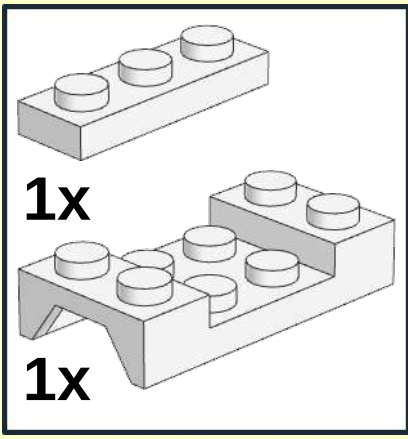

1

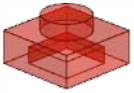
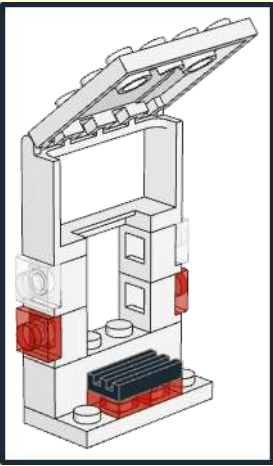

2x

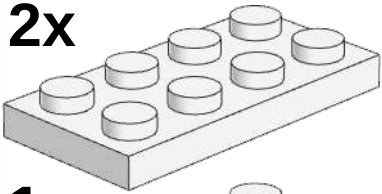

1x

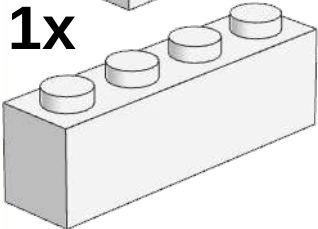

1x

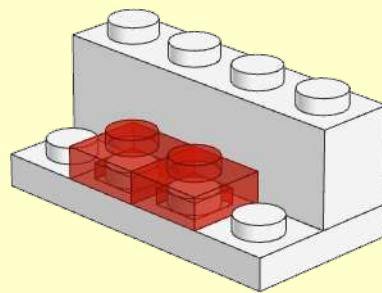

2

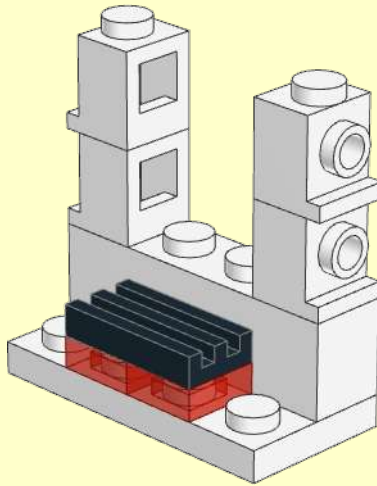
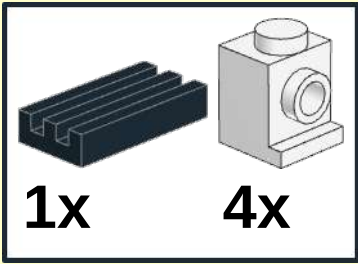

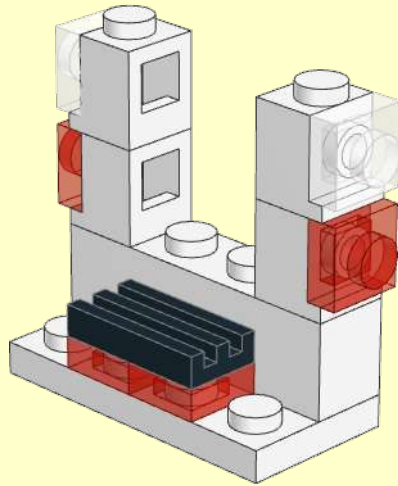
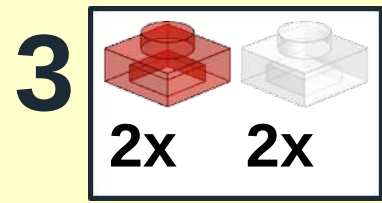

4

