

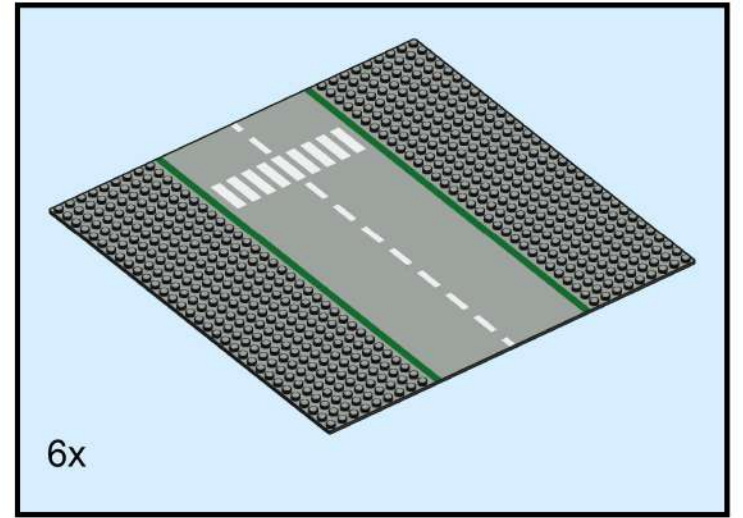

1

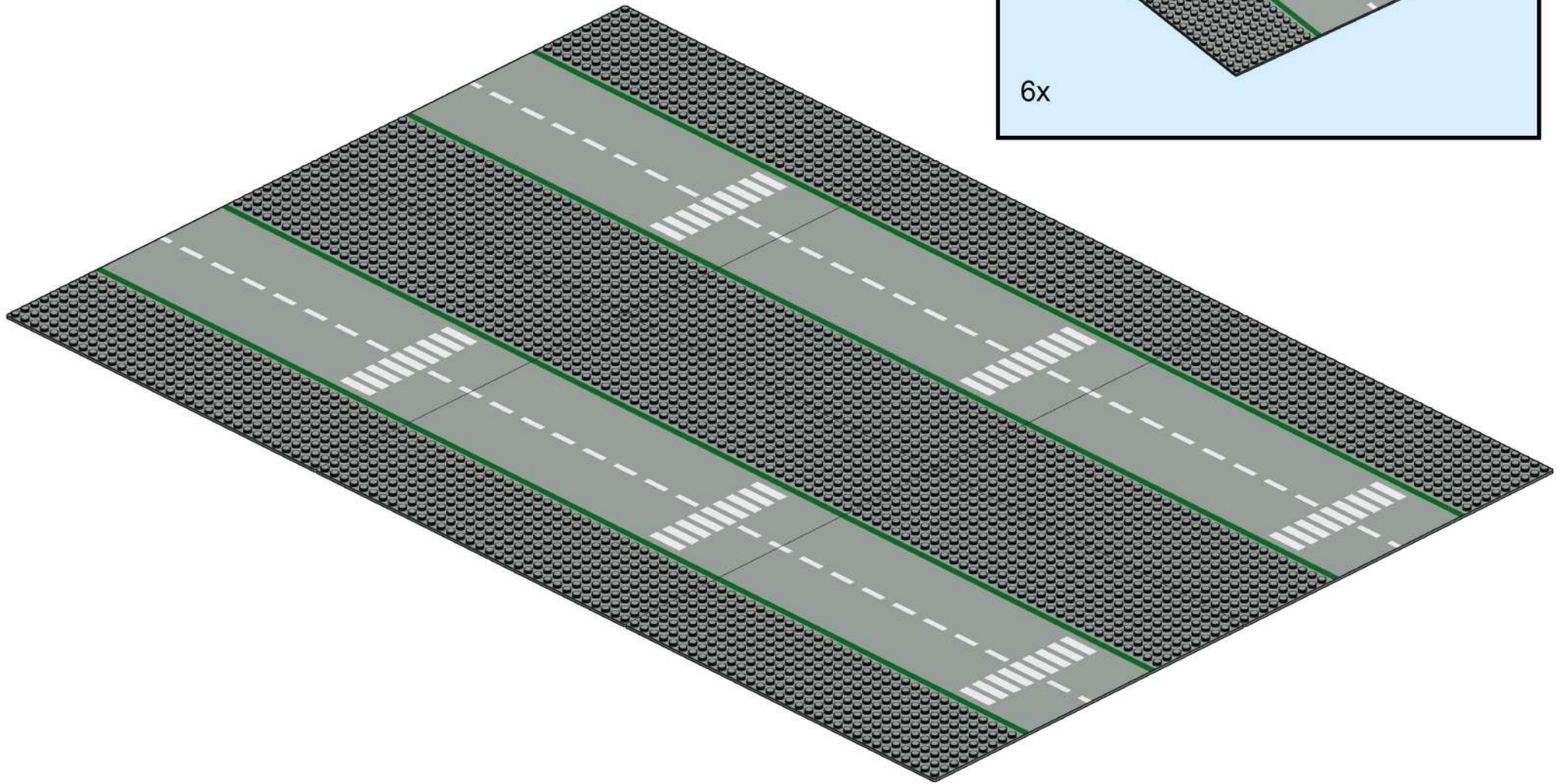

2

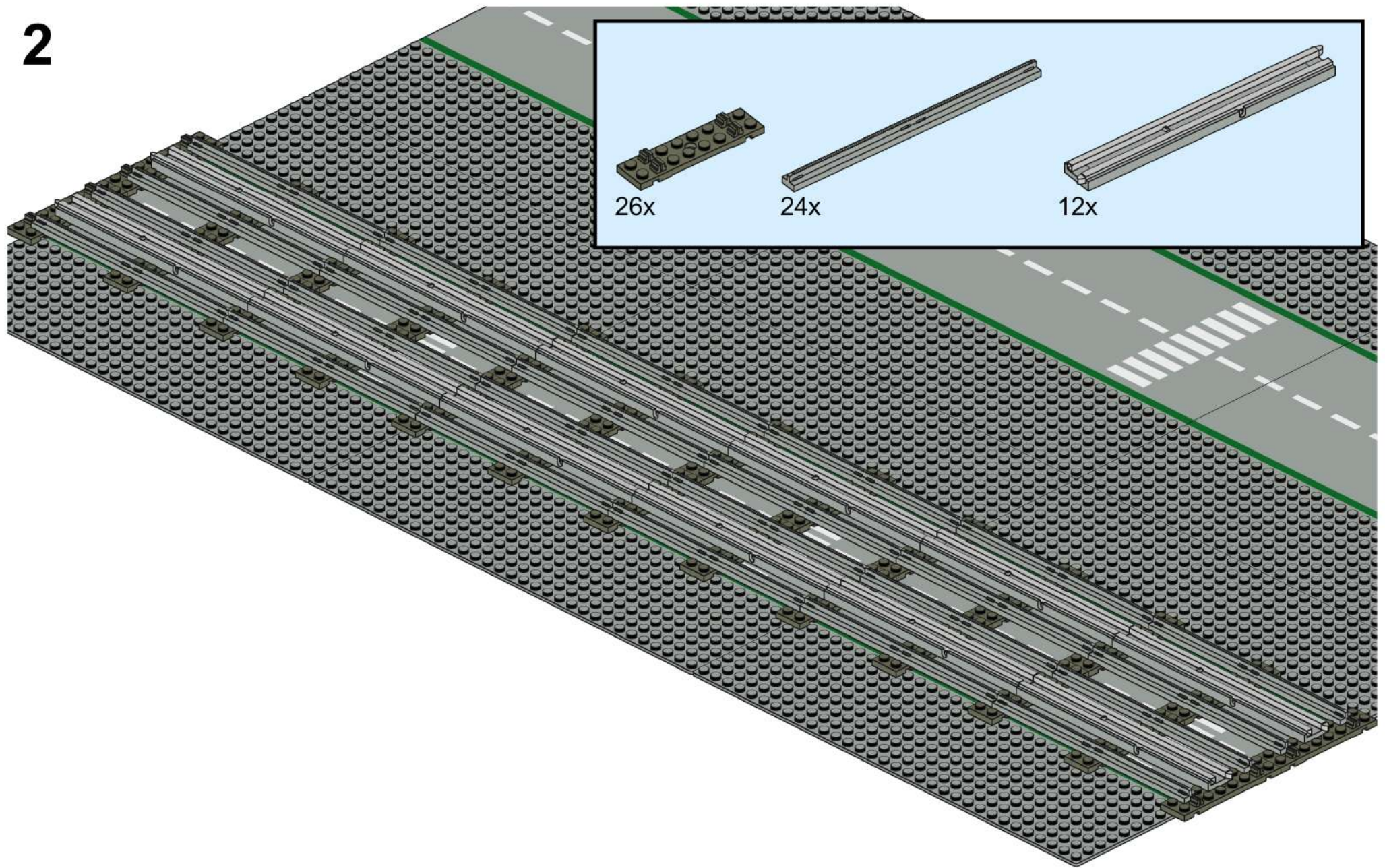

3

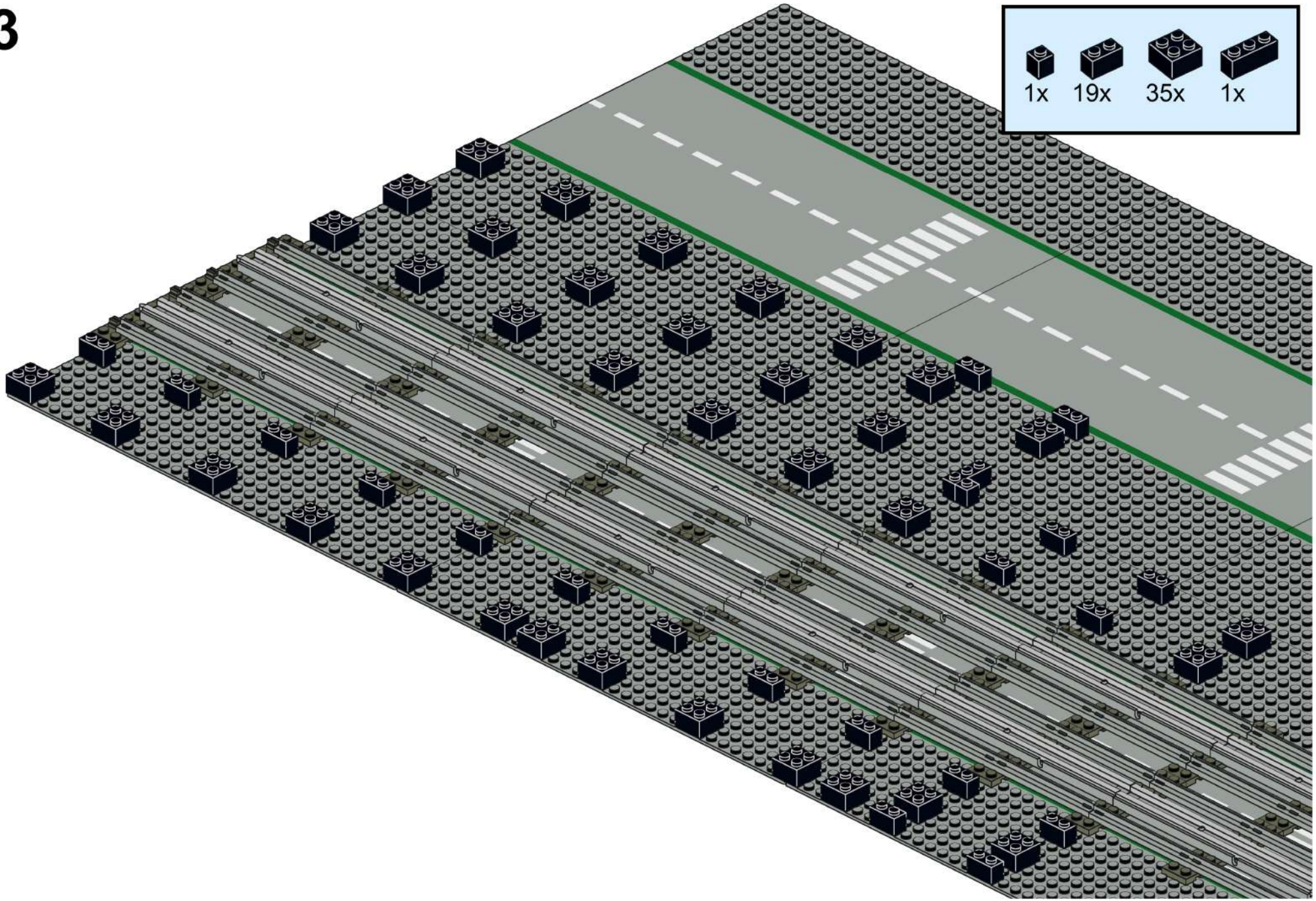

4

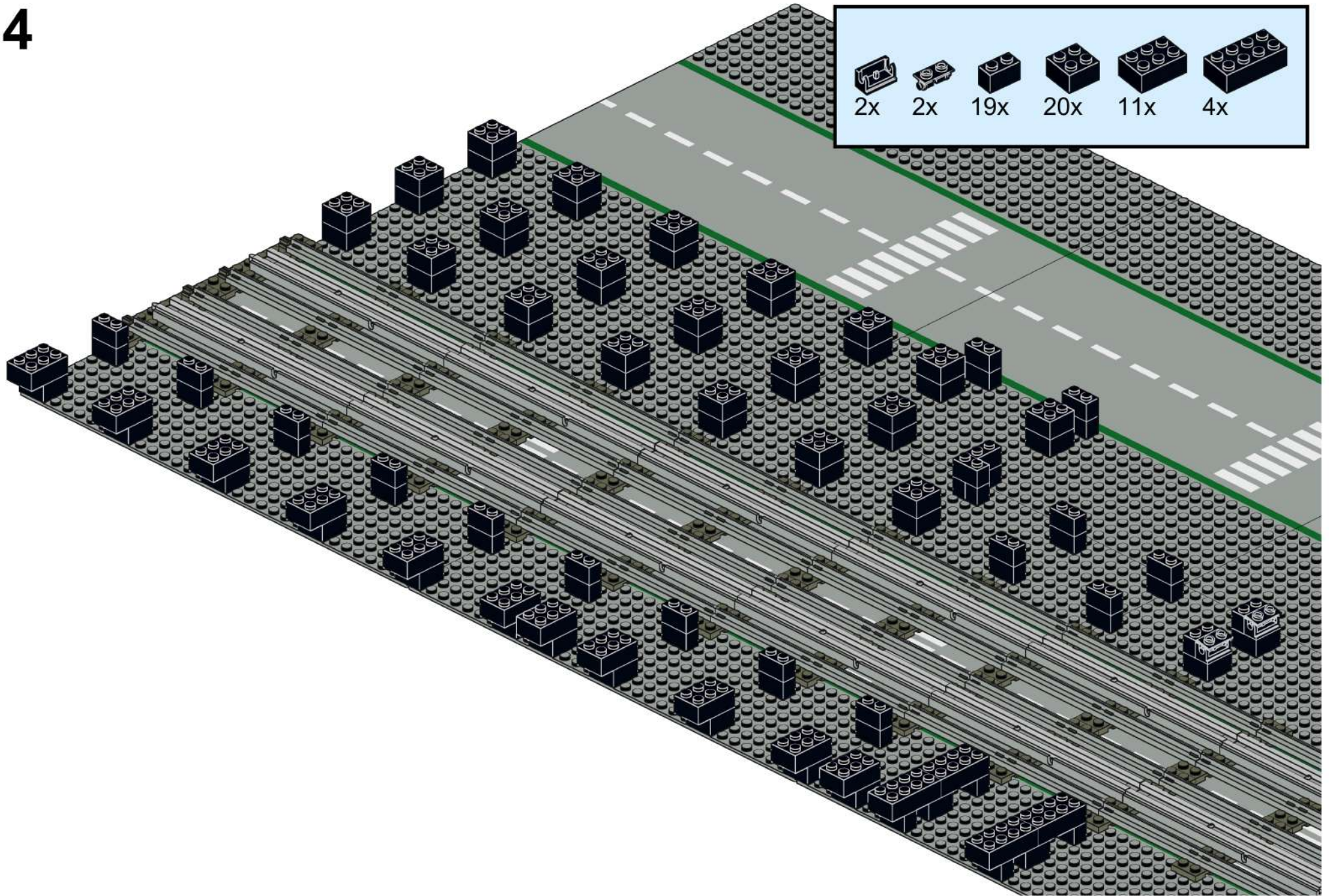

5

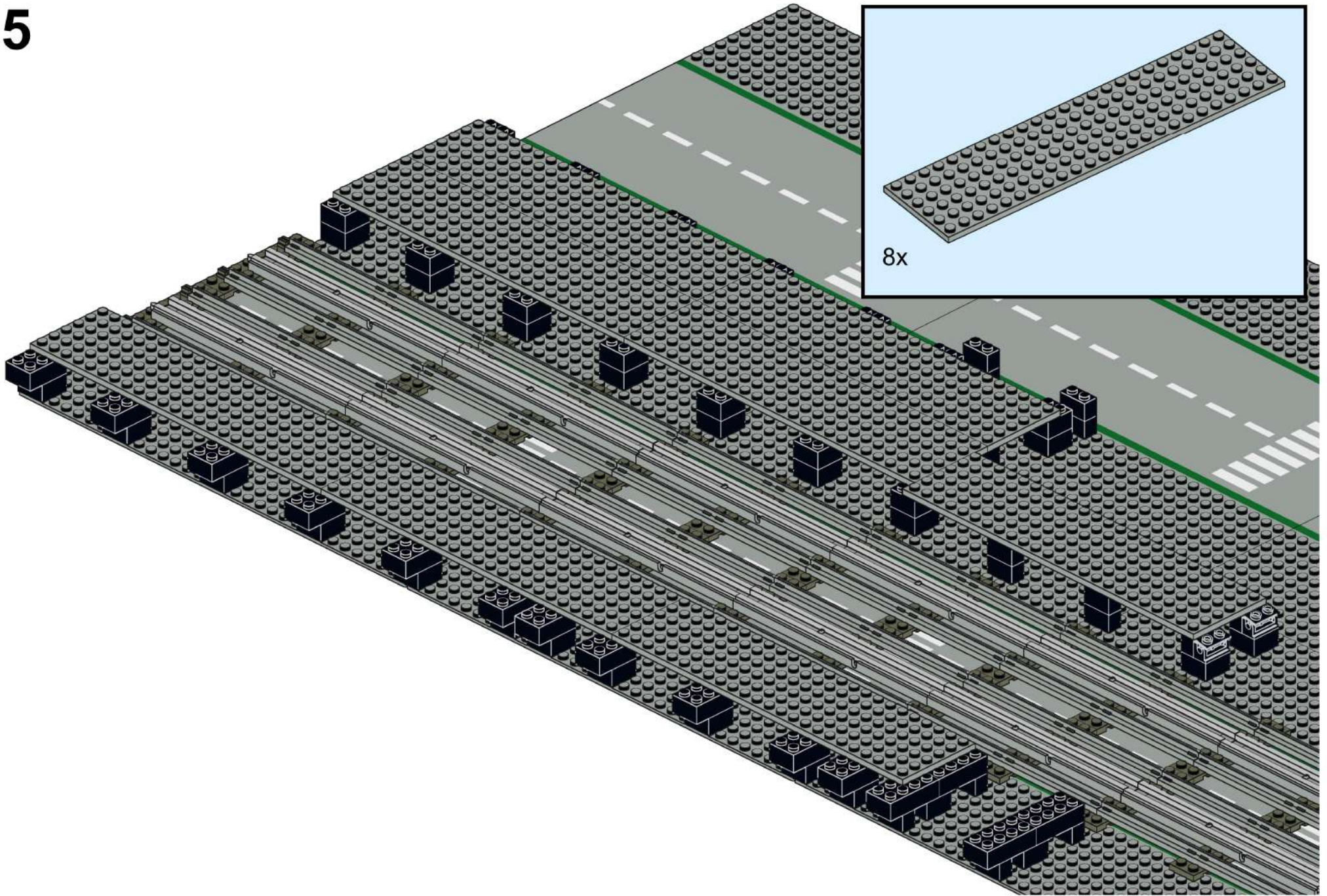

6

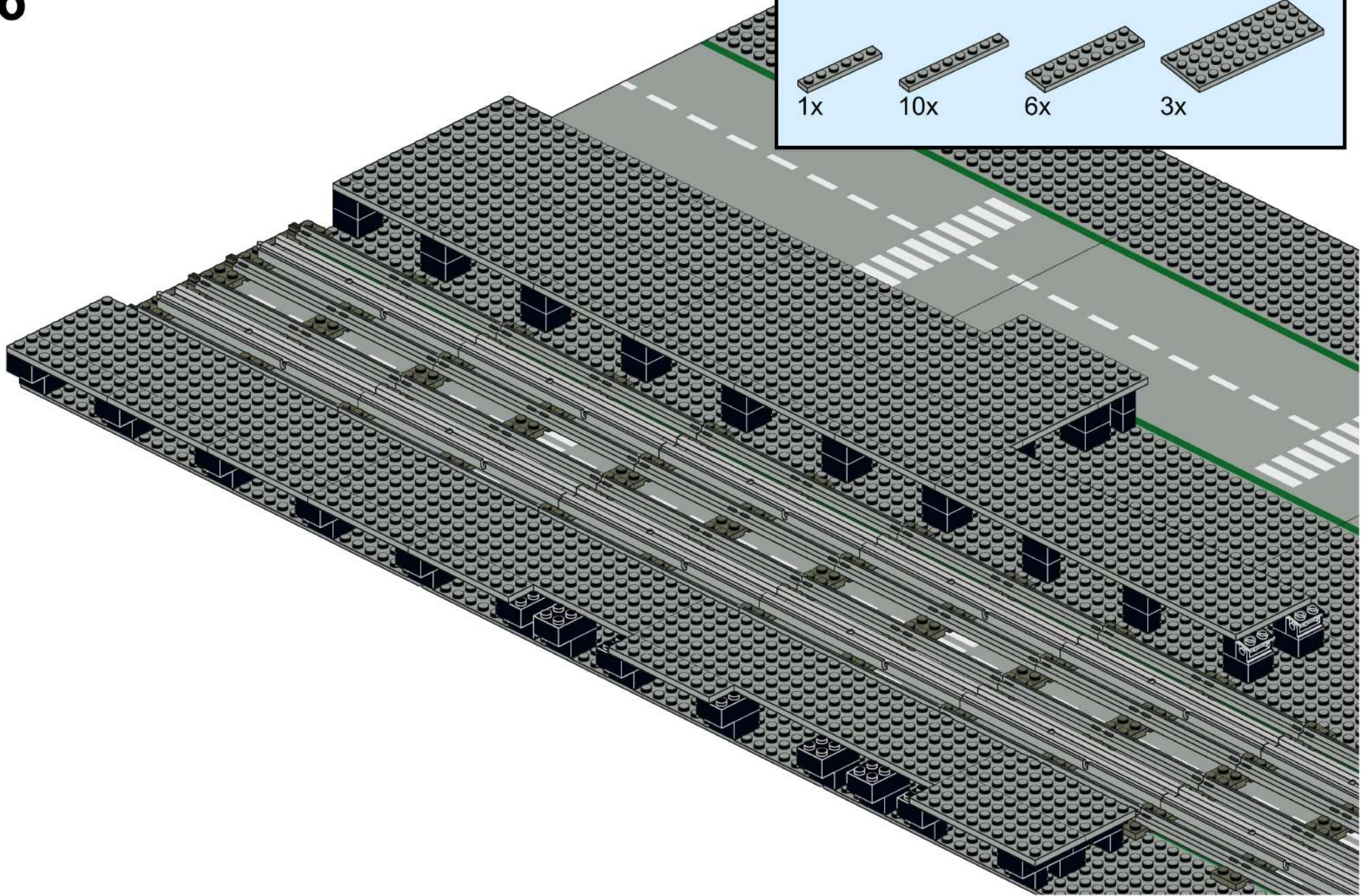
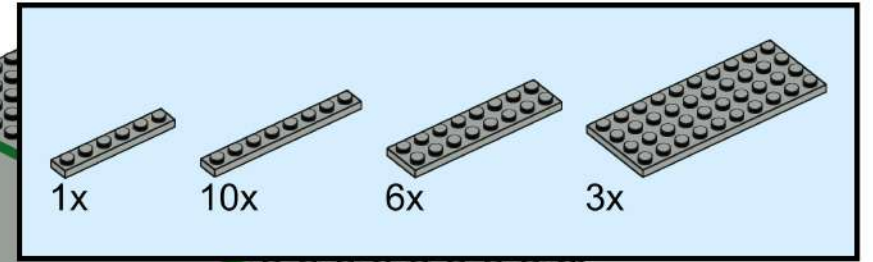

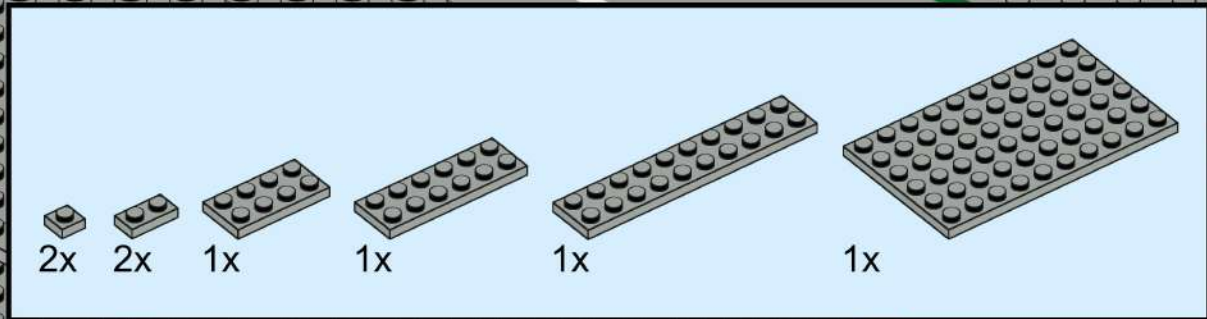

2x 2x 1x 1x 1x 1x

This inset box displays the parts list for step 7. It includes: a 1x1 dark grey Technic pin (2x), a 1x2 dark grey Technic pin (2x), a 1x3 dark grey Technic pin (1x), a 1x4 dark grey Technic pin (1x), a 1x6 dark grey Technic pin (1x), and a 1x6 dark grey Technic plate (1x).

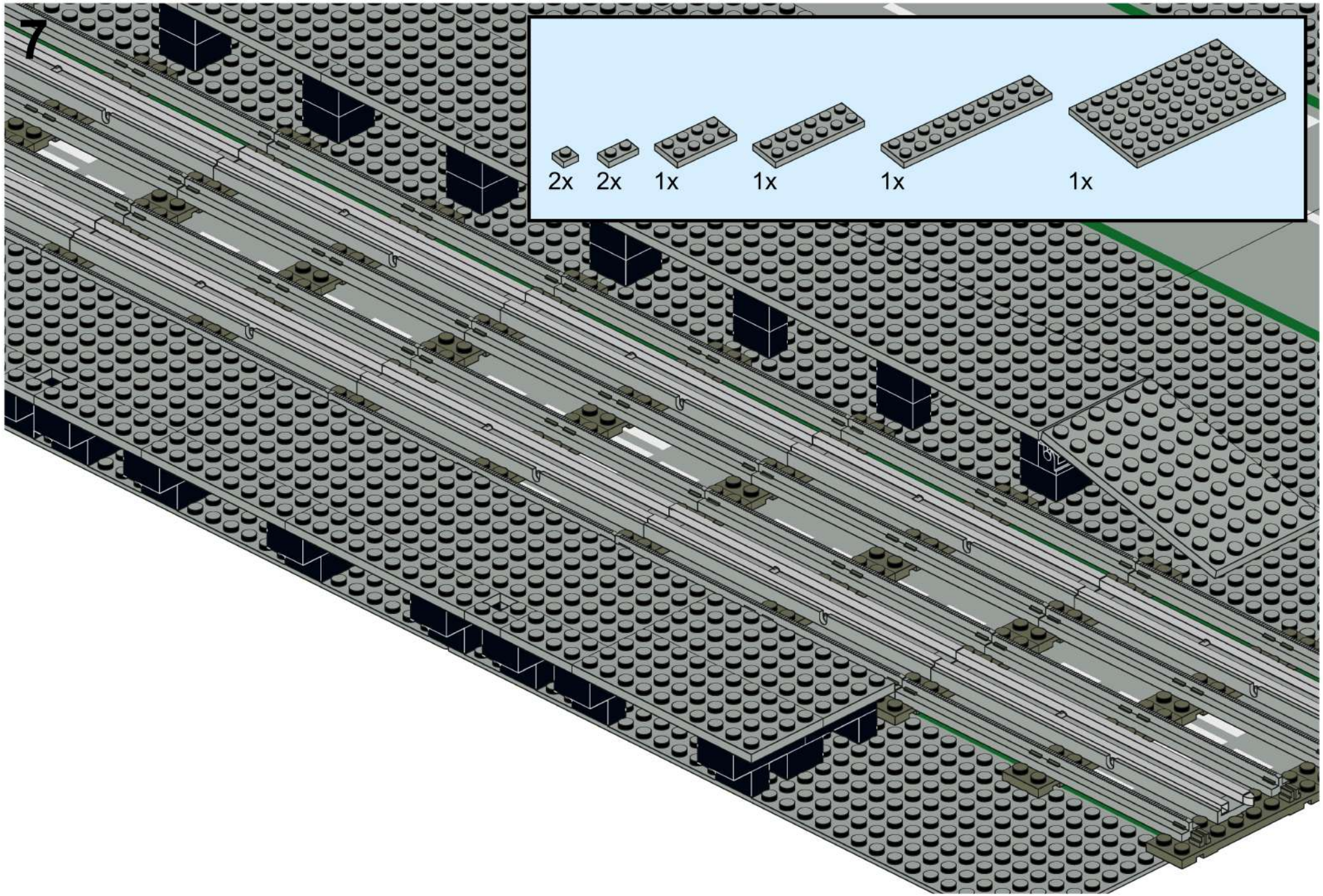

8

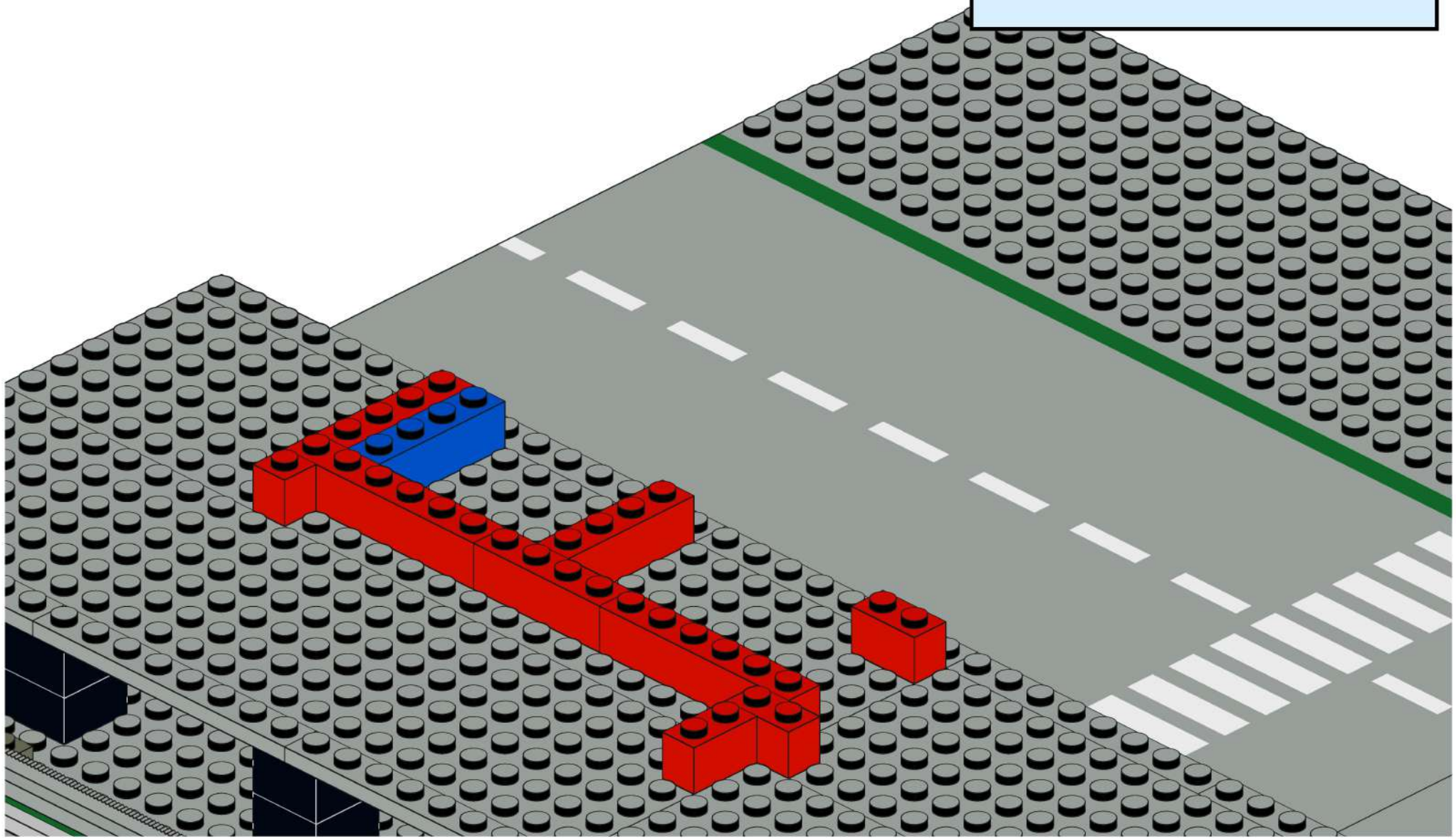
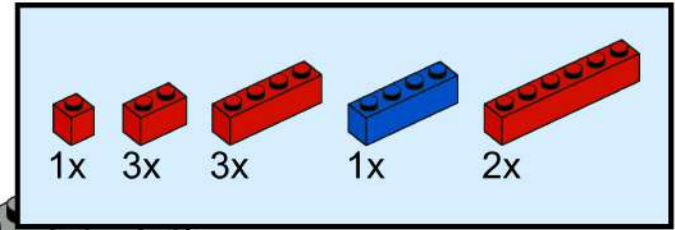

9

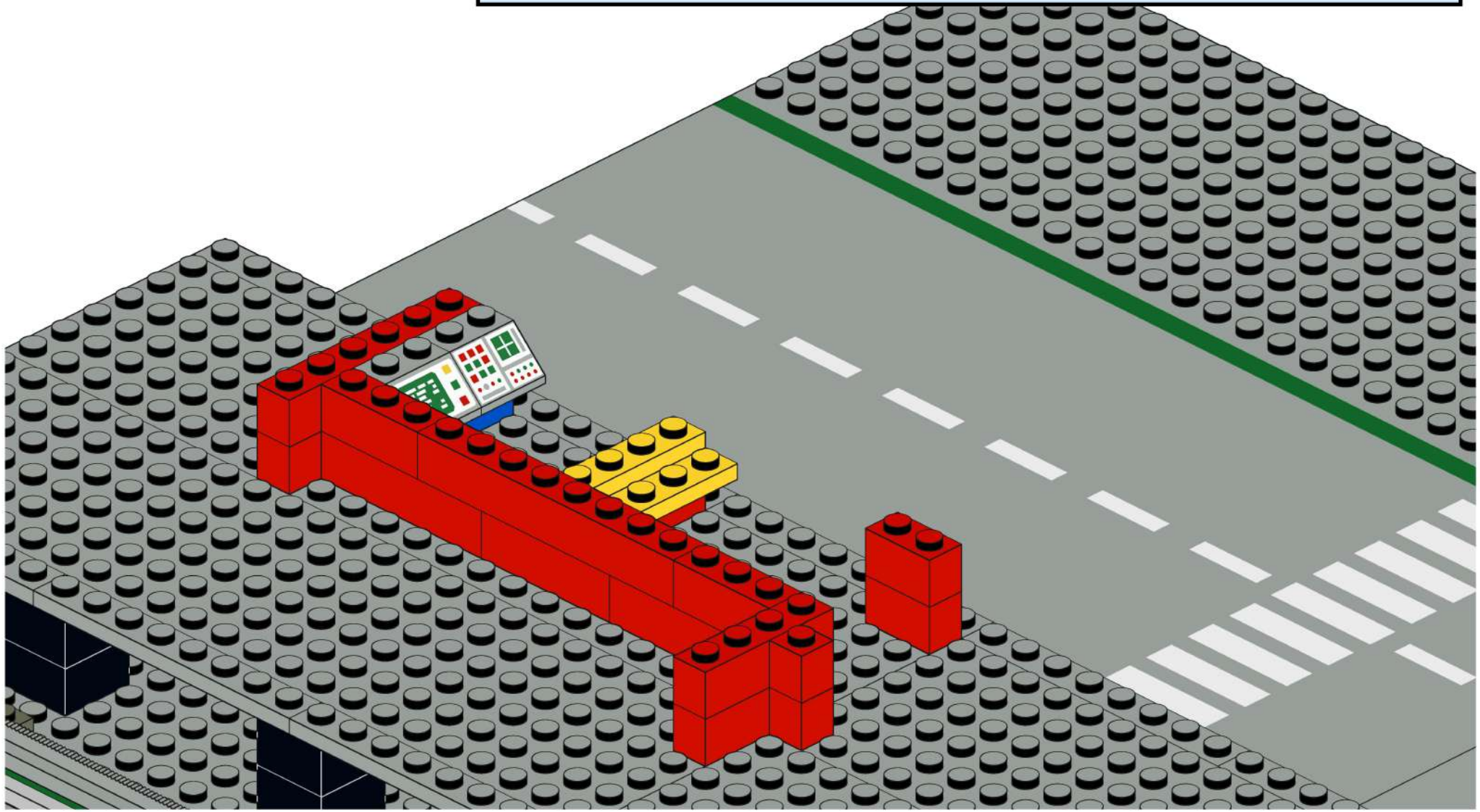
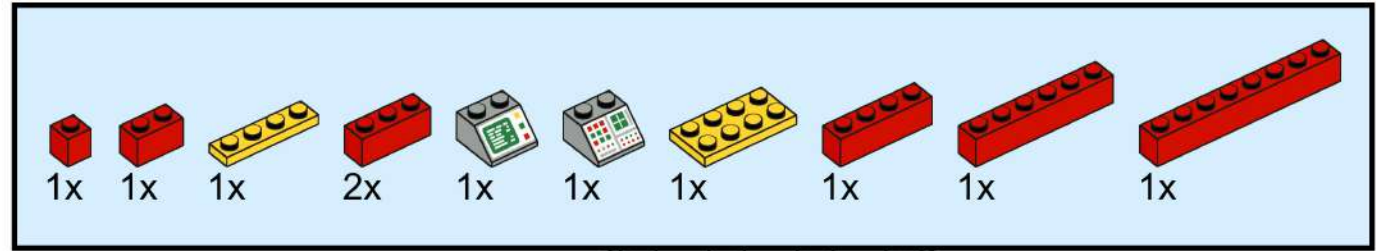

10

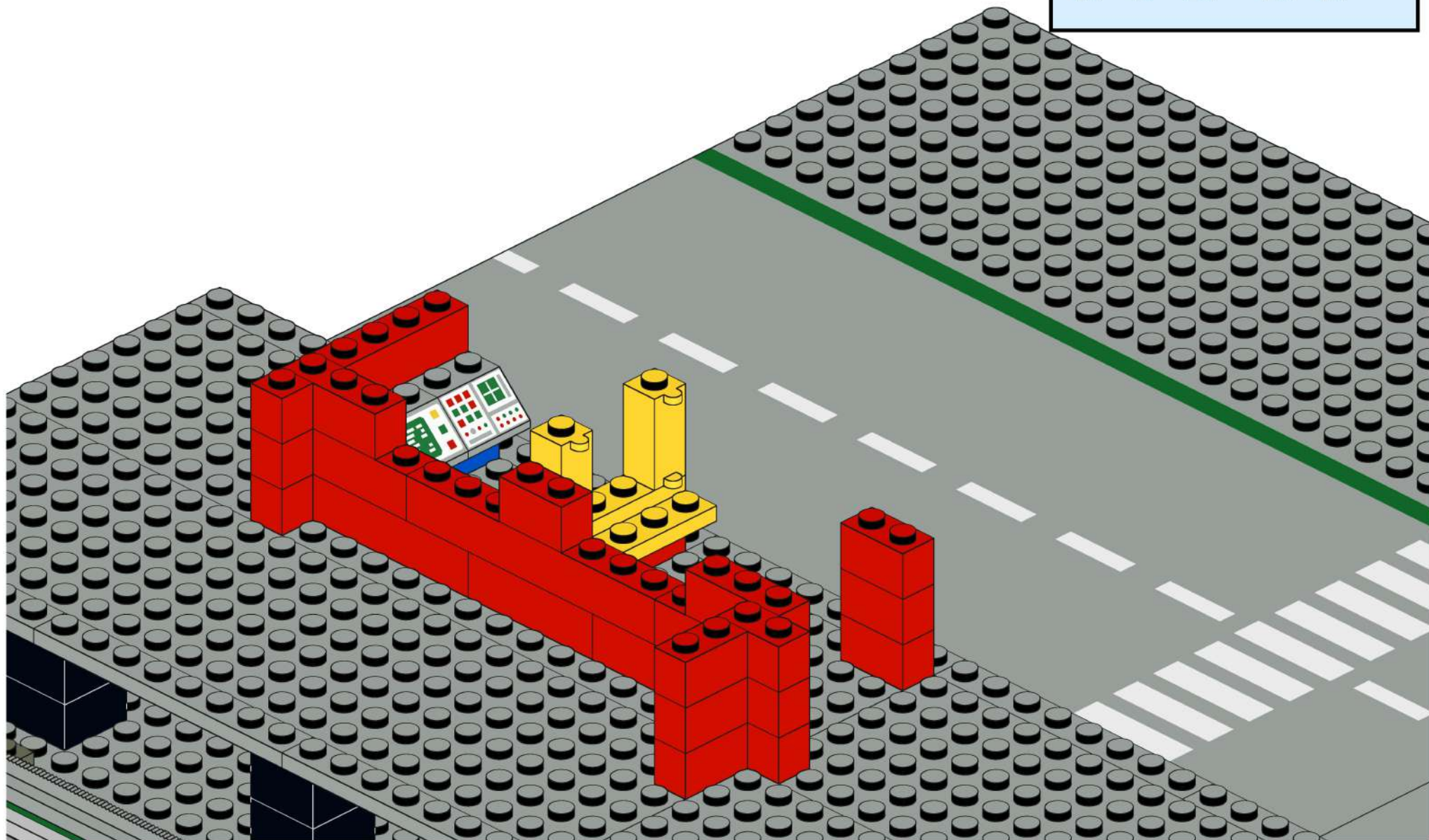
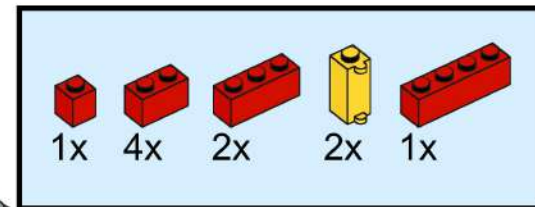

11

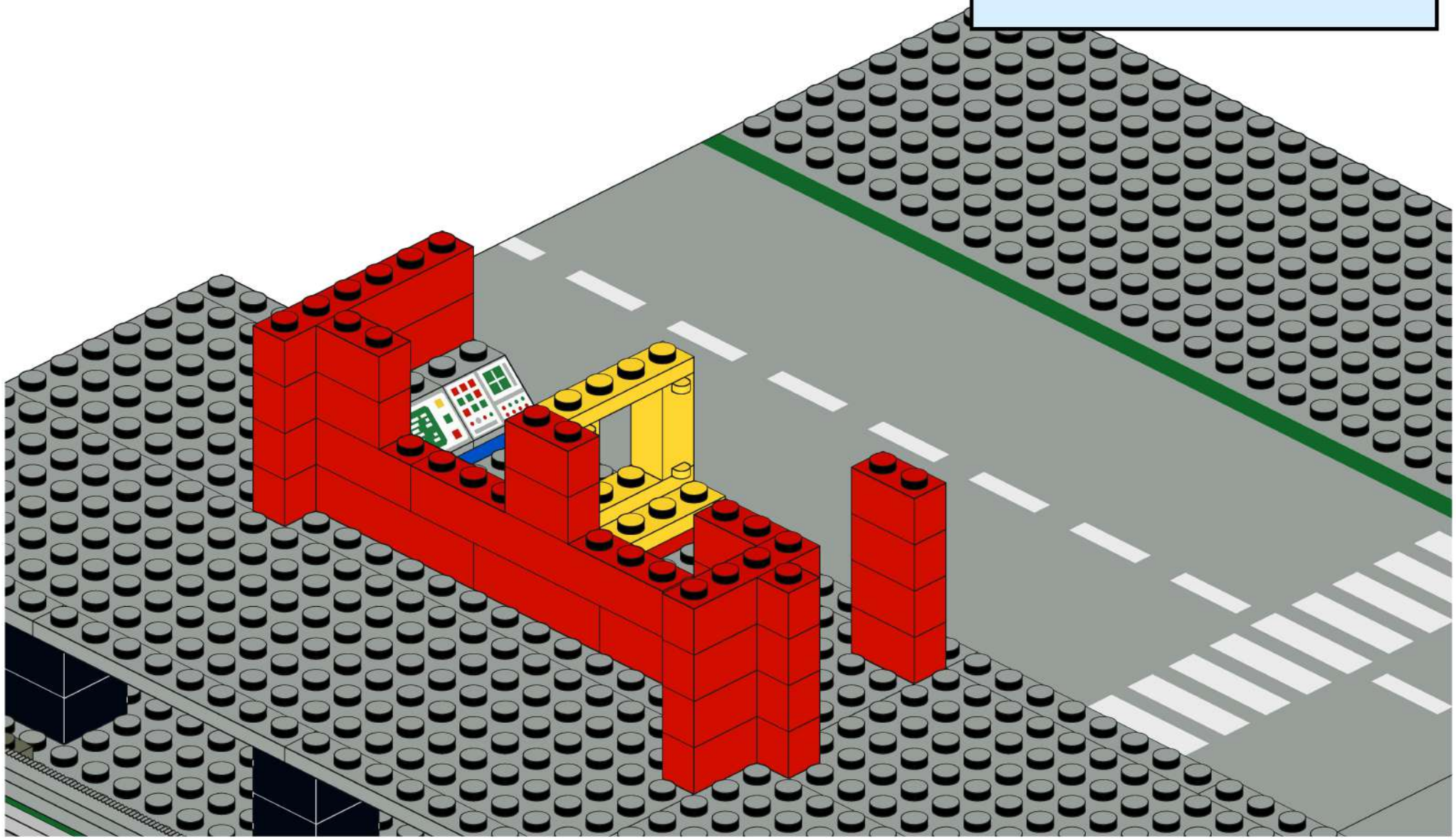
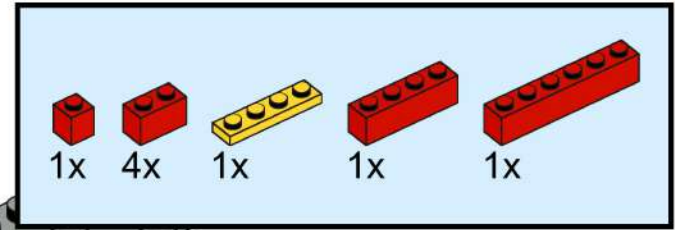

12

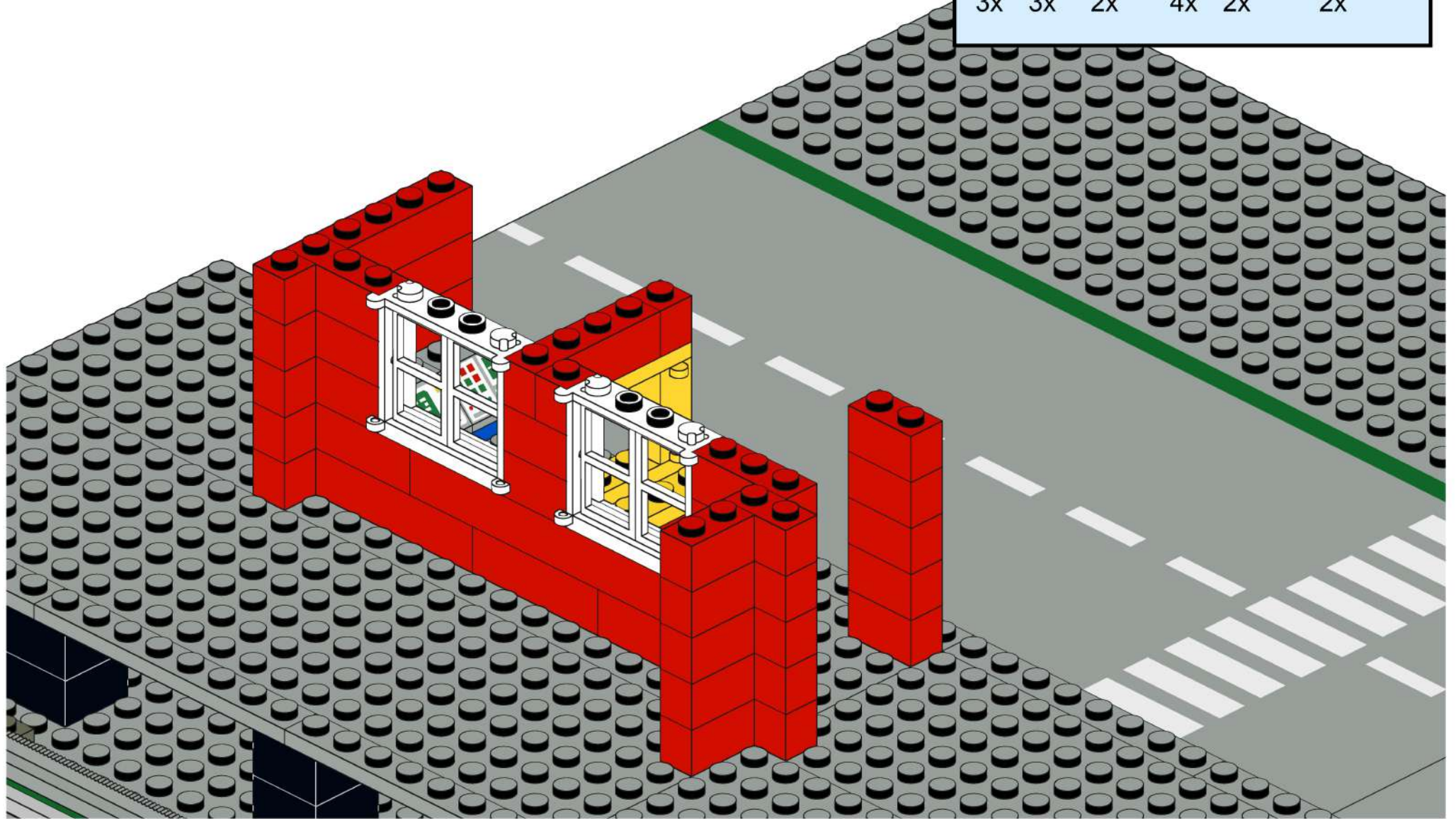
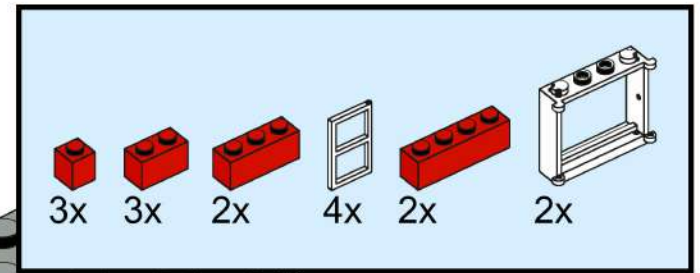

13

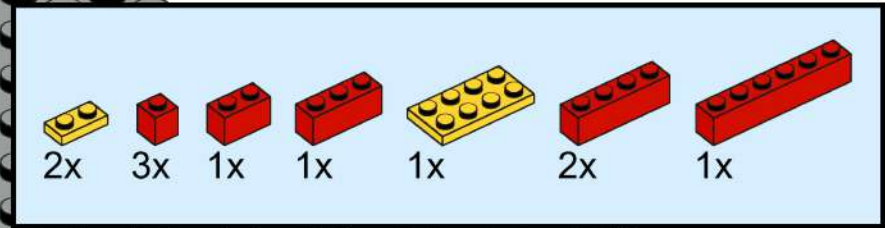

2x 3x 1x 1x 1x 2x 1x

This block contains a parts list for step 13. It features seven items with their respective quantities: two yellow 1x2 Technic bricks, three red 1x1 Technic bricks, one red 1x2 Technic brick, one red 1x3 Technic brick, one yellow 1x4 Technic brick with four studs, two red 1x4 Technic bricks, and one red 1x6 Technic brick.

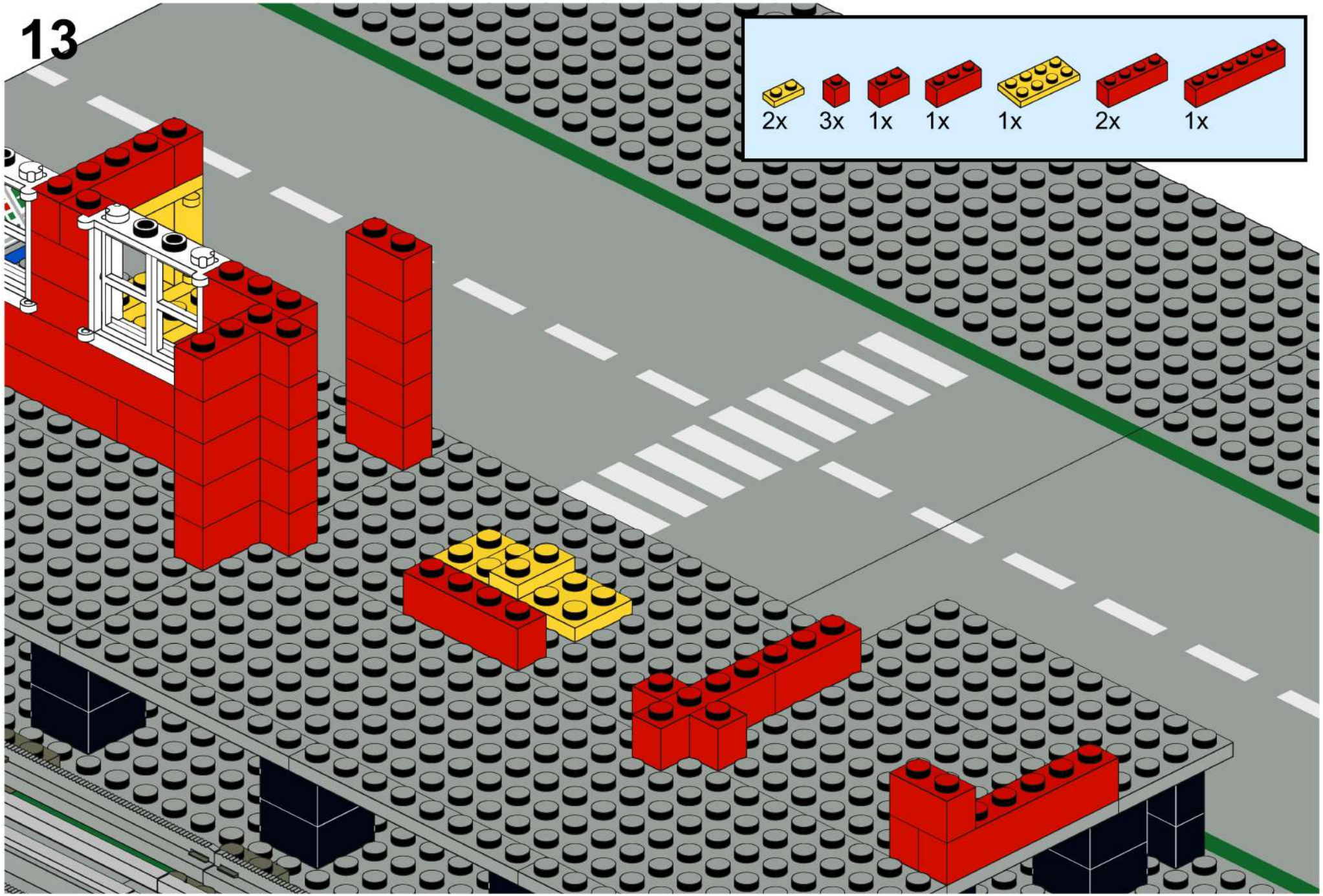

14

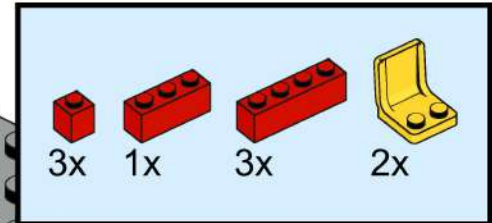

3x 1x 3x 2x

This inset box lists the required parts for step 14: three 1x1 red Technic bricks, one 1x3 red Technic brick, three 1x5 red Technic bricks, and two yellow Technic clips.

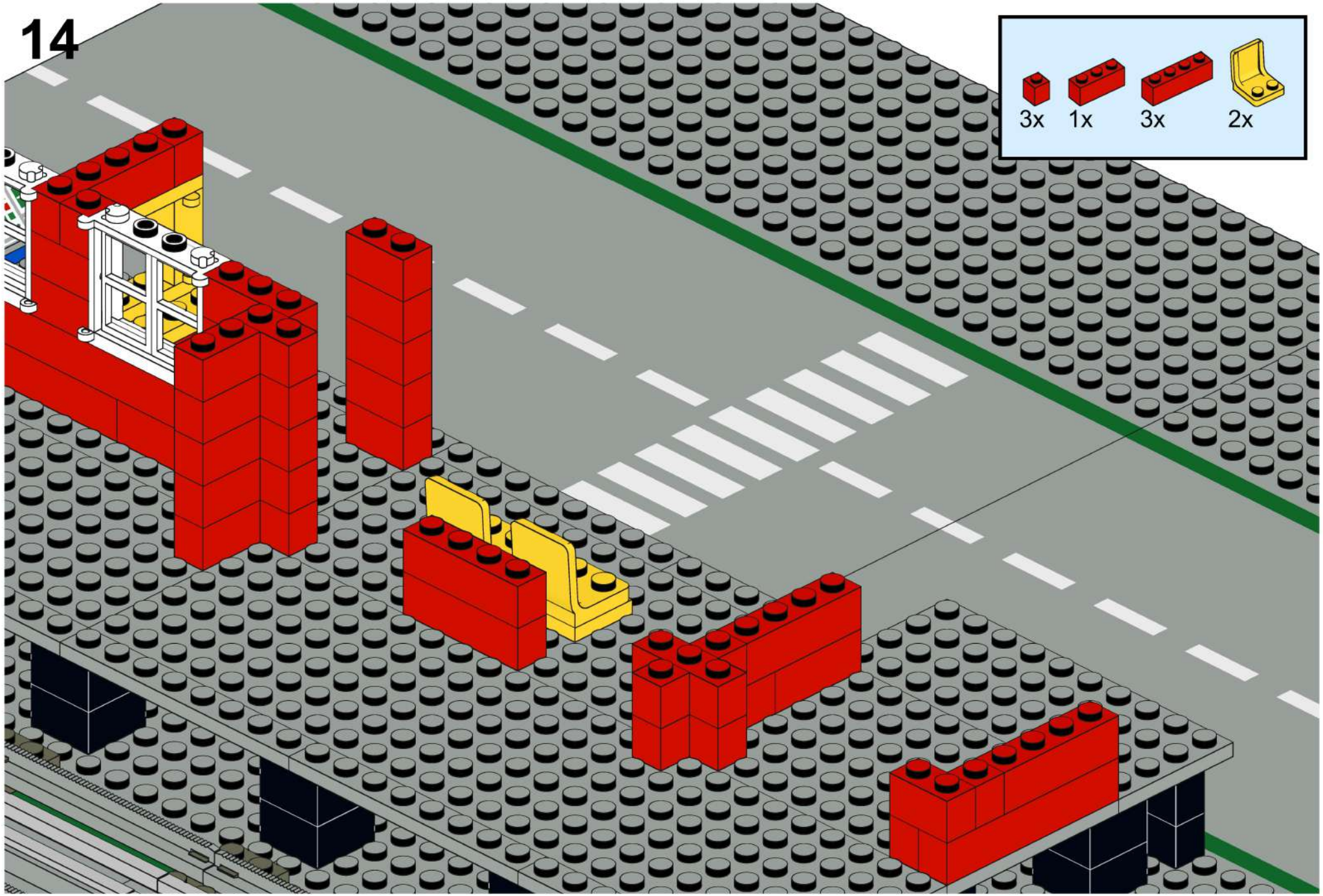

15

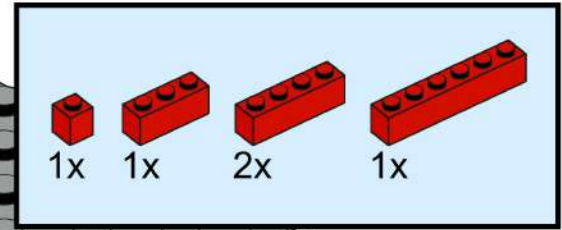

1x 1x 2x 1x

This inset box lists the required parts for step 15: one 1x1 red brick, one 1x2 red brick, two 1x3 red bricks, and one 1x4 red brick.

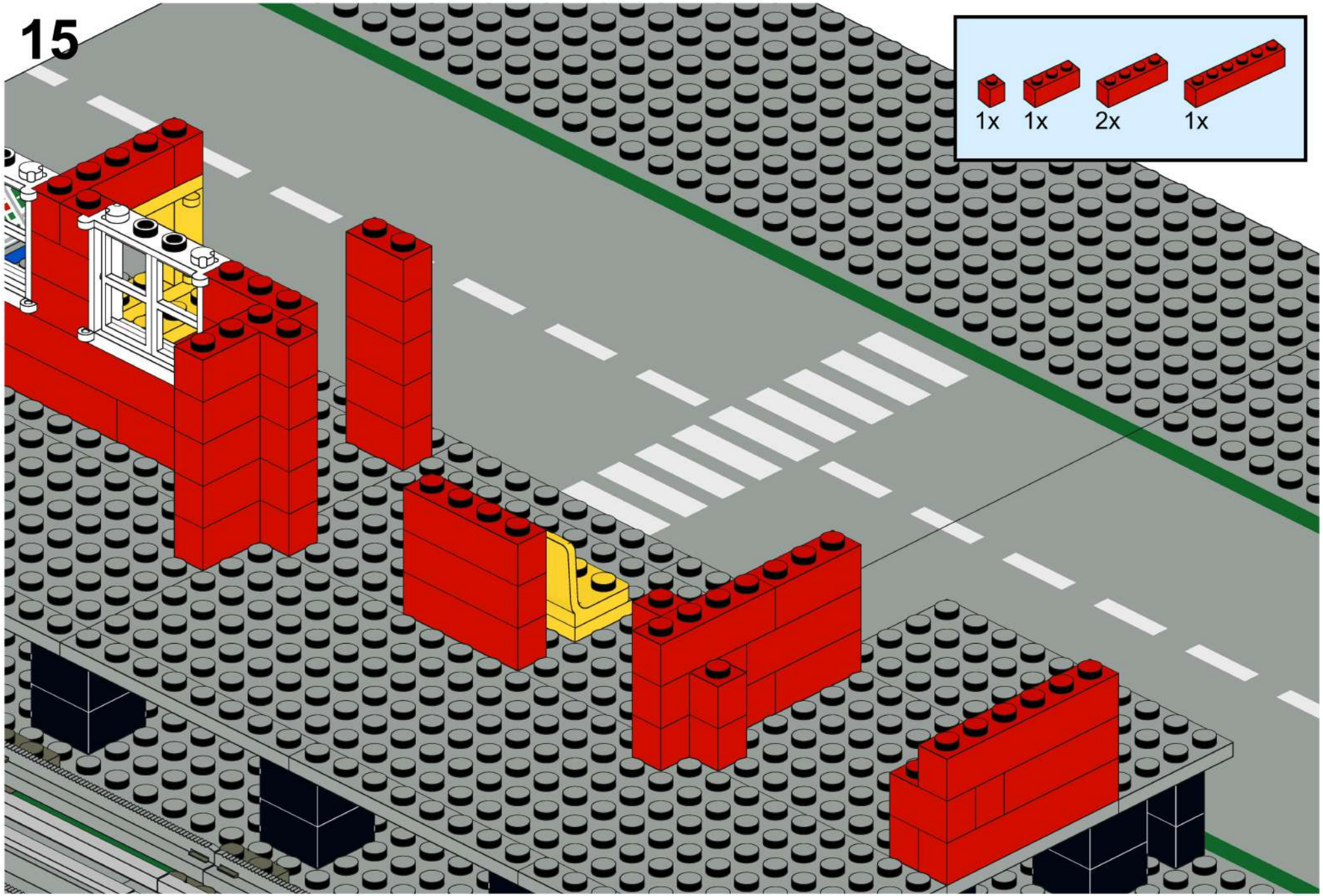

16

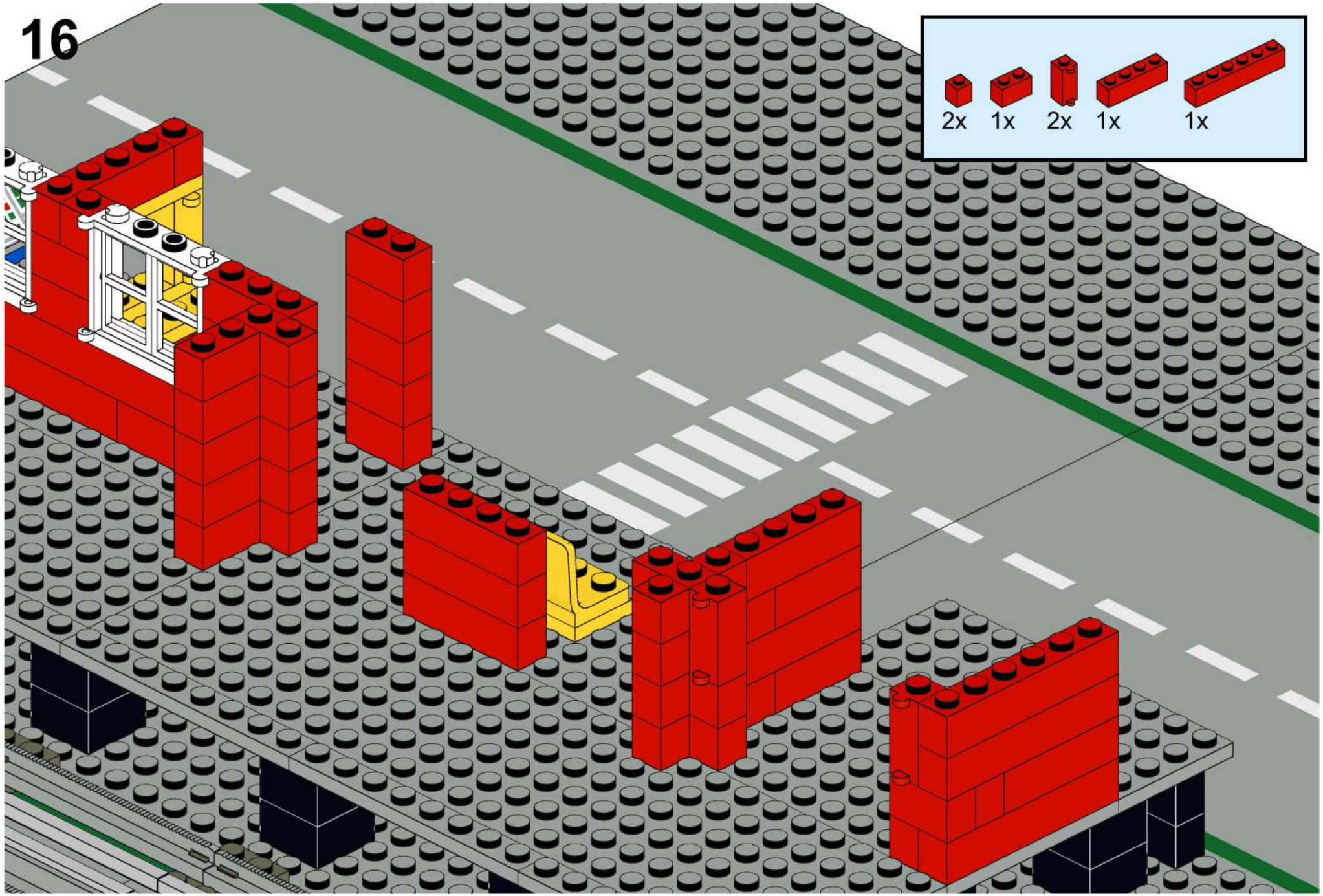
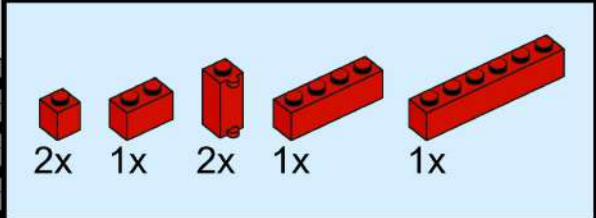

17

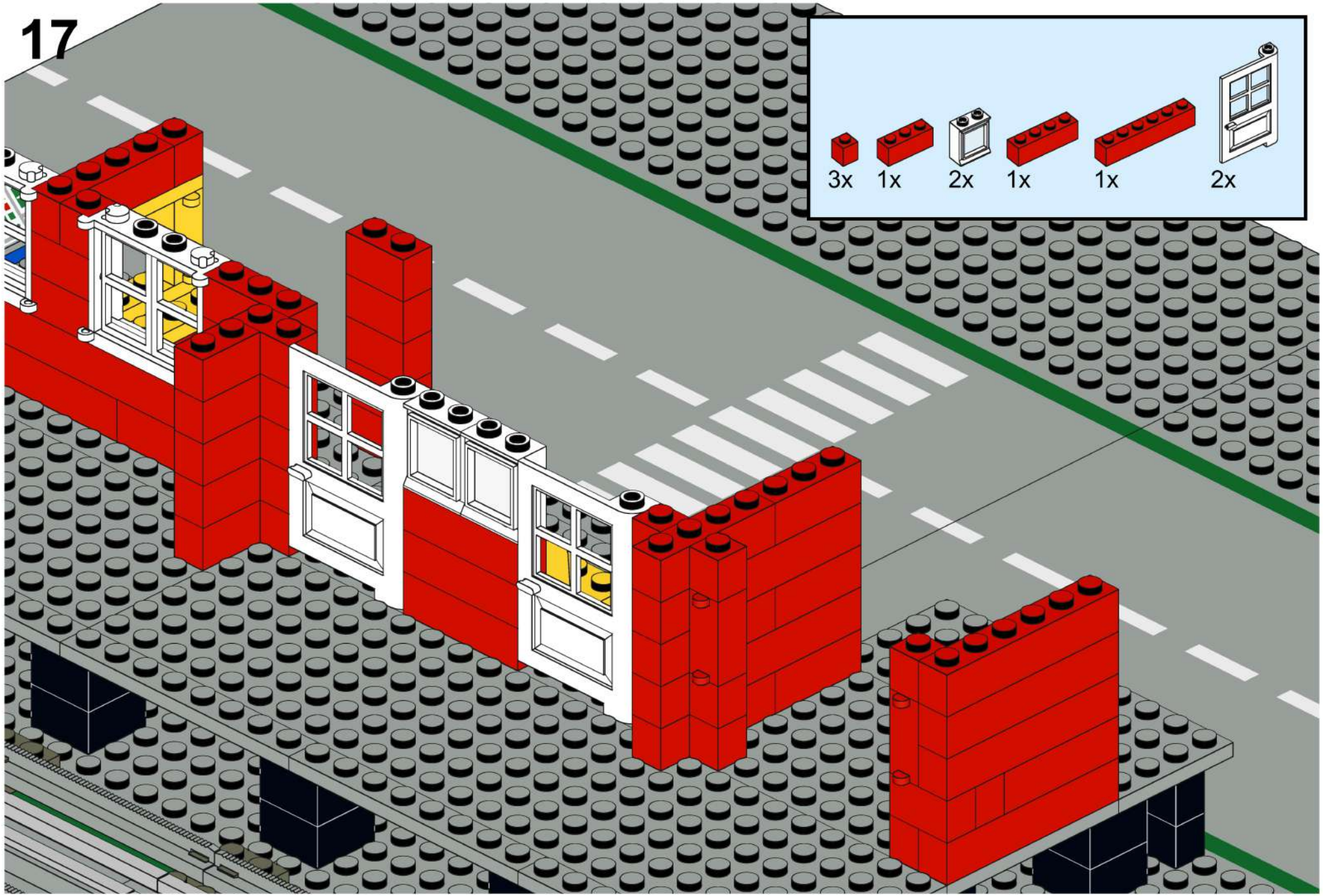

3x 1x 2x 1x 1x 2x

A parts list for step 17, displayed in a light blue box. The list includes: 3x red 1x1 brick, 1x red 1x3 brick, 2x white window frame, 1x red 1x3 brick, 1x red 1x5 brick, and 2x white window frame.

18

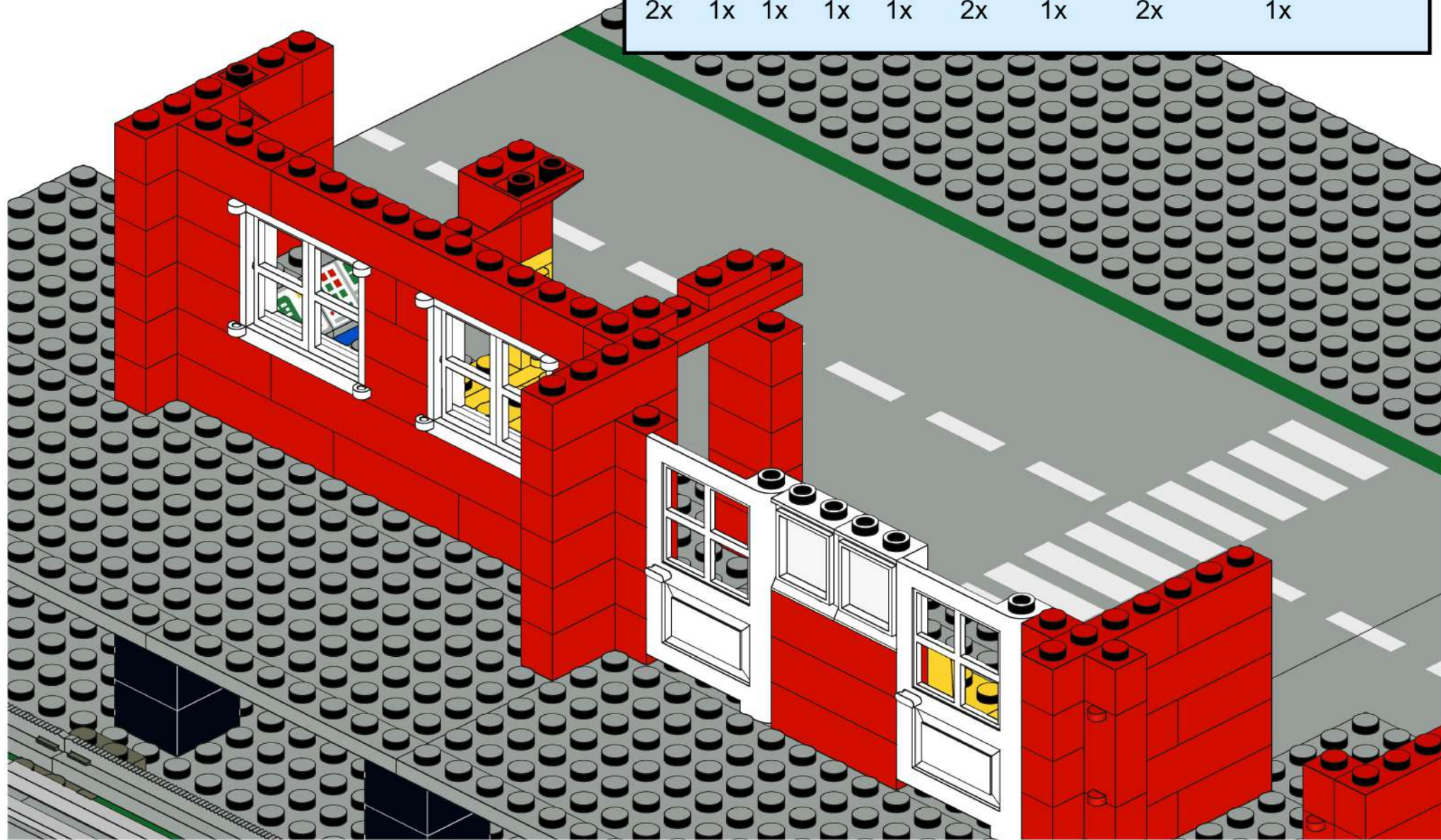
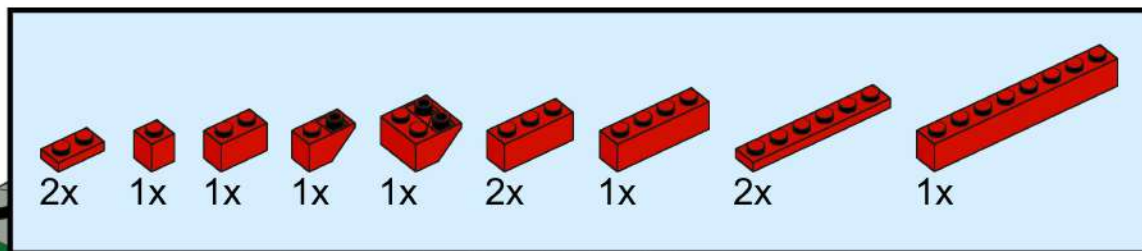

19

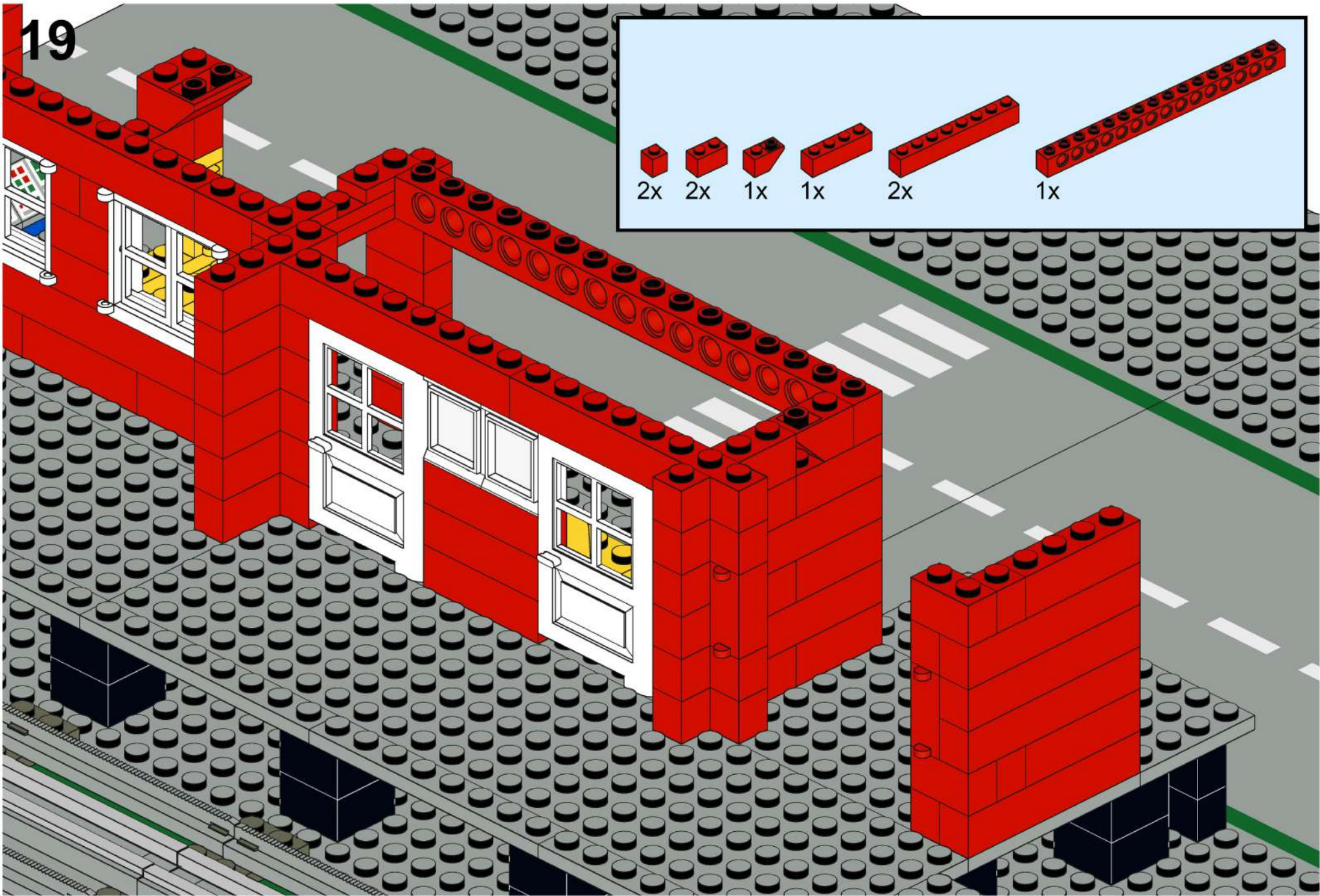

20

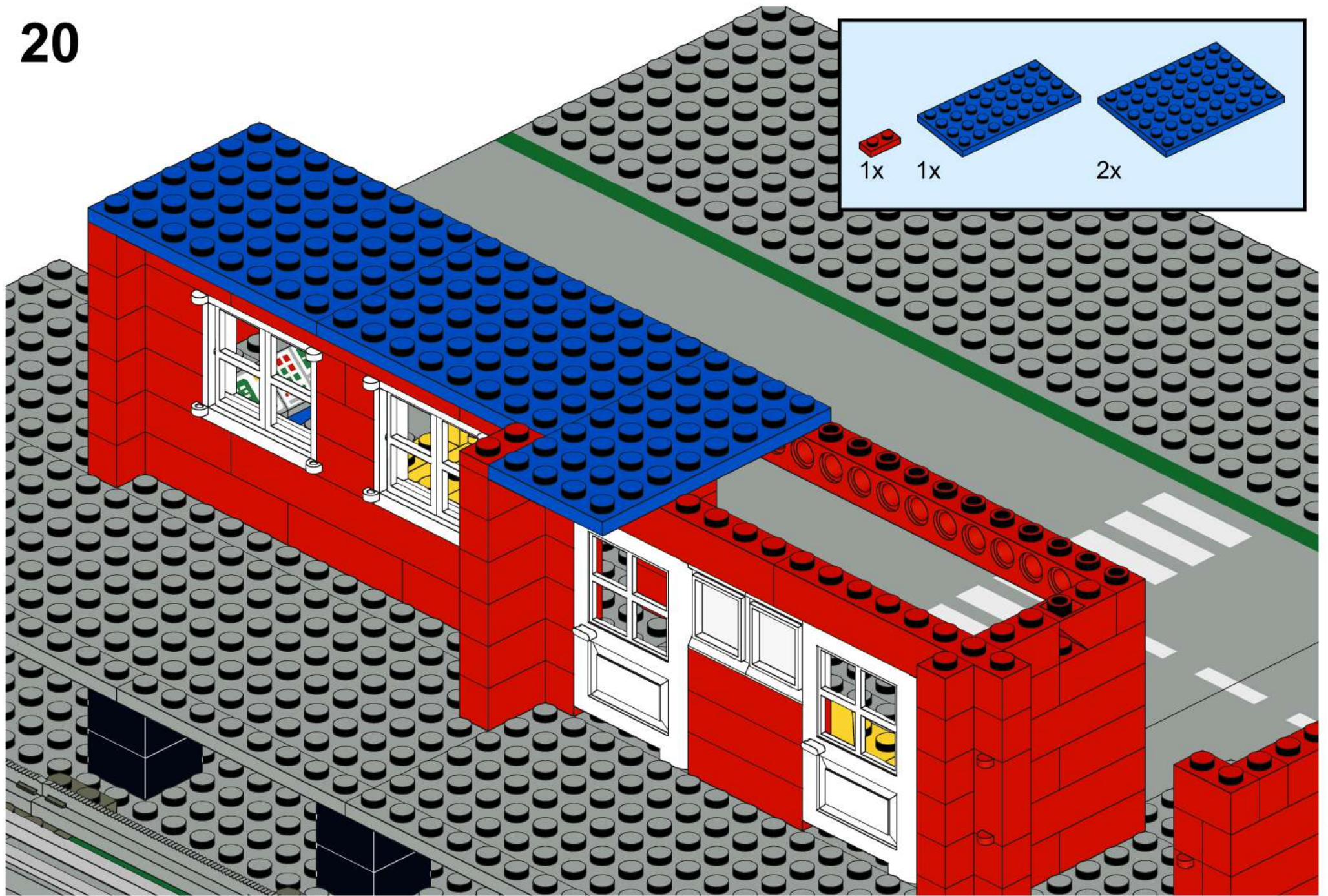

21

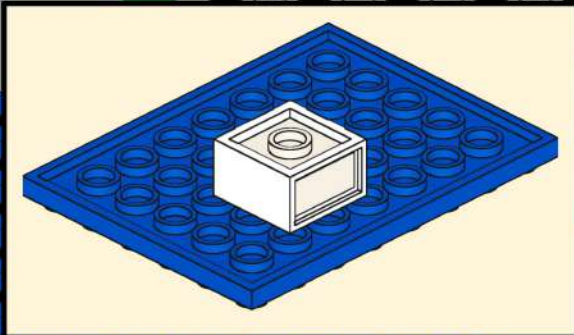

1x 1x 1x 1x 1x 1x 2x

A parts list for step 21, showing the following items: a white 1x1 brick with a hole, a red 1x3 Technic brick, a red 1x5 Technic brick, a red 1x7 Technic brick, a blue 1x4 Technic plate, a blue 4x4 Technic plate, and two white vertical bars with a latch.

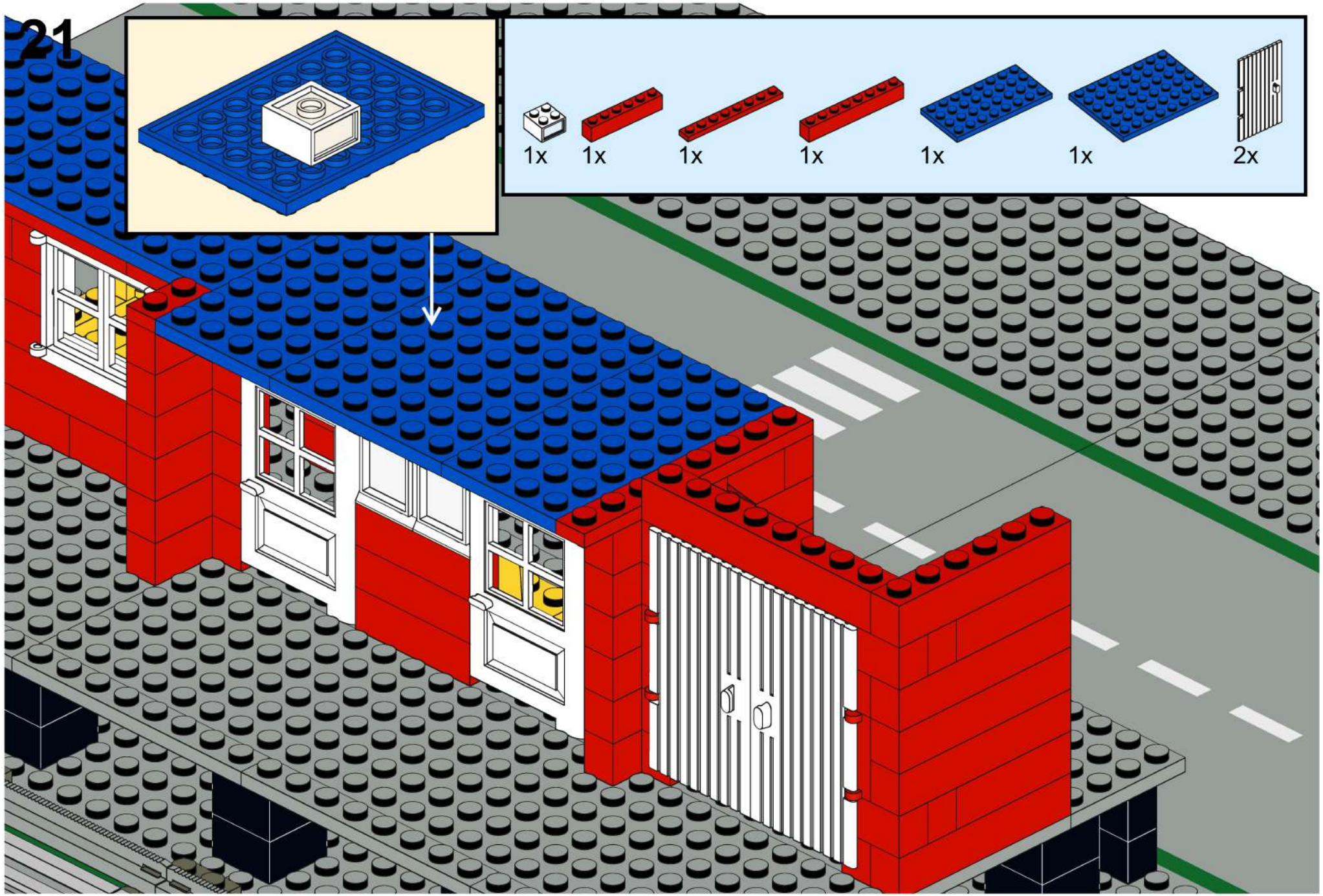

22

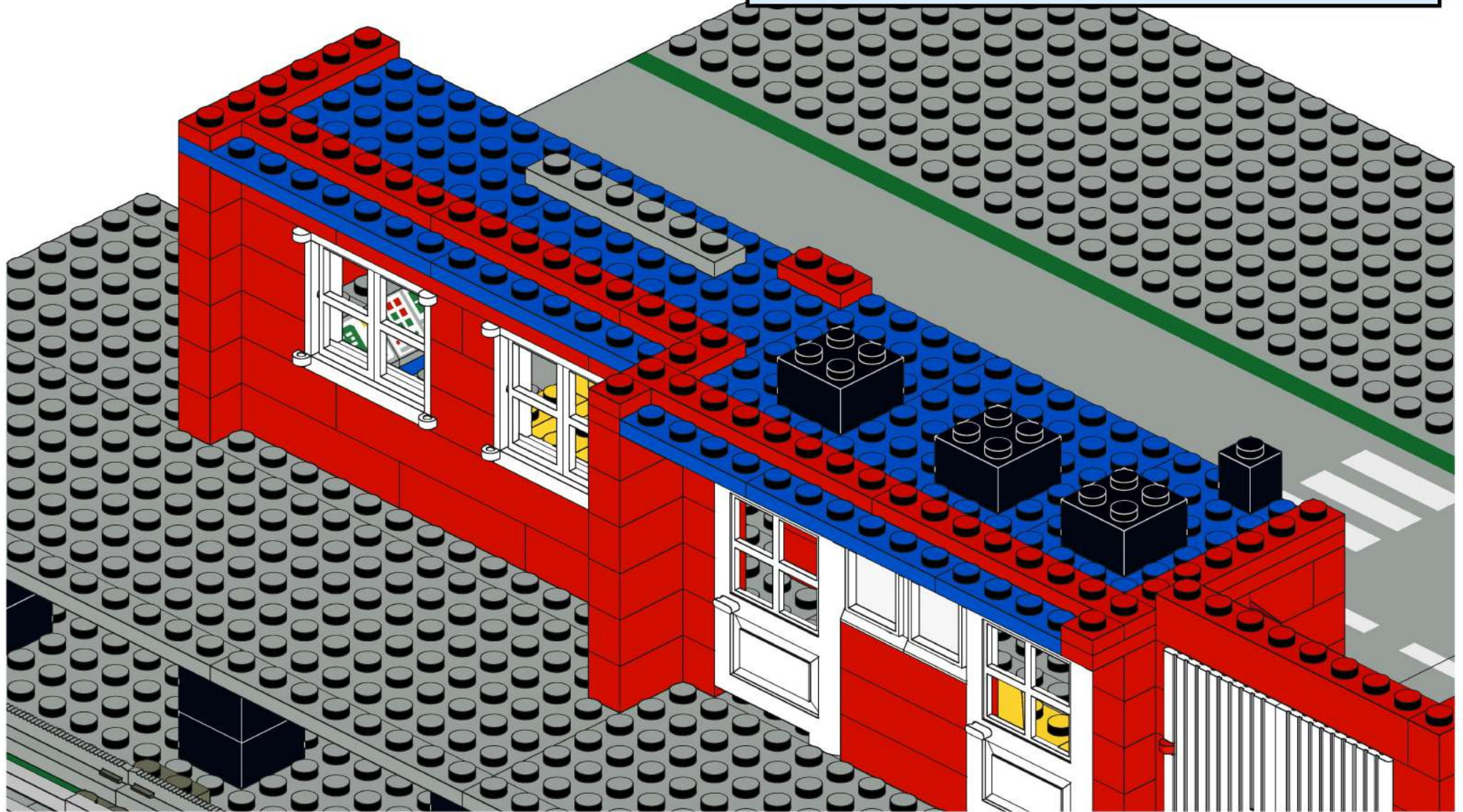
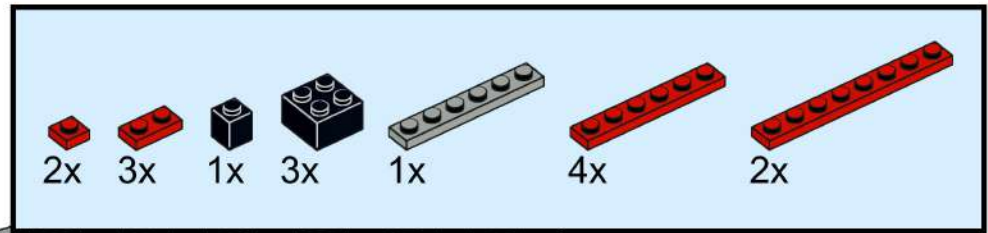

23



1x 1x 1x 2x

This inset box shows the parts list for step 23. It contains four blue Technic parts: a 1x2 plate, a 1x4 plate, a 1x6 plate, and a 1x10 plate. Below each part is a quantity label: '1x' for the first three and '2x' for the last.

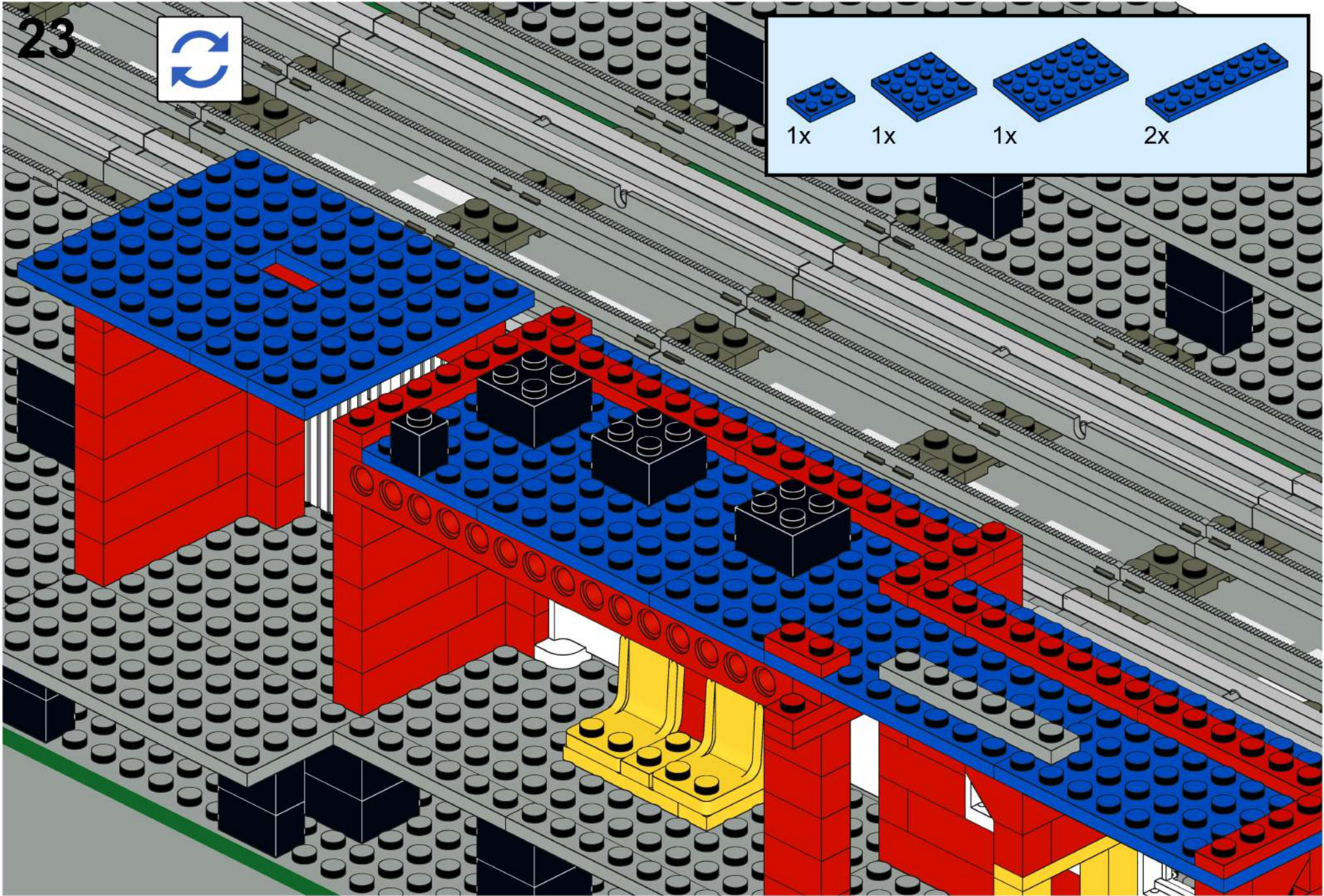

24

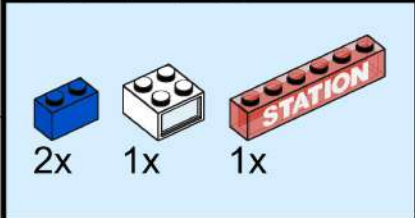

2x 1x 1x

STATION

This inset box lists the required parts for step 24: two blue 1x2 Technic bricks, one white 1x2 Technic brick with three holes, and one red 1x6 Technic brick with the word 'STATION' printed on it. The parts are shown with their respective quantities below them.

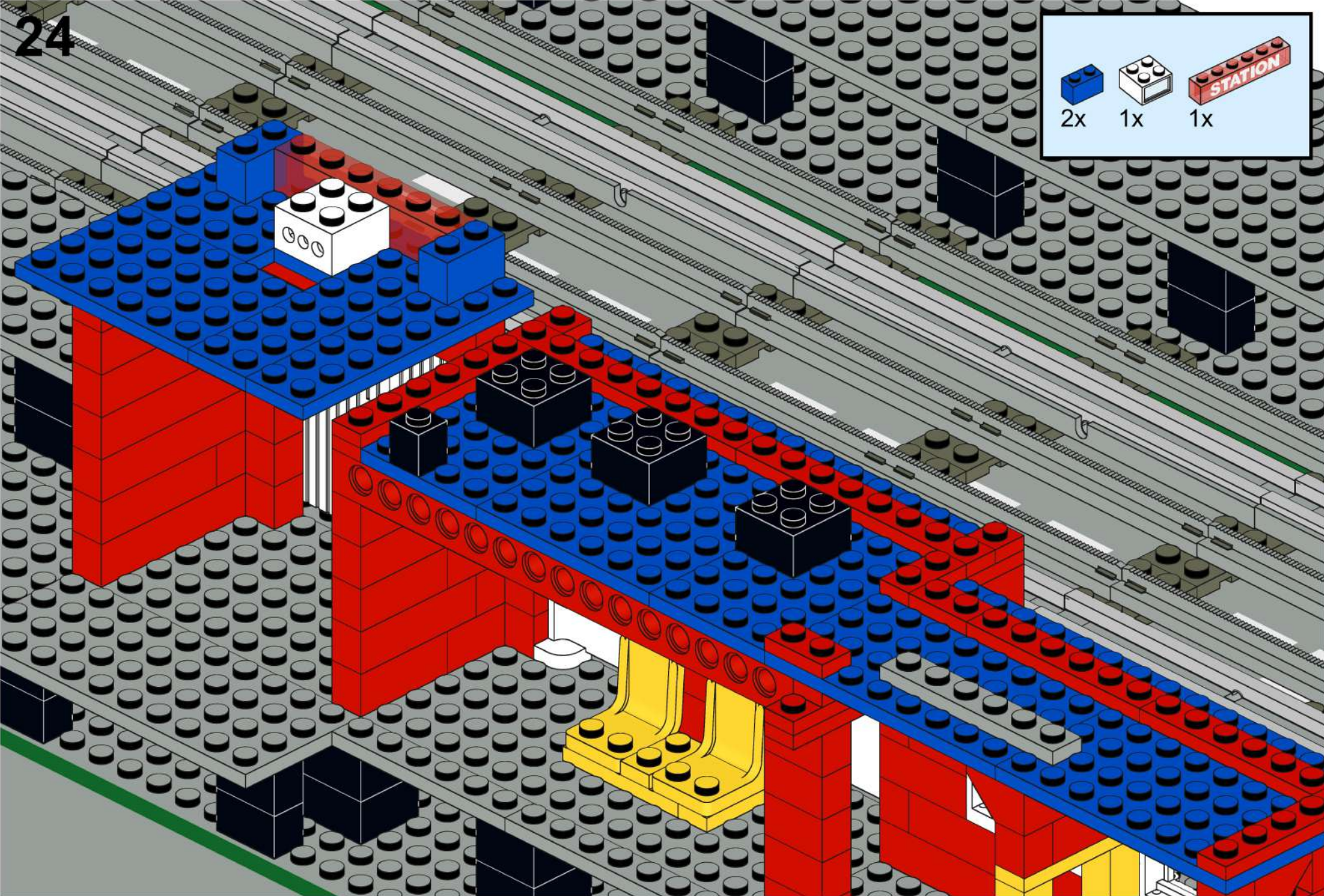

25

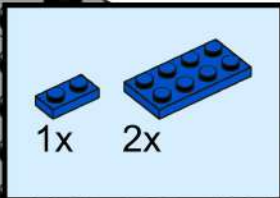

1x 2x

This inset box shows the parts required for step 25: one 1x2 blue Technic brick with holes and two 1x2 blue Technic bricks with holes.

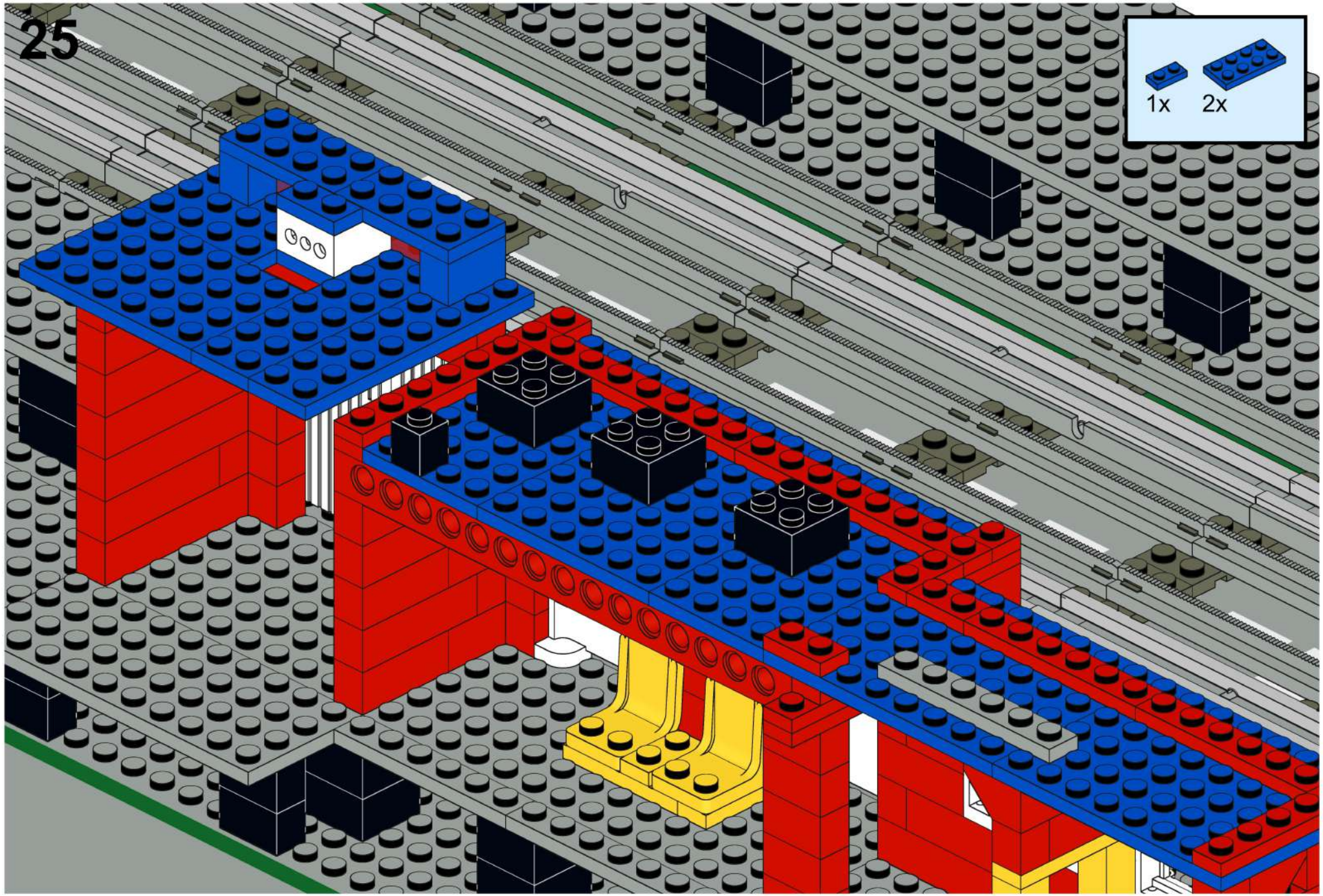

26

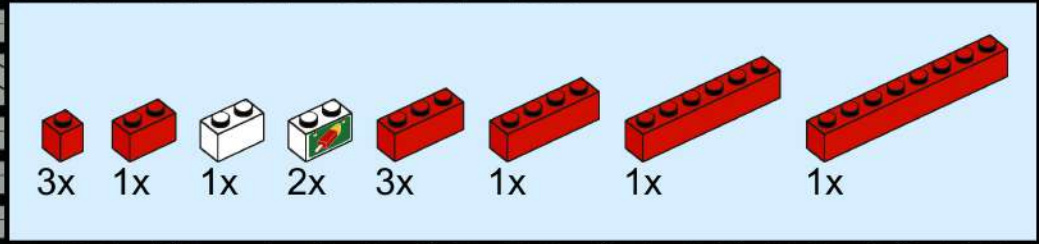

A parts list box containing eight items with their respective quantities:

- 3x Red 1x1 brick
- 1x Red 1x2 brick
- 1x White 1x2 brick with two black studs
- 2x White 1x2 brick with a red and green pattern
- 3x Red 1x3 brick
- 1x Red 1x4 brick
- 1x Red 1x5 brick
- 1x Red 1x6 brick

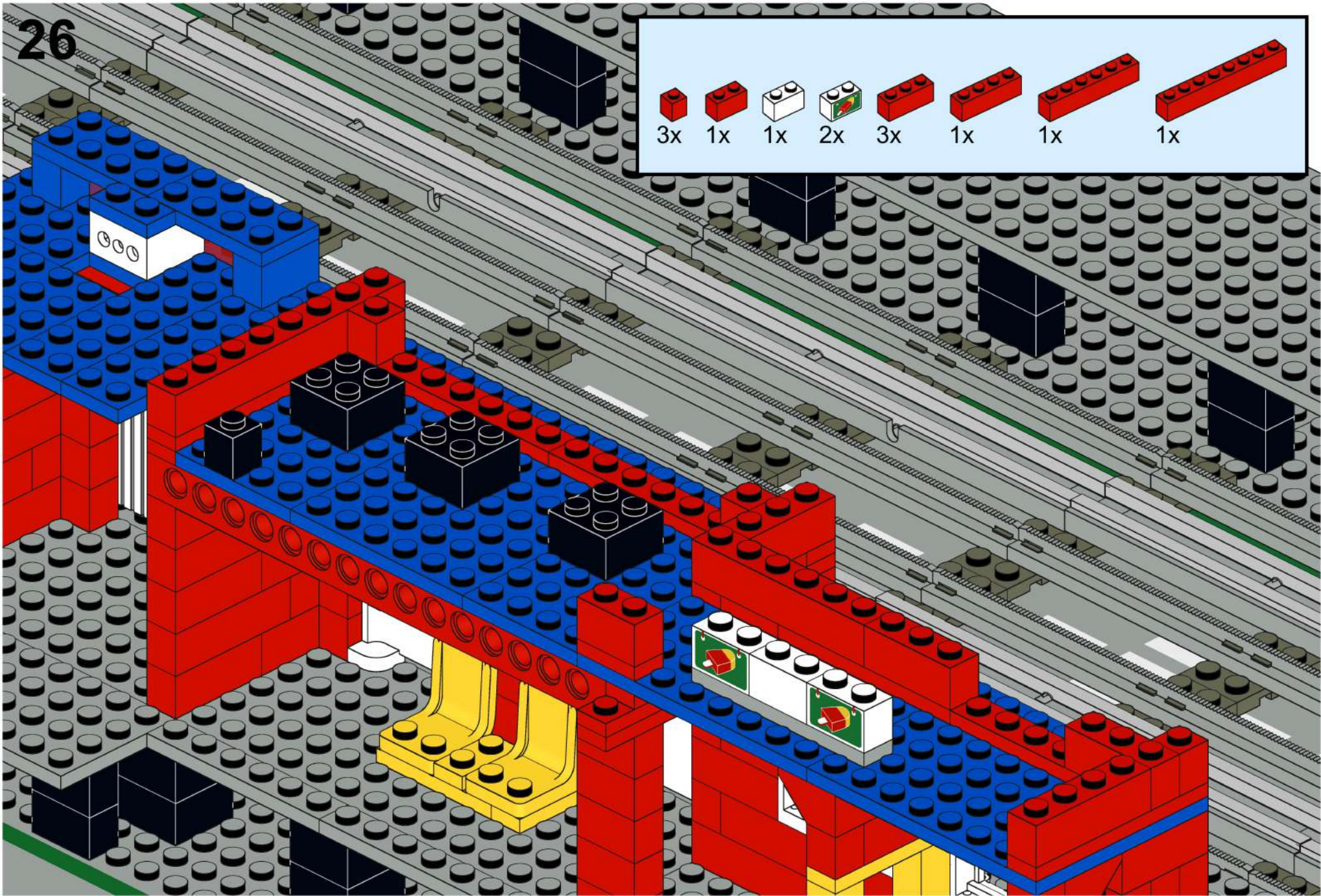

27

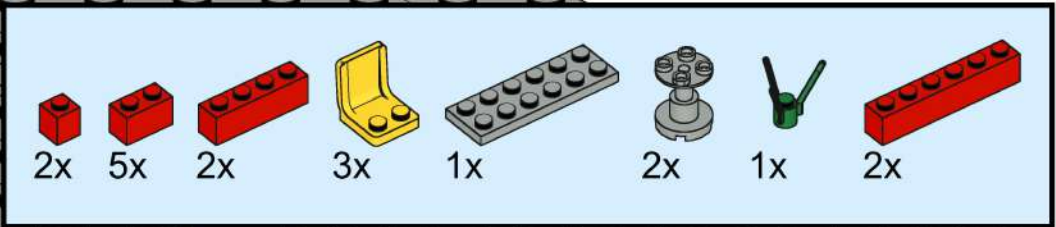

2x 5x 2x 3x 1x 2x 1x 2x

This block contains a parts list for step 27. It includes: 2x red 1x1 bricks, 5x red 1x2 bricks, 2x red 1x3 bricks, 3x yellow 1x2 curved connectors, 1x grey 1x5 Technic brick with holes, 2x grey 4-way Technic connectors, 1x green 3-pronged Technic pin, and 2x red 1x4 Technic bricks.

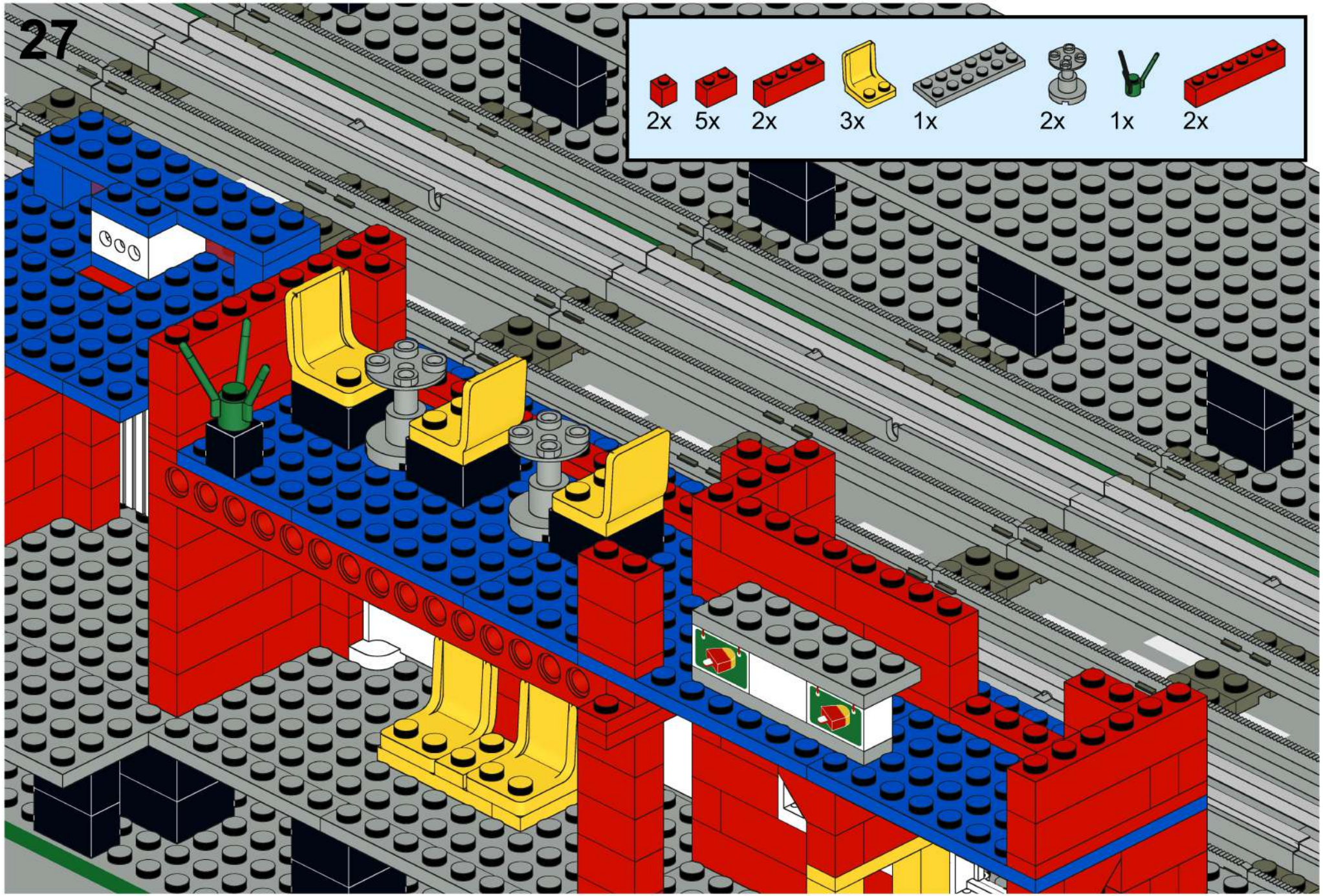

28

A parts list box containing the following items and quantities:

- 3x Yellow Technic Axle
- 3x Red 1x1 Technic Brick
- 2x White 1x2 Technic Plate with Holes
- 4x Red 1x2 Technic Brick
- 1x Black 1x2 Technic Slope
- 3x Red 1x3 Technic Brick
- 1x Red 1x6 Technic Brick

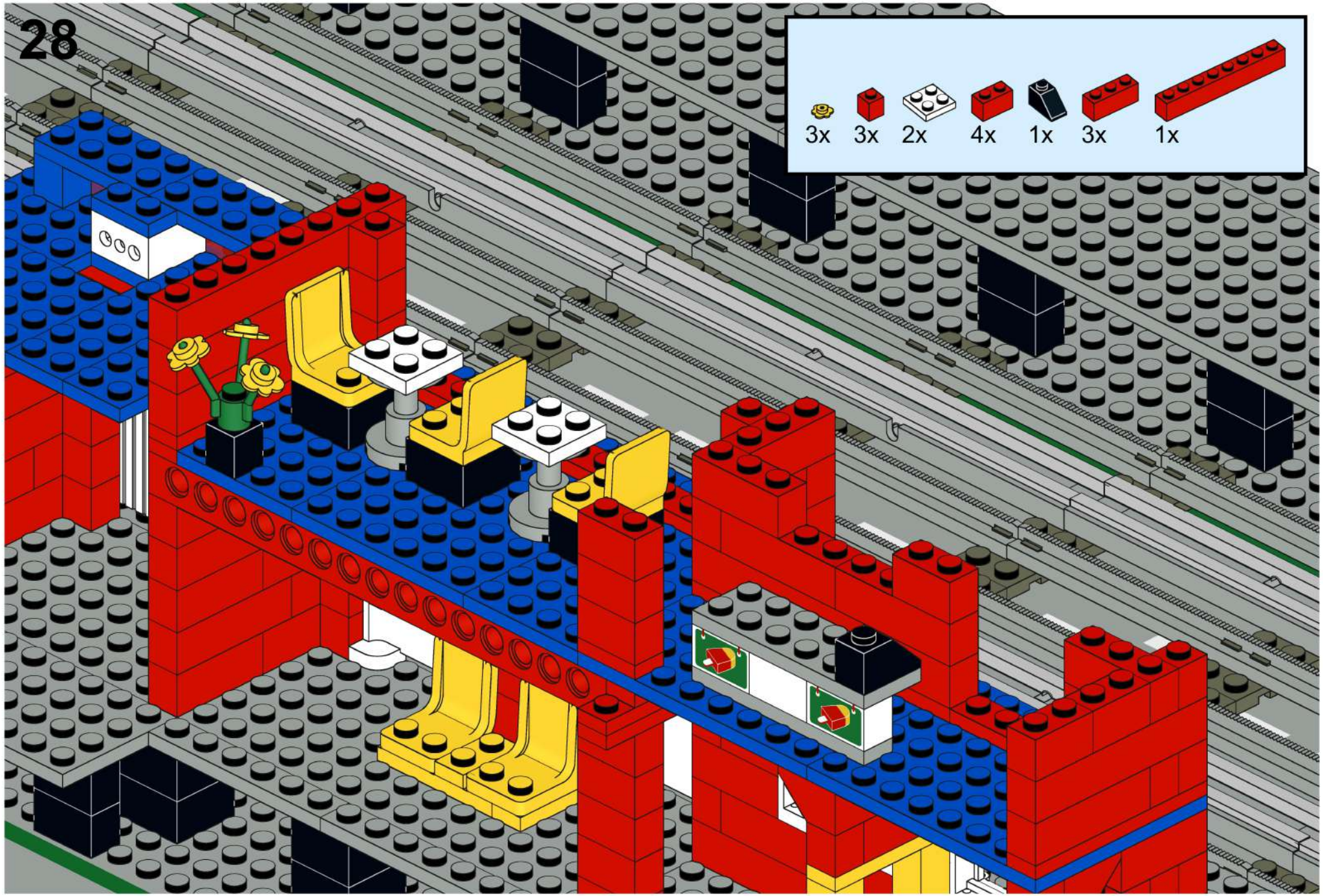

29

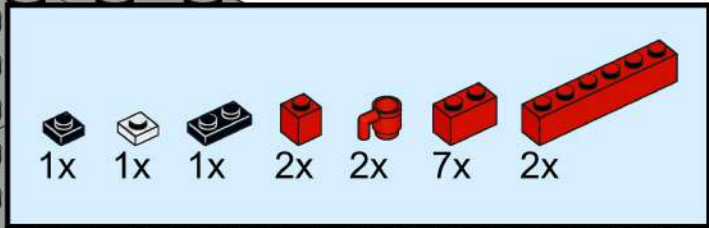

1x 1x 1x 2x 2x 7x 2x

This block contains a parts list for step 29. It includes icons for: 1x black 1x1 Technic brick with a hole, 1x white 1x1 Technic brick with a hole, 1x black 1x2 Technic brick with a hole, 2x red 1x1 Technic bricks, 2x red 1x2 Technic bricks, 7x red 1x3 Technic bricks, and 2x red 1x6 Technic bricks.

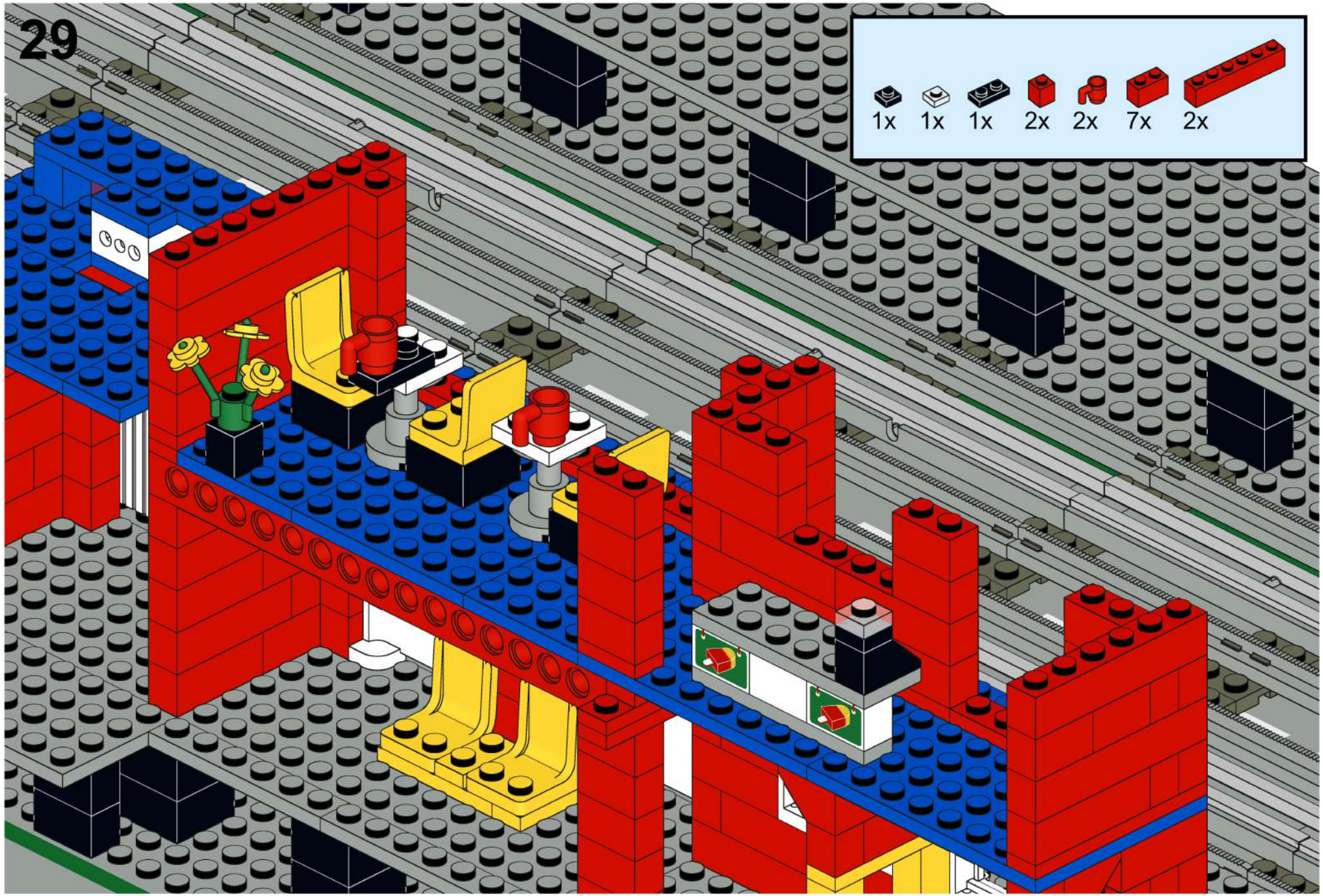

30

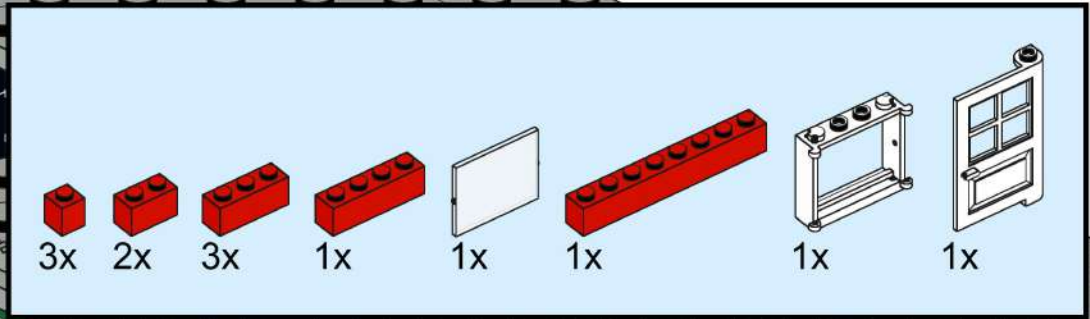

3x 2x 3x 1x 1x 1x 1x 1x

This inset box lists the required parts for step 30. It includes: 3 small red 1x1 bricks, 2 red 1x2 bricks, 3 red 1x3 bricks, 1 red 1x4 brick, 1 white 1x2 plate, 1 red 1x6 brick, 1 white kitchen sink, and 1 white window frame.

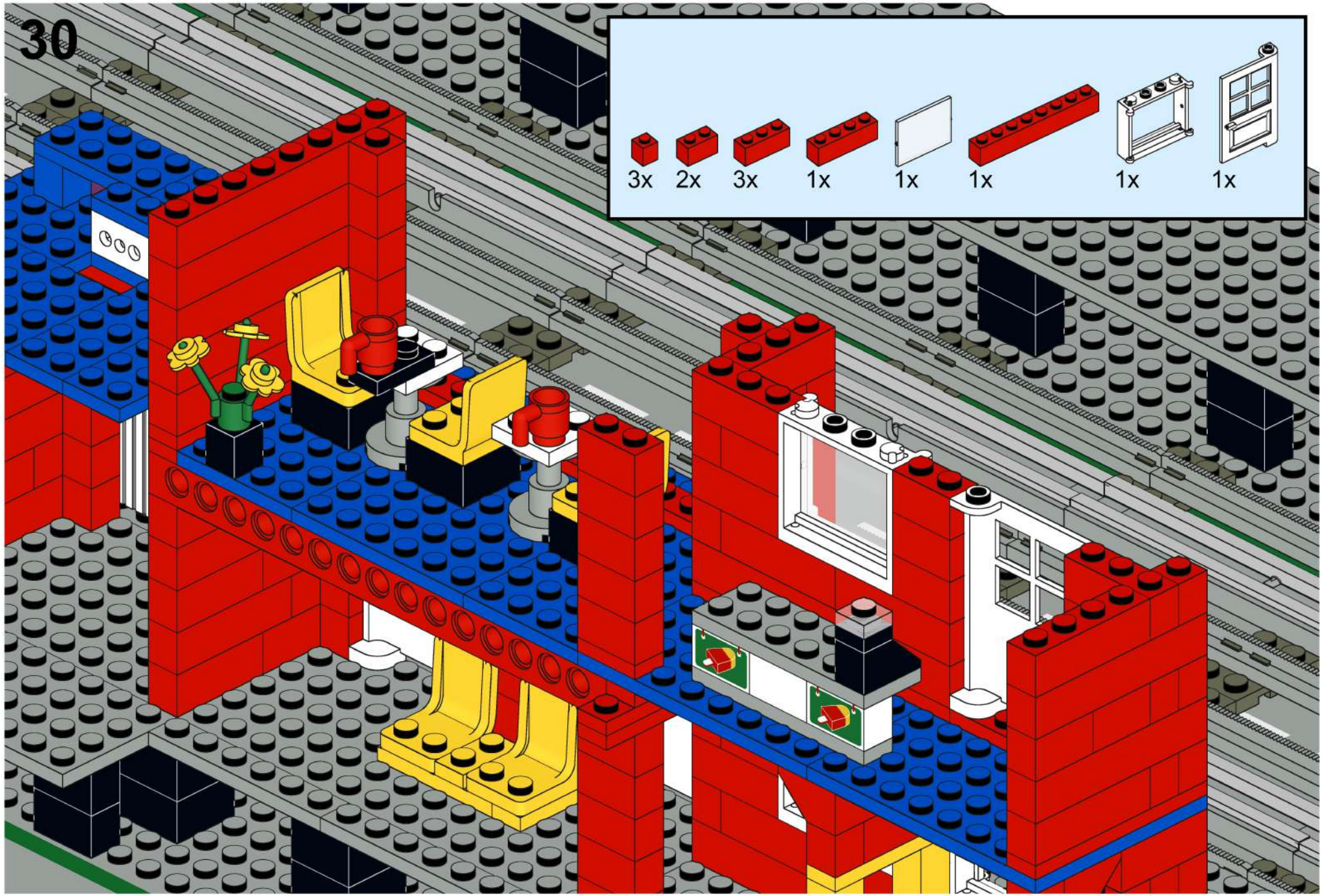

31

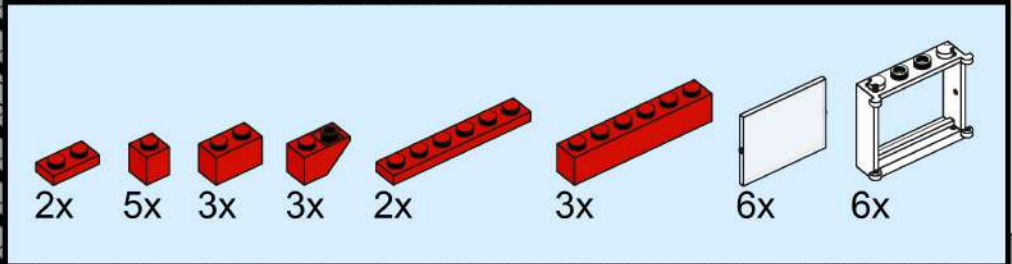

2x 5x 3x 3x 2x 3x 6x 6x

This inset box lists the required parts for step 31. It contains eight items: a 1x2 red brick (2x), a 1x2 red brick with a hole (5x), a 1x3 red brick (3x), a 1x3 red brick with a hole (3x), a 1x6 red brick (2x), a 1x6 red brick with a hole (3x), a white 1x6 plate (6x), and a white 1x6 window frame (6x).

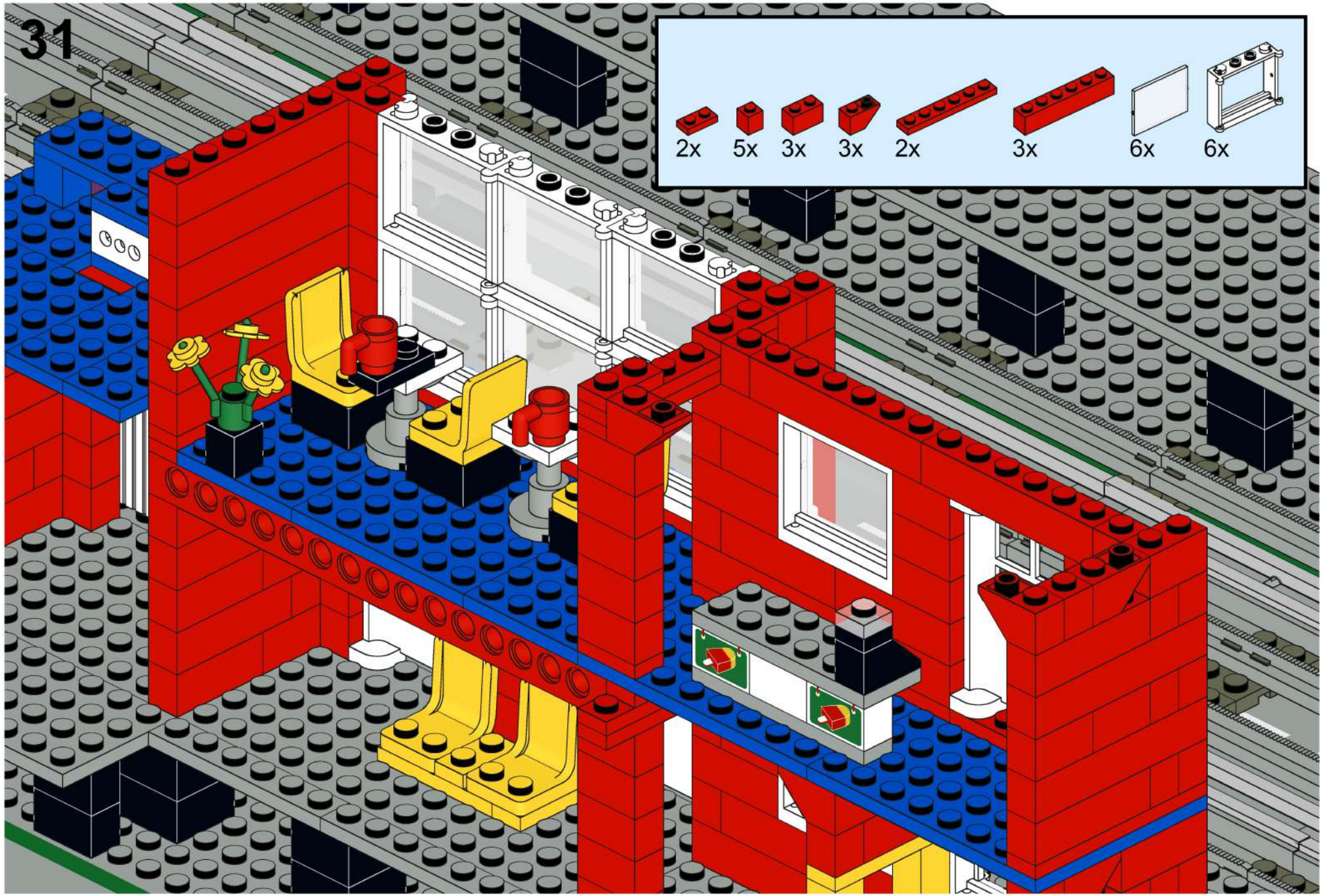

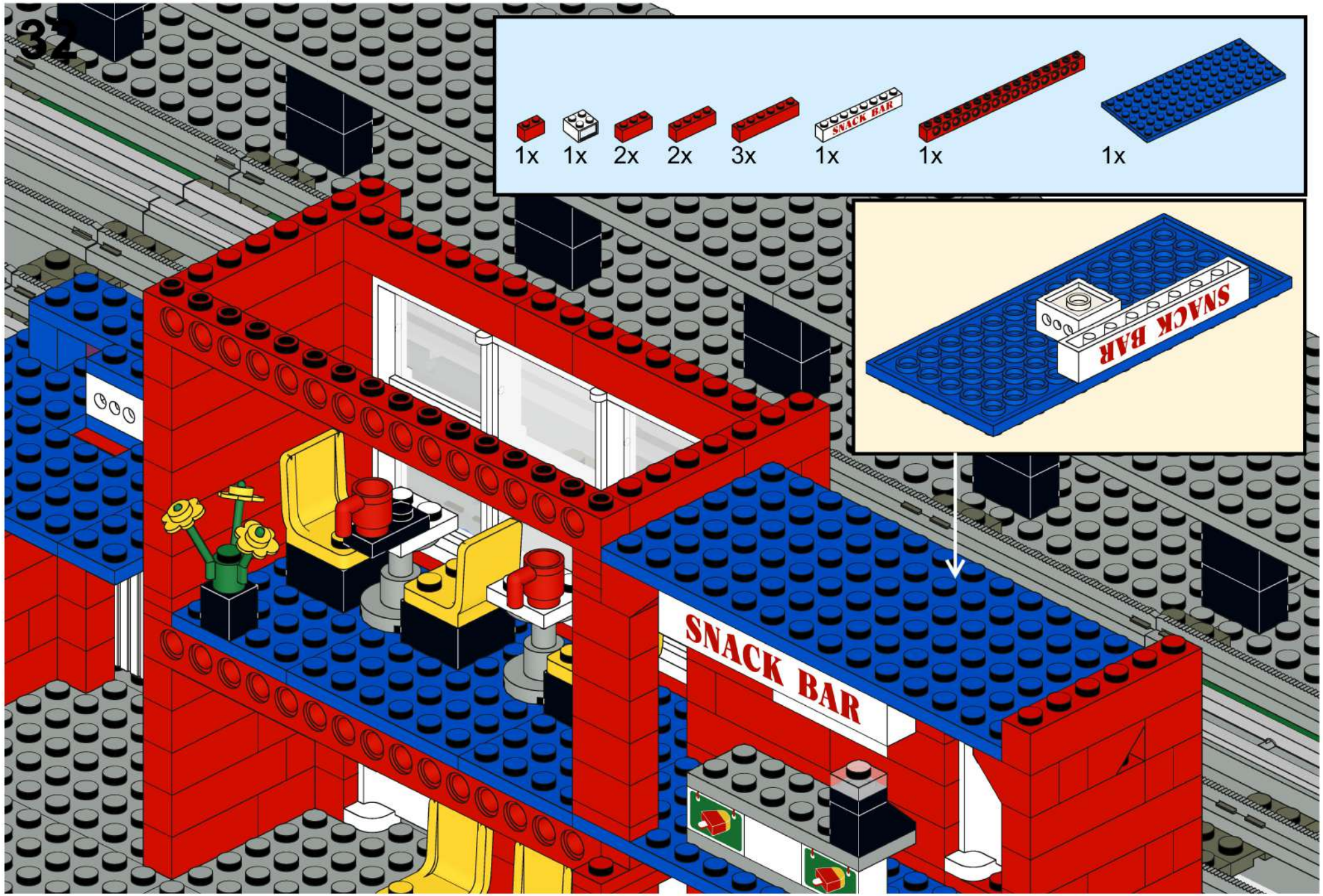

- 1x [red 1x1 Technic brick]
- 1x [white 1x2 Technic brick with hole]
- 2x [red 1x2 Technic brick]
- 2x [red 1x3 Technic brick]
- 3x [red 1x4 Technic brick]
- 1x [white 1x12 Technic bar with 'SNACK BAR' text]
- 1x [red 1x12 Technic bar with holes]
- 1x [blue 1x12 Technic plate]

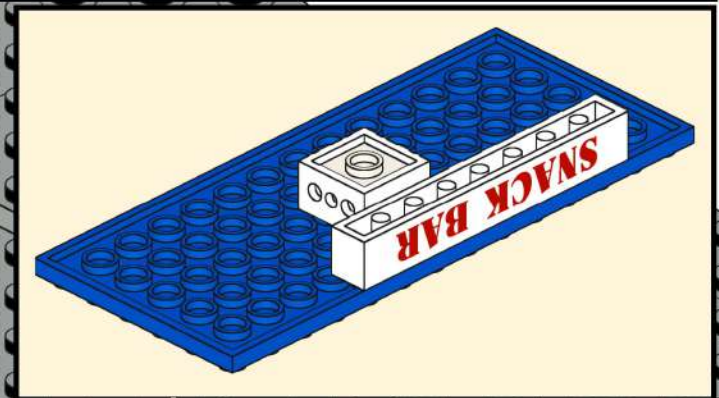

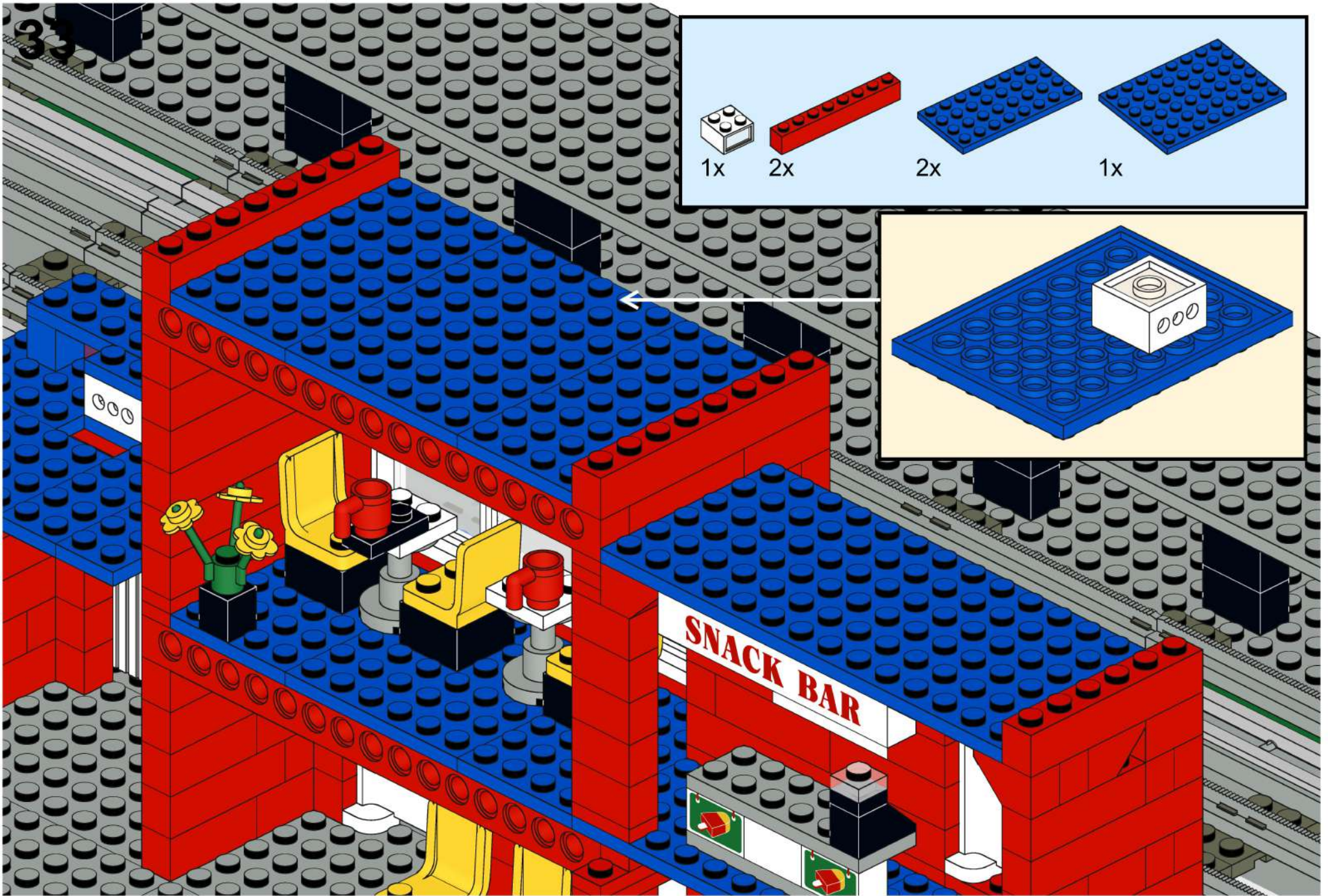

34

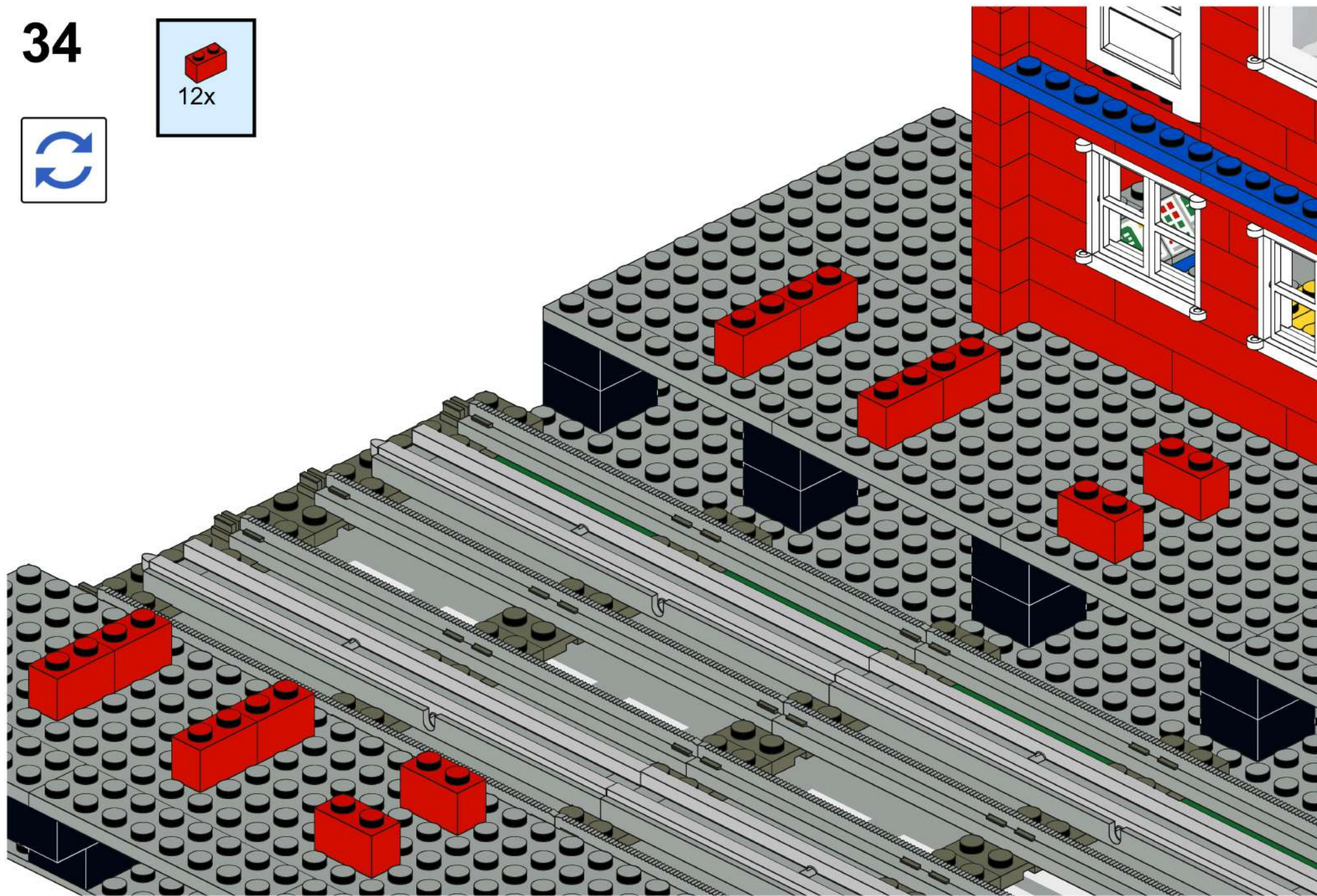
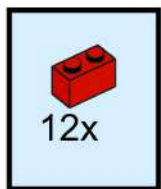

35

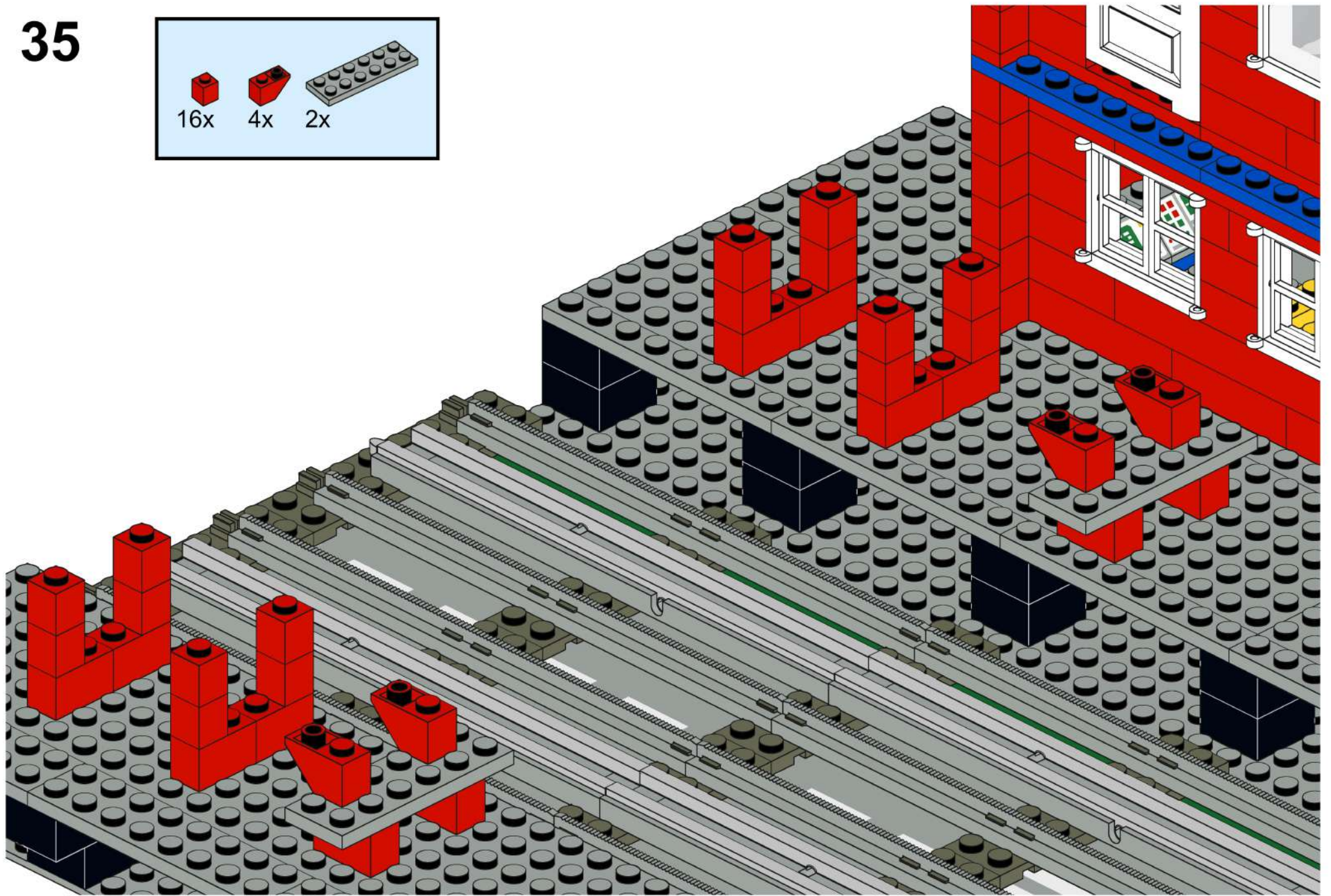
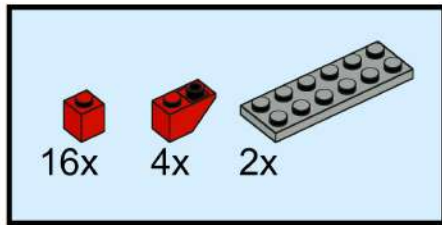

36

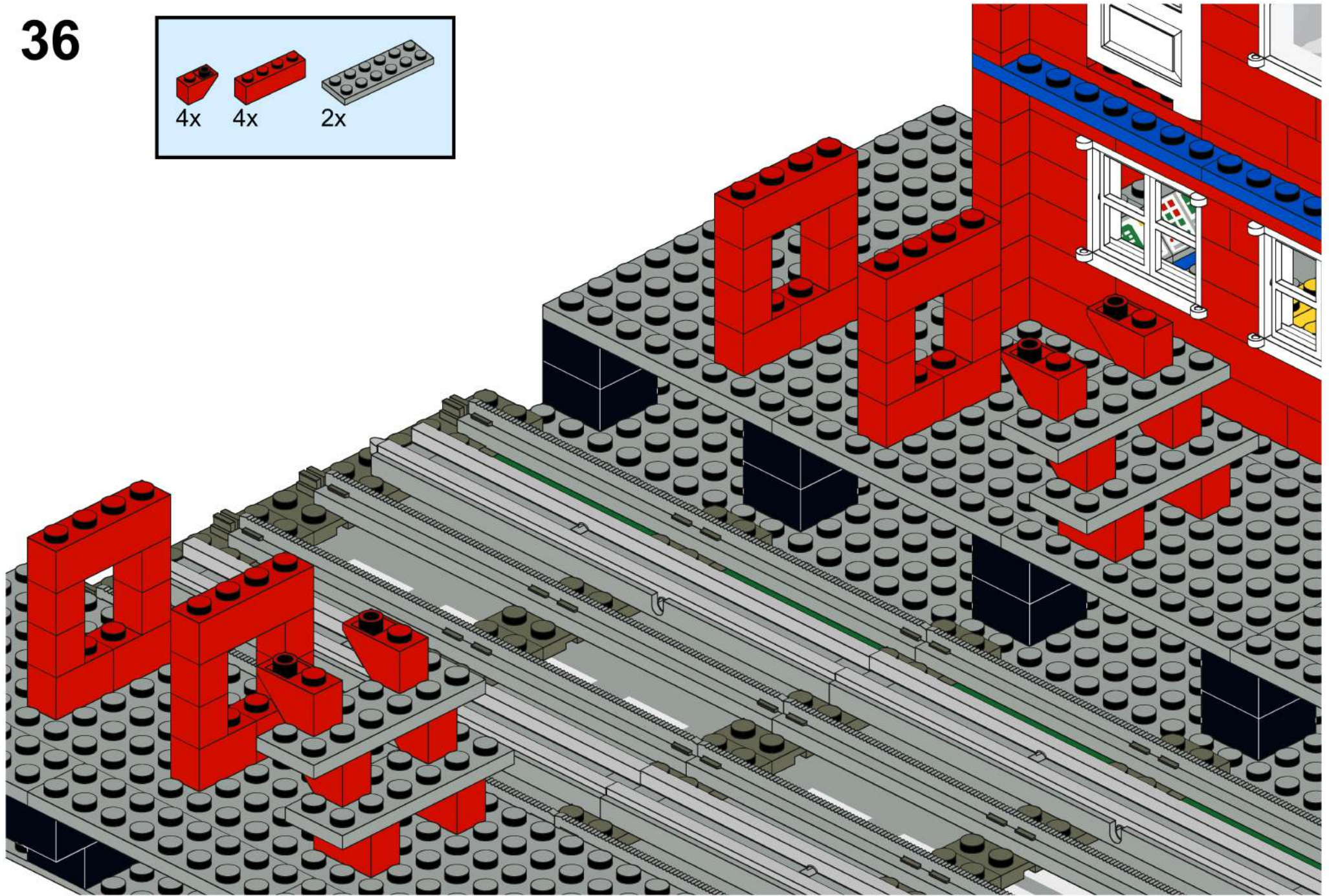
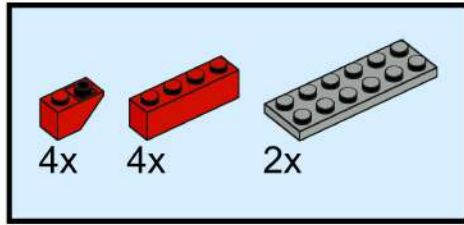

37

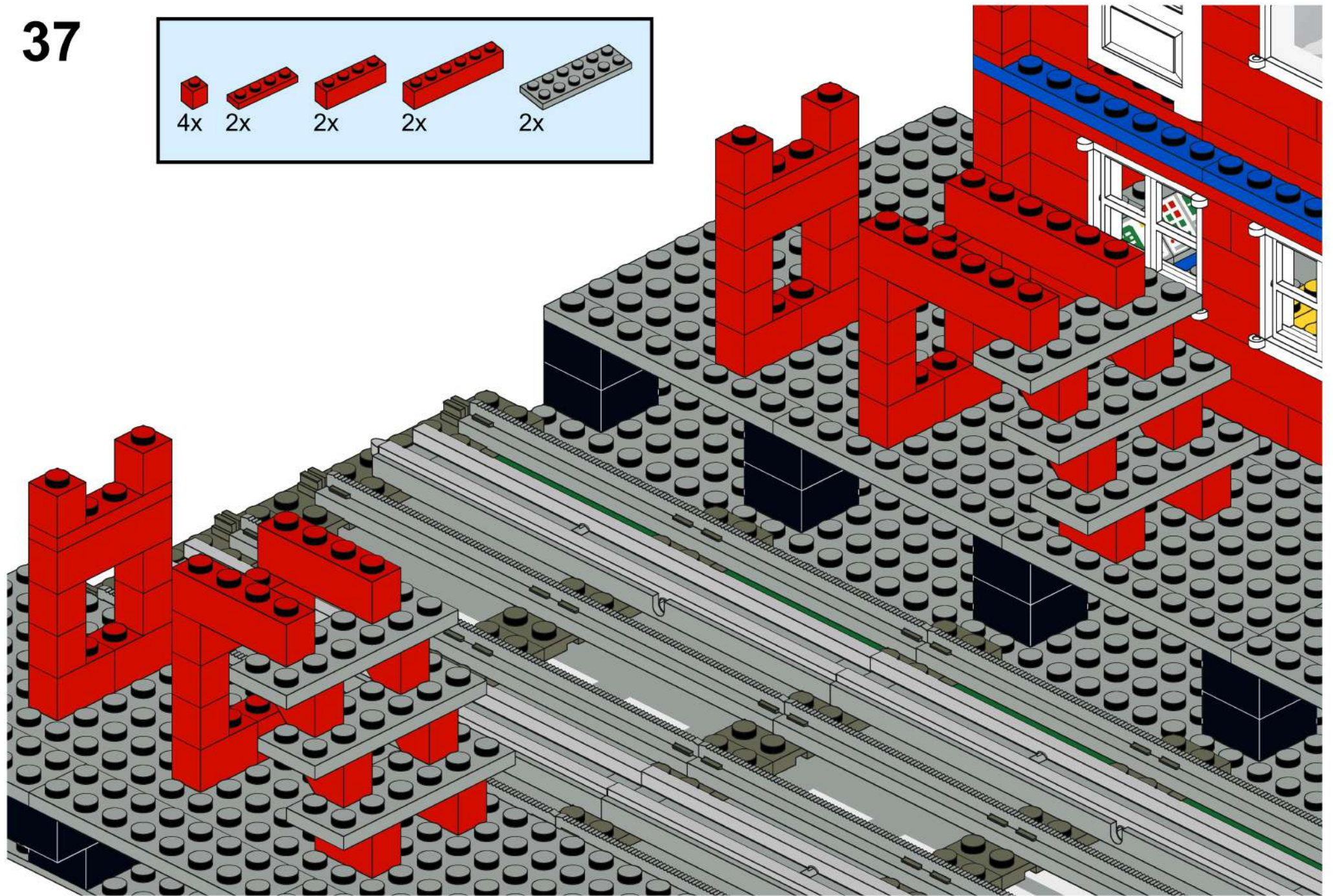
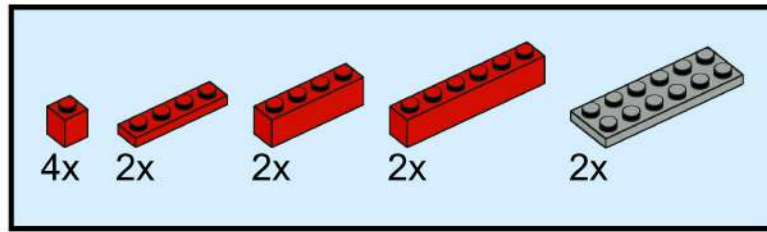

38

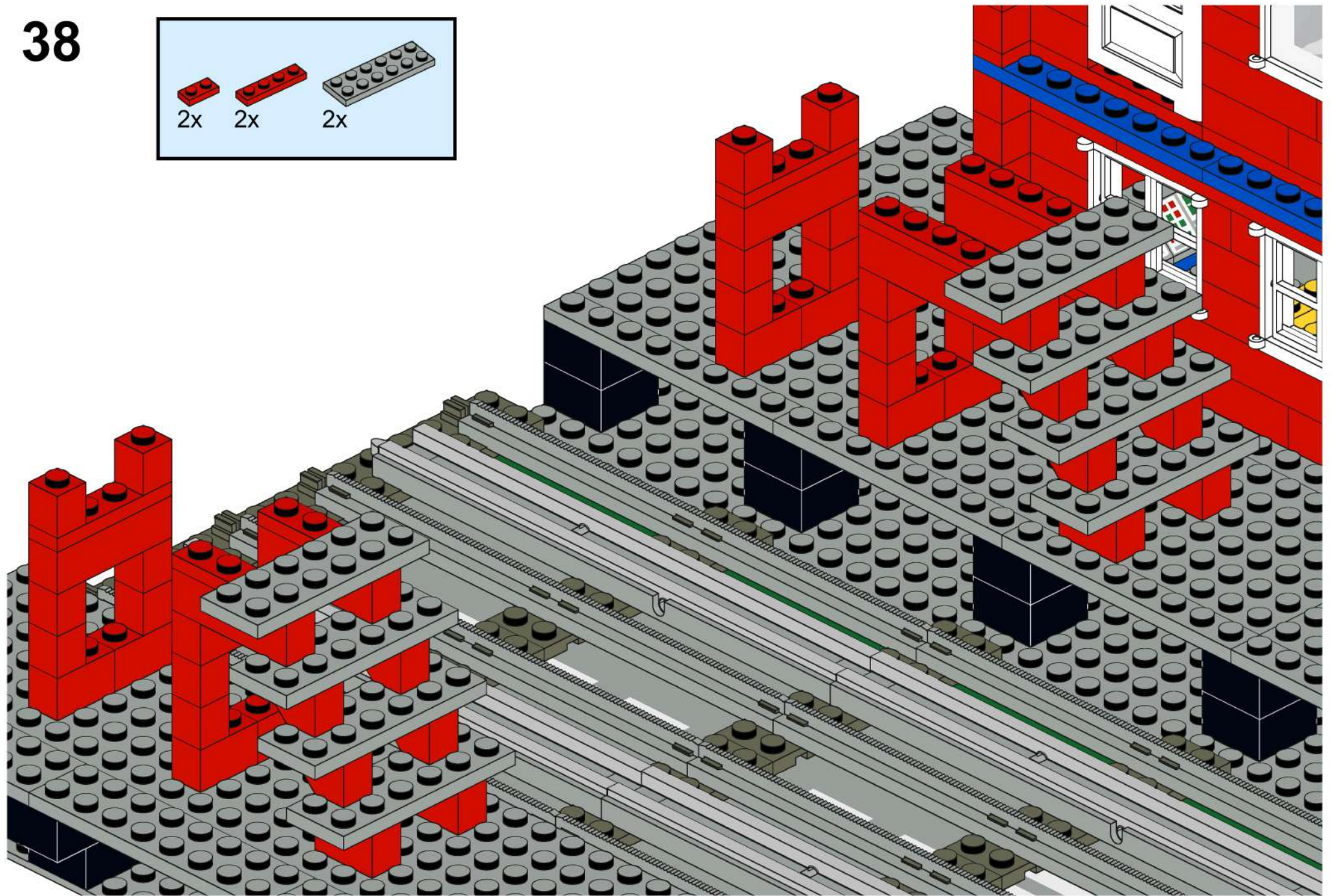
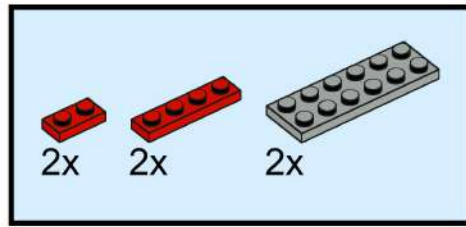

39

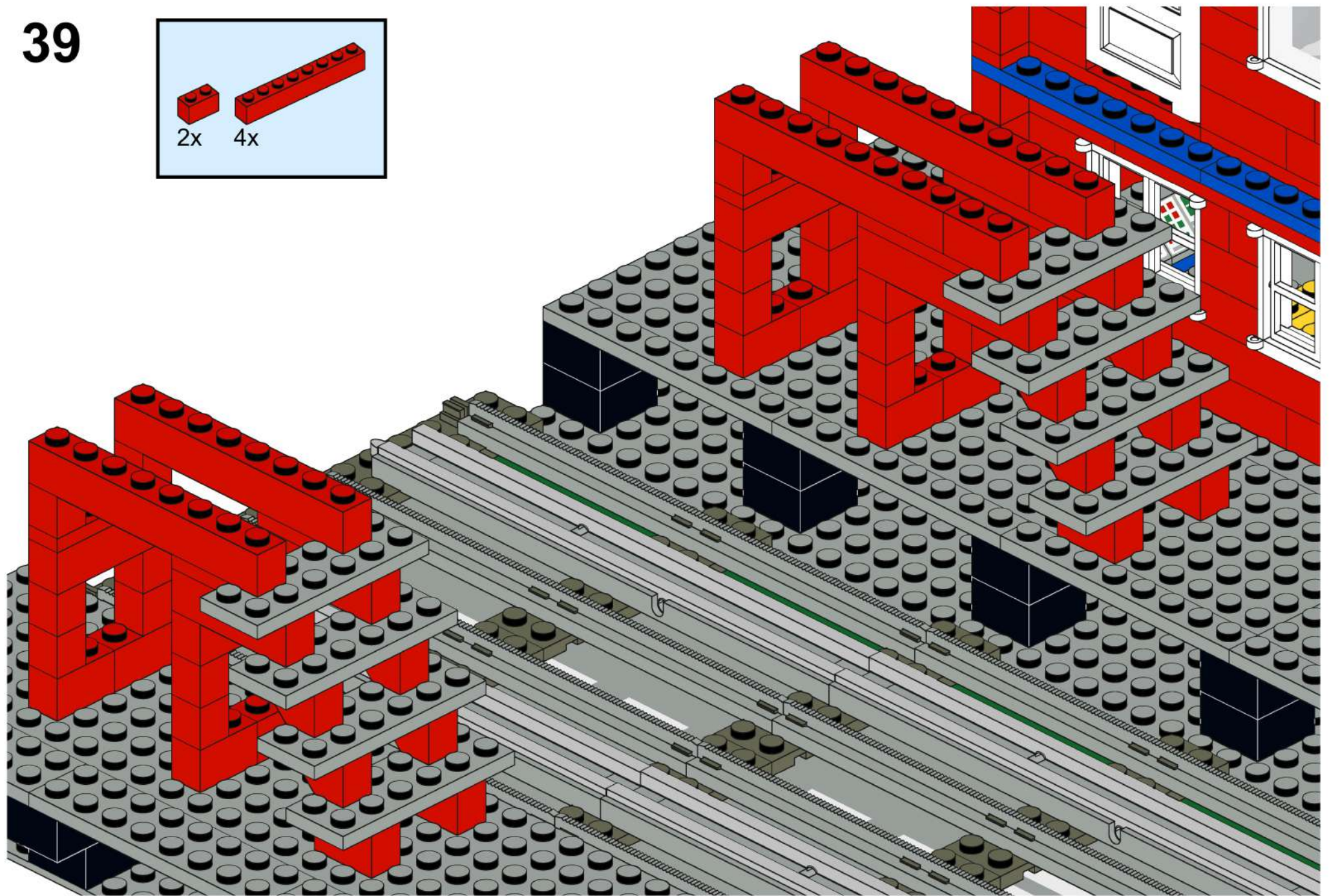
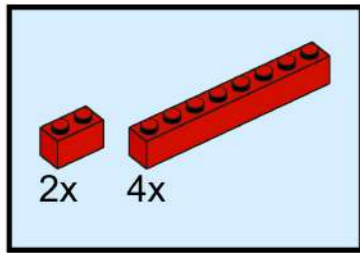

40

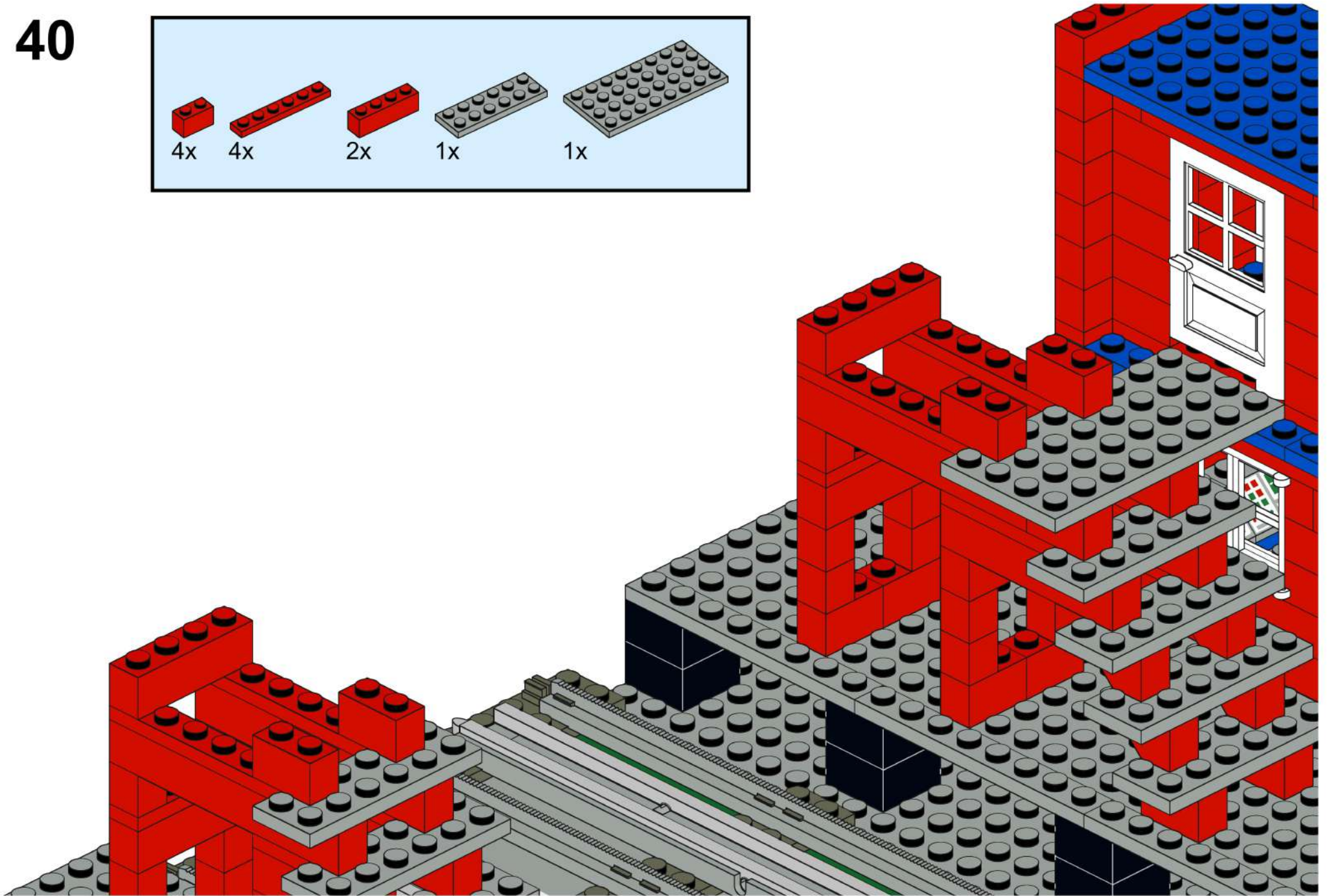
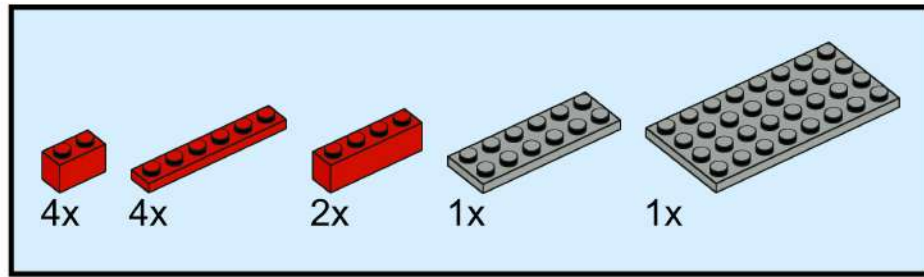

41

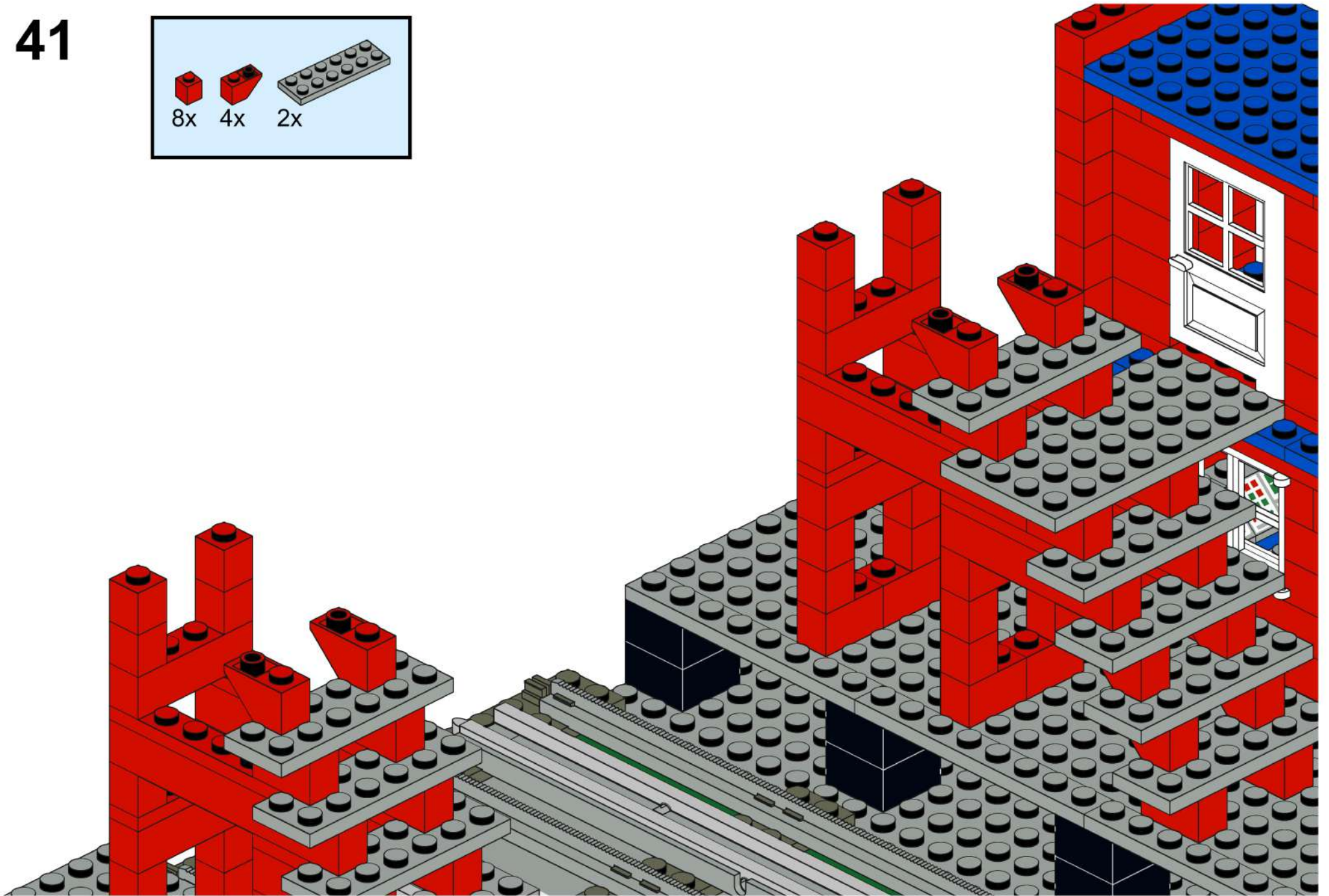
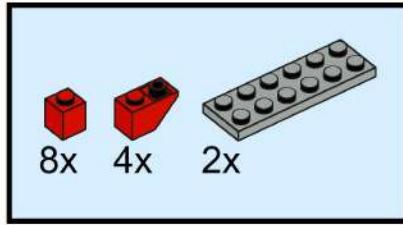

42

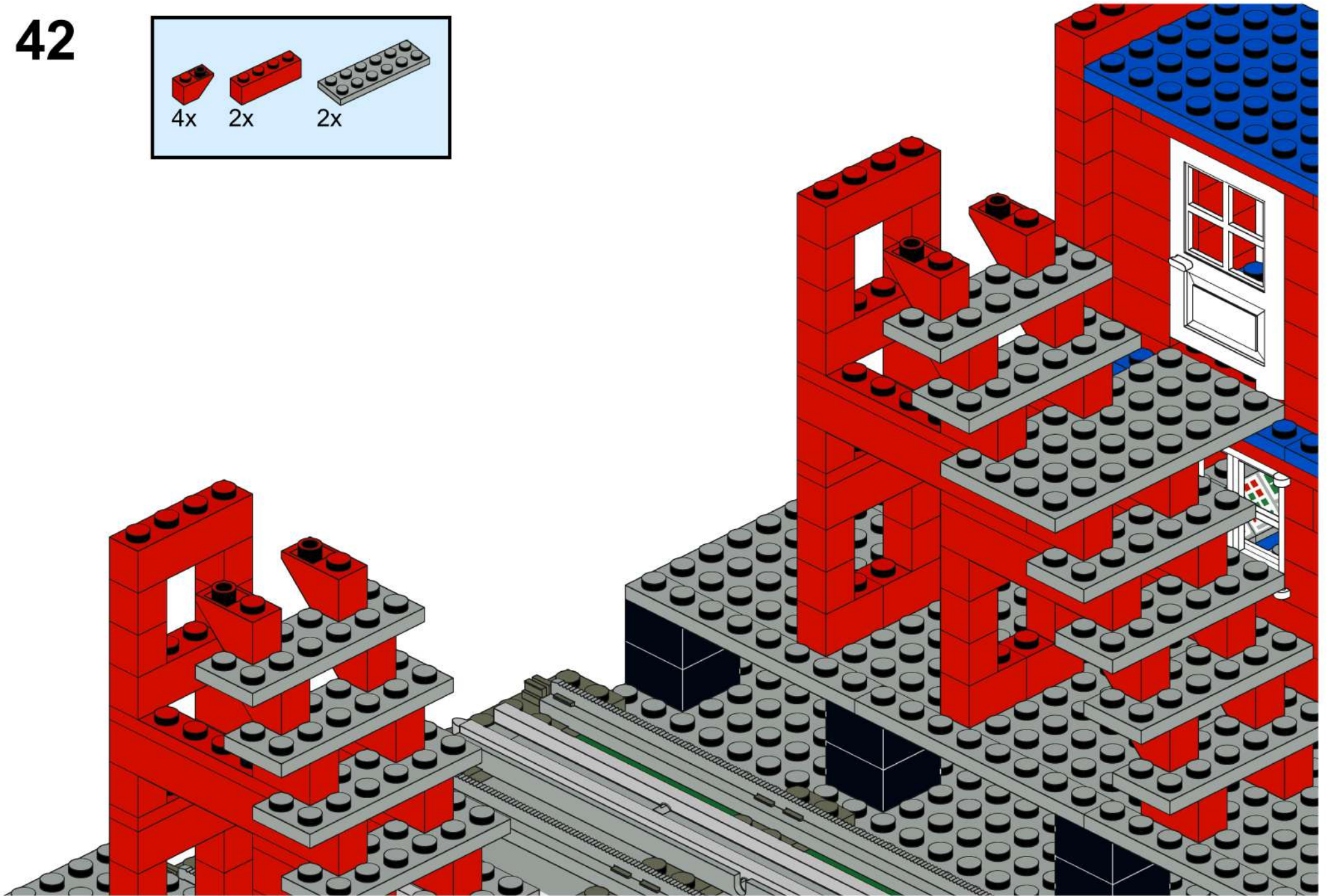
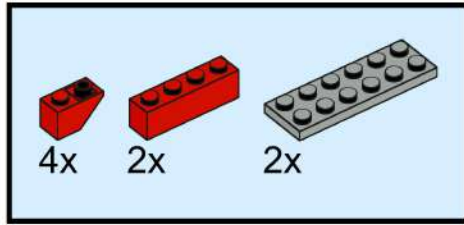

43

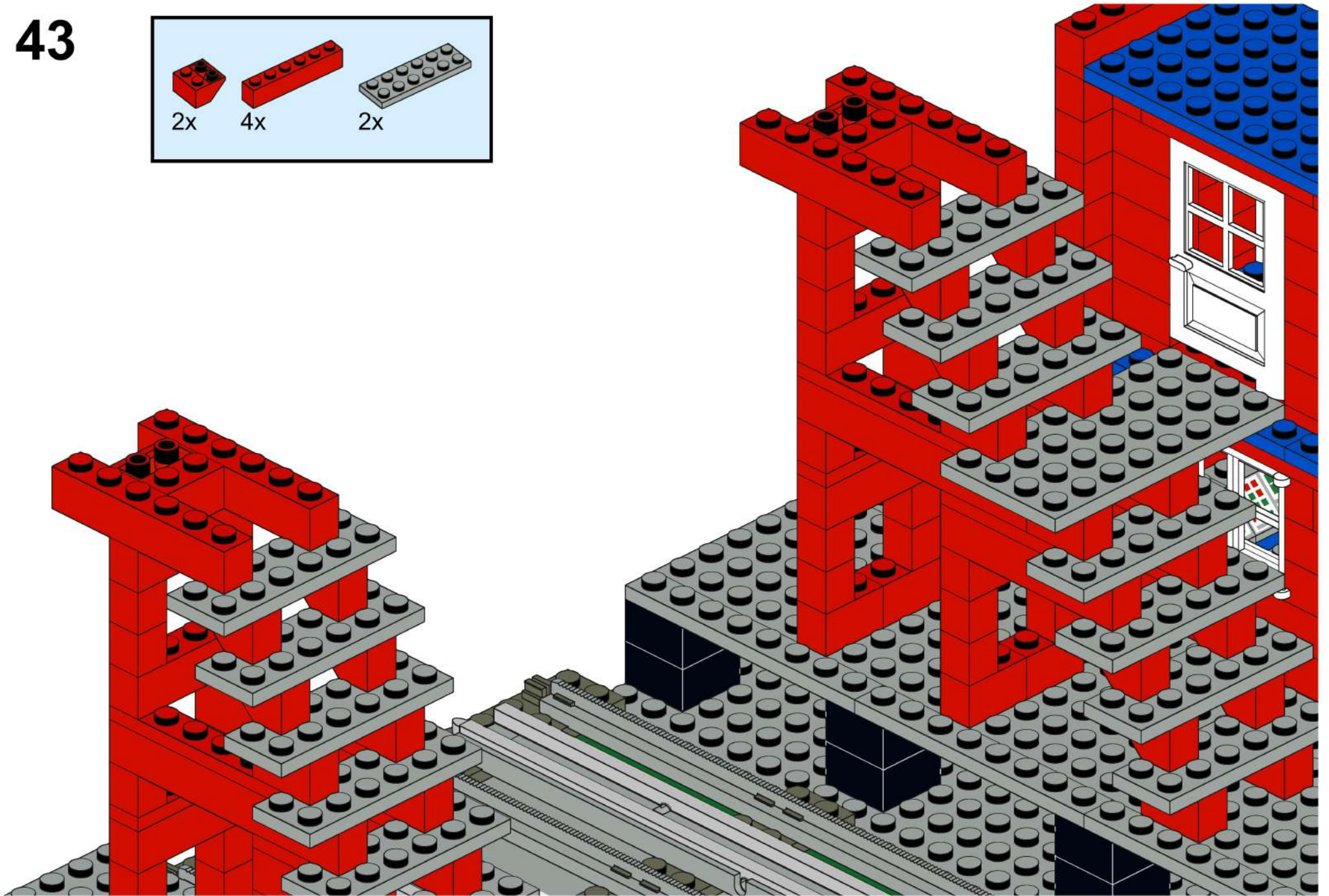
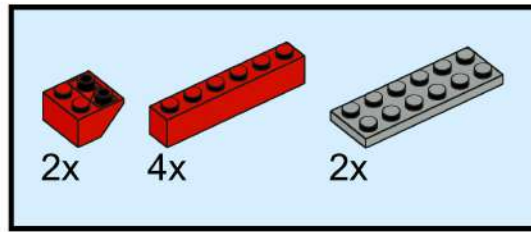

44

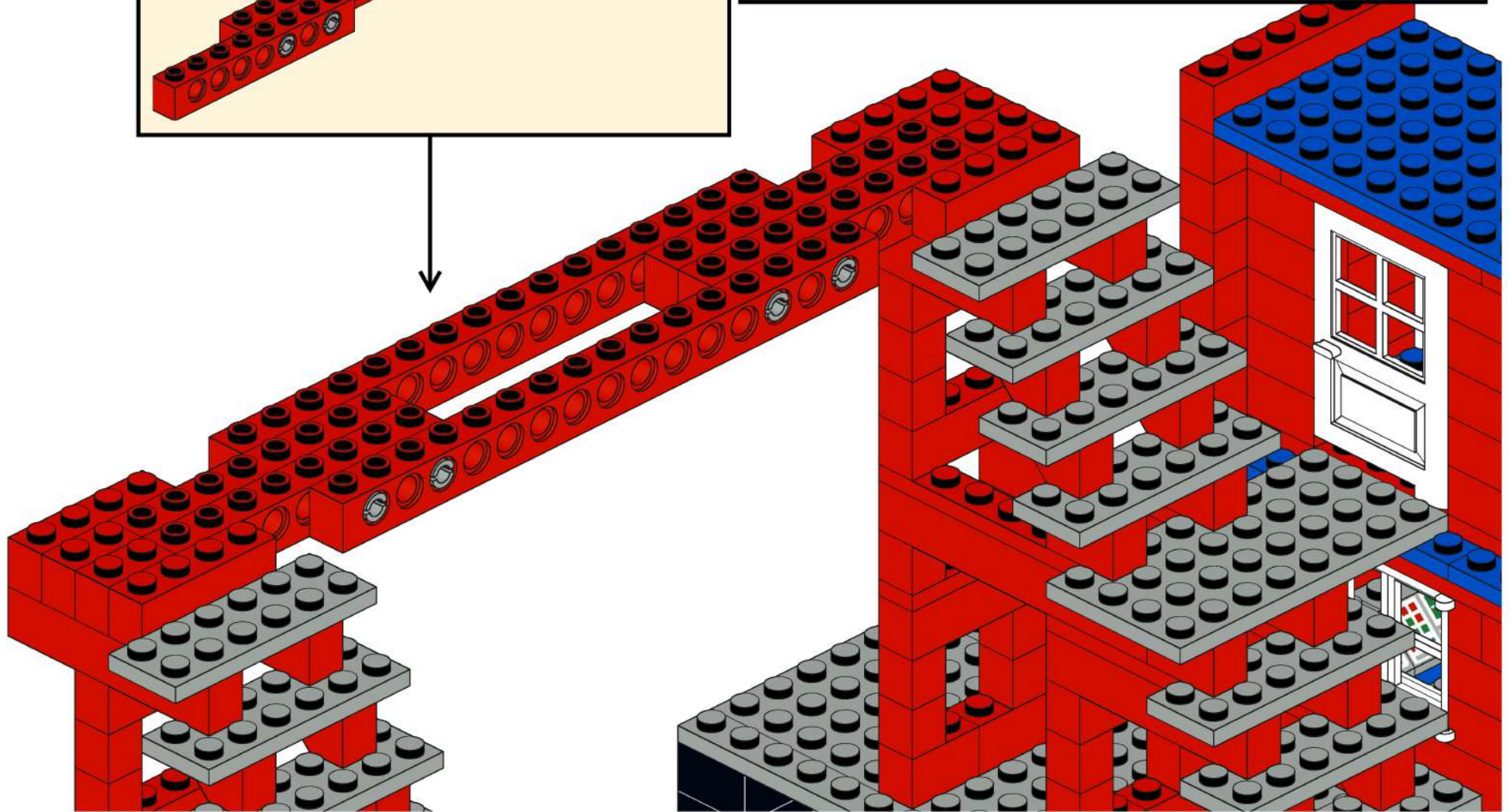
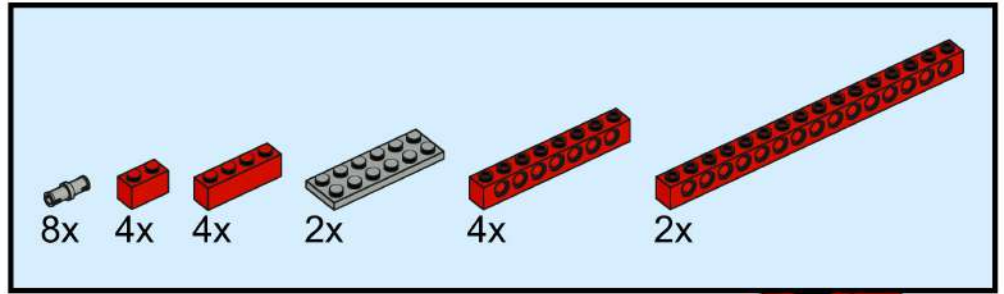
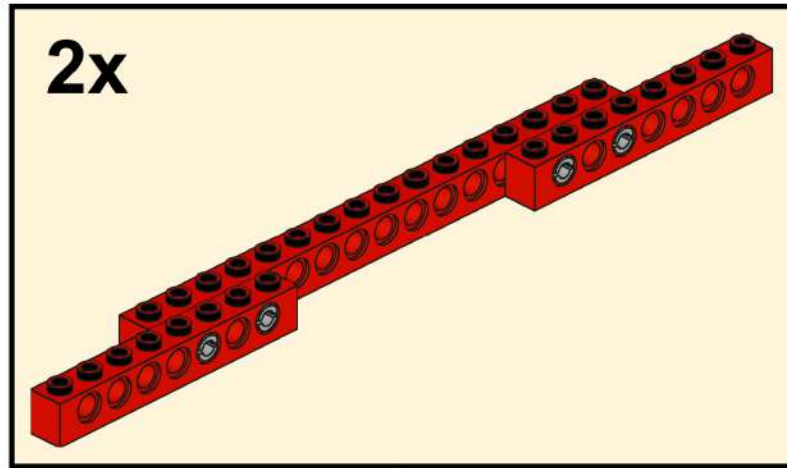

45

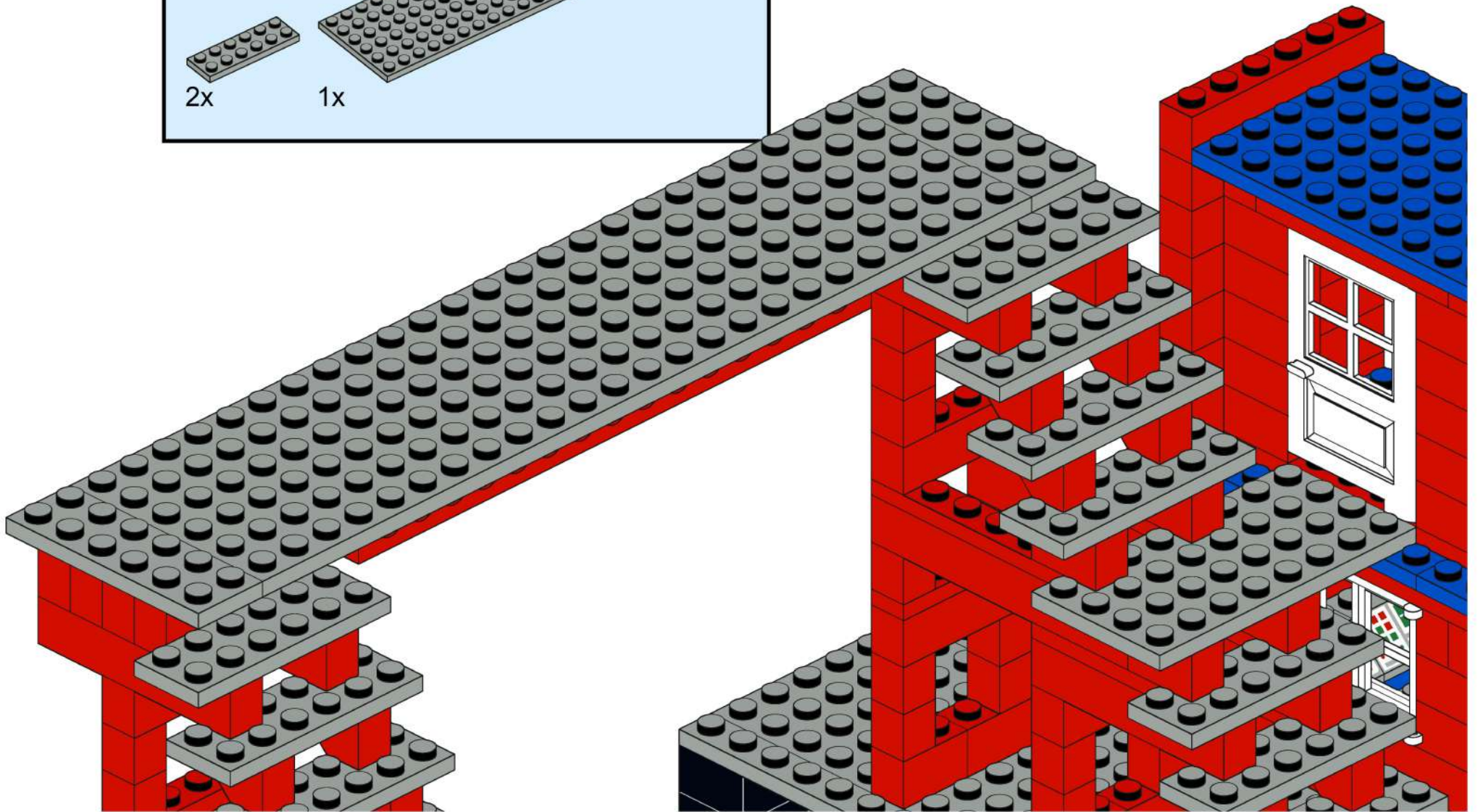
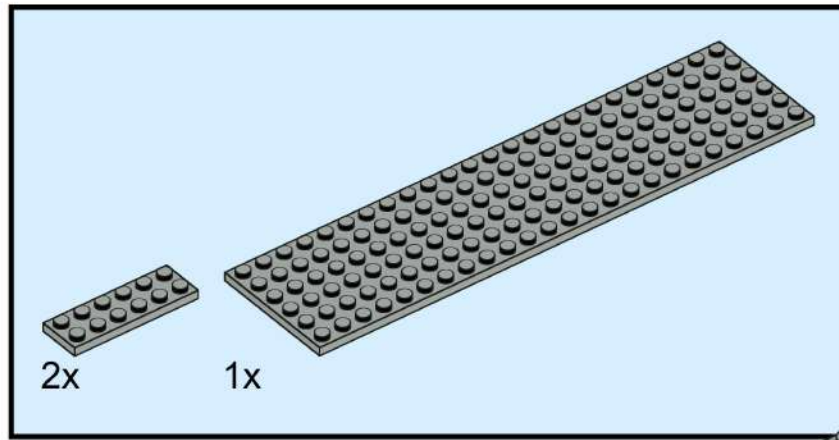

46

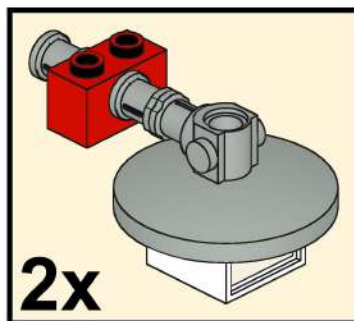
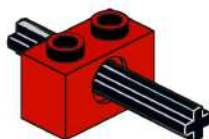
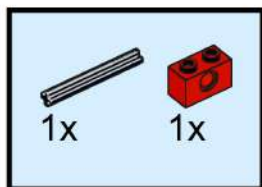

48

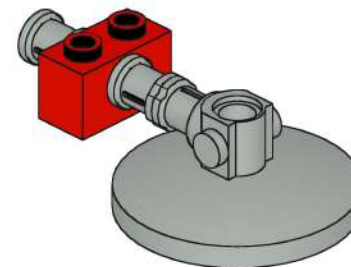
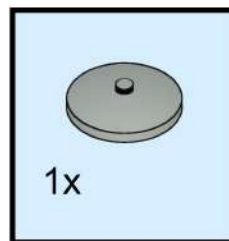

47

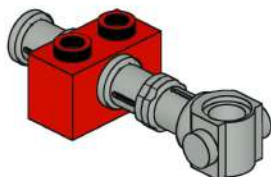
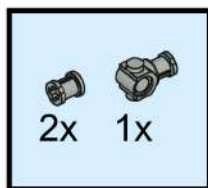

49

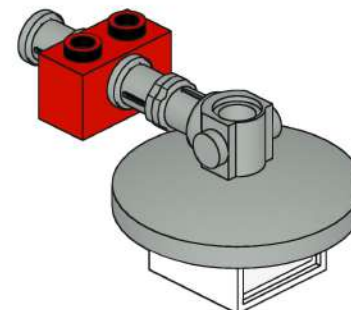
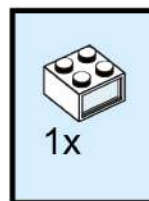

50

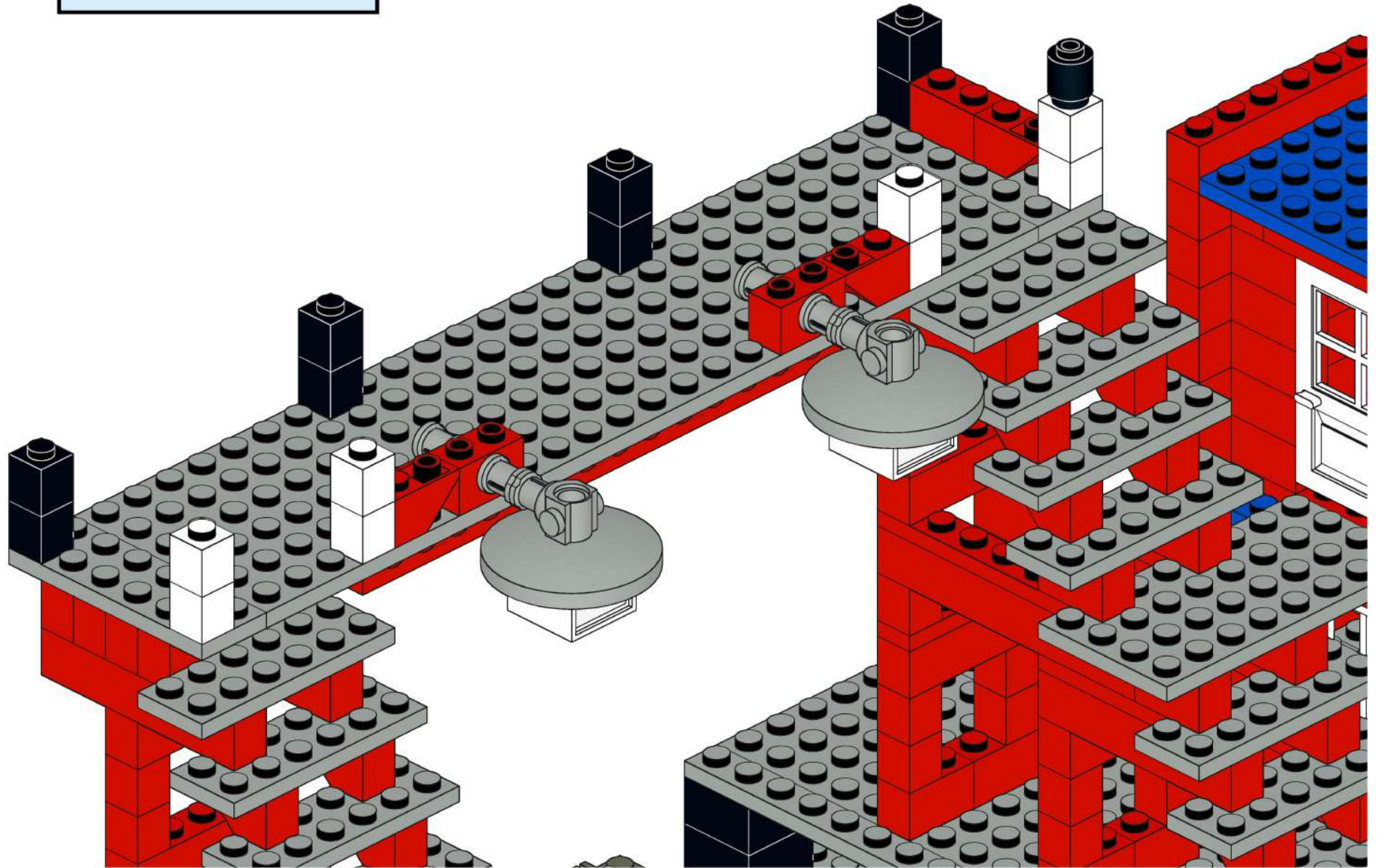
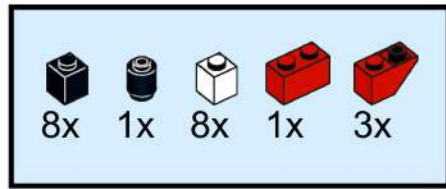

51

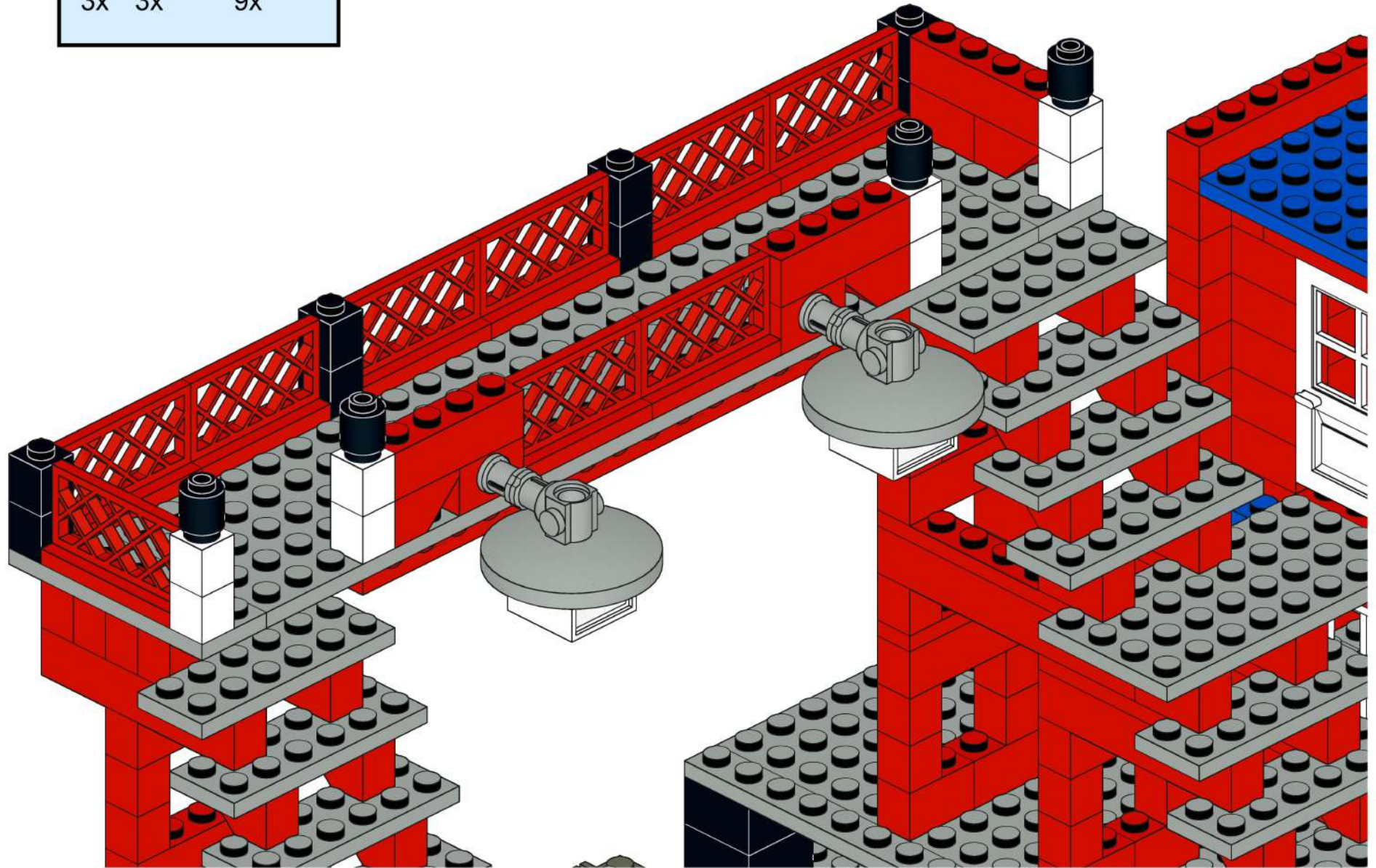
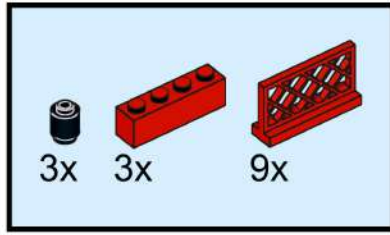

52

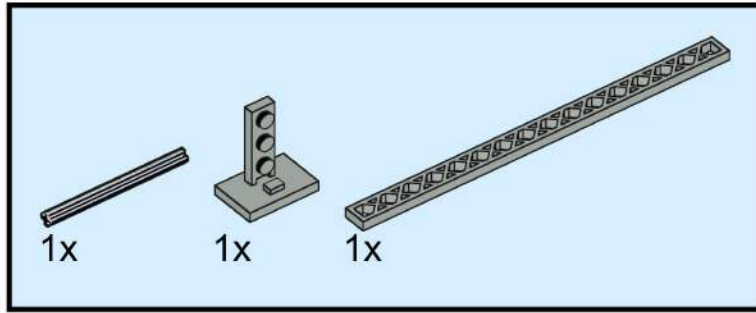

53

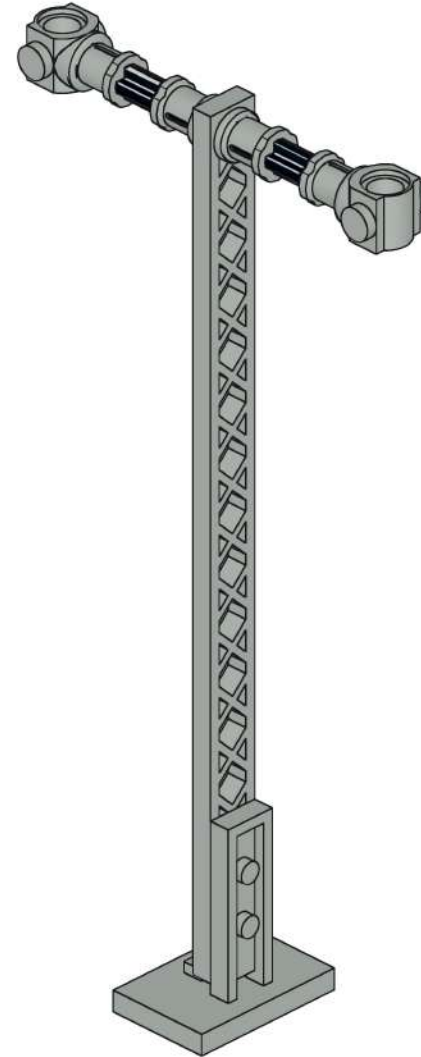
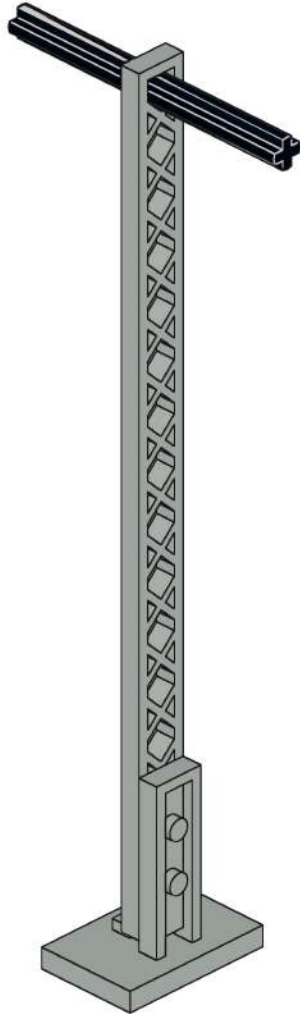
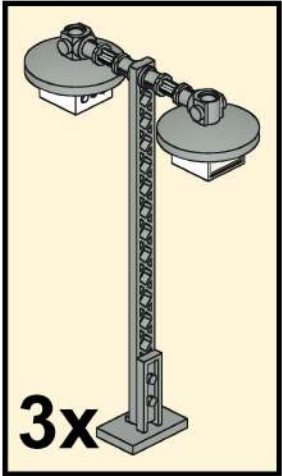
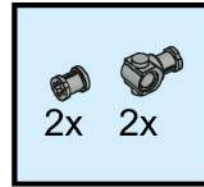

54

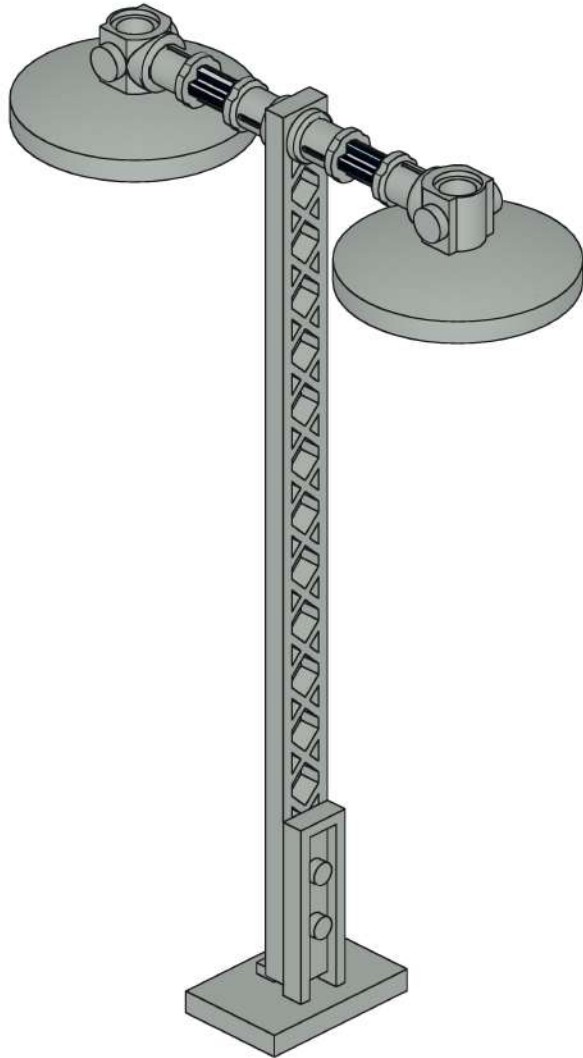
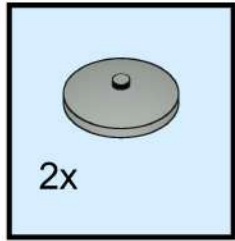

55

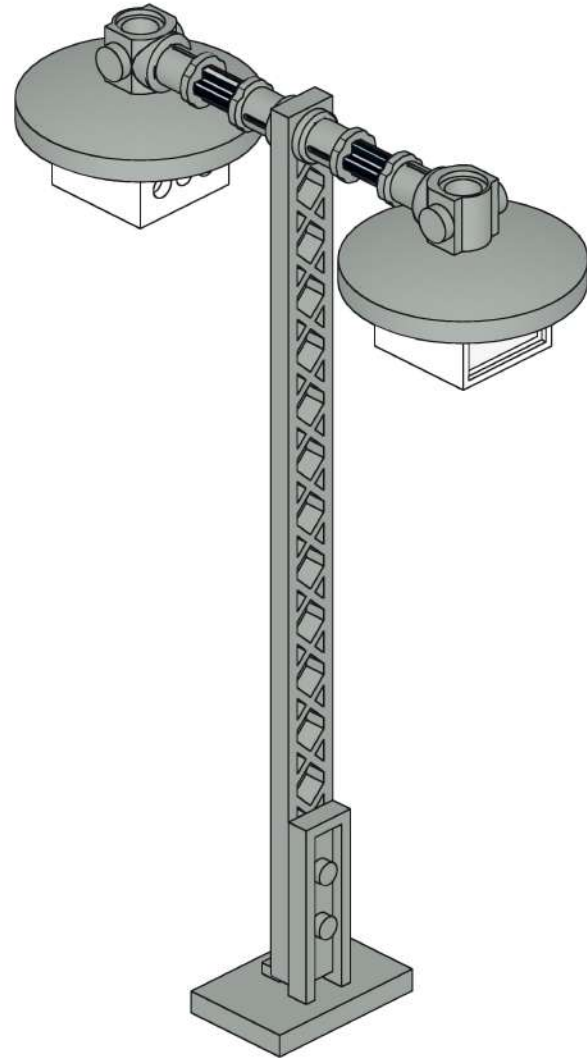
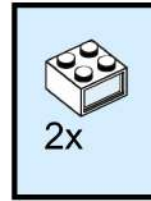

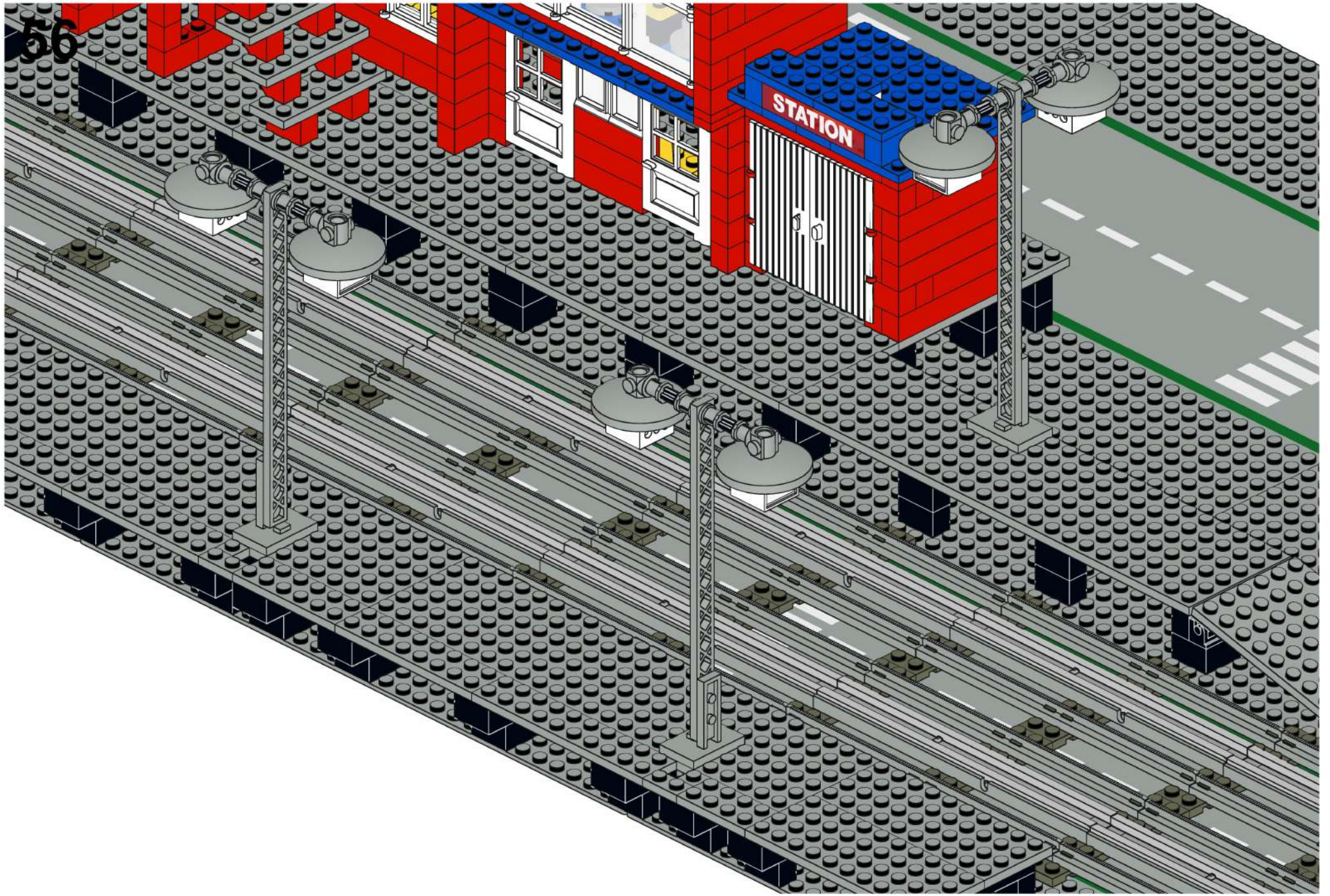

- 1x 3024 Black
- 58x 3003 Black
- 4x 3062b Black
- 1x 3622 Black
- 10x 3005 Black
- 1x 3023 Black
- 2x 3937 Black
- 2x 3938 Black
- 1x 3040 Black
- 38x 3004 Black
- 2x 3024 Light Gray
- 10x 3713 Light Gray
- 8x 3673 Light Gray
- 2x 3023 Light Gray
- 8x 3960 Light Gray
- 8x 3651 Light Gray
- 1x 3039p23 Light Gray
- 1x 3039p34 Light Gray
- 2x 3940b Light Gray
- 1x 3020 Light Gray
- 3x 4169 Light Gray
- 2x 3960 Light Gray
- 2x 3666 Light Gray
- 21x 3795 Light Gray
- 10x 3460 Light Gray
- 6x 3034 Light Gray
- 1x 3035 Light Gray
- 8x 3832 Light Gray
- 3x 3030 Light Gray
- 1x 3033 Light Gray
- 24x 3228b Light Gray
- 3x 4168 Light Gray
- 12x 3242 Light Gray
- 9x 3026 Light Gray
- 26x 4166 Dark Gray

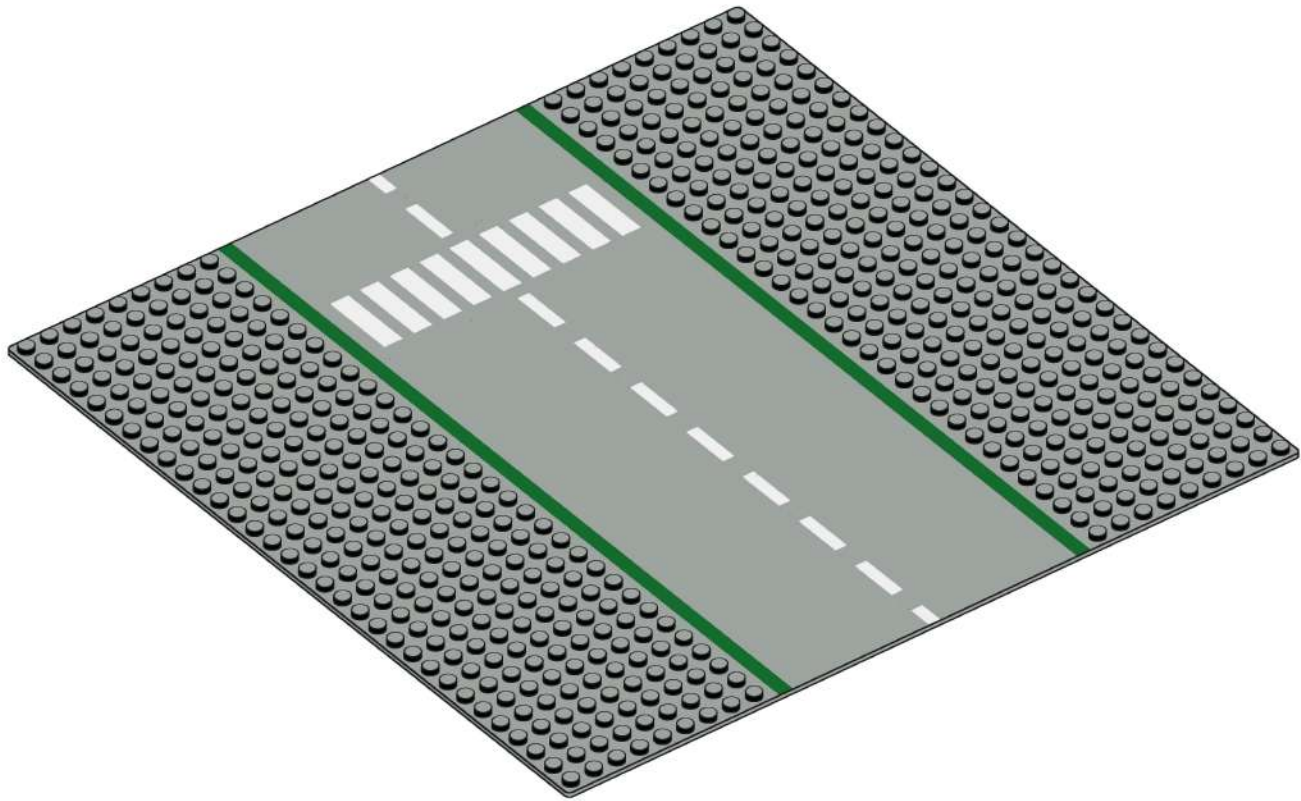

6x
606p02
Light Gray



8x
3005
White



2x
3004pb005
White



1x
3004
White



2x
3022
White



12x
08010bc01
White



2x
7026
White



4x
3854
White



9x
3853
White



3x
3861
White



2x
3644
White



1x
3008pb013
White



2x
3024
Red



68x
3005
Red



2x
3899
Red



10x
3023
Red



66x
3004
Red



24x
3665
Red



2x
3700
Red



2x
3581
Red



3x
3660
Red



23x
3622
Red



4x
3710
Red



42x
3010
Red



4x
3702
Red



2x
3020
Yellow

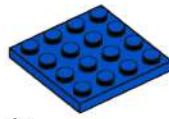

1x
3031
Blue

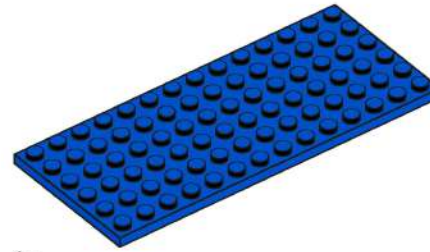

1x
3456
Blue



9x
3185
Red



4x
3703
Red



1x
3741
Green



1x
3032
Blue



1x
3024
Trans-Clear



12x
3666
Red



1x
3023
Blue



1x
3032
Blue

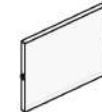

7x
3855
Trans-Clear

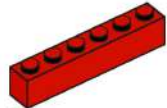

26x
3009
Red



3x
3742
Yellow



2x
3004
Blue



2x
3034
Blue



3x
3460
Red



2x
3023
Yellow



1x
3021
Blue



4x
3035
Blue



1x
3067pb08
Trans-Red



2x
3581
Yellow



1x
3010
Blue

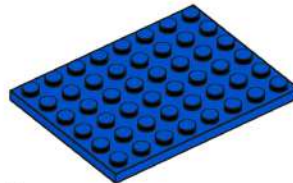

4x
3036
Blue

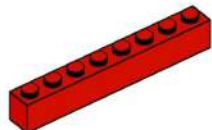

14x
3008
Red



5x
4079
Yellow



2x
3020
Blue



2x
3710
Yellow