

1

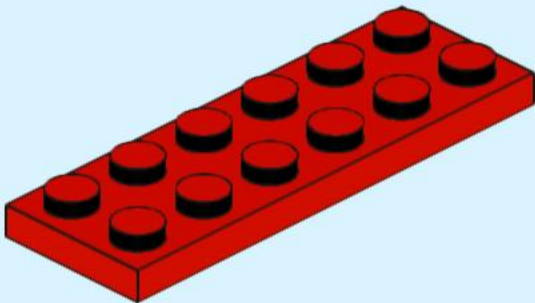

# 2

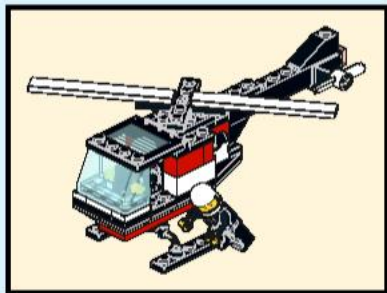
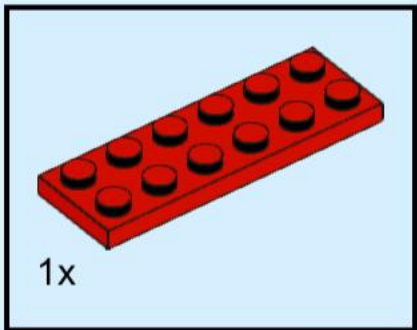
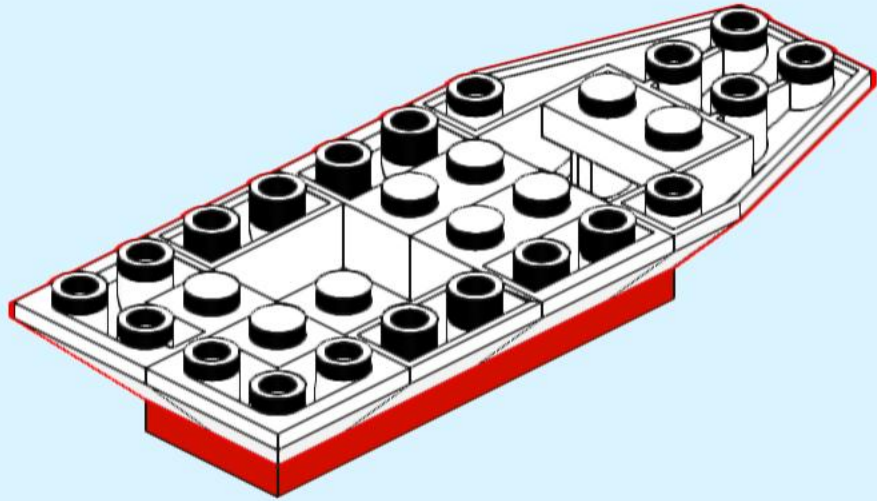
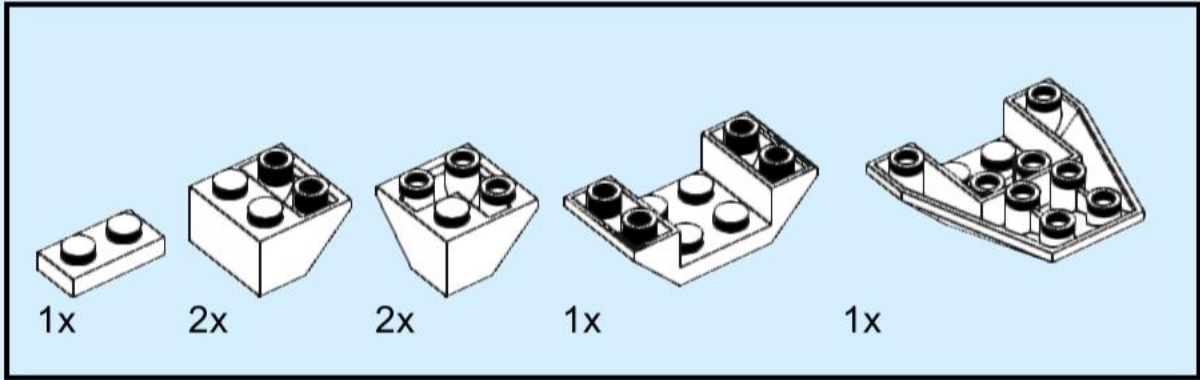

# 3

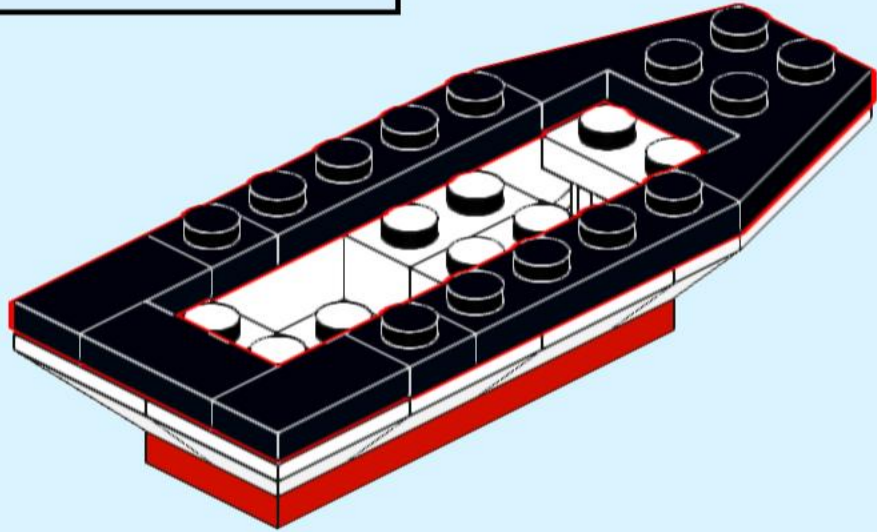
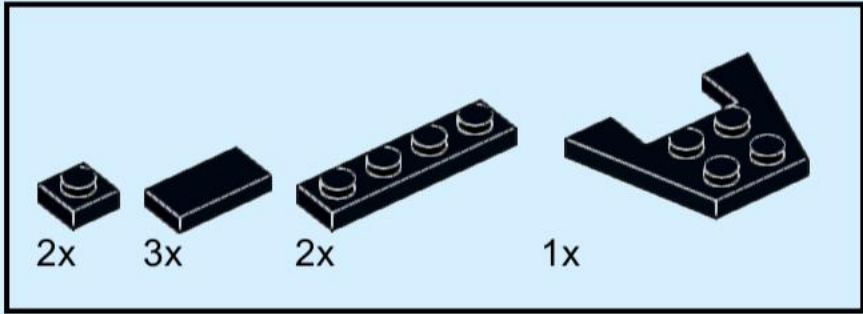

# 4

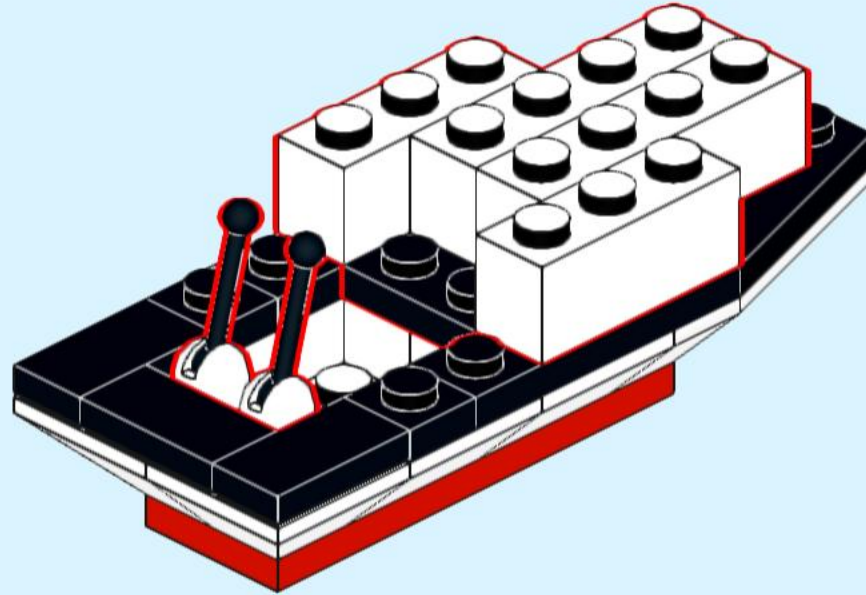
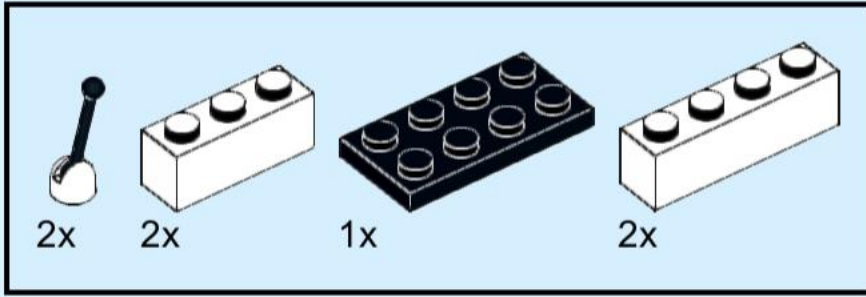

# 5

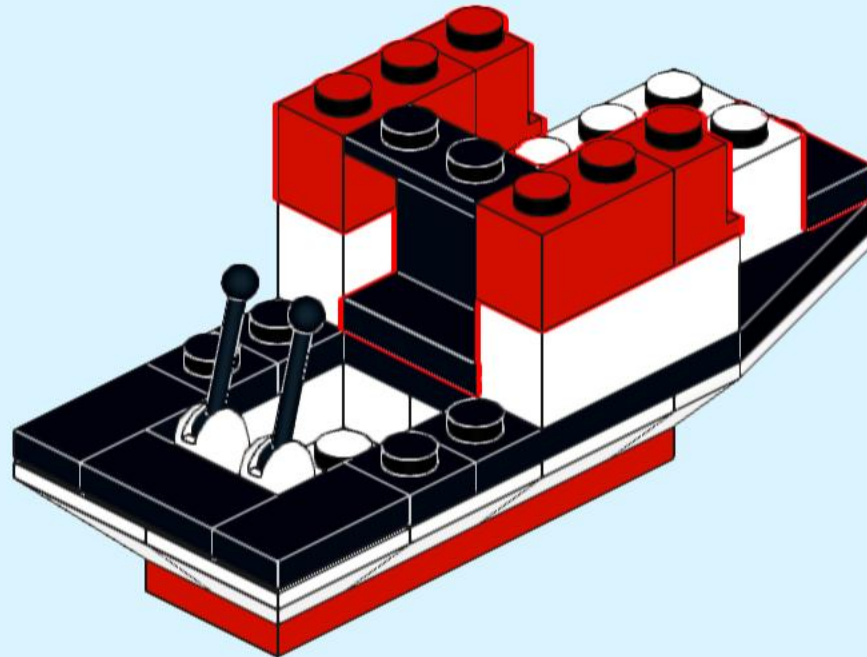
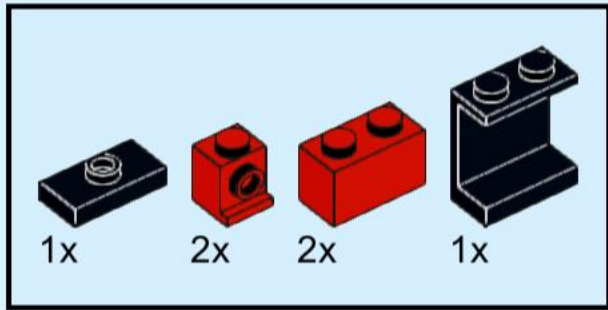

# 6

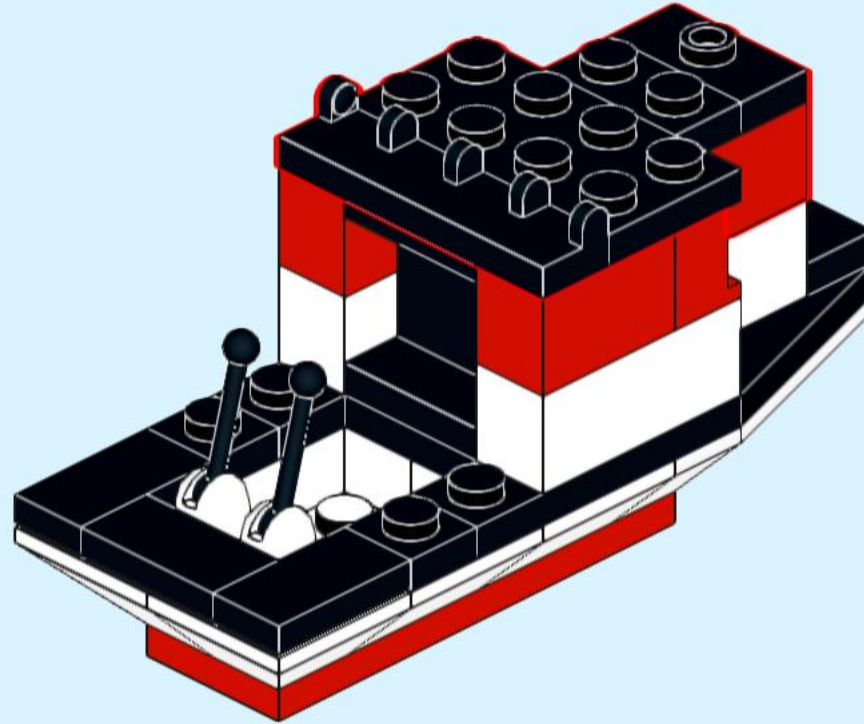
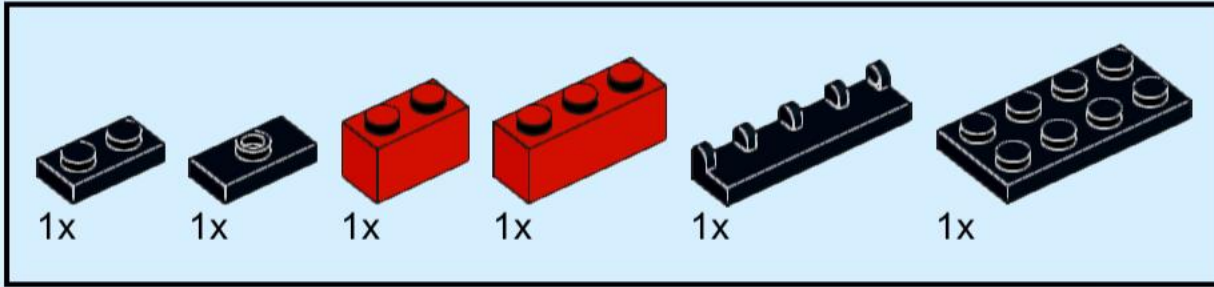

# 7

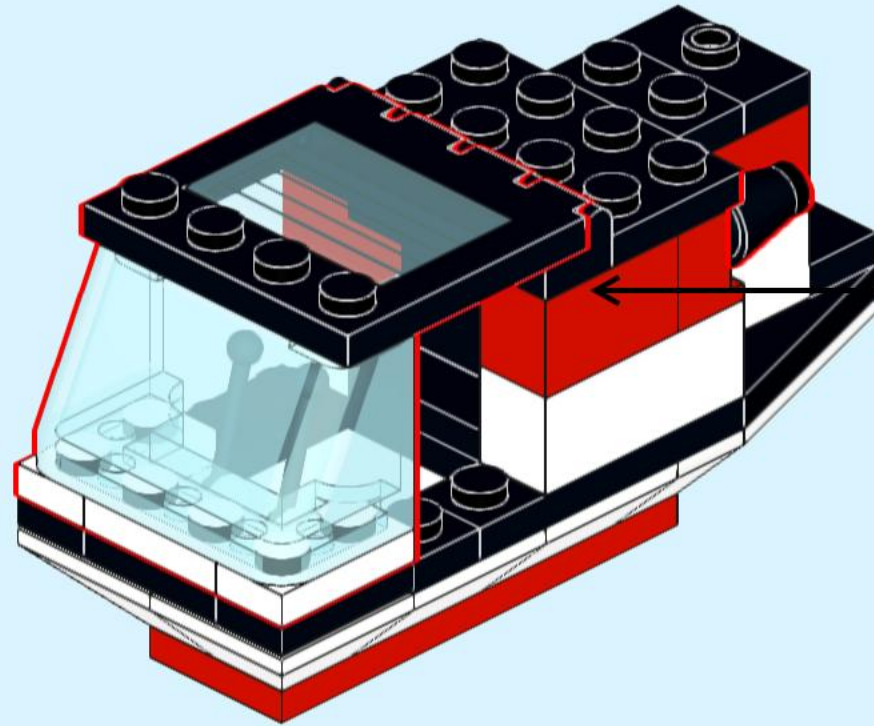

1

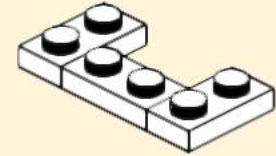

2

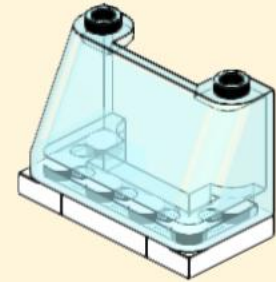

3

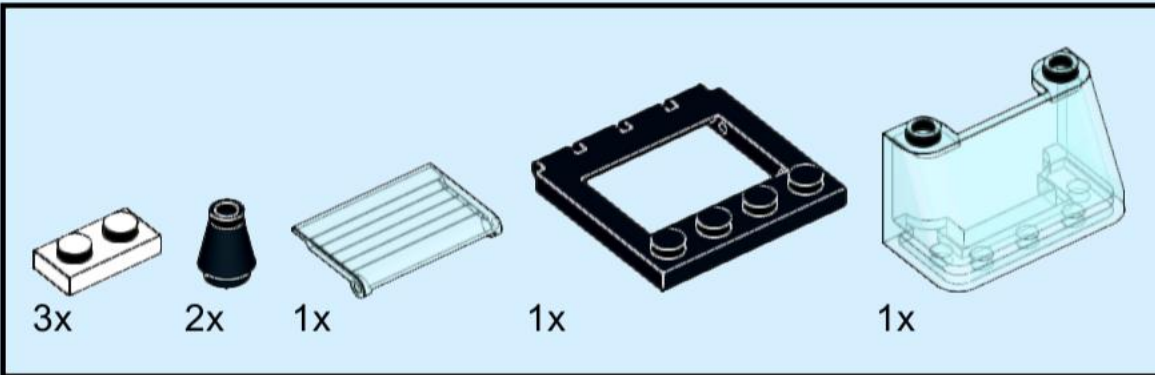
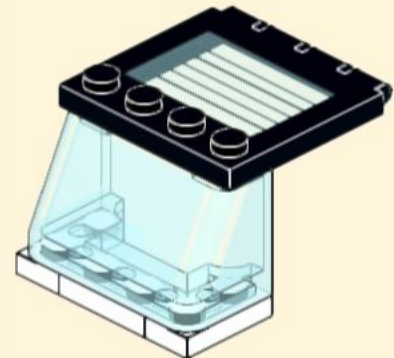

# 8

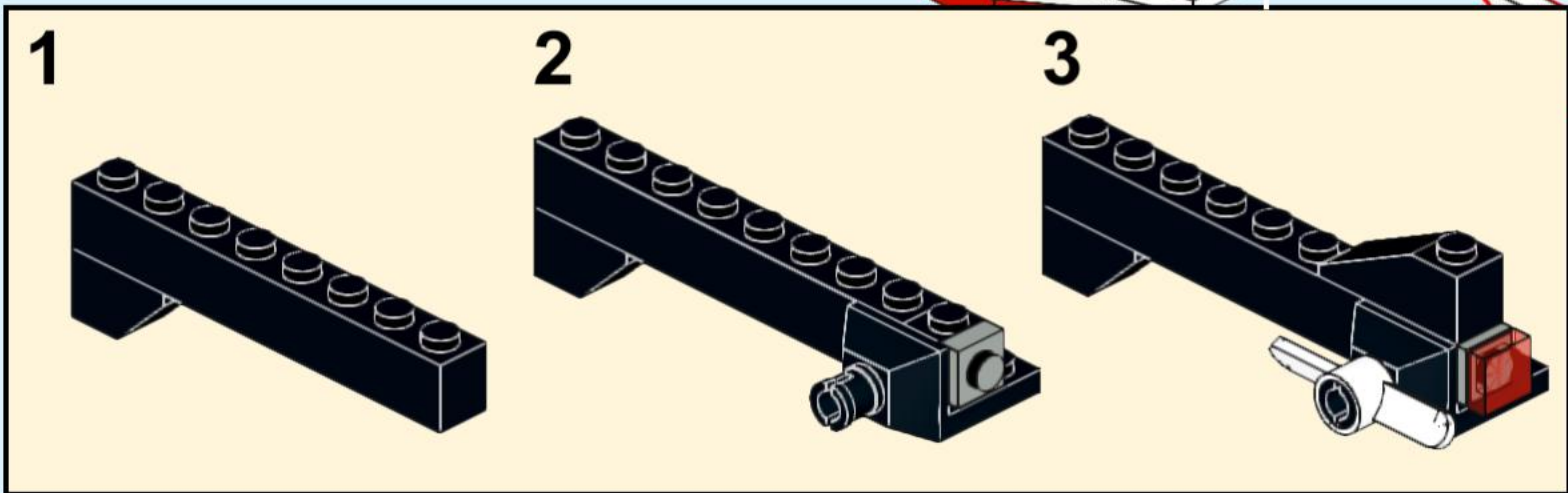
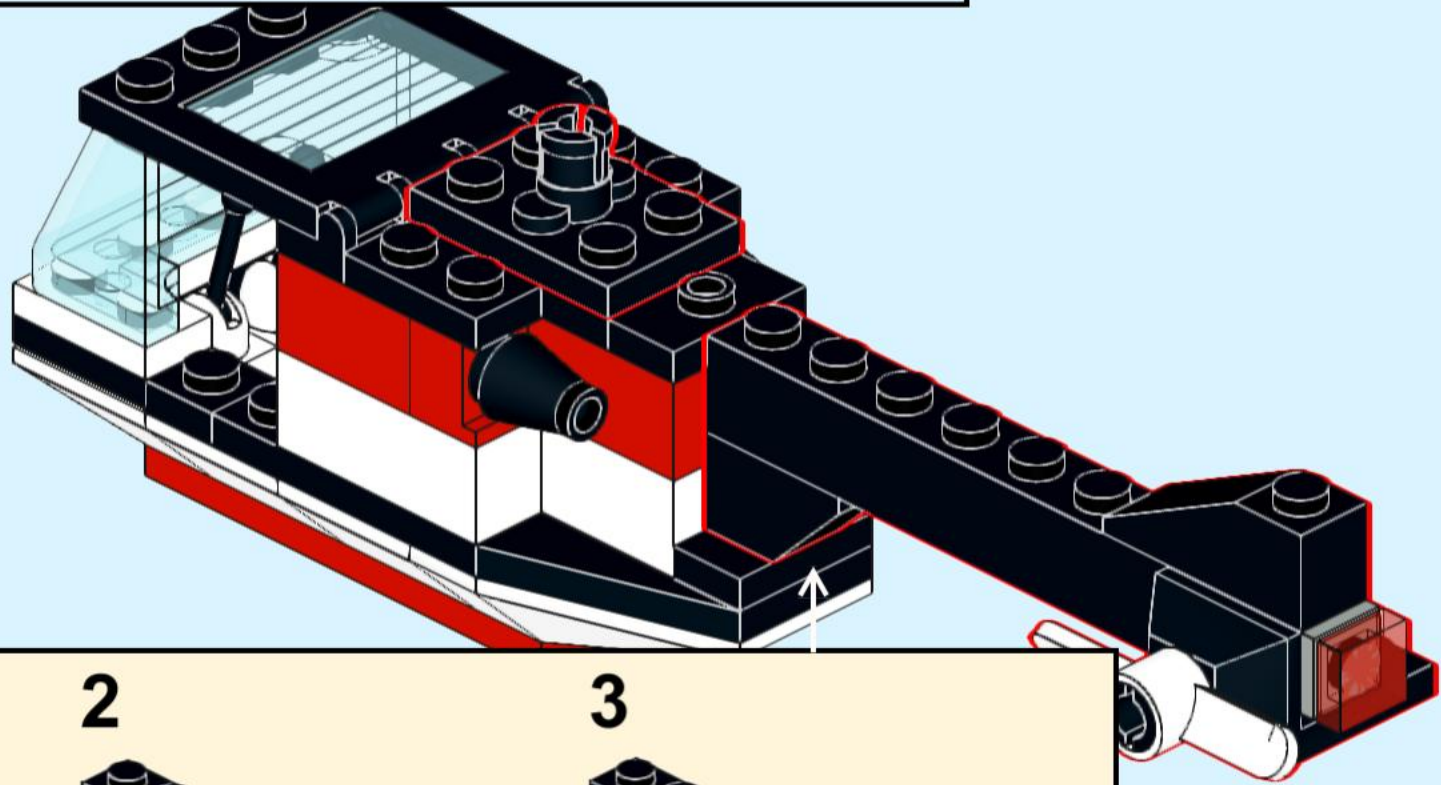
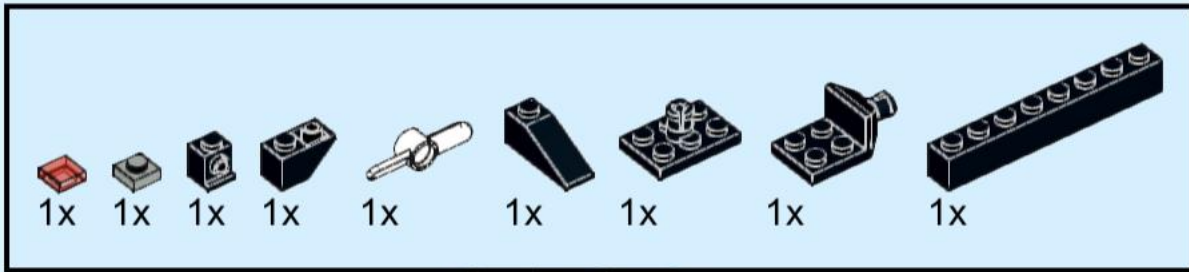





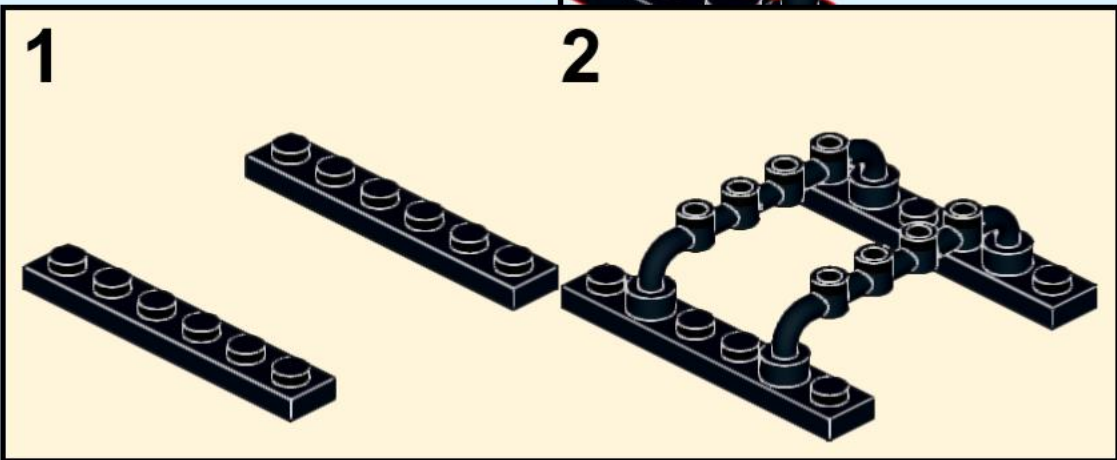
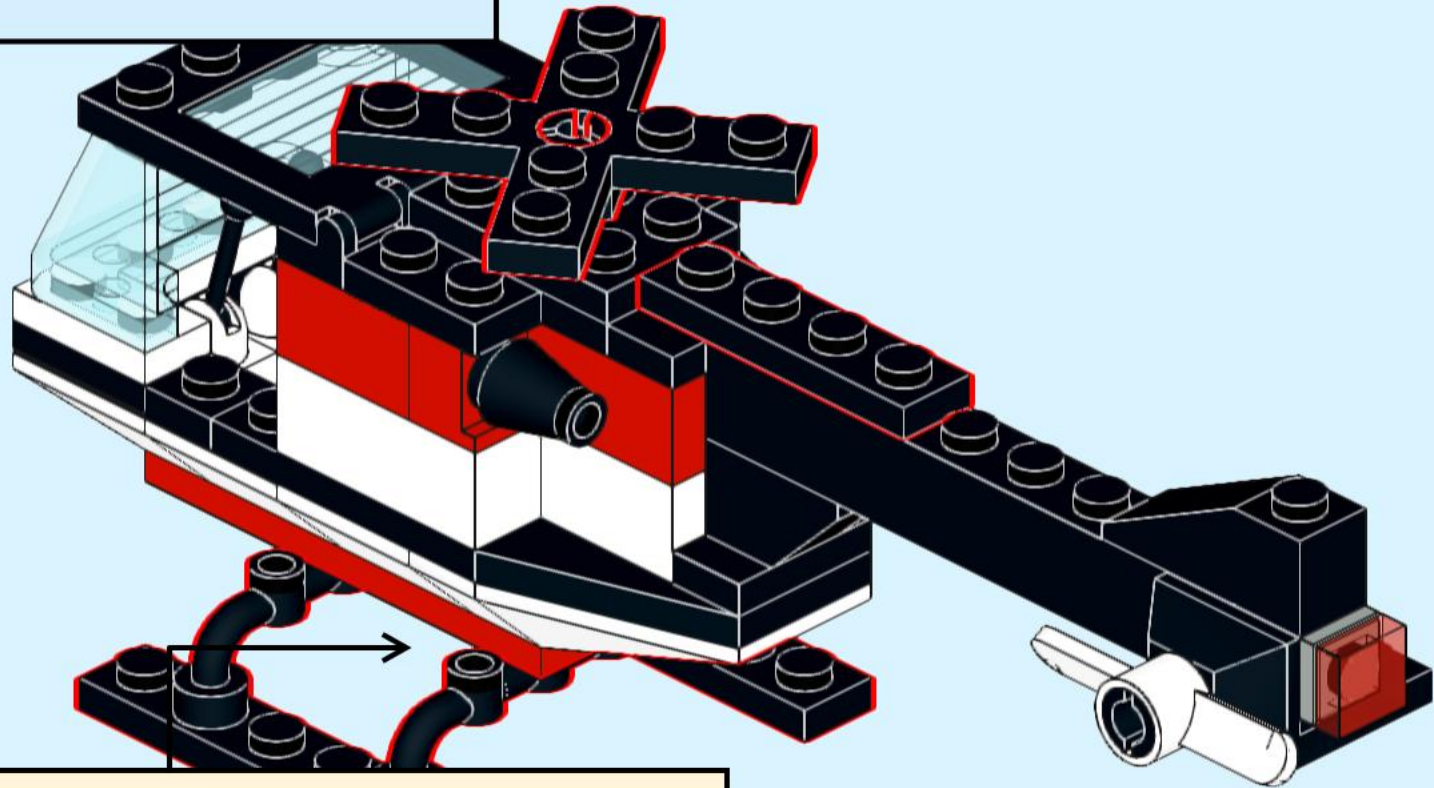
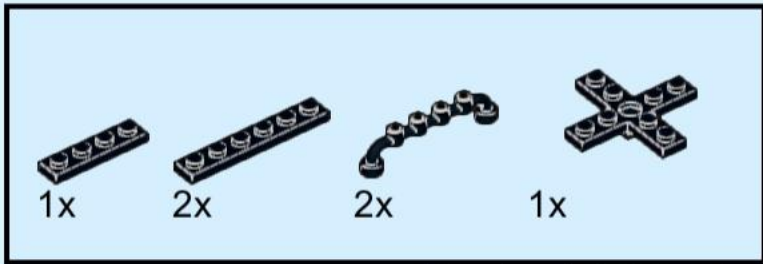



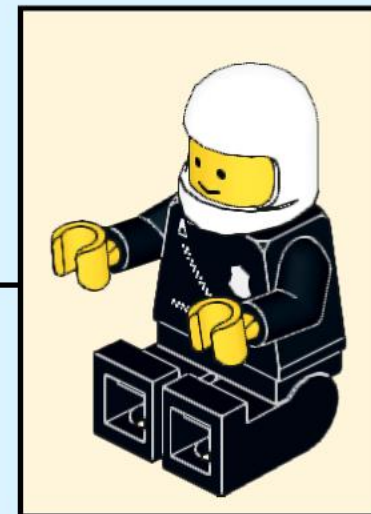
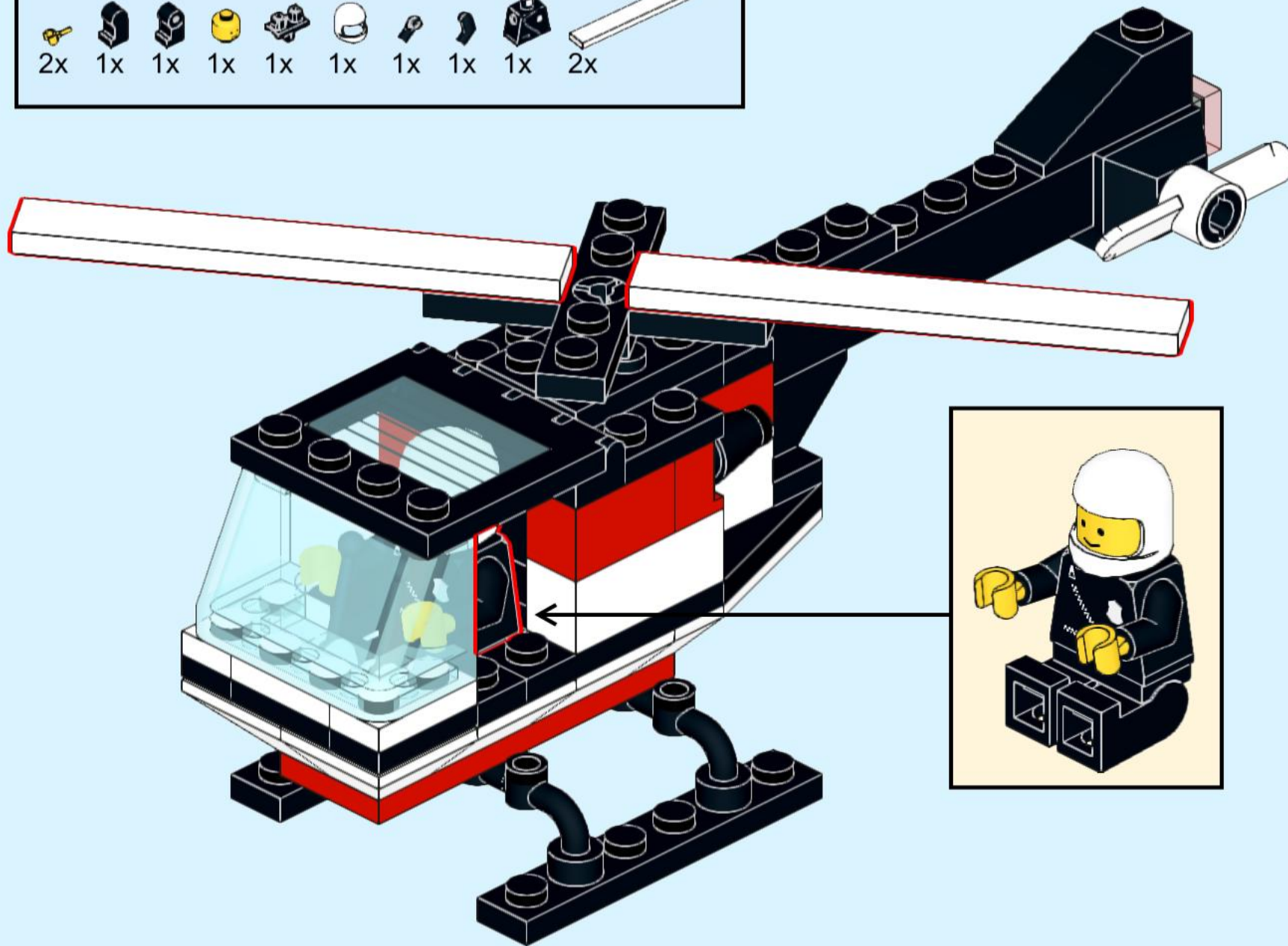

# 9



# 10



# 11

- 2x 
- 1x 
- 1x 
- 1x 
- 1x 
- 1x 
- 1x 
- 1x 
- 1x 

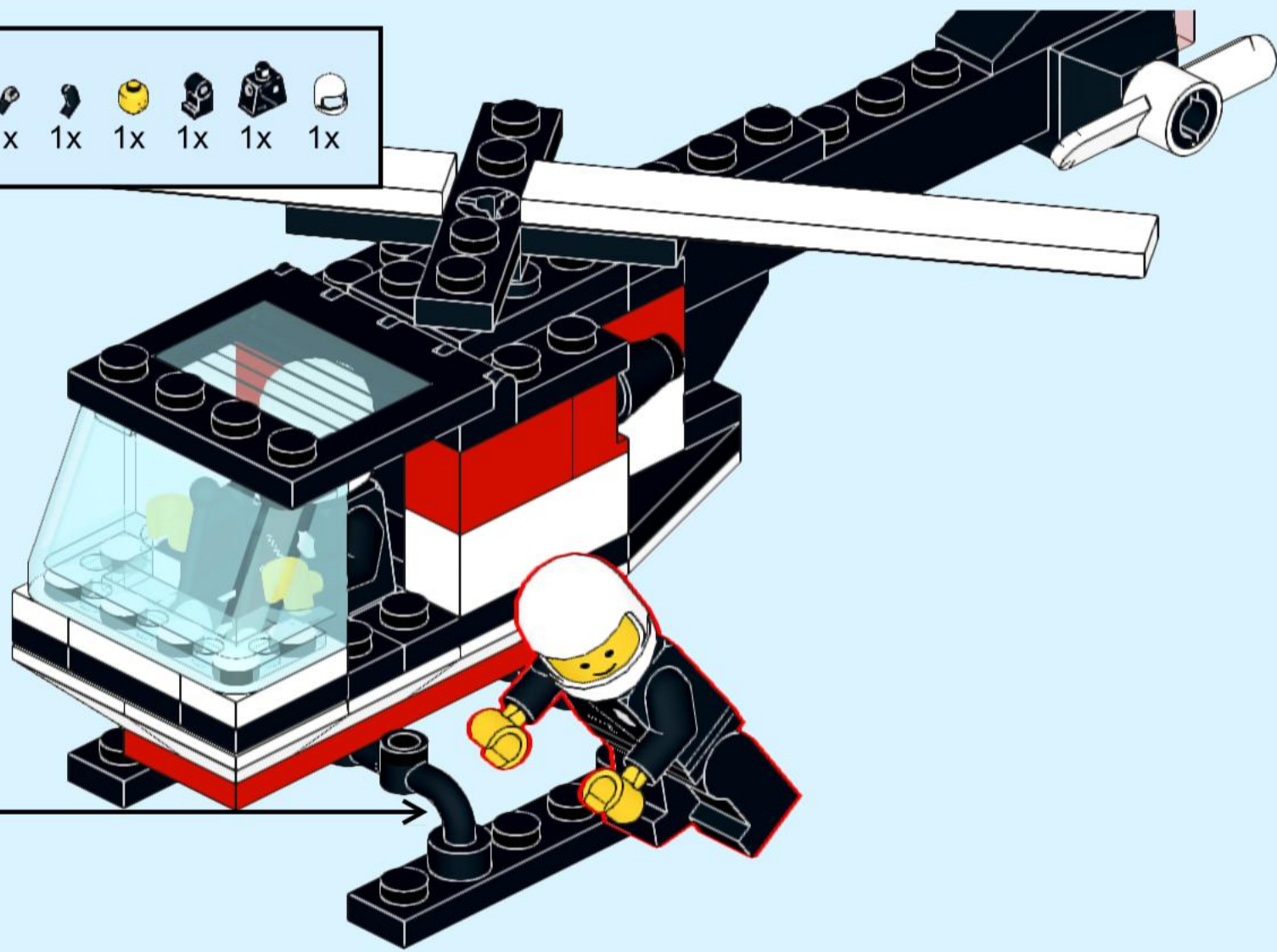

12

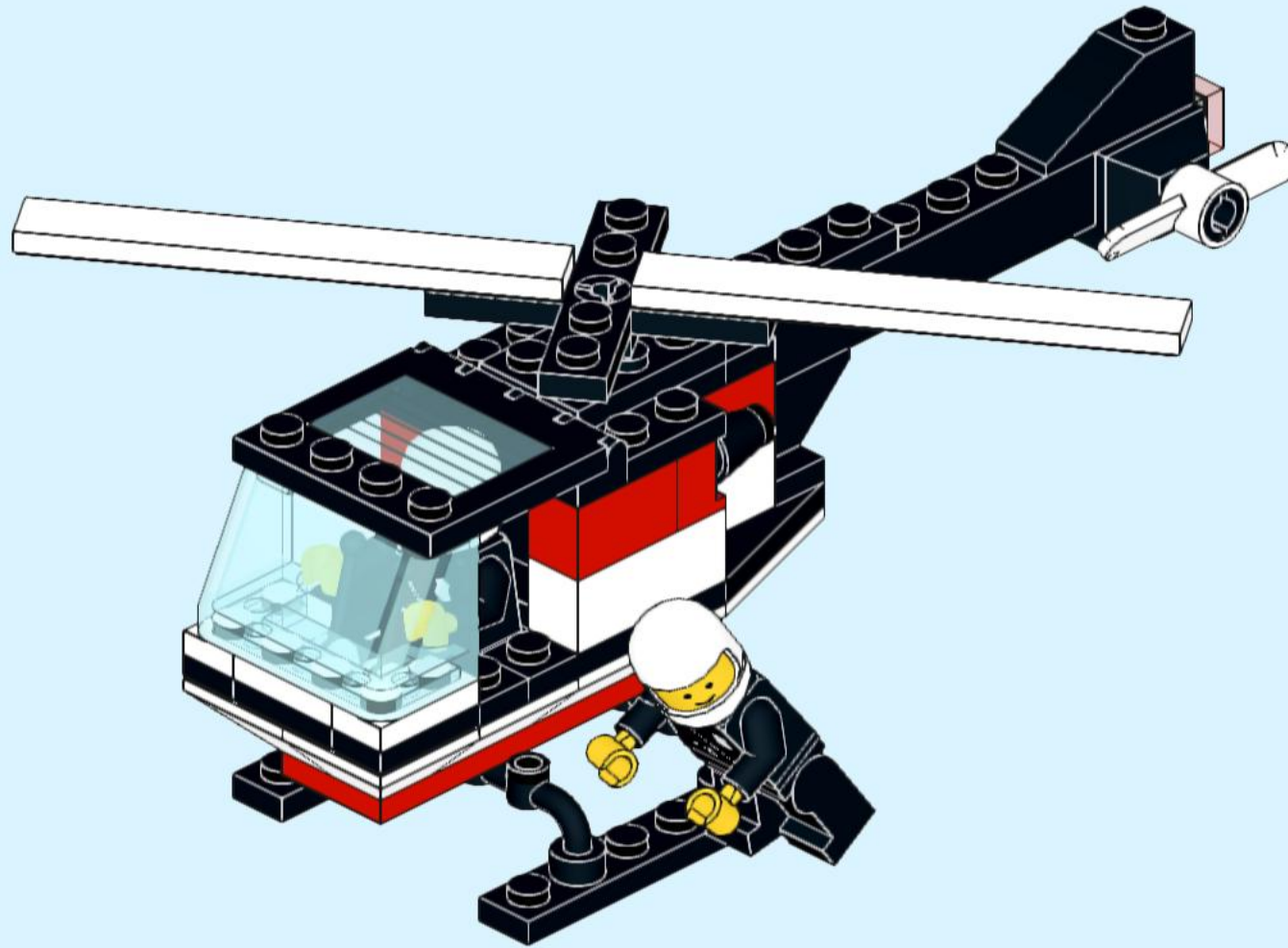

# 13

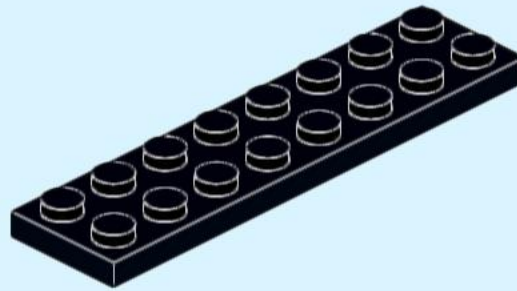
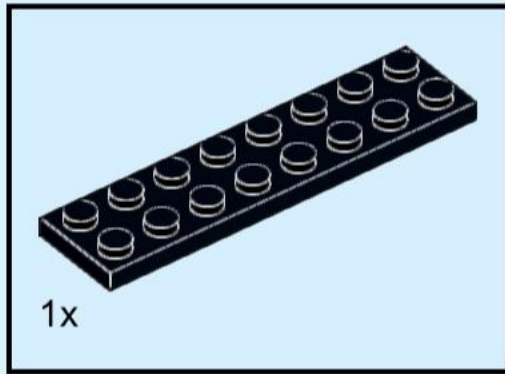

# 14

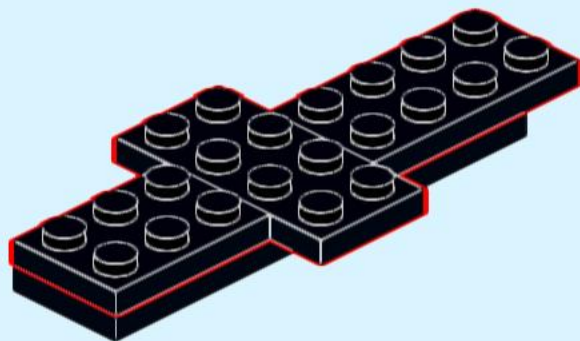
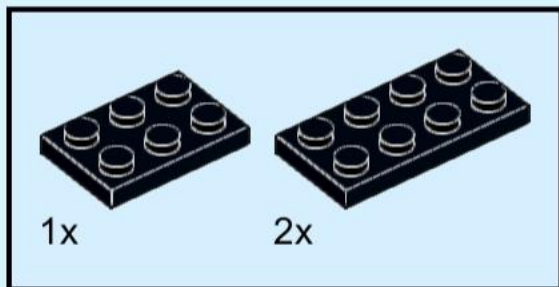

# 15

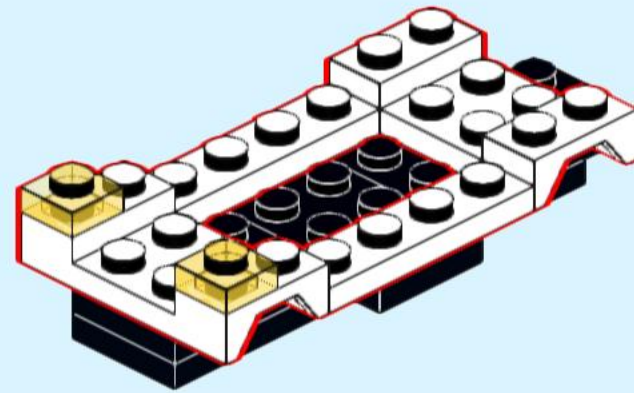
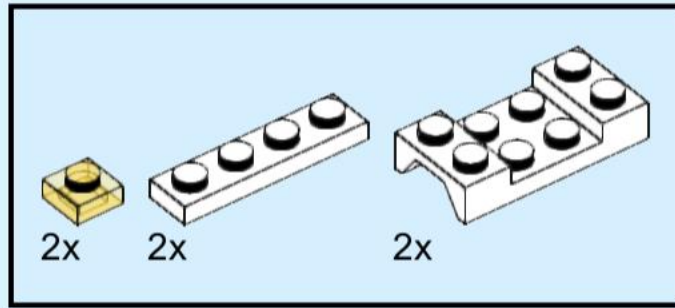

# 16

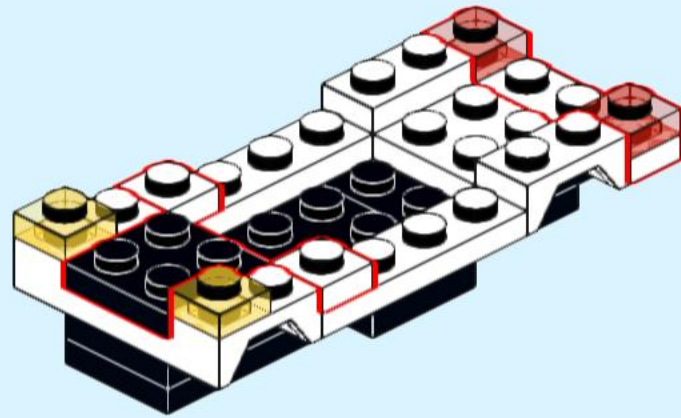
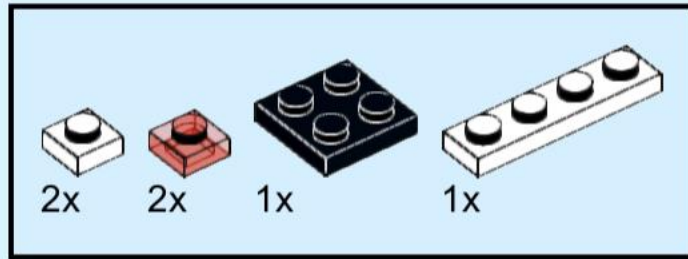



# 17

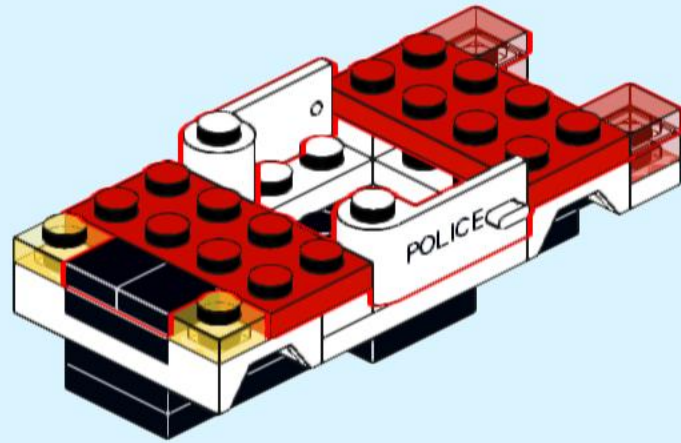
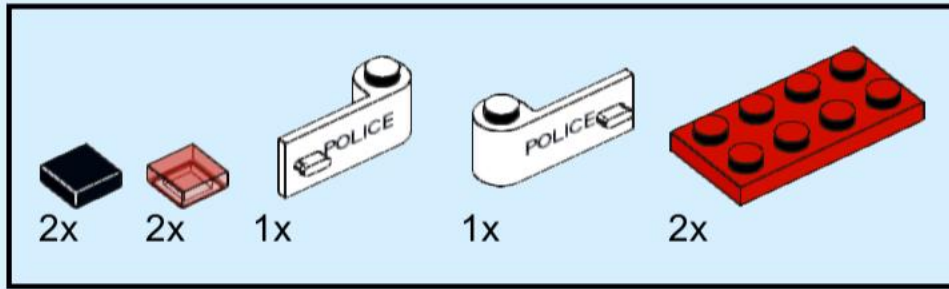

# 18

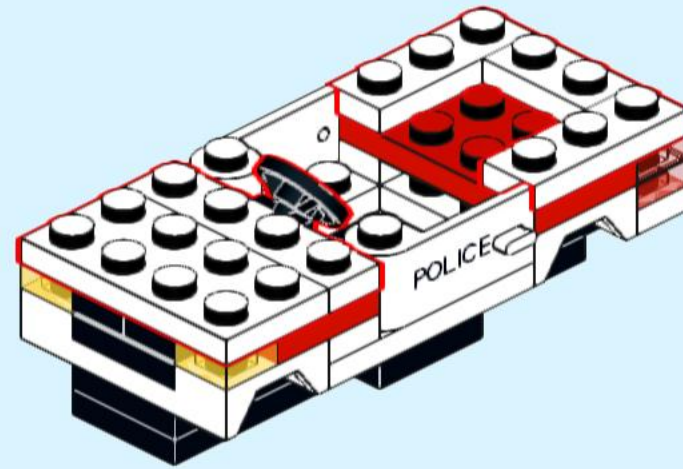
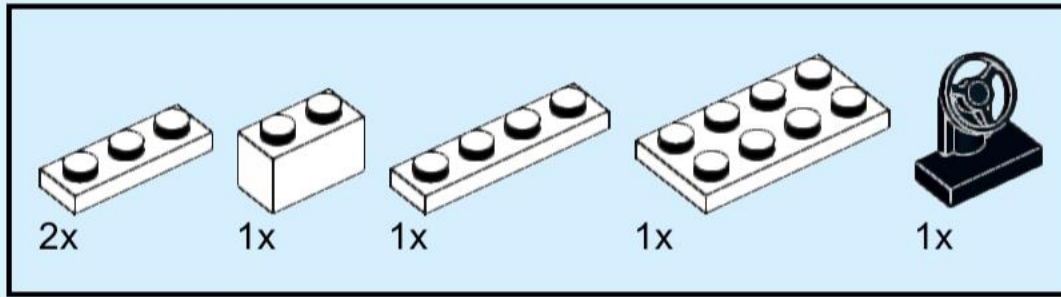

# 19

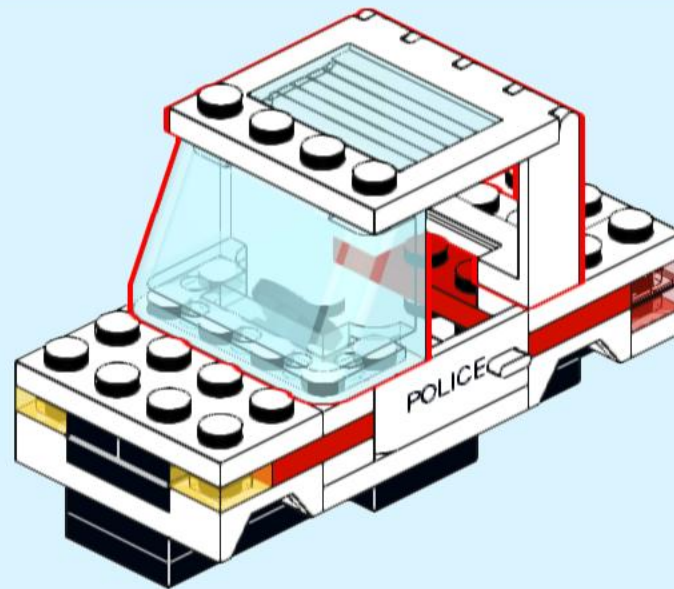
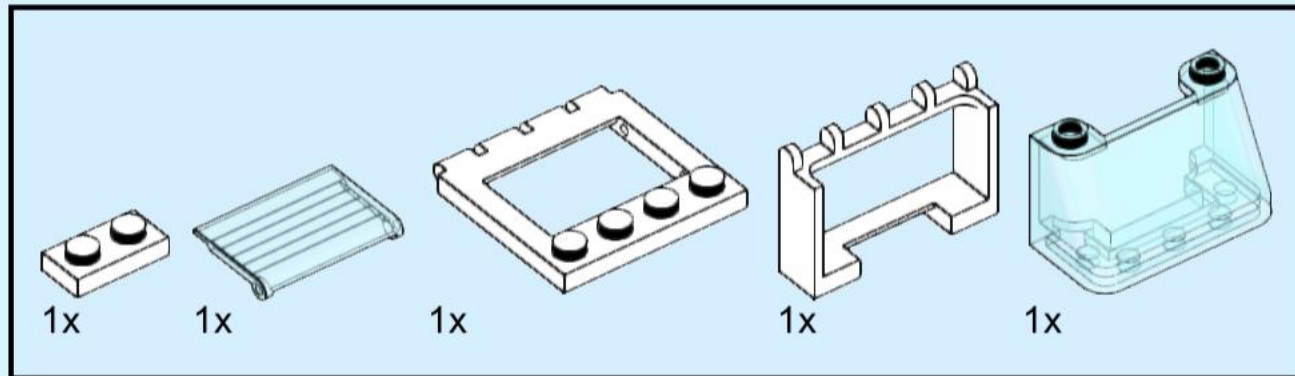

# 20

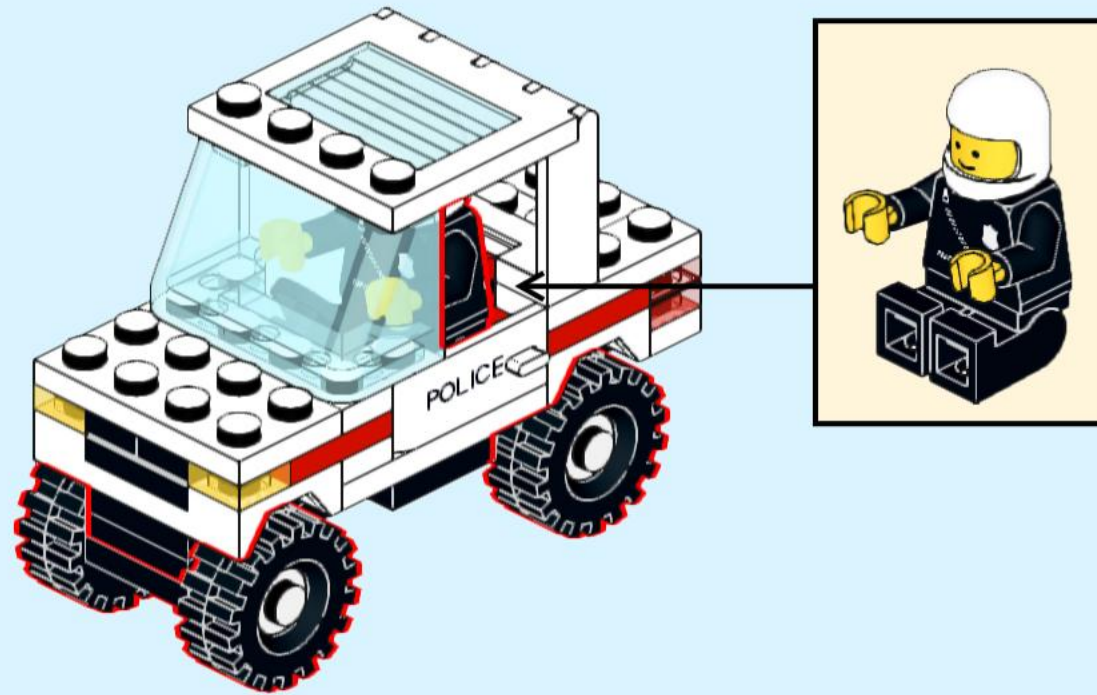
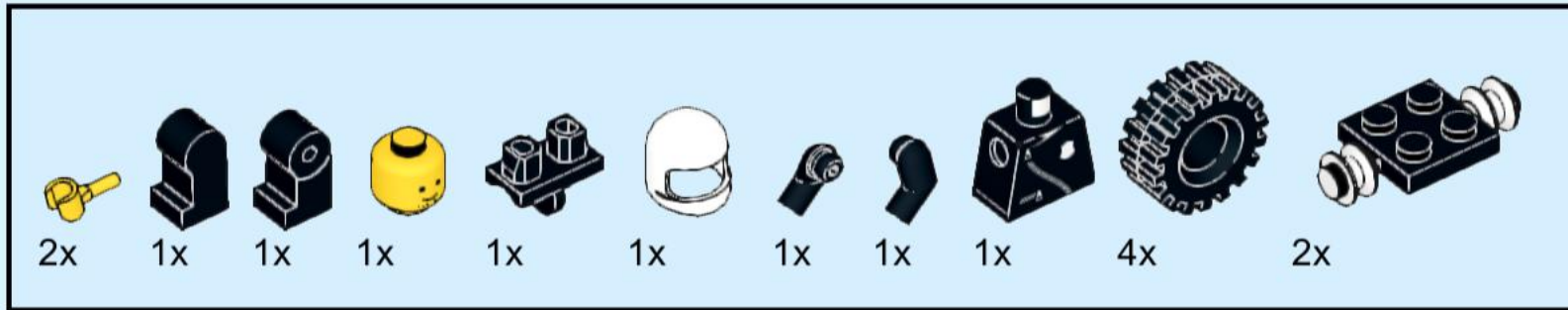

# 21

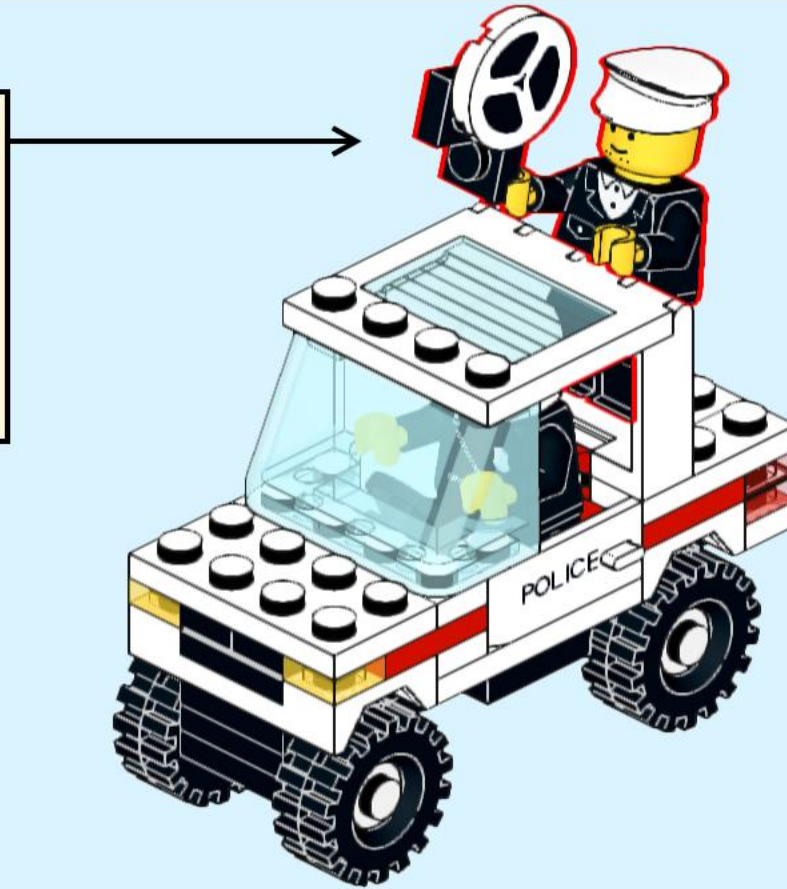
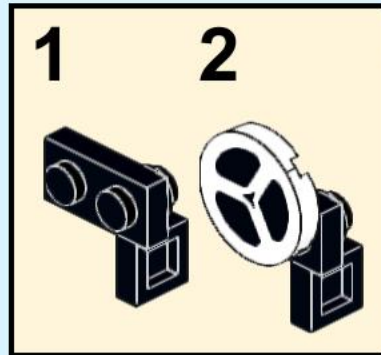
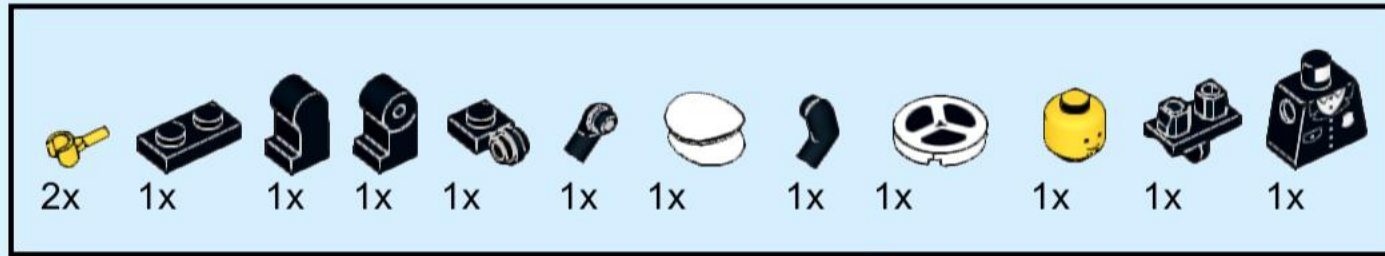

# 22

