

1

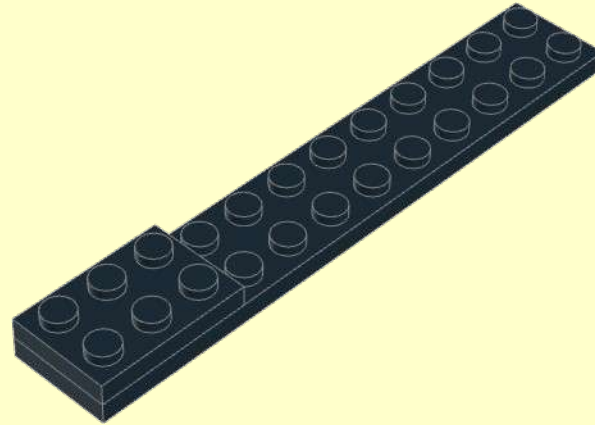

2

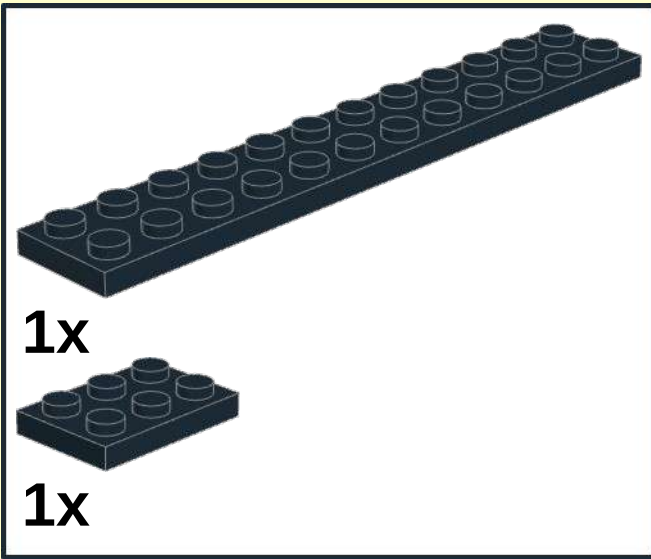
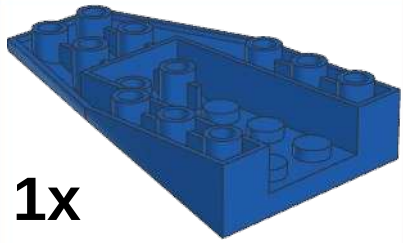

1x

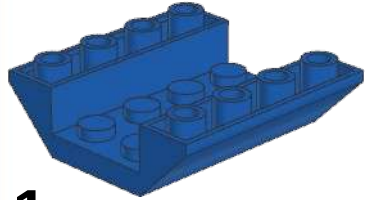

1x

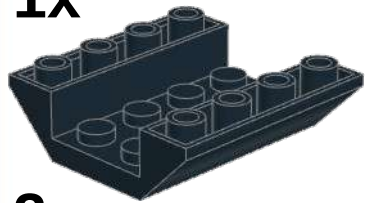

2x

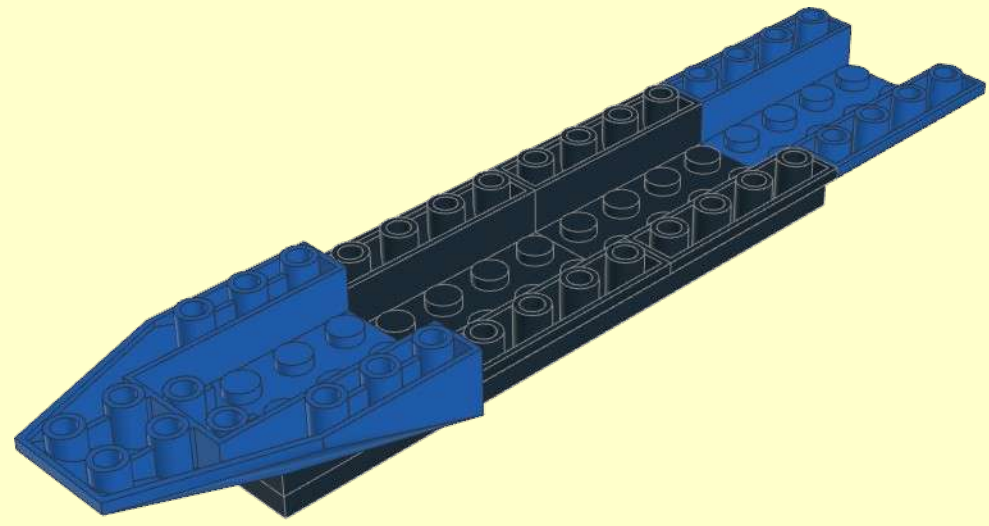

3



2x



1x

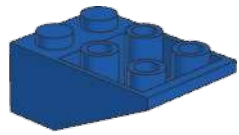

1x

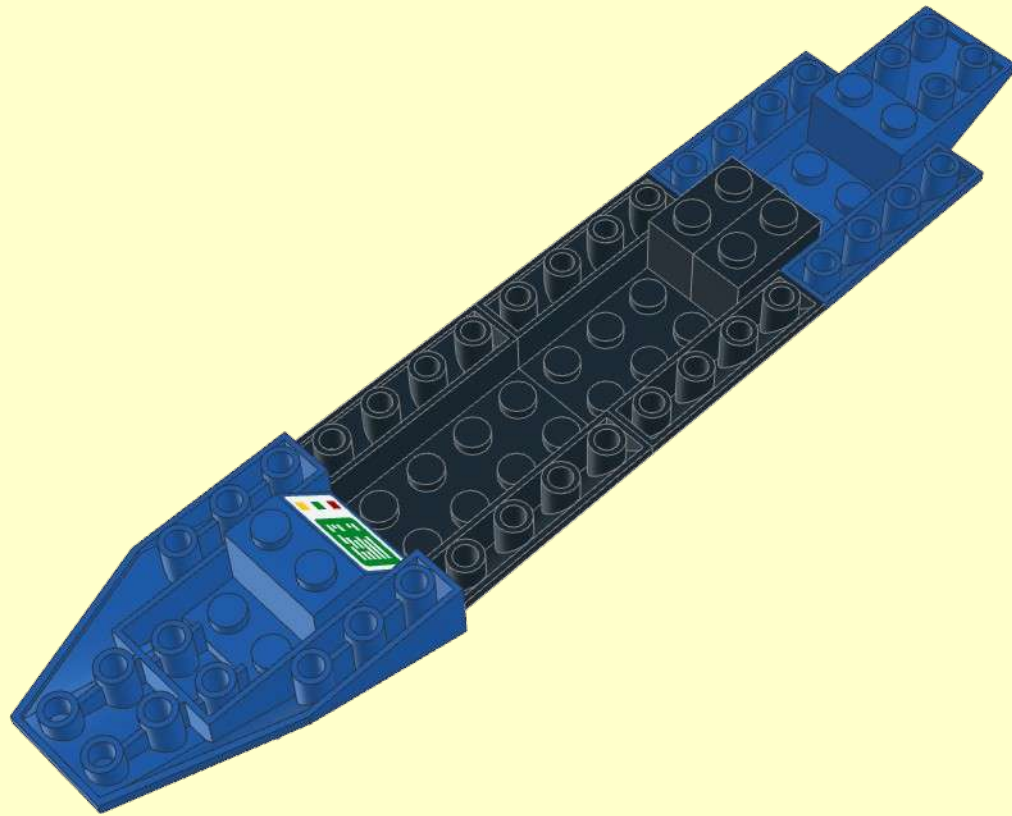

4

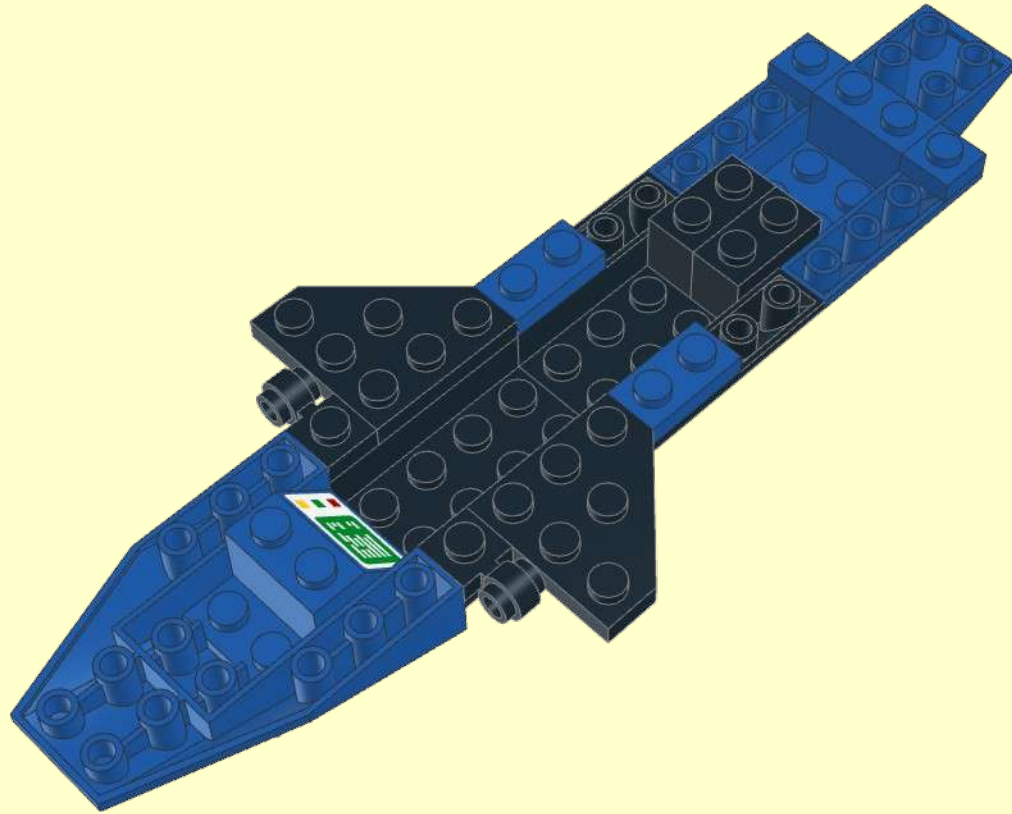
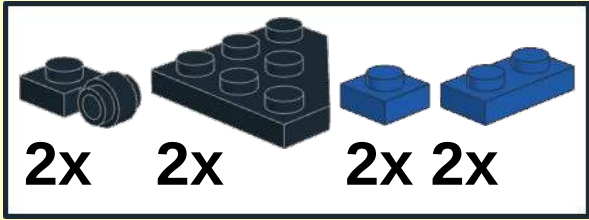

5

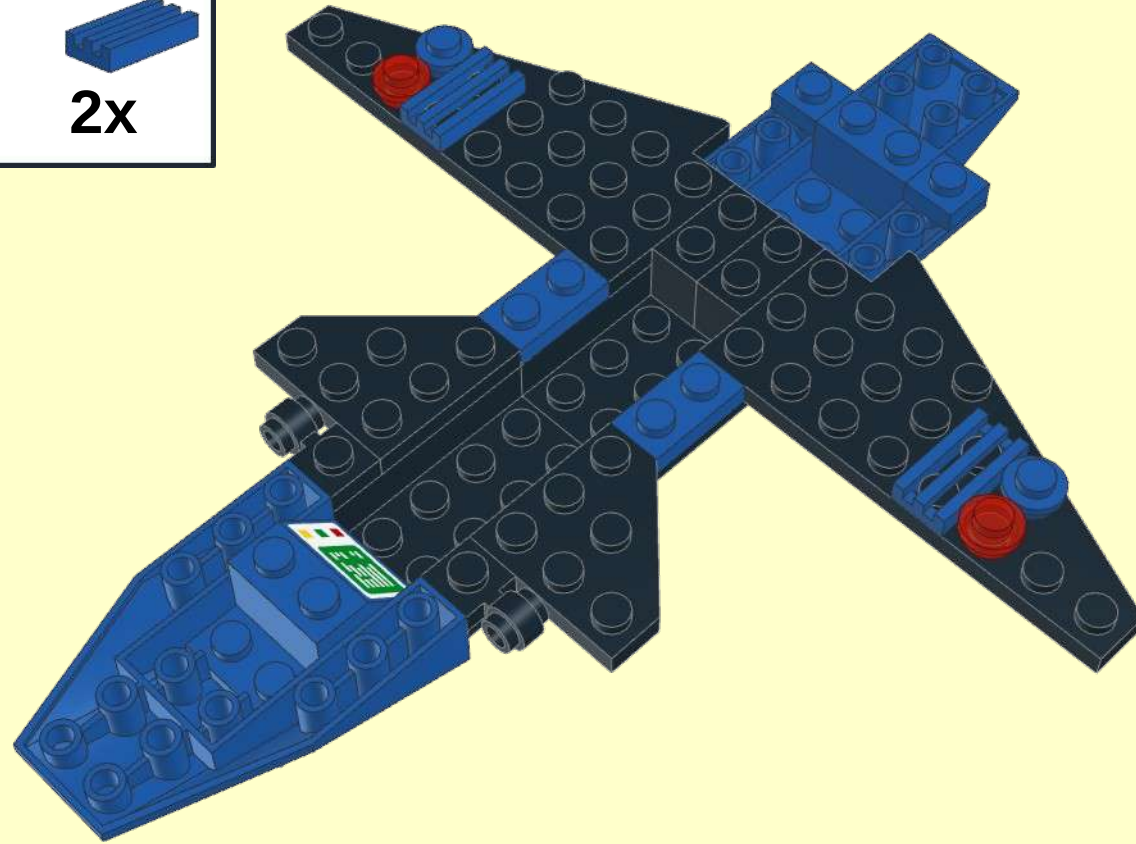
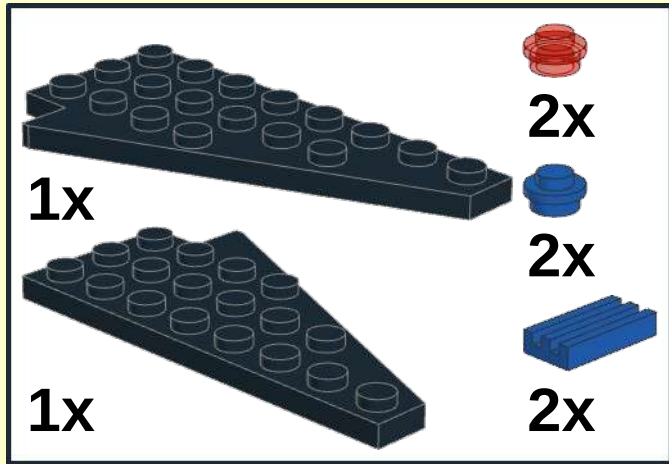

6

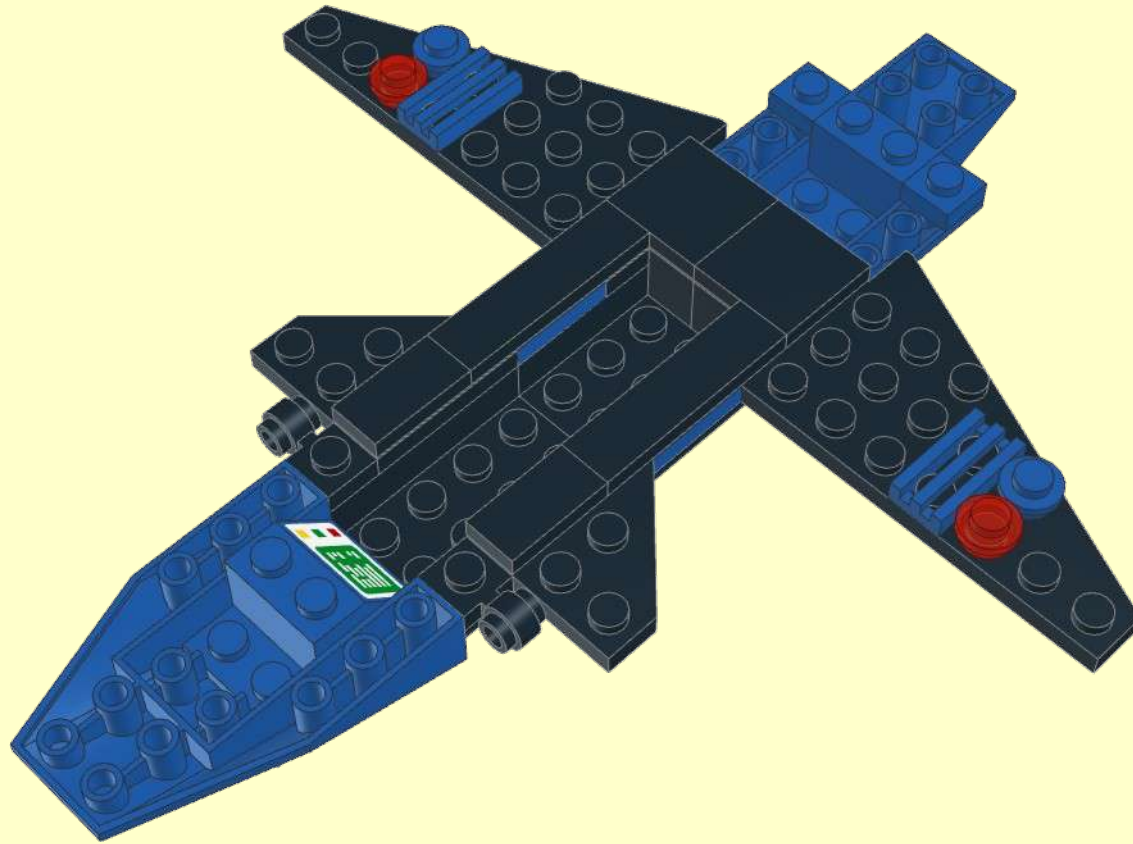
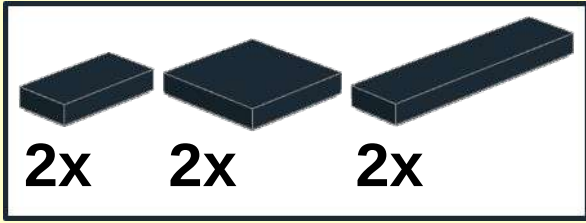

7

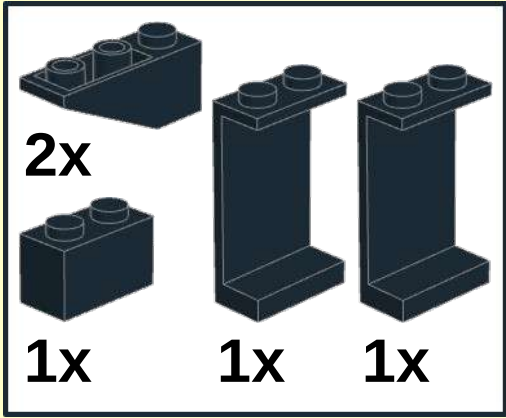

8

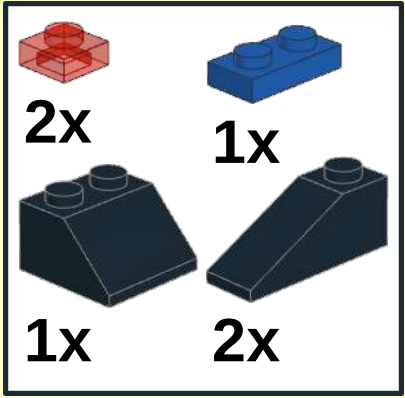

9



1x



2x



10

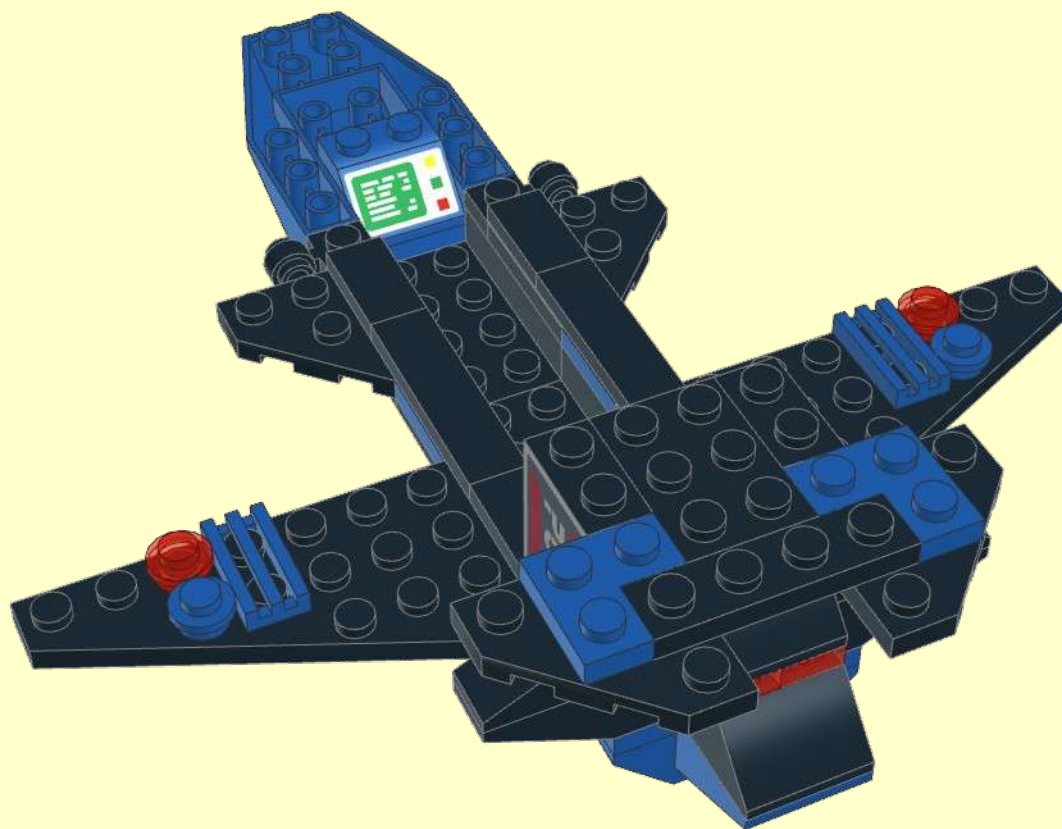
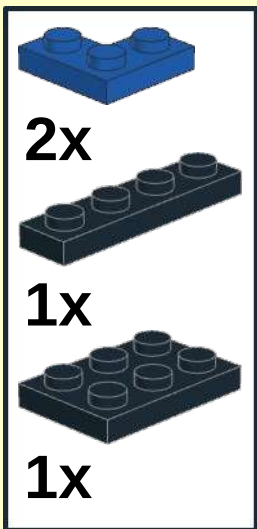

11

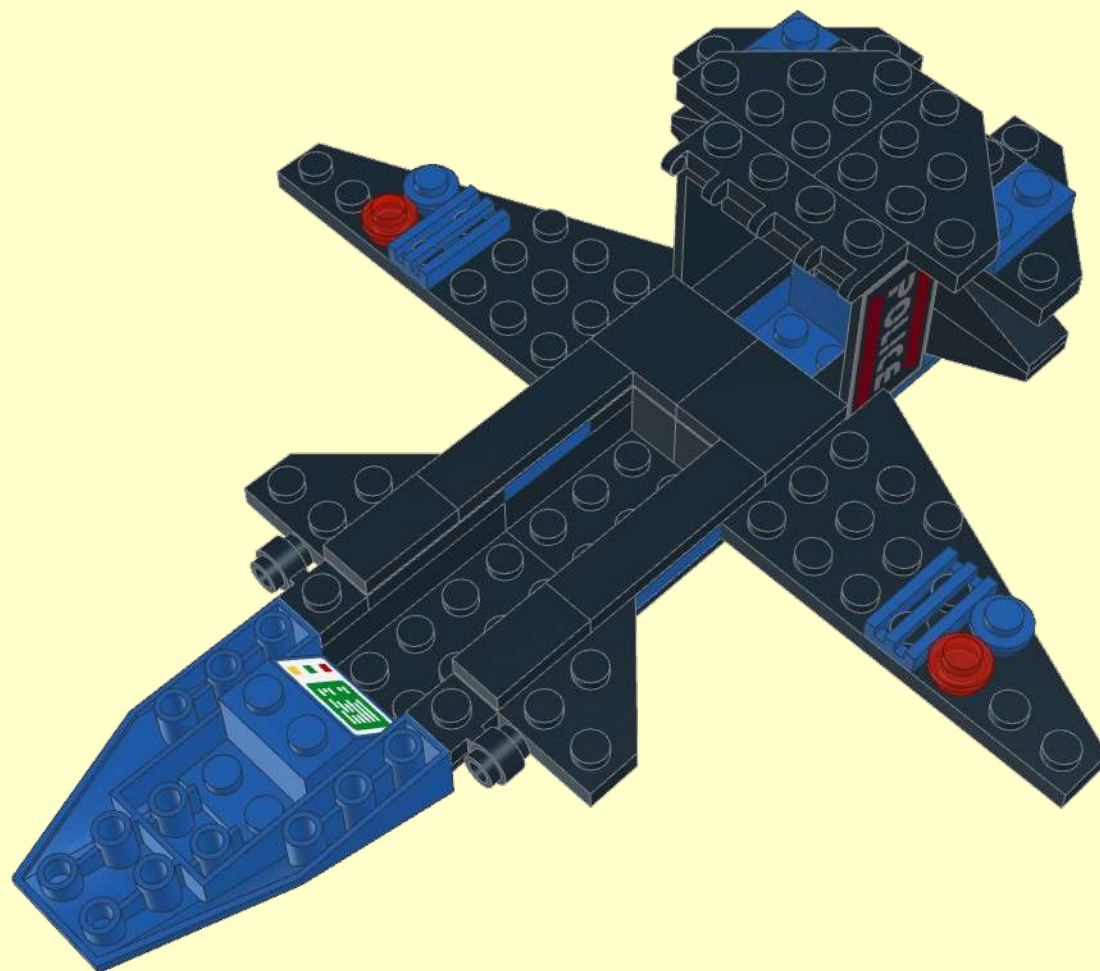
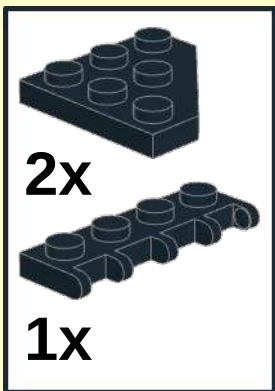

12

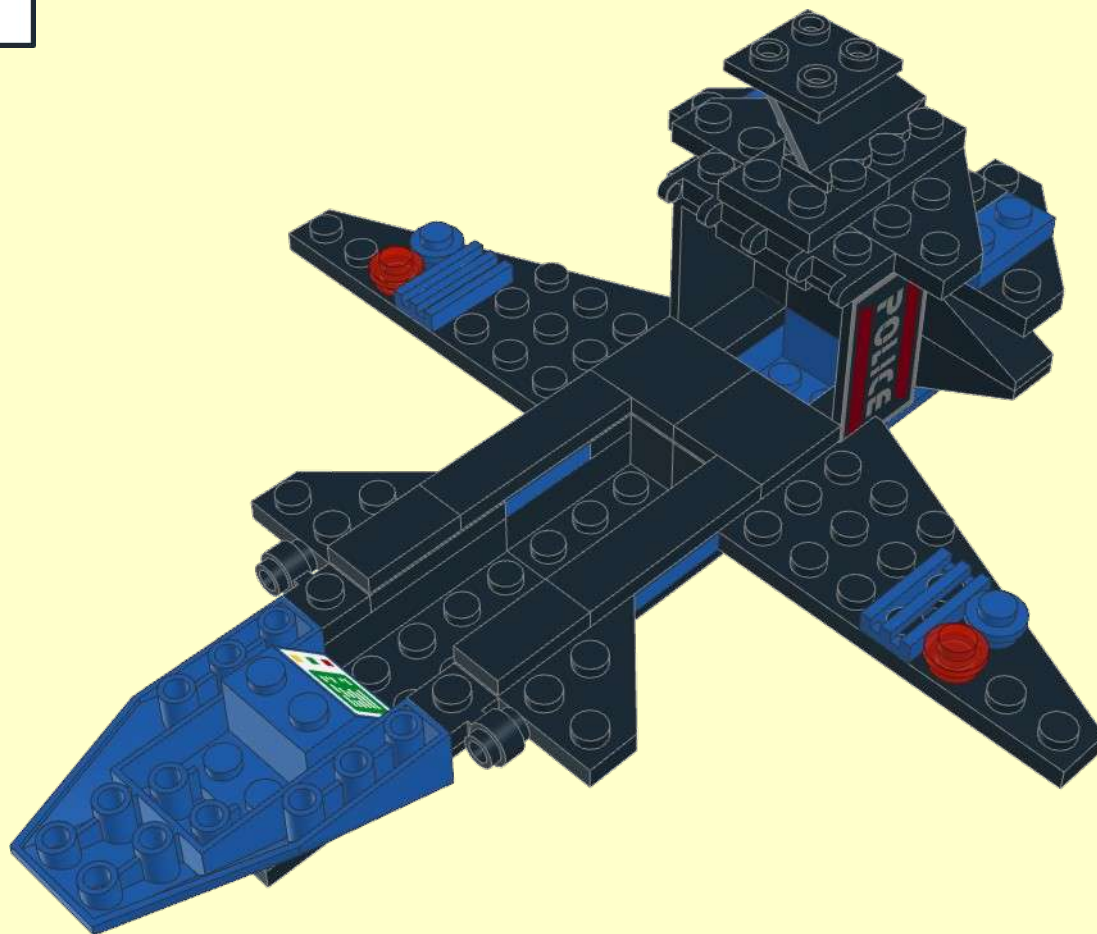
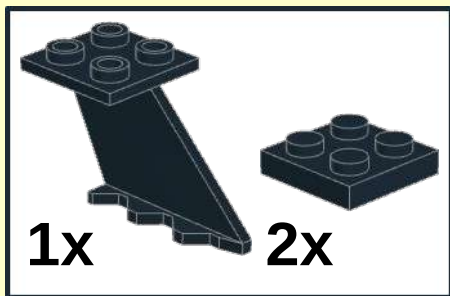

13

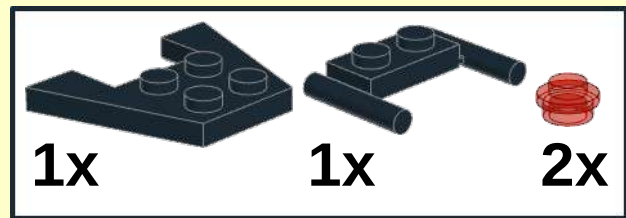

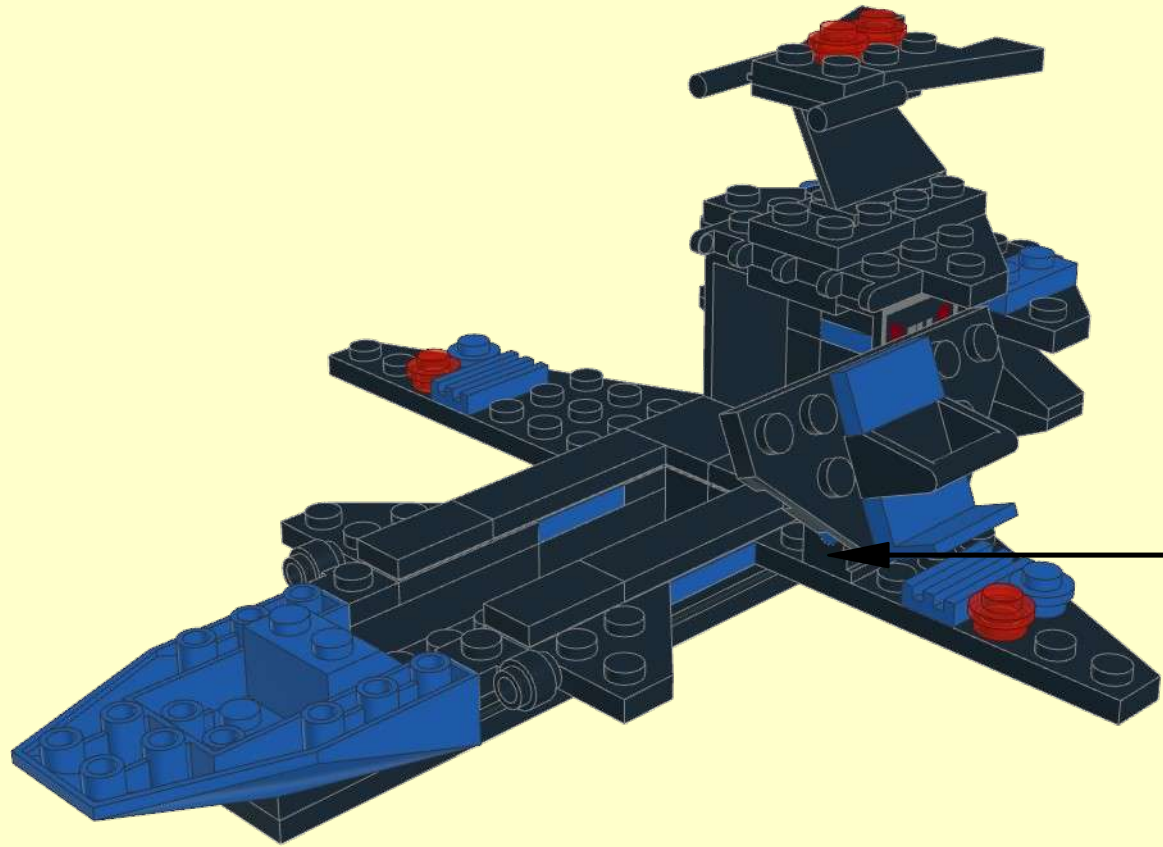

1

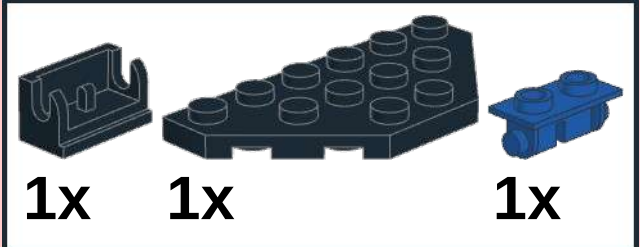

1x

1x

1x

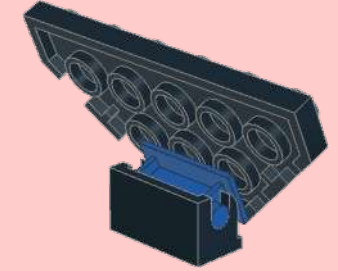

2

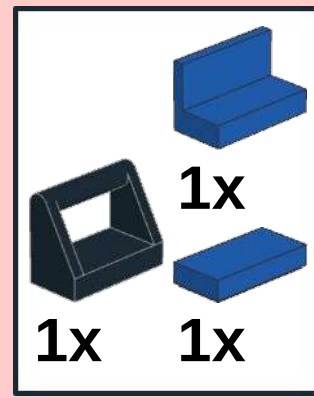

1x

1x

1x

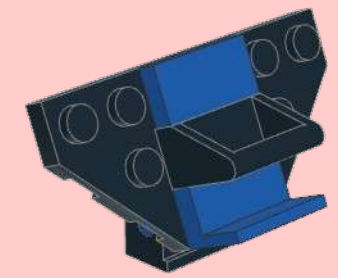

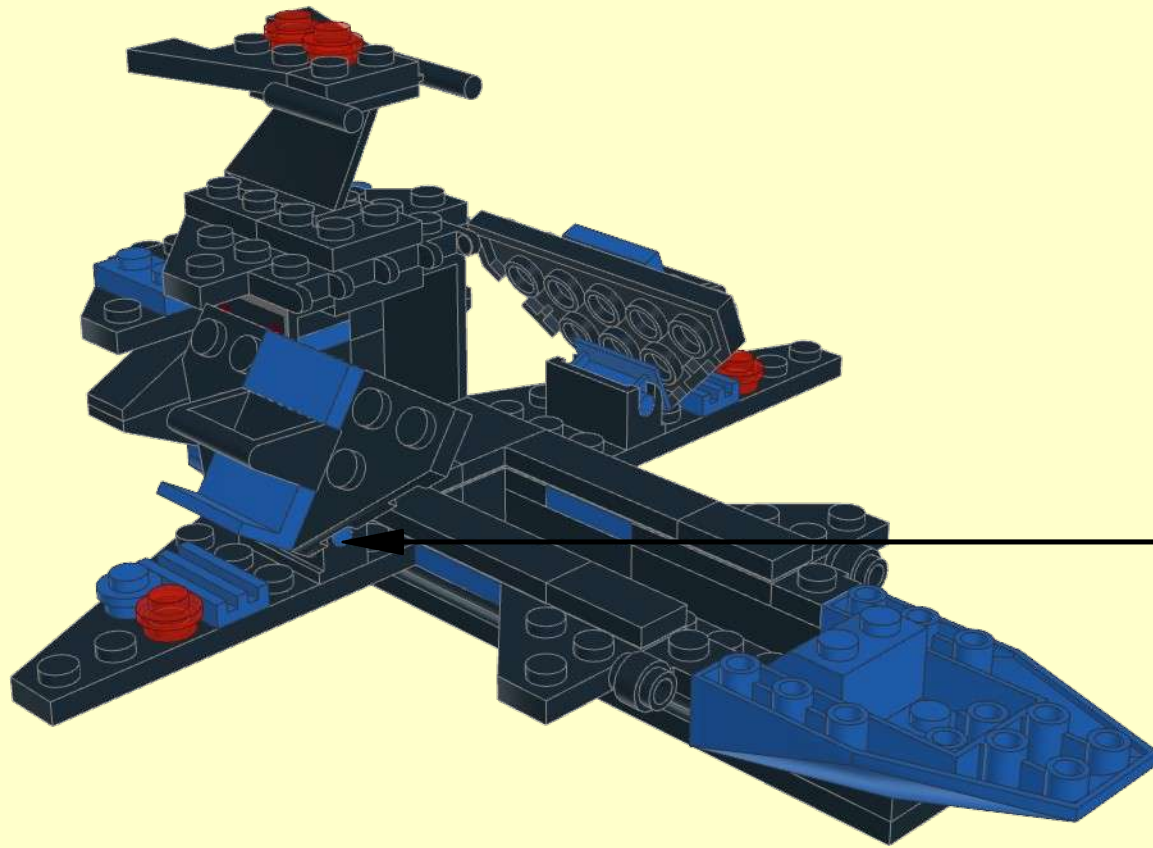

1

1x **1x** **1x**

2

1x **1x**

Step 1 shows three parts: a black L-shaped Technic beam (1x), a black 1x6 Technic beam (1x), and a blue 1x2 Technic beam (1x). These are joined to form a sub-assembly. Step 2 shows three parts: a black U-shaped Technic beam (1x), a blue L-shaped Technic beam (1x), and a blue 1x2 Technic beam (1x). These are joined to form another sub-assembly. The sub-assembly from step 2 is then attached to the main structure at the location indicated by the arrow.

16

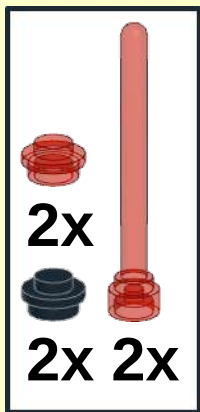

2x
2x 2x

This block contains a parts list for step 16. It features a red bush, a red axle, a black bush, and a red bush. The quantity '2x' is written below the red bush and the black bush, and '2x 2x' is written below the red axle and the bottom red bush.

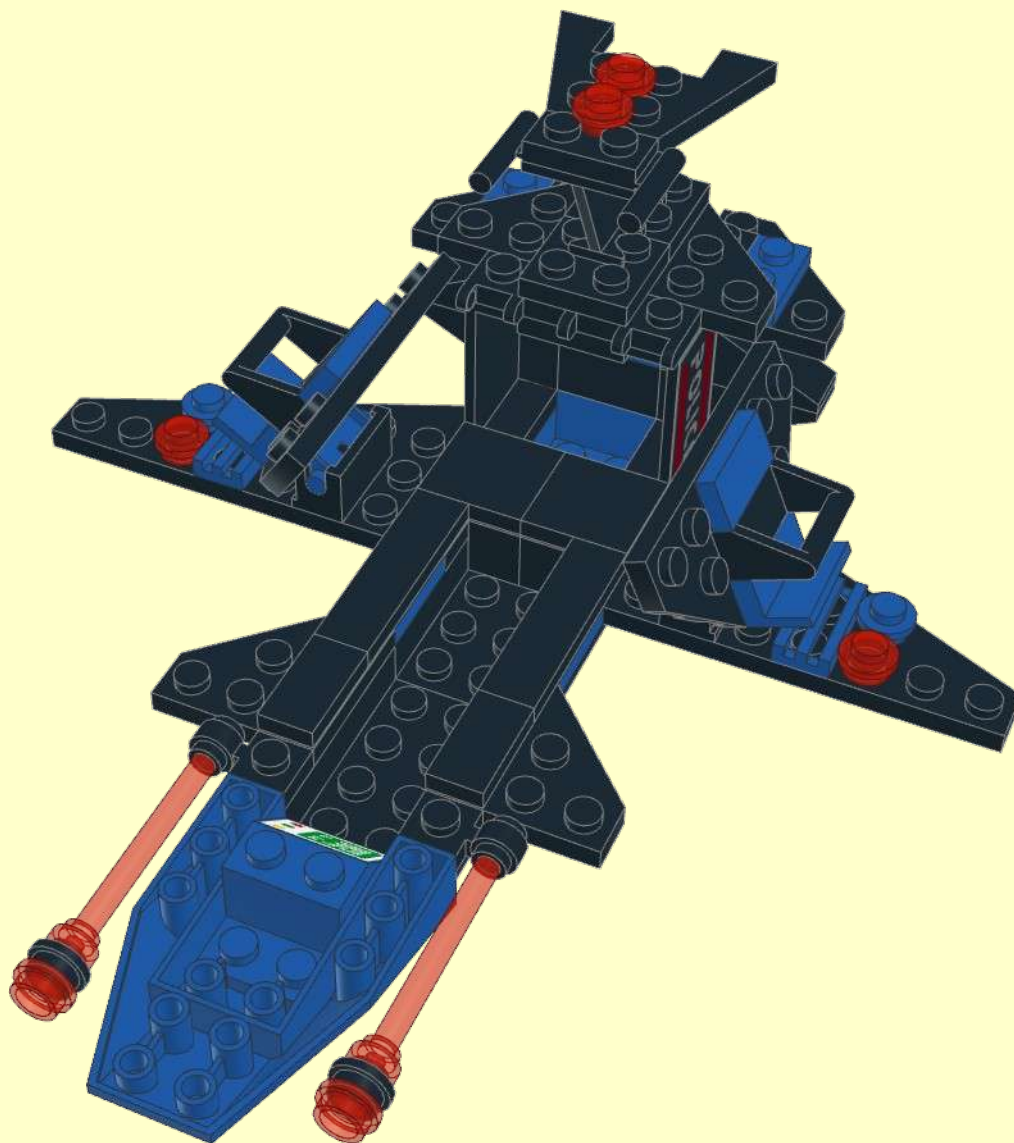

17

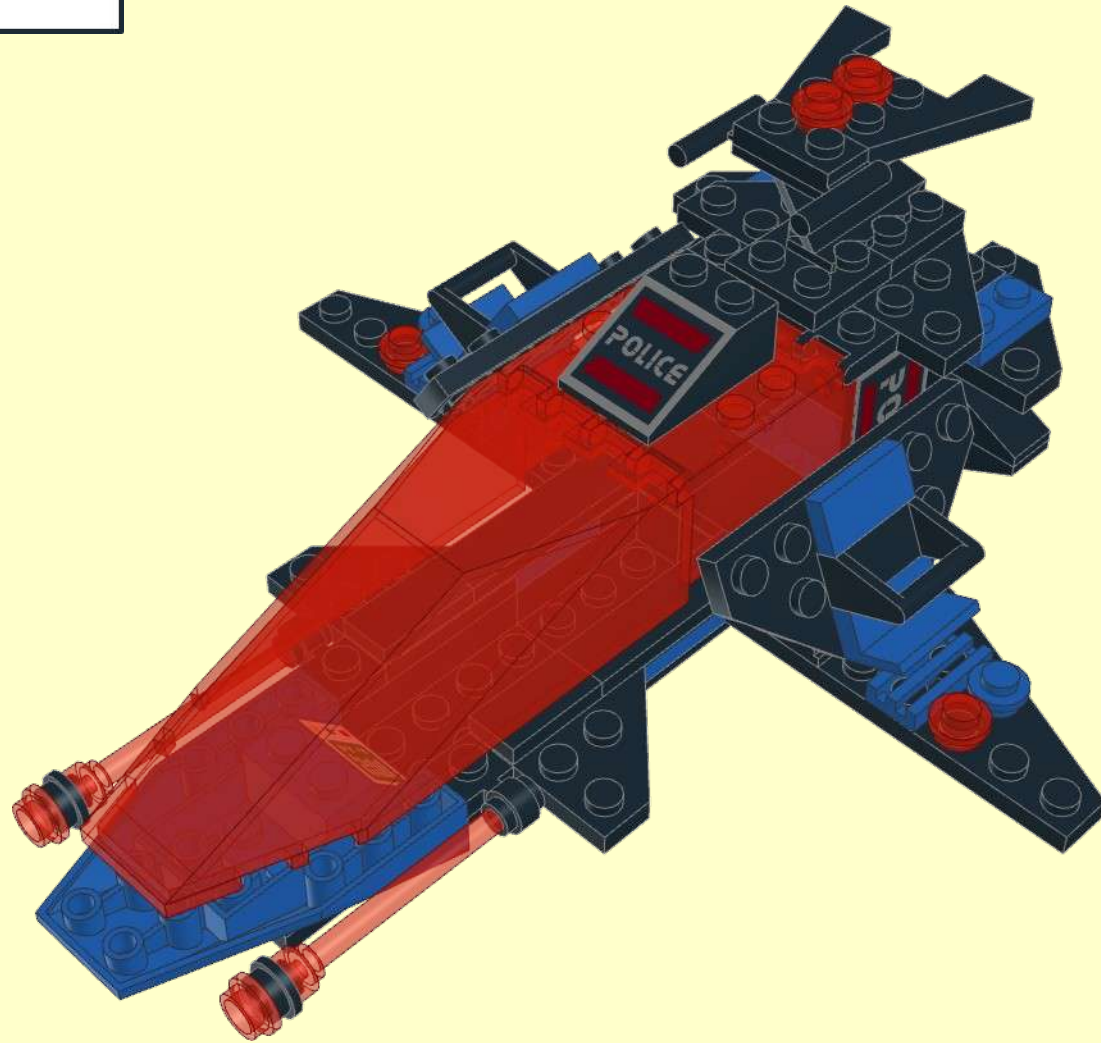
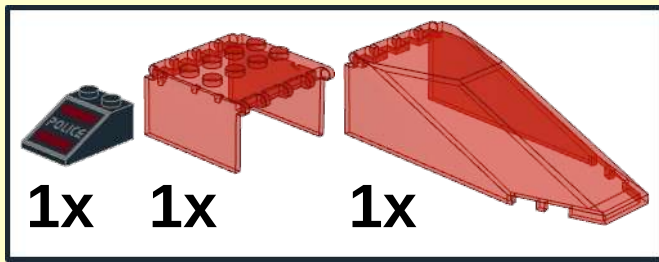

1

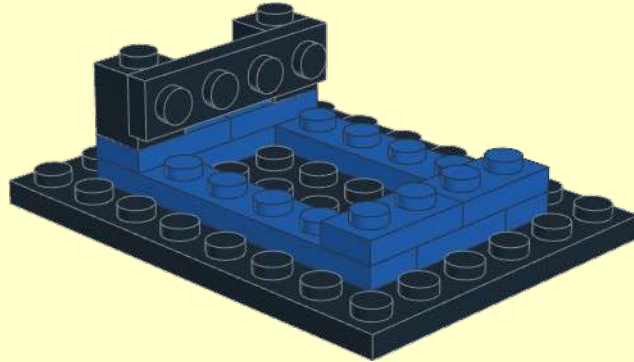
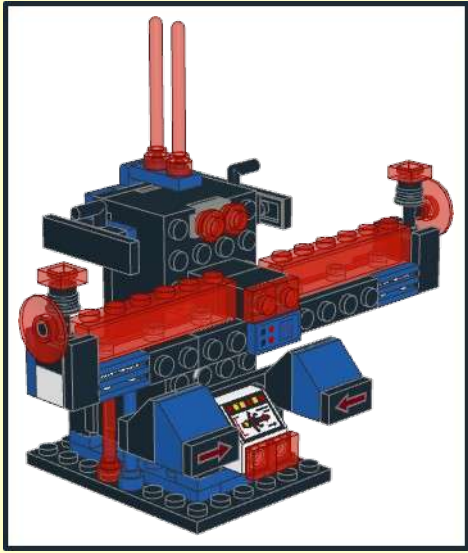

1

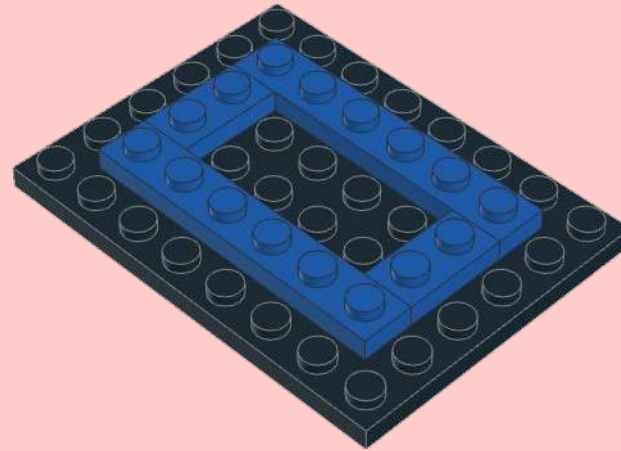
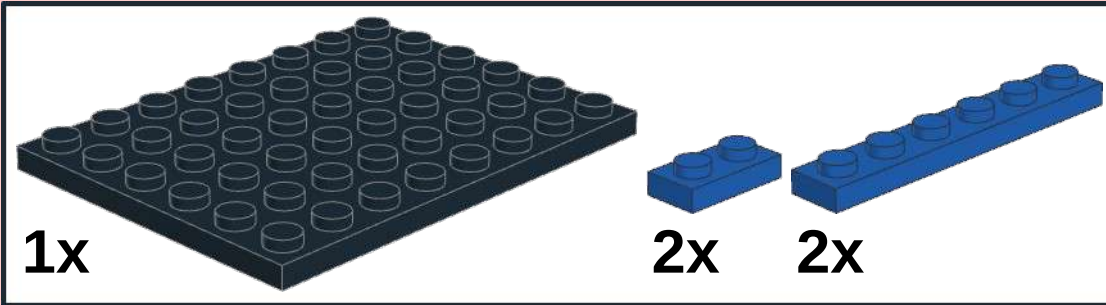
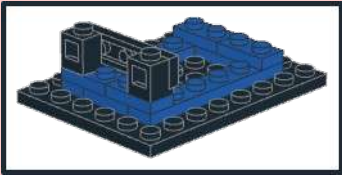

2



2x 1x

4x

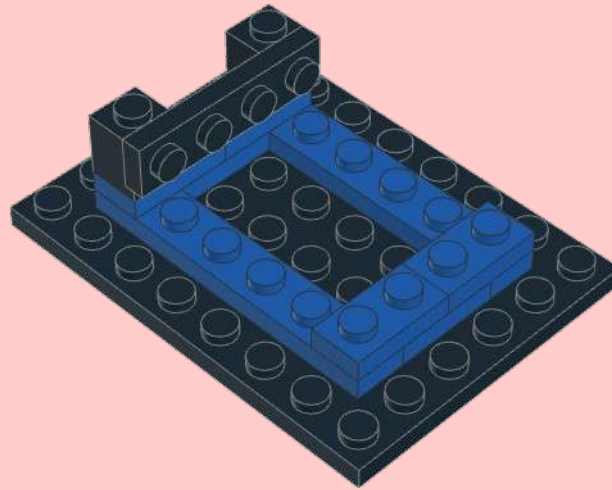

1

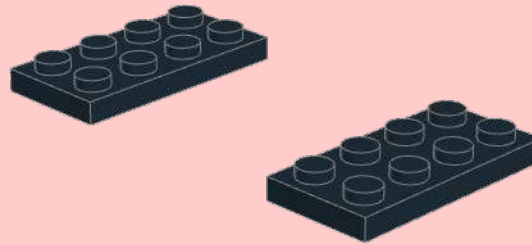
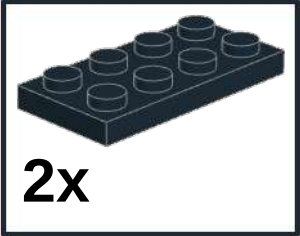
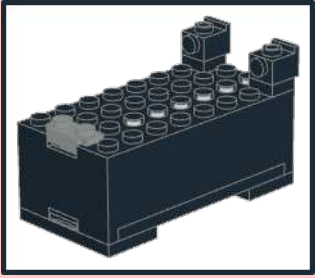

2

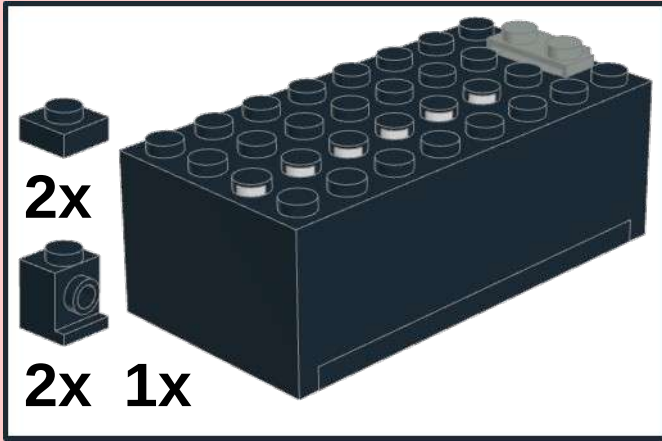

2

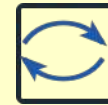
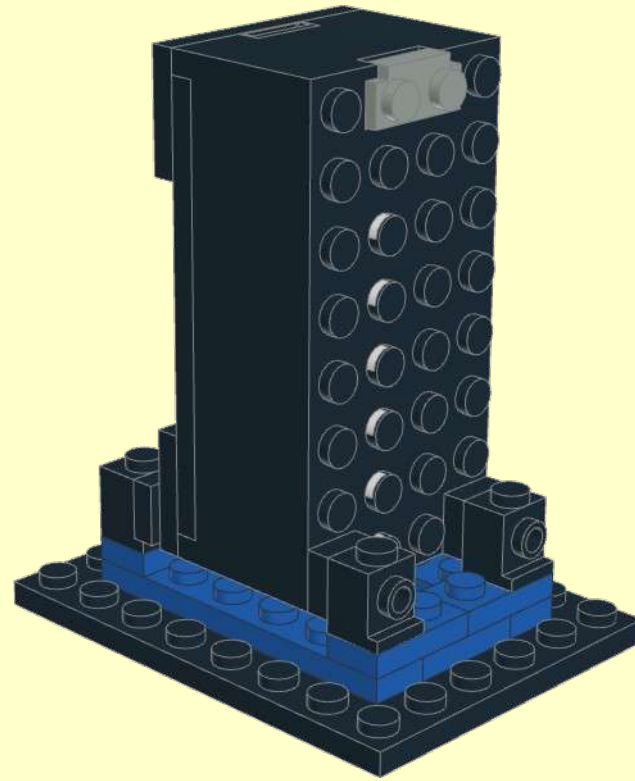

3

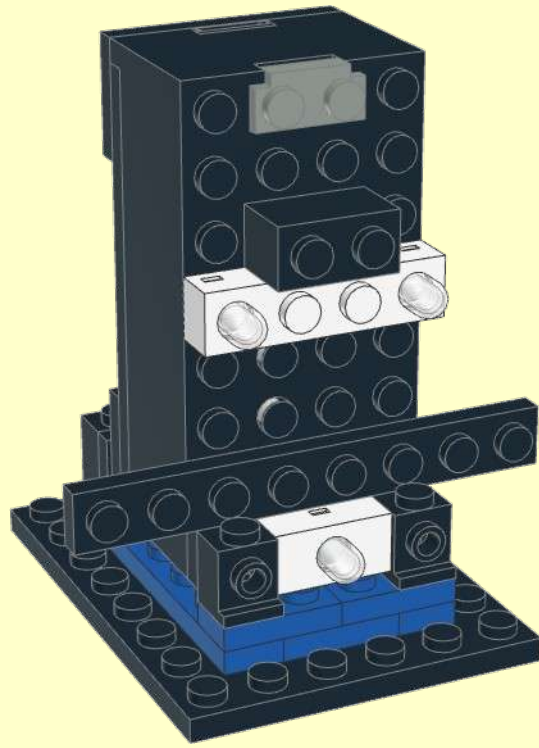
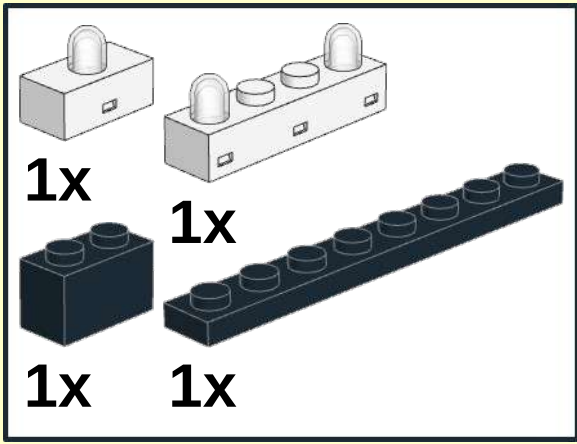

4

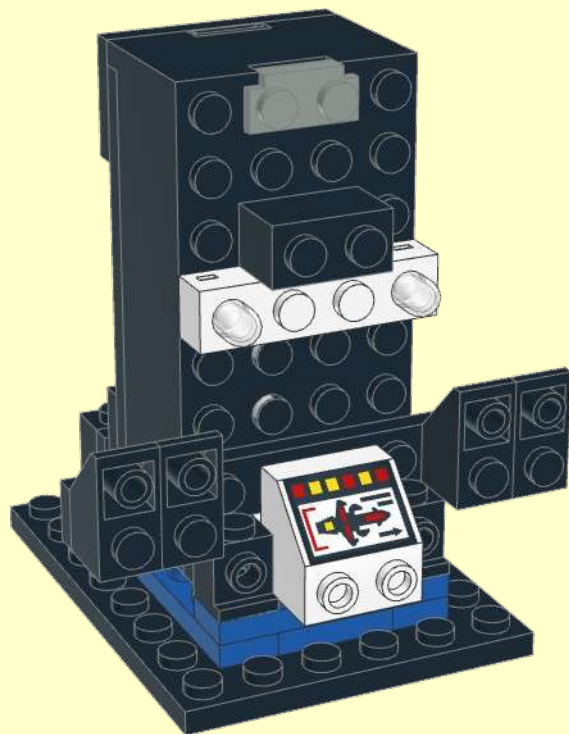
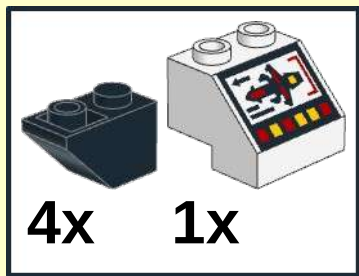

5

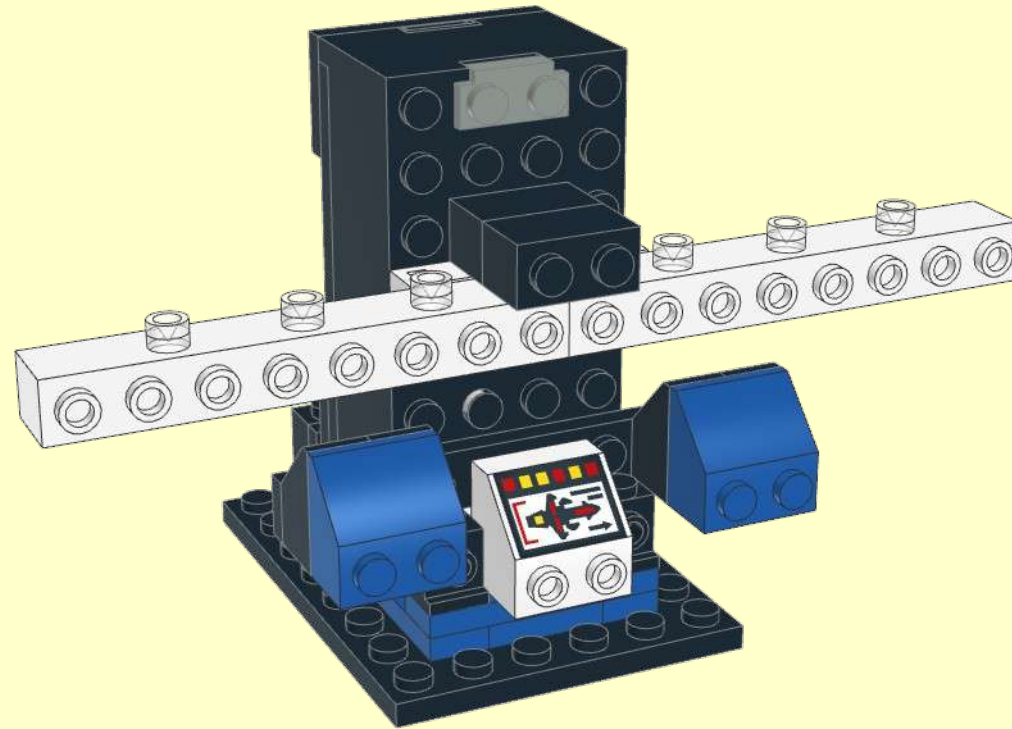
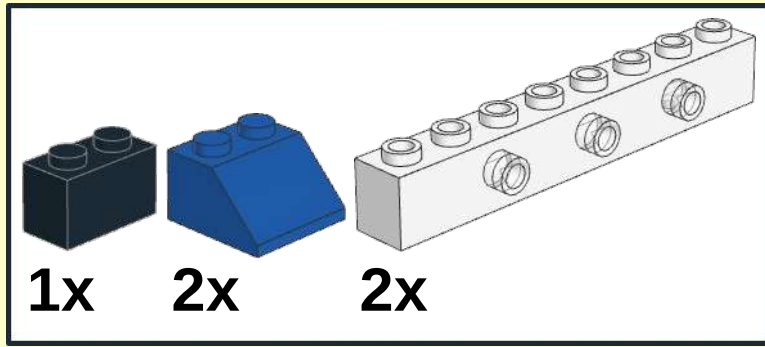

6

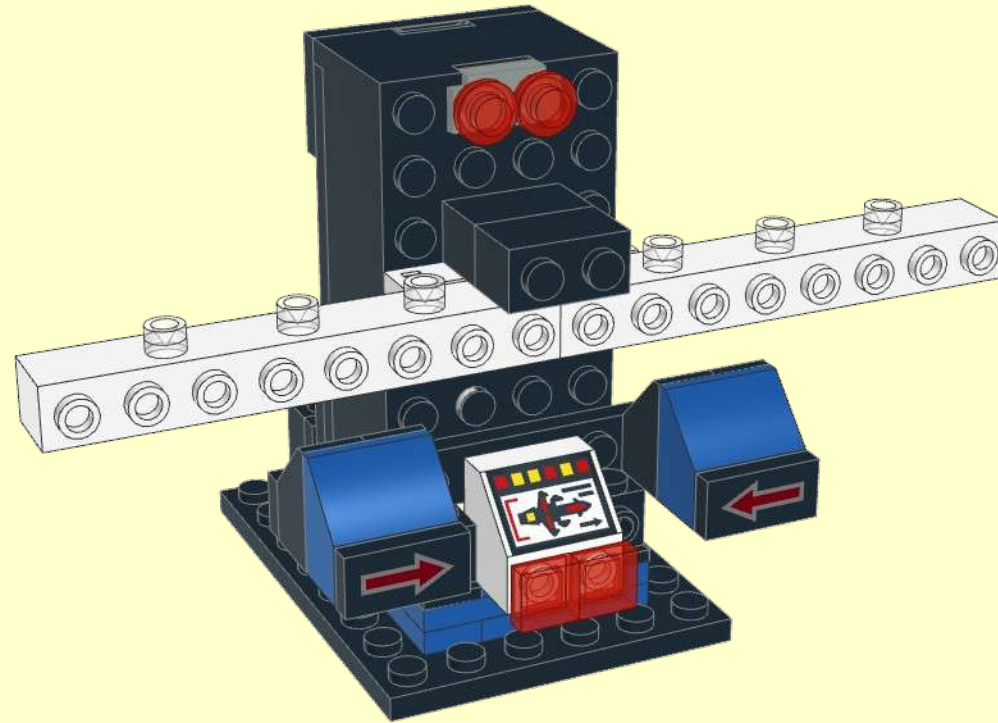
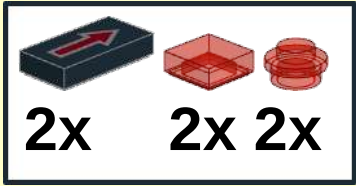

7

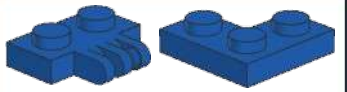

3x

2x

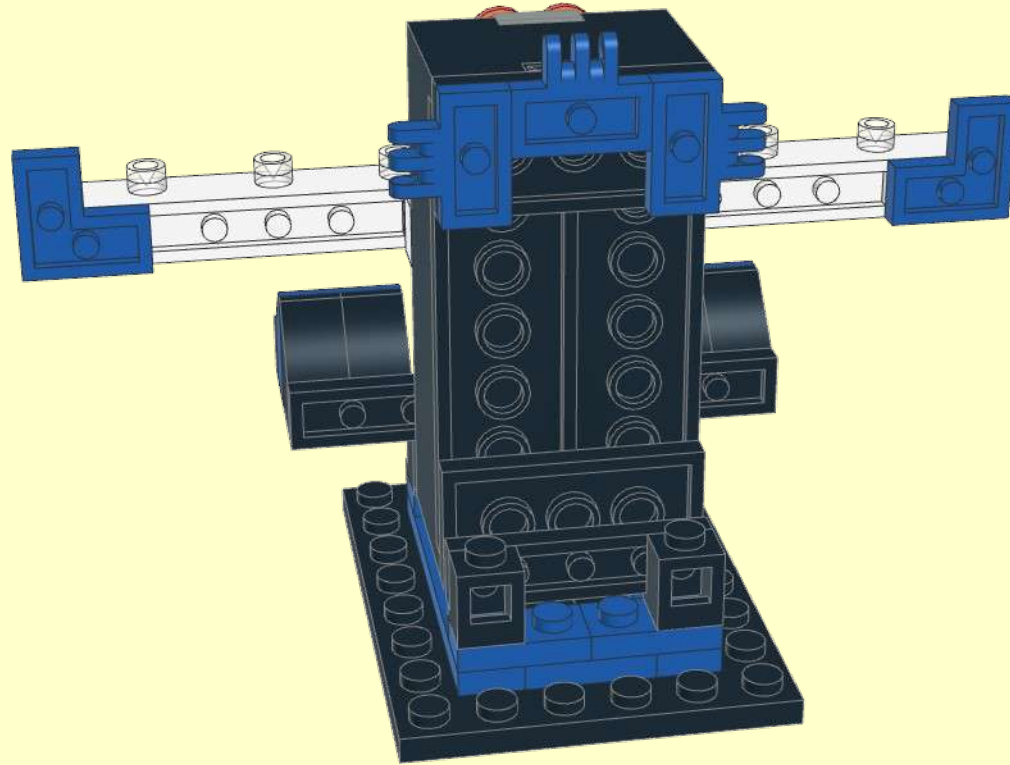

10

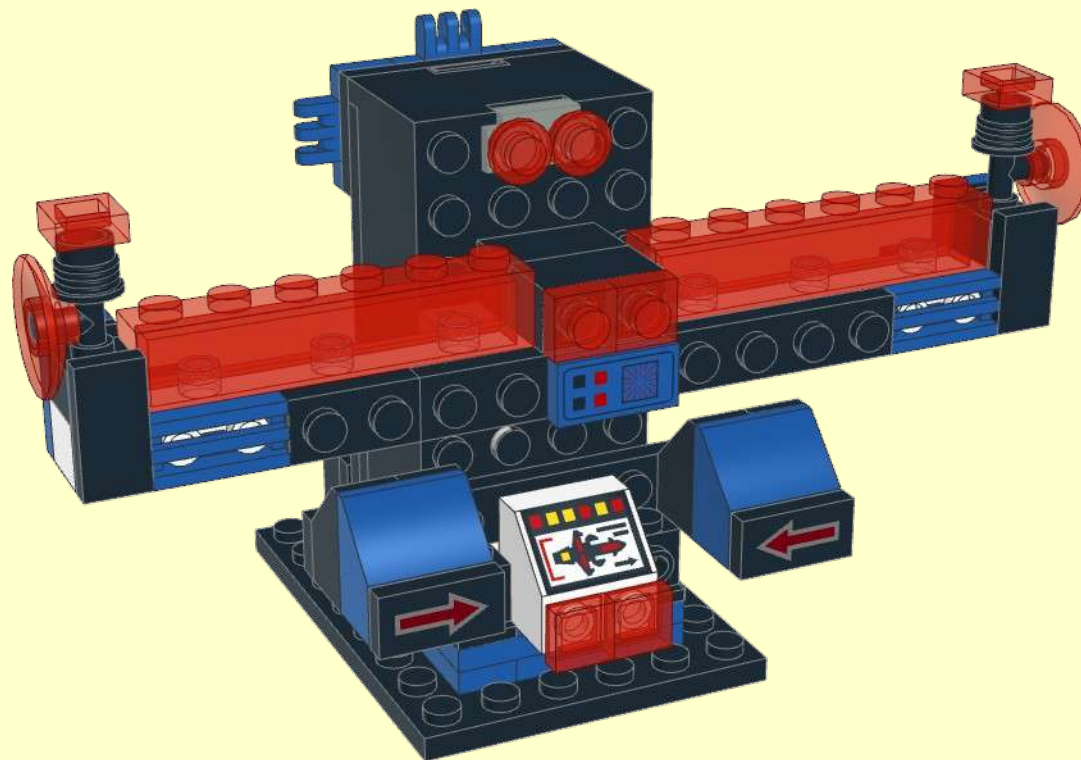

11

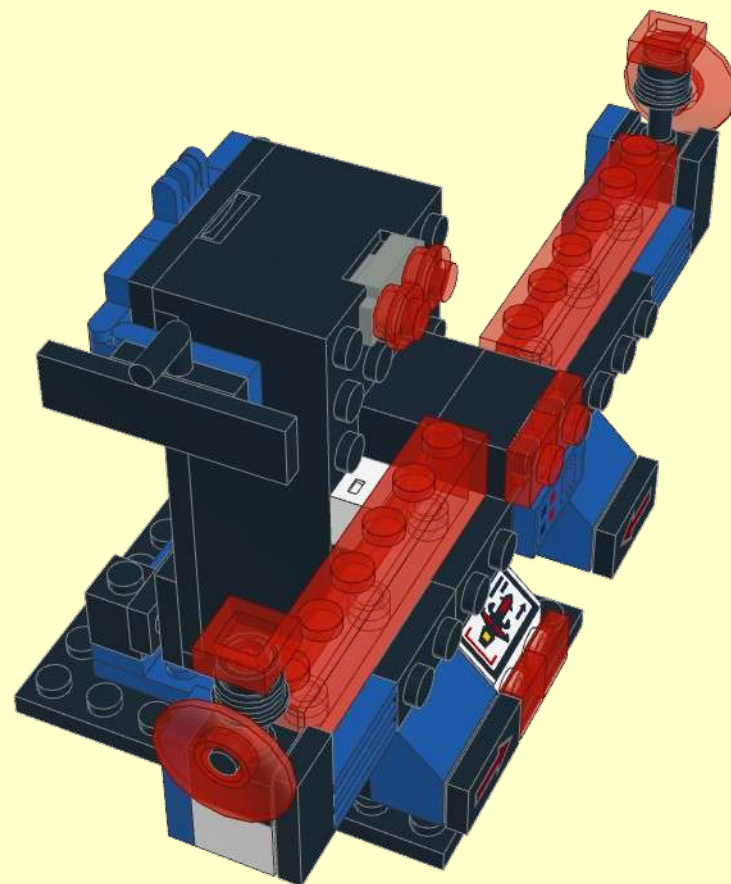
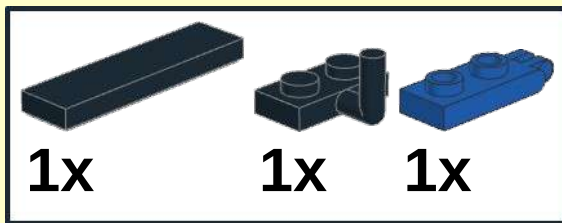

12

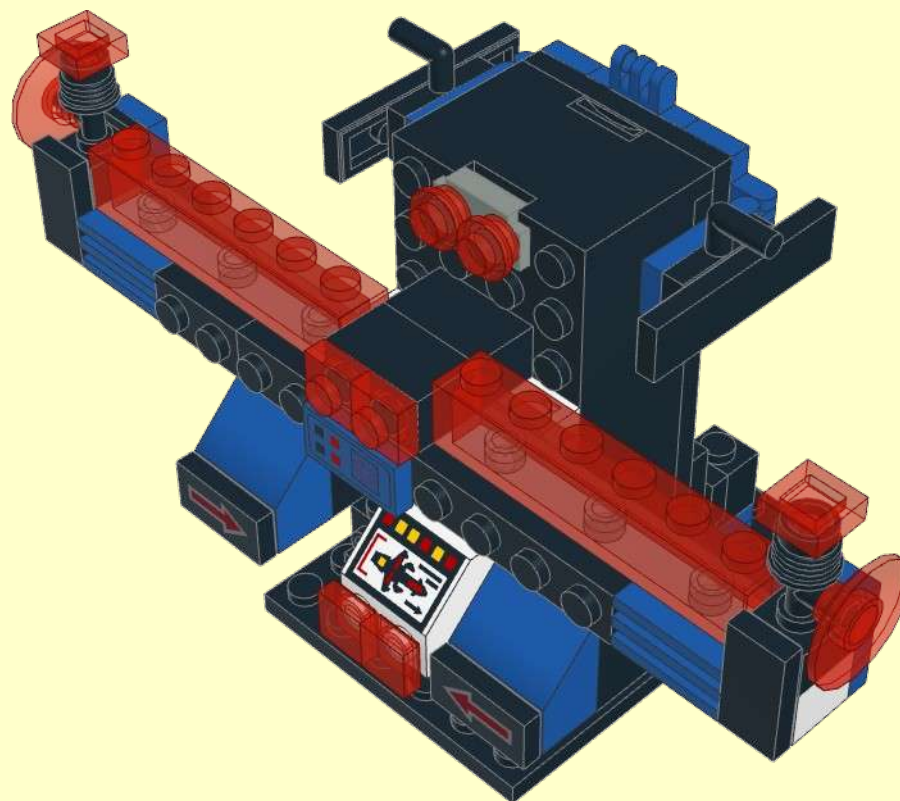
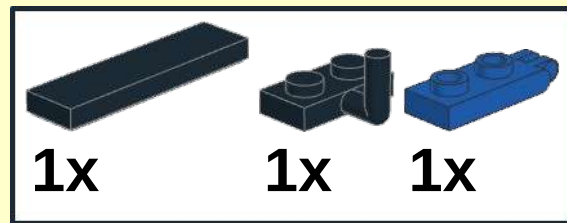

13

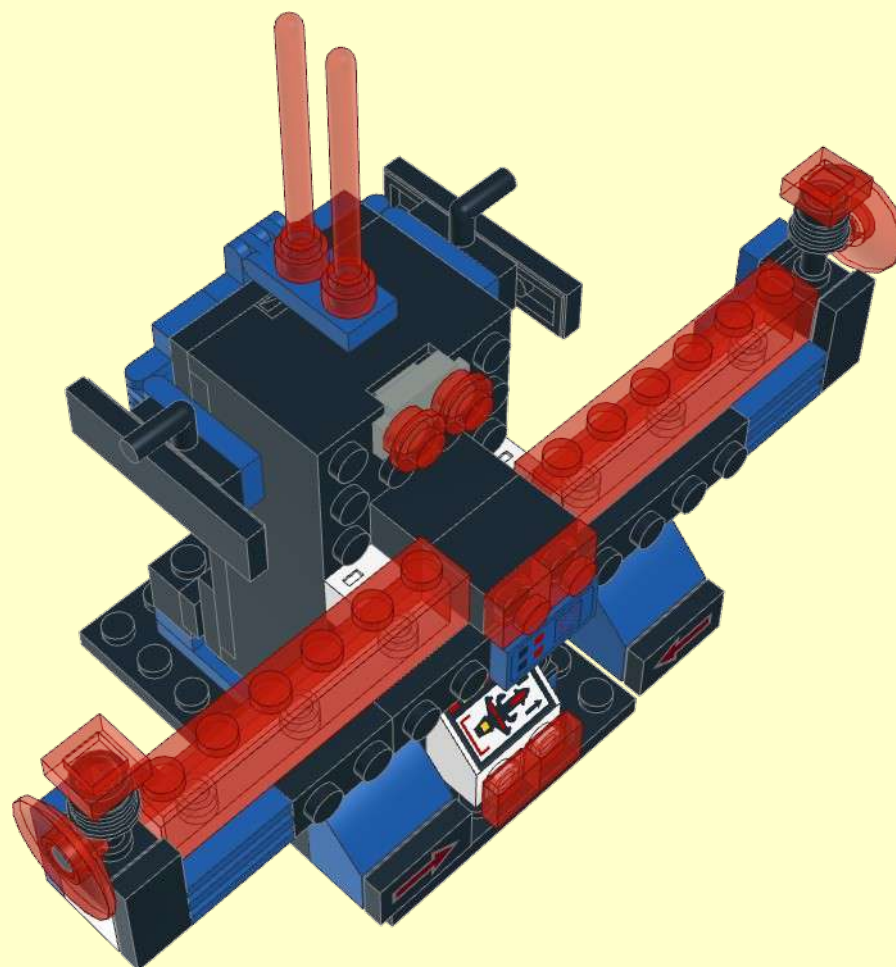
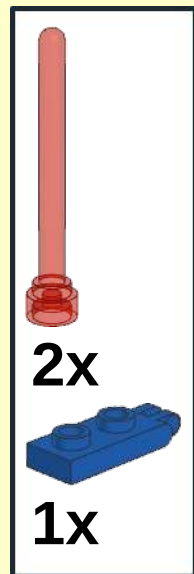

14

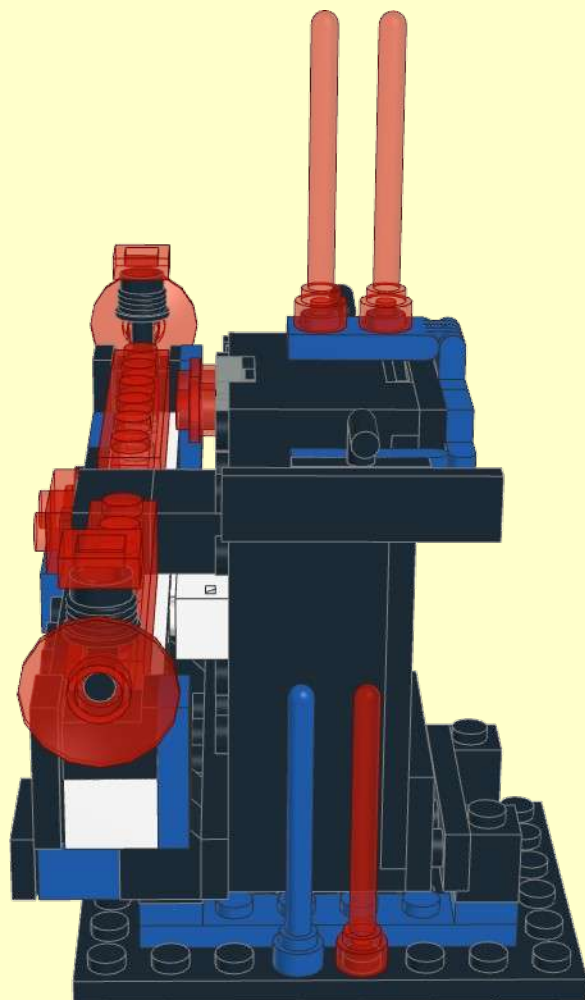
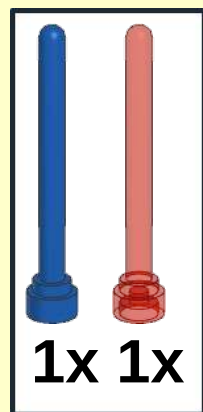

15

