









1

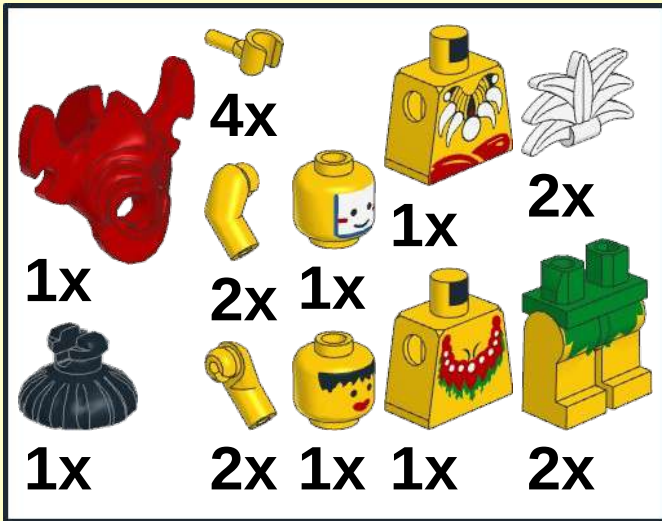



1x

1x

1x

A parts list and assembly diagram. The parts list shows: a red 1x3 Technic brick (1x), a black Technic axle (1x), and a white horn-shaped piece (1x). The assembly diagram shows the red brick being attached to the black axle, with the white horn-shaped piece on top.

3

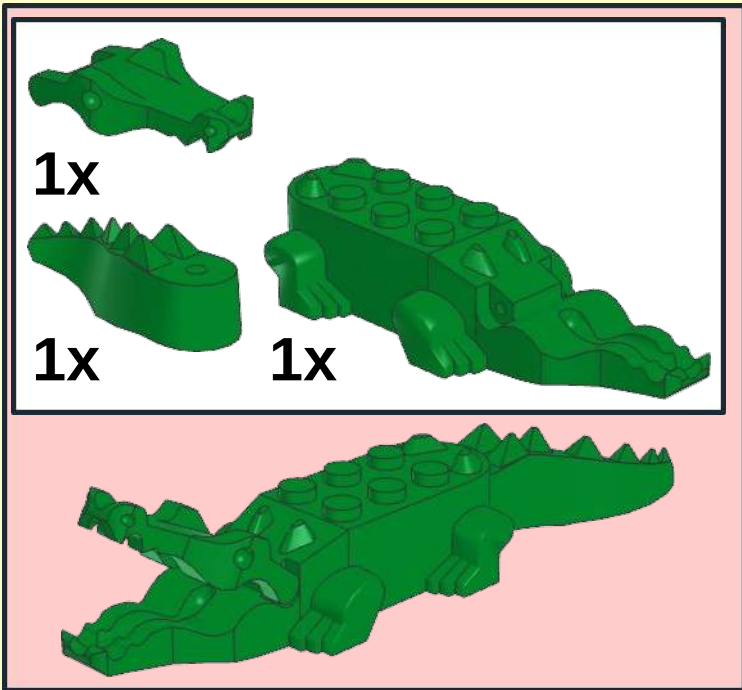
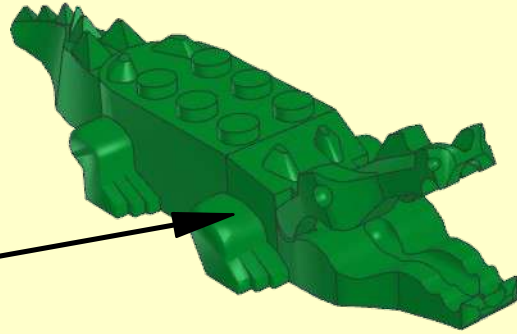

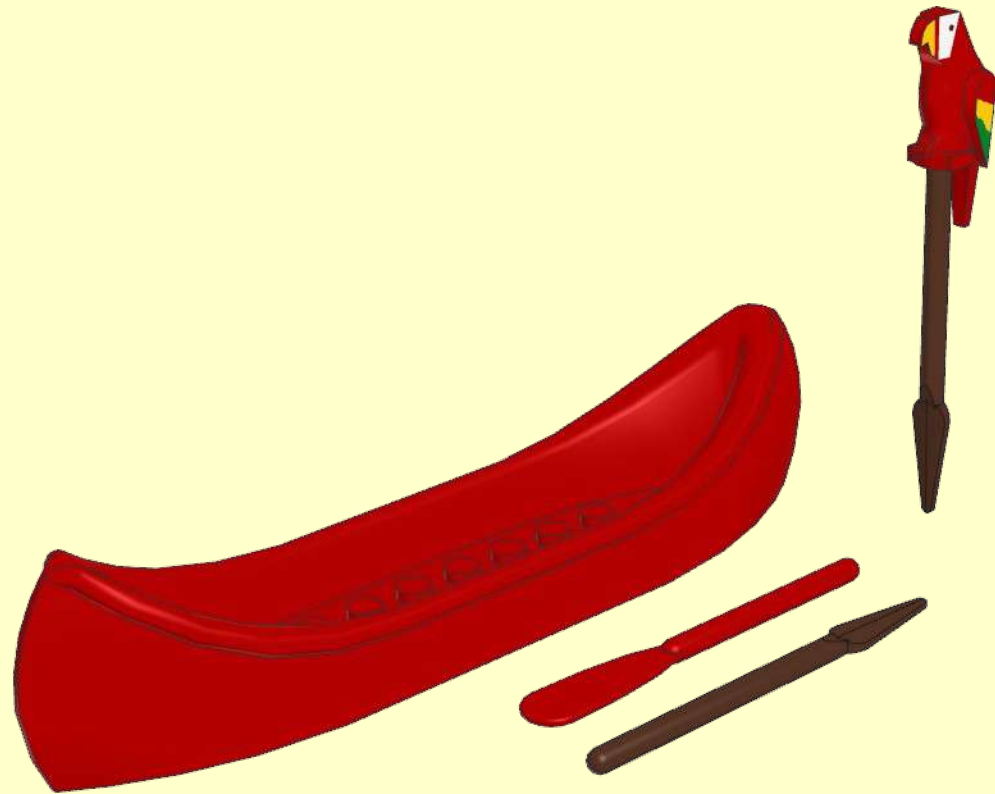
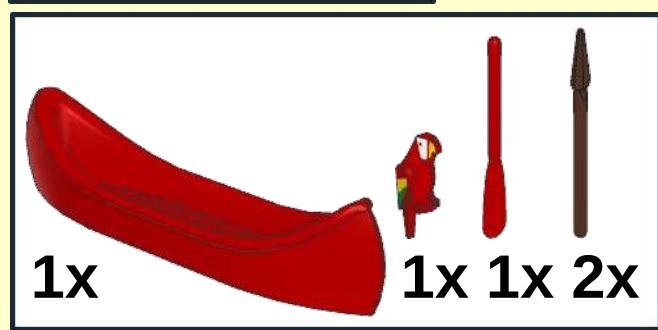
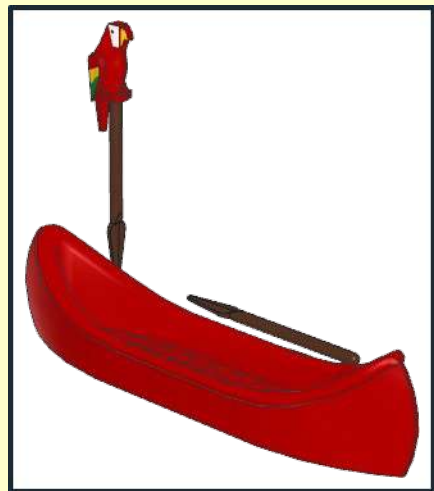

1

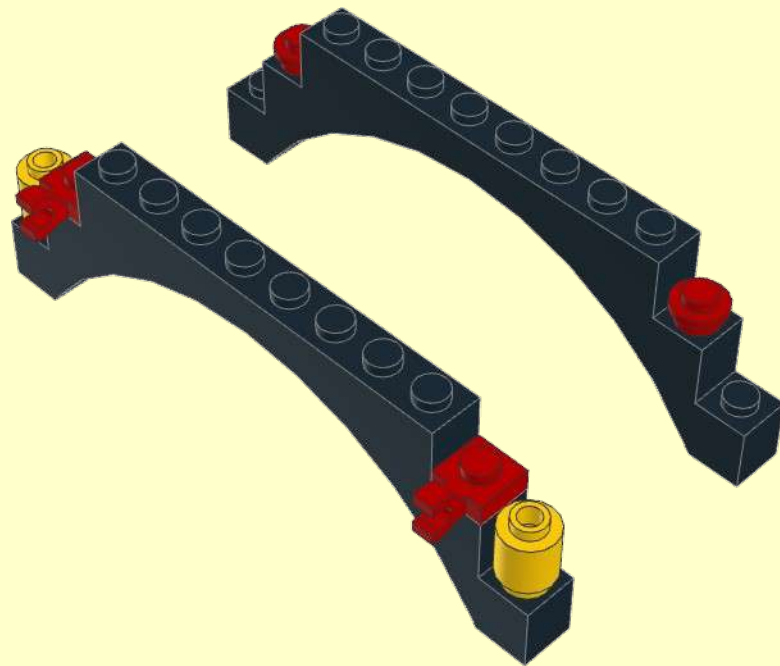
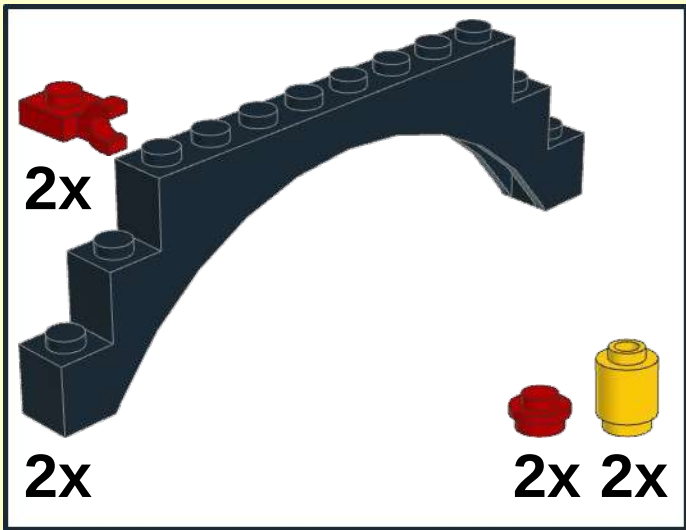
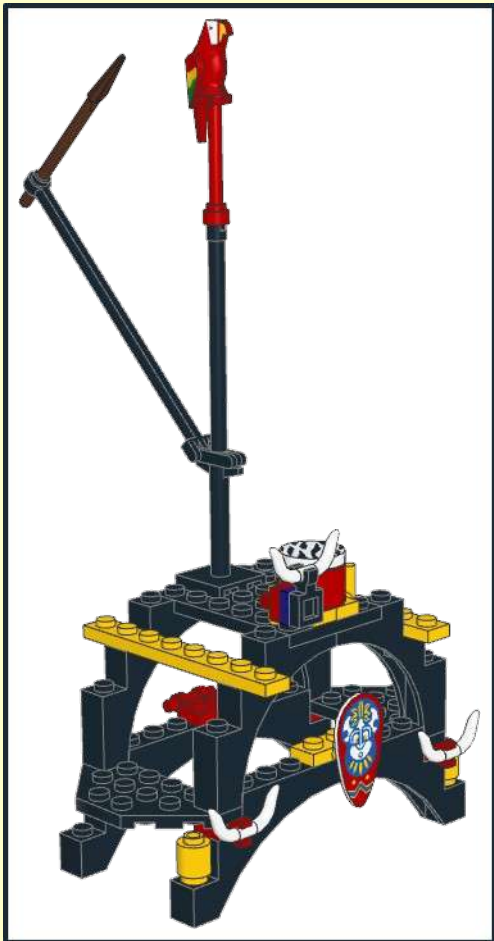

2

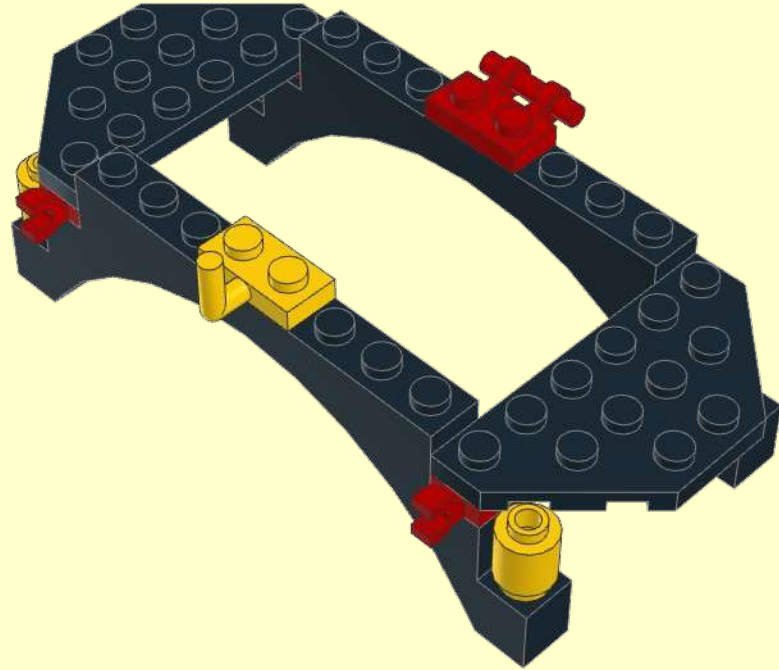
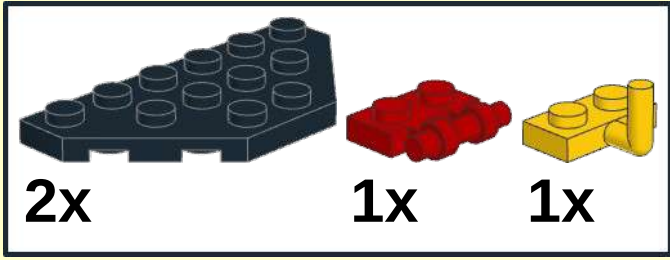



3

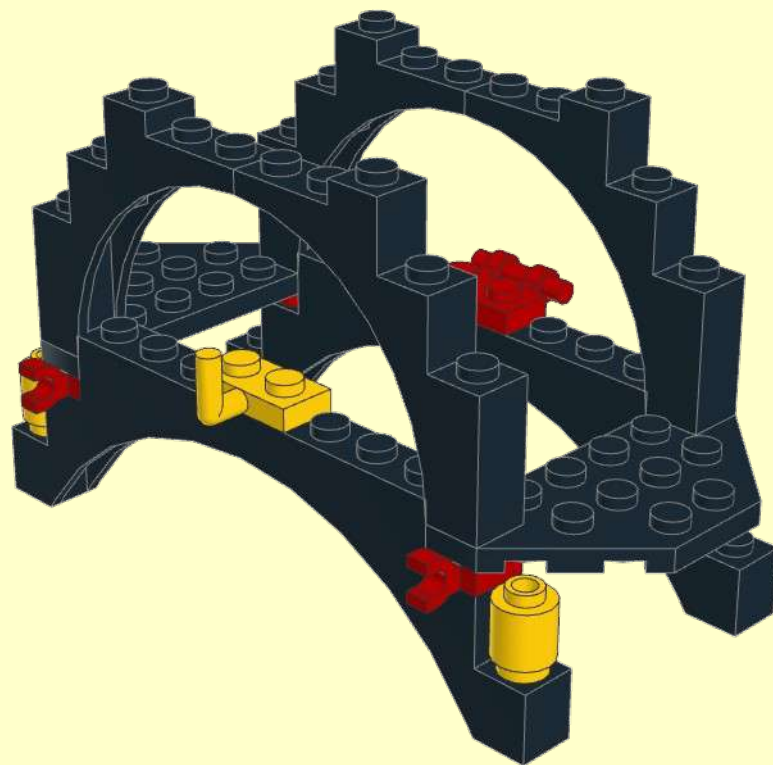
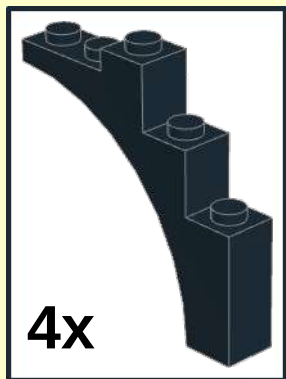

4

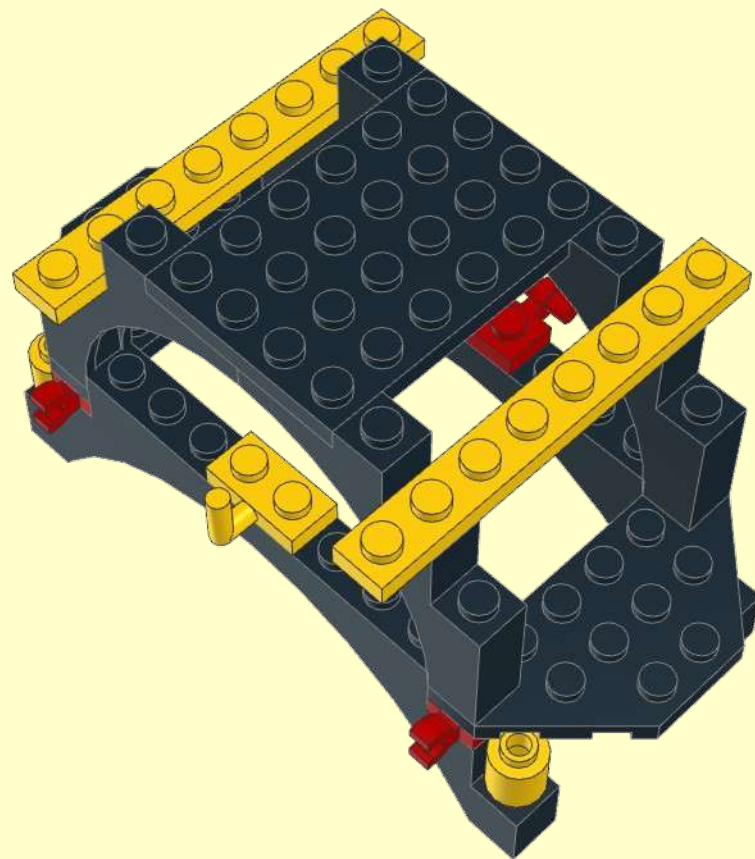
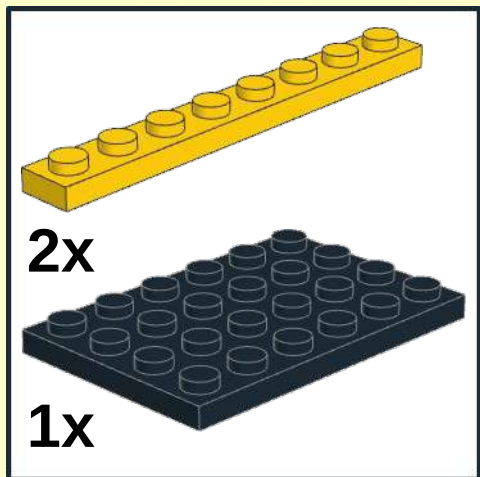



5

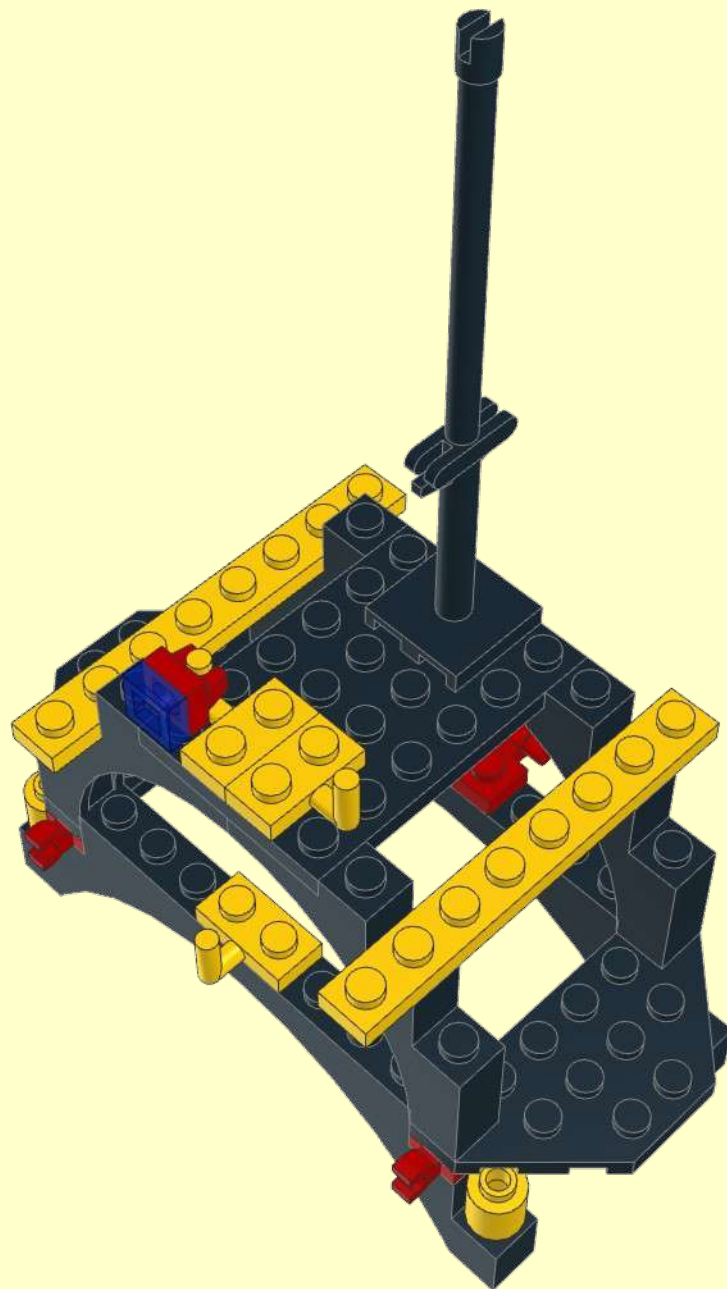
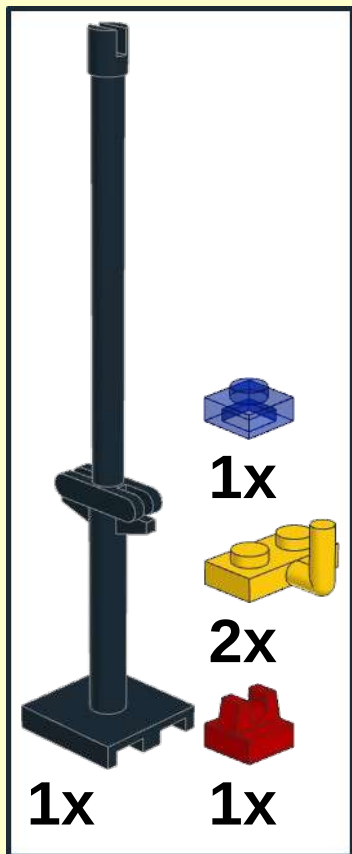

6

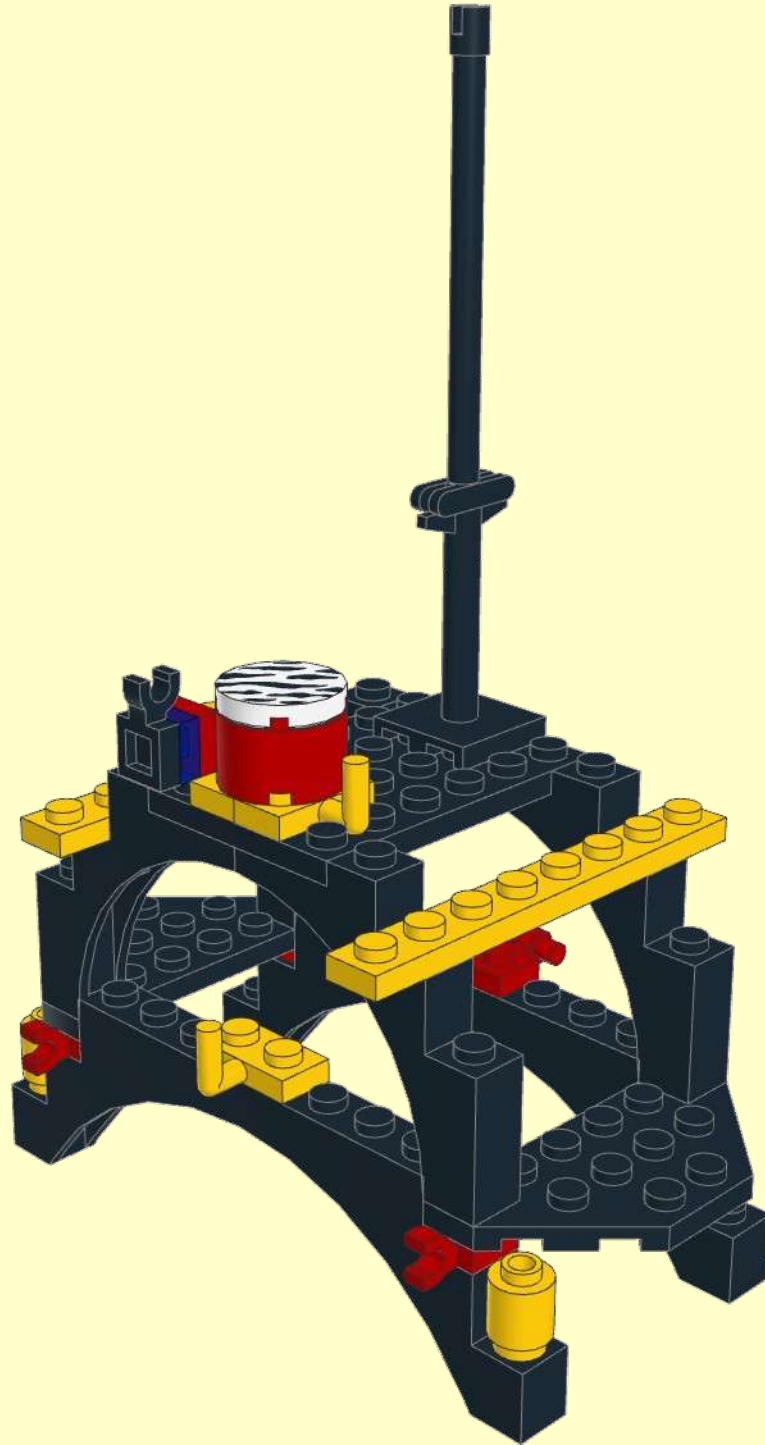
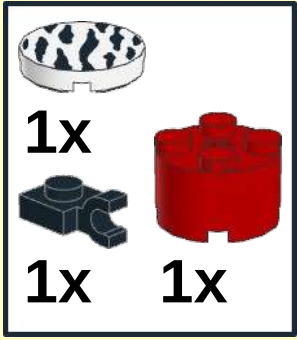



7

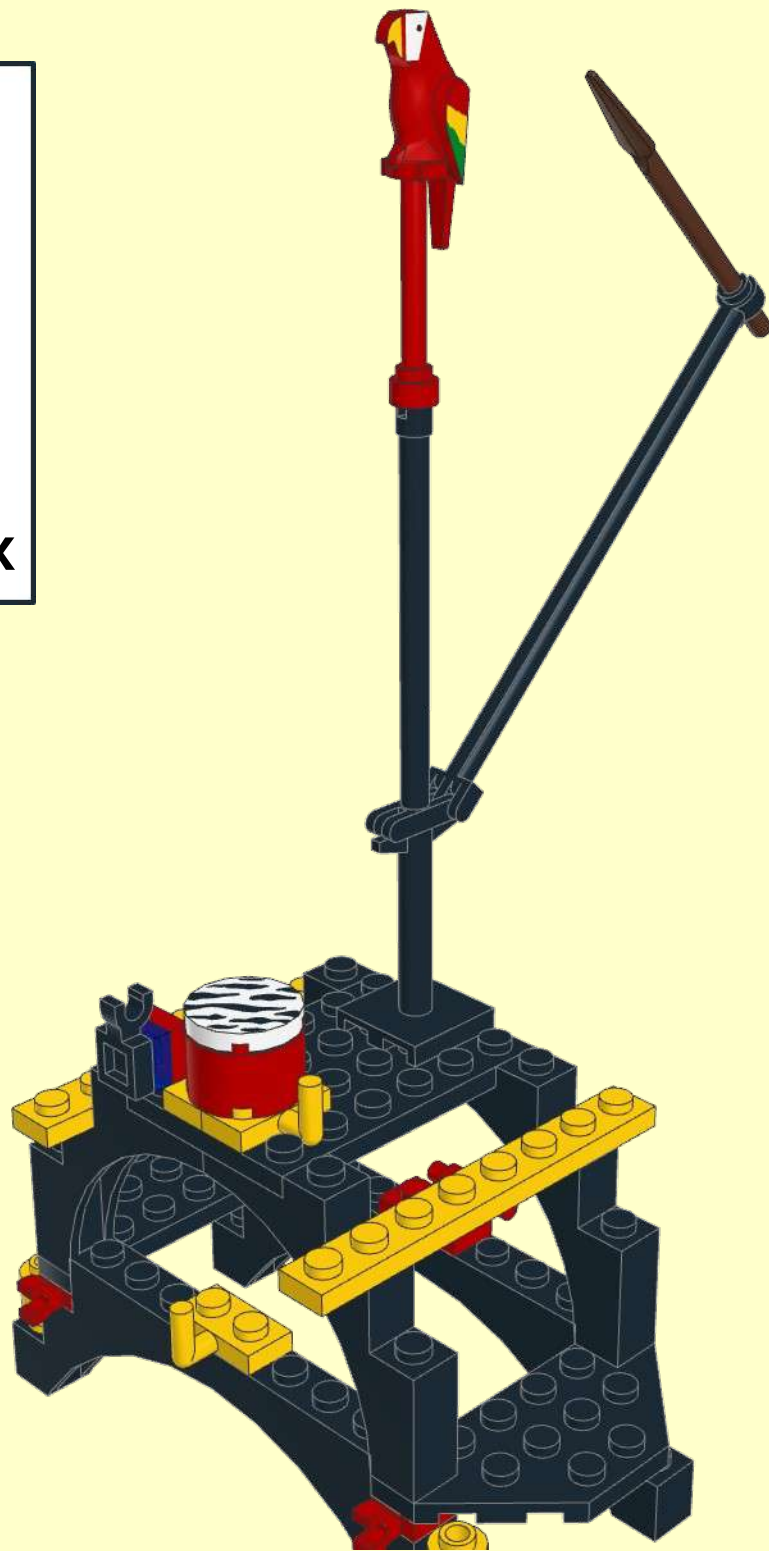
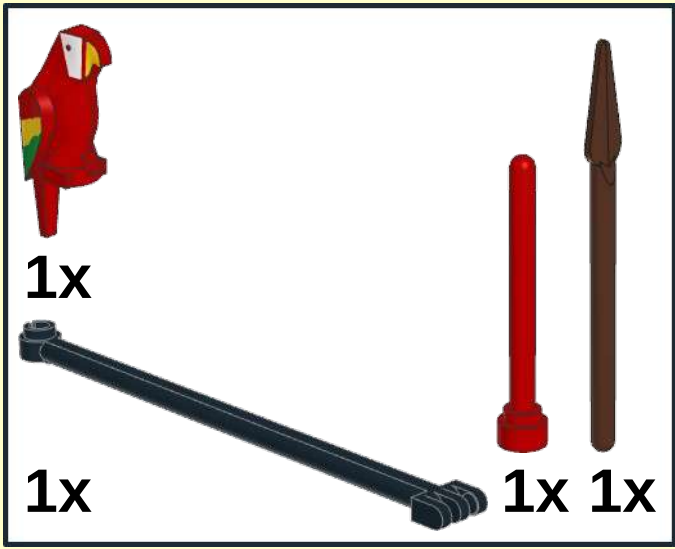

8



1x



3x





3

