

1

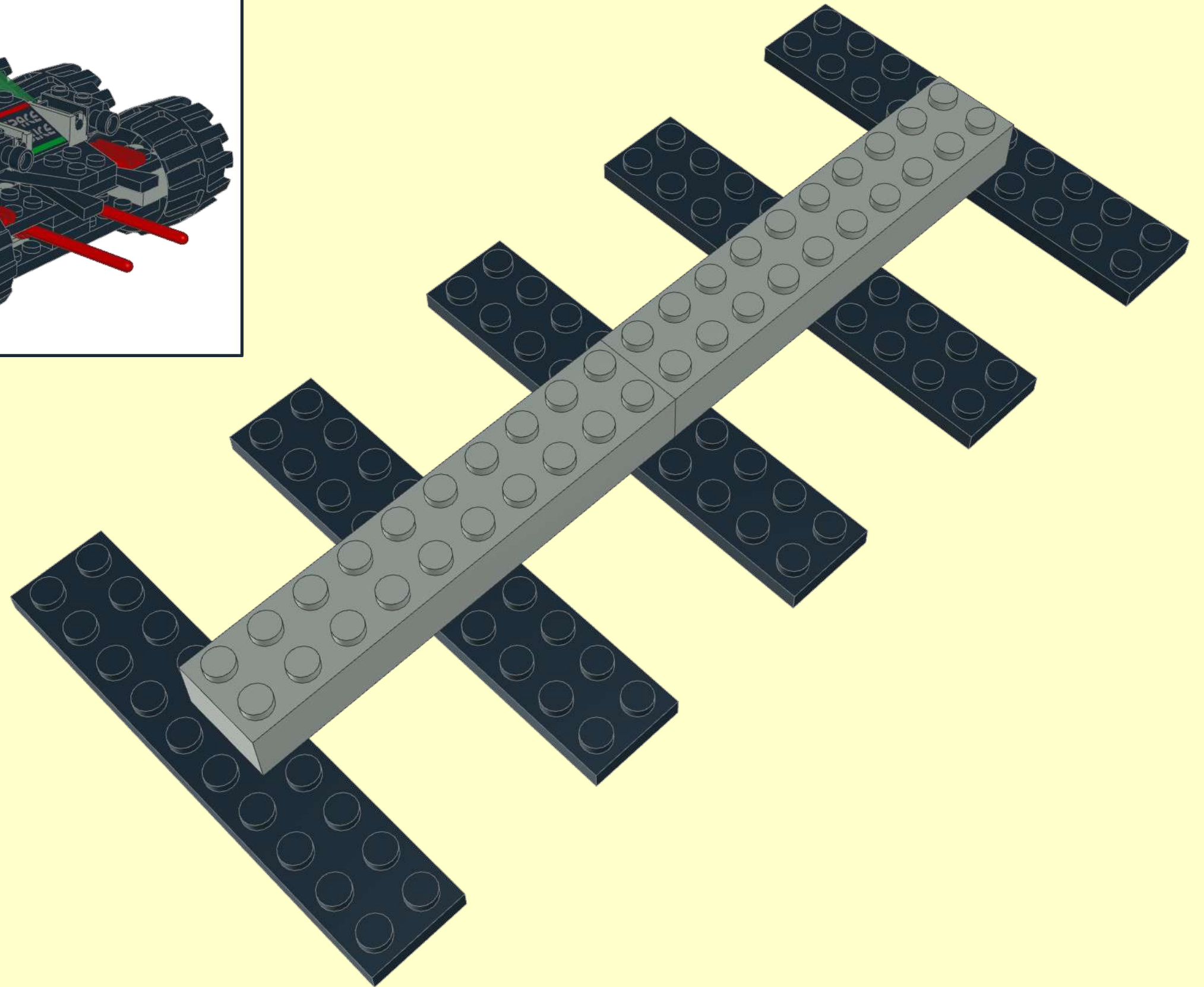

2

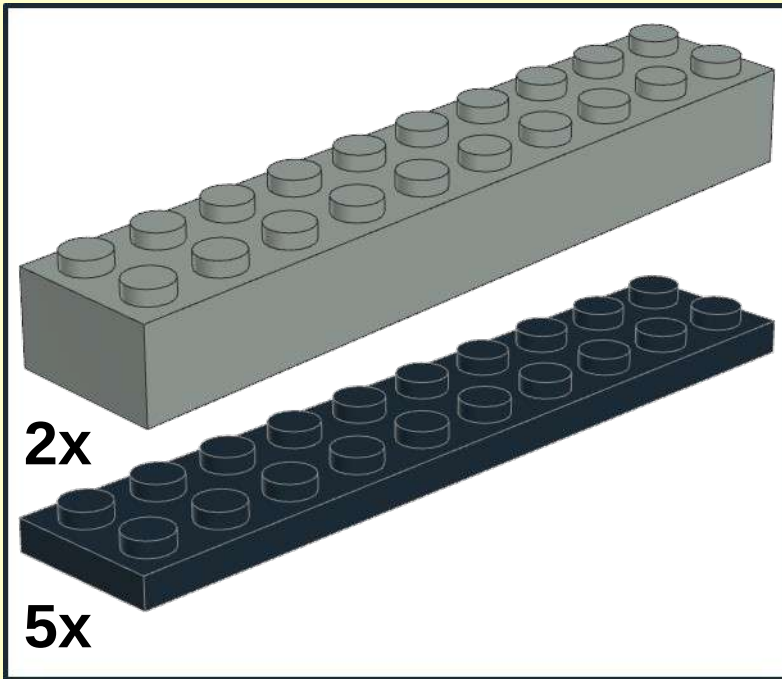
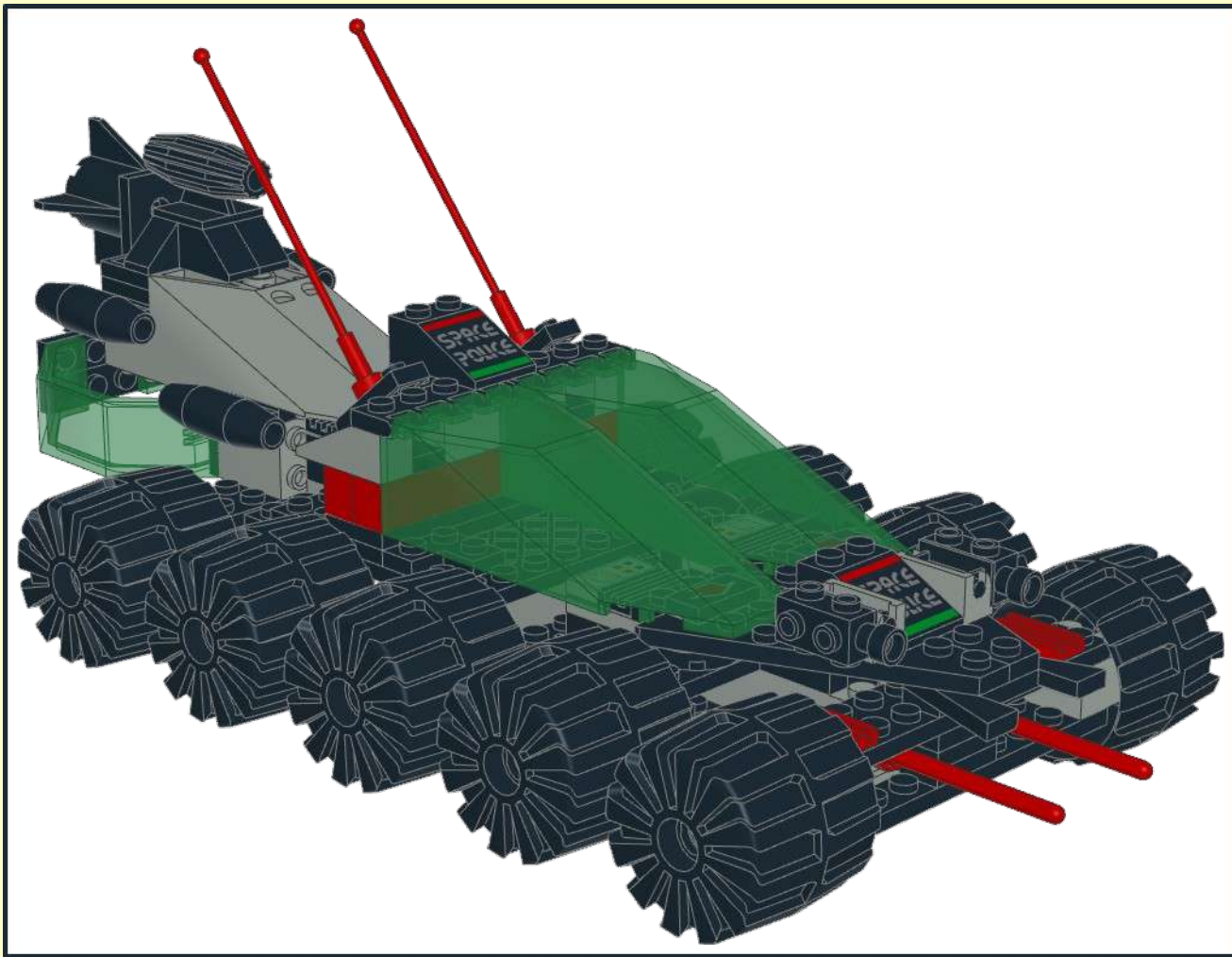
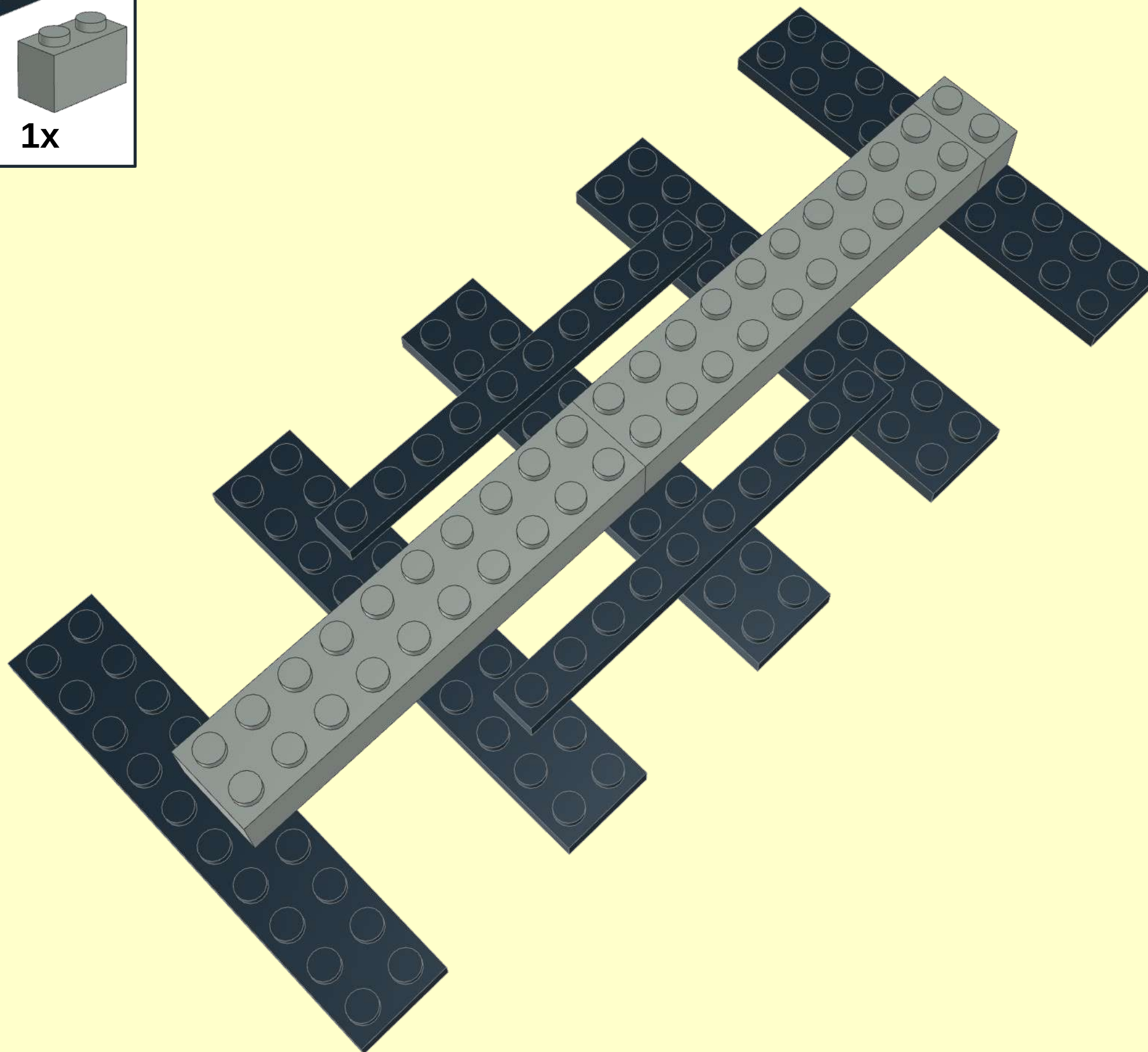
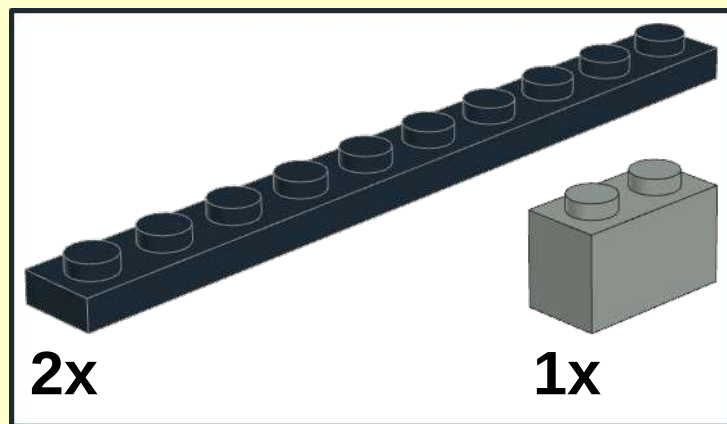

3

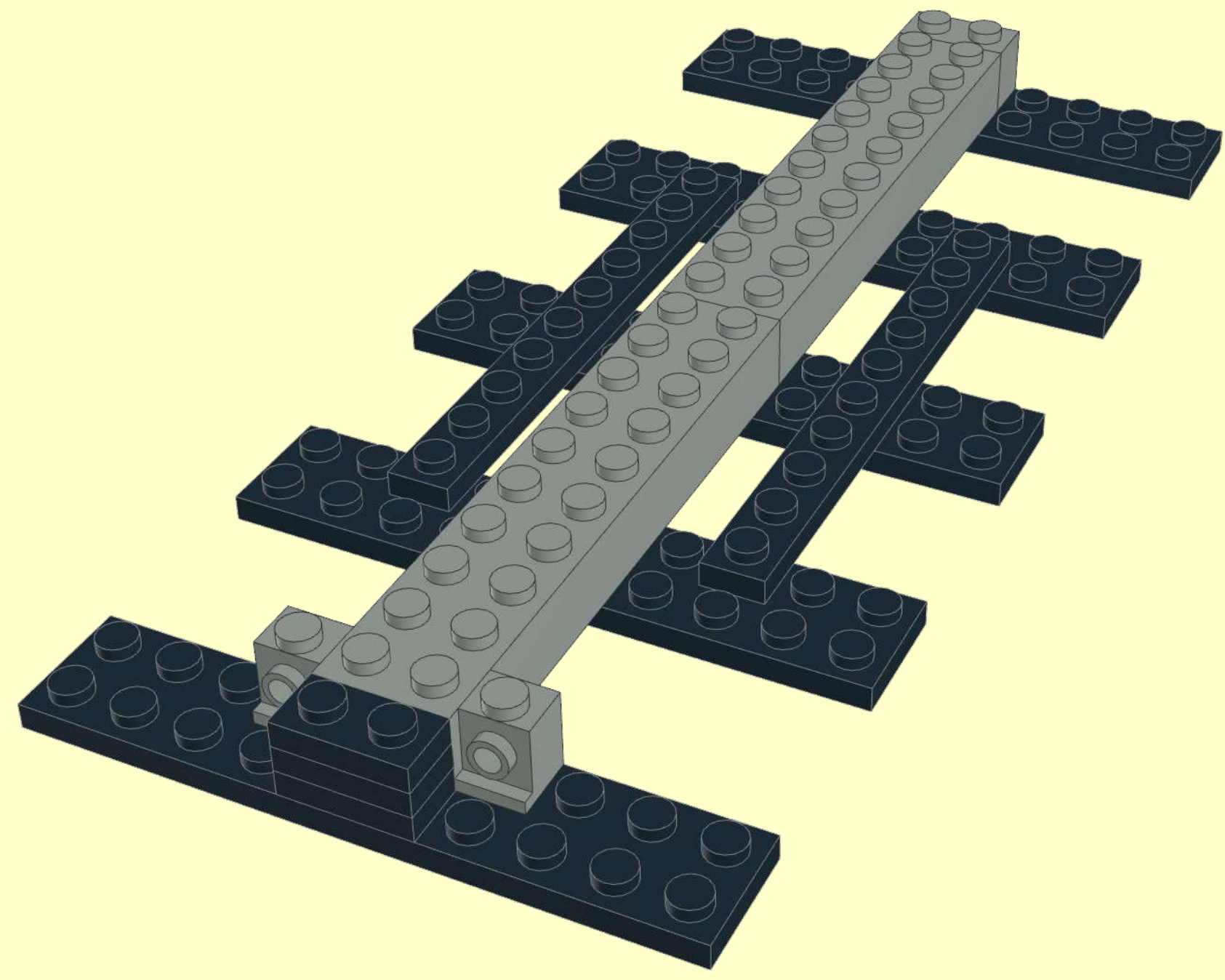
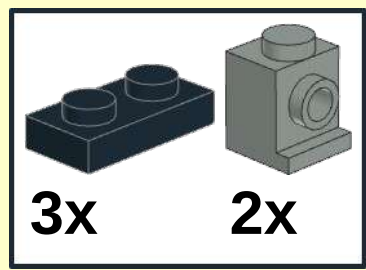

4

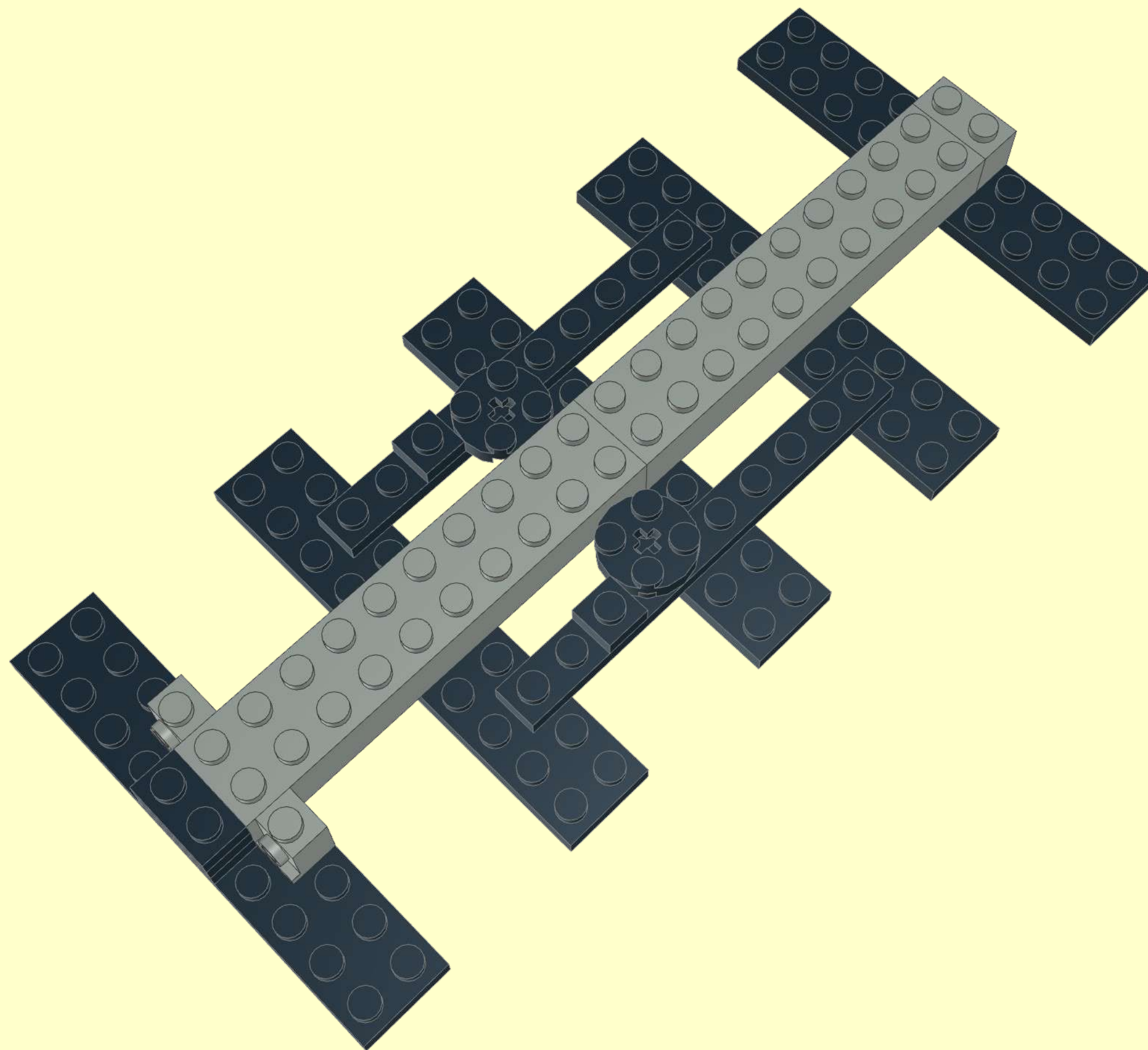
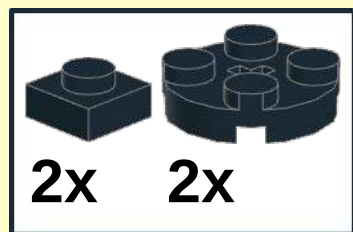



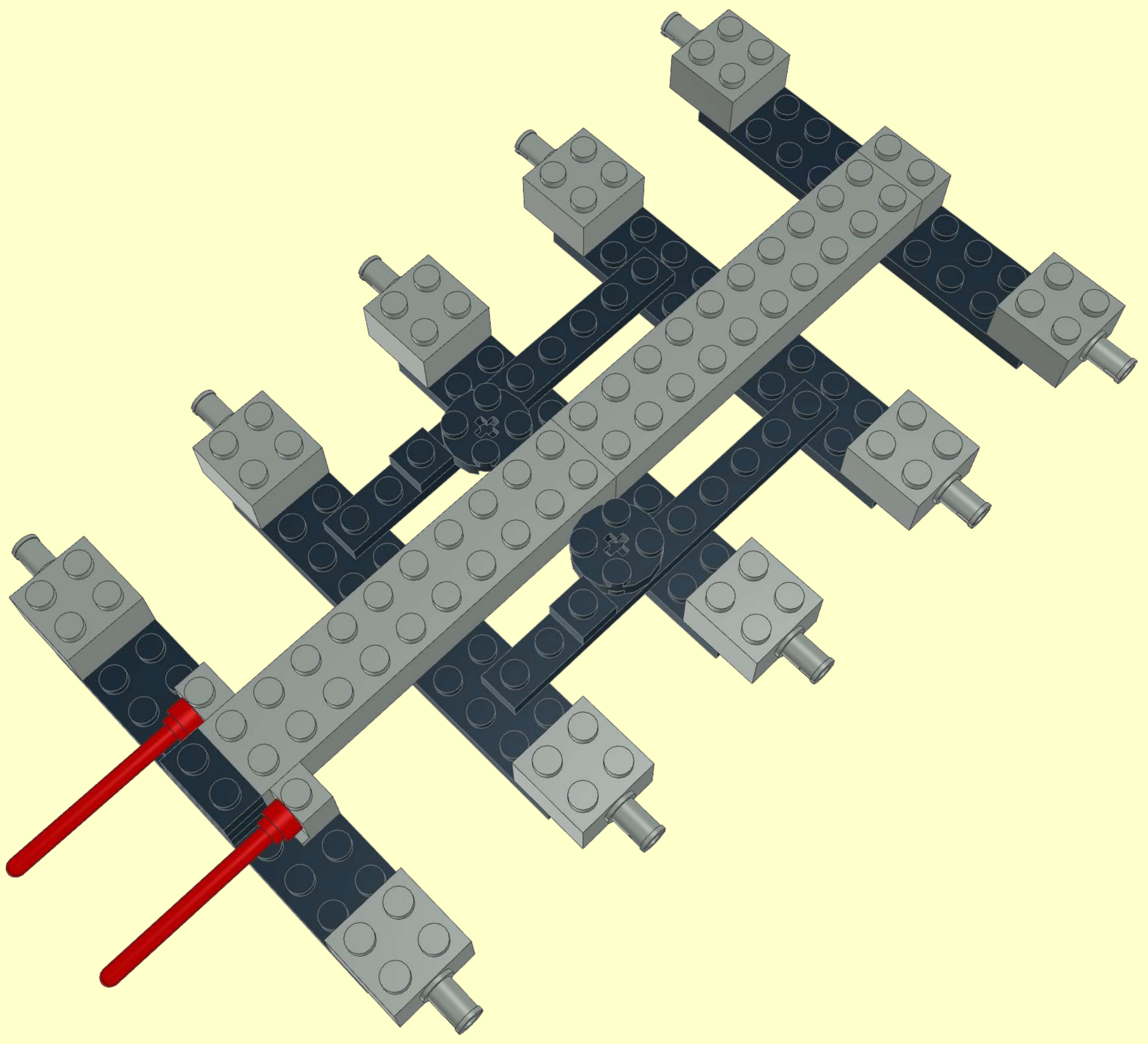
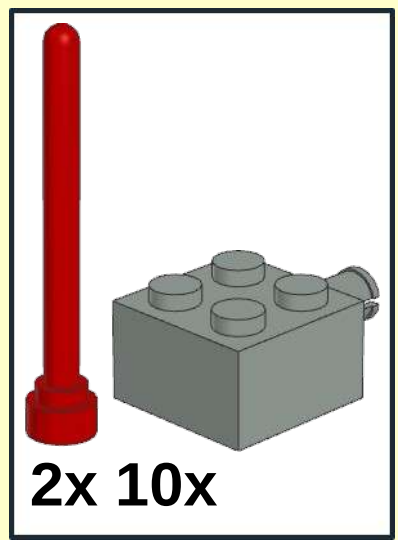

5

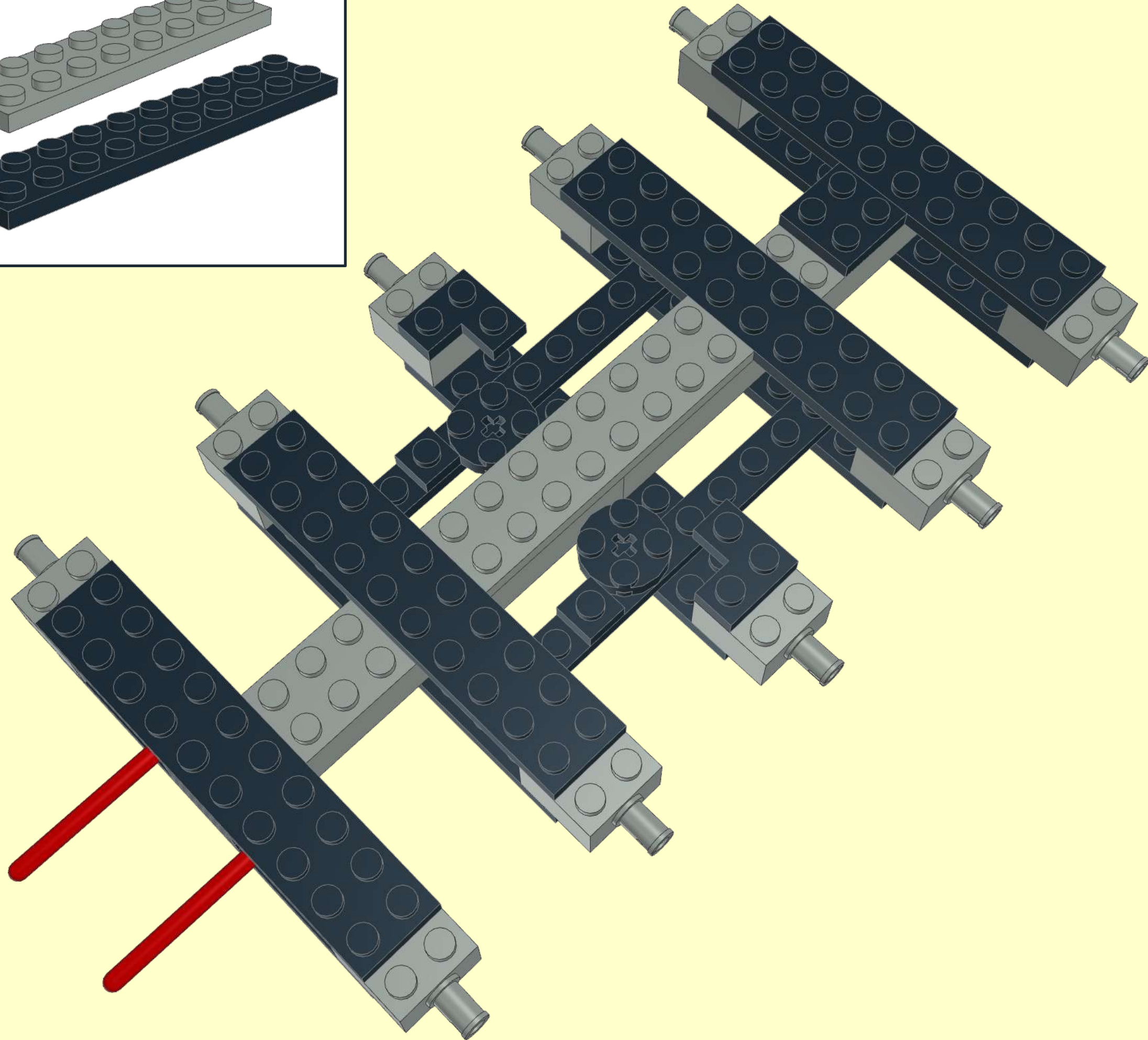
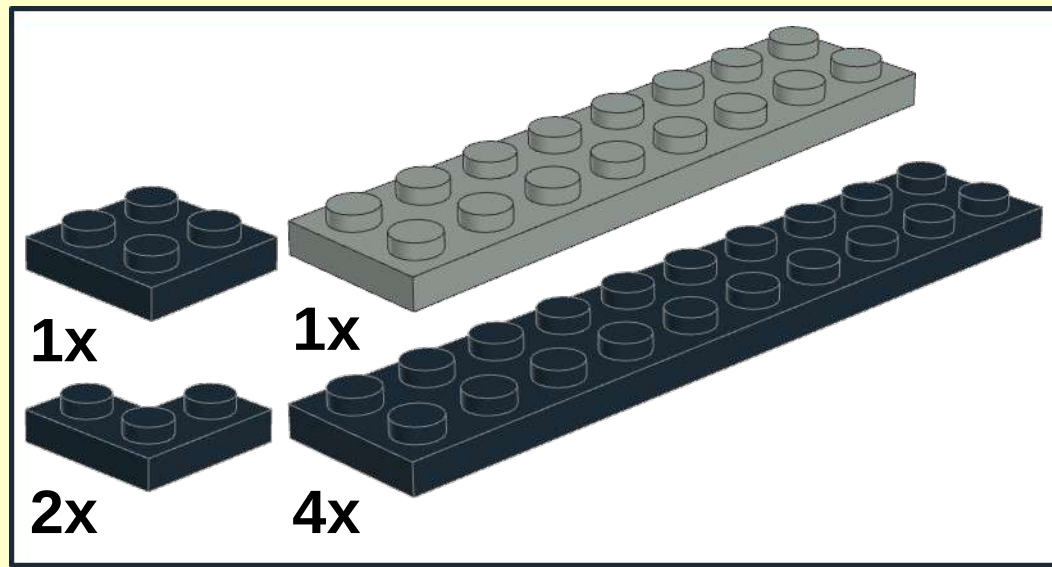

6

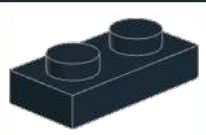

7

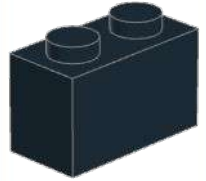

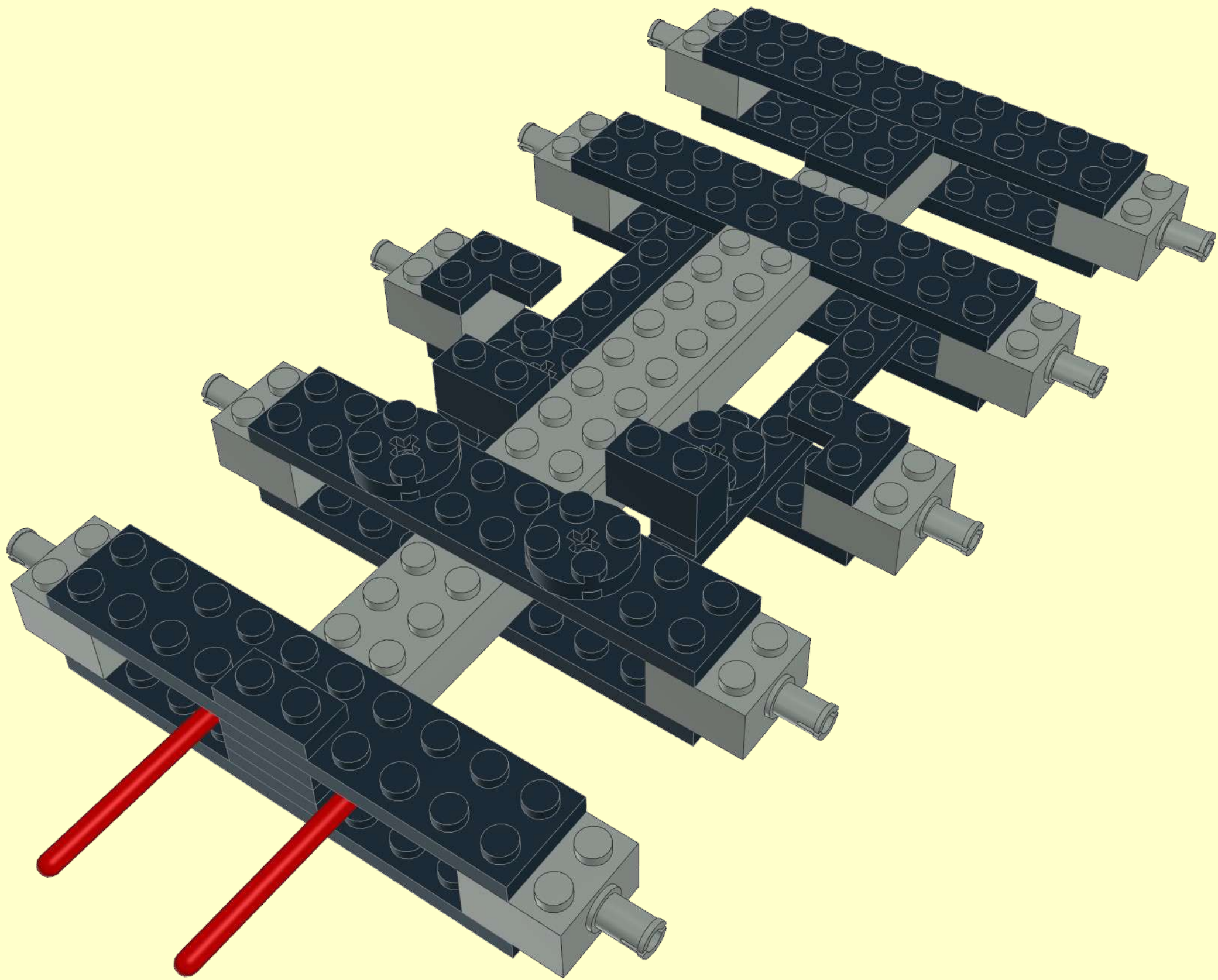
-  1x
-  2x
-  2x

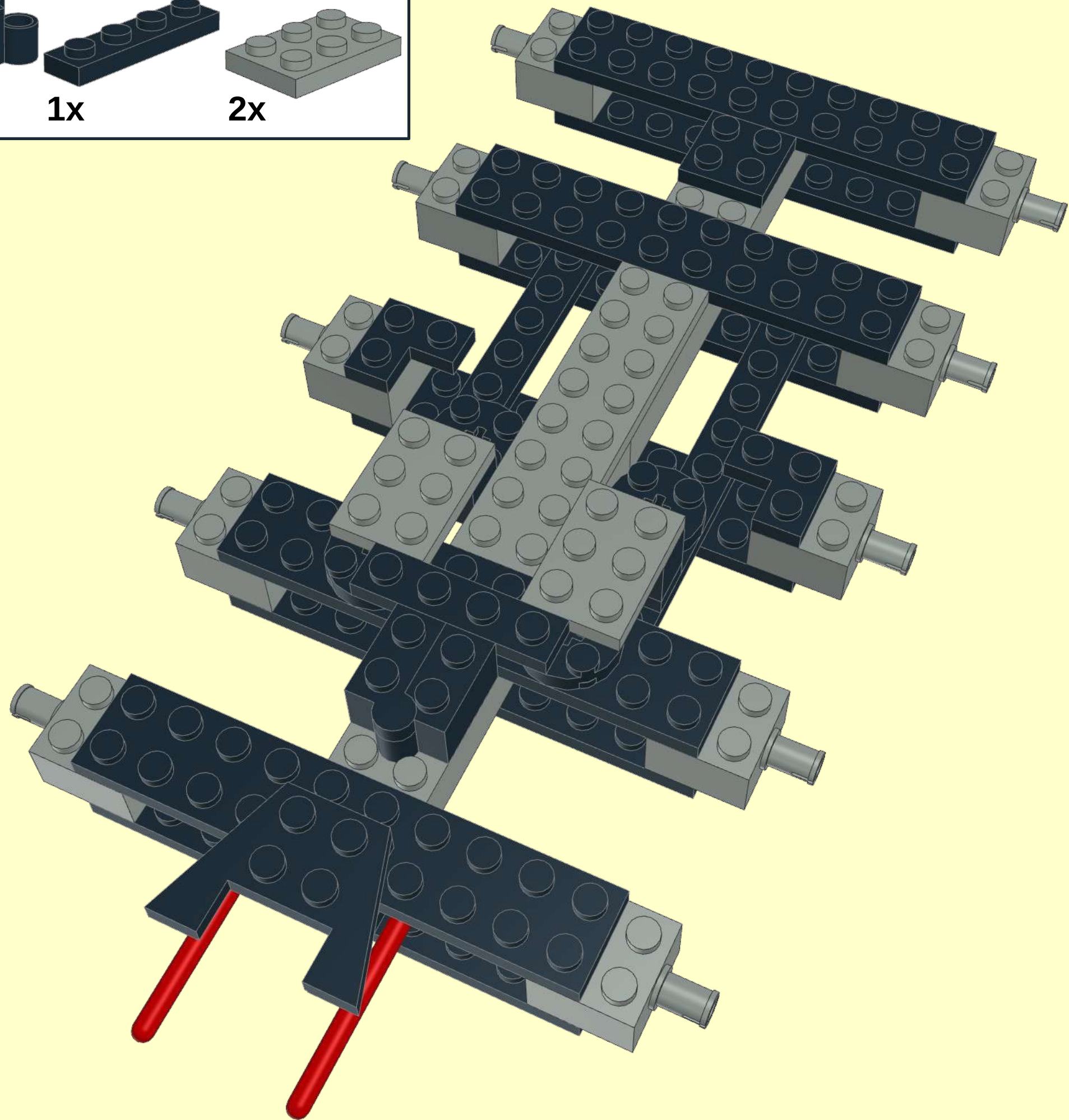
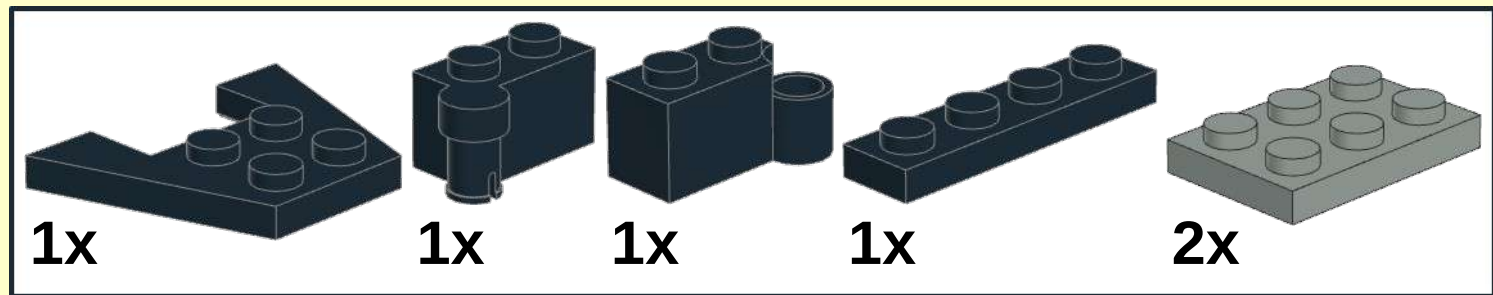

8

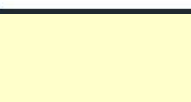

9

-  2x
-  2x
-  2x
-  2x

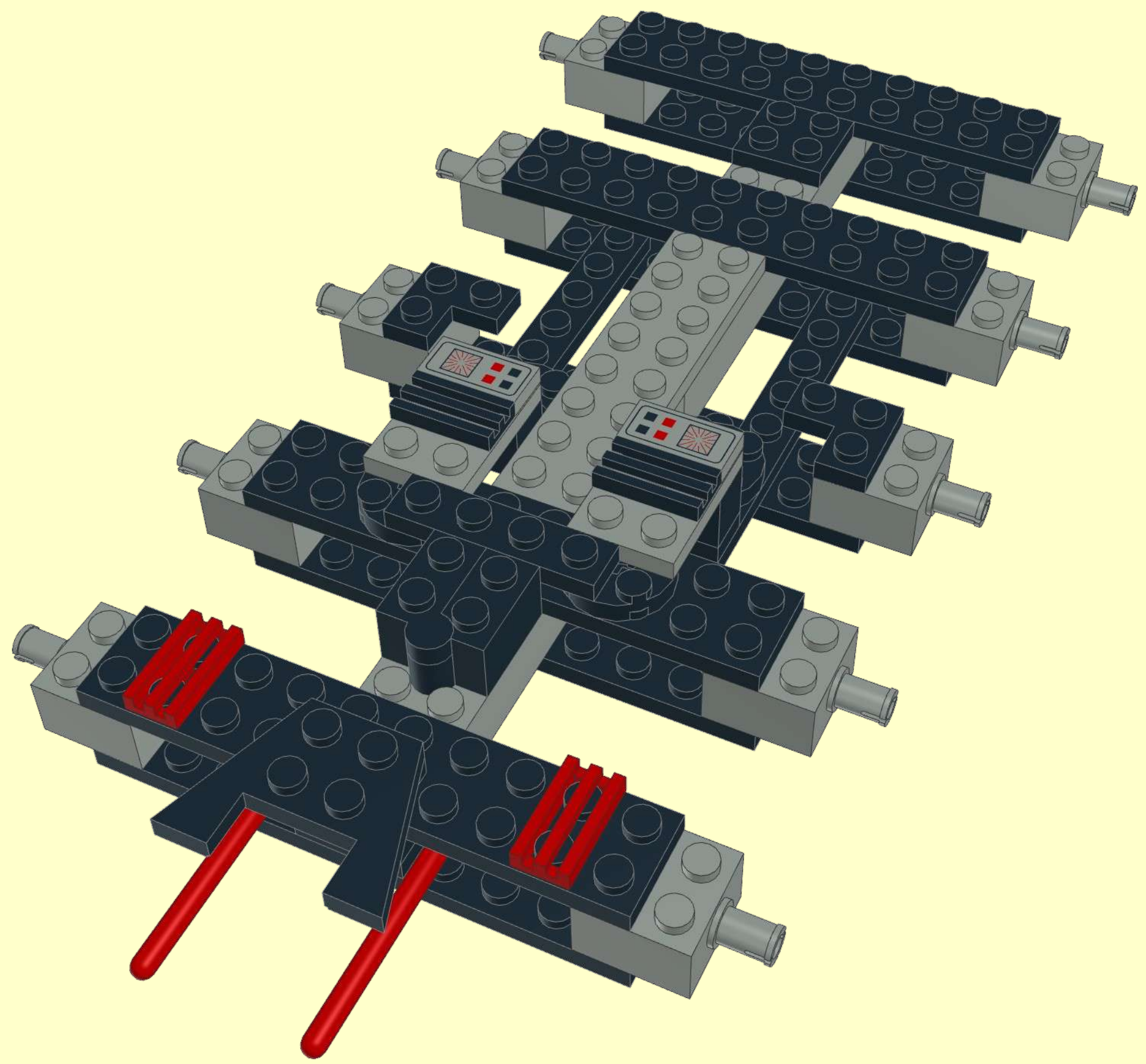

10

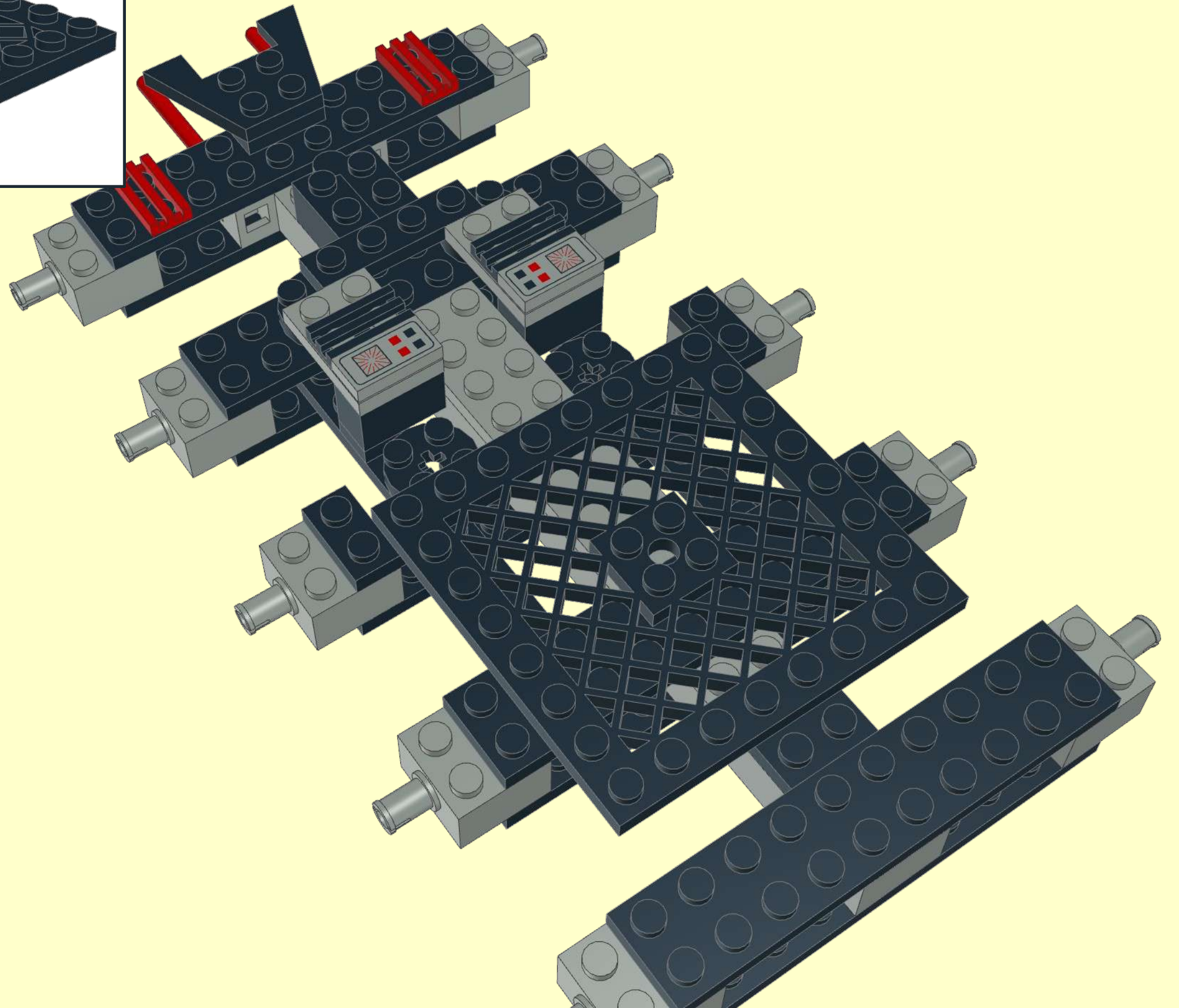
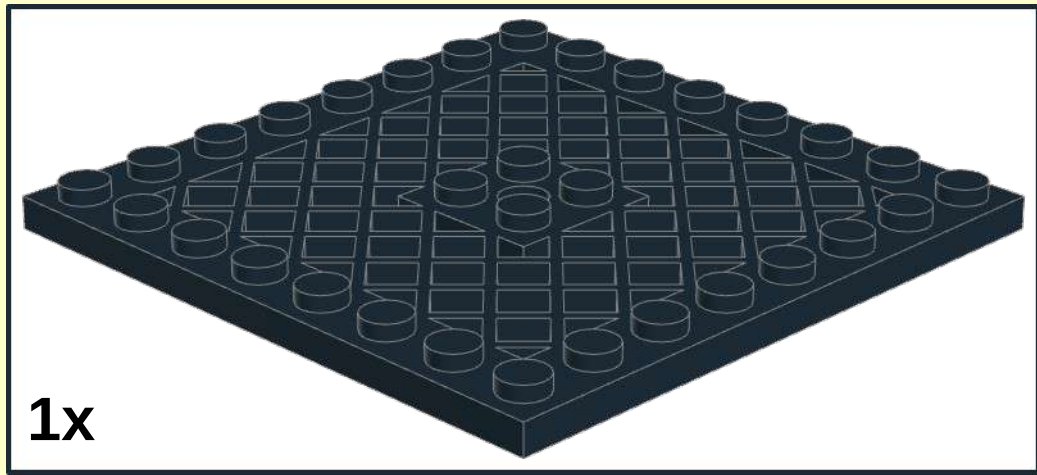

11

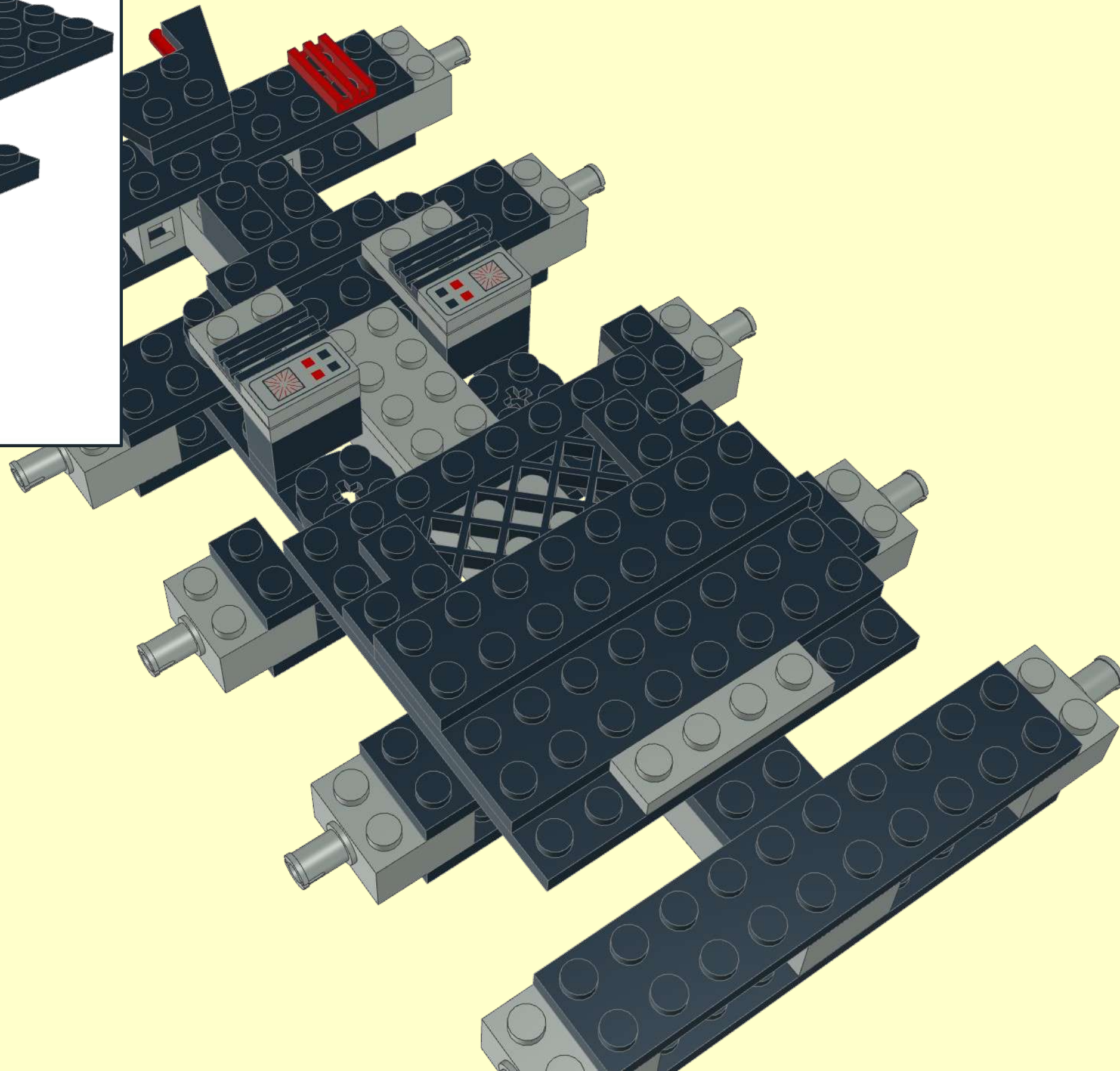
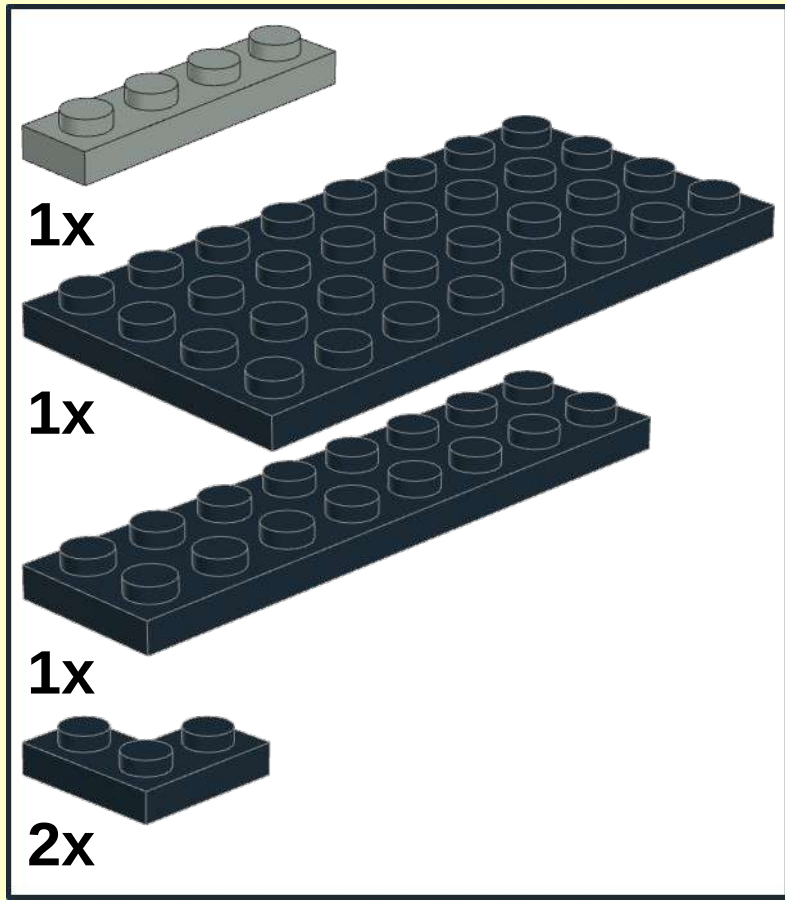

12

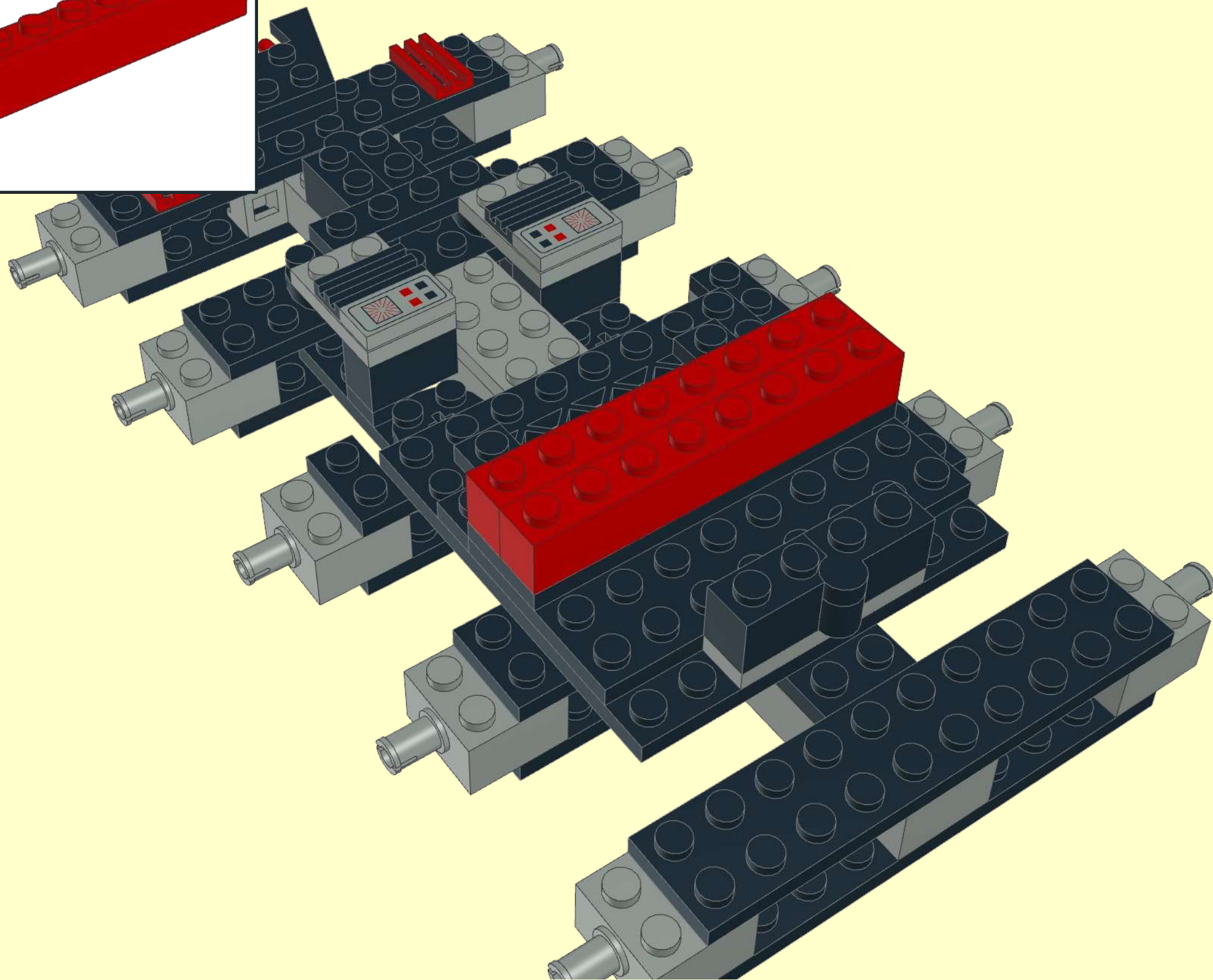
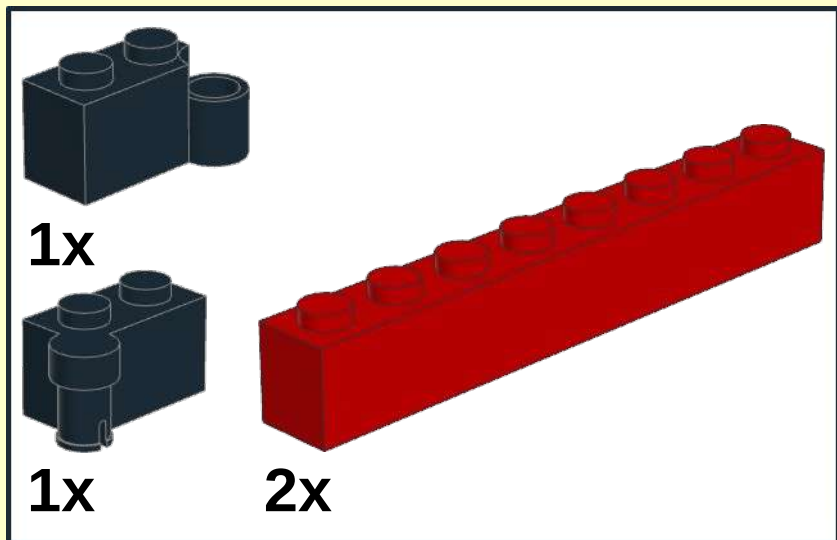



13

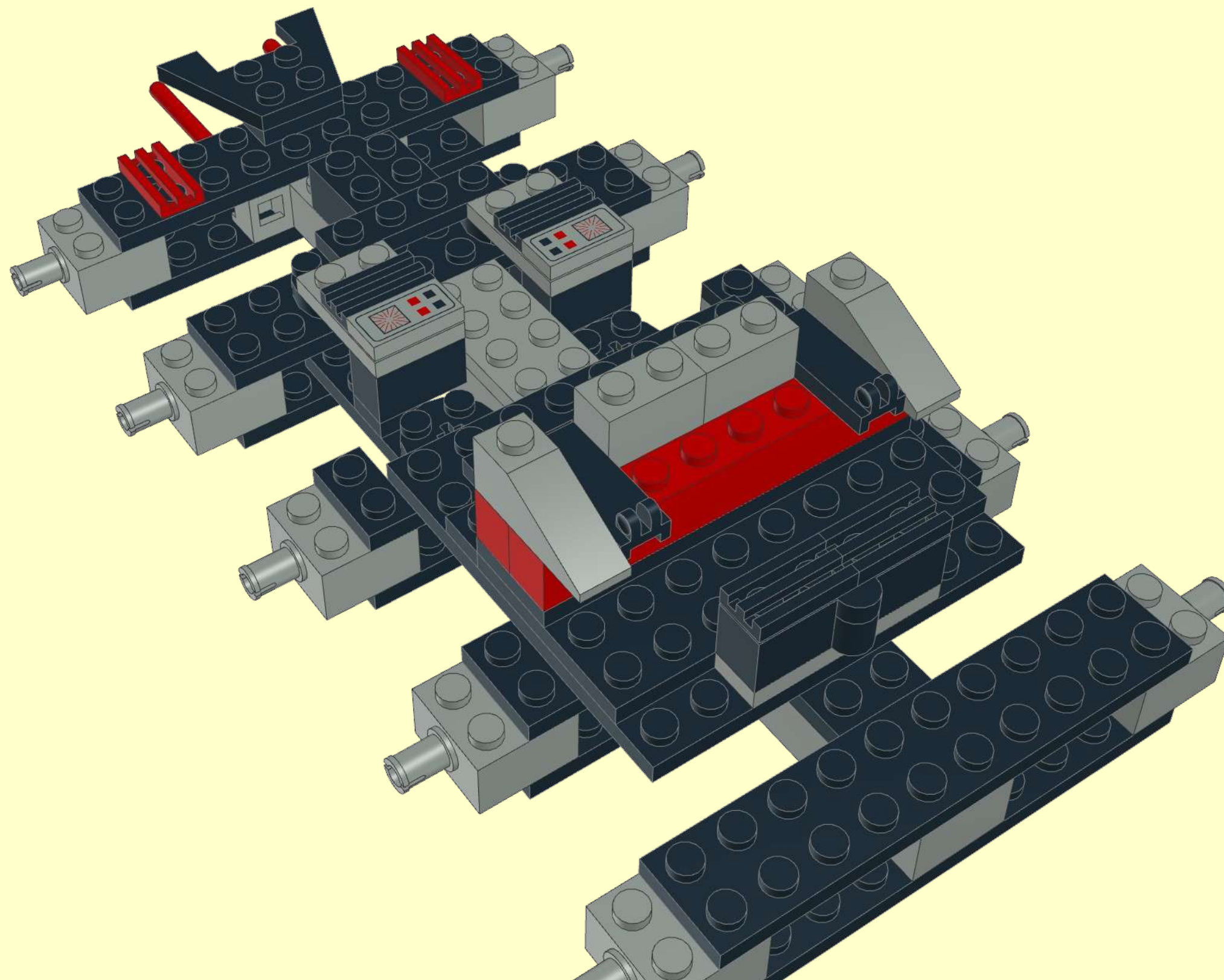
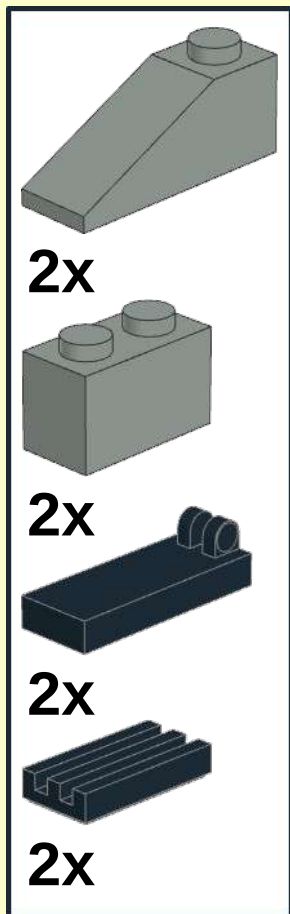

14

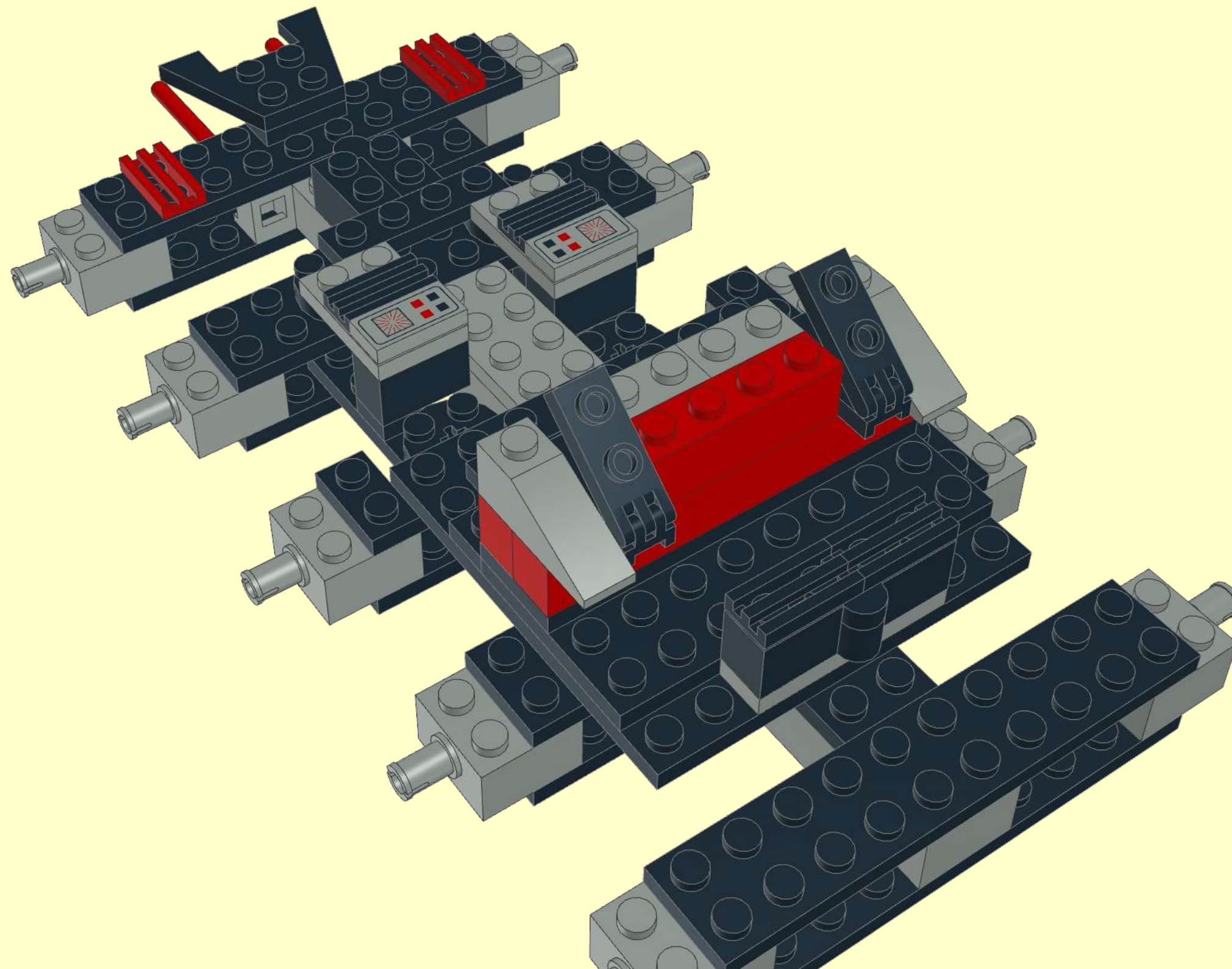
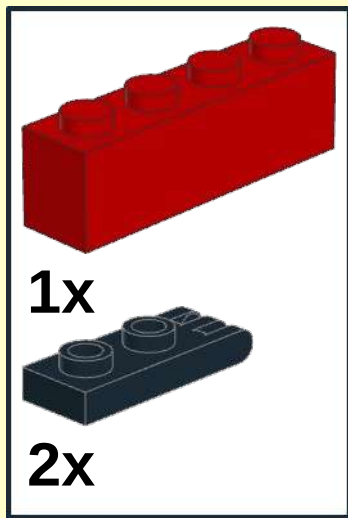

15

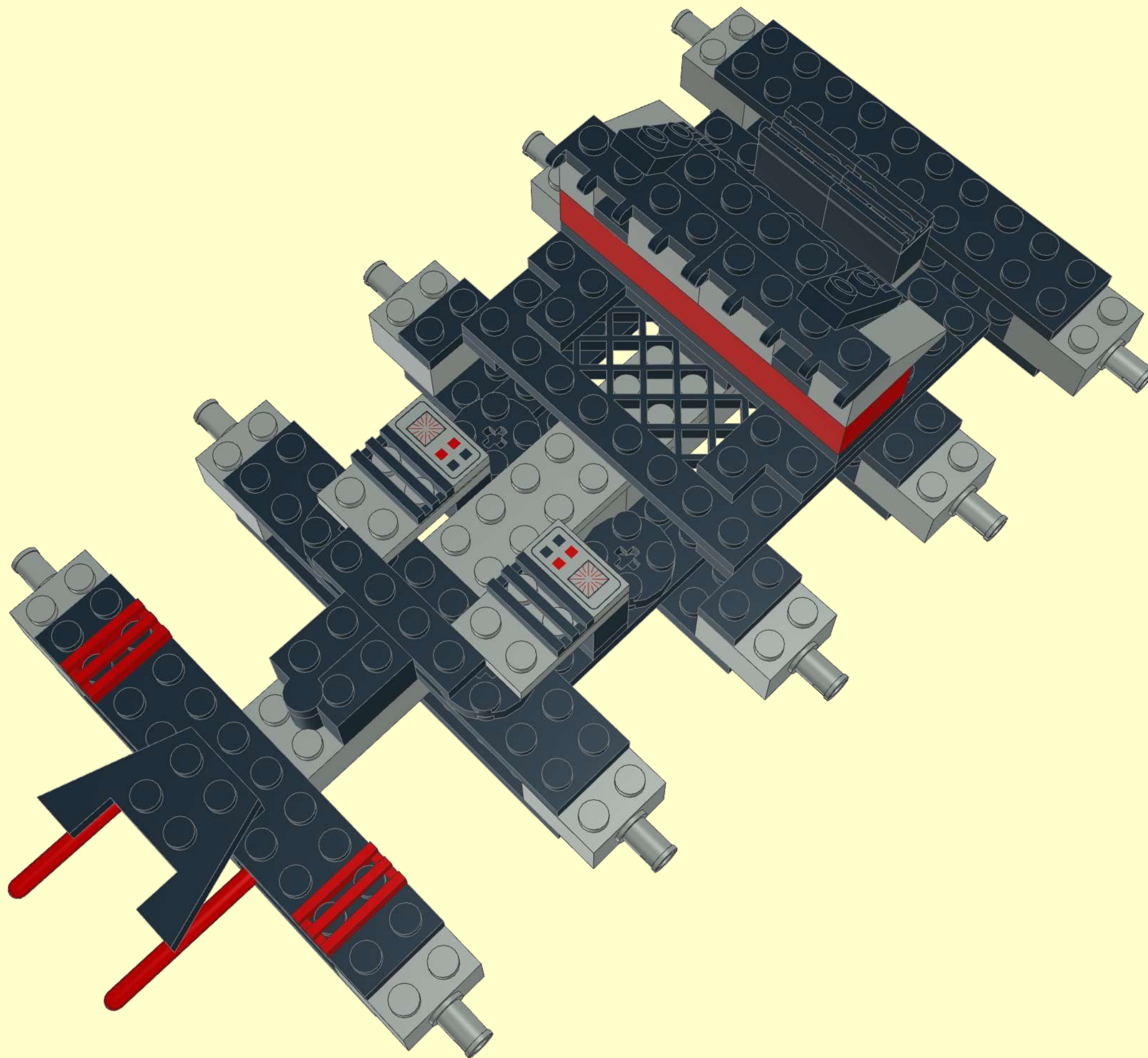
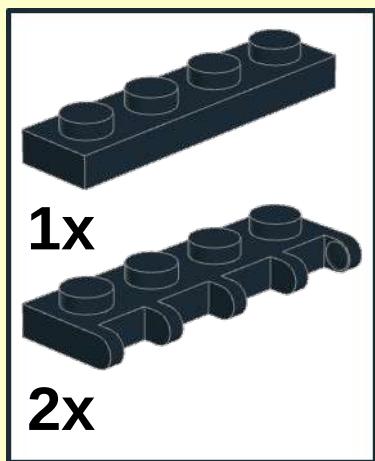

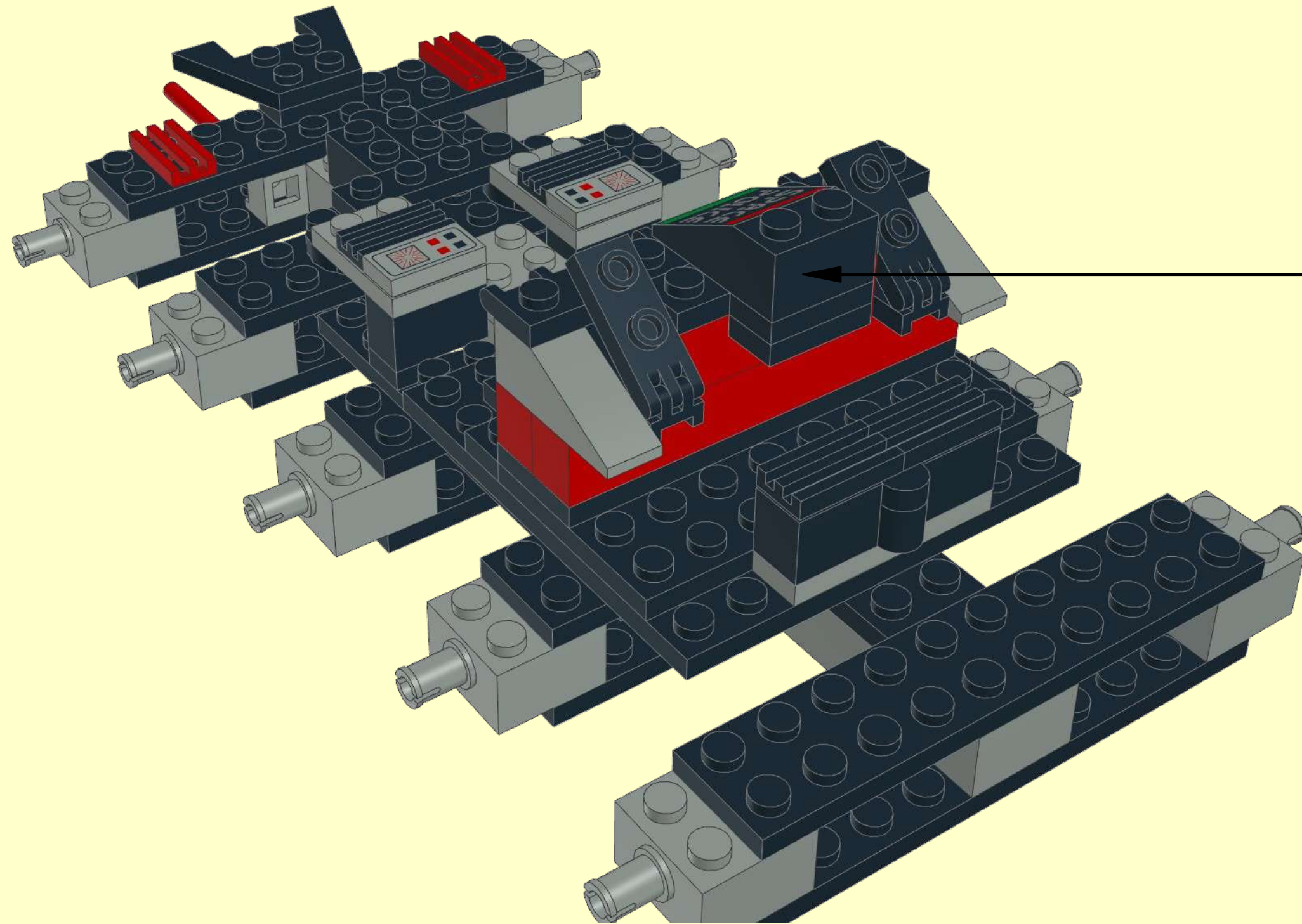

1

2x

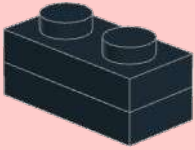
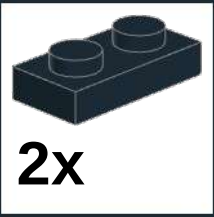

2

1x

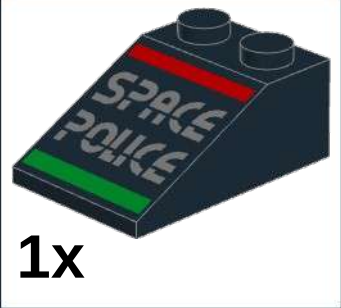

17

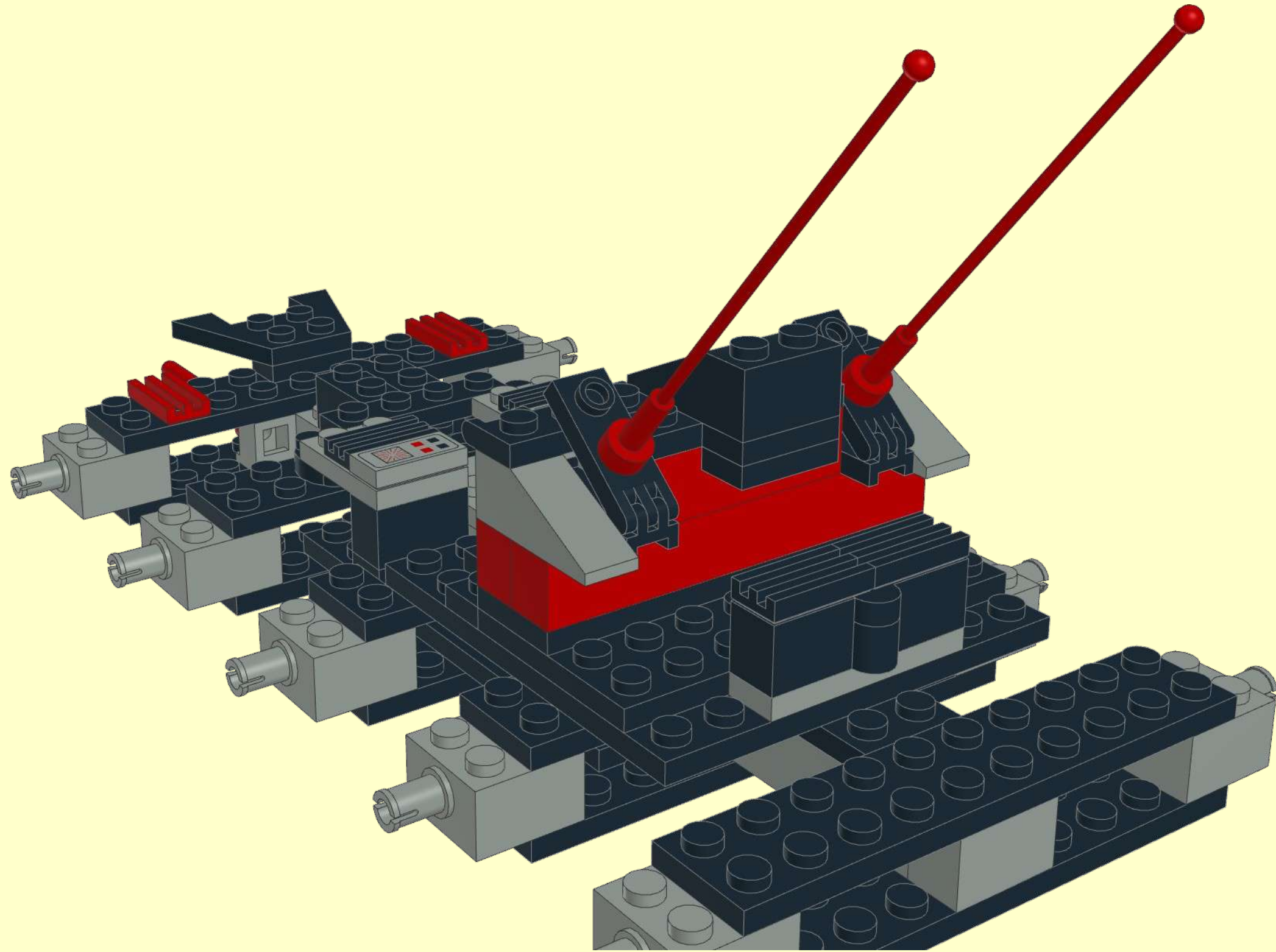
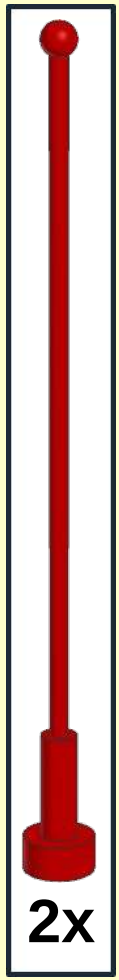

18

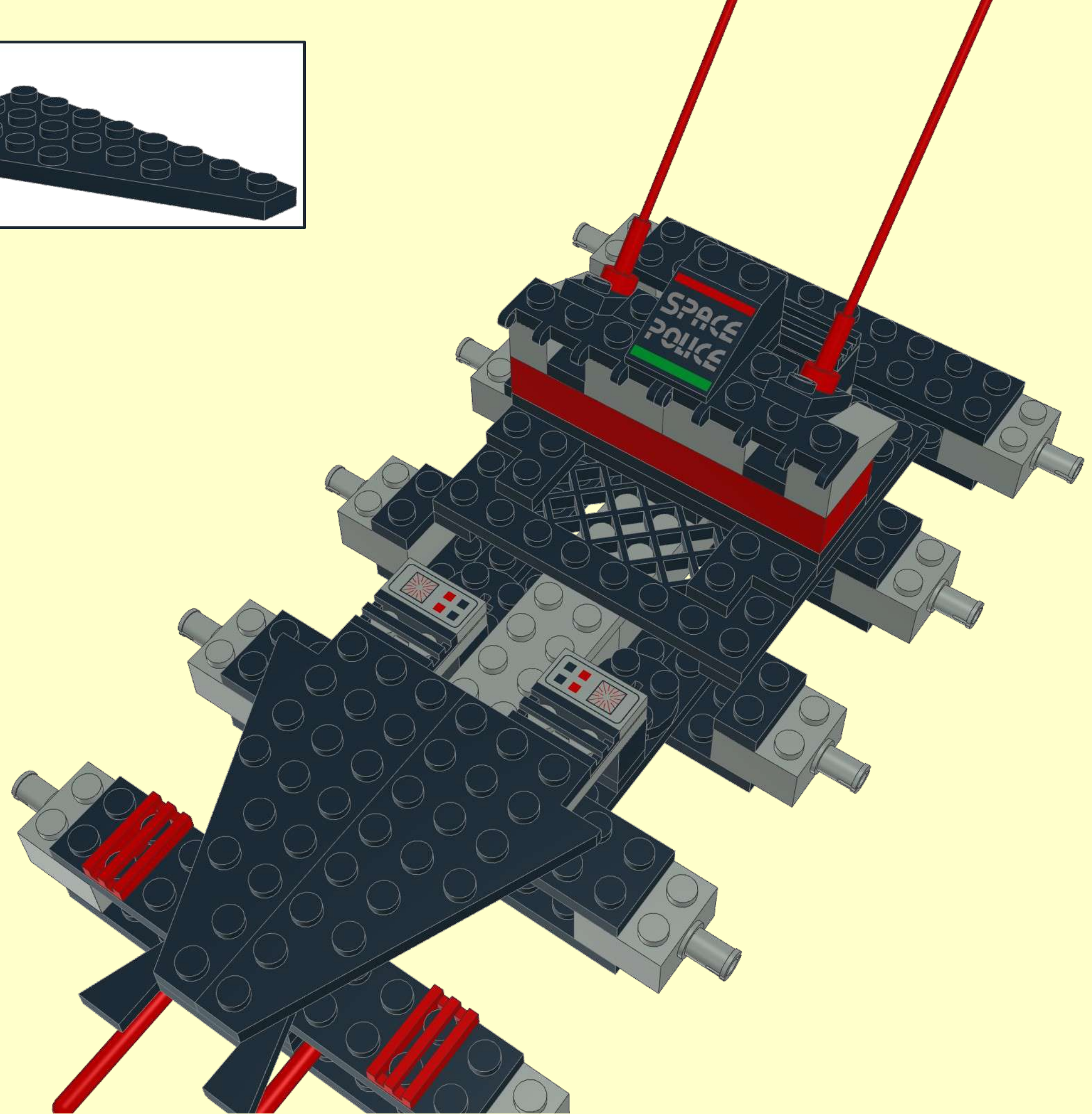
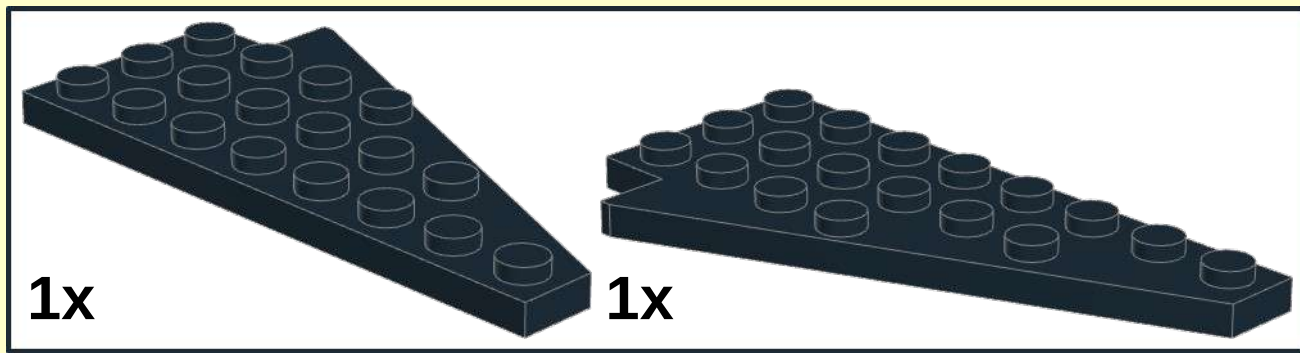

19

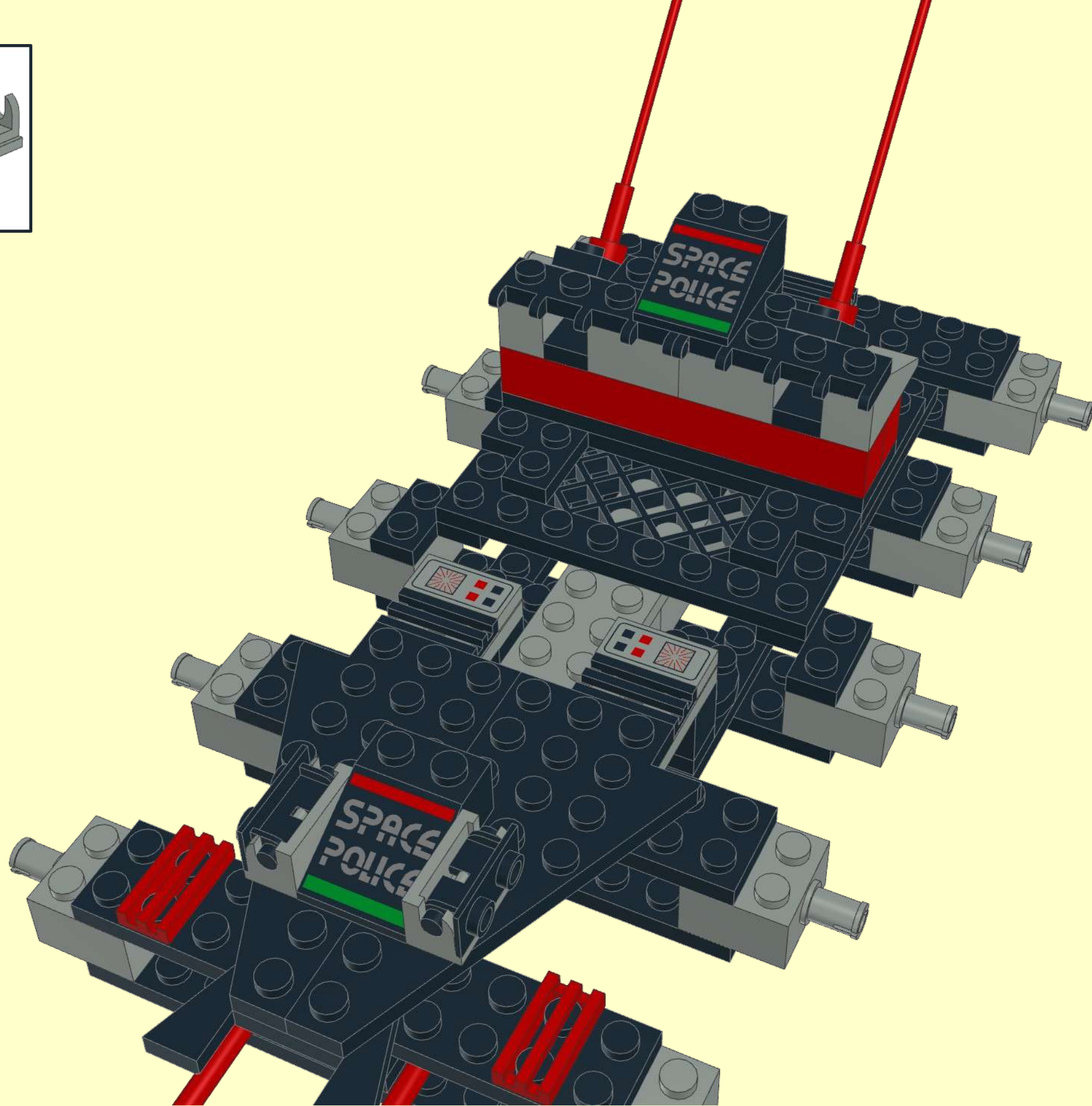
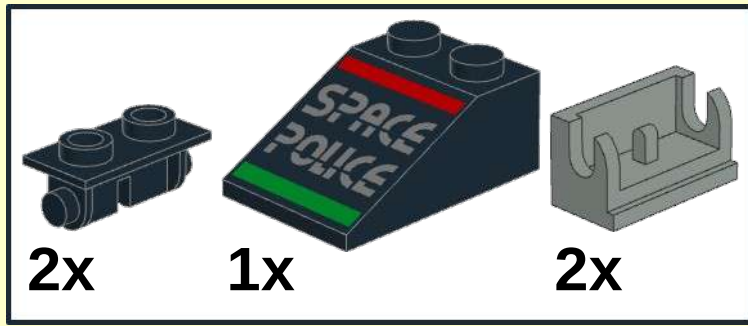

20

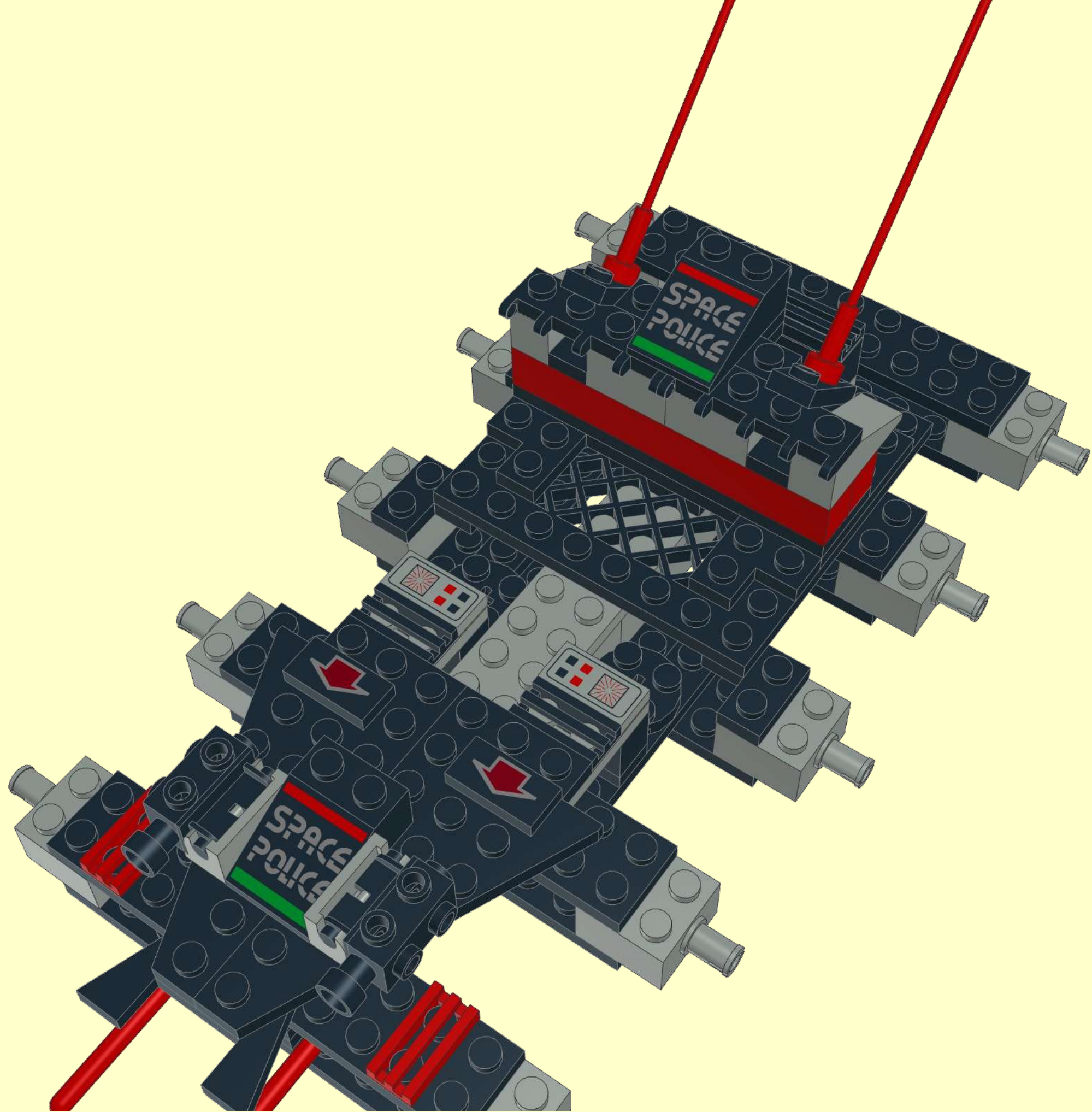



21

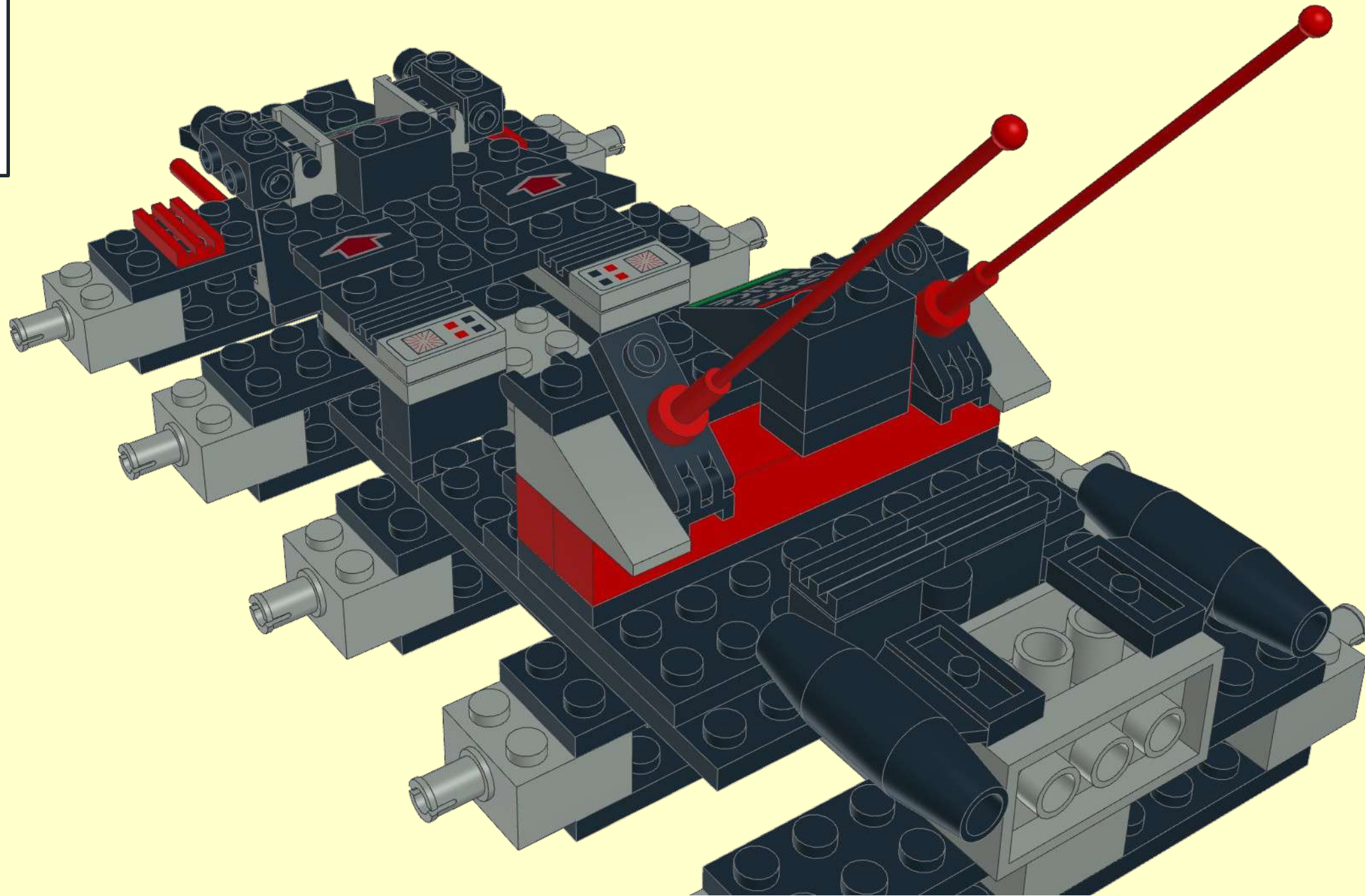
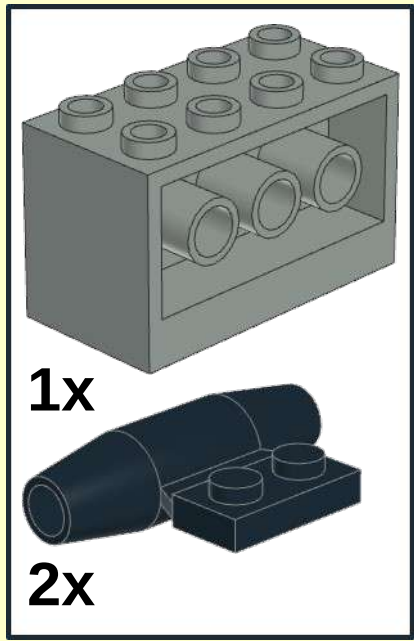

1

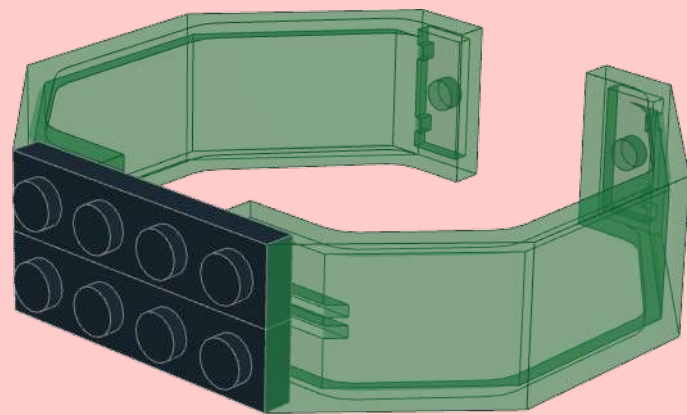
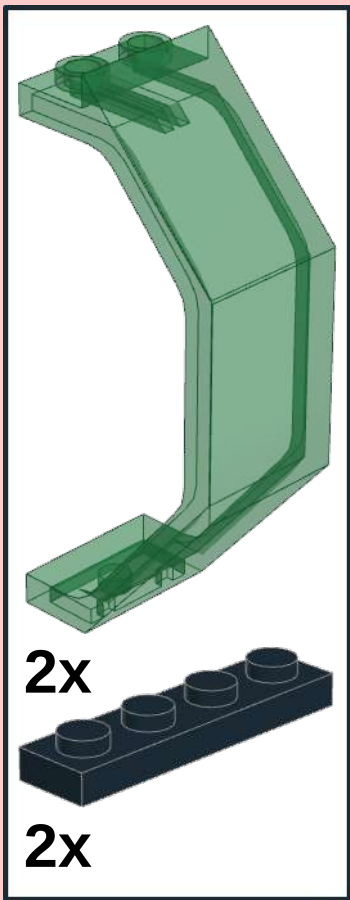
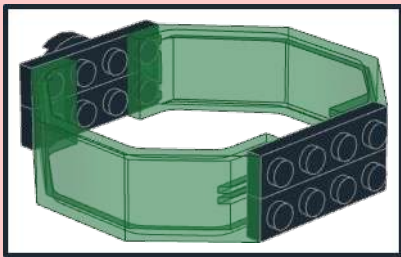

2

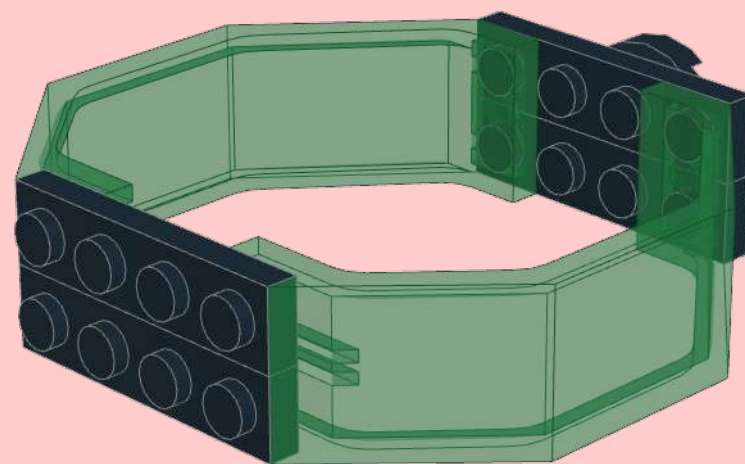
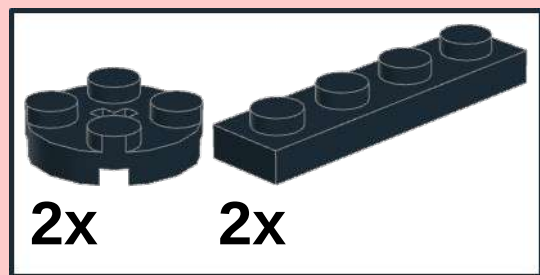

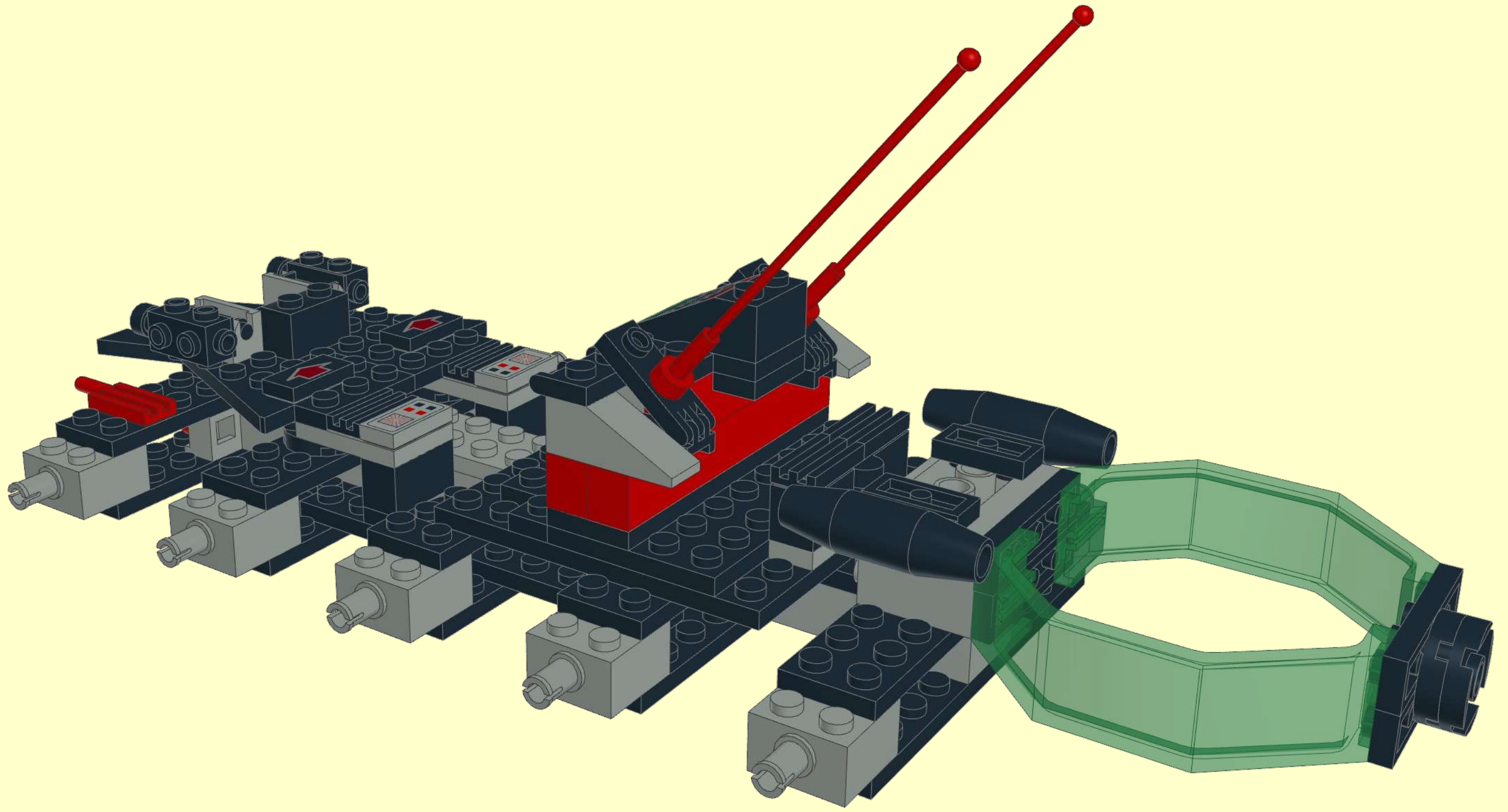

23

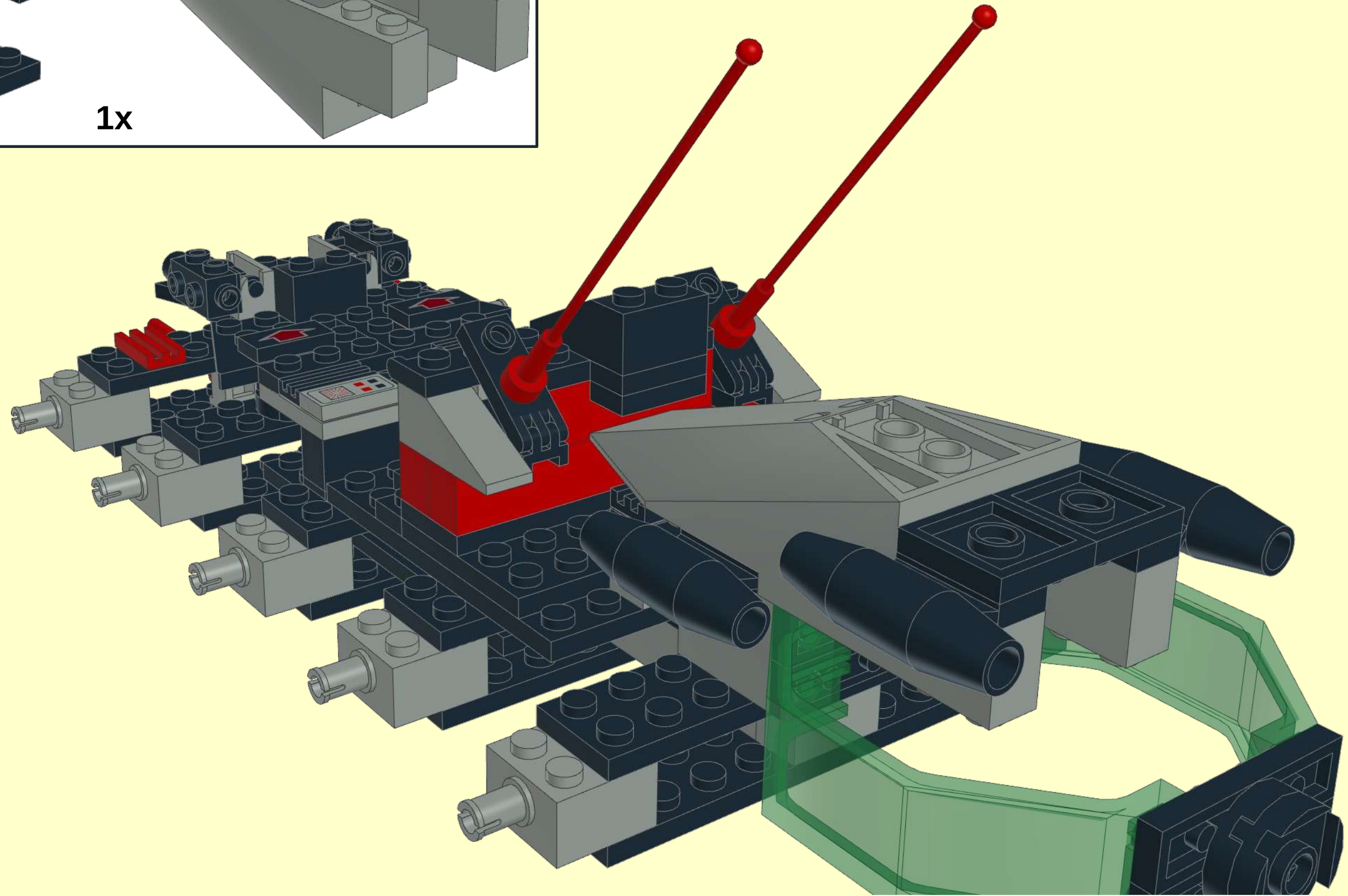
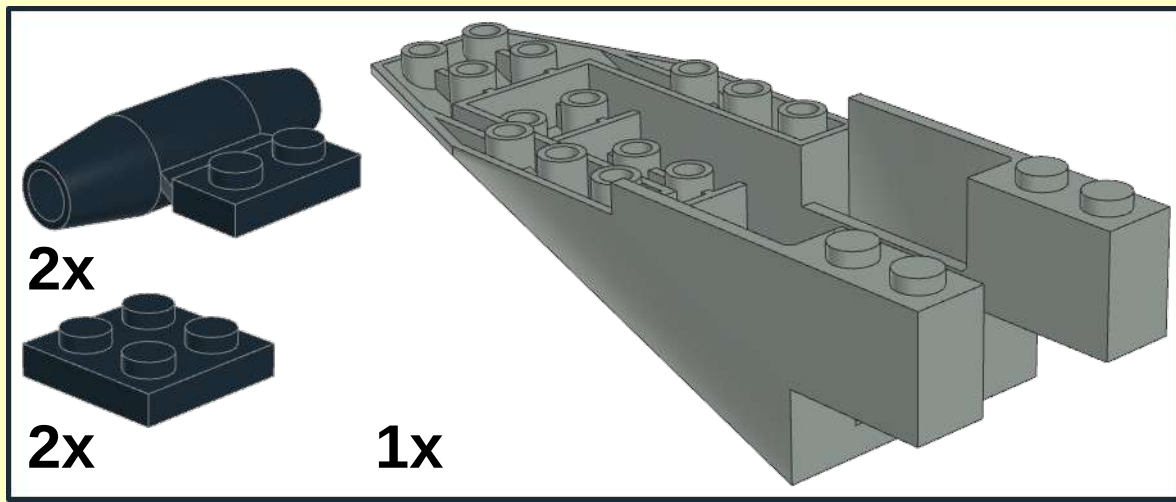

24

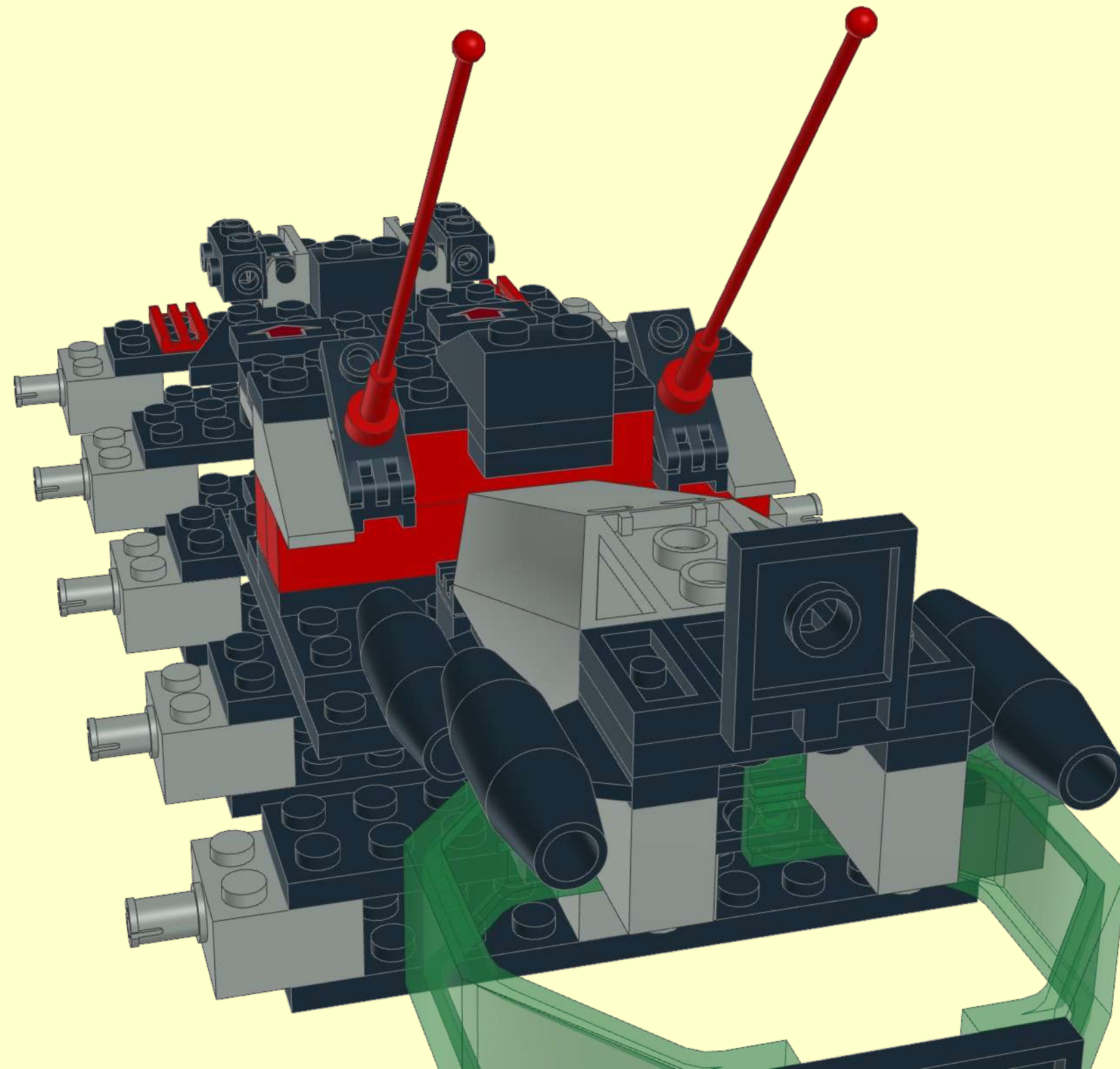
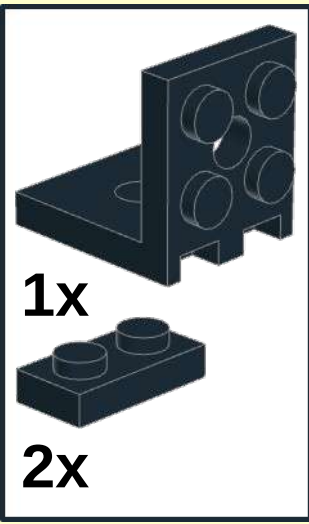

25

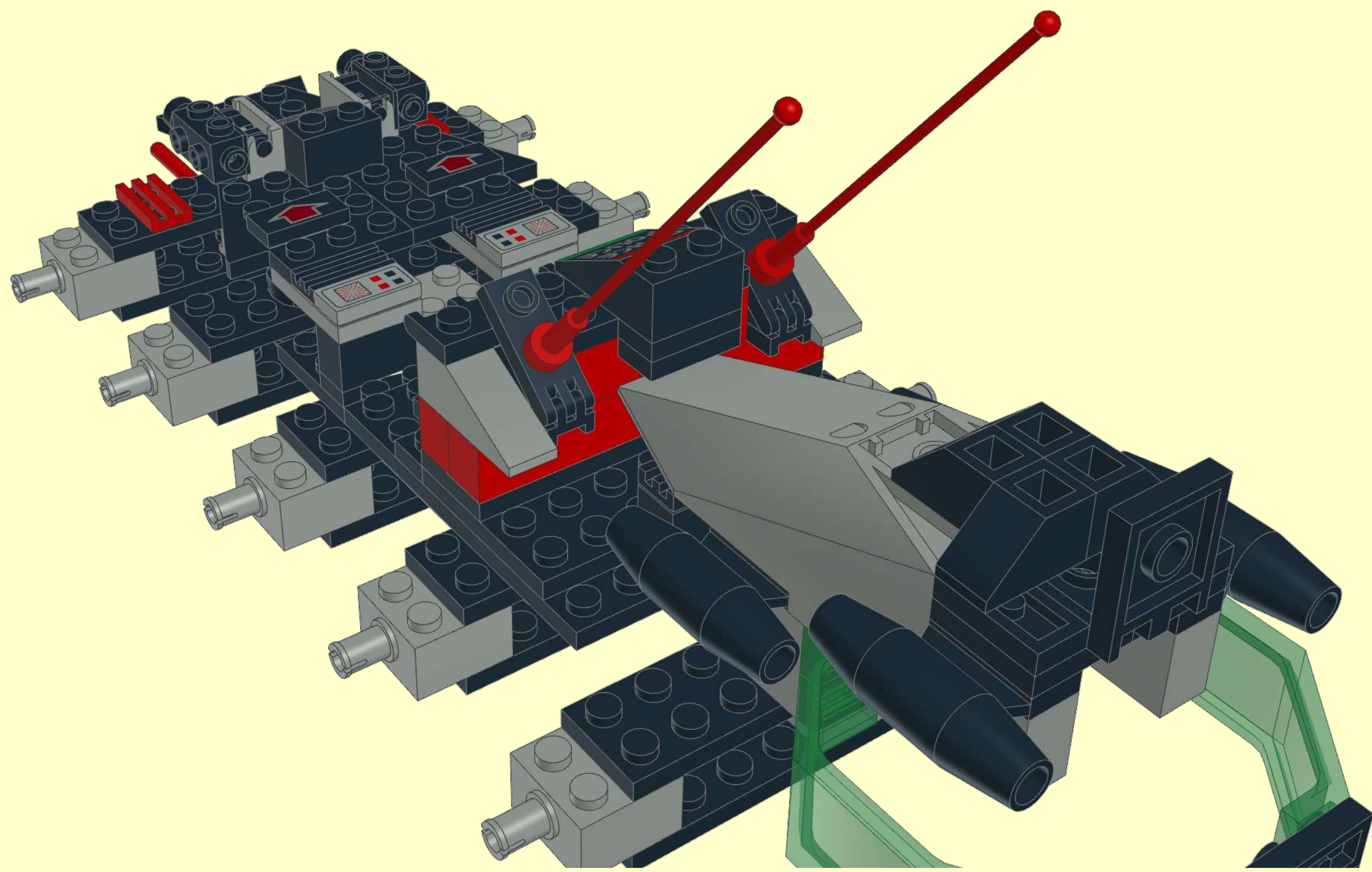
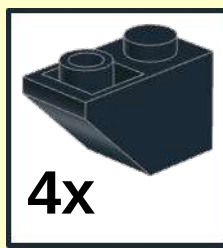

26

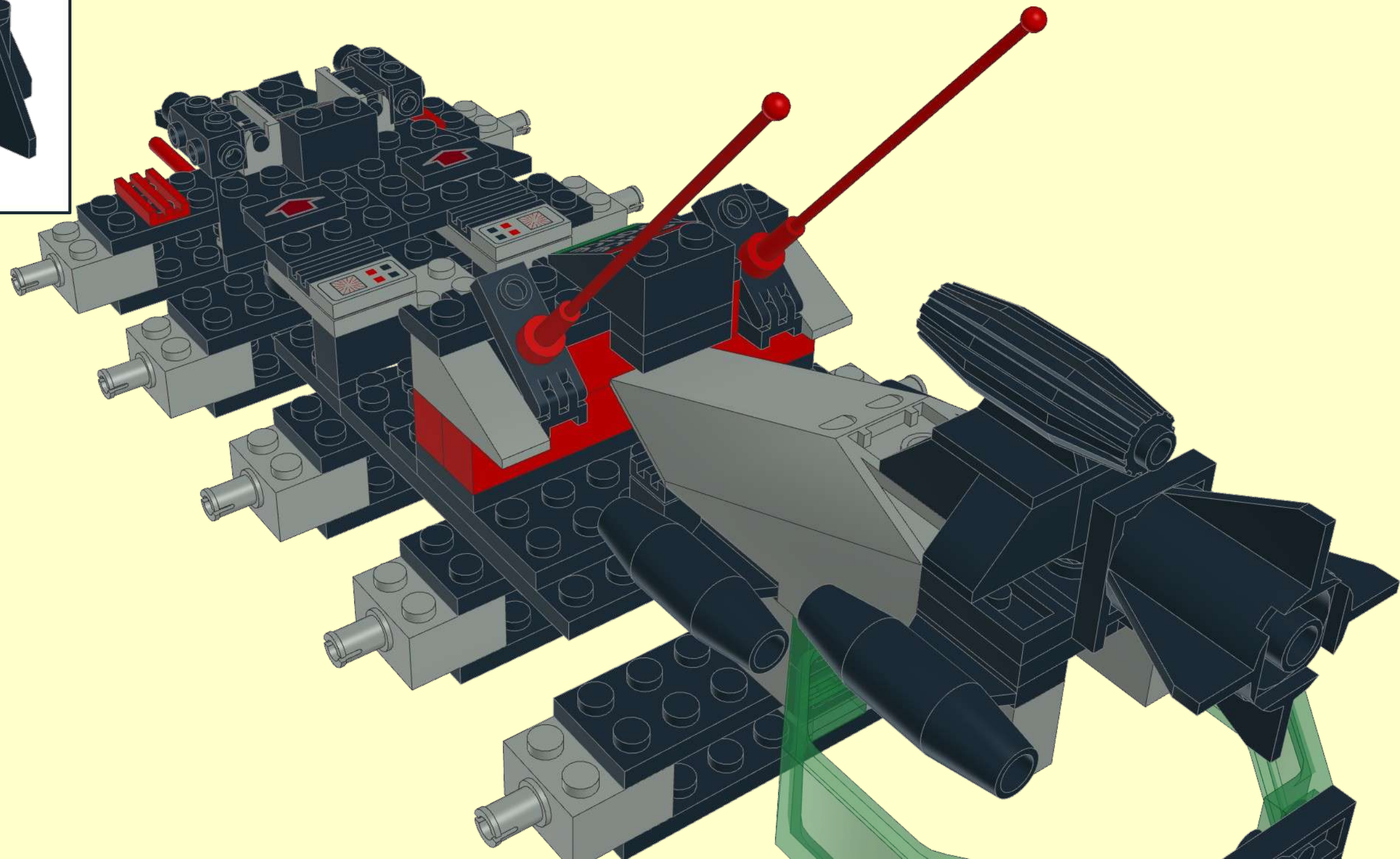



27

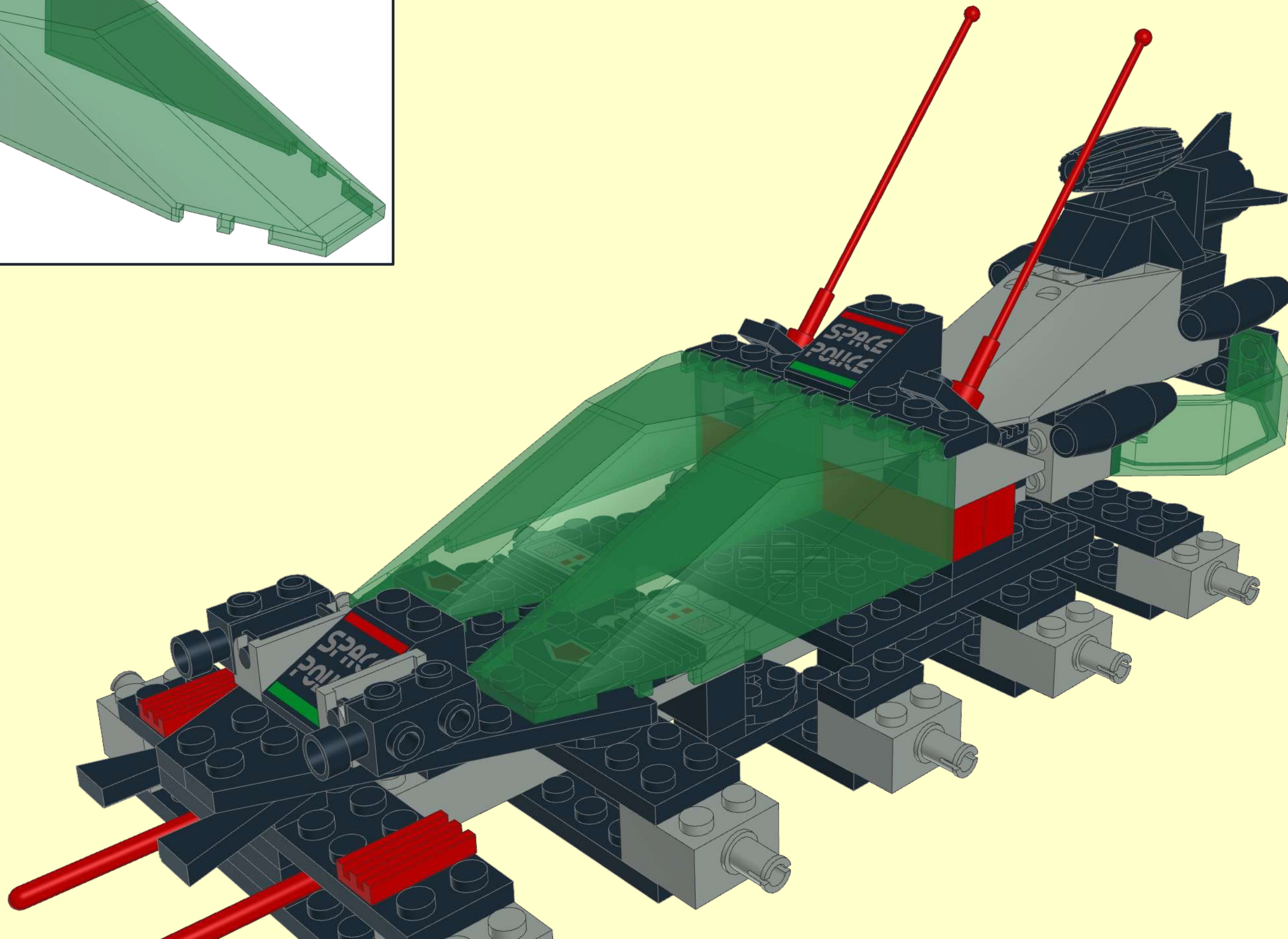
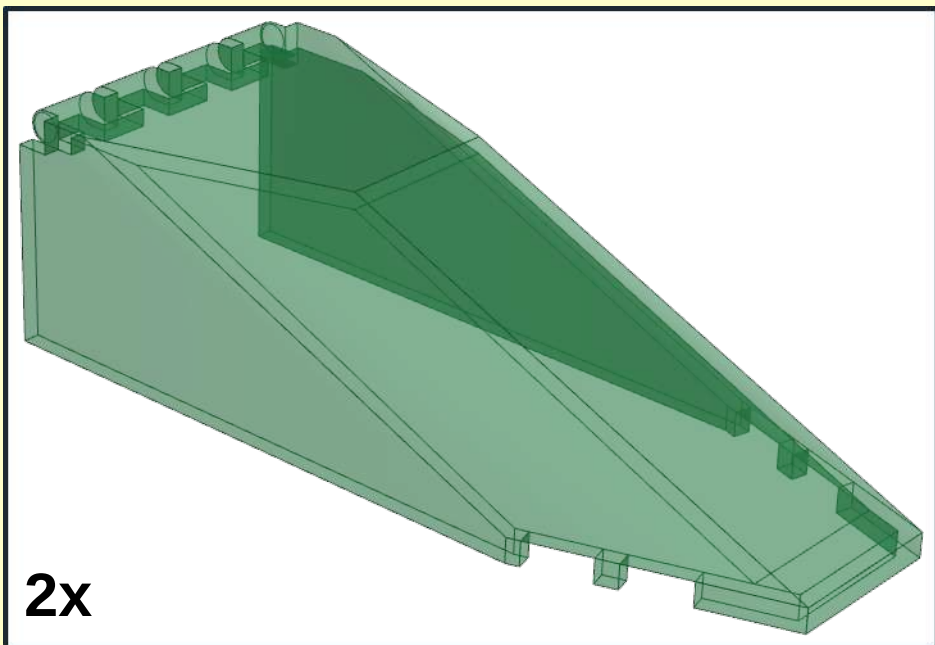

28

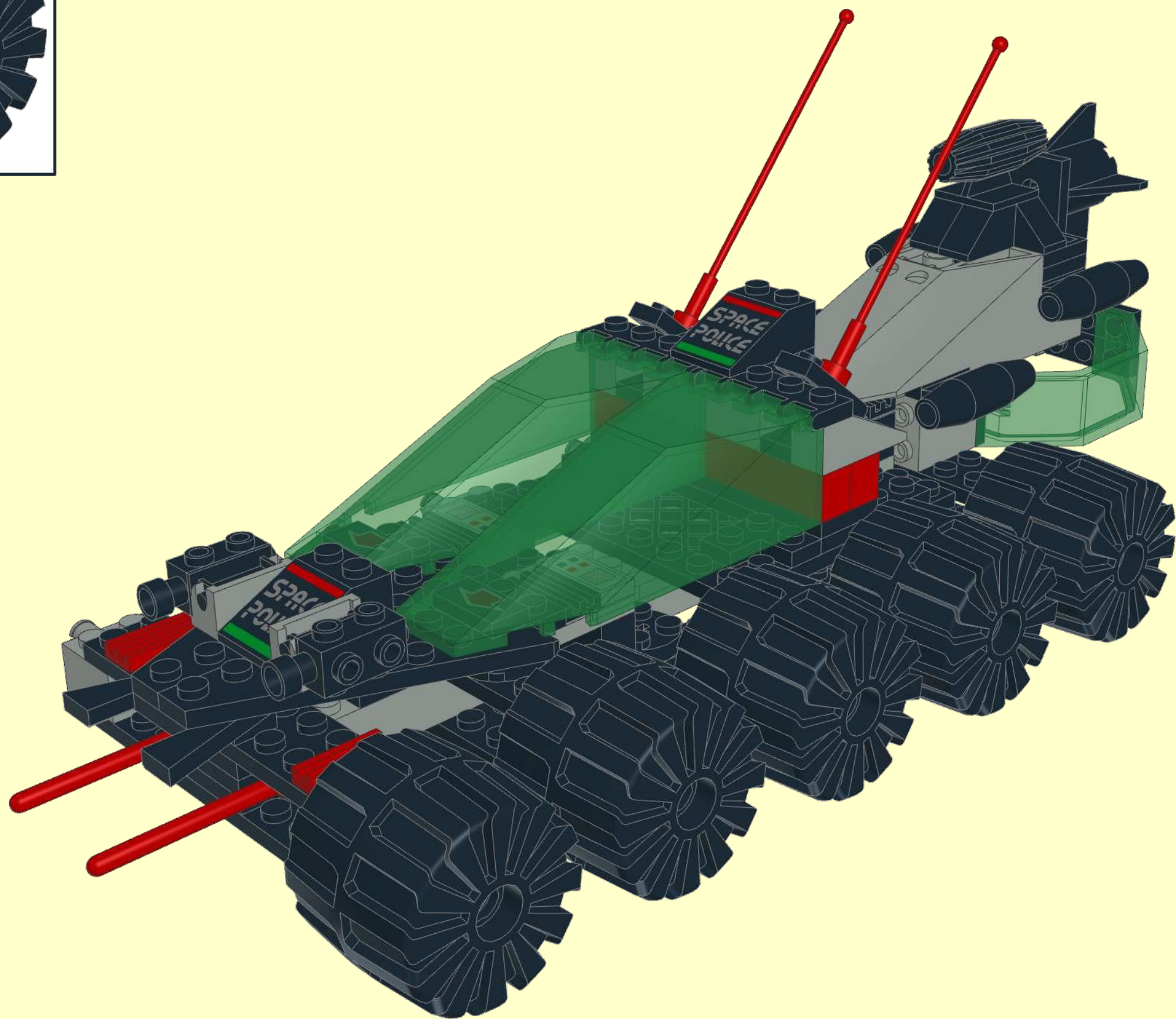

29

