

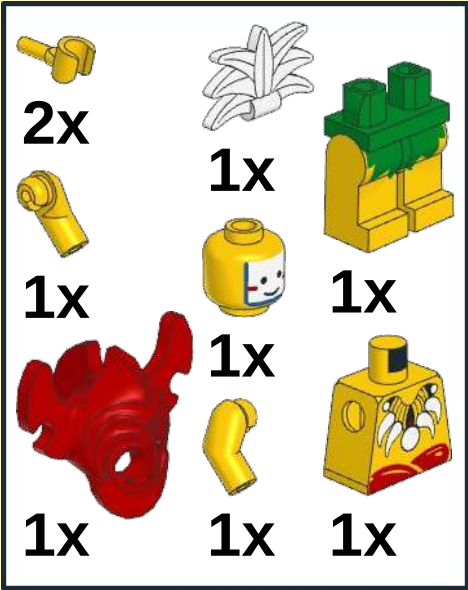



1



2



 1x	 1x	 1x	 1x
--	--	--	--

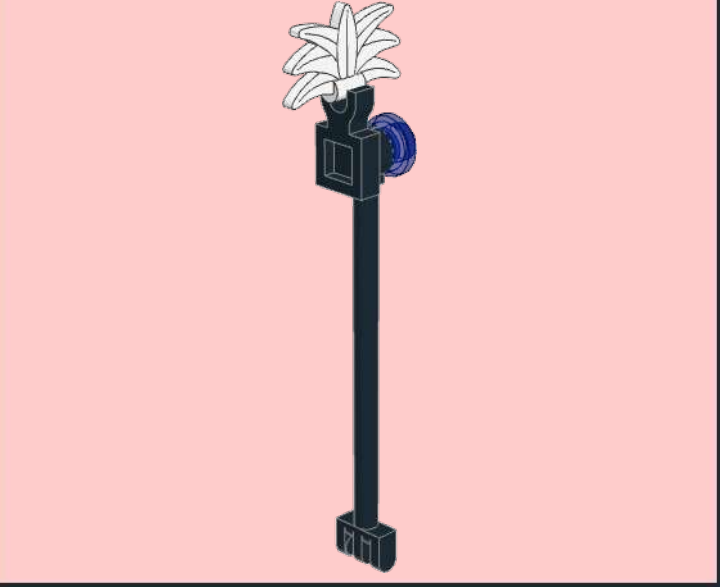

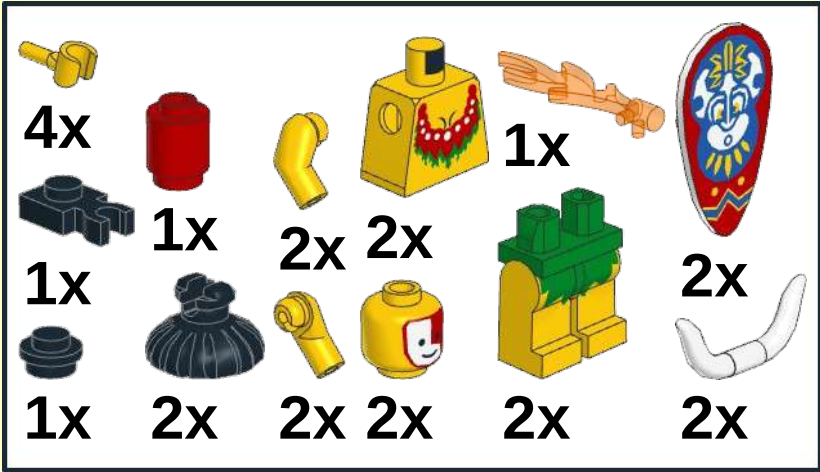

1



2x



1x





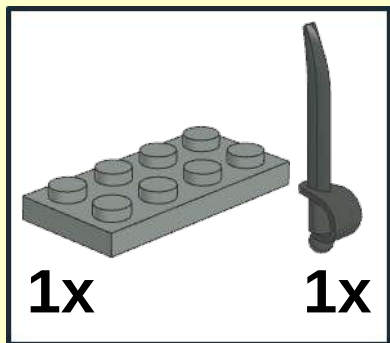

2

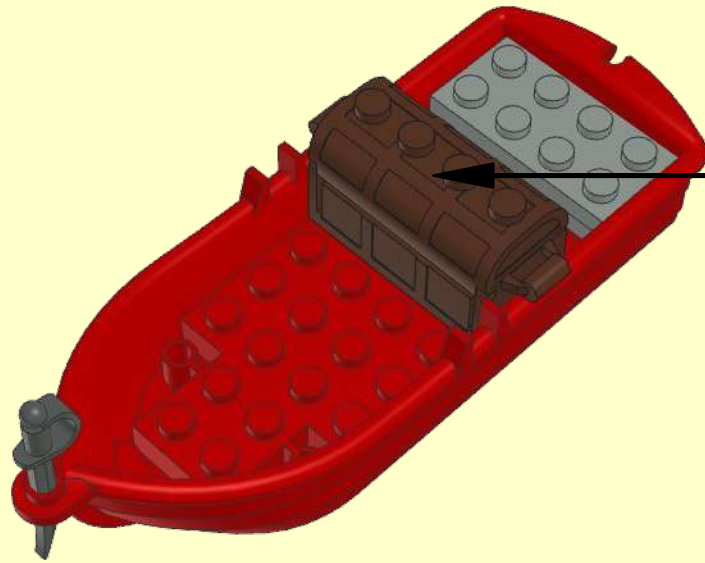

3

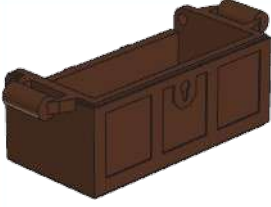

1

		
1x	1x	1x
		
	1x	1x

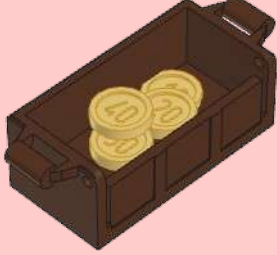

2



1x

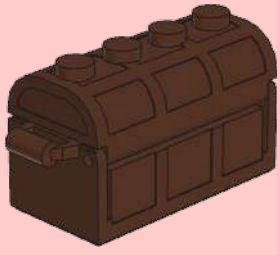

4

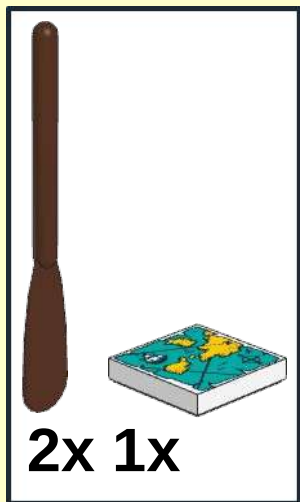

1

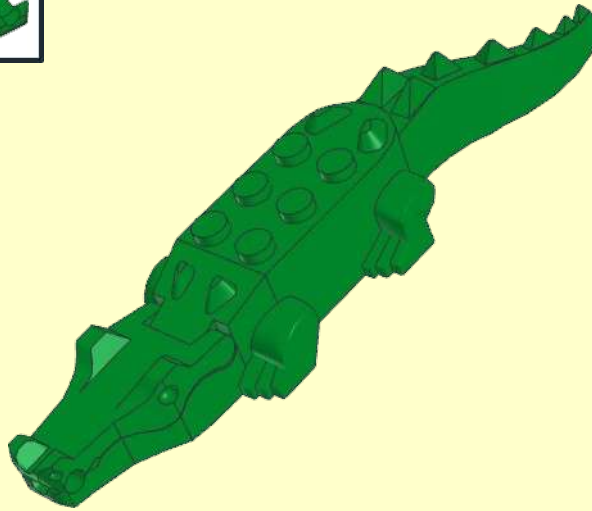
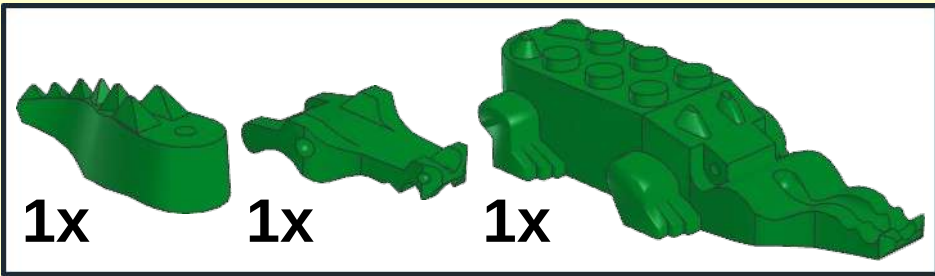
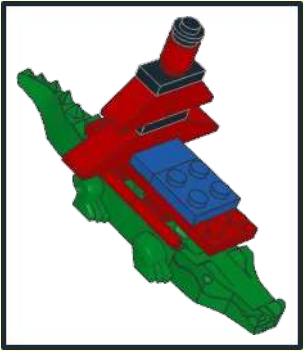

2

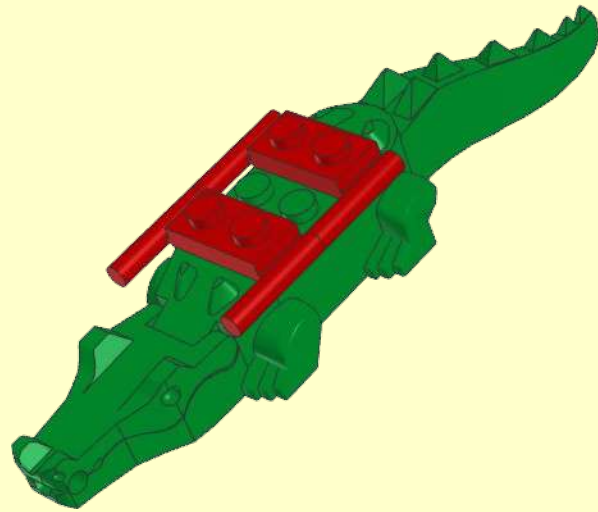
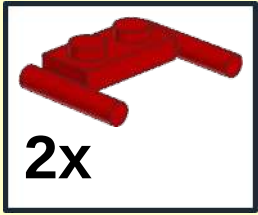

3

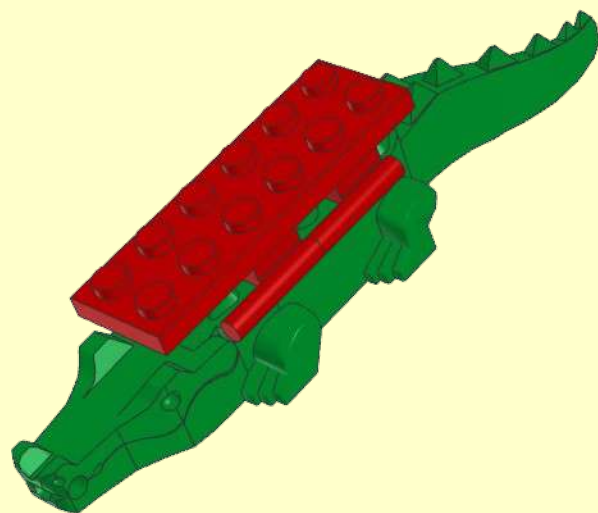
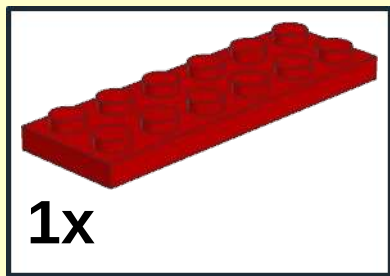

4

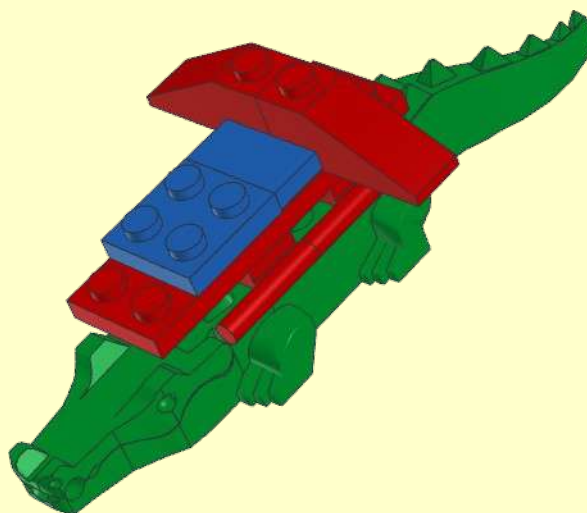
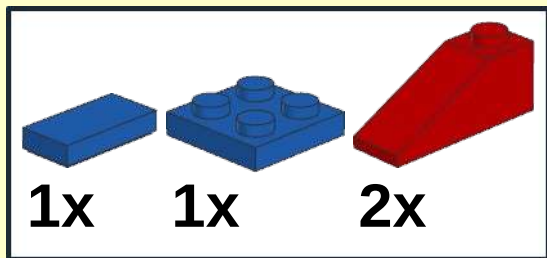

5

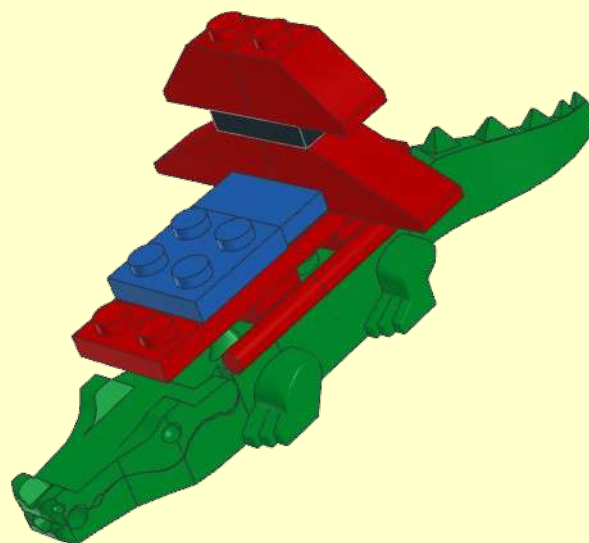
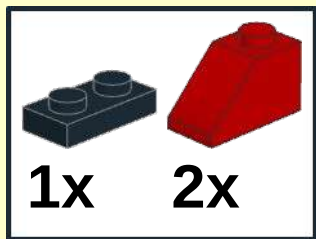

6

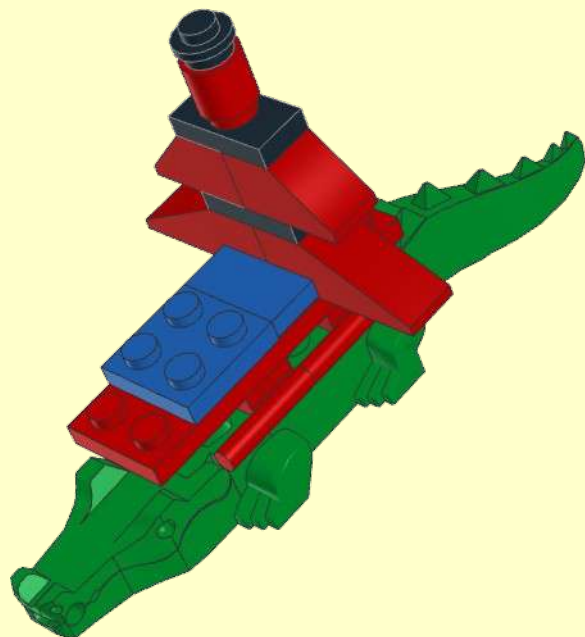
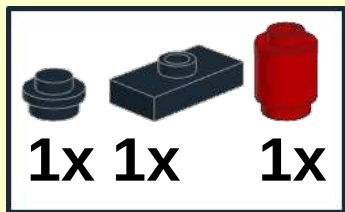

1

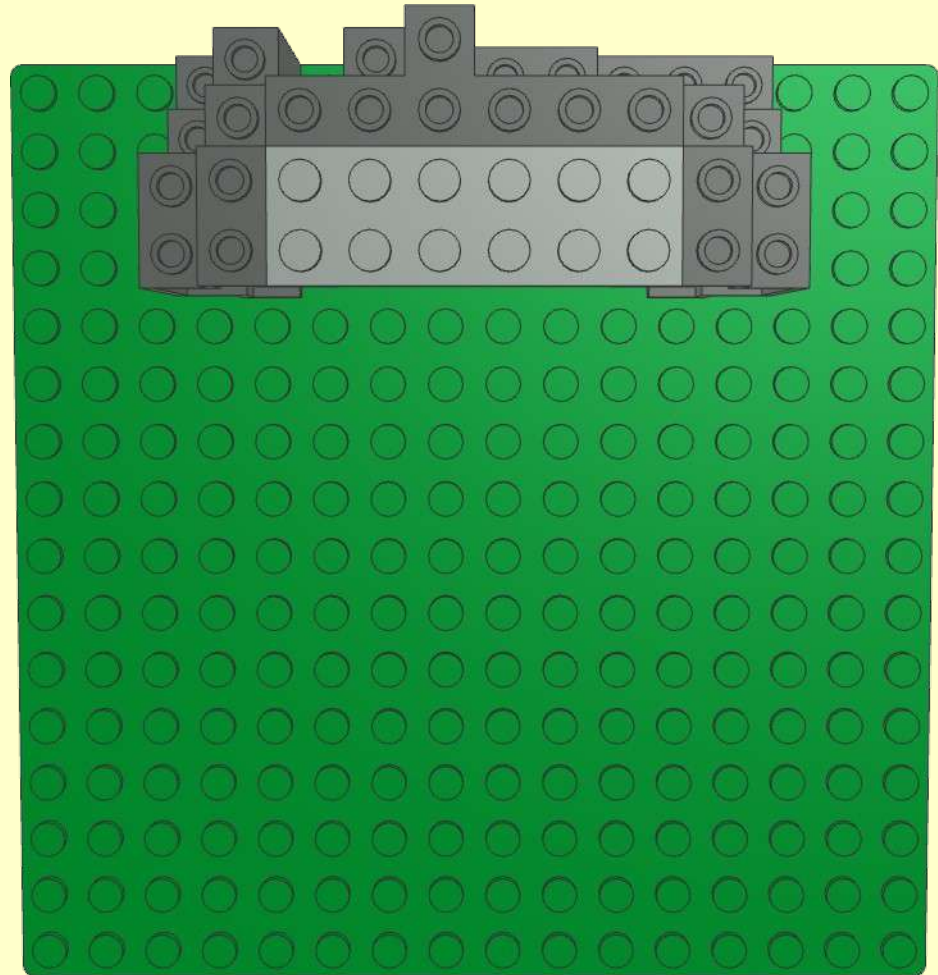
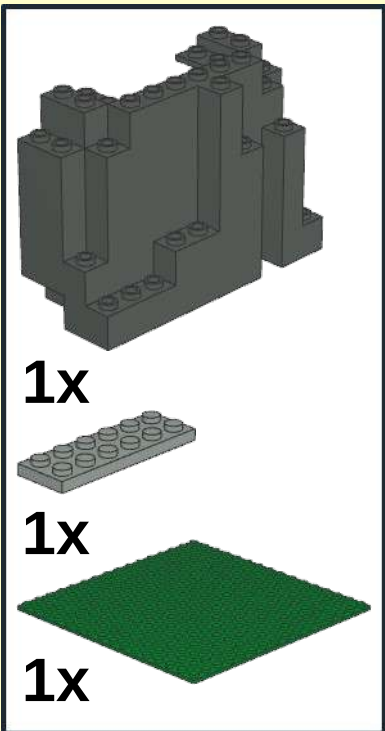

2

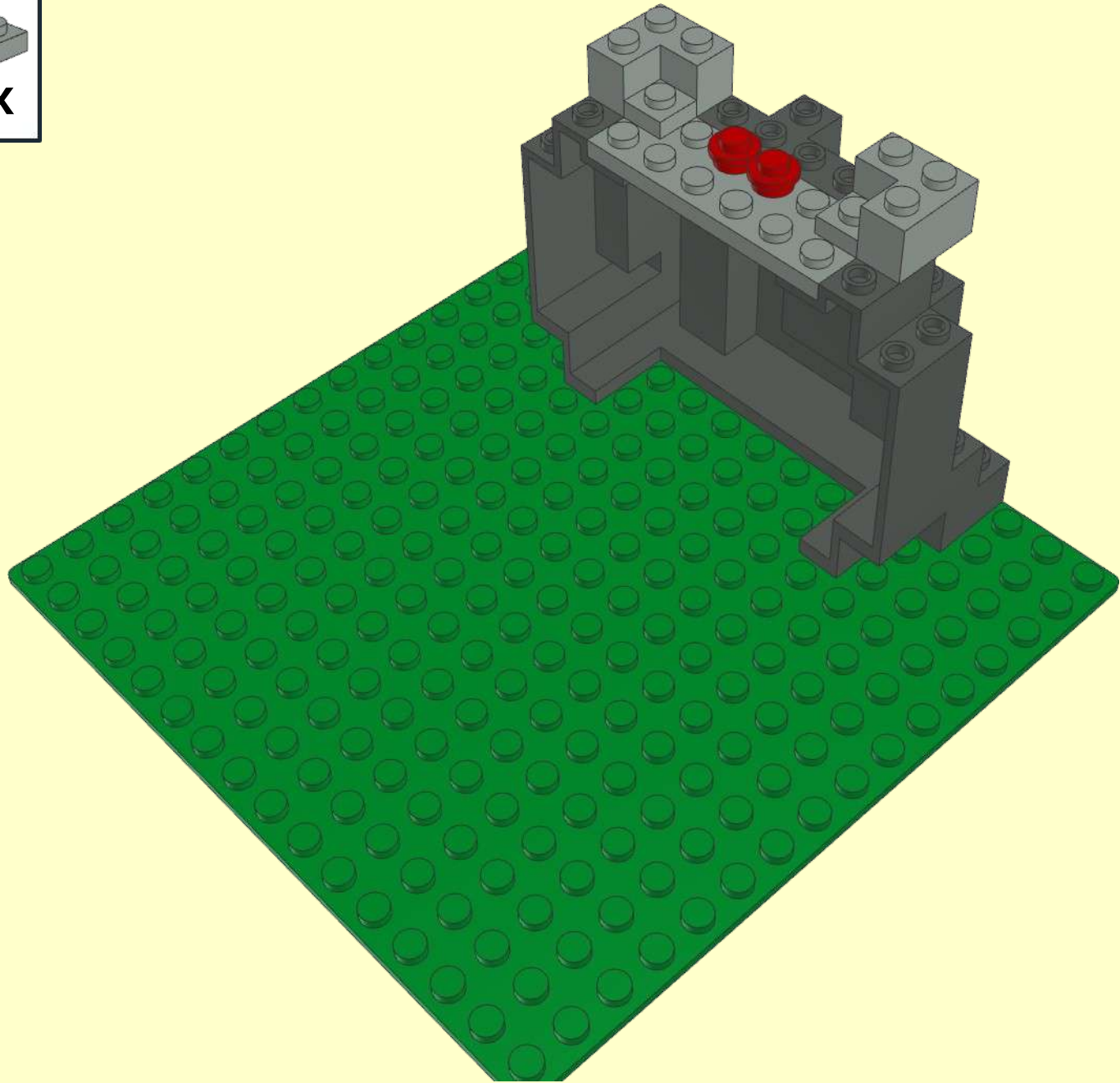
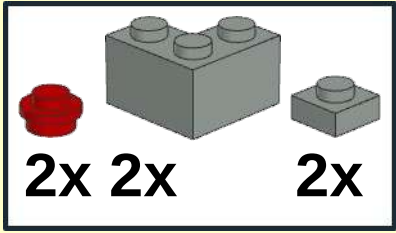

3

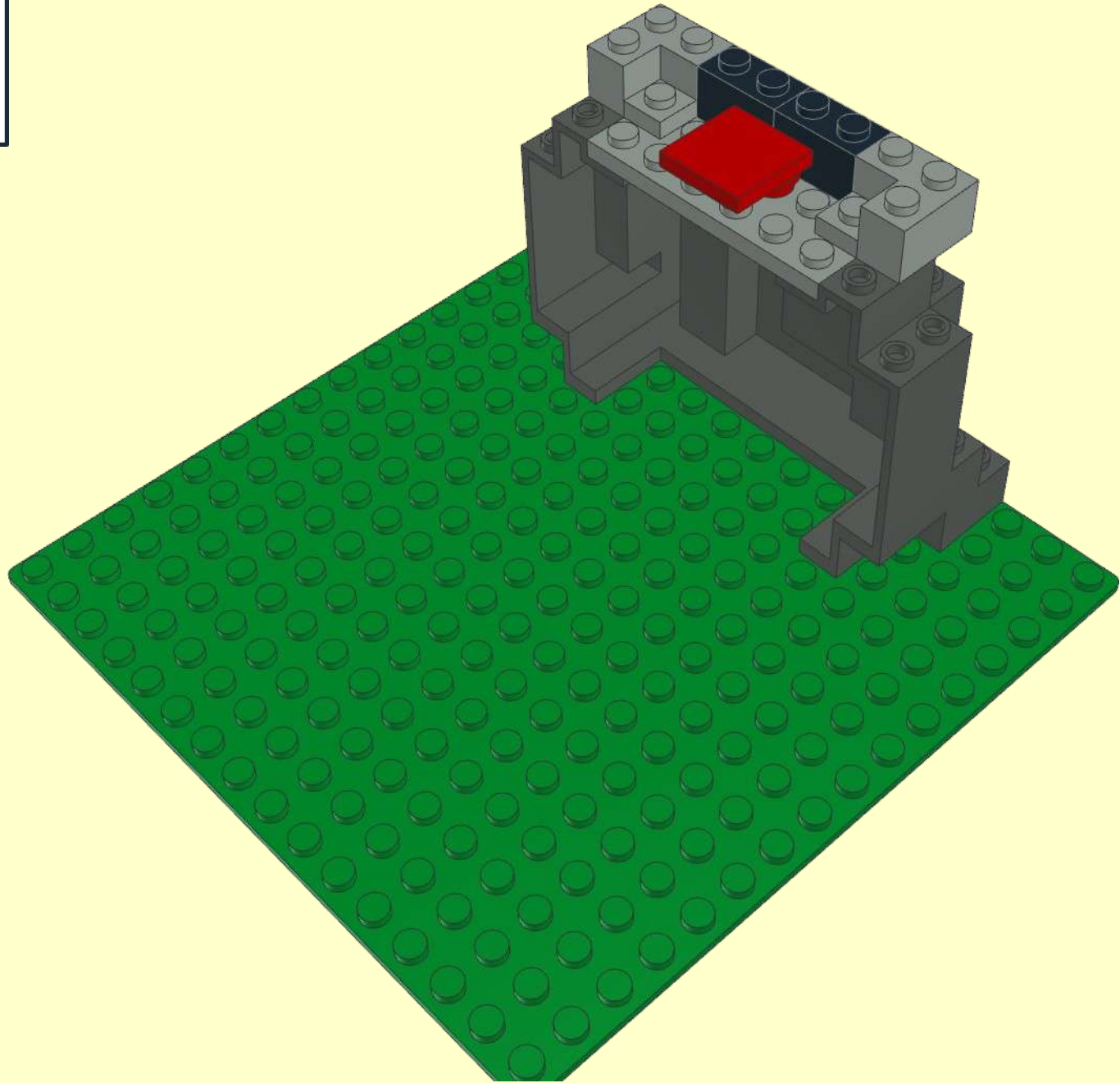
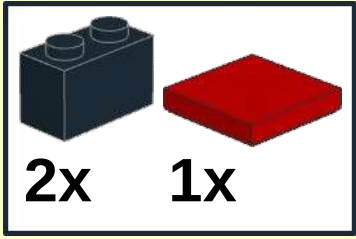

4

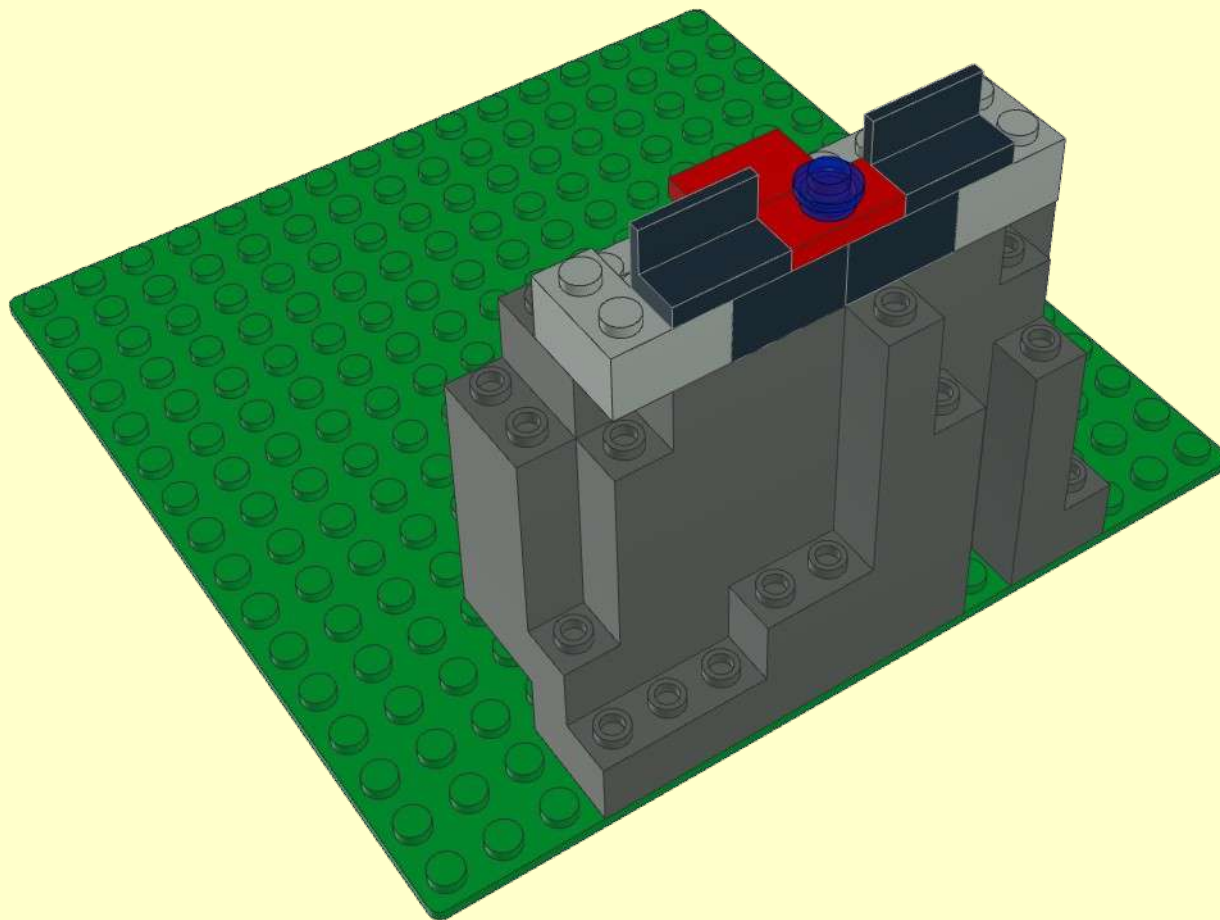
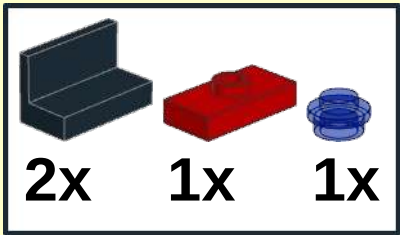

5

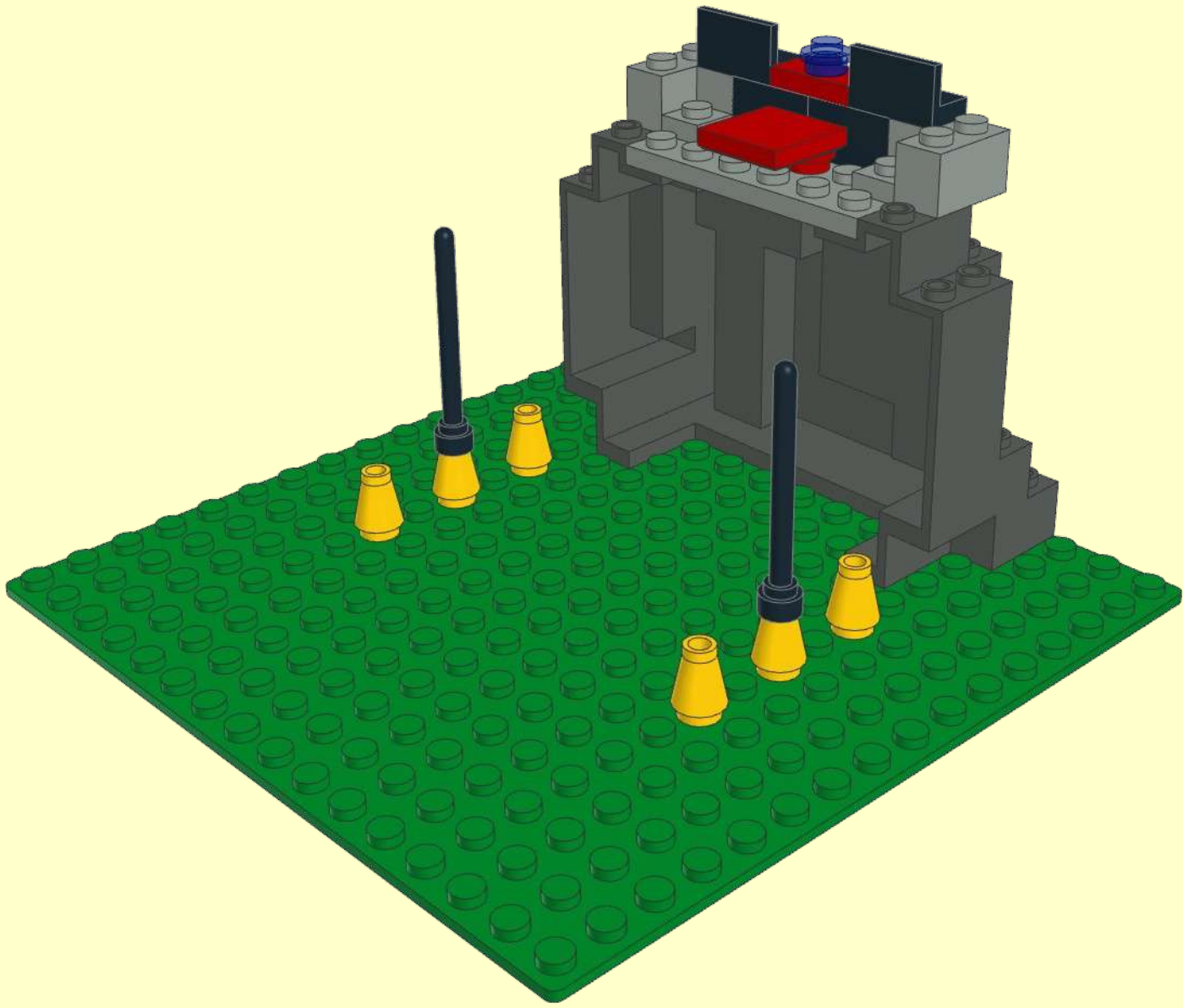
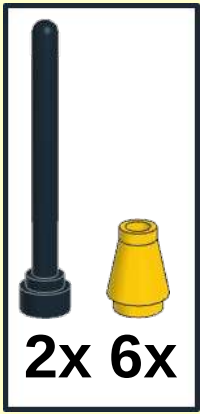

6

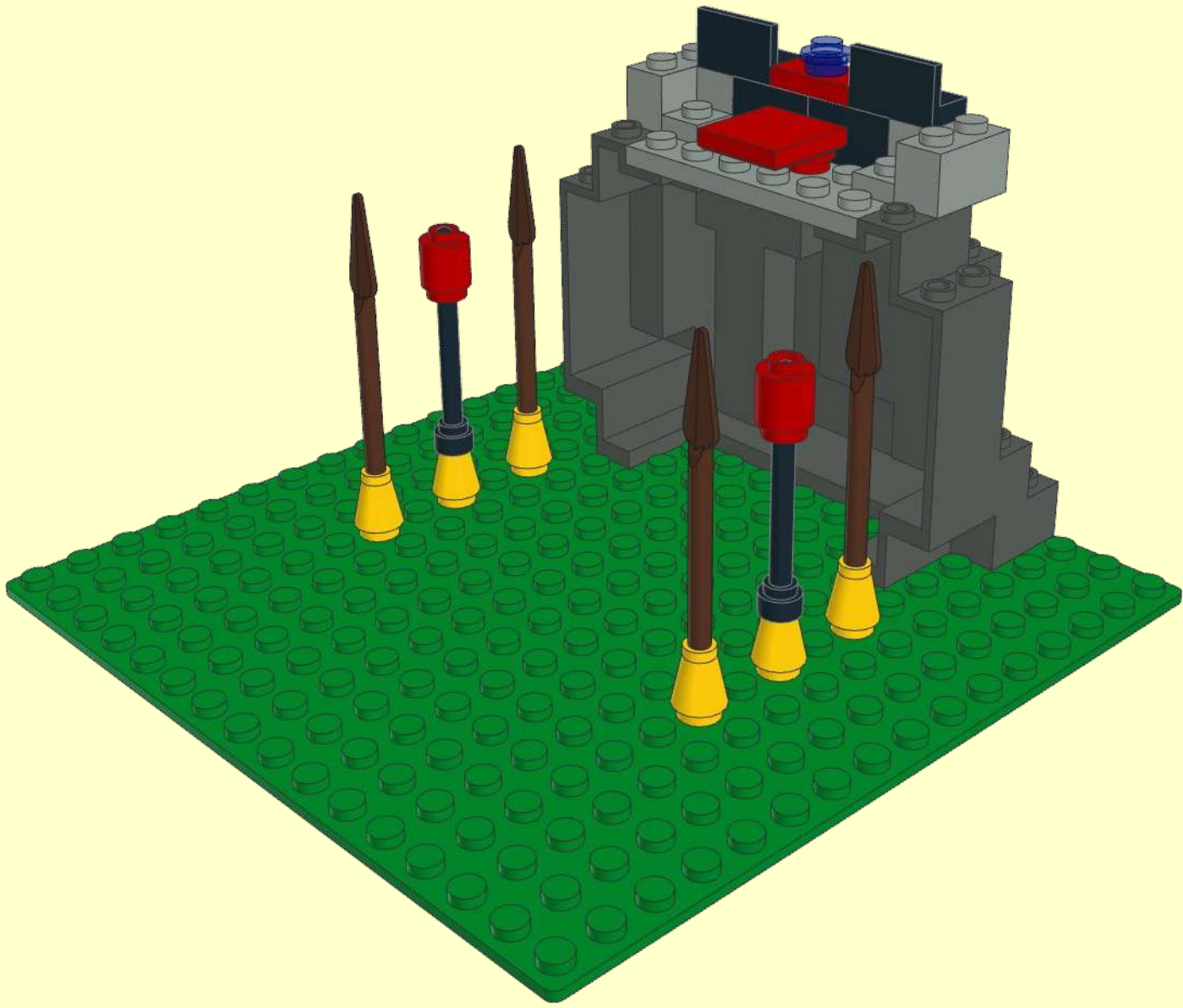

7

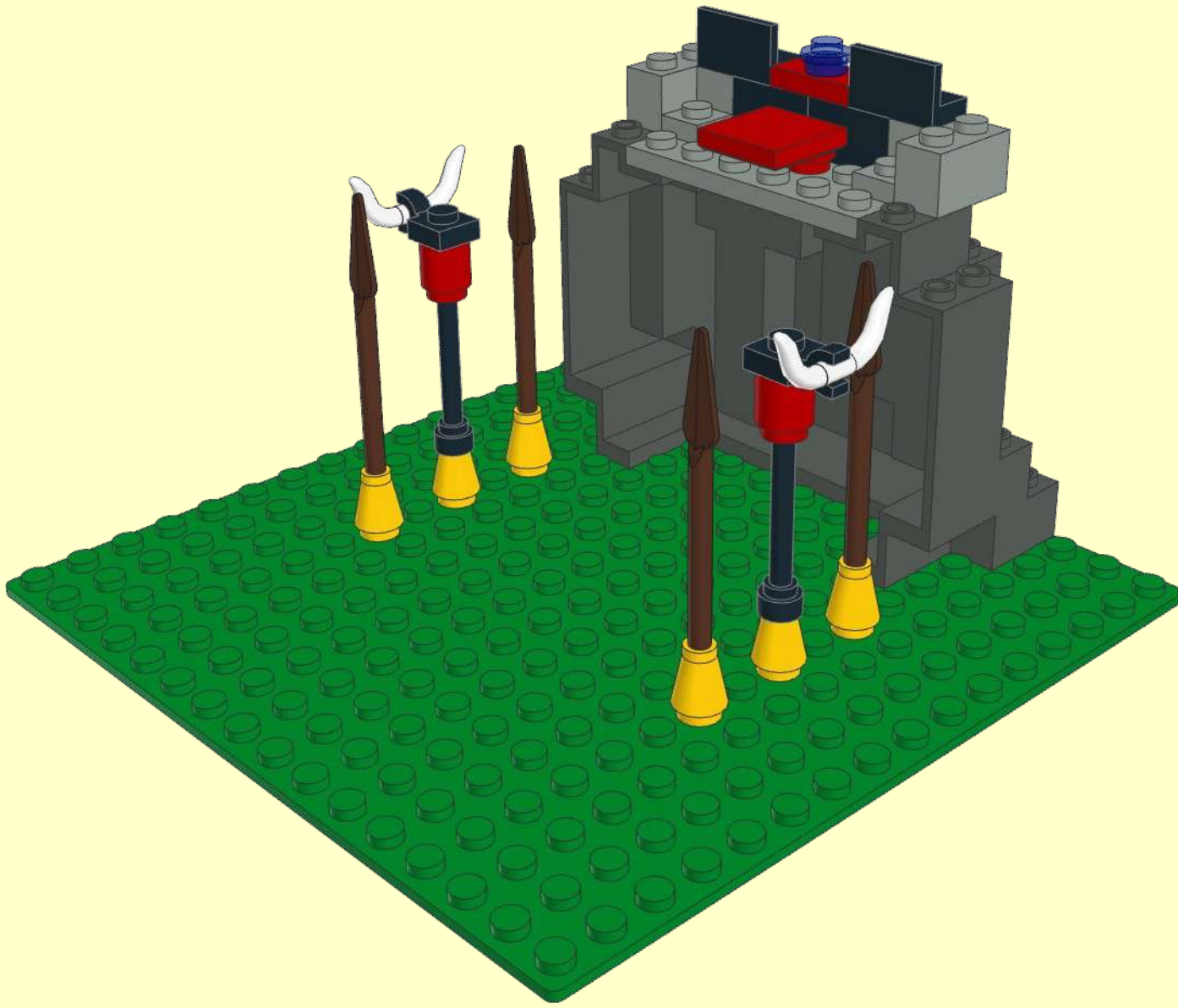
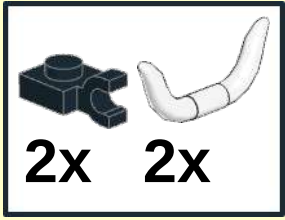

8



2x

2x

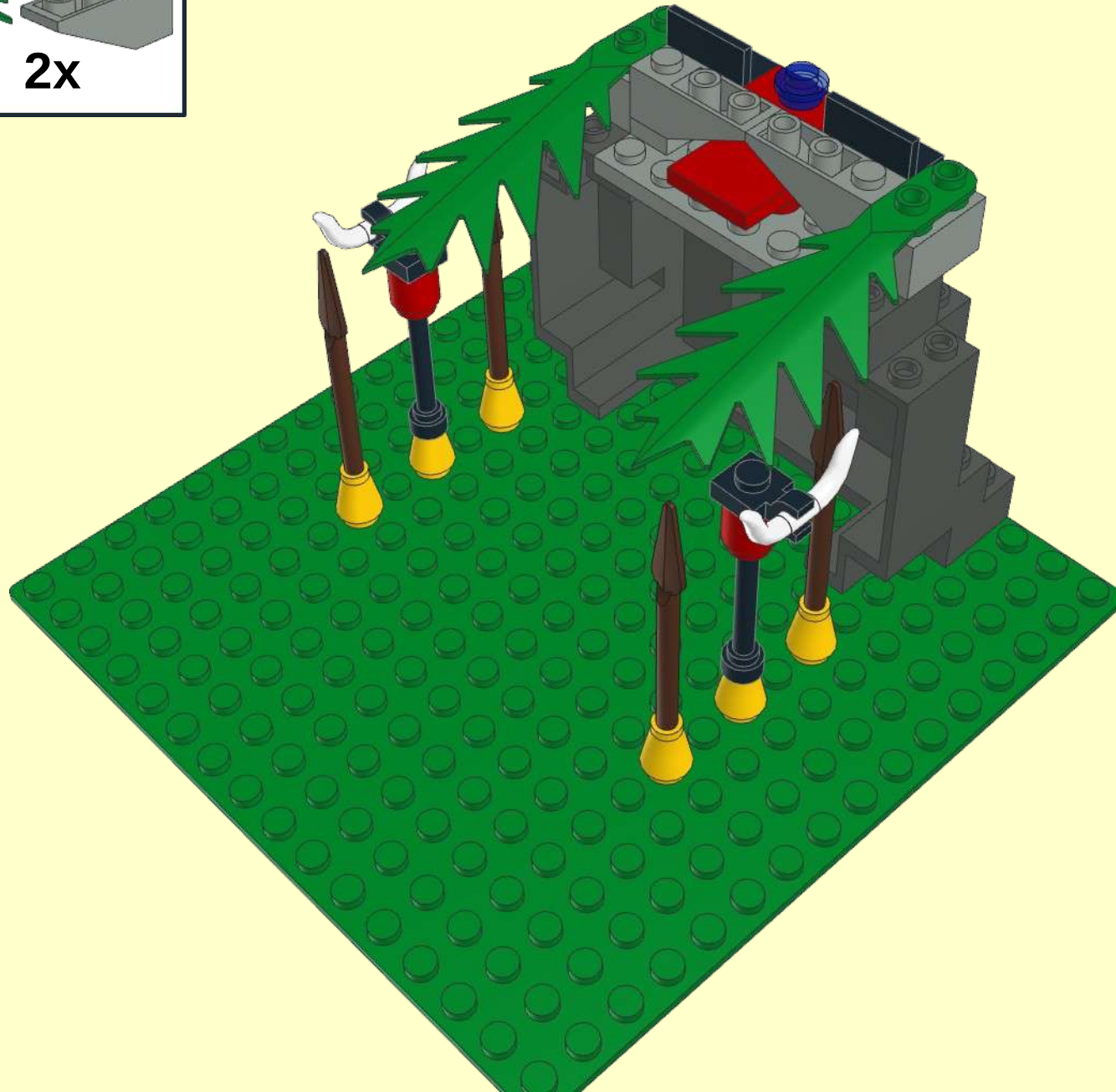

9

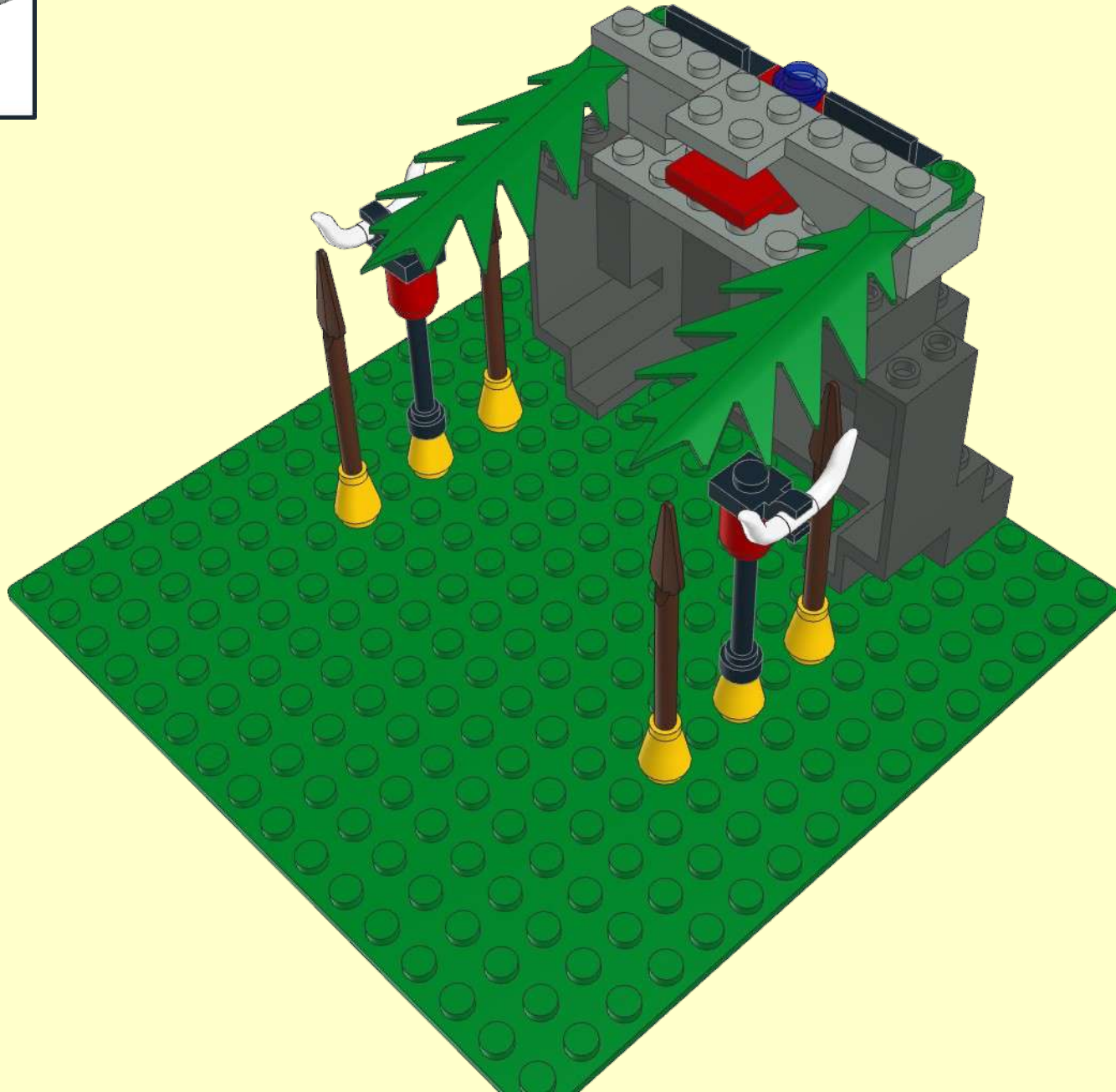
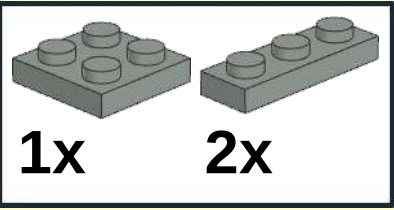

10

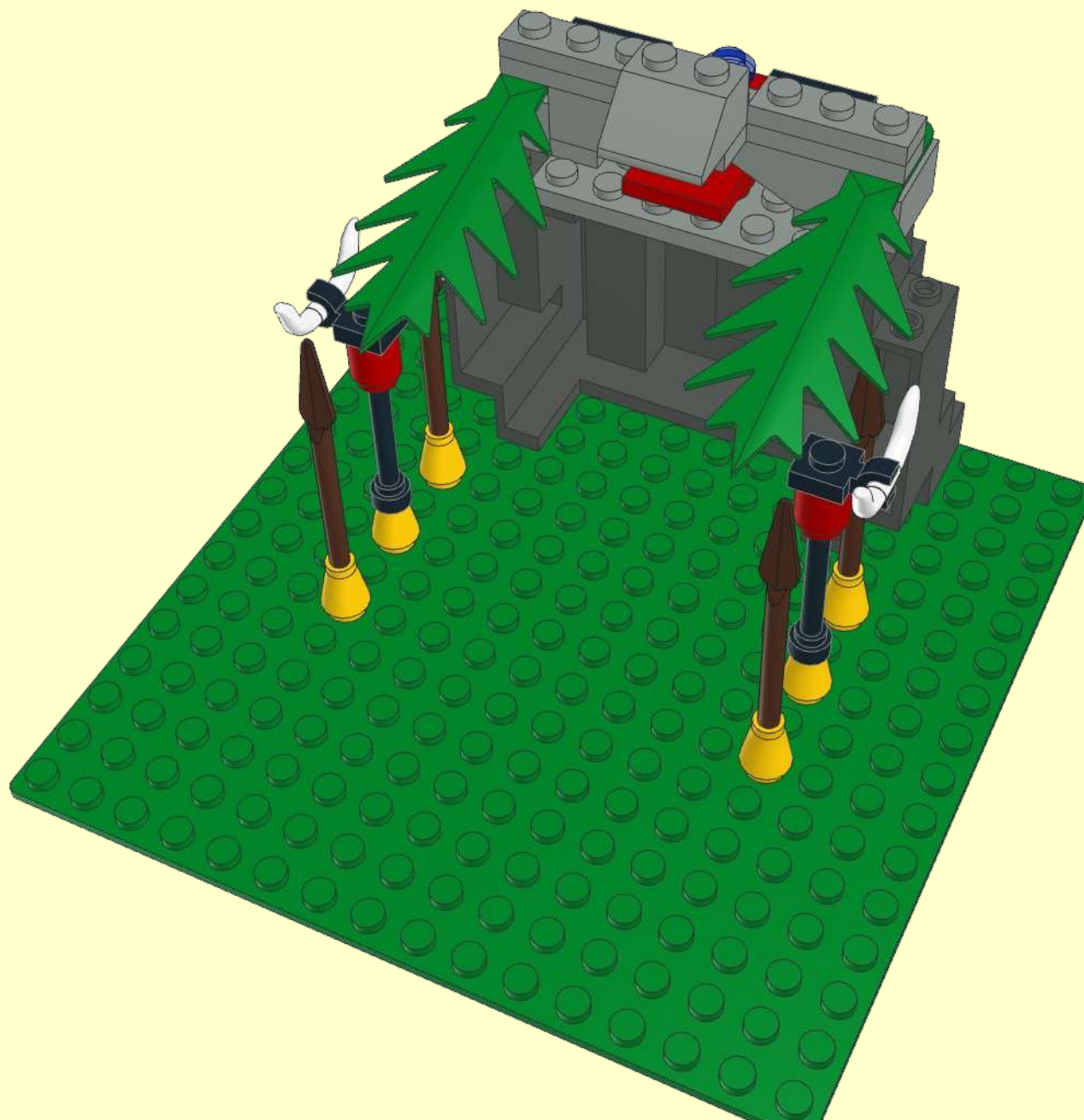
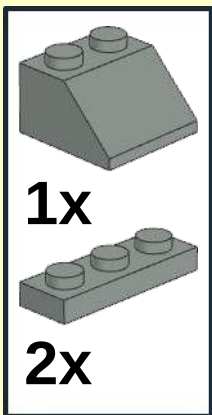

11

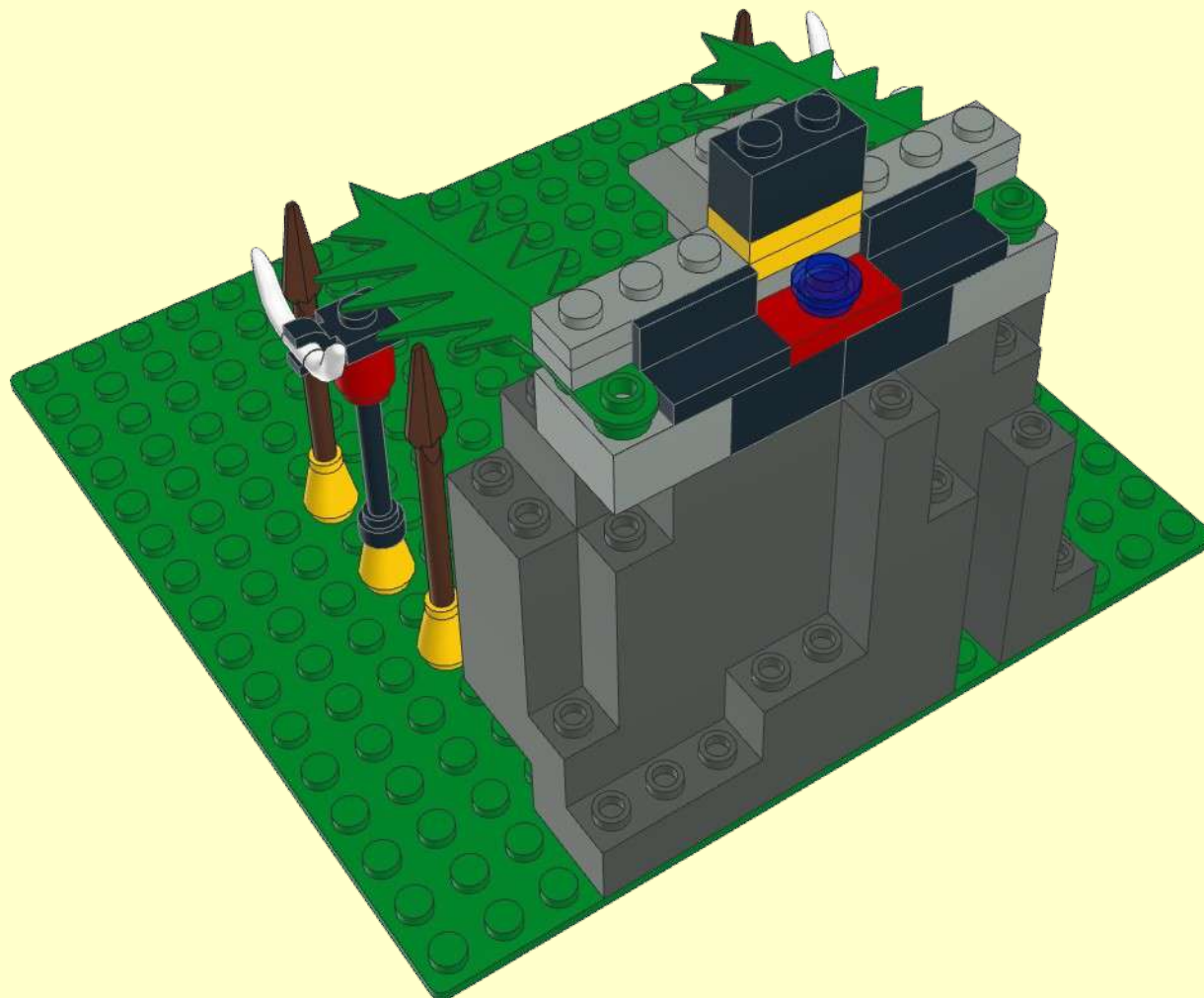
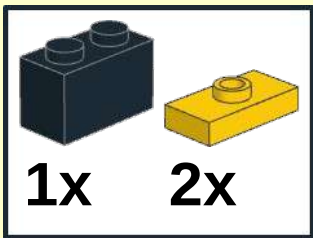

12

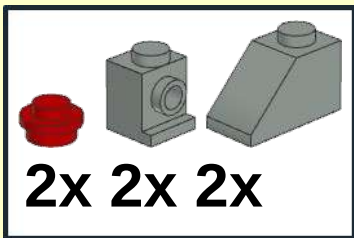

13

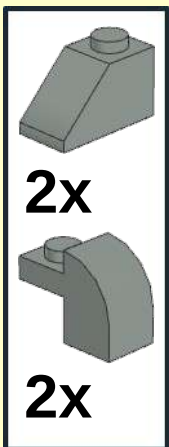

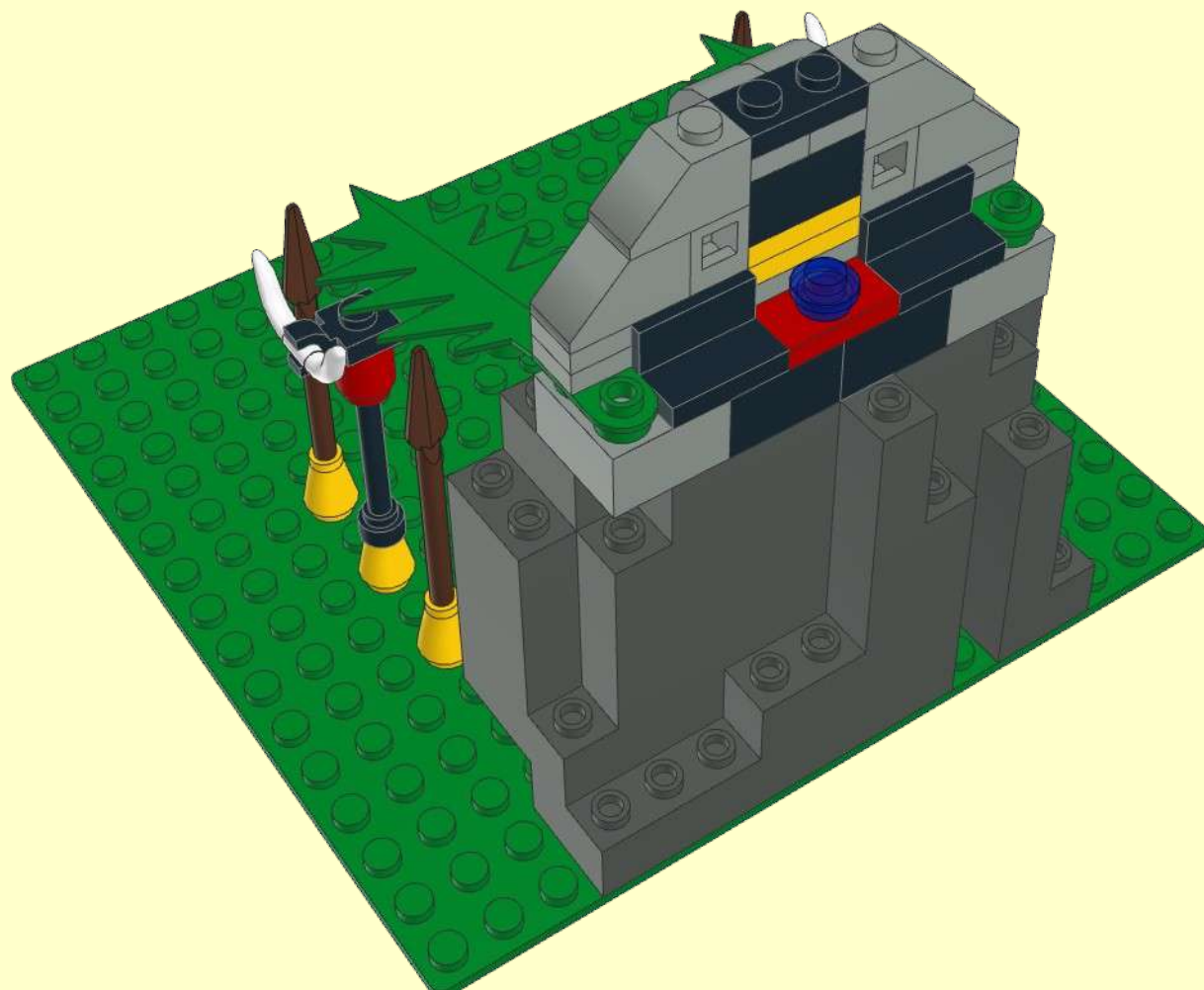
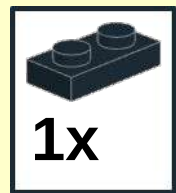

14

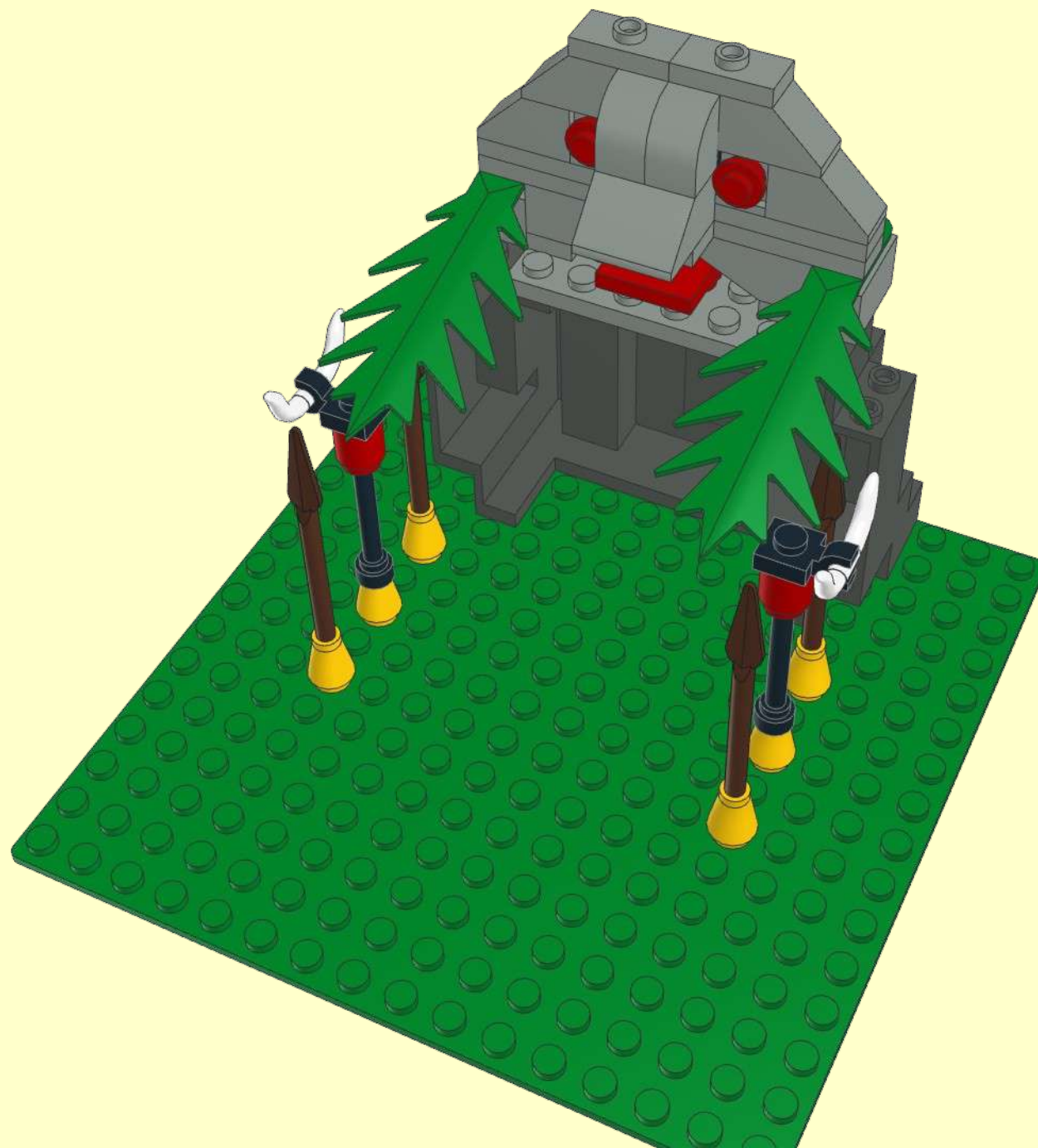
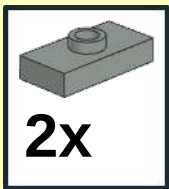

15



17

		
2x	1x	1x

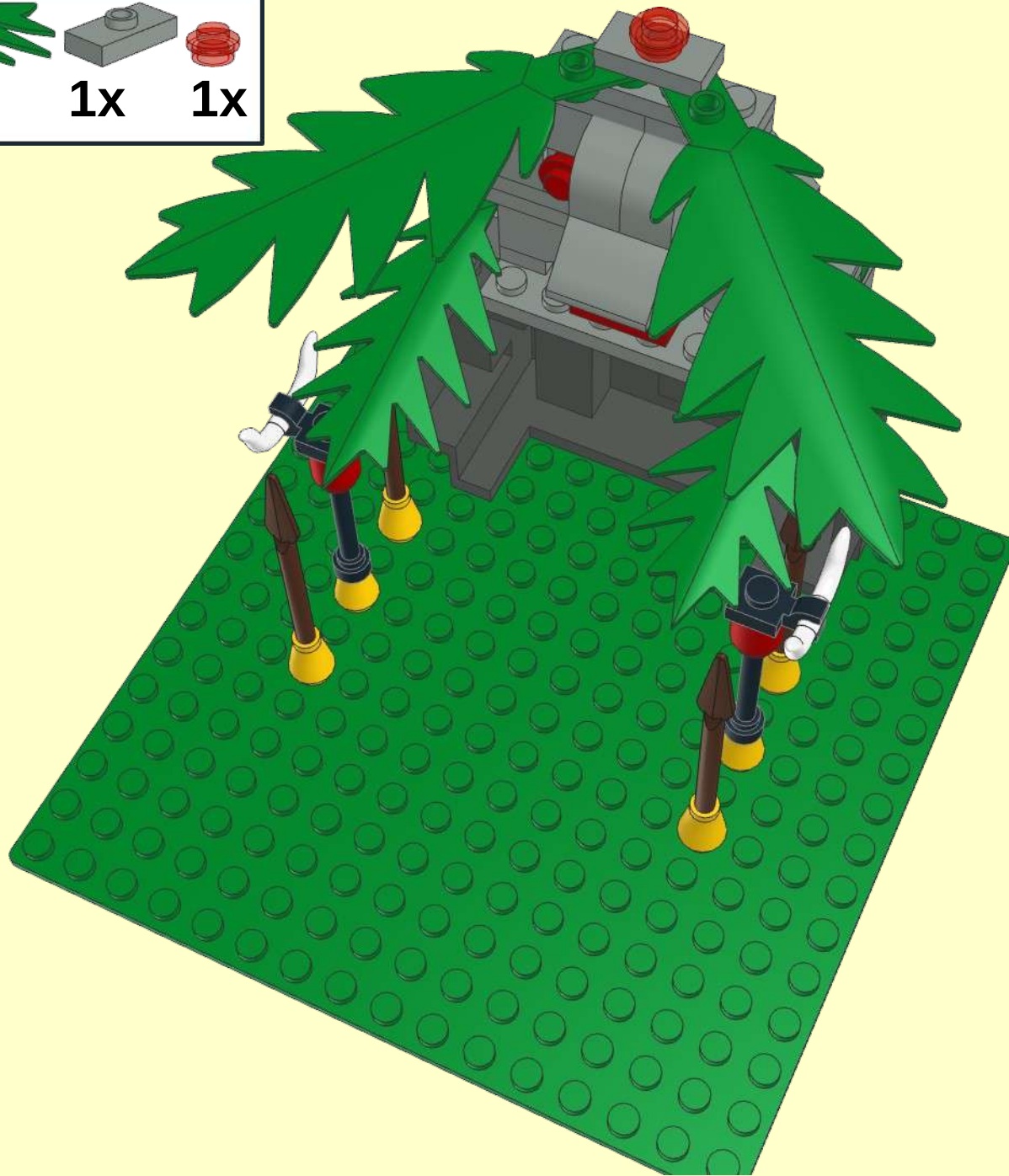

18

