

1

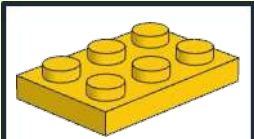

1x

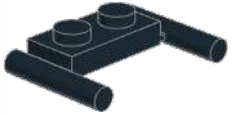

1x

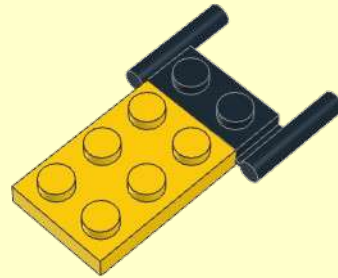

2

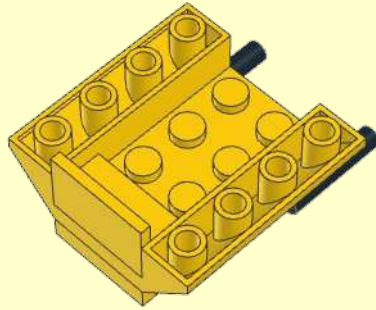
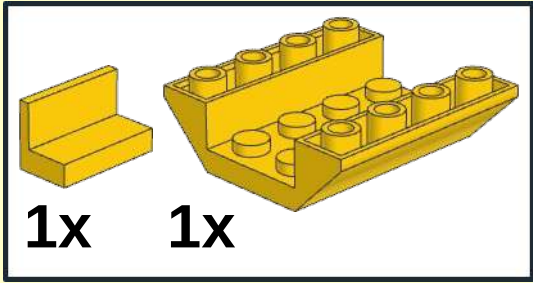

3

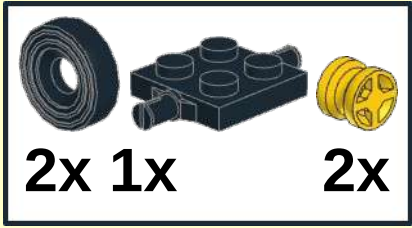

4

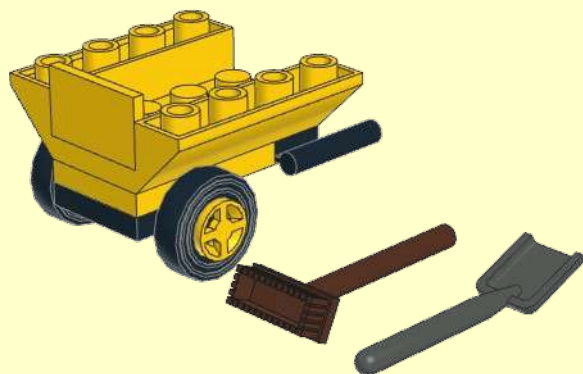

1



4x

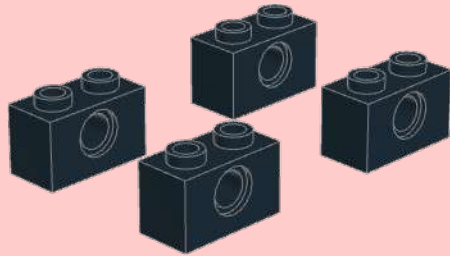

2

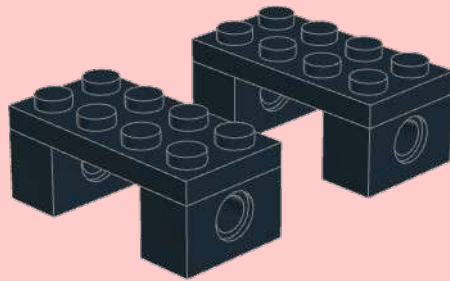
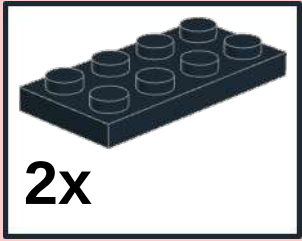

3

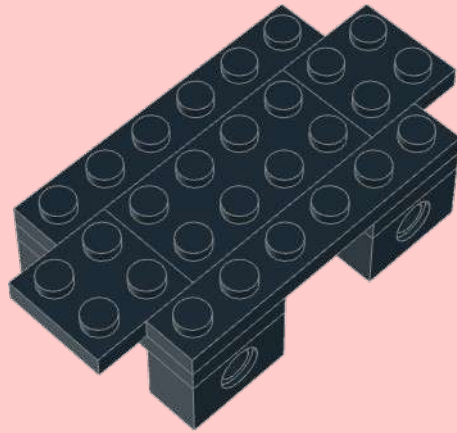
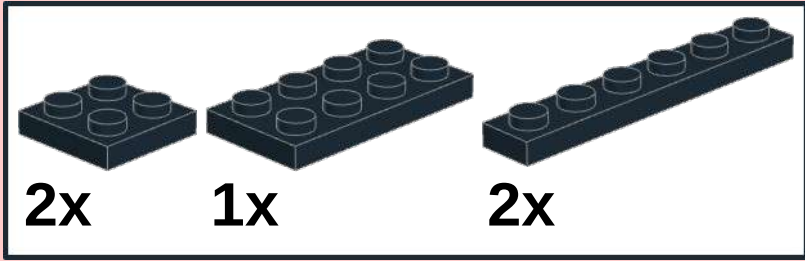

4

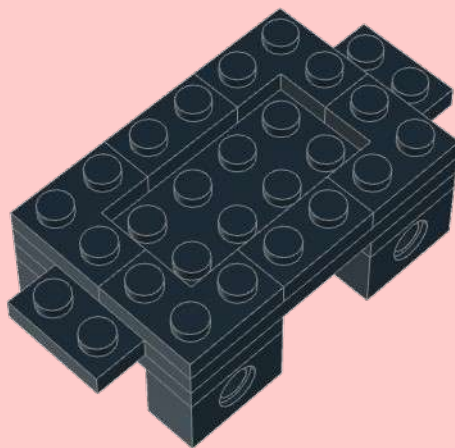
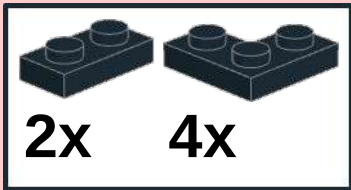

5

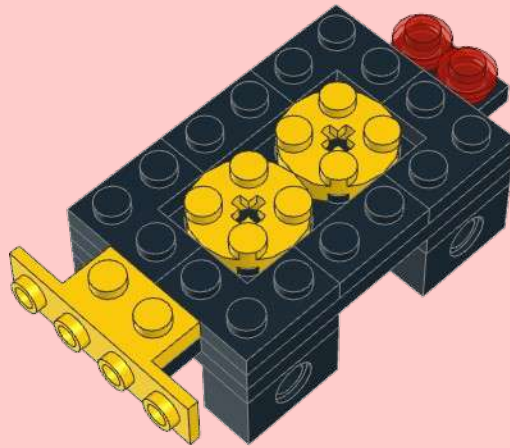
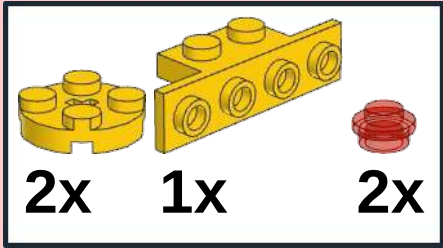

6

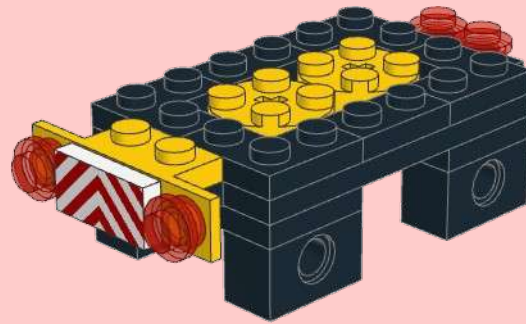
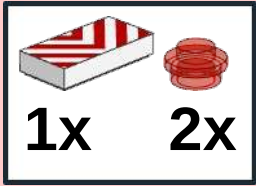

7

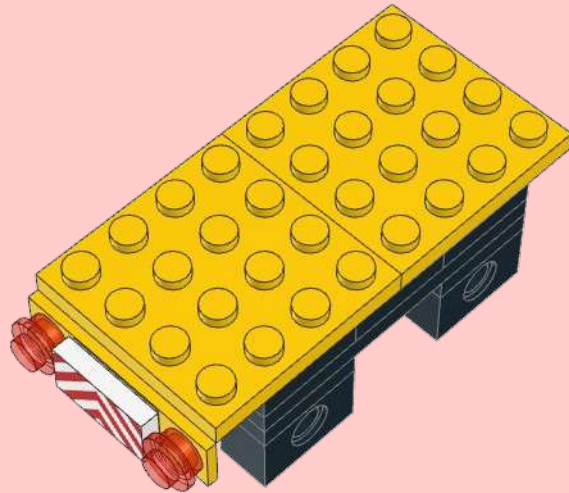
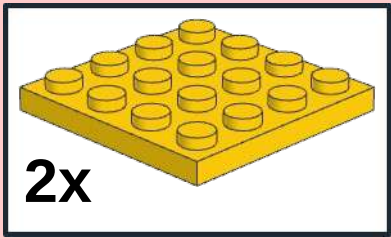

8

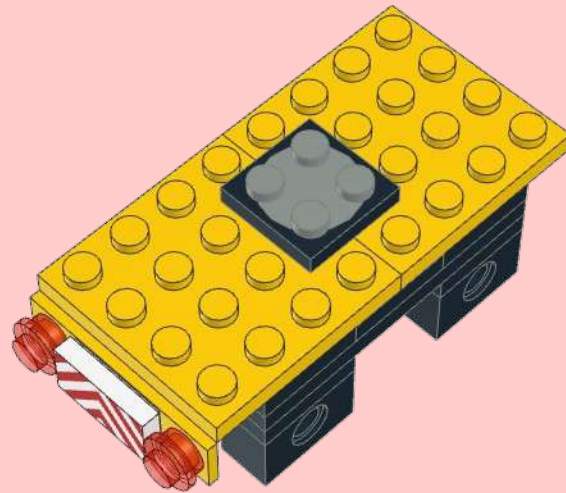

9

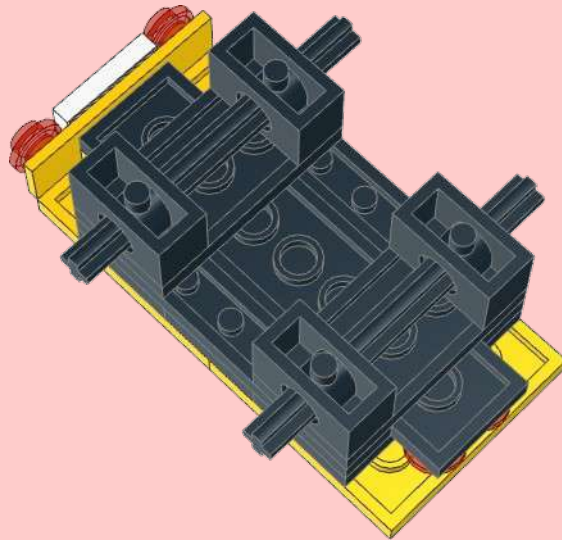

10

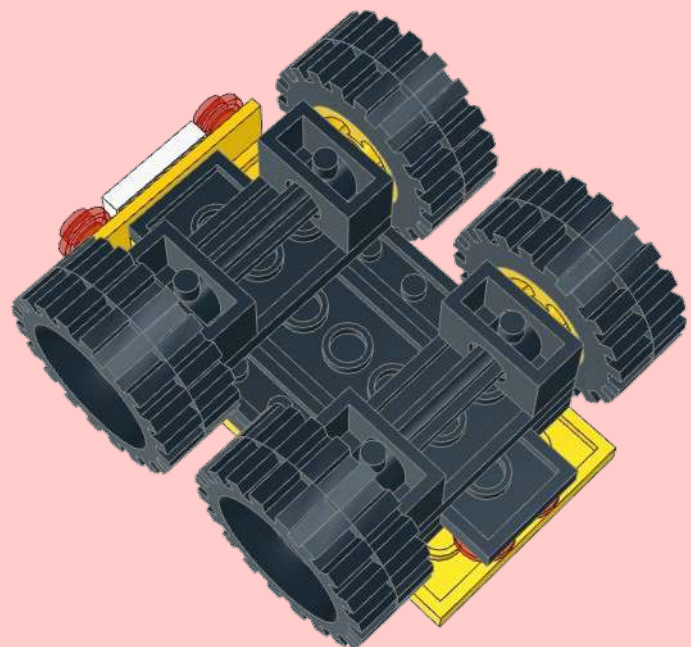
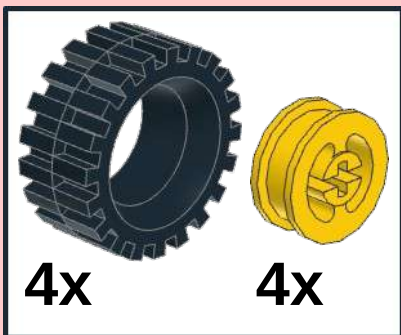

1

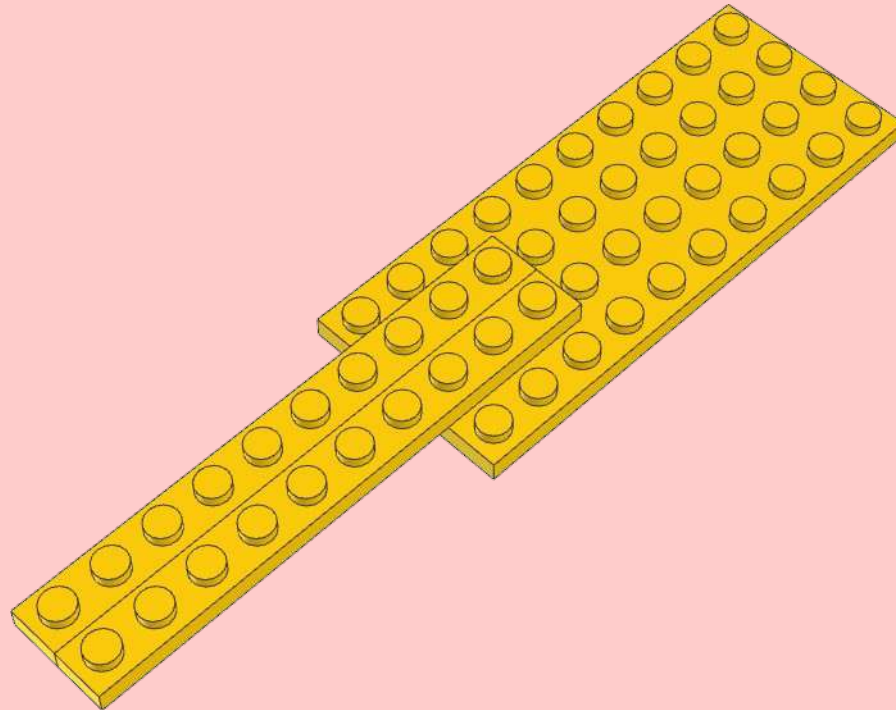
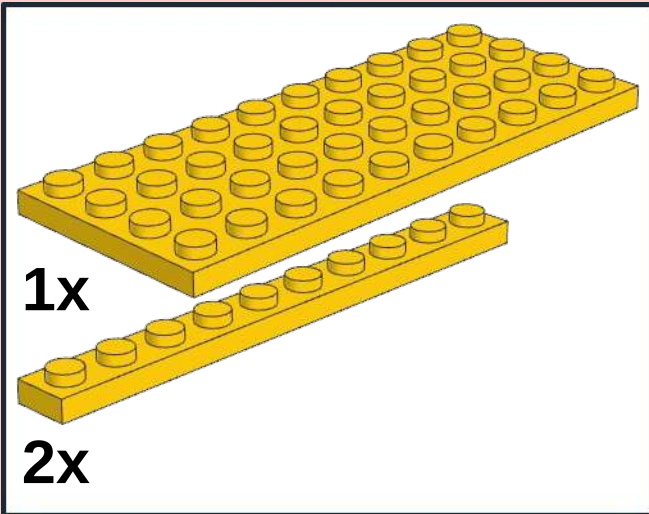
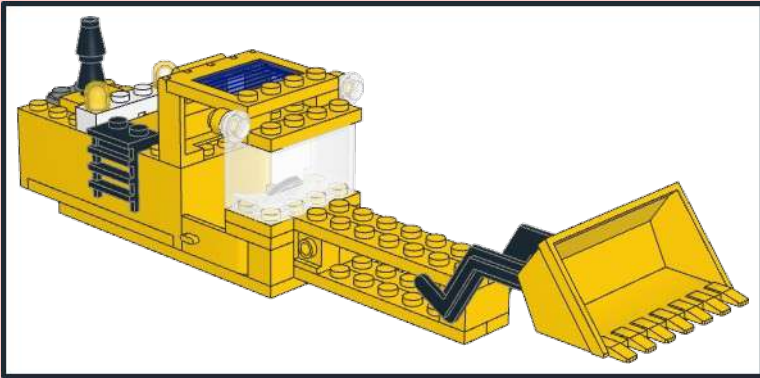

2

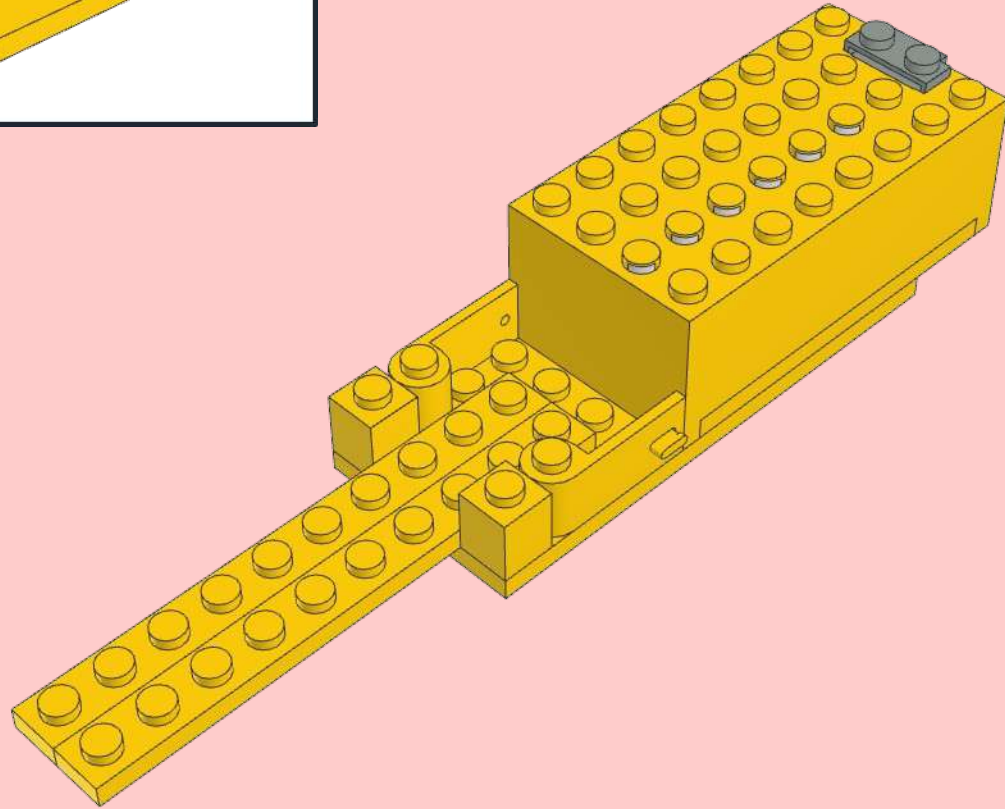
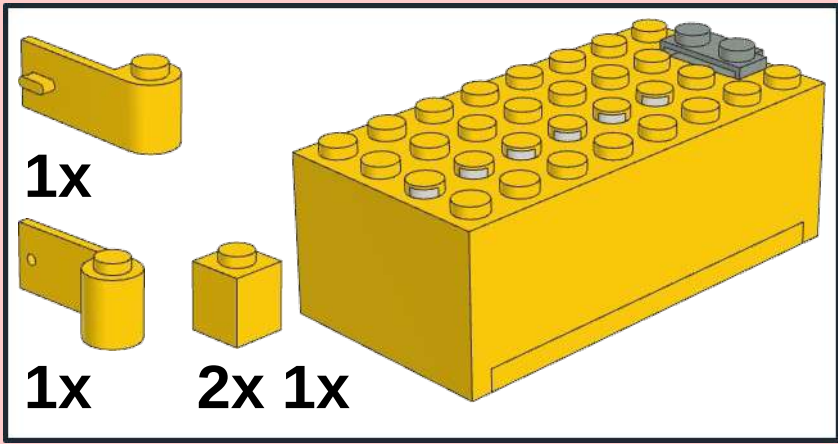

3

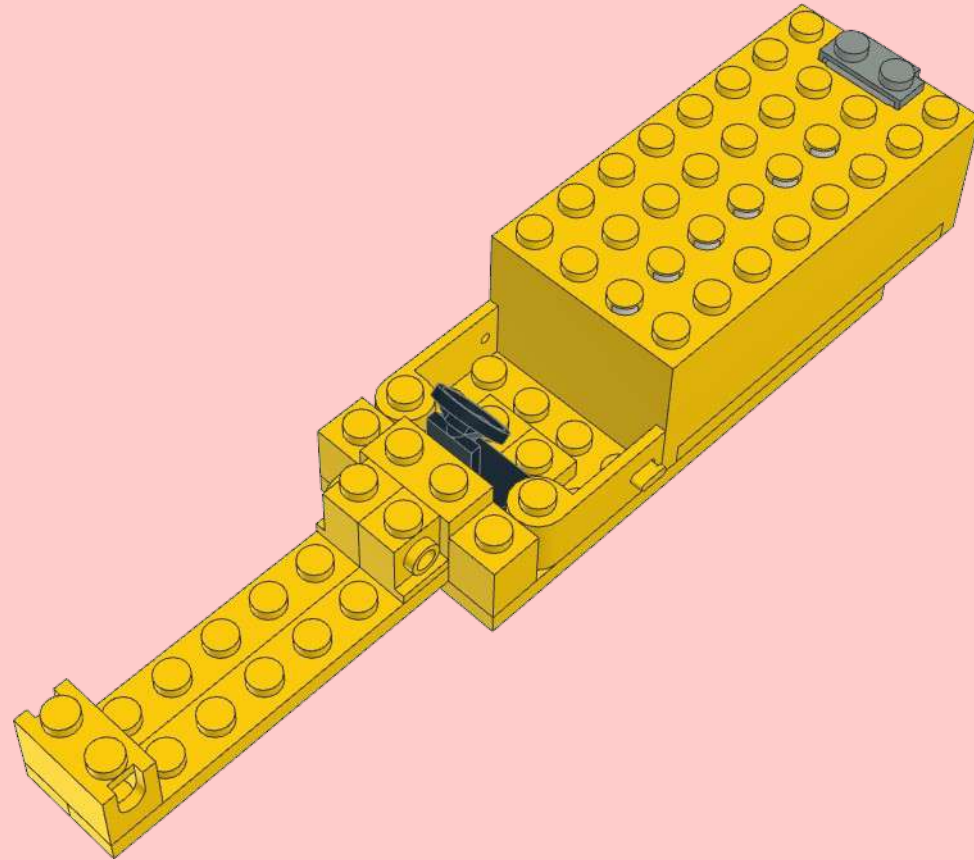
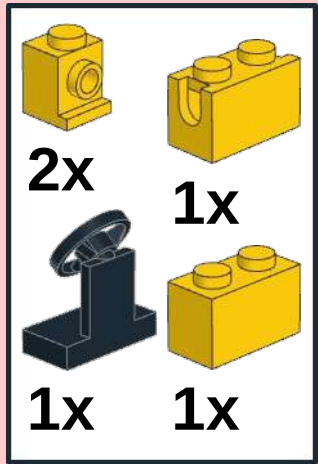

4
4x

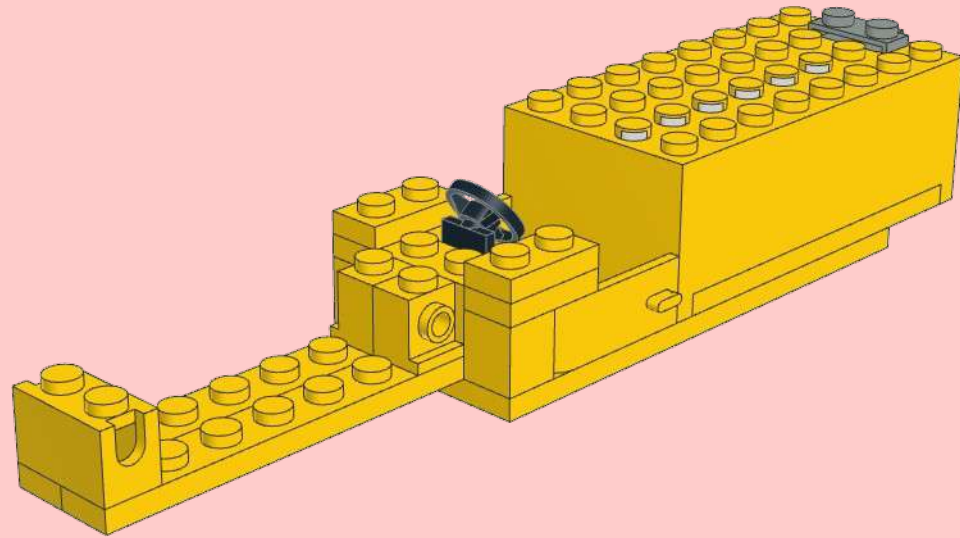

5

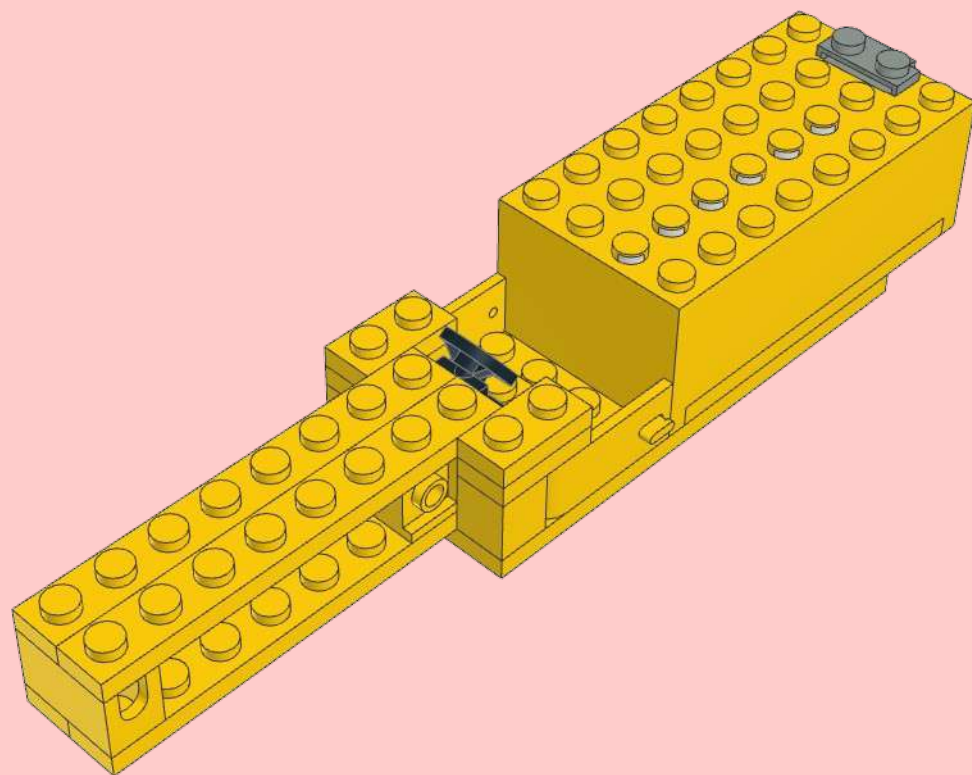
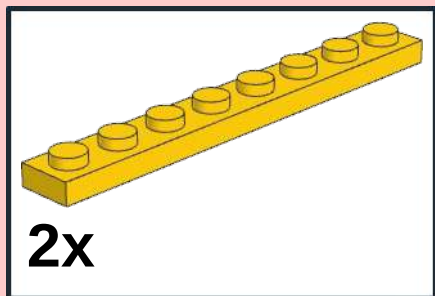

6

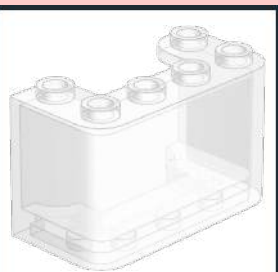

1x

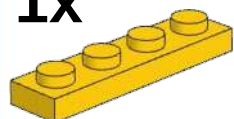

2x



7

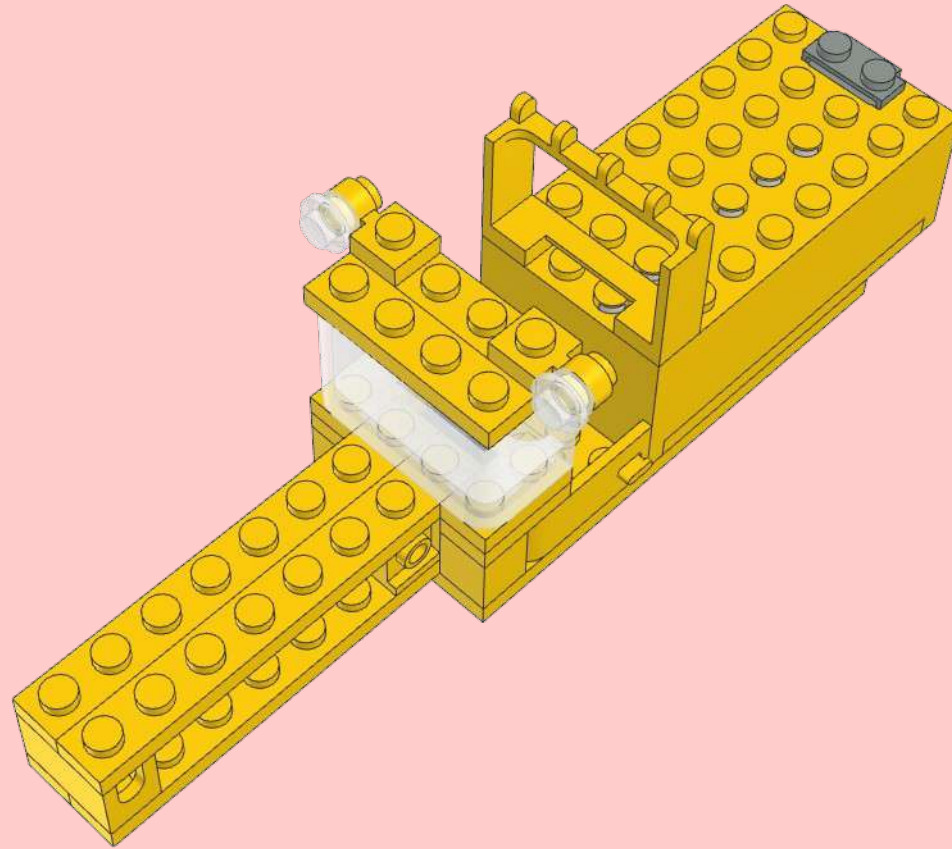
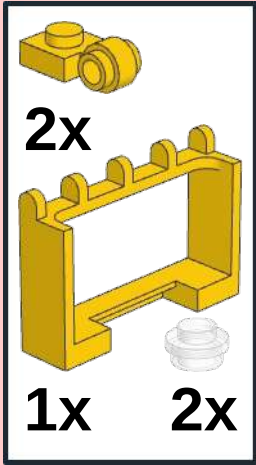

8

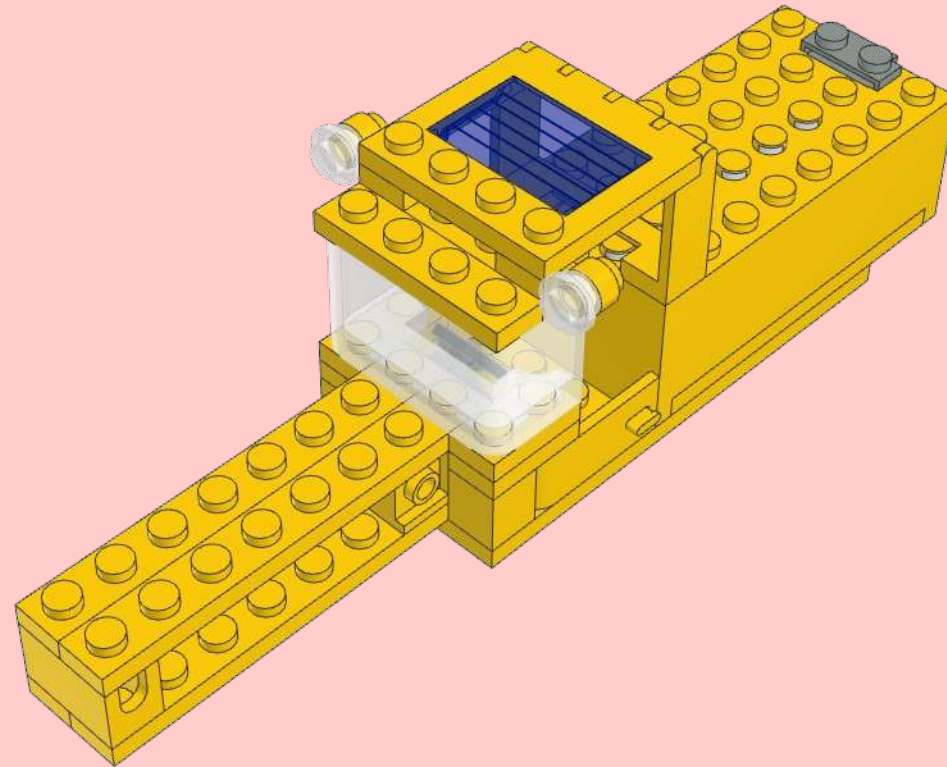
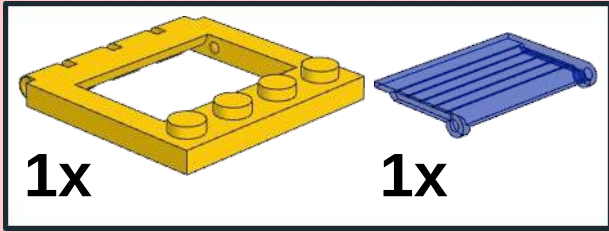

9

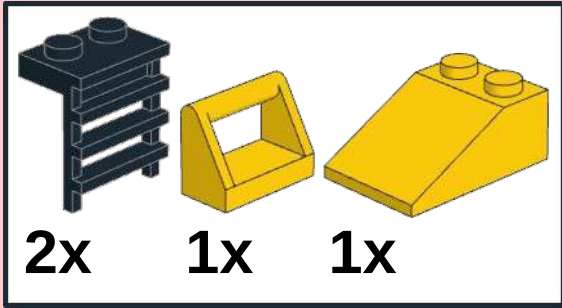

10

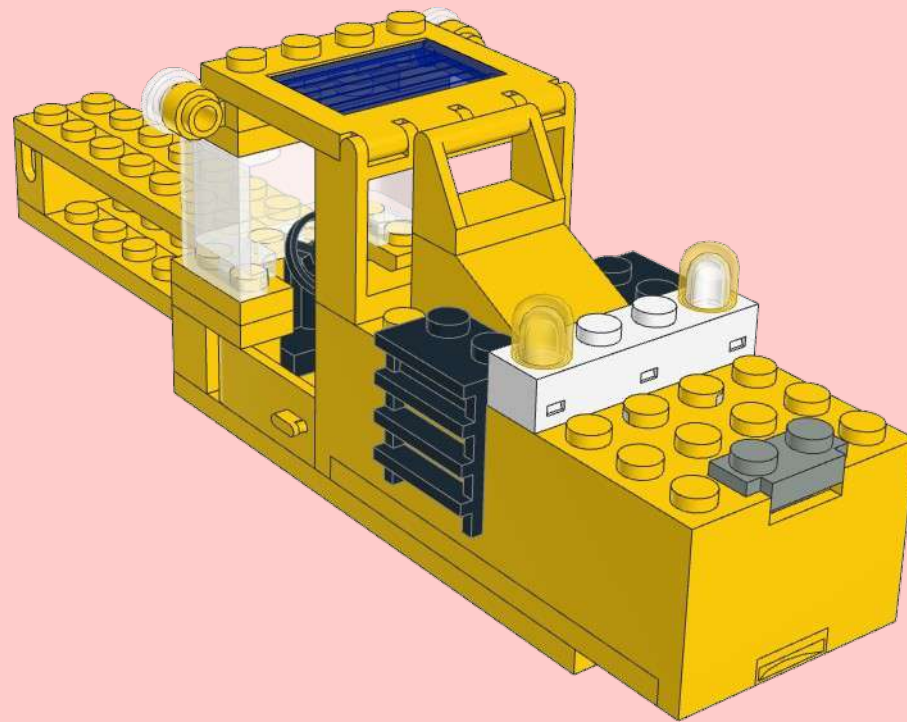
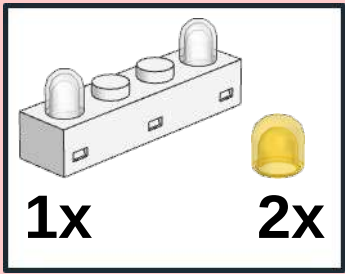

11

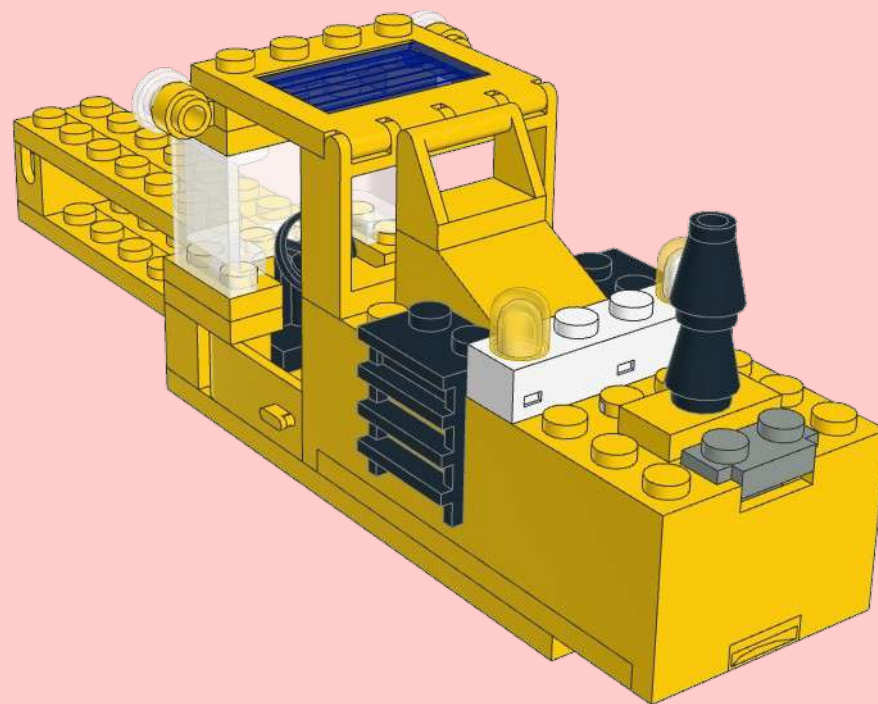
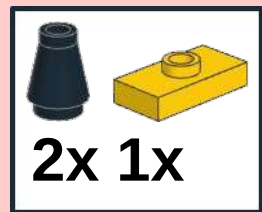

12

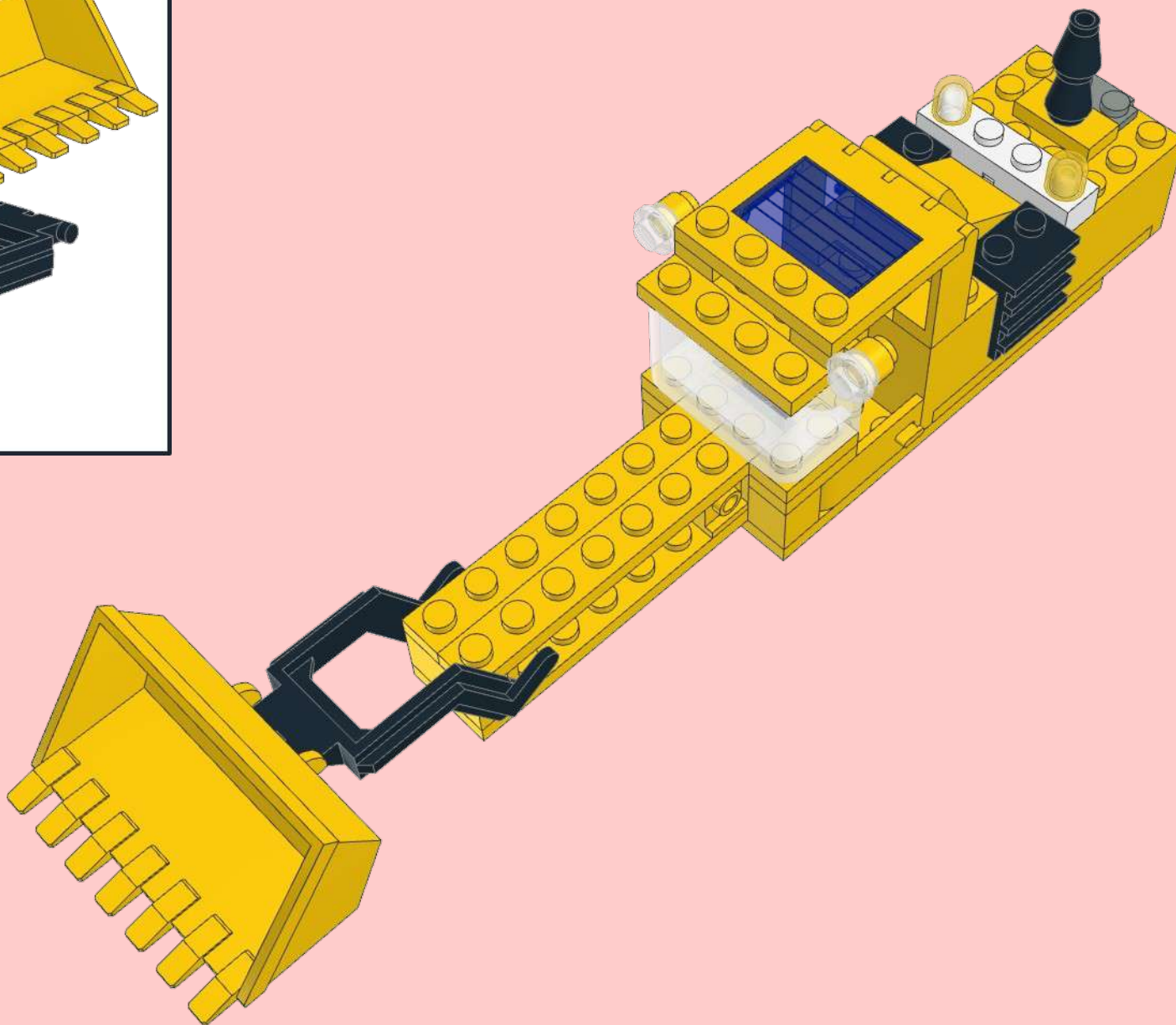
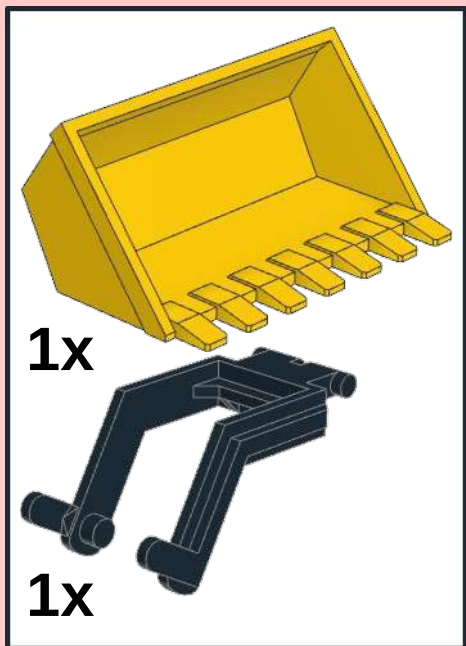

2

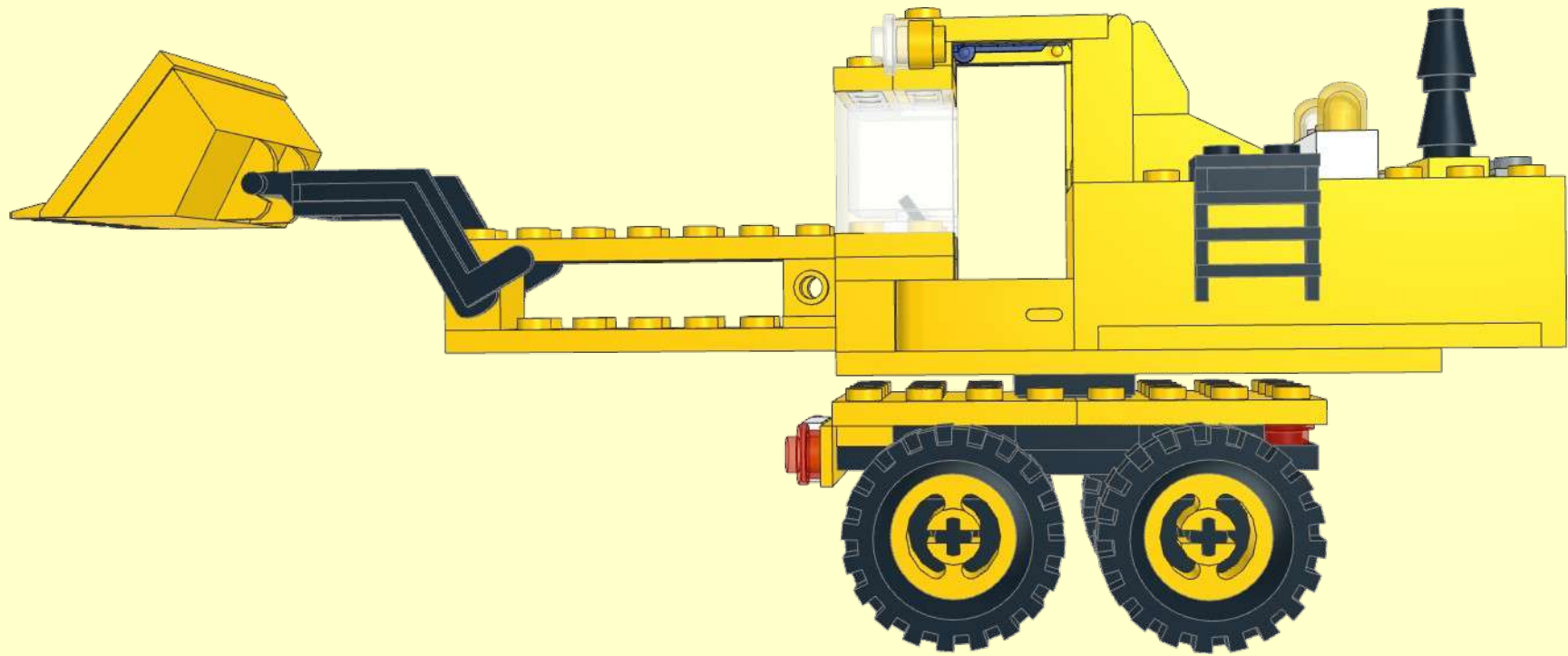

3

