

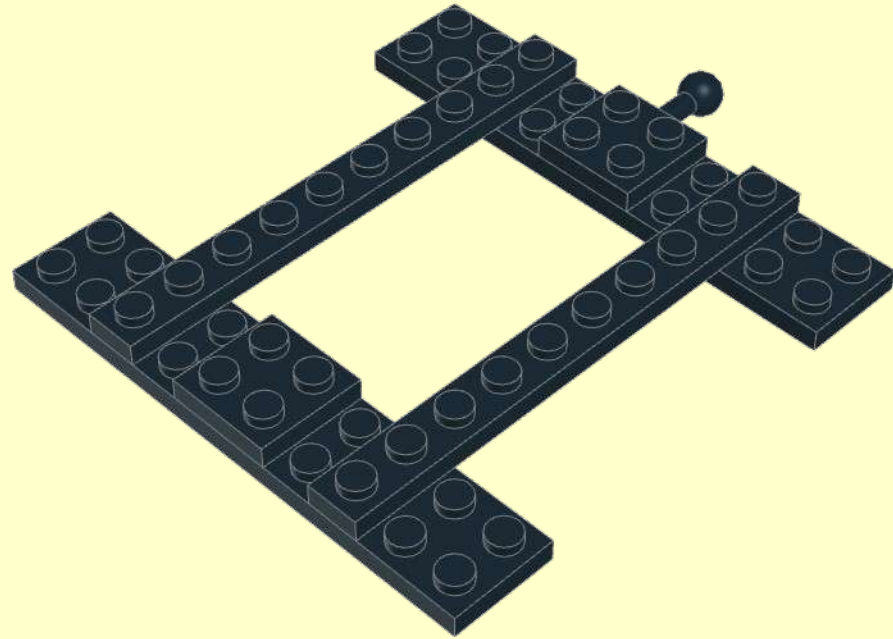

1

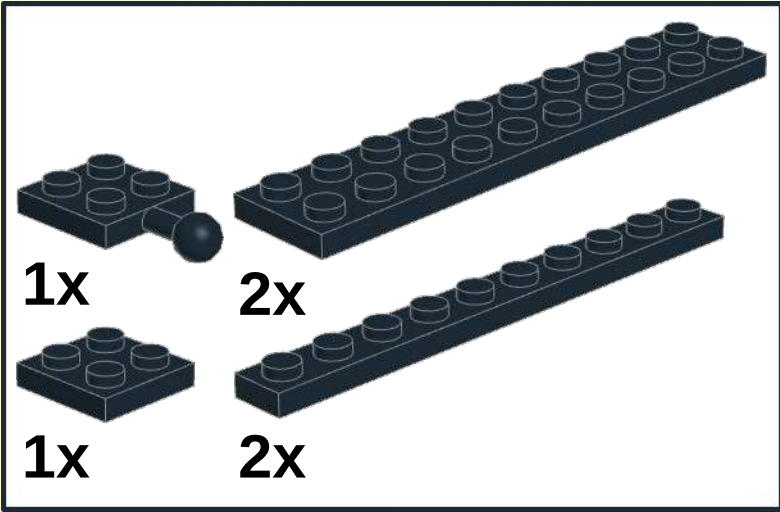

2

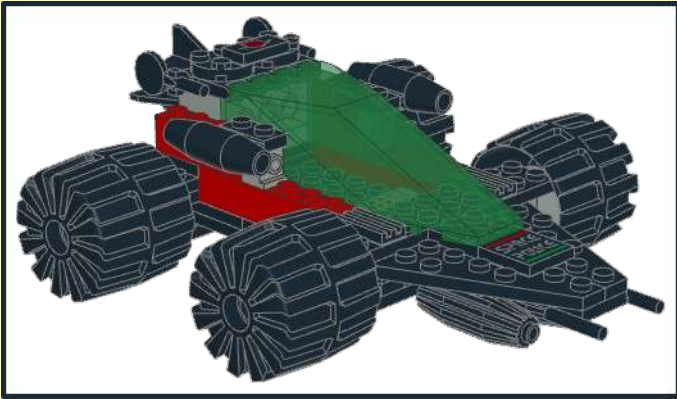
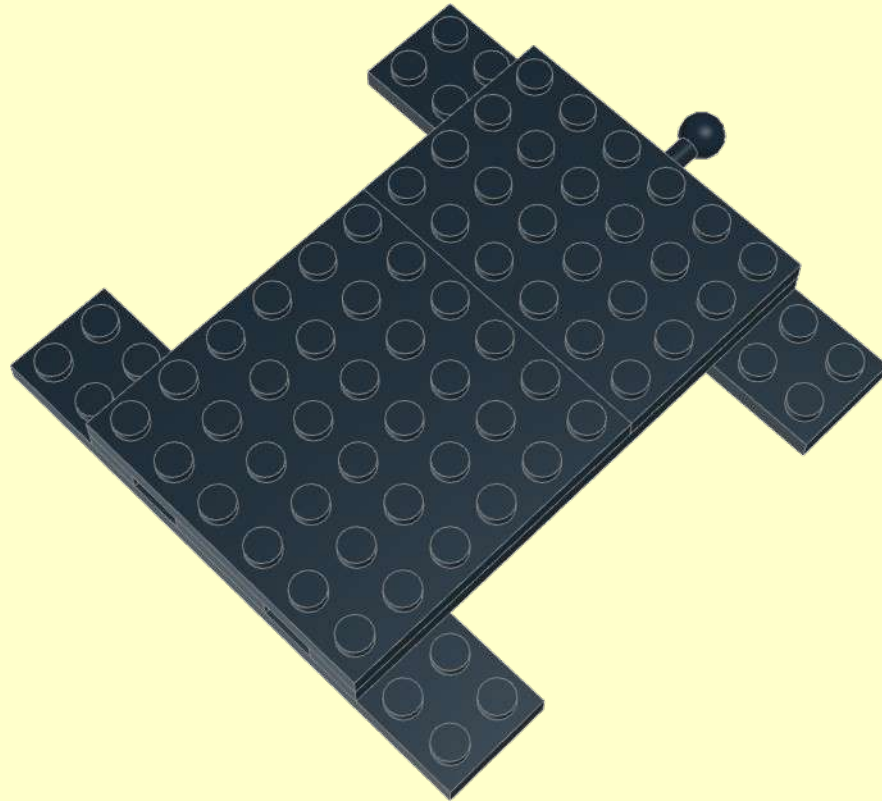
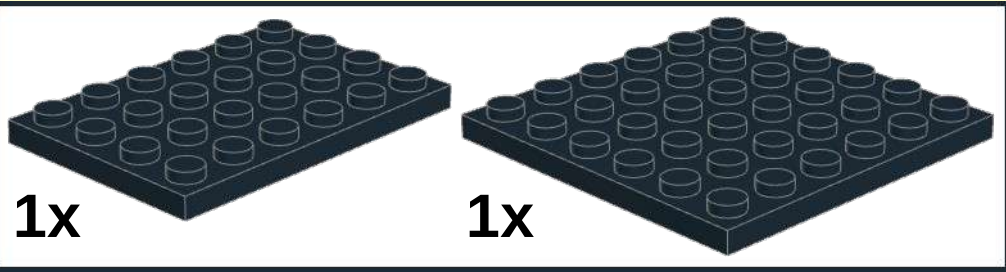

3



1x

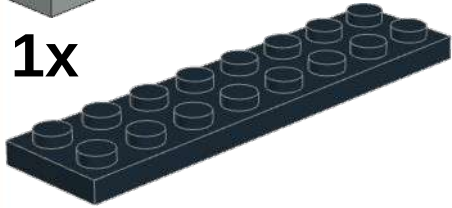

1x



1x

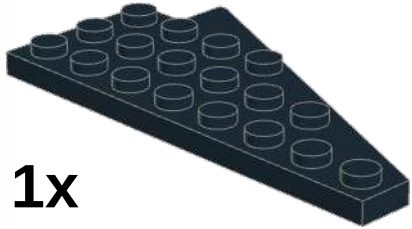

1x

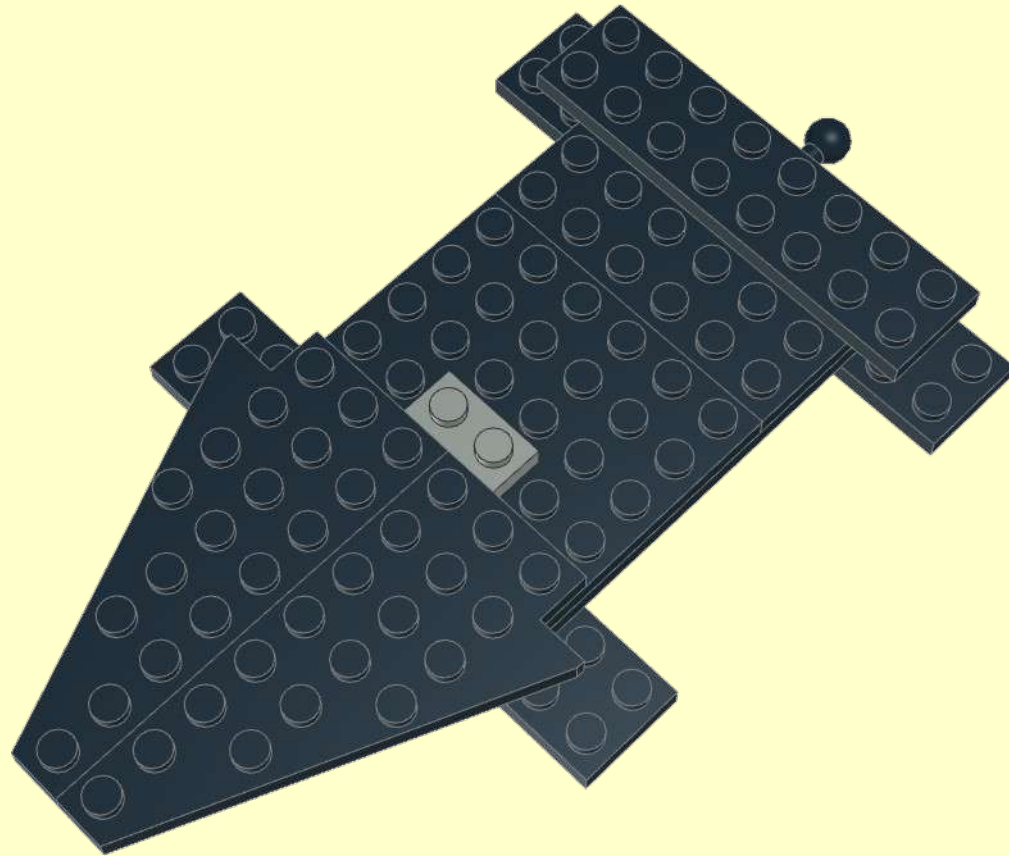

4

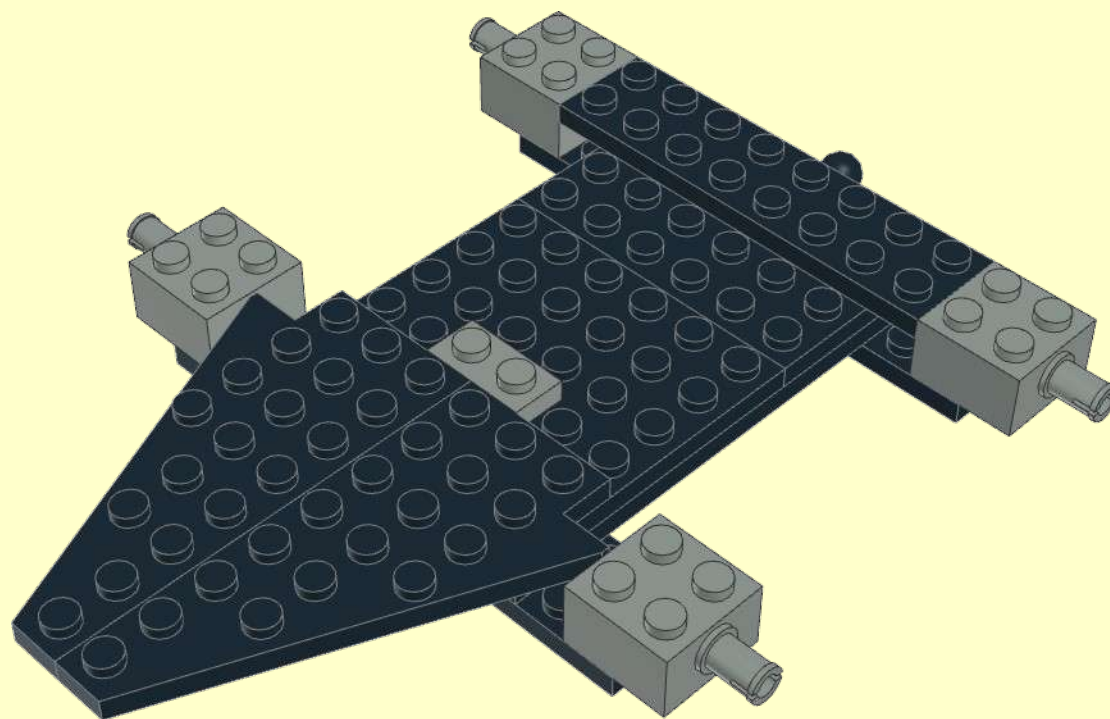
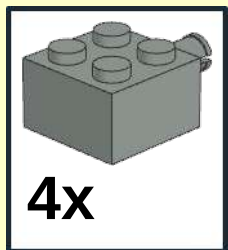

5

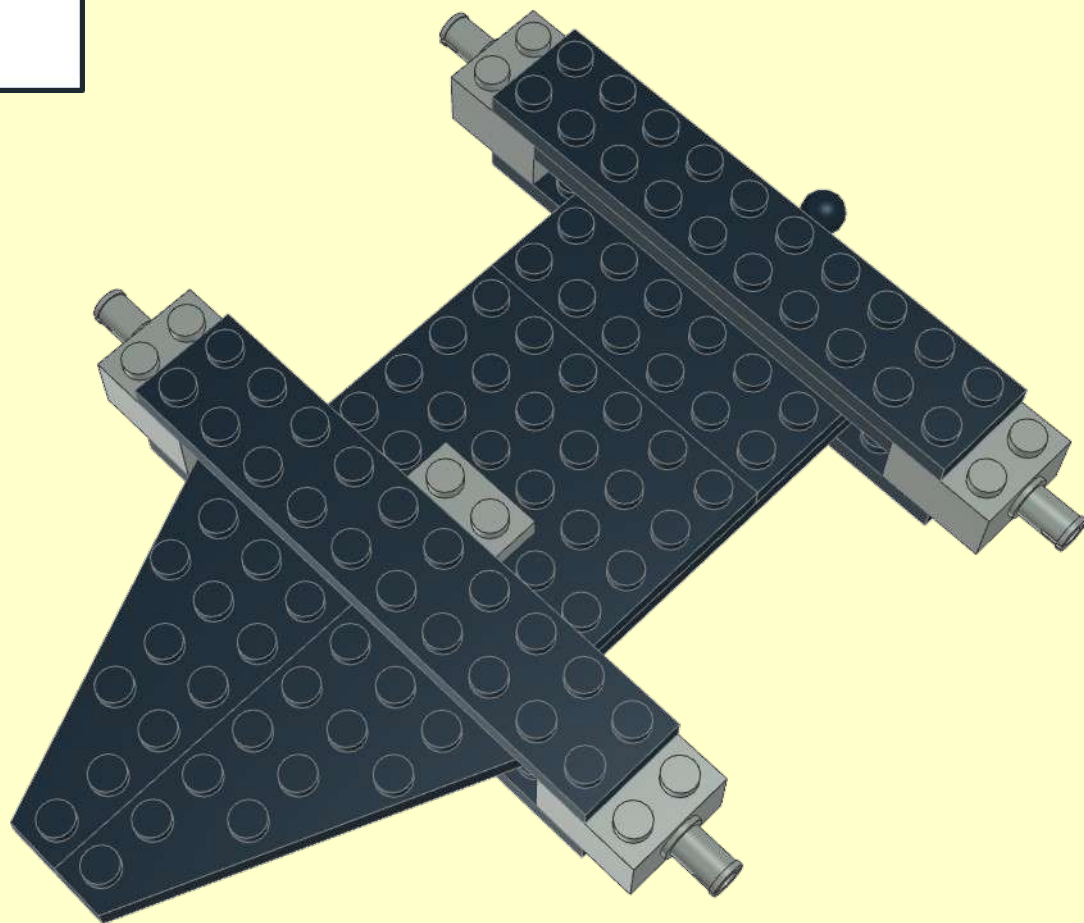
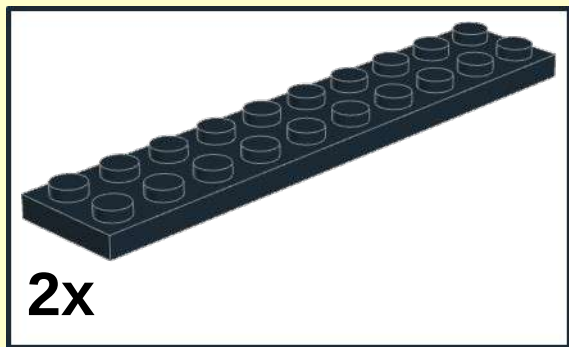

6

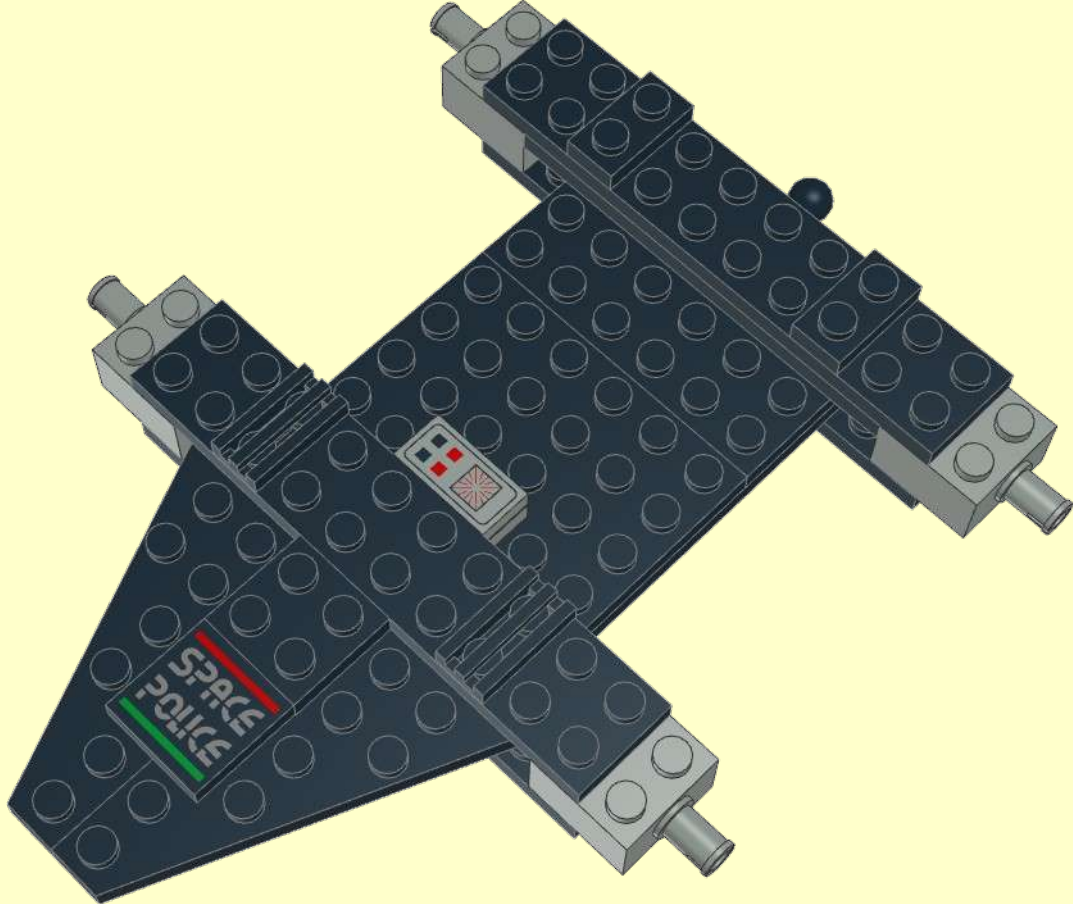
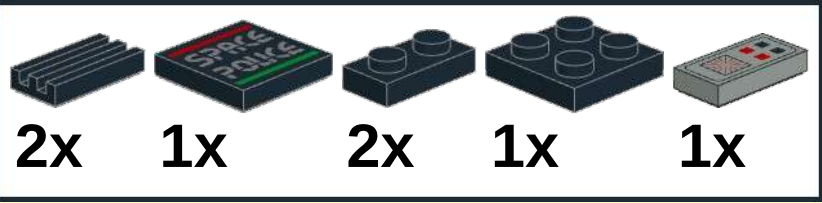

7

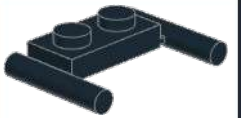

1x



2x

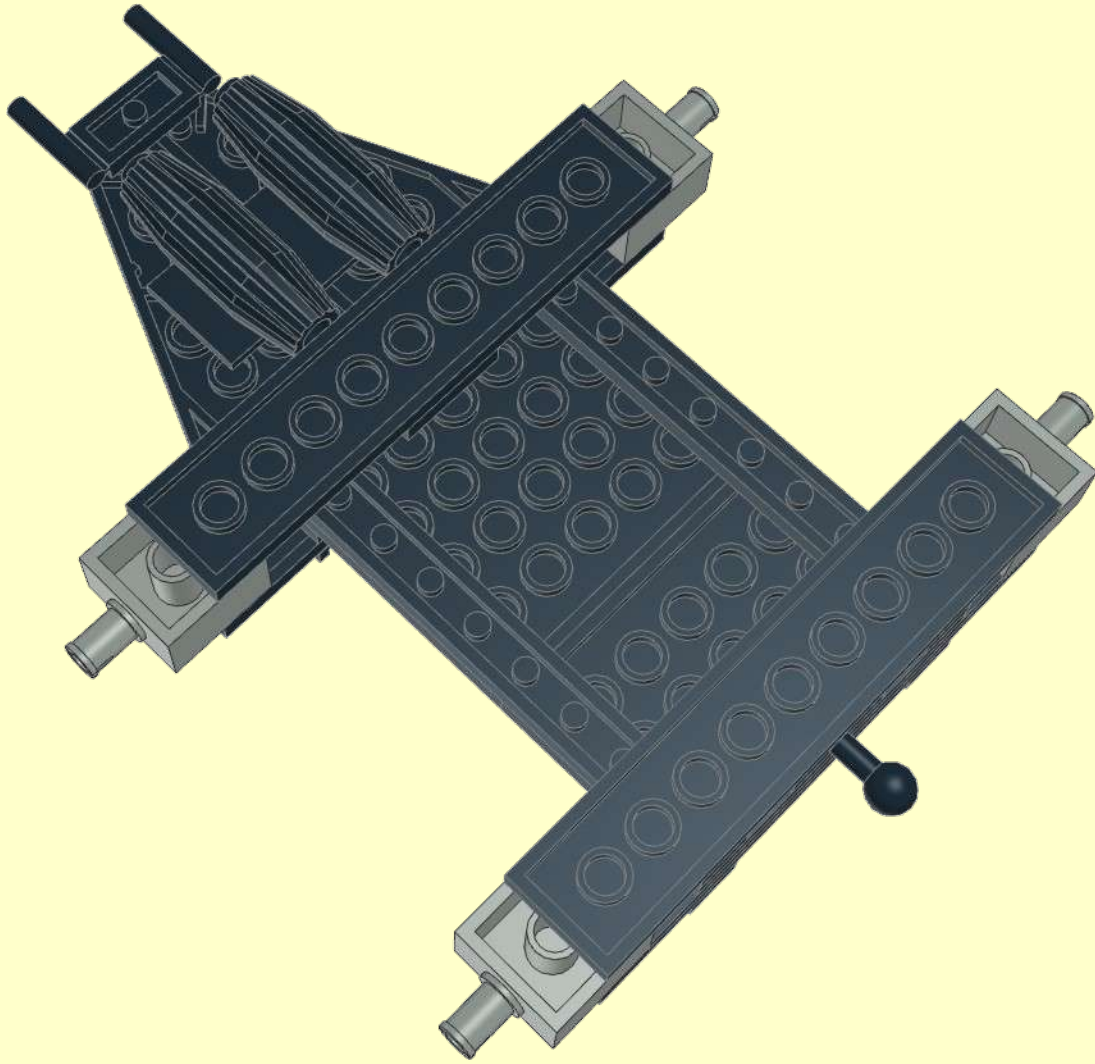

8

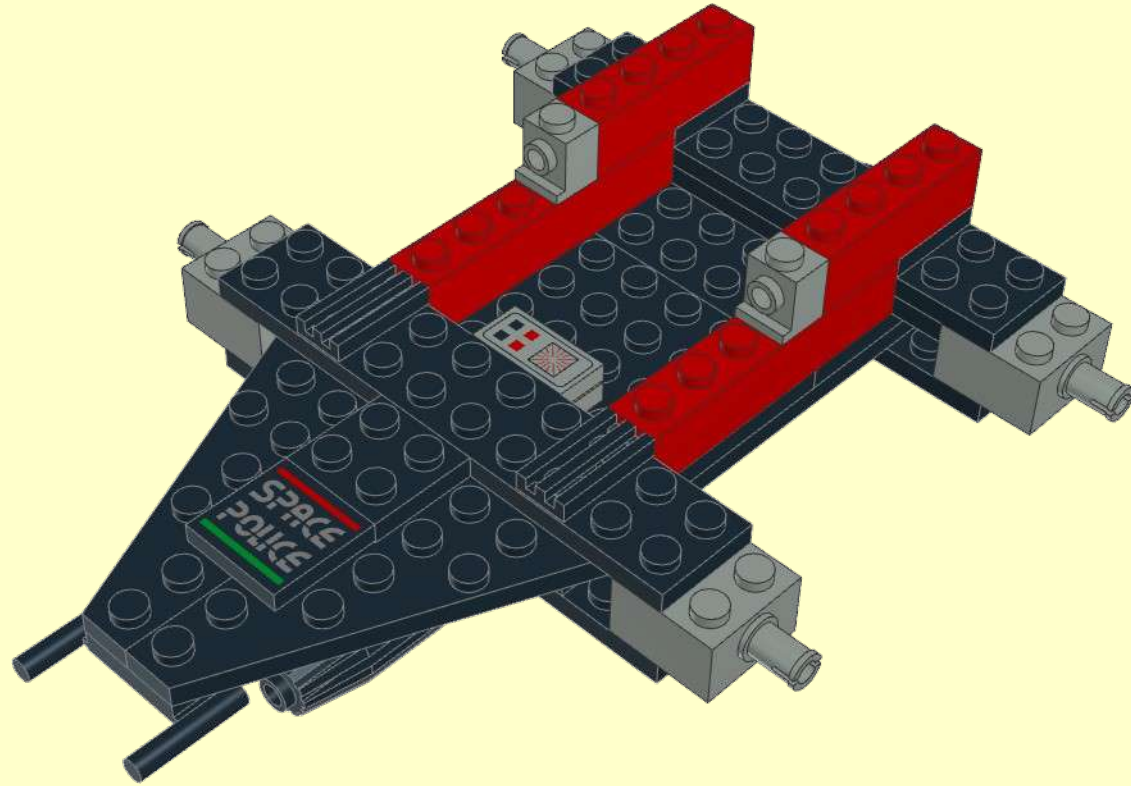
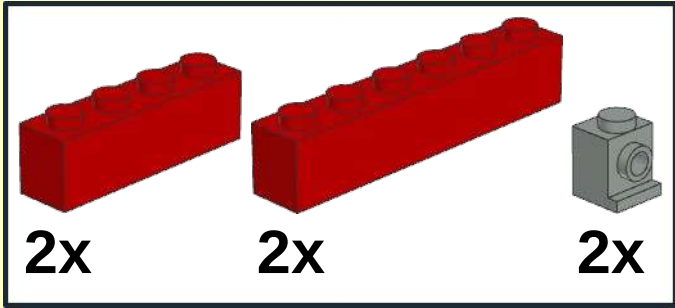

9

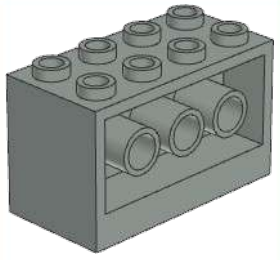

1x

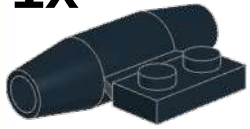

2x

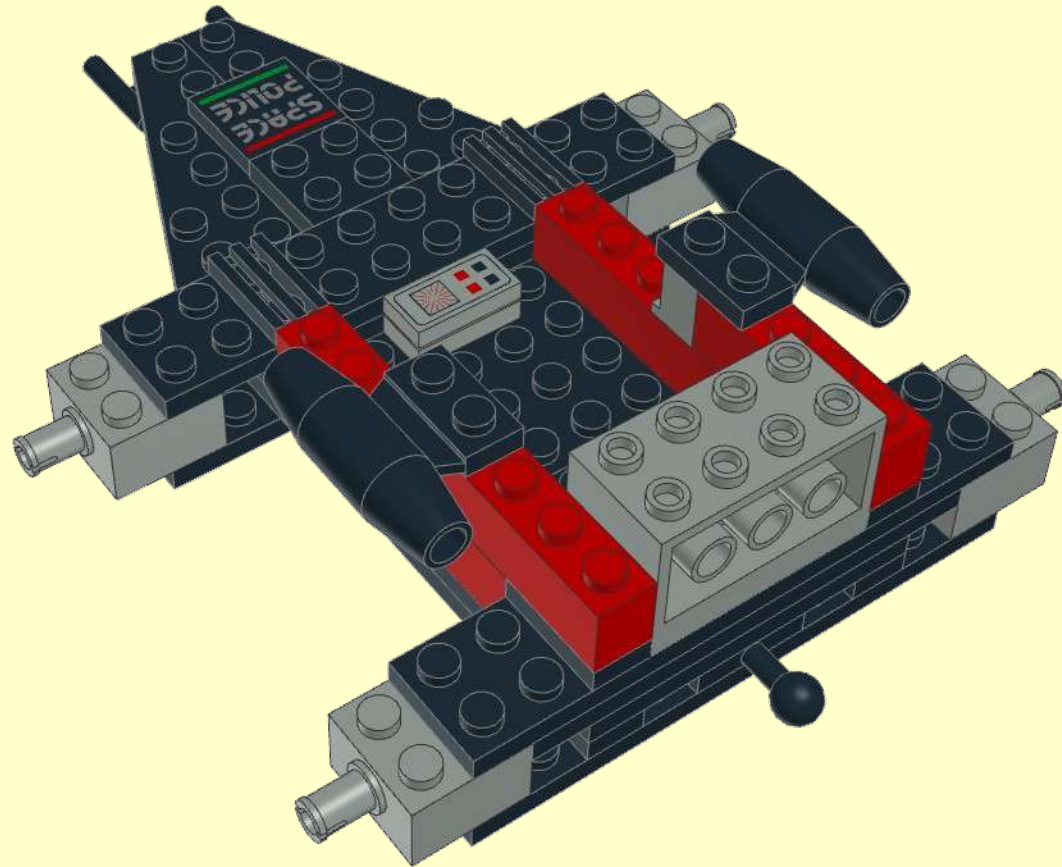

10

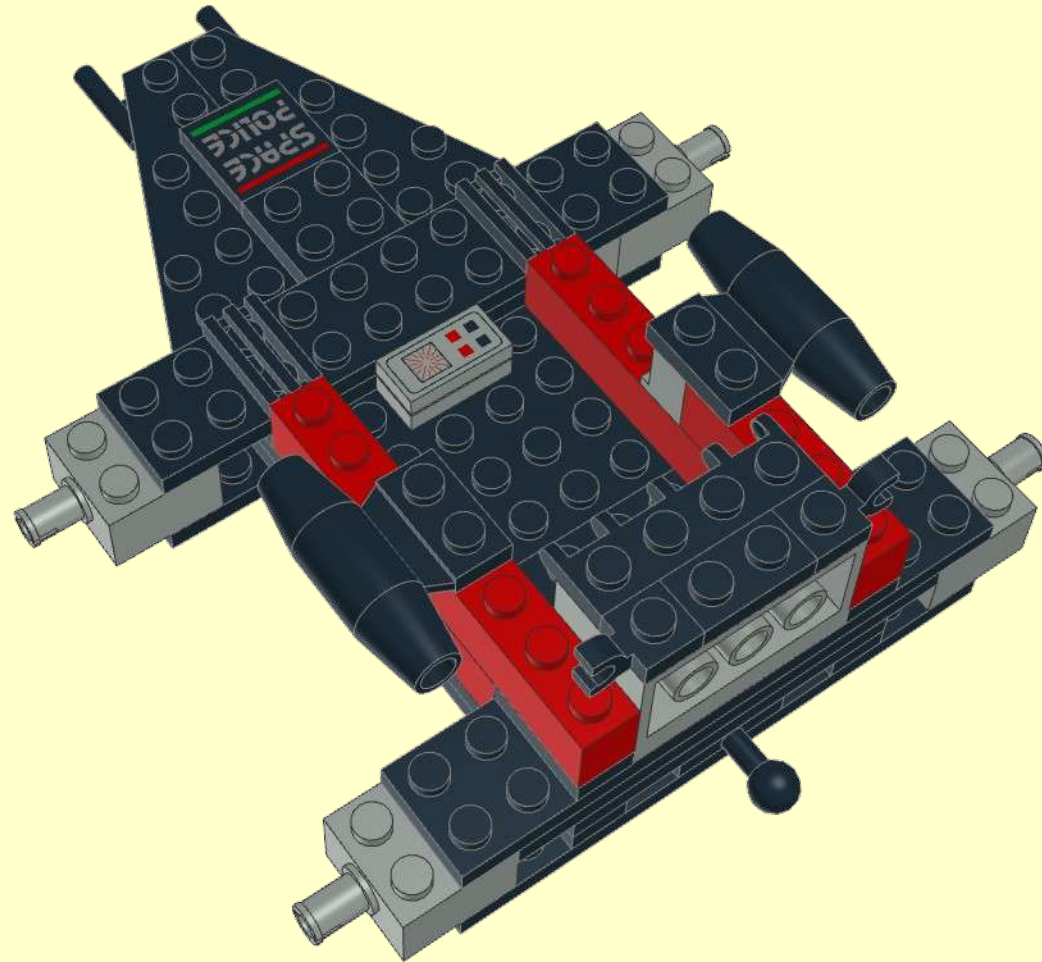
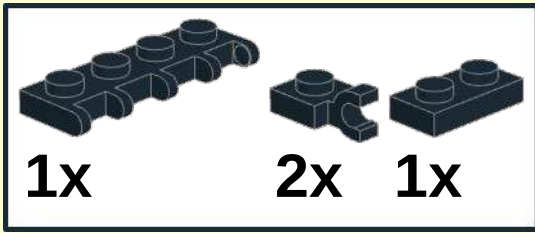

11

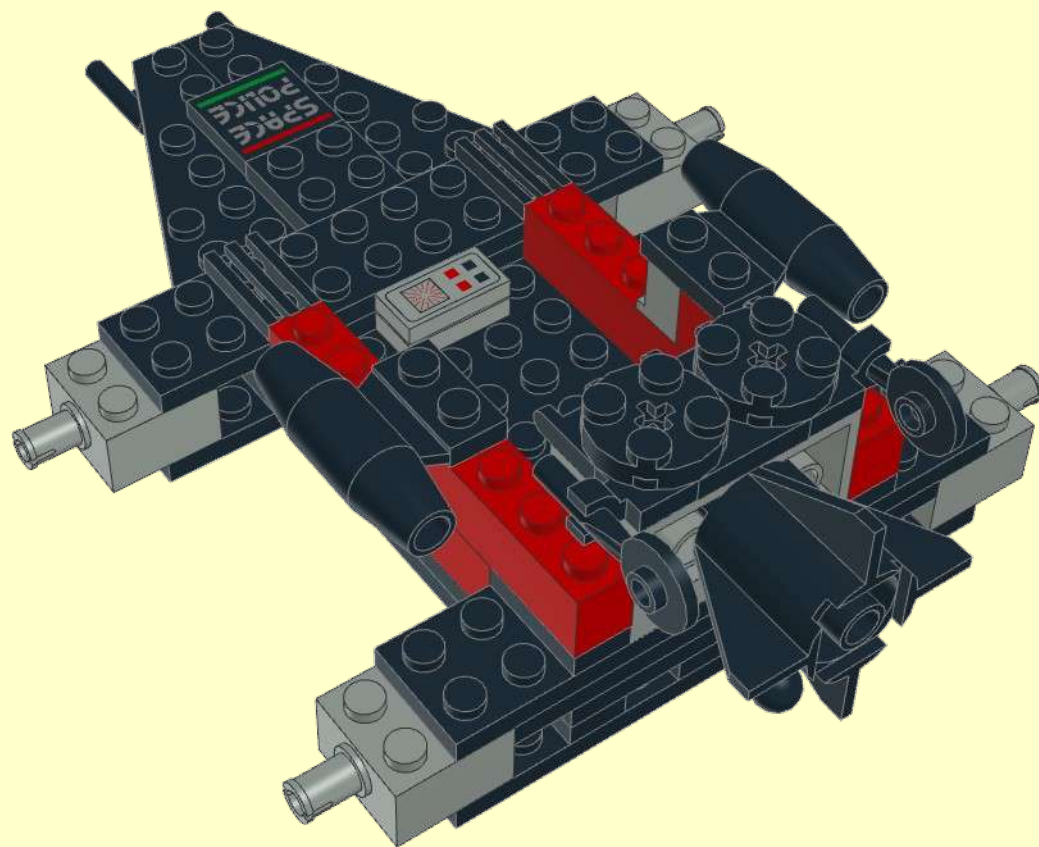
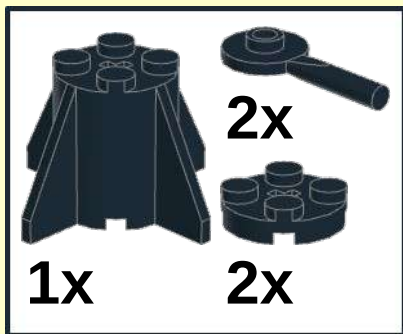

12

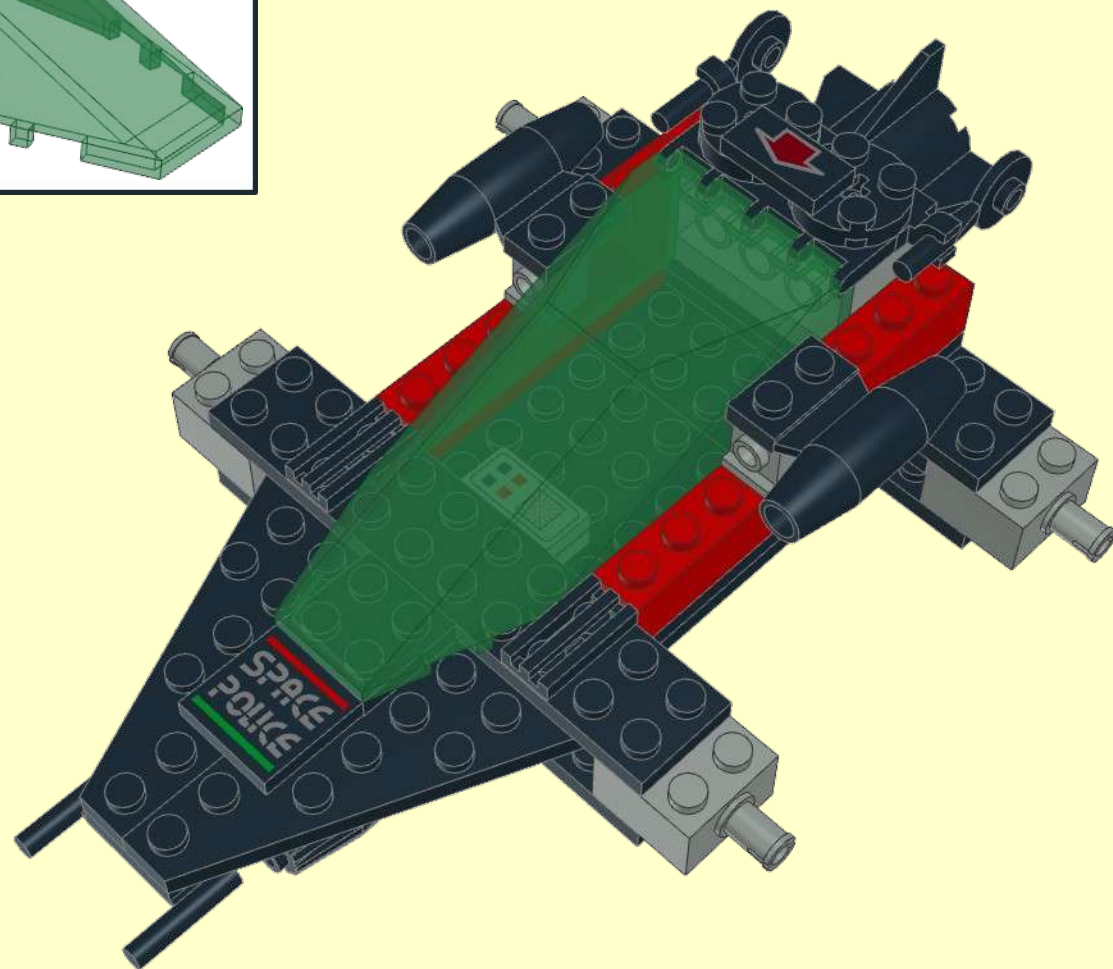
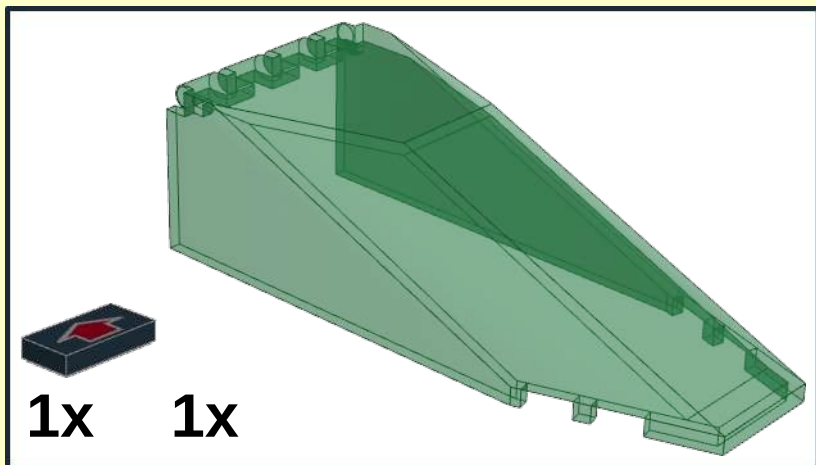

13

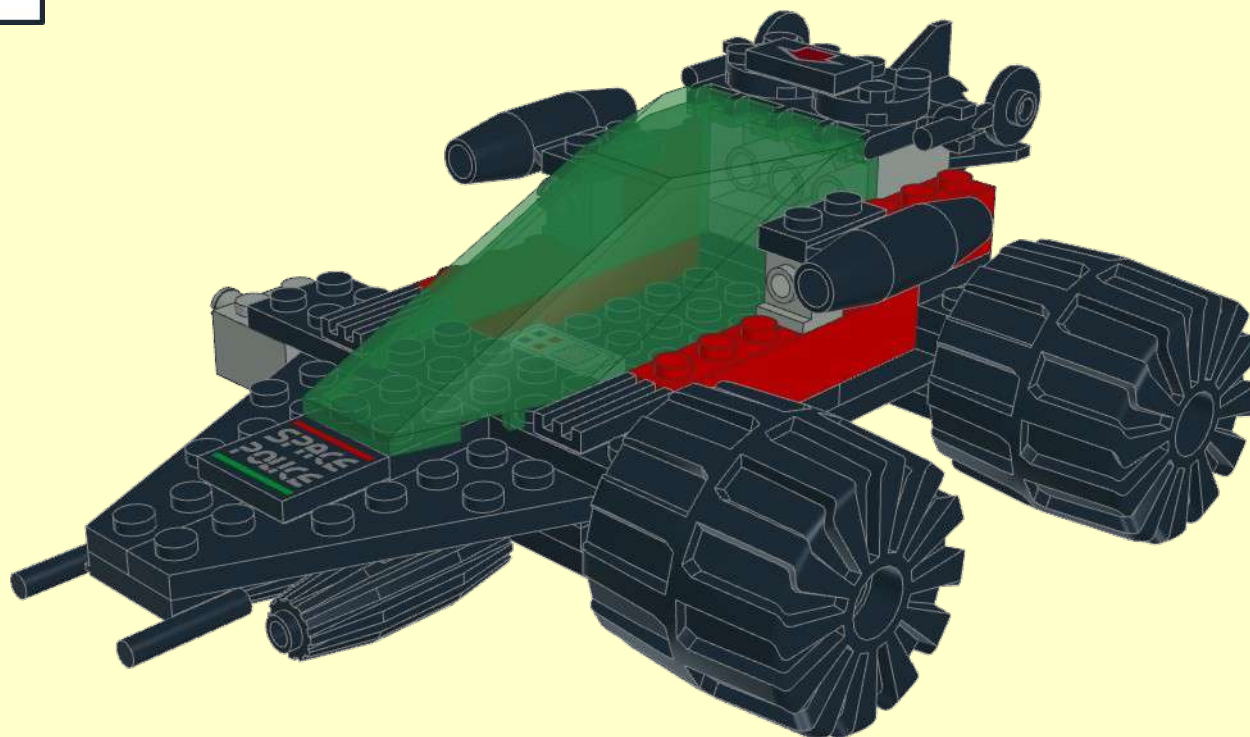

14

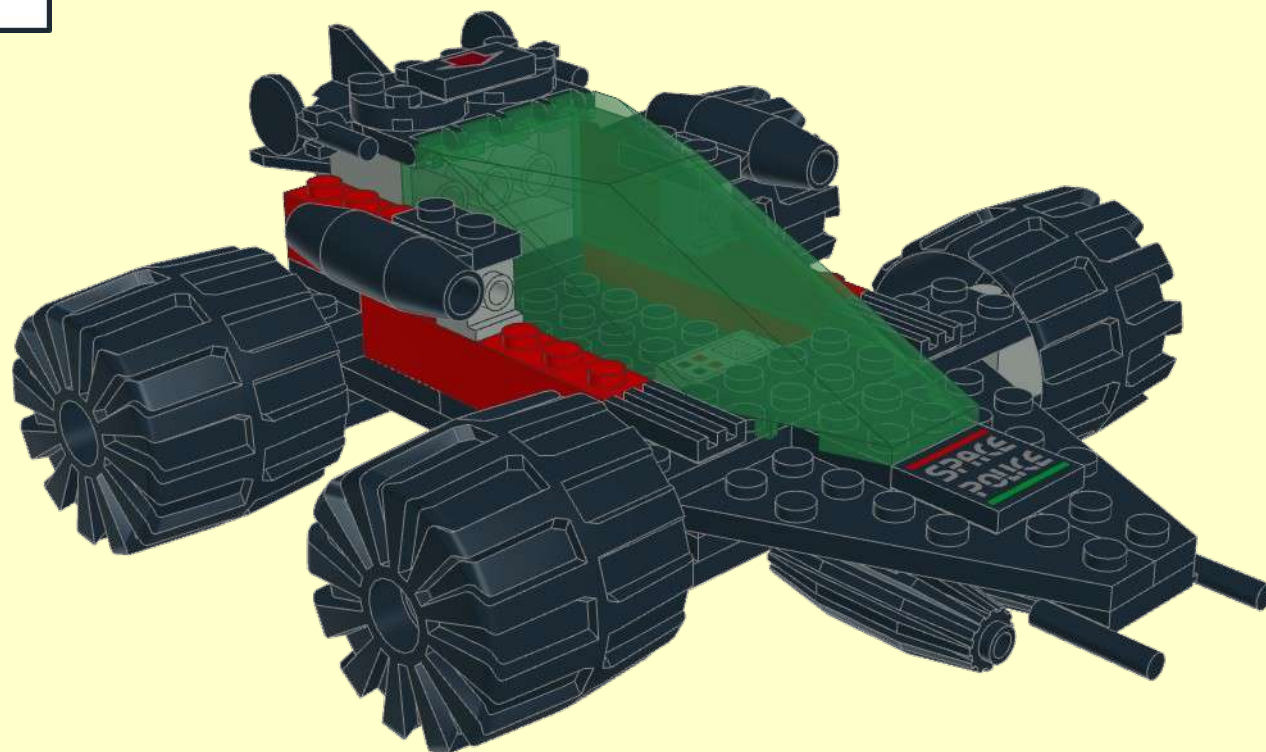

1

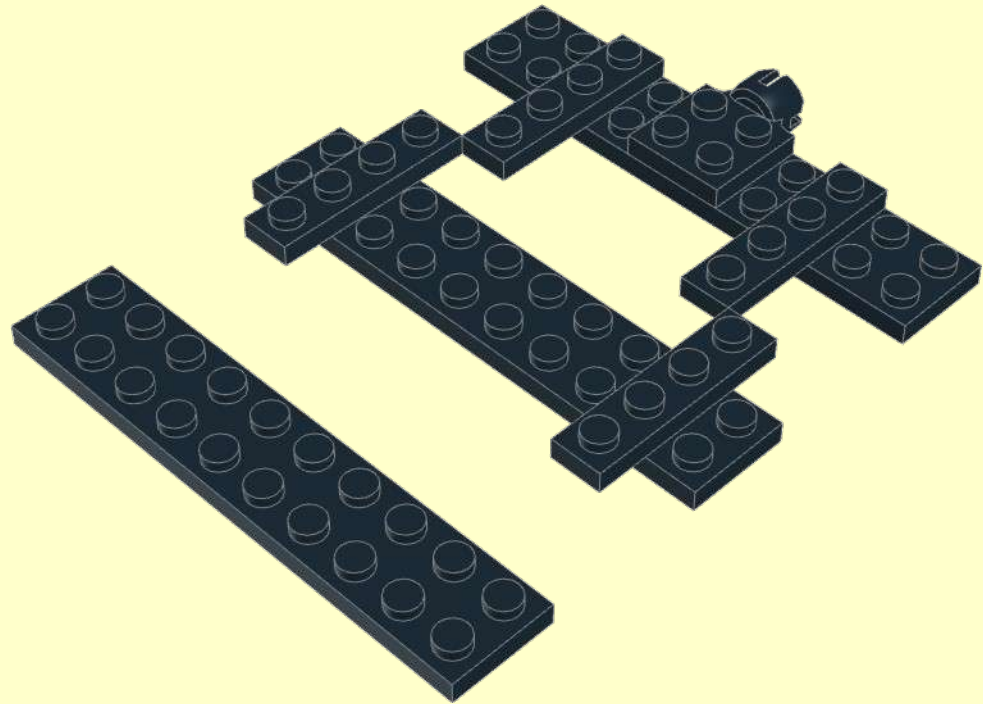
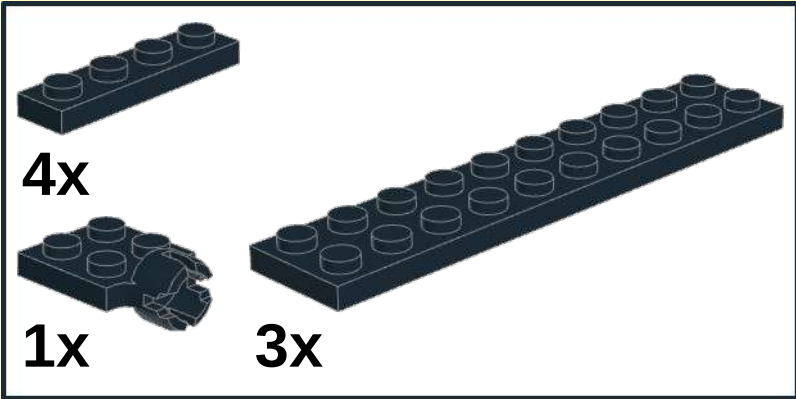
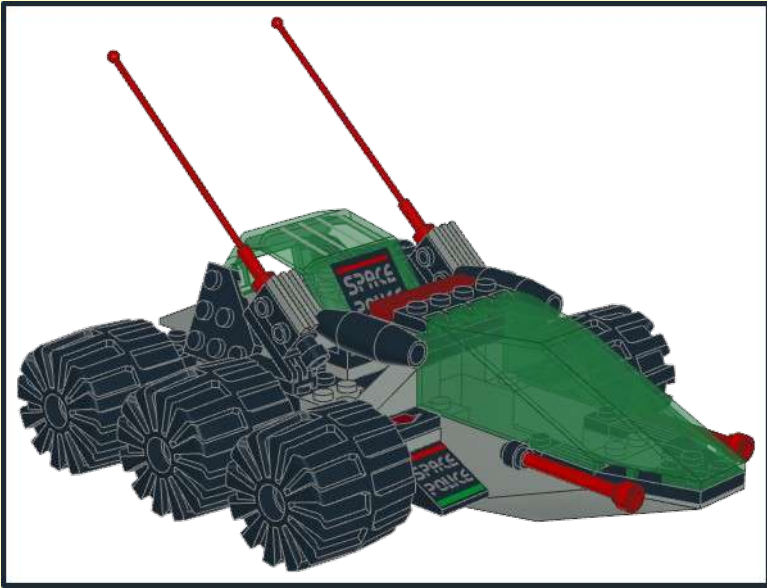

2

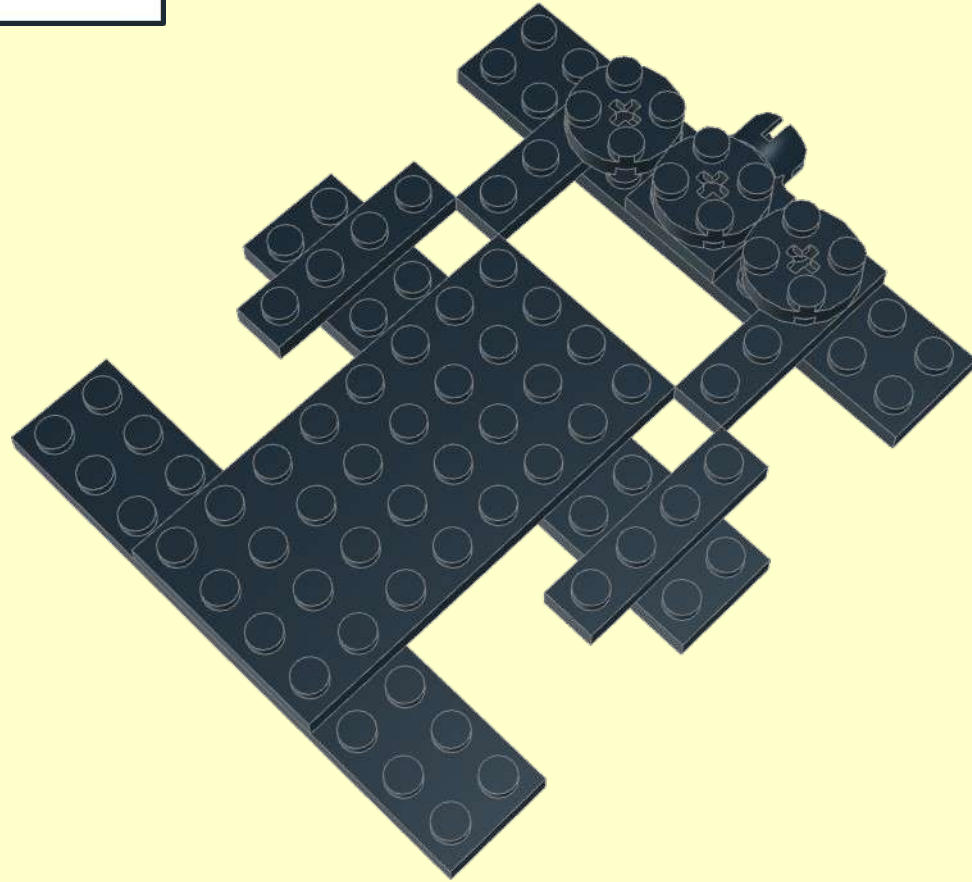
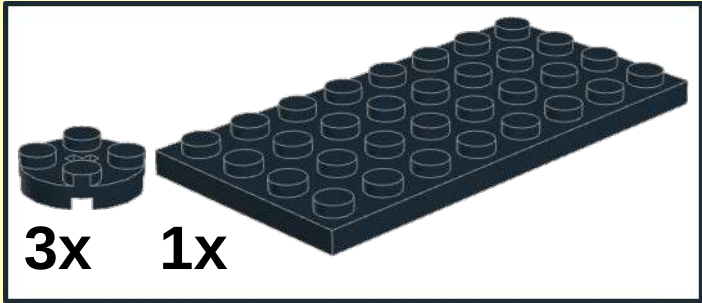

3

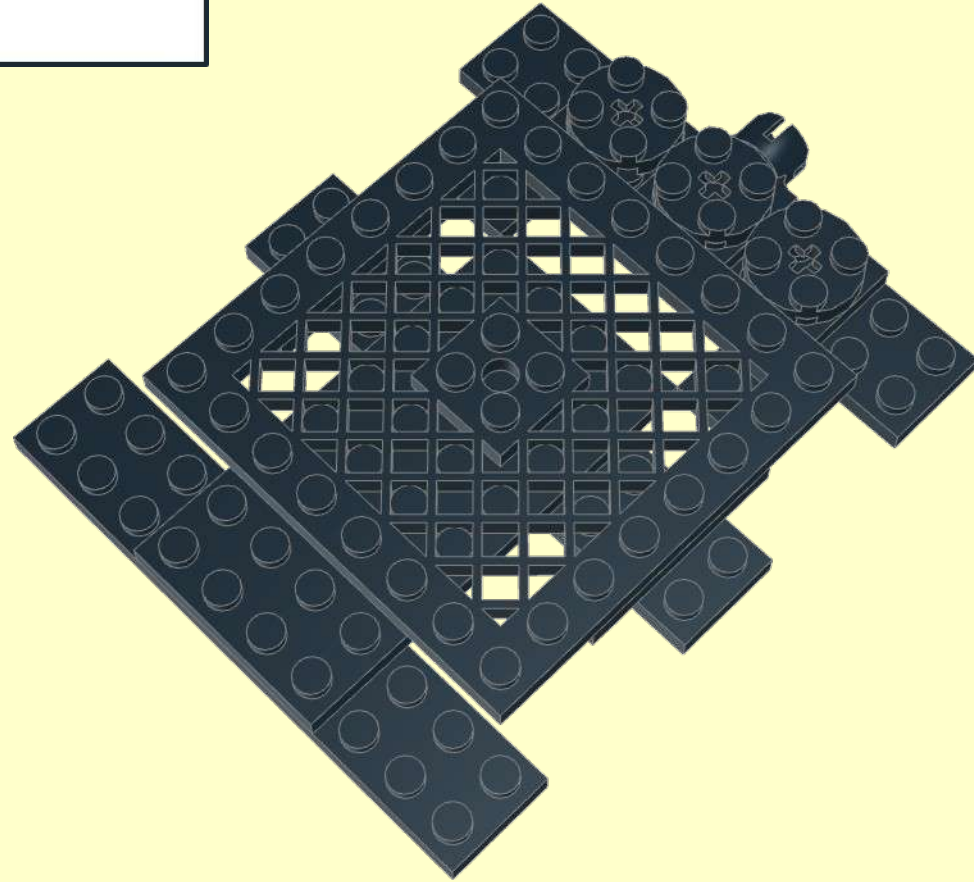
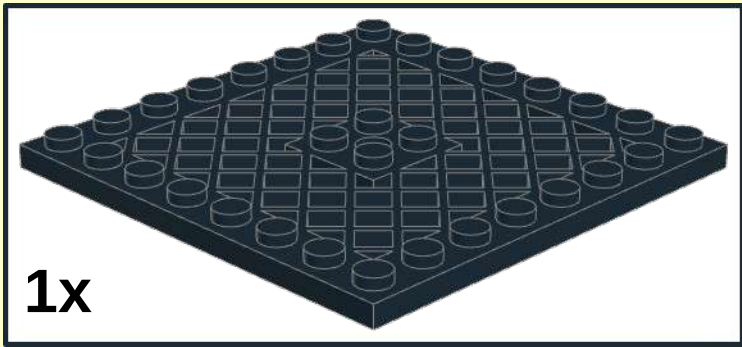

4

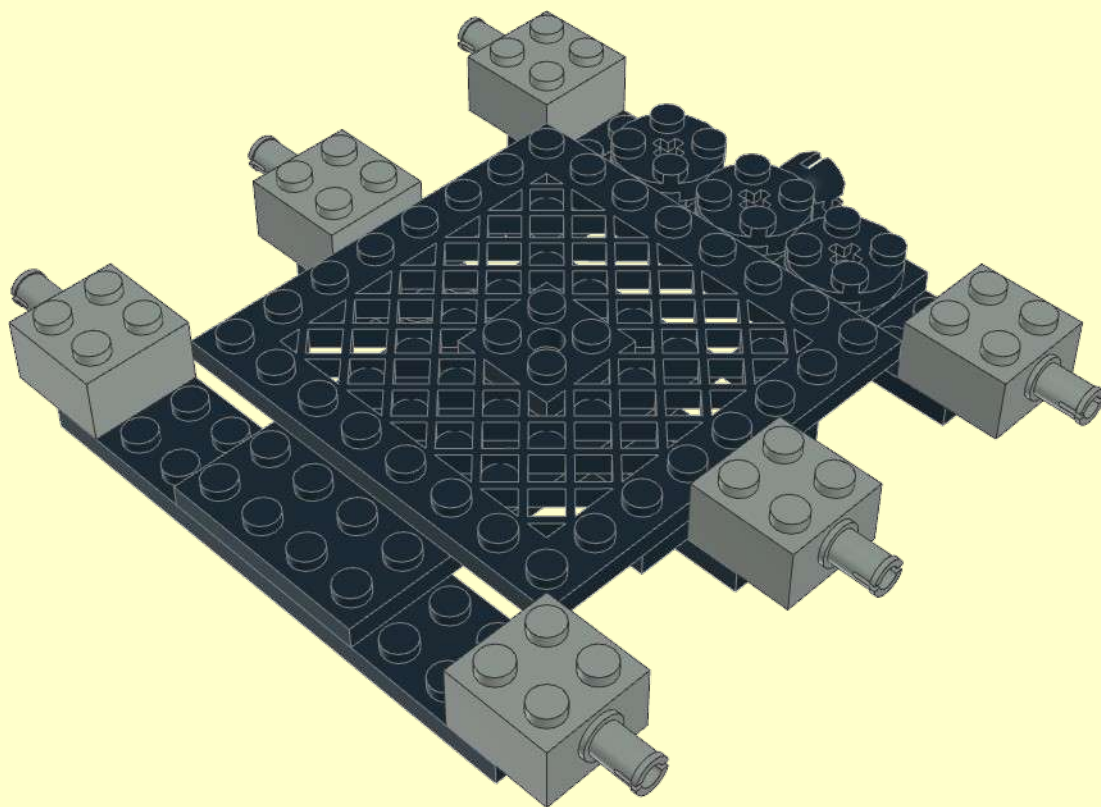
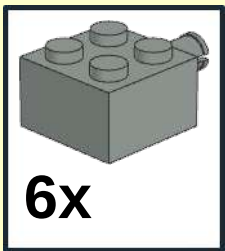

5

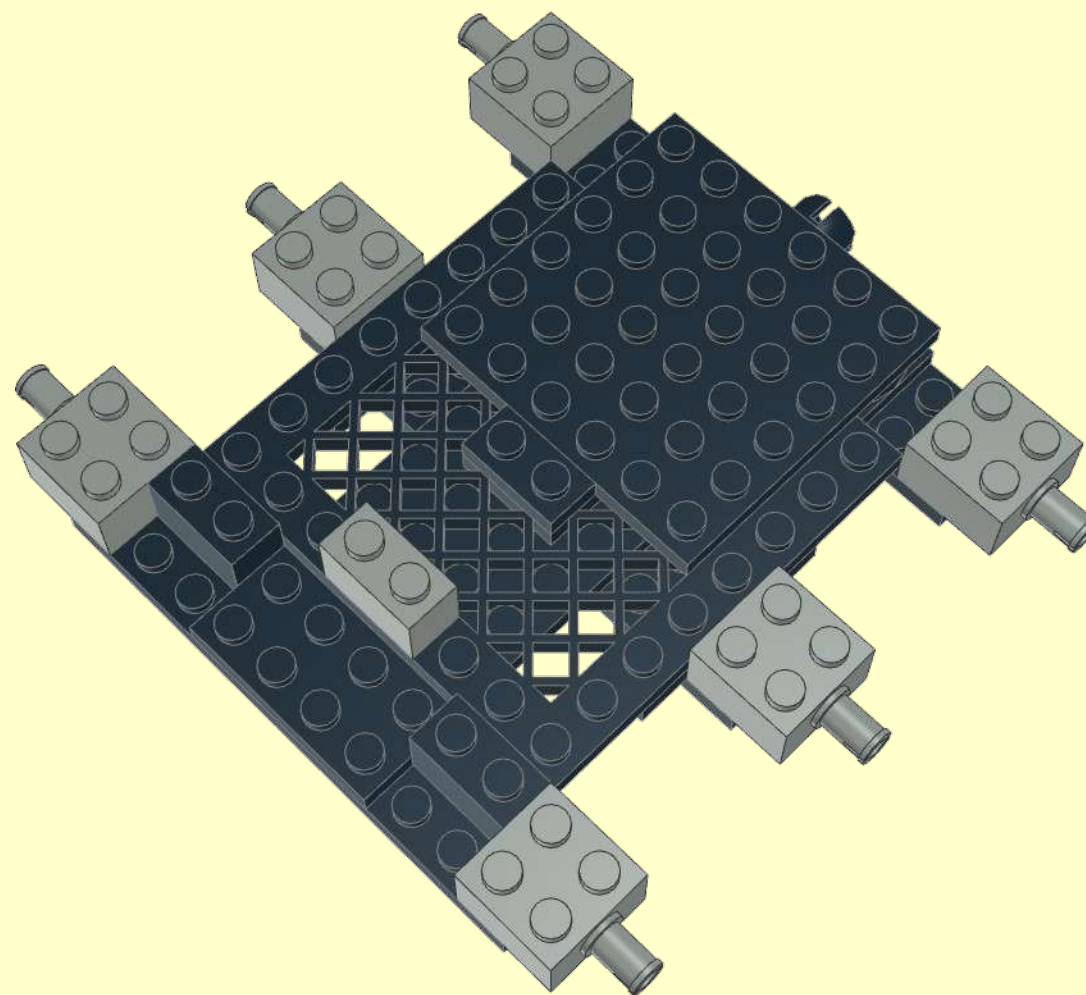
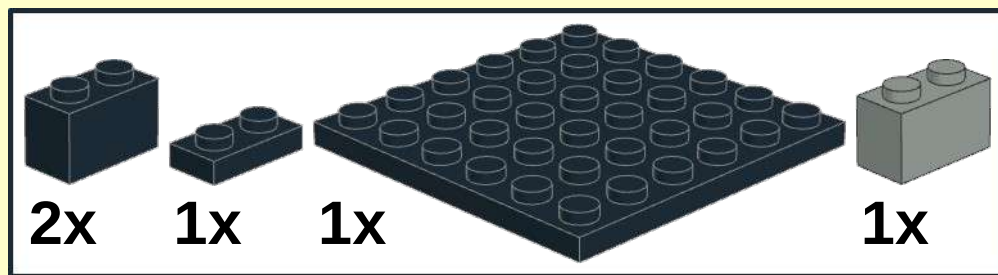

6

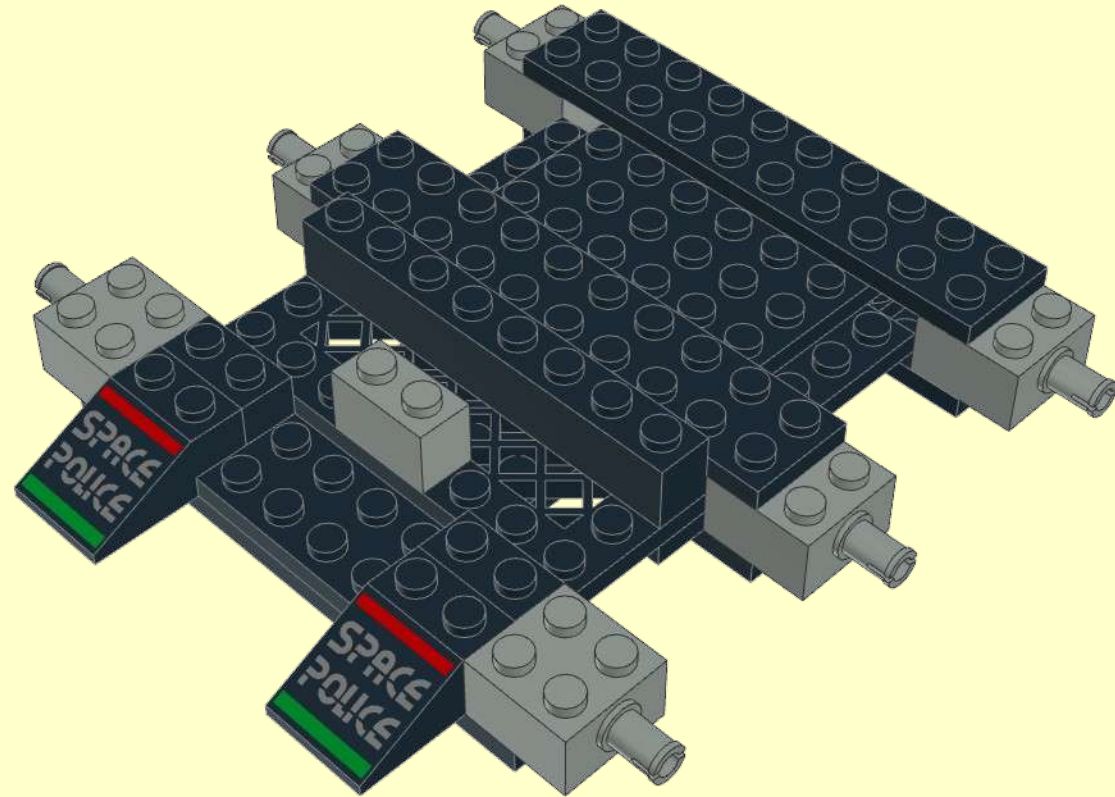
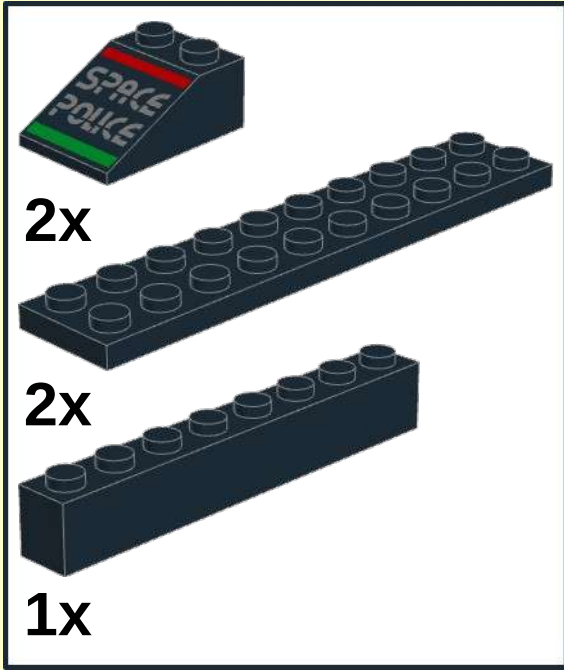

7
4x

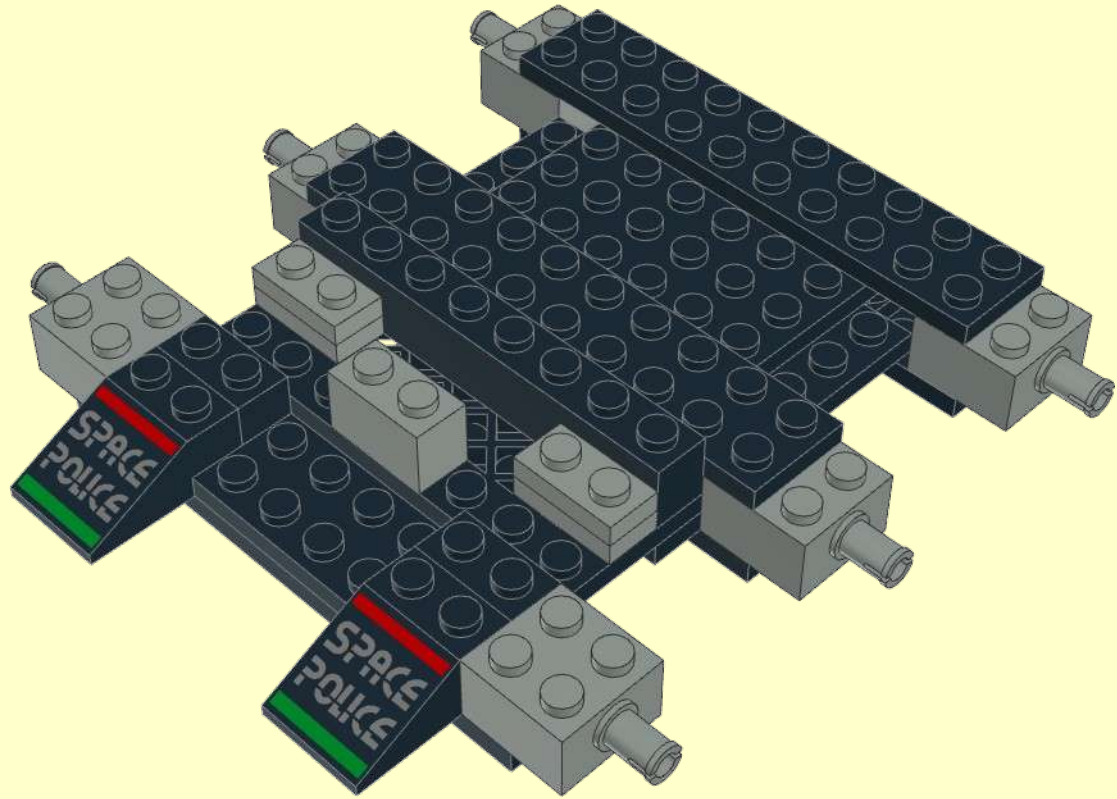

8

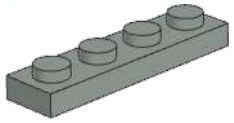

1x

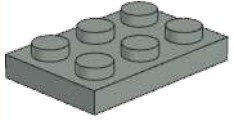

2x



2x

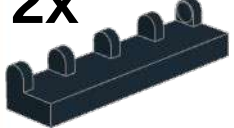

1x

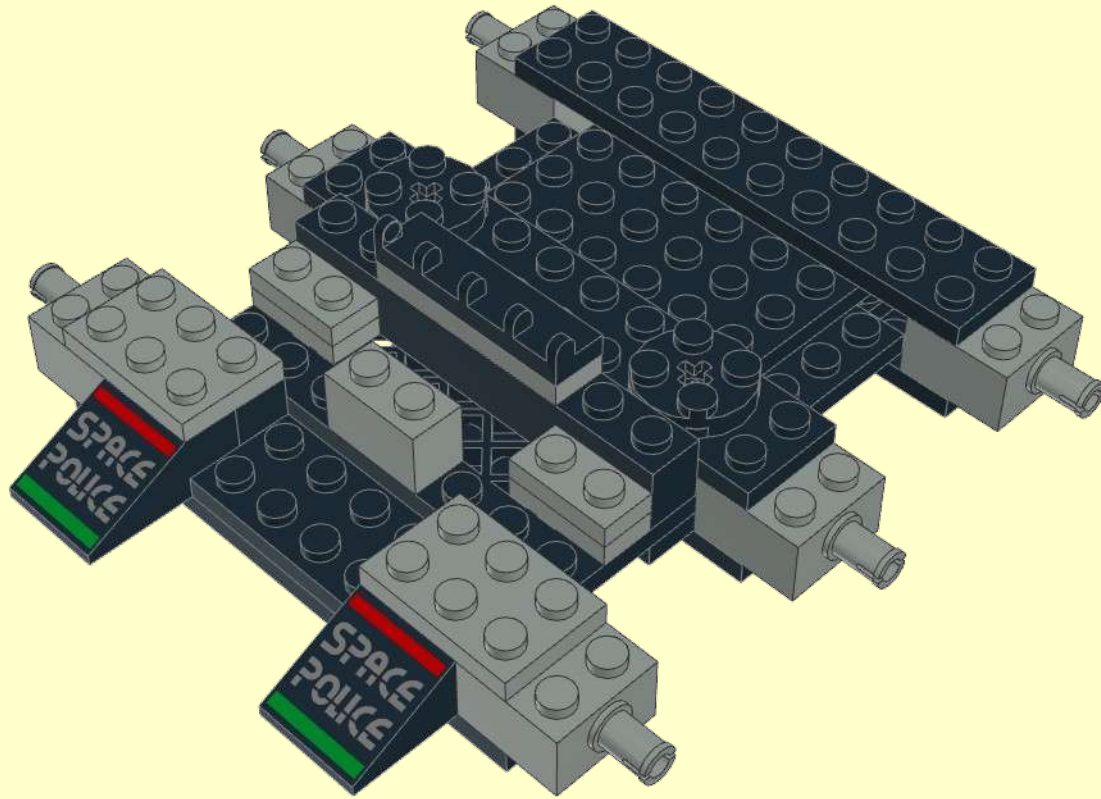

9

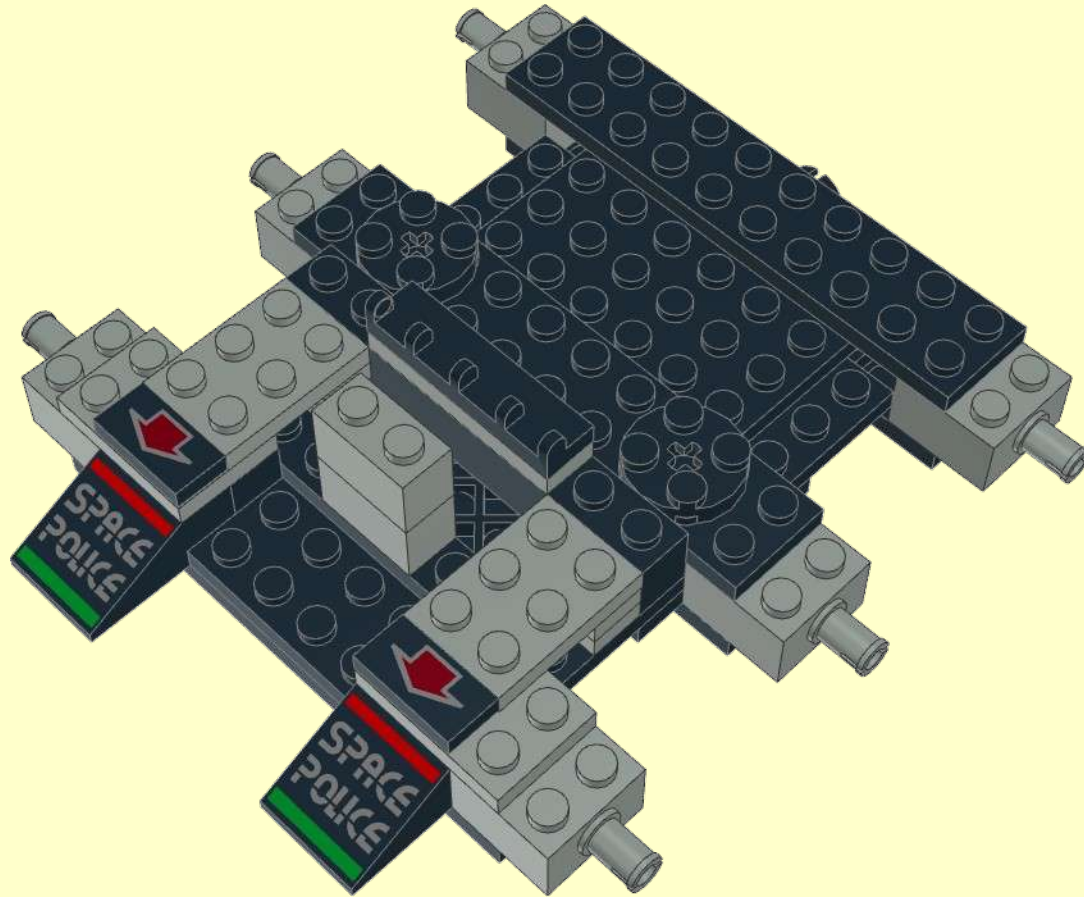
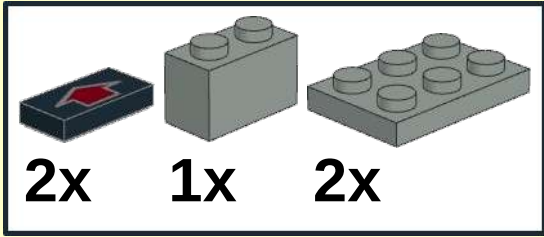

10

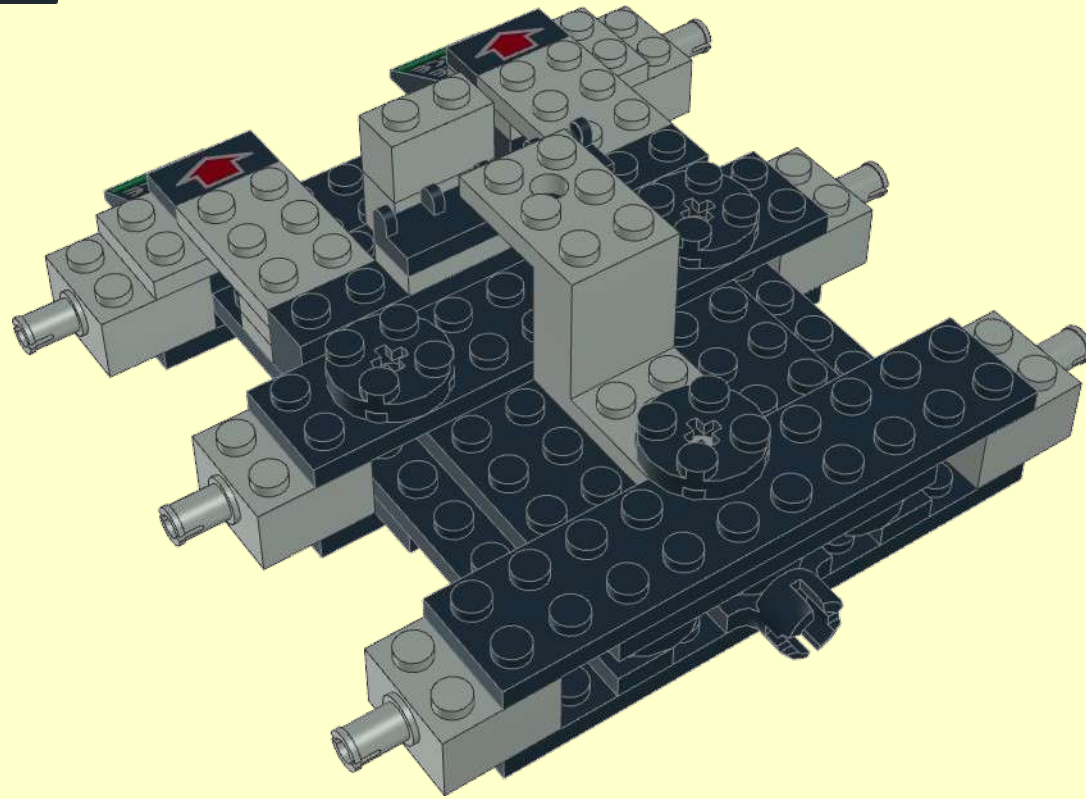
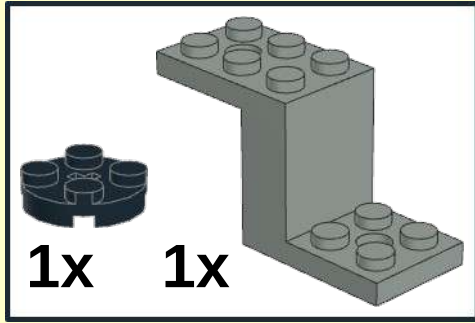

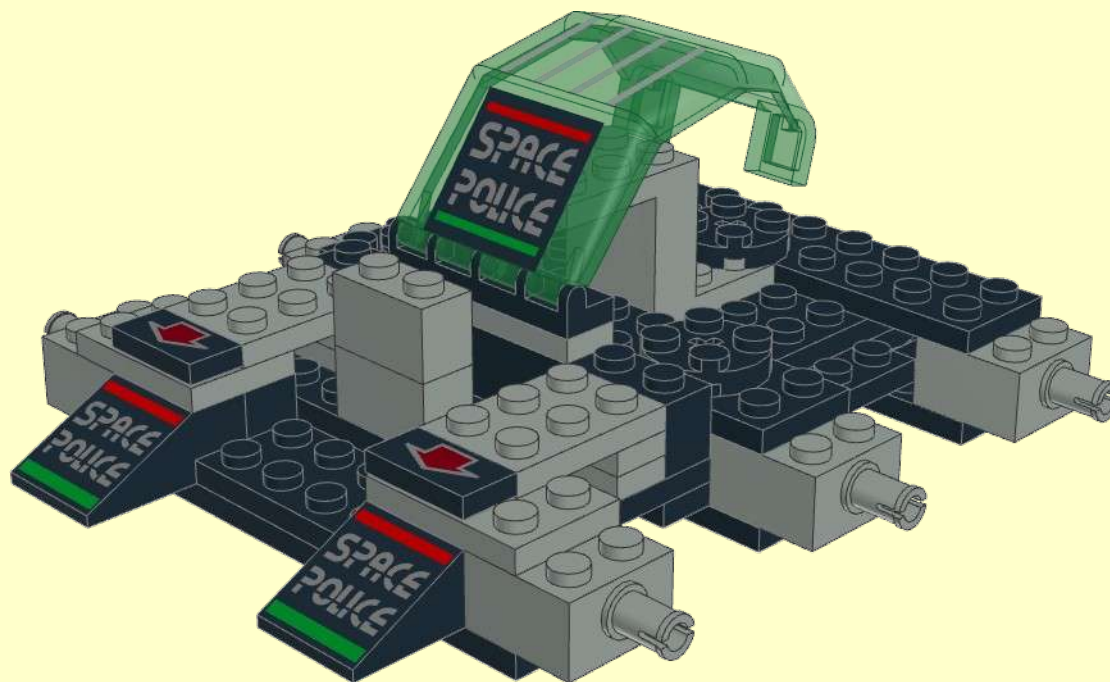

11

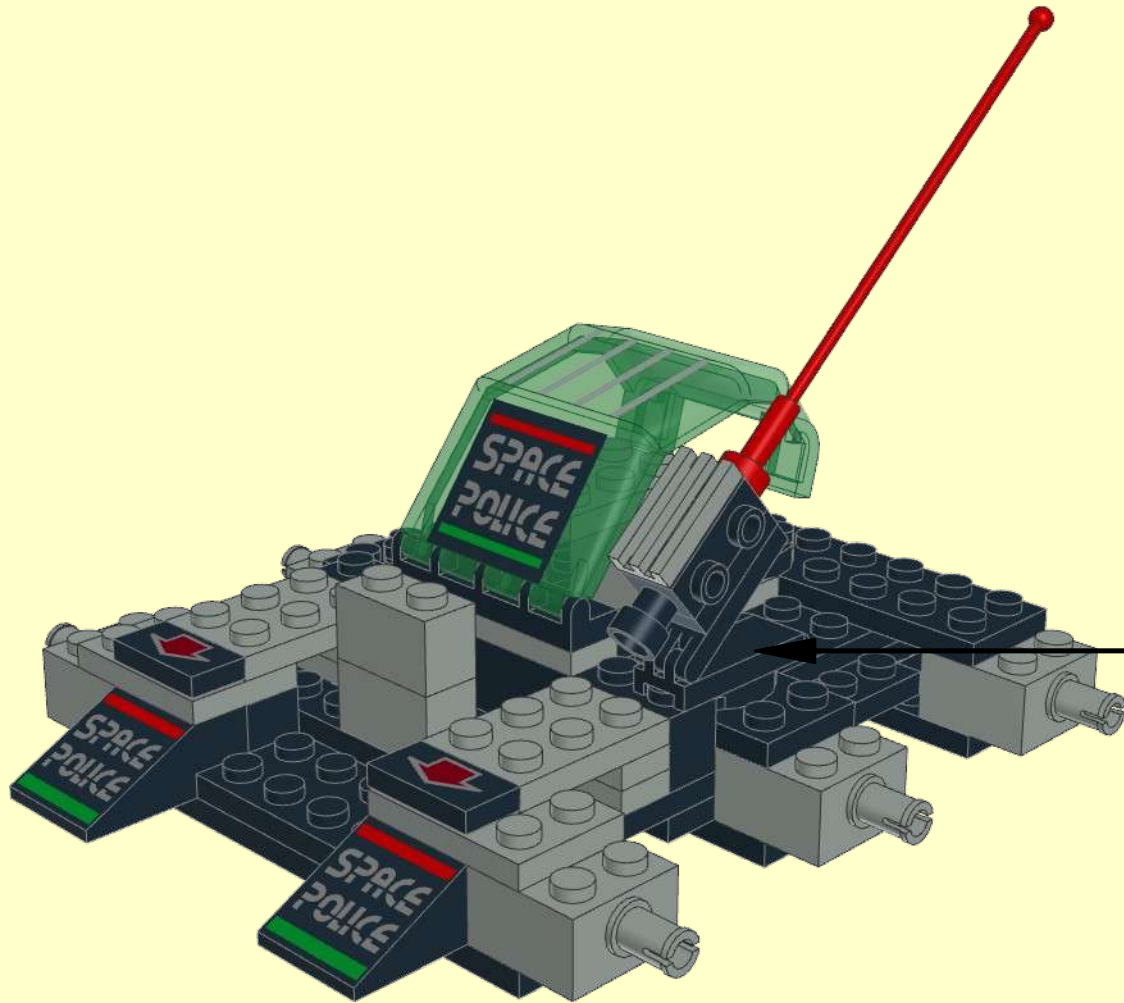



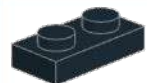

1

-  1x
-  1x
-  1x

2

-  1x
-  1x
-  1x



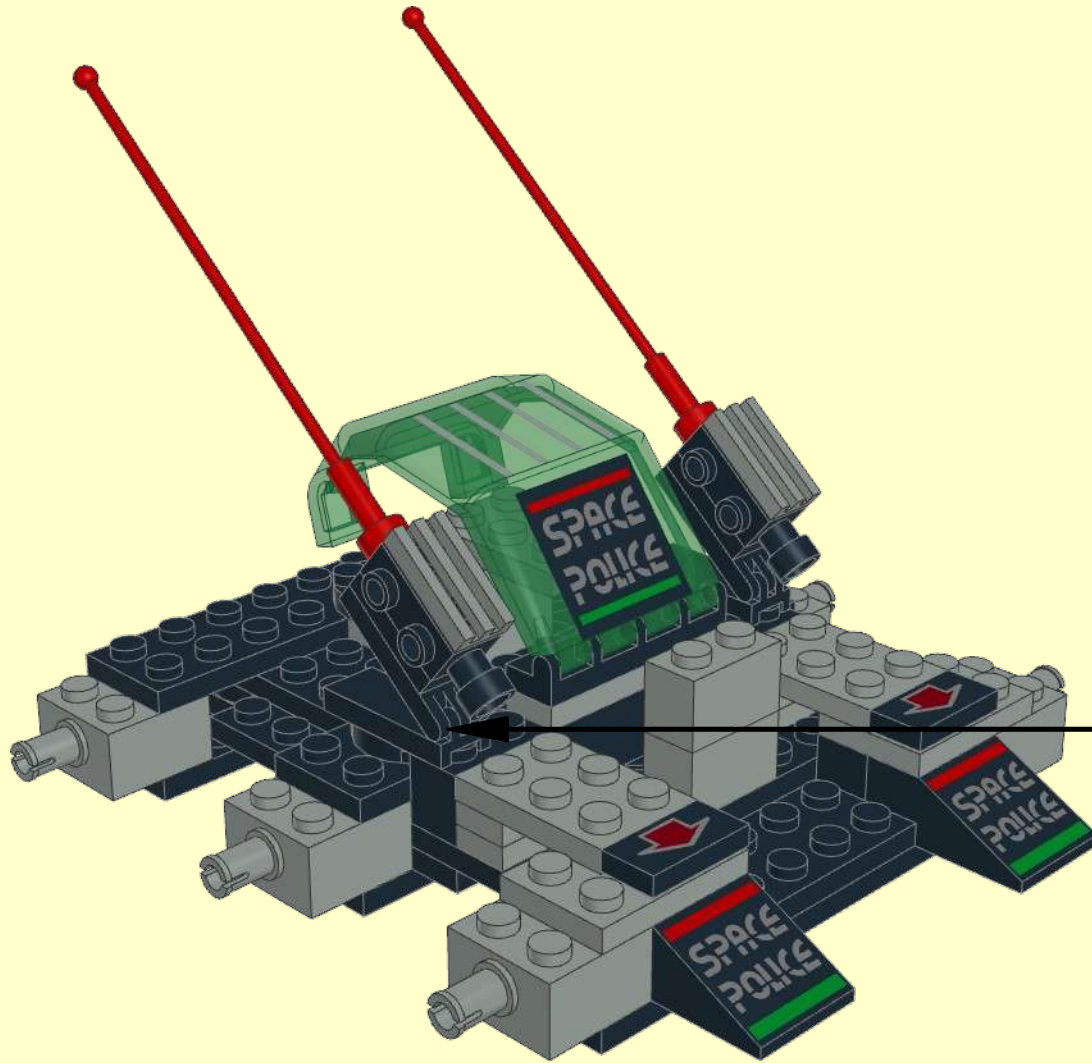

1

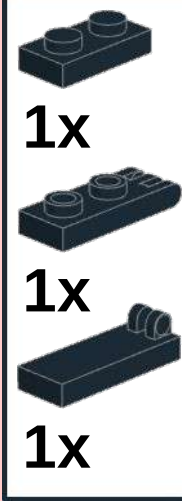

2

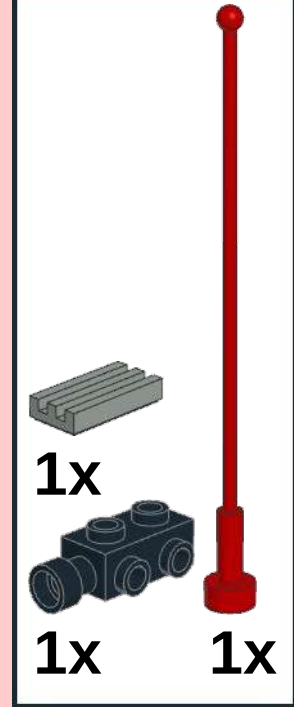

14

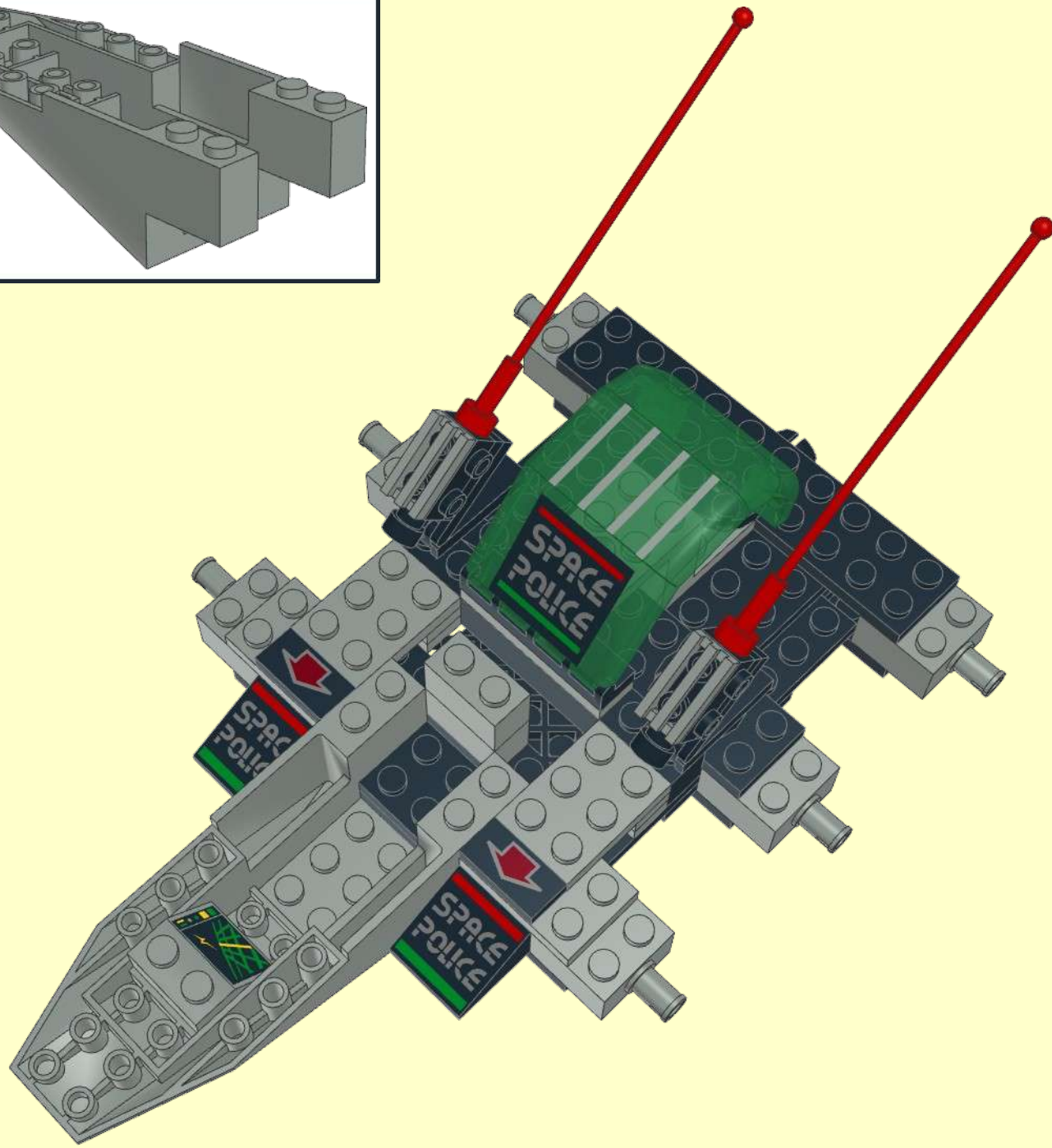
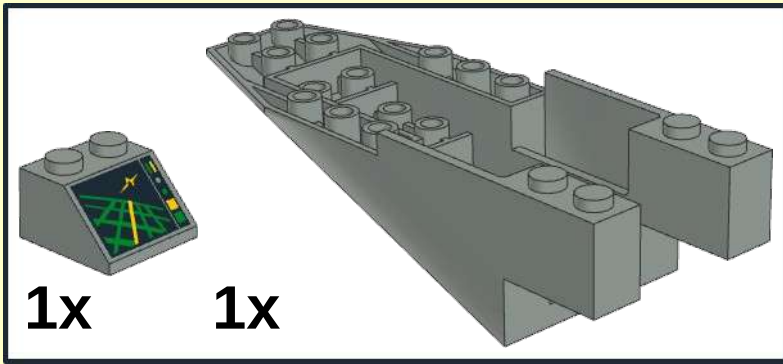

15

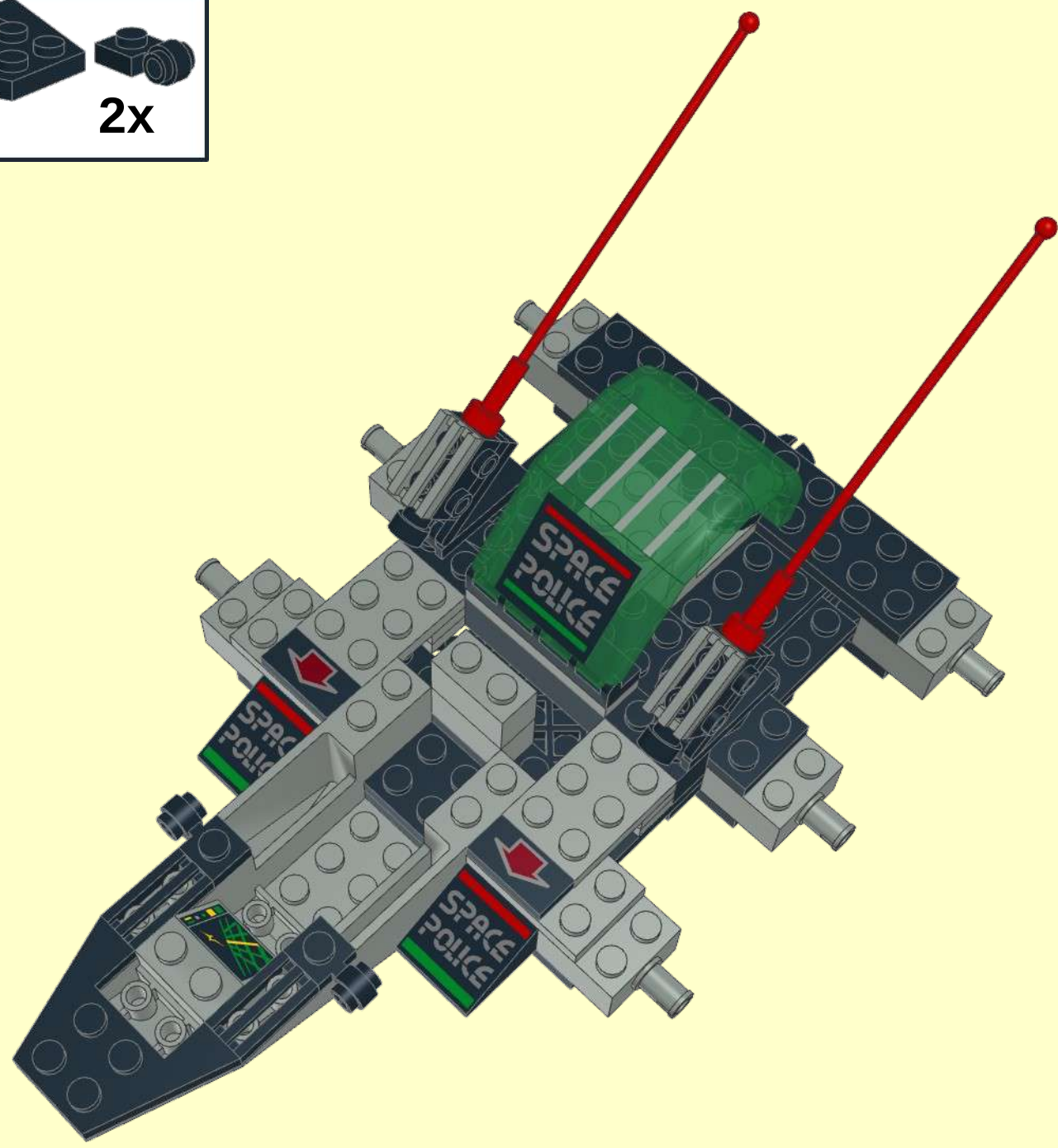
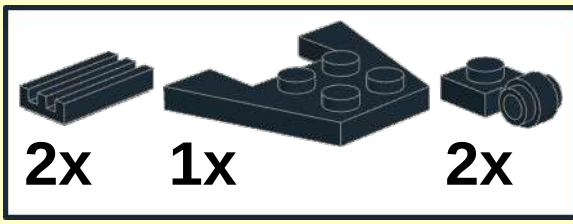

16

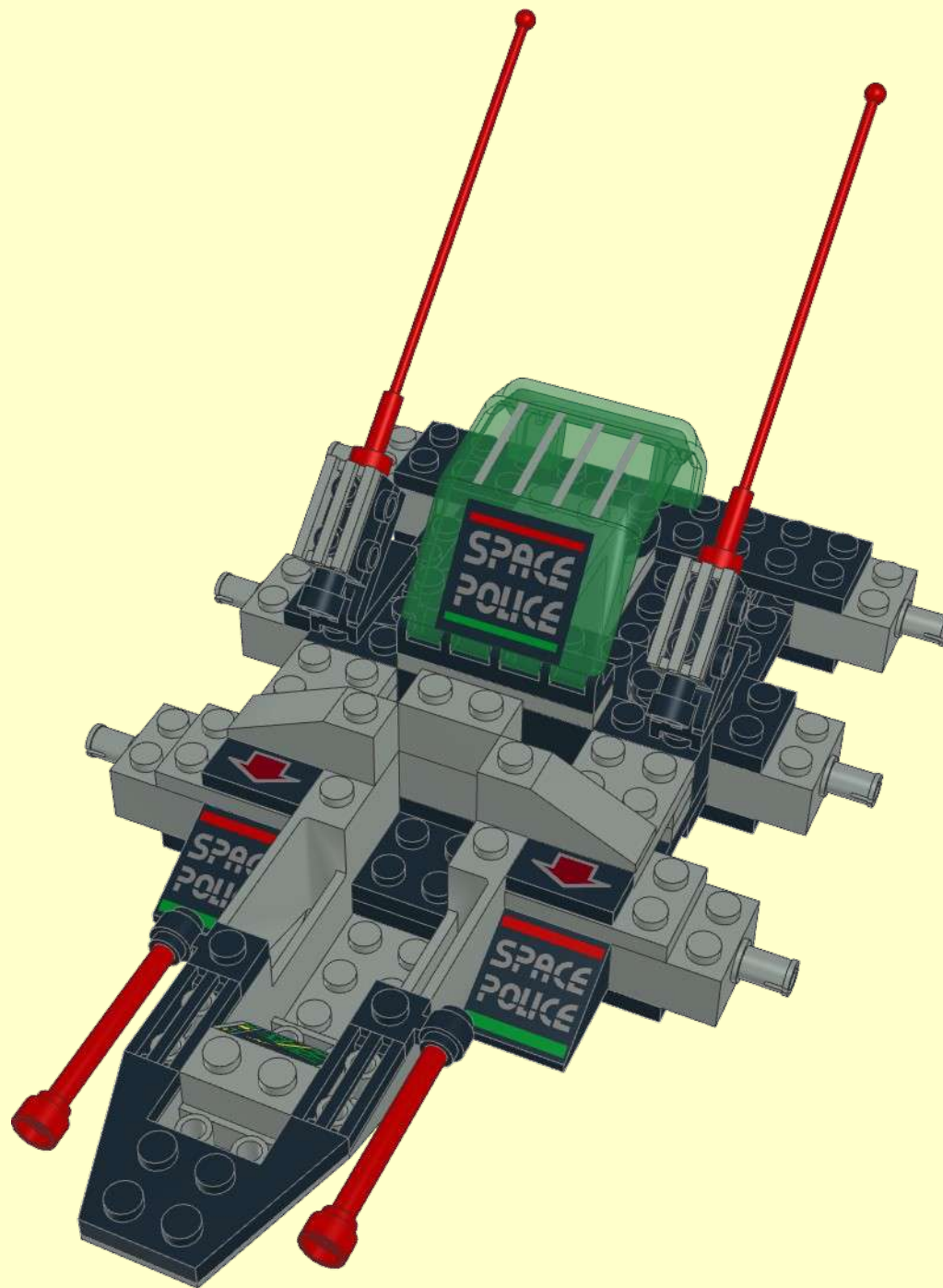
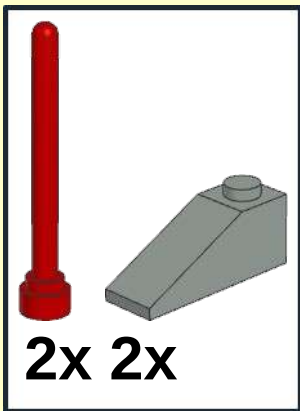

17

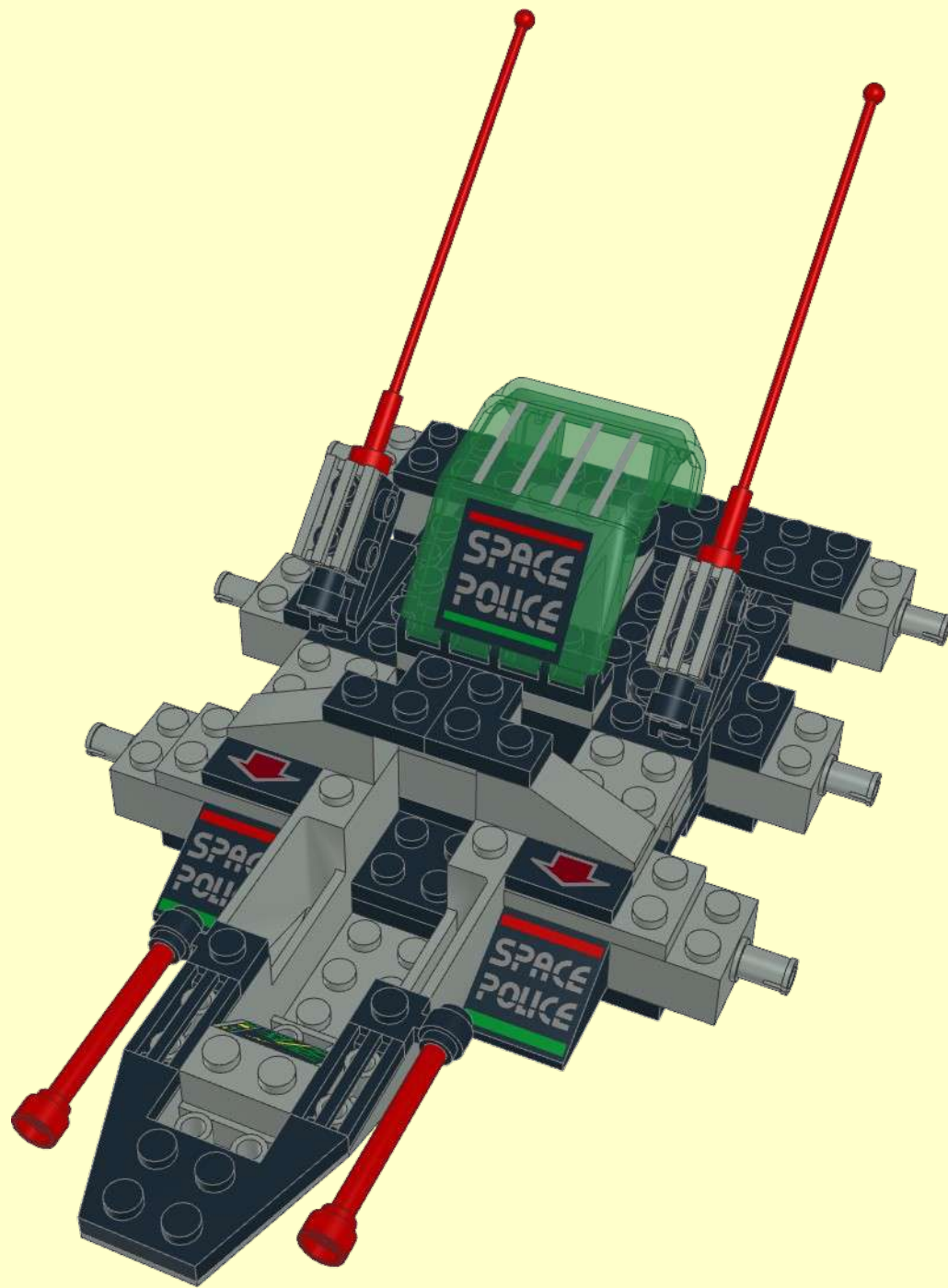
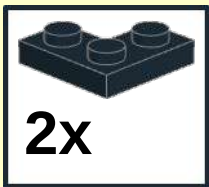

18

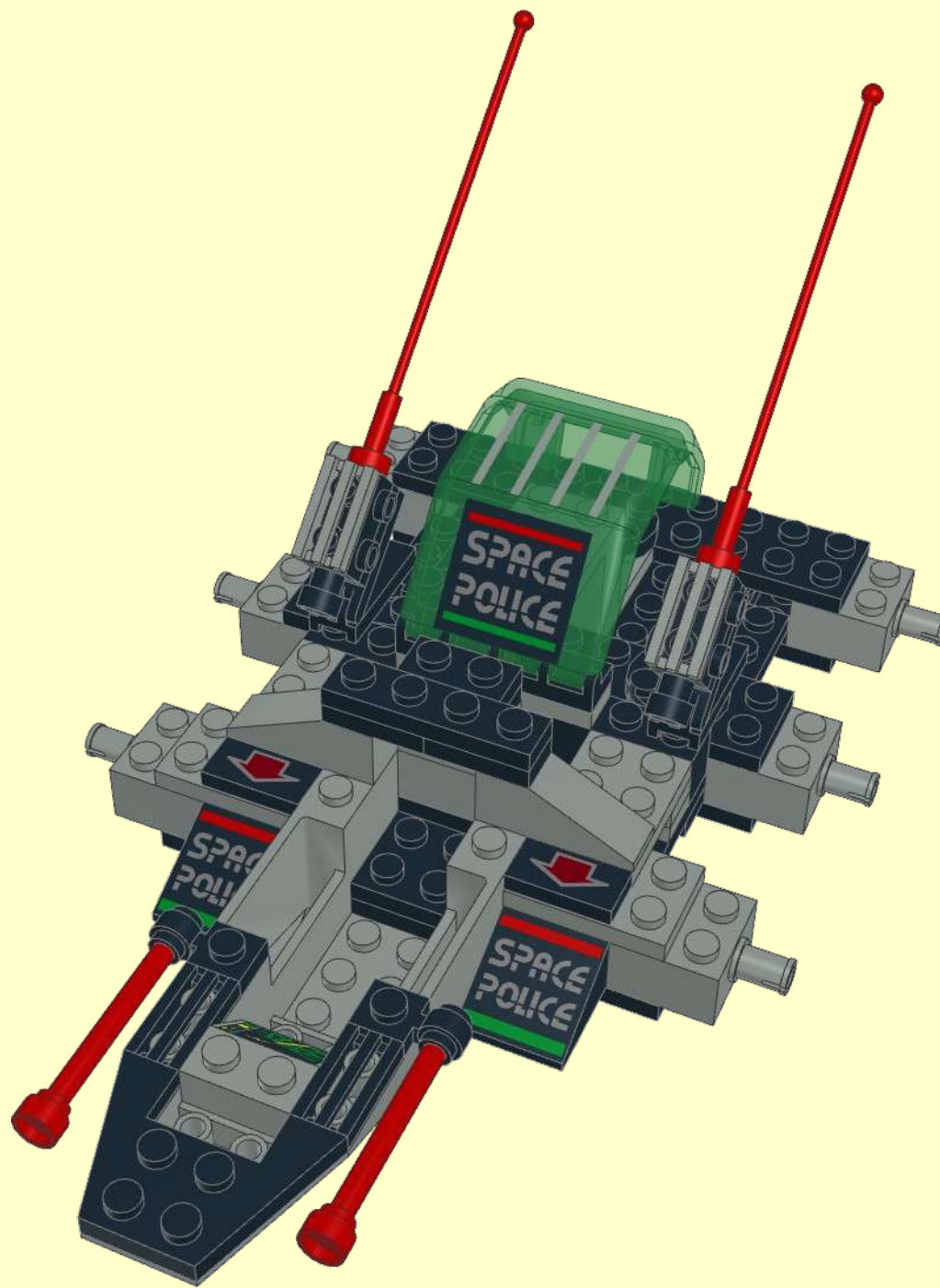
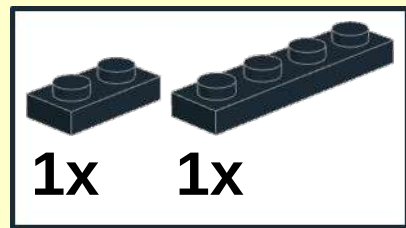

19

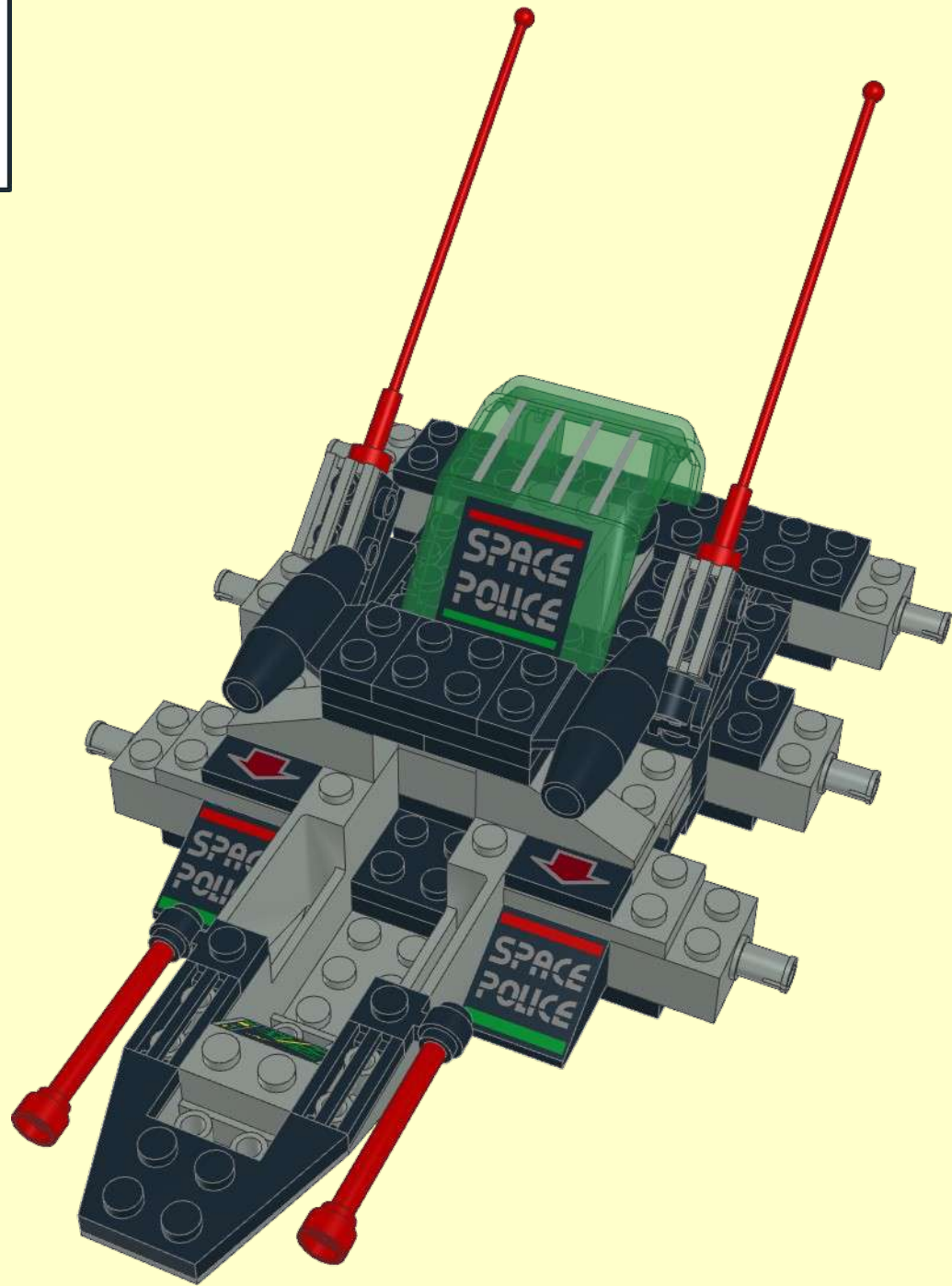
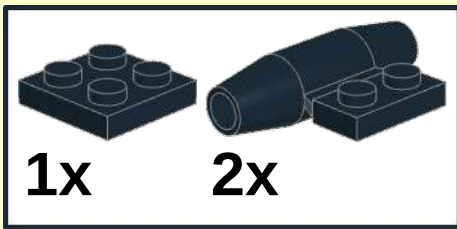

20

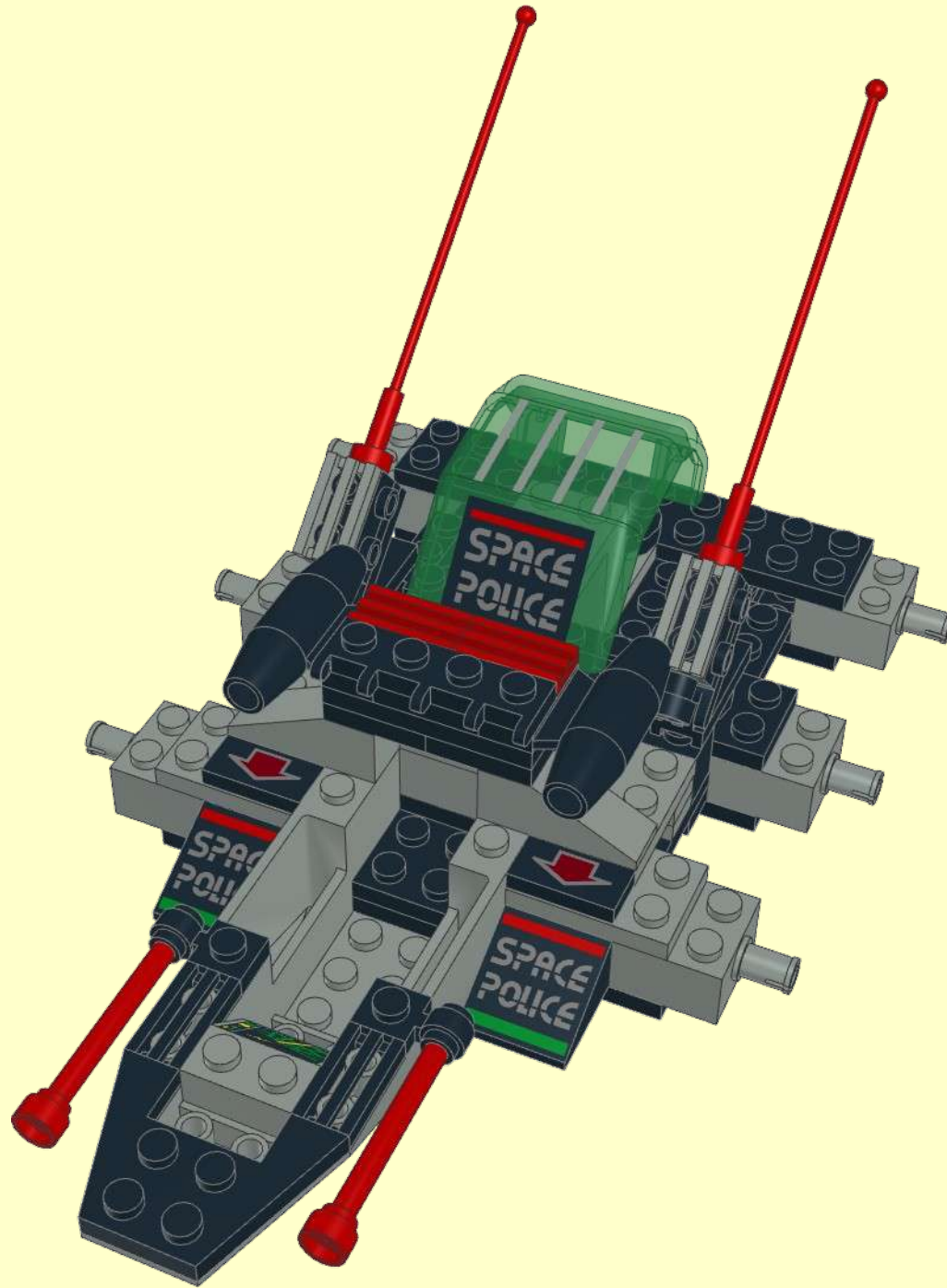
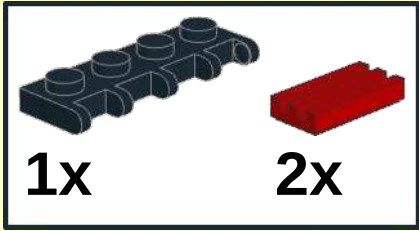

21

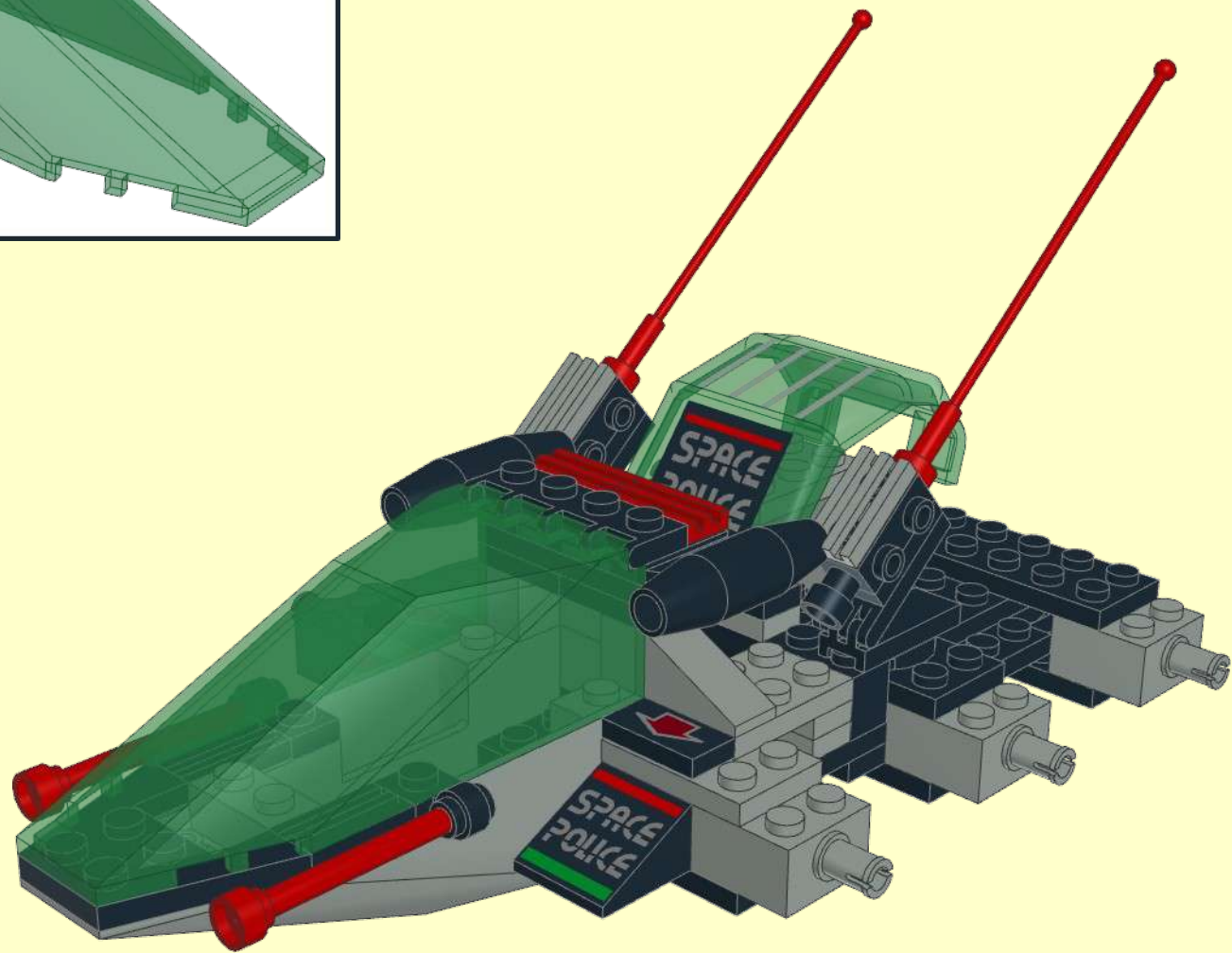
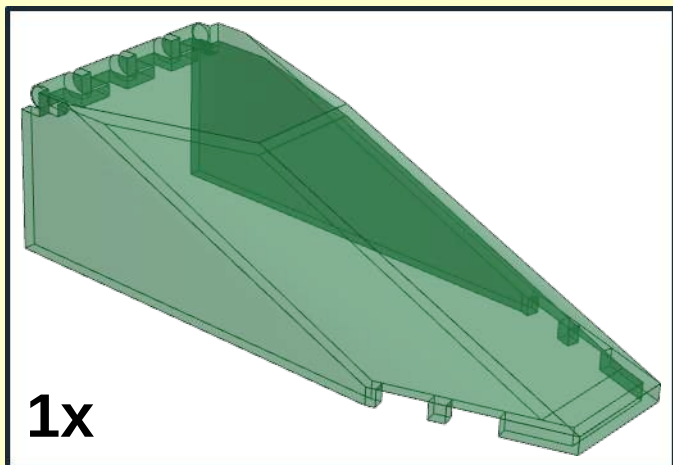

22

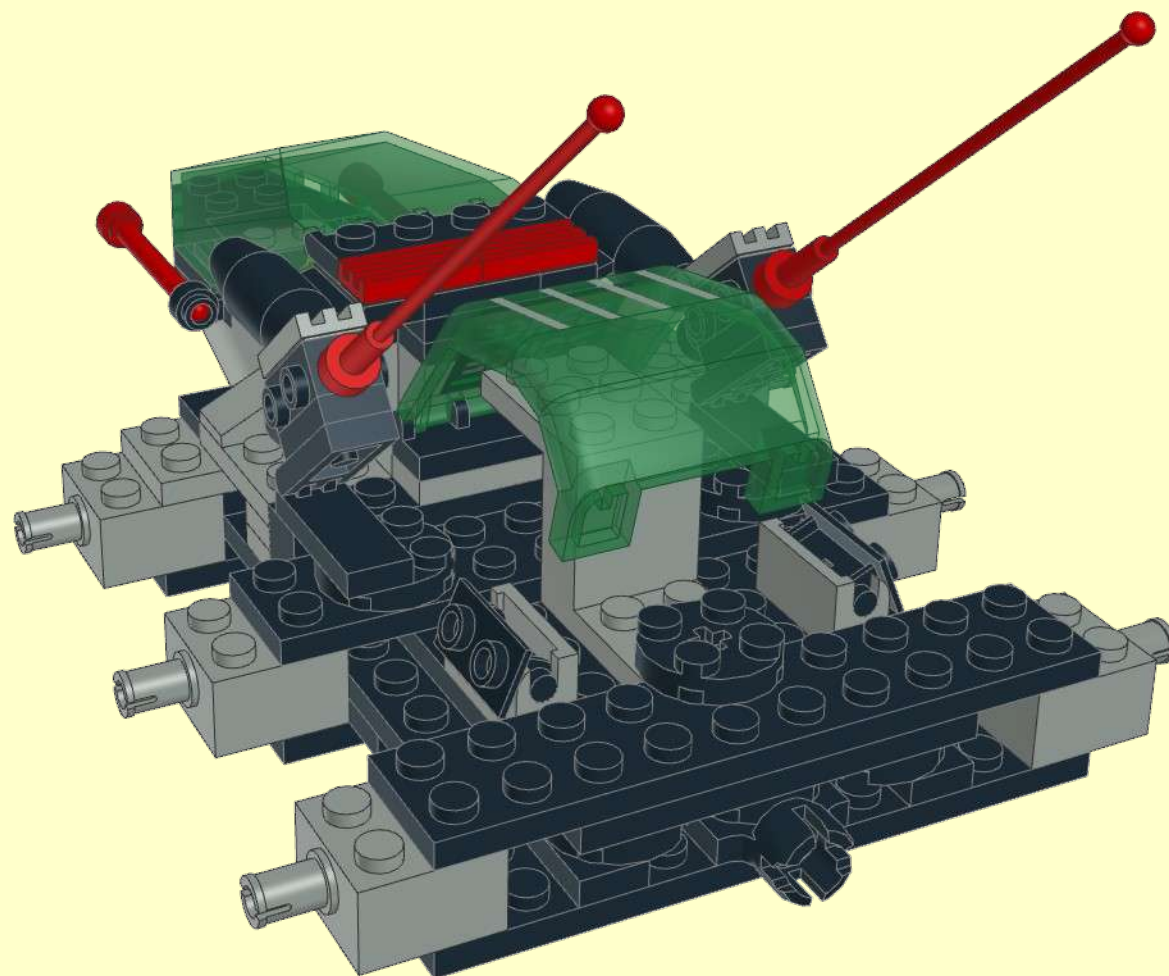
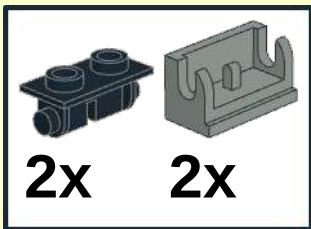

23

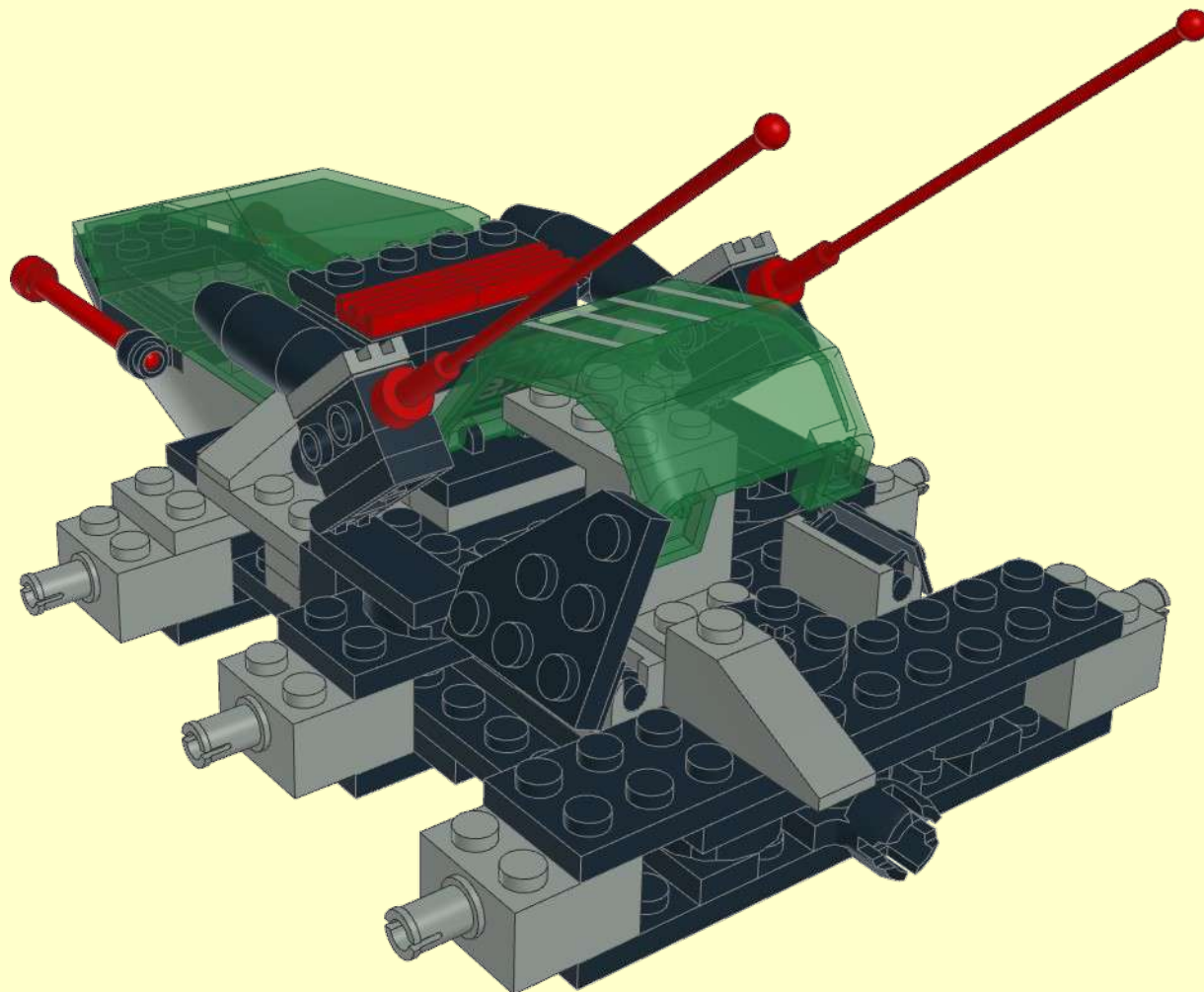
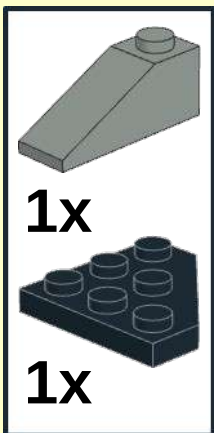

24

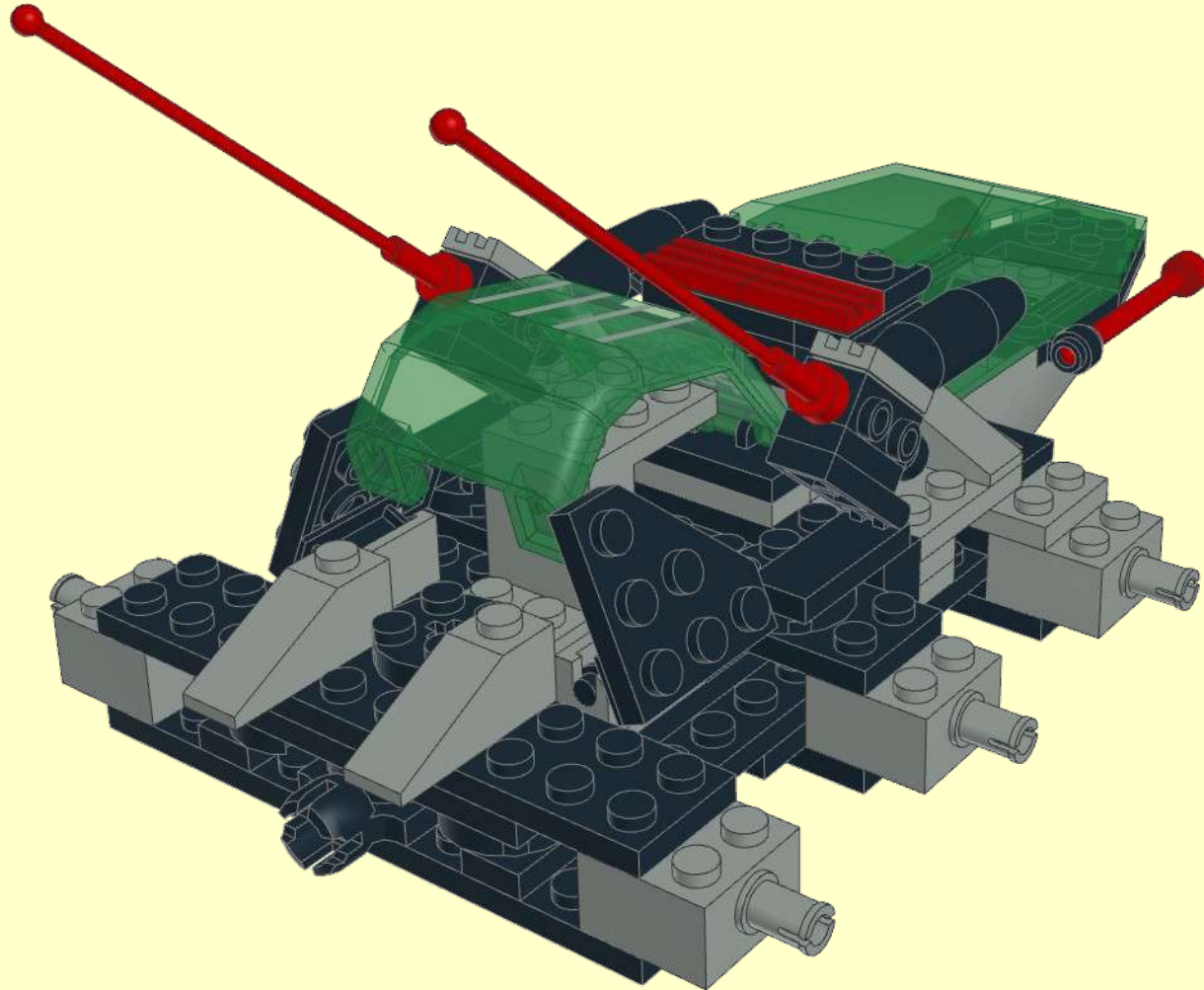
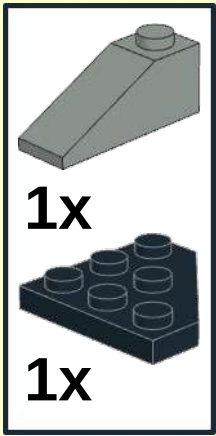

25

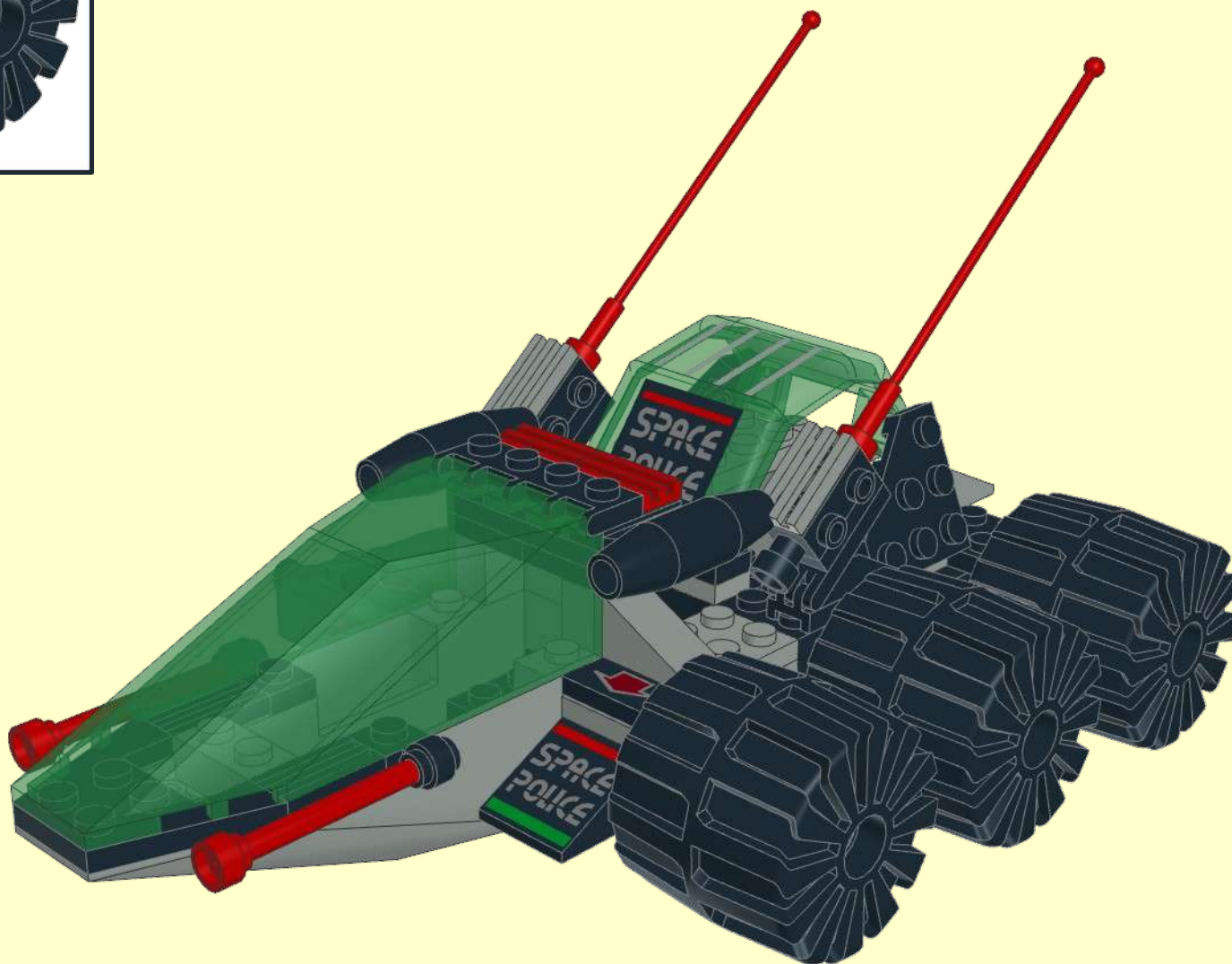

26

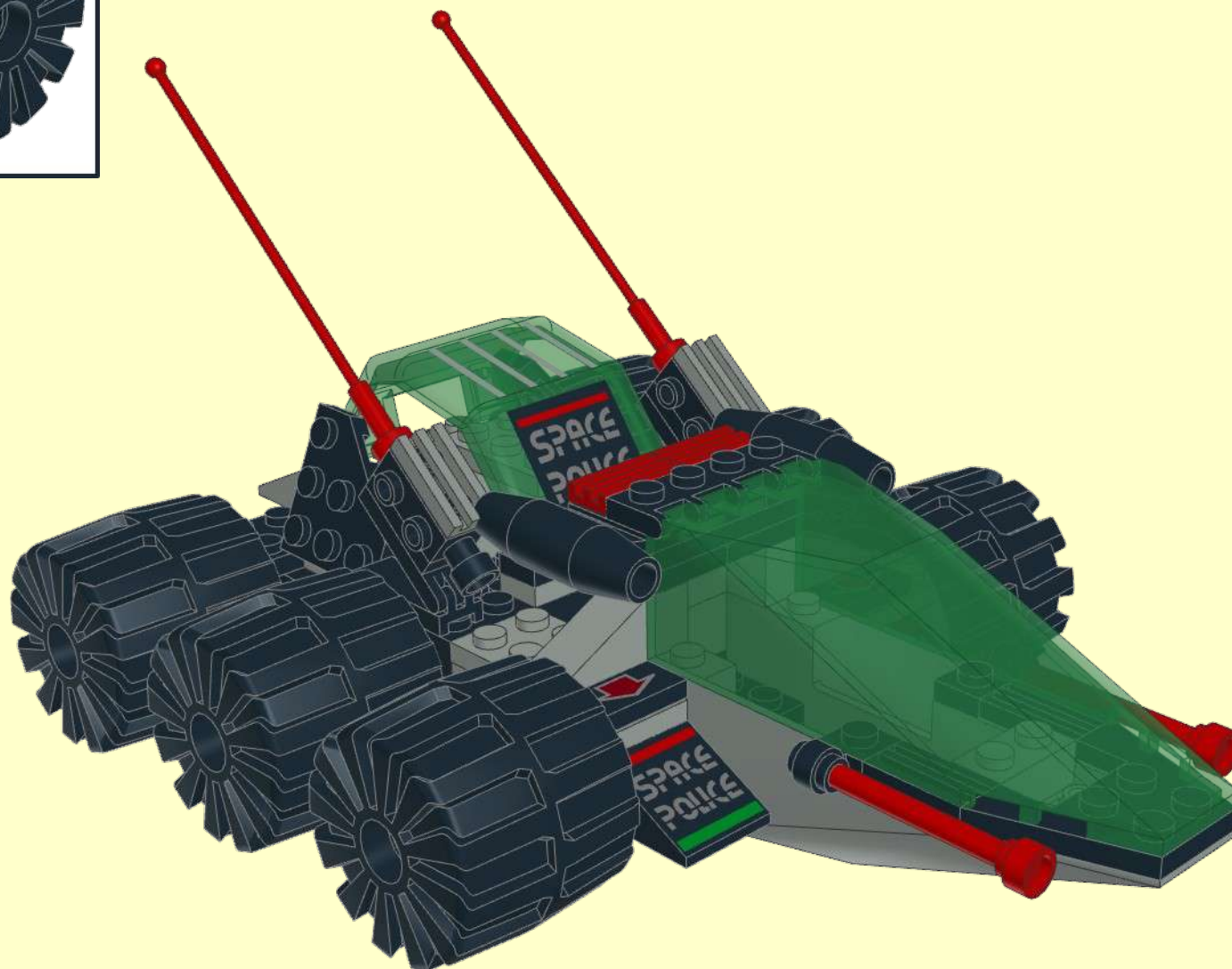

3

