

1

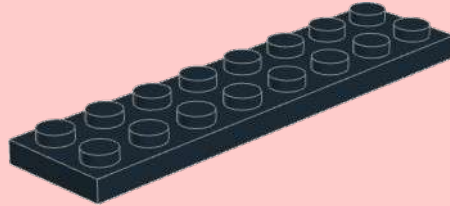

2

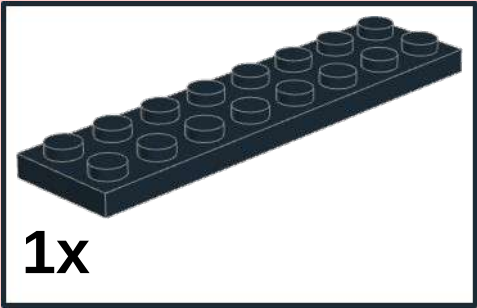
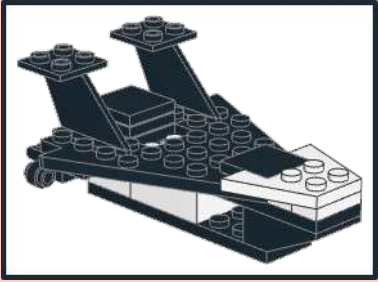
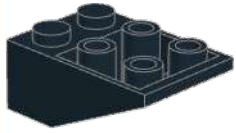

1x

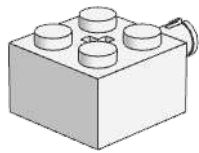

1x

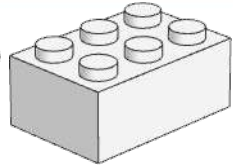

1x

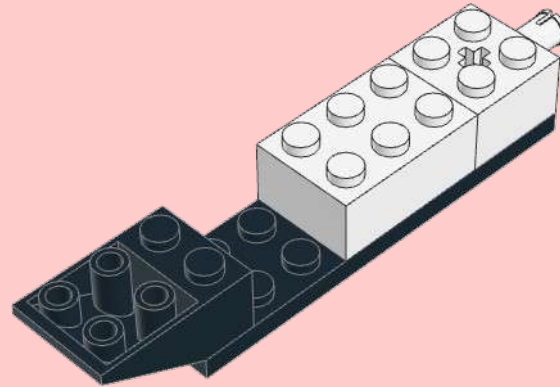

3

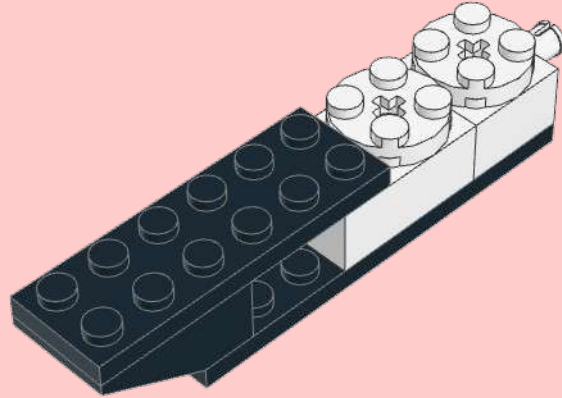
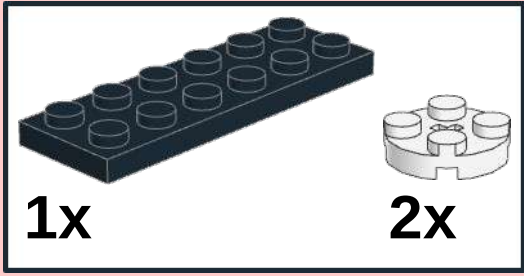

4

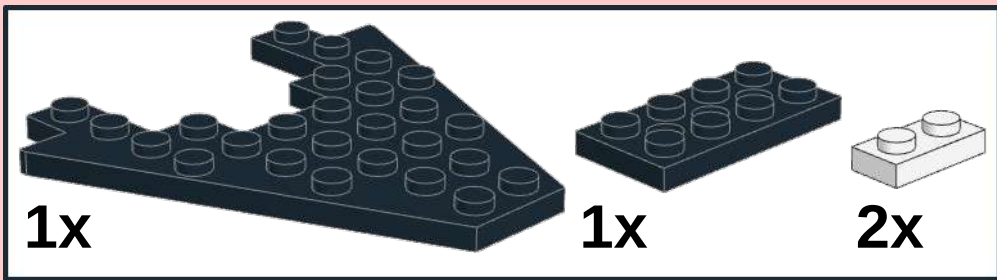

5

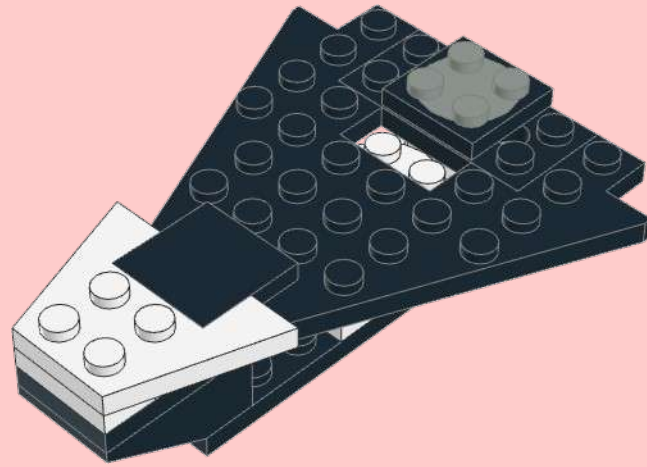
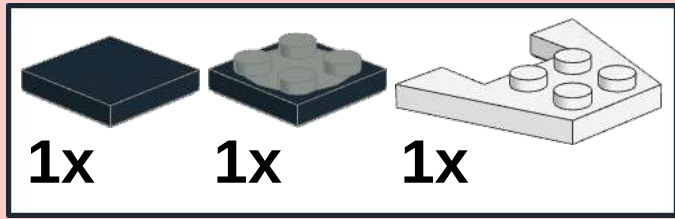

6

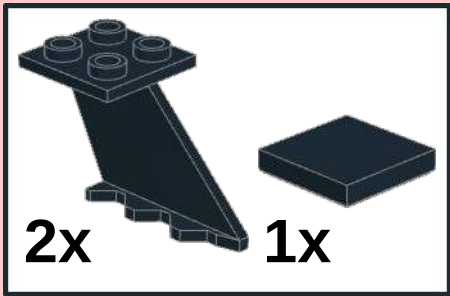

7



2x



2x

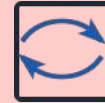
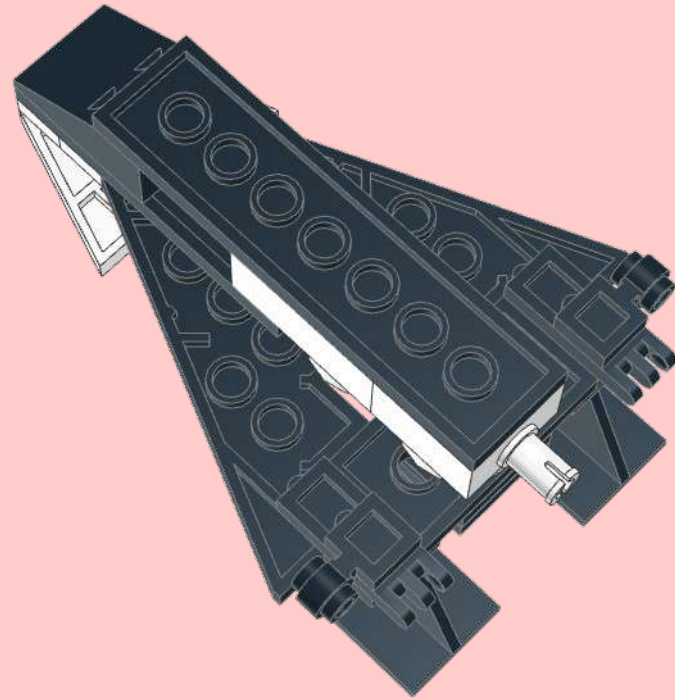

1

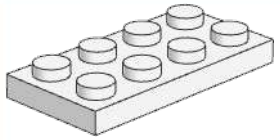
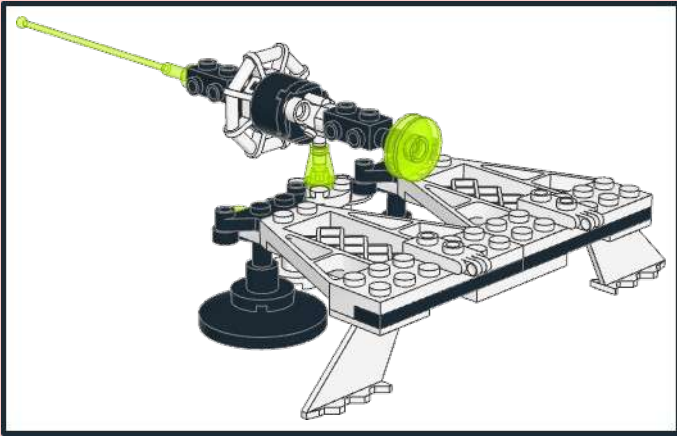

1x



2x



2

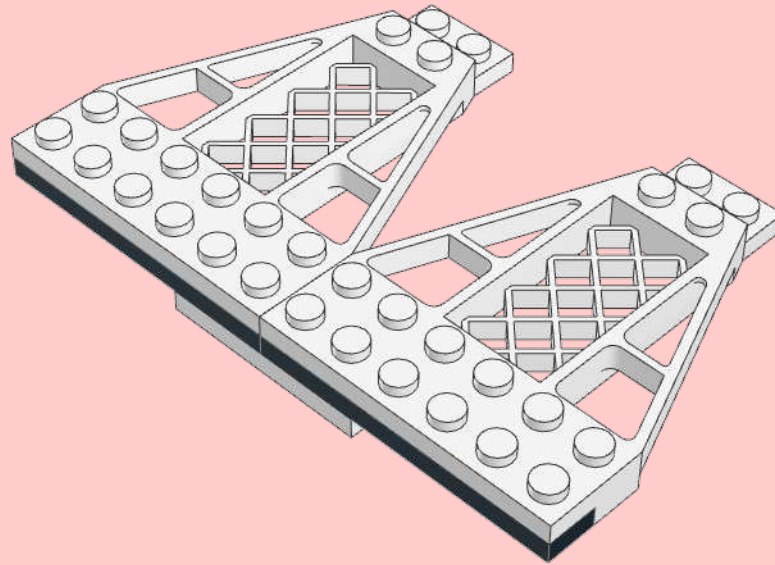
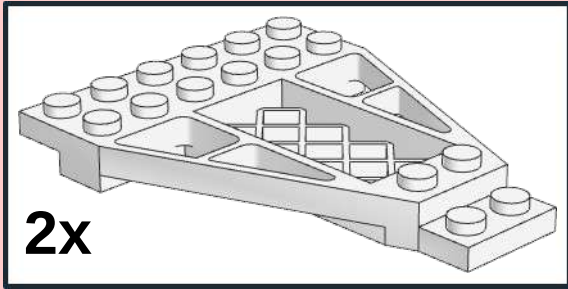

3

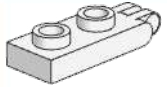

2x



2x

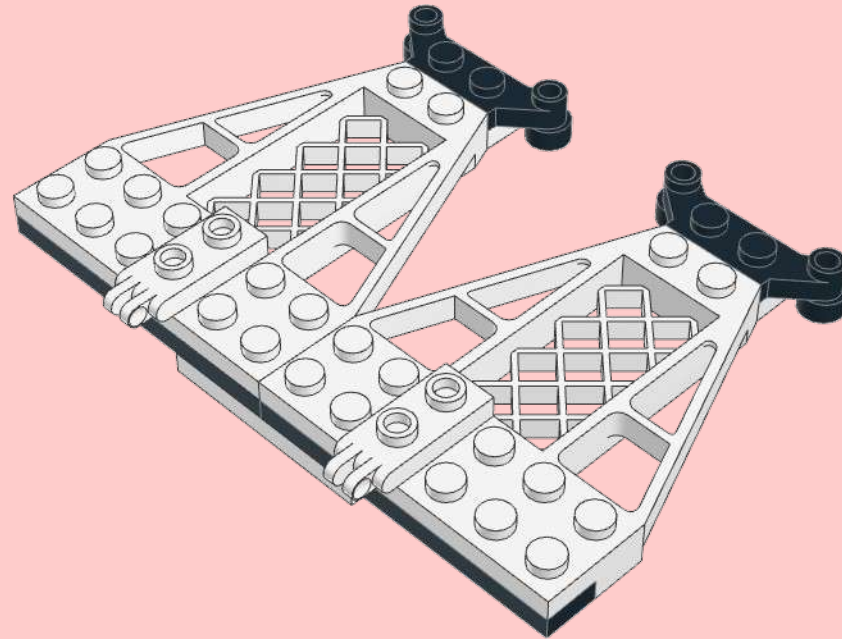



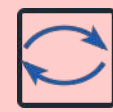
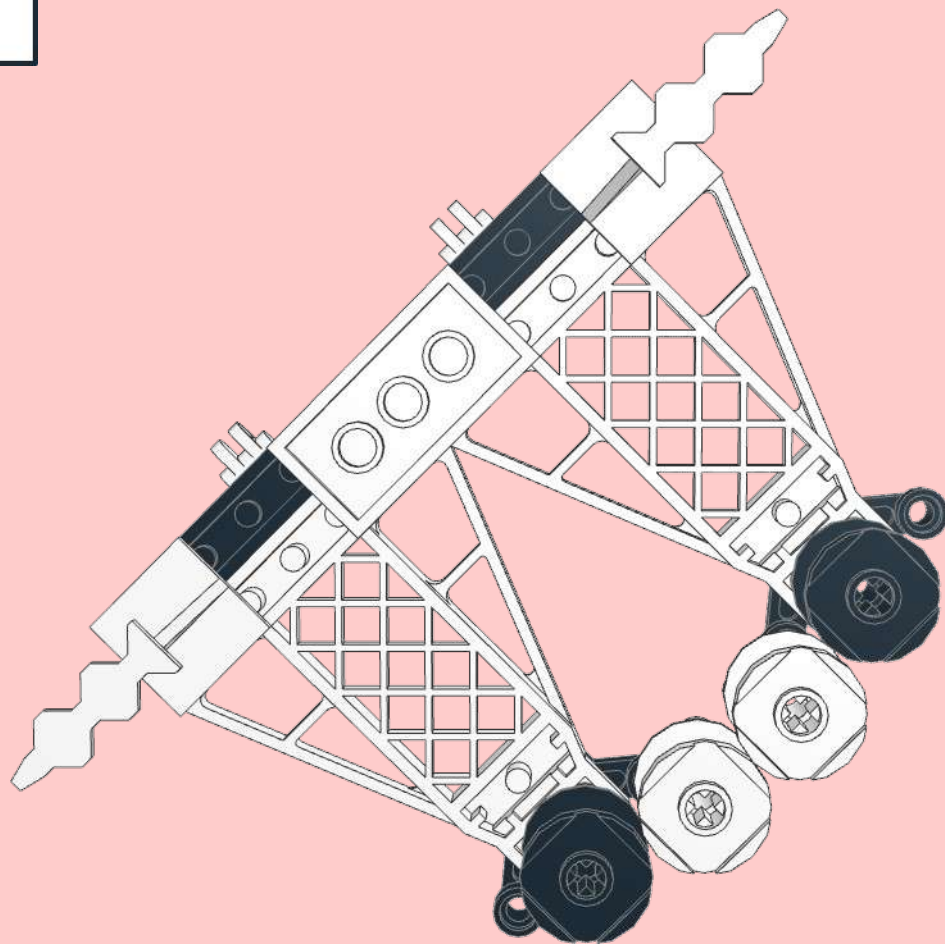
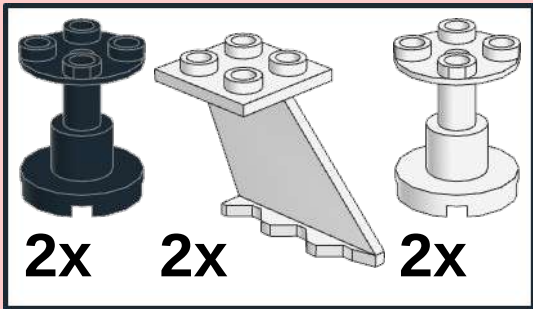

4

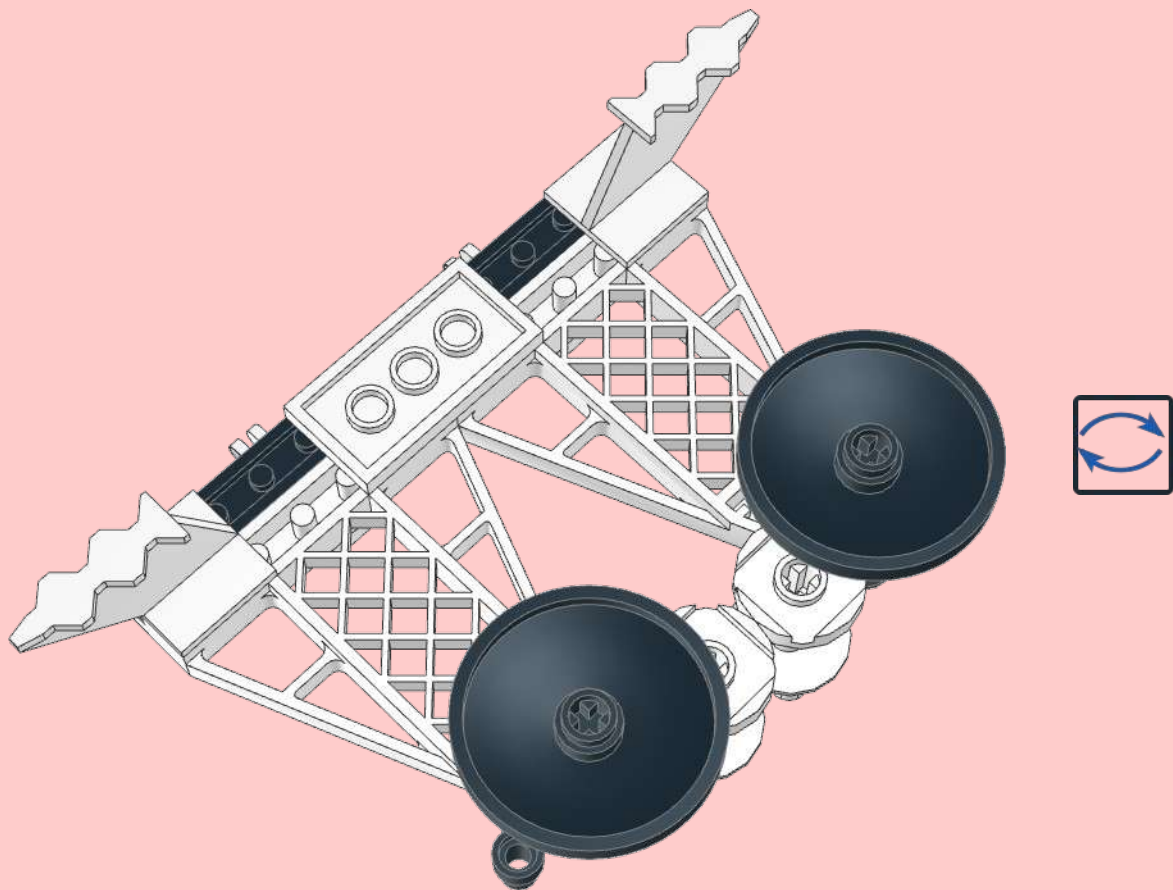

5

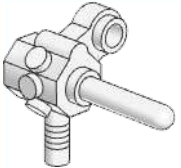

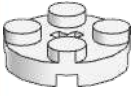
6

	
1x	2x
	
1x	1x

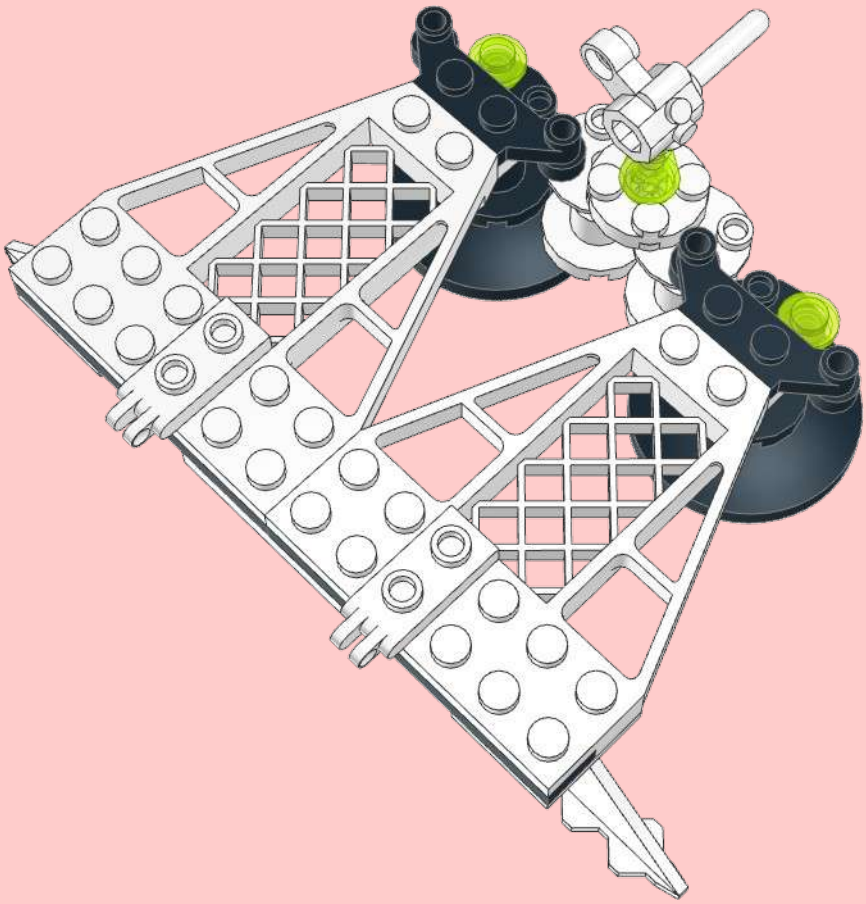

7



2x



1x

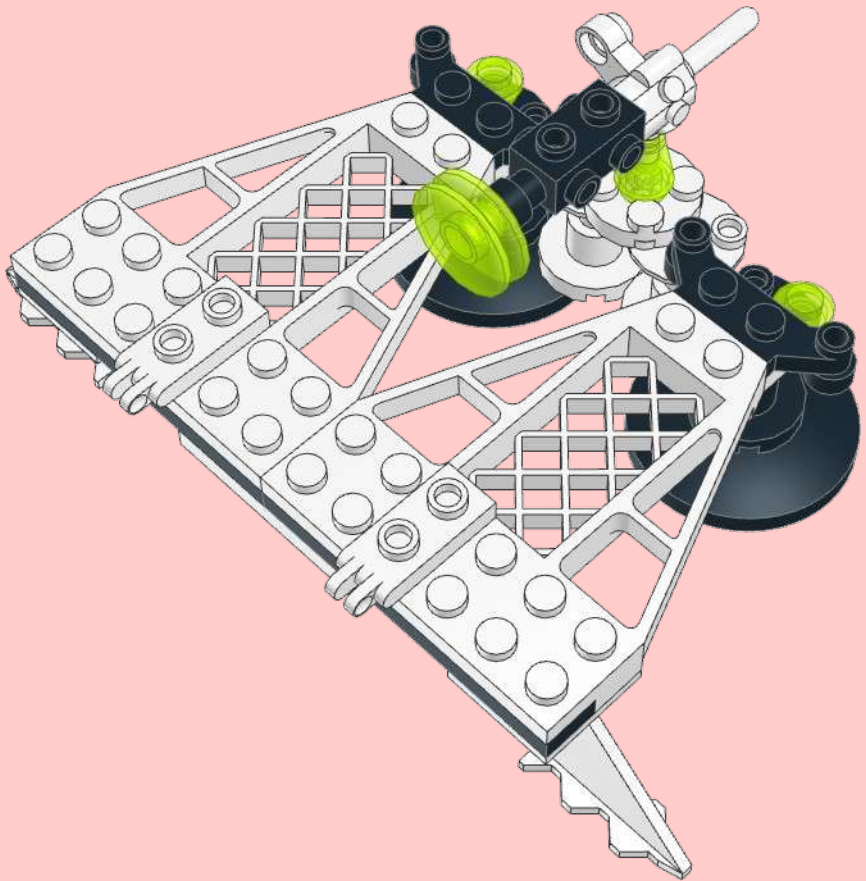

8

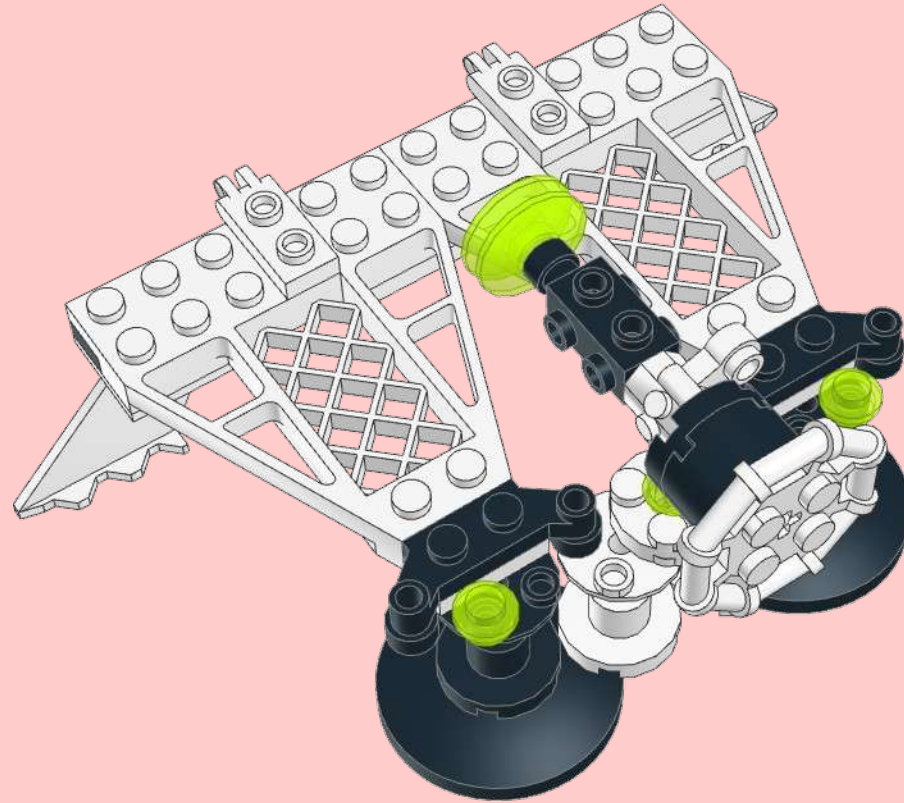
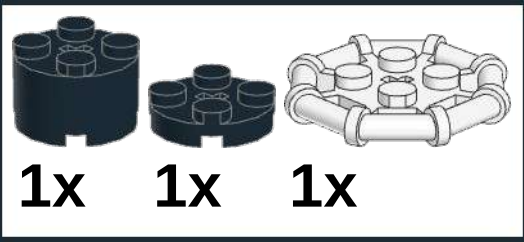

9

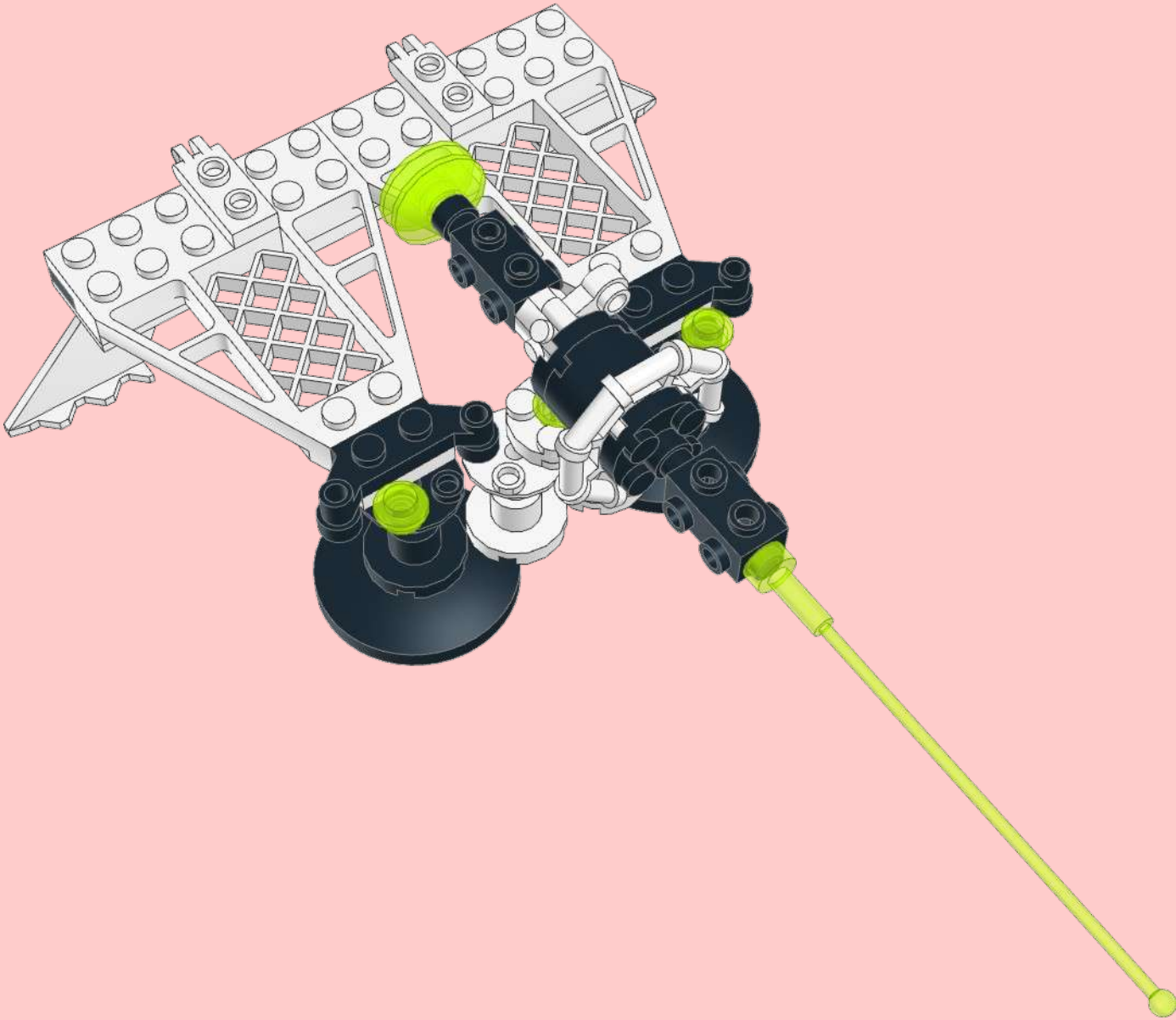
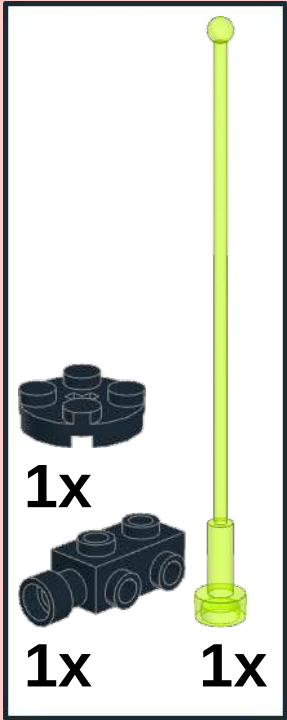

2

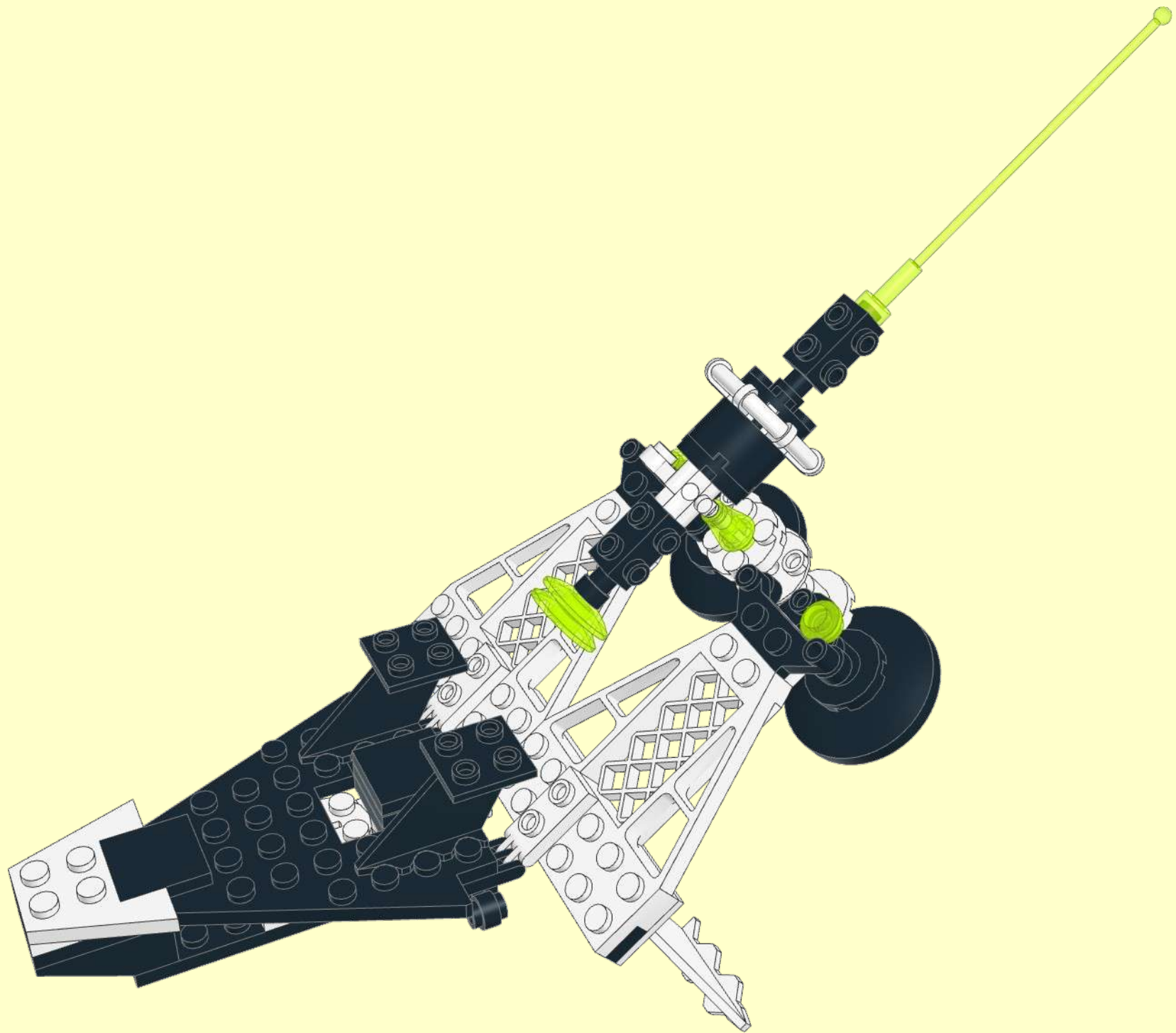

2

