

1

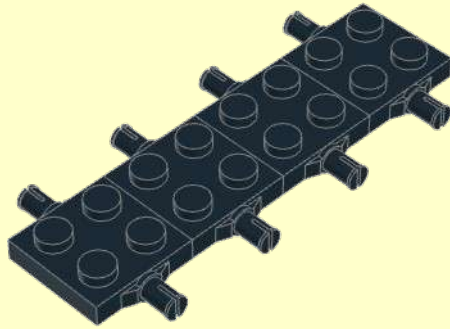

2

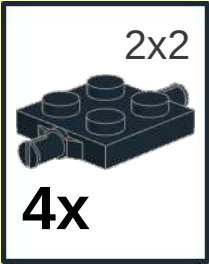
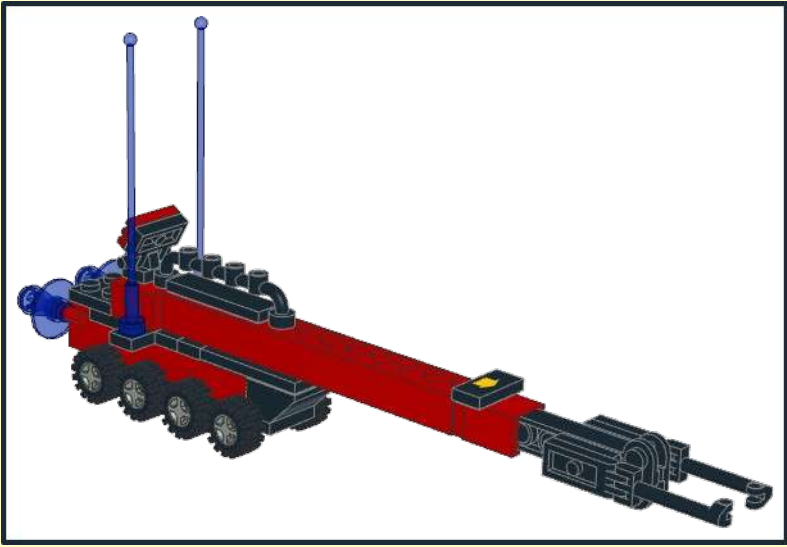
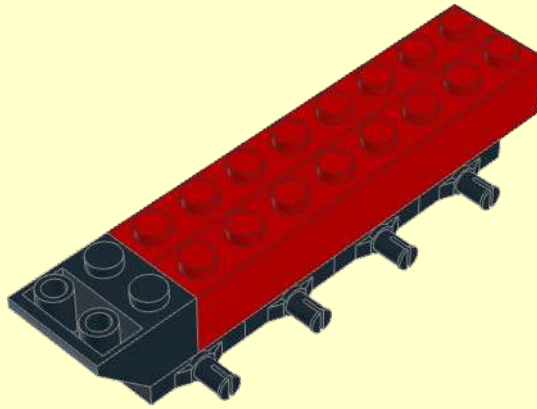
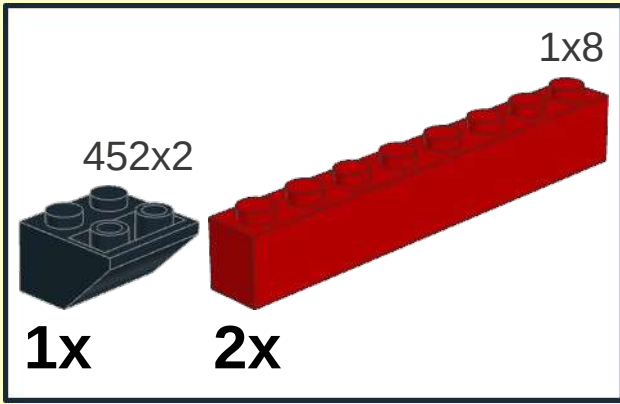

3

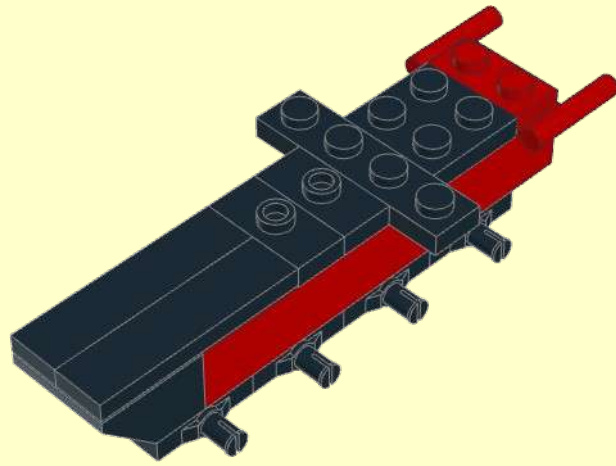
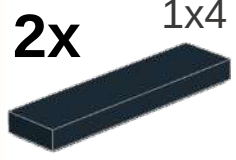
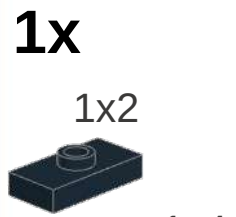
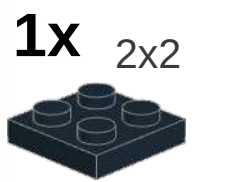
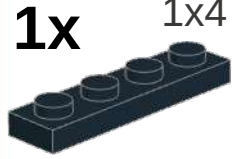
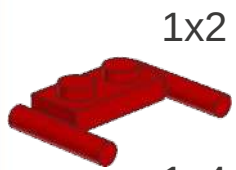

4

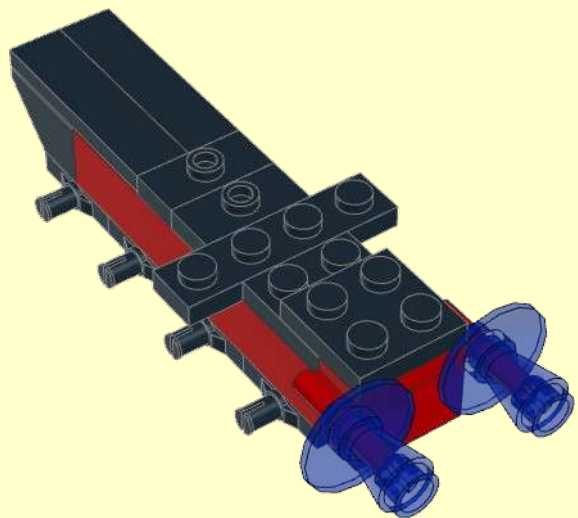

5

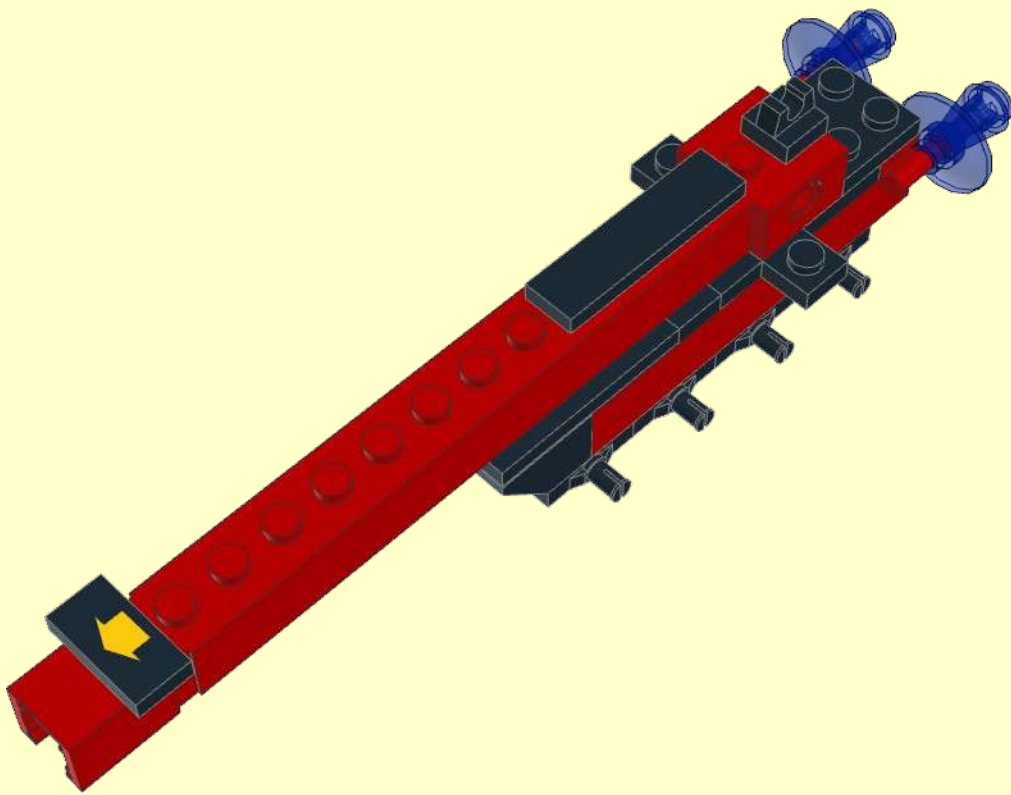
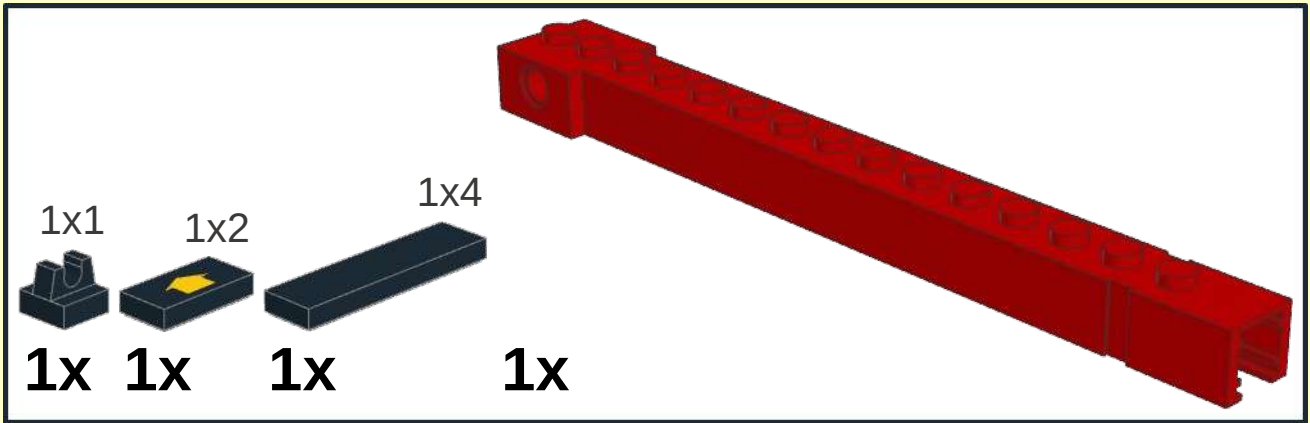

6

1x2





1x 1x2



1x 1x6

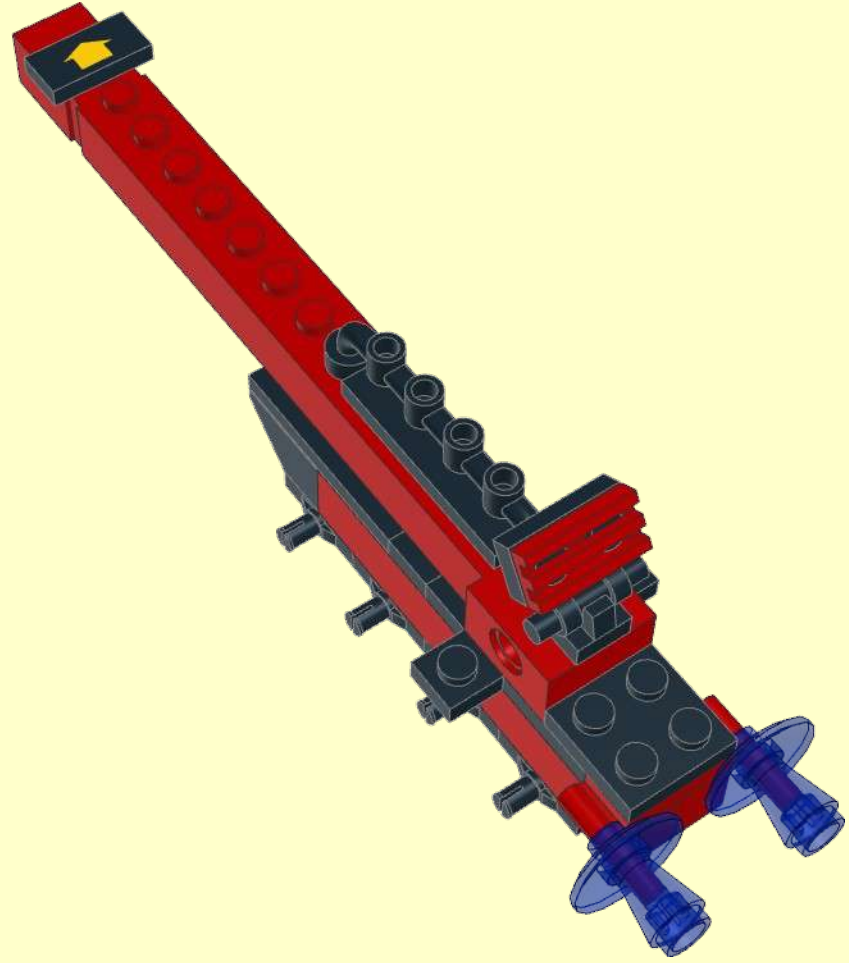

1x



1

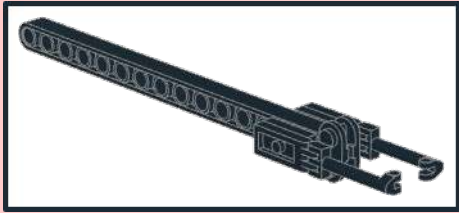

2

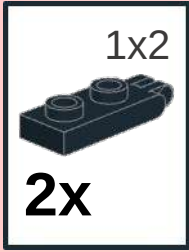

3



7

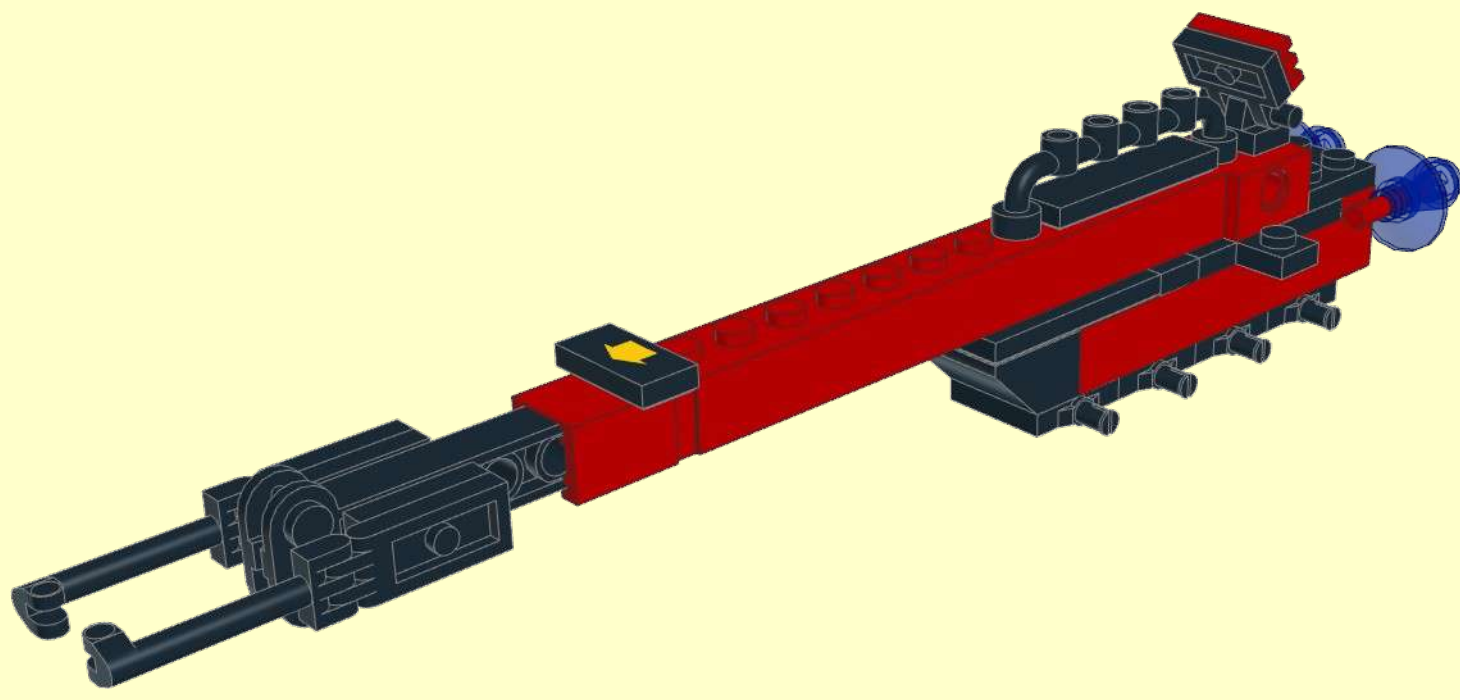

8

6.4x8



4x

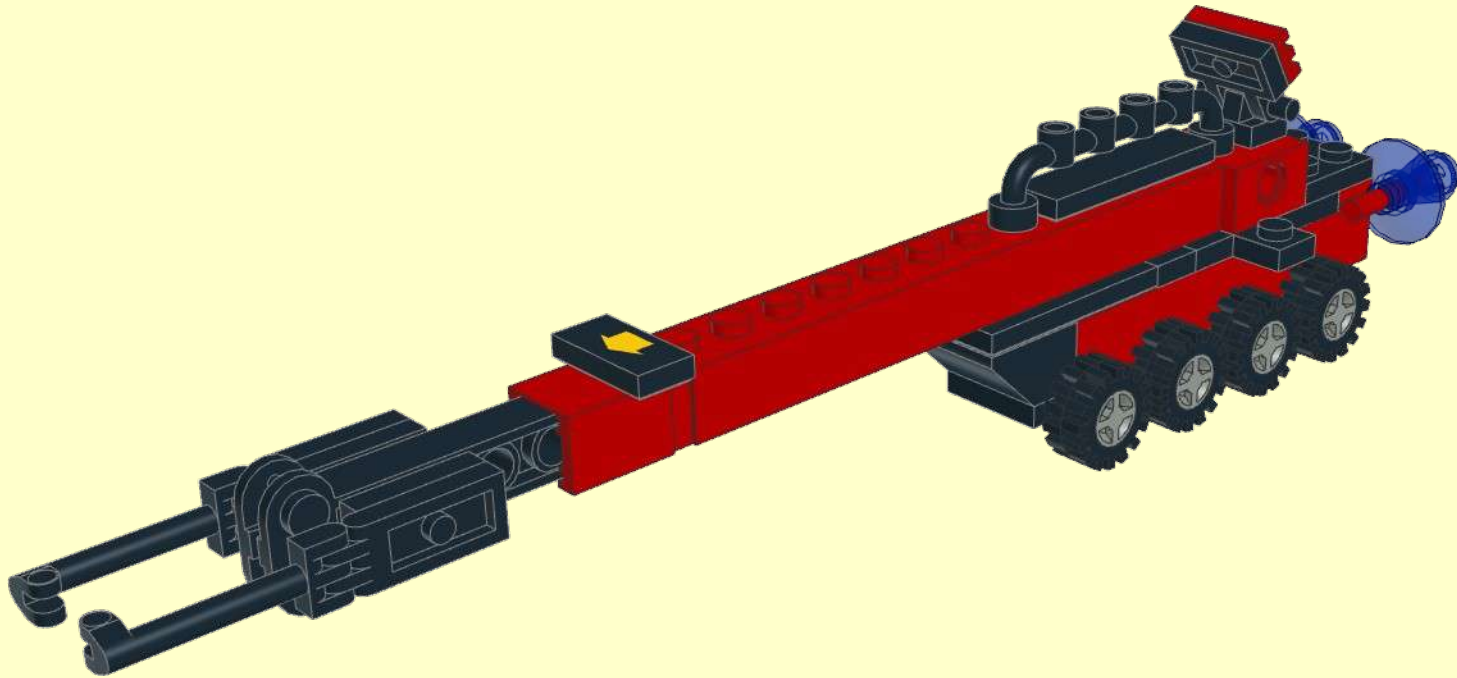

9

6.4x8



4x

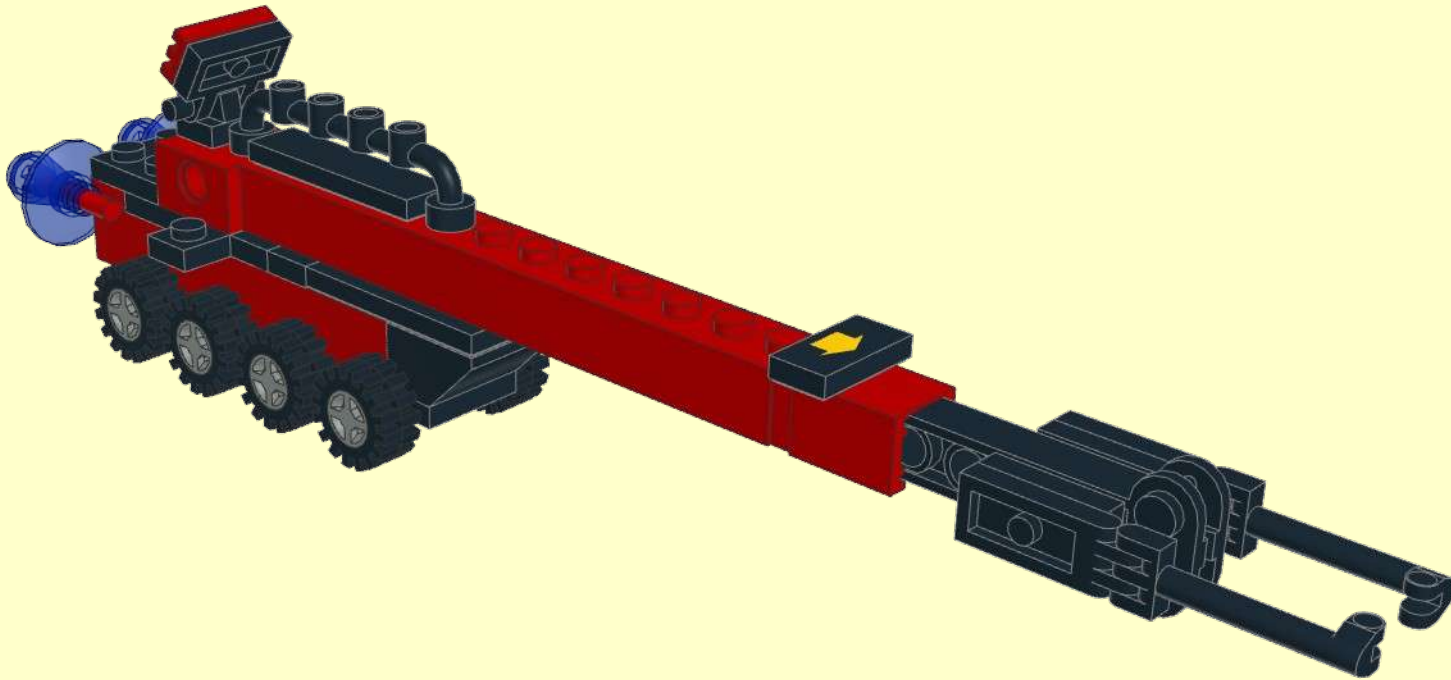

1

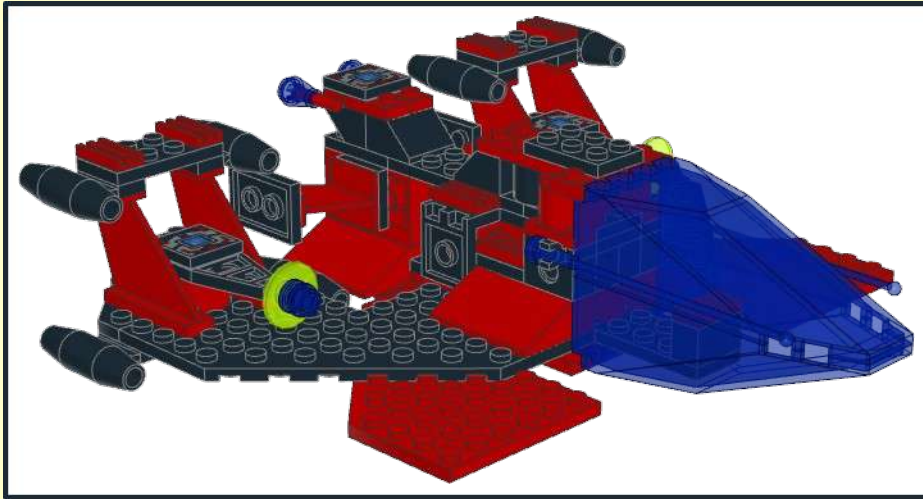

4x12

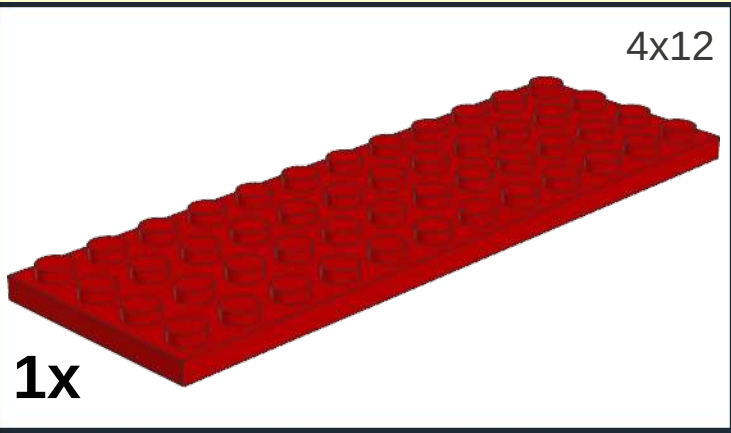

1x

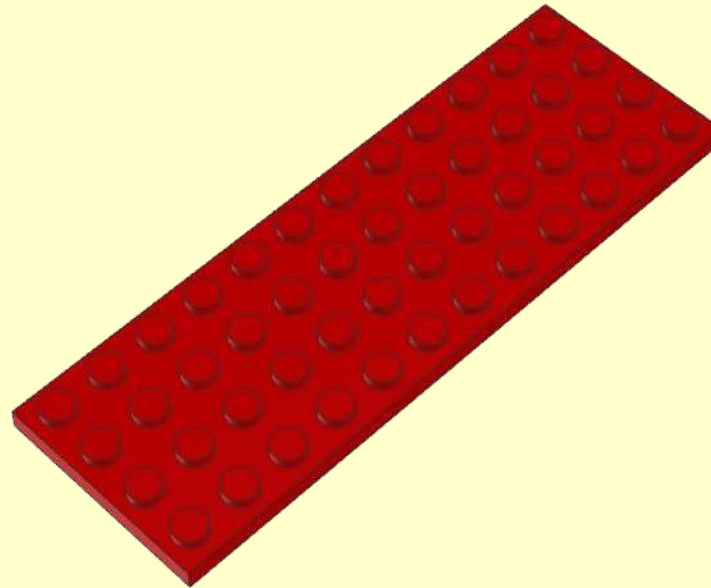

2

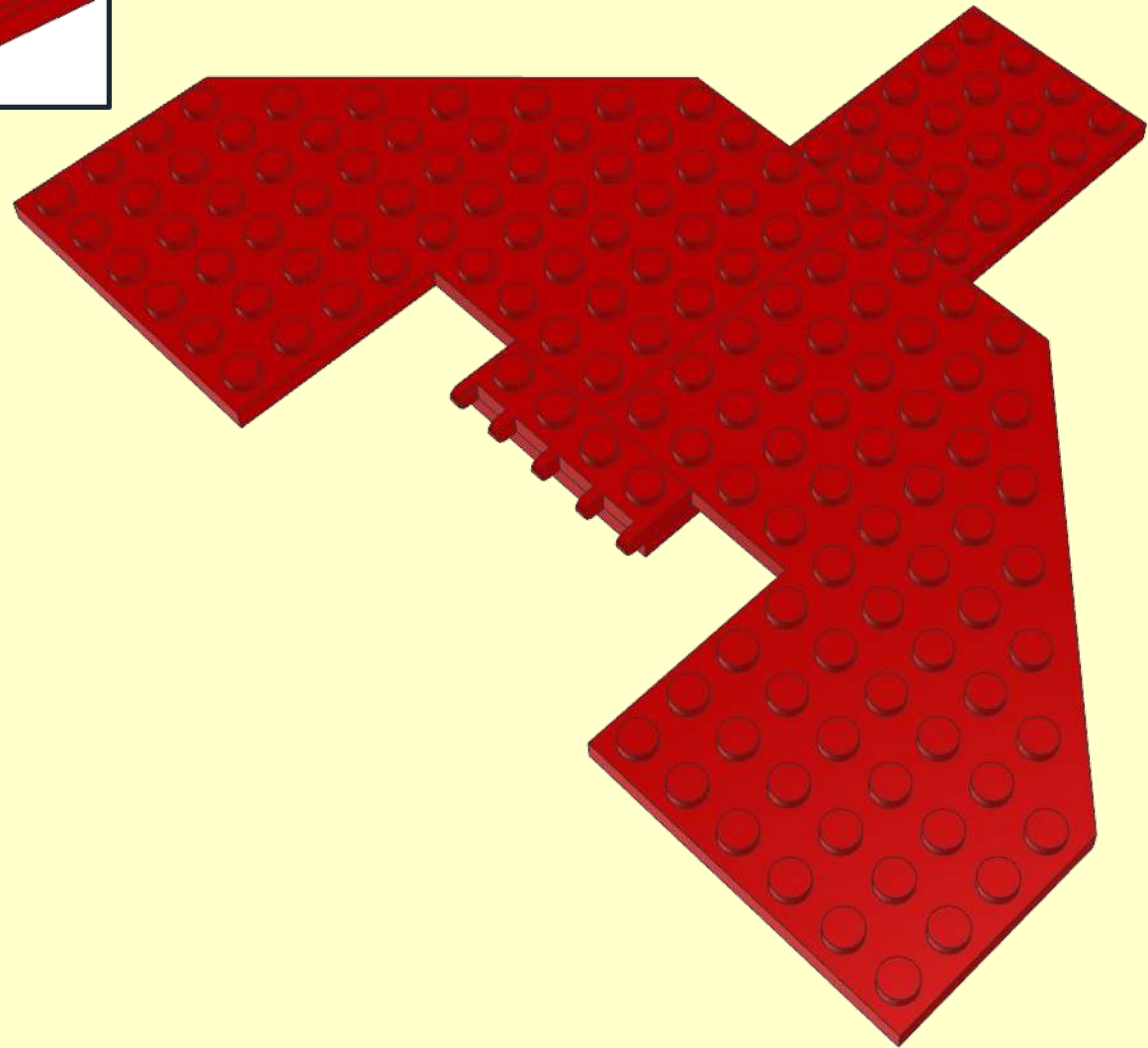
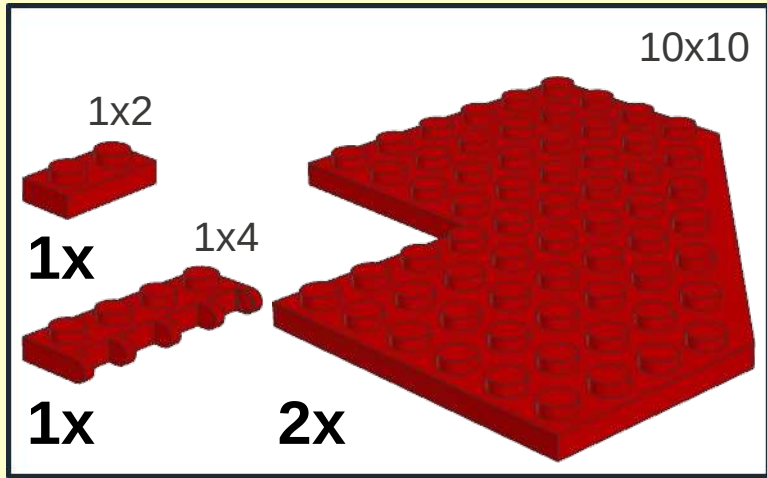



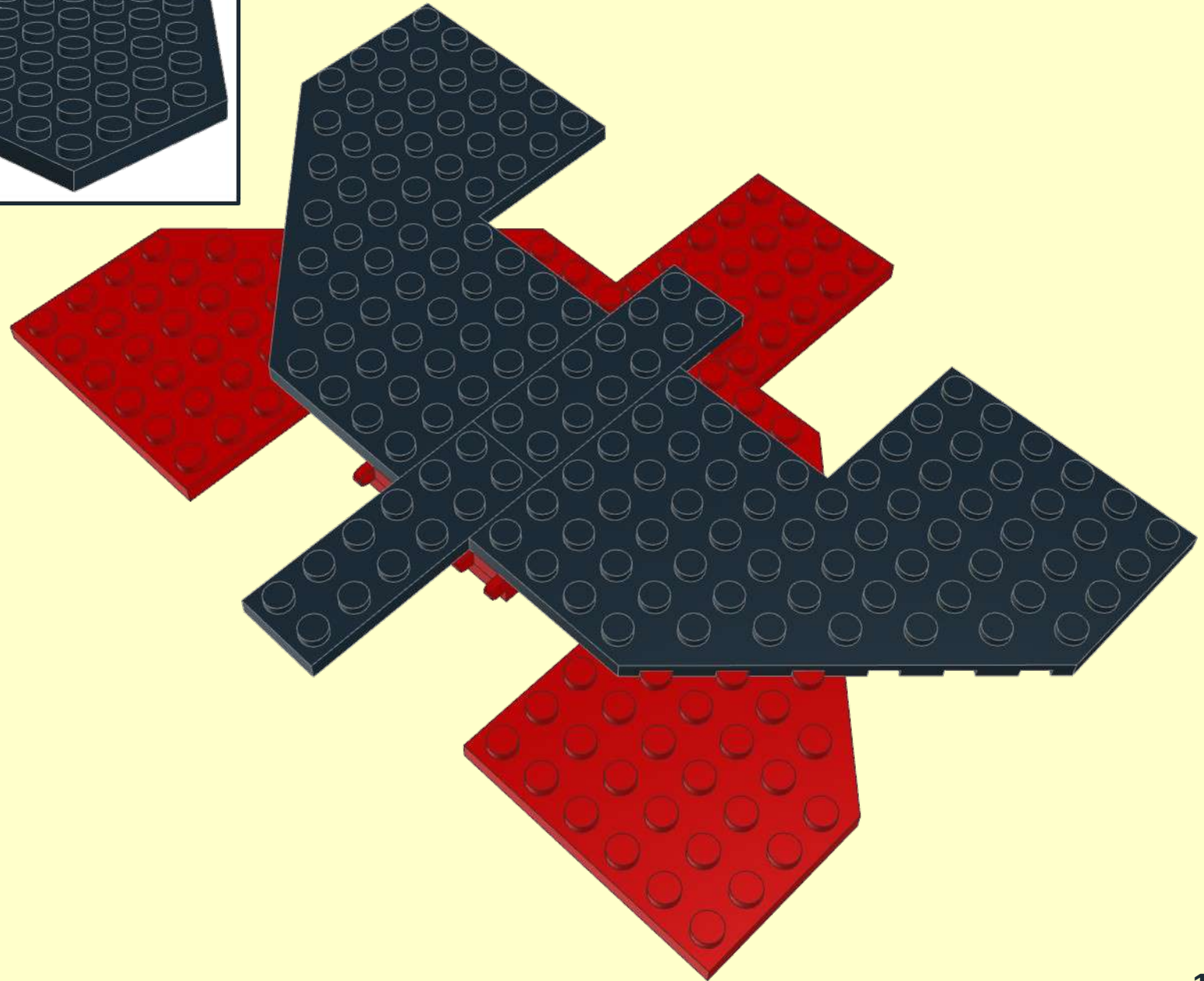
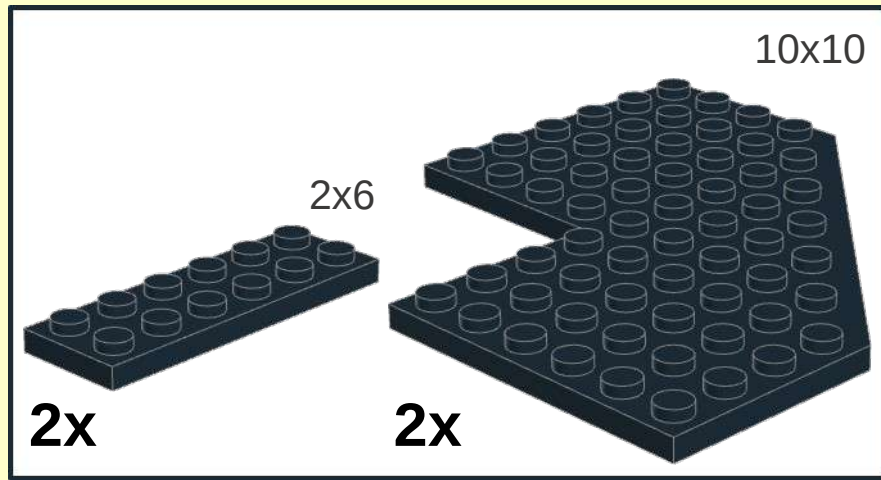

3

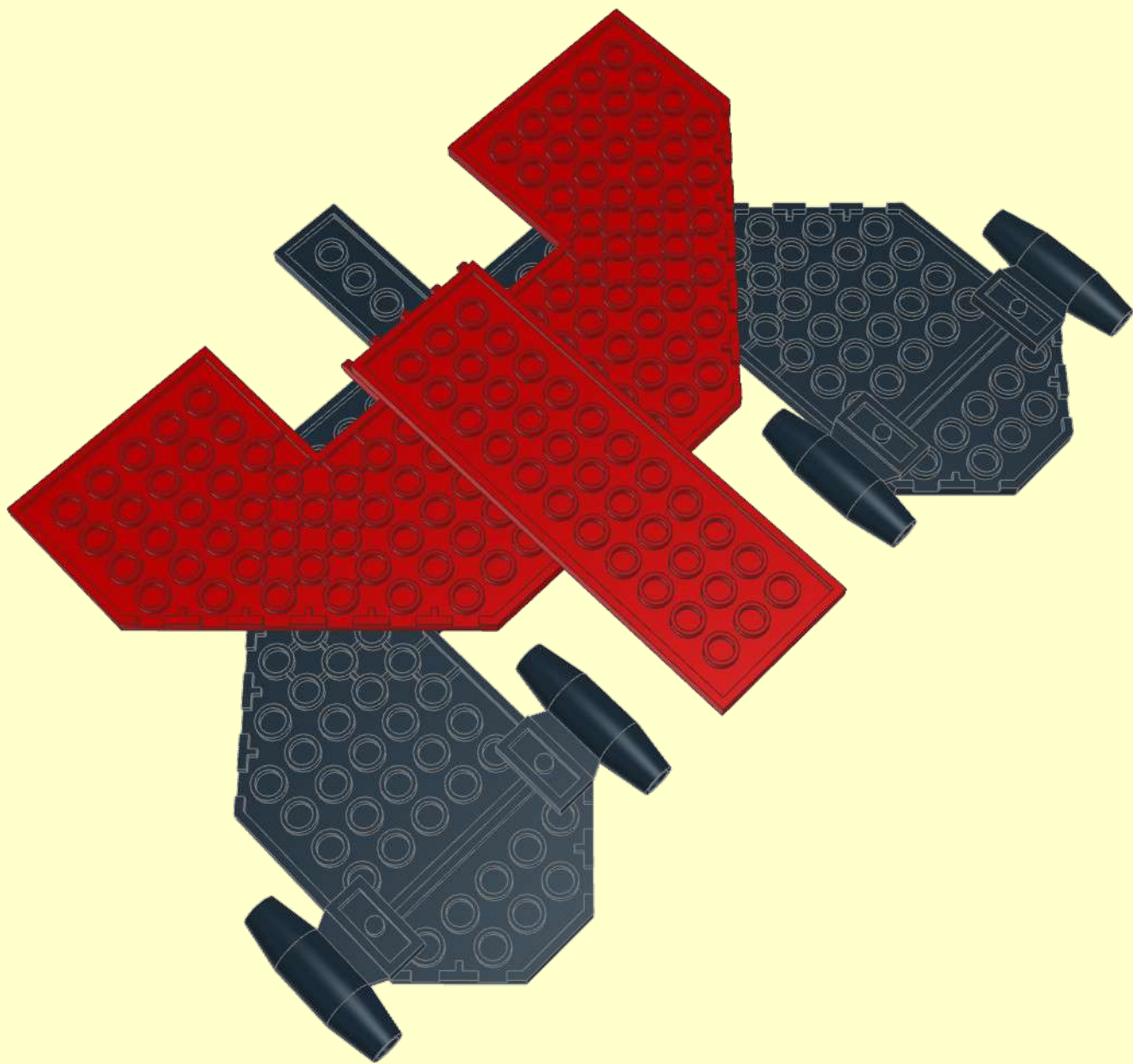
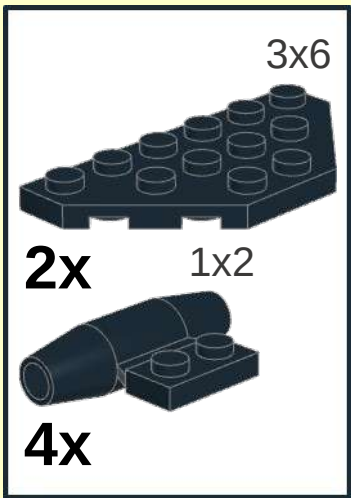

4

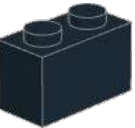

5

1x2	2x2
	
1x	1x
2x2	2x2
	
1x	1x

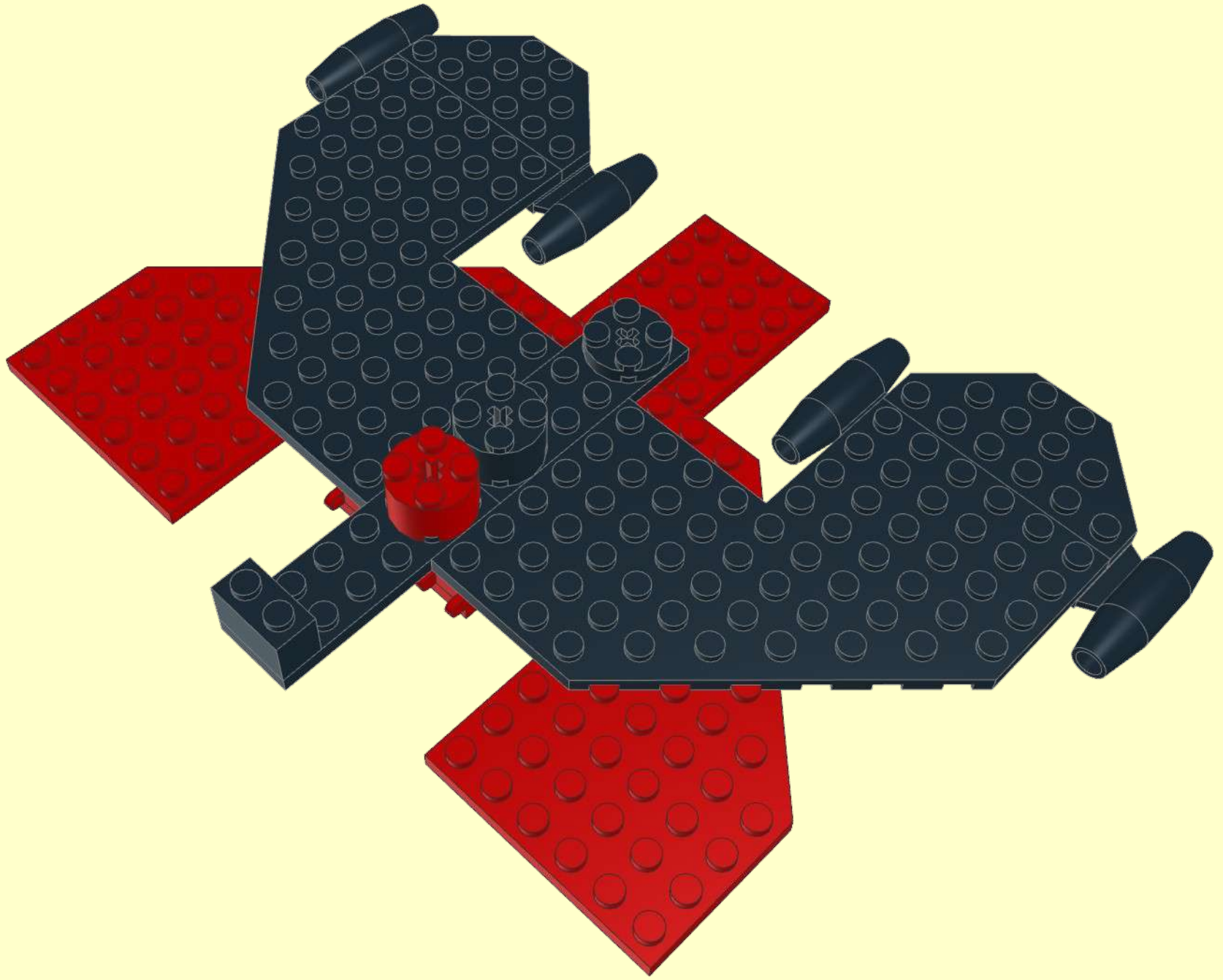

6

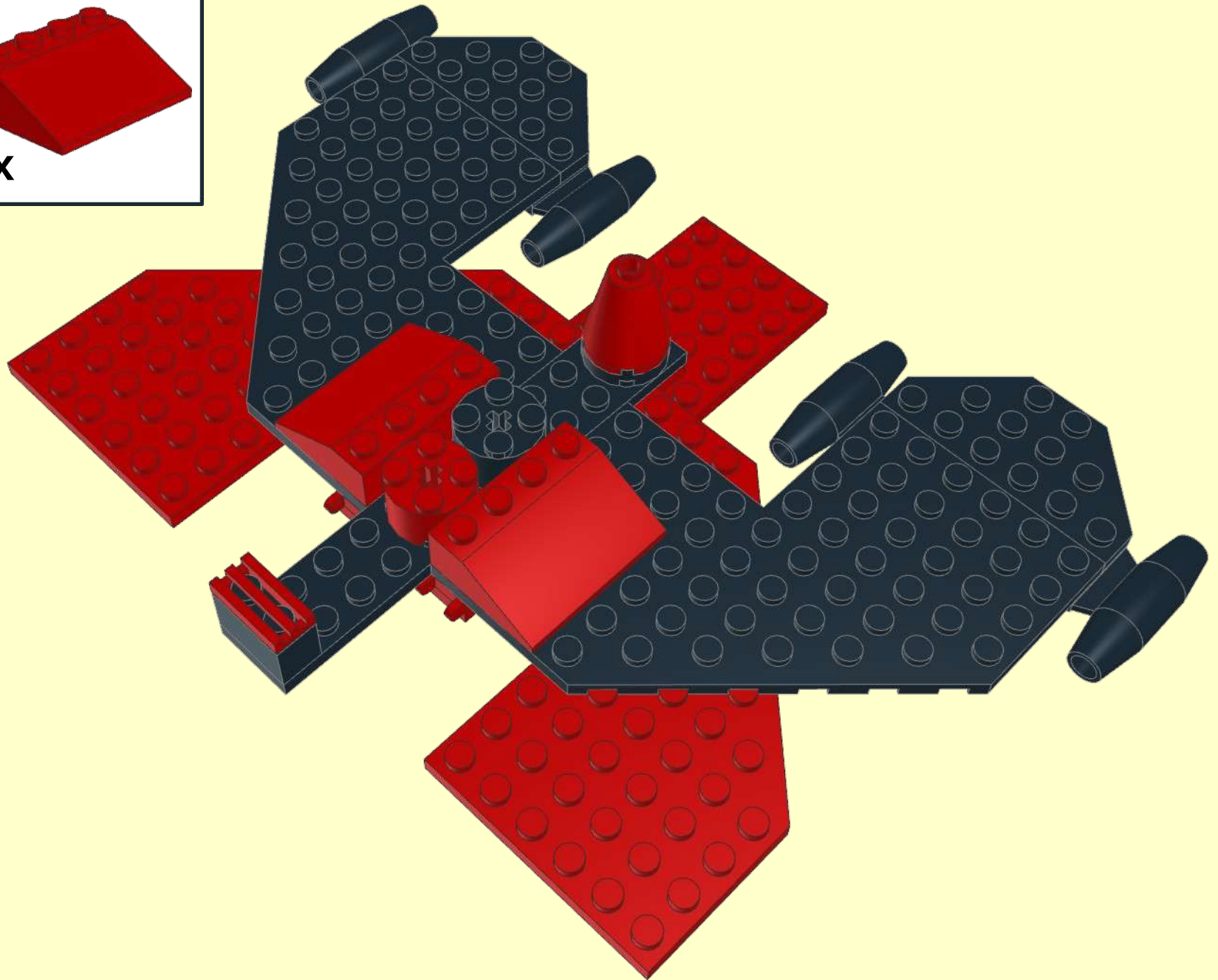
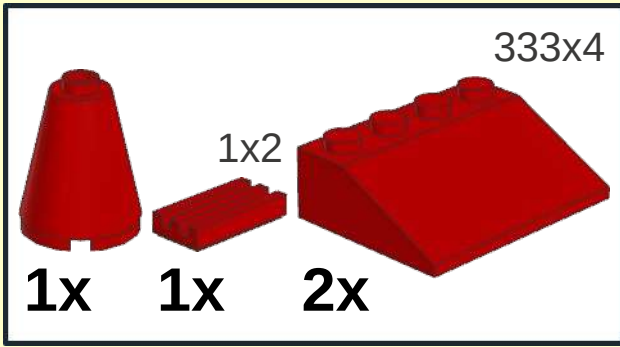

7

2x4x2

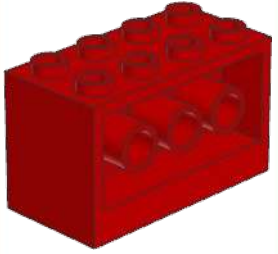

1x 2x2

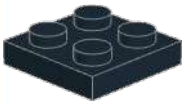

2x

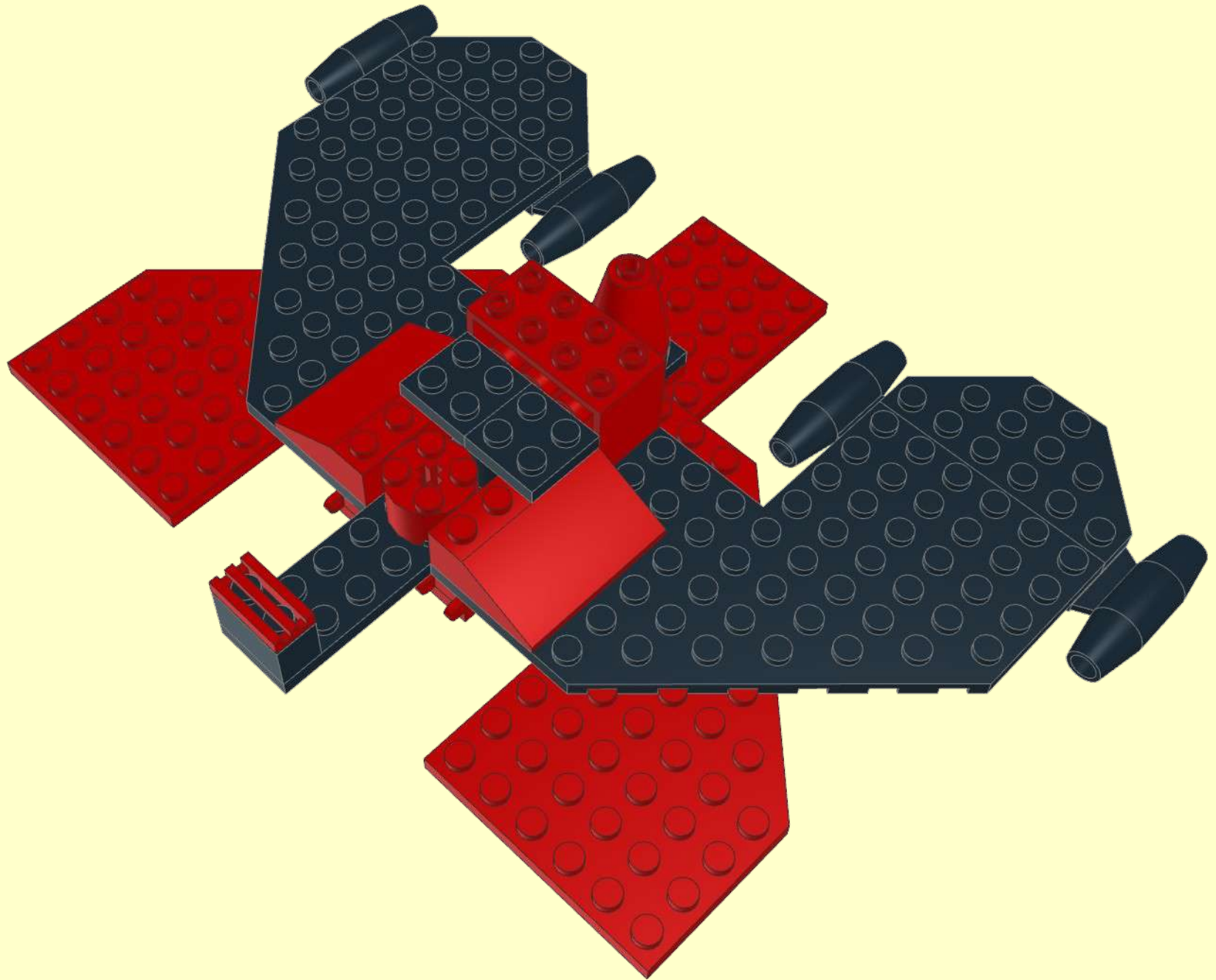

8

2x2-2x2



1x2

2x

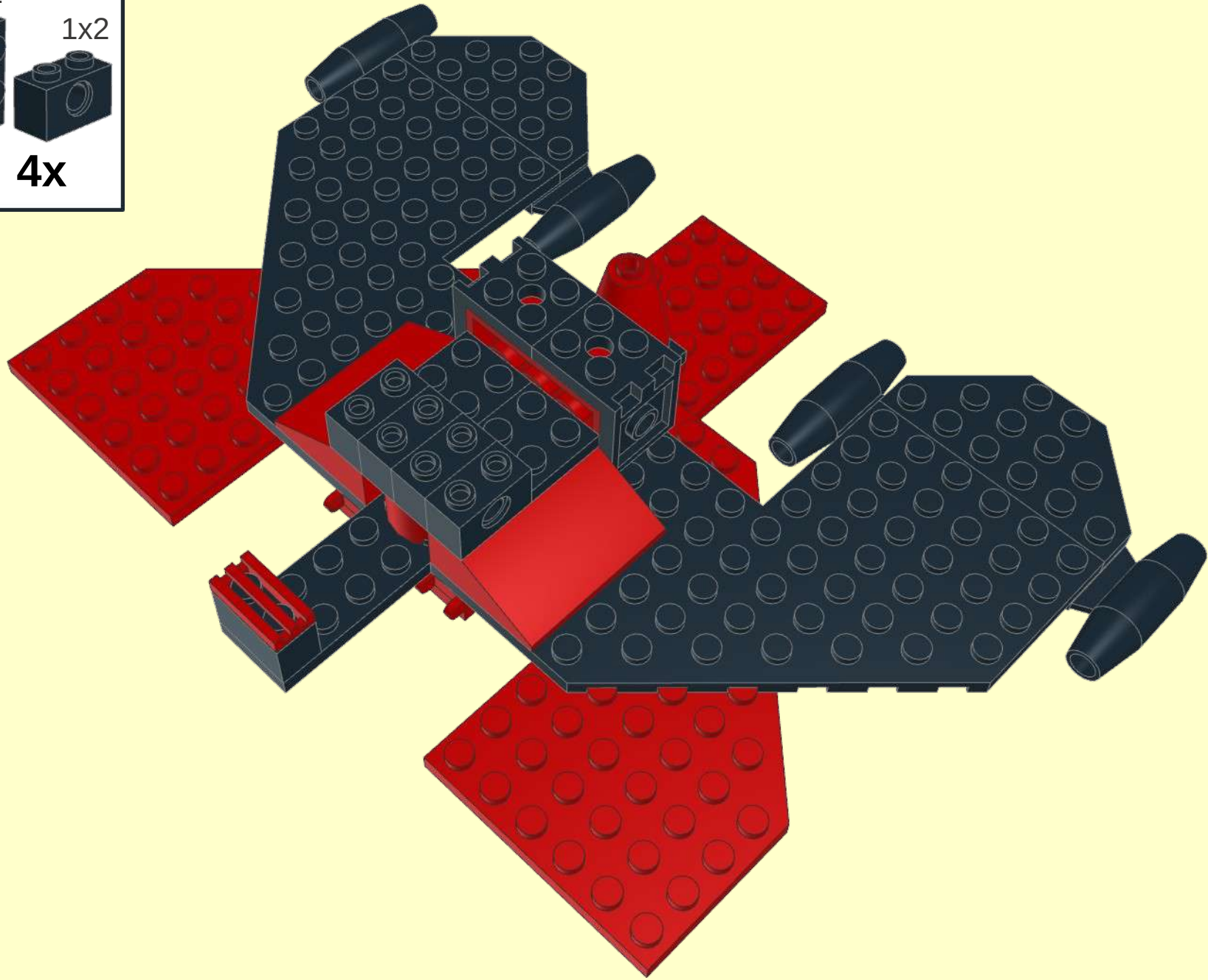
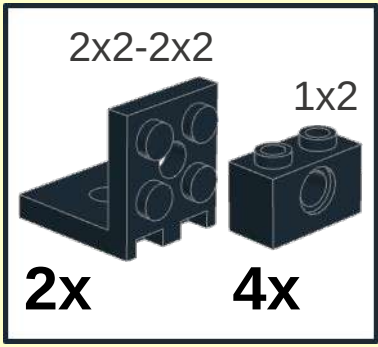
4x



9

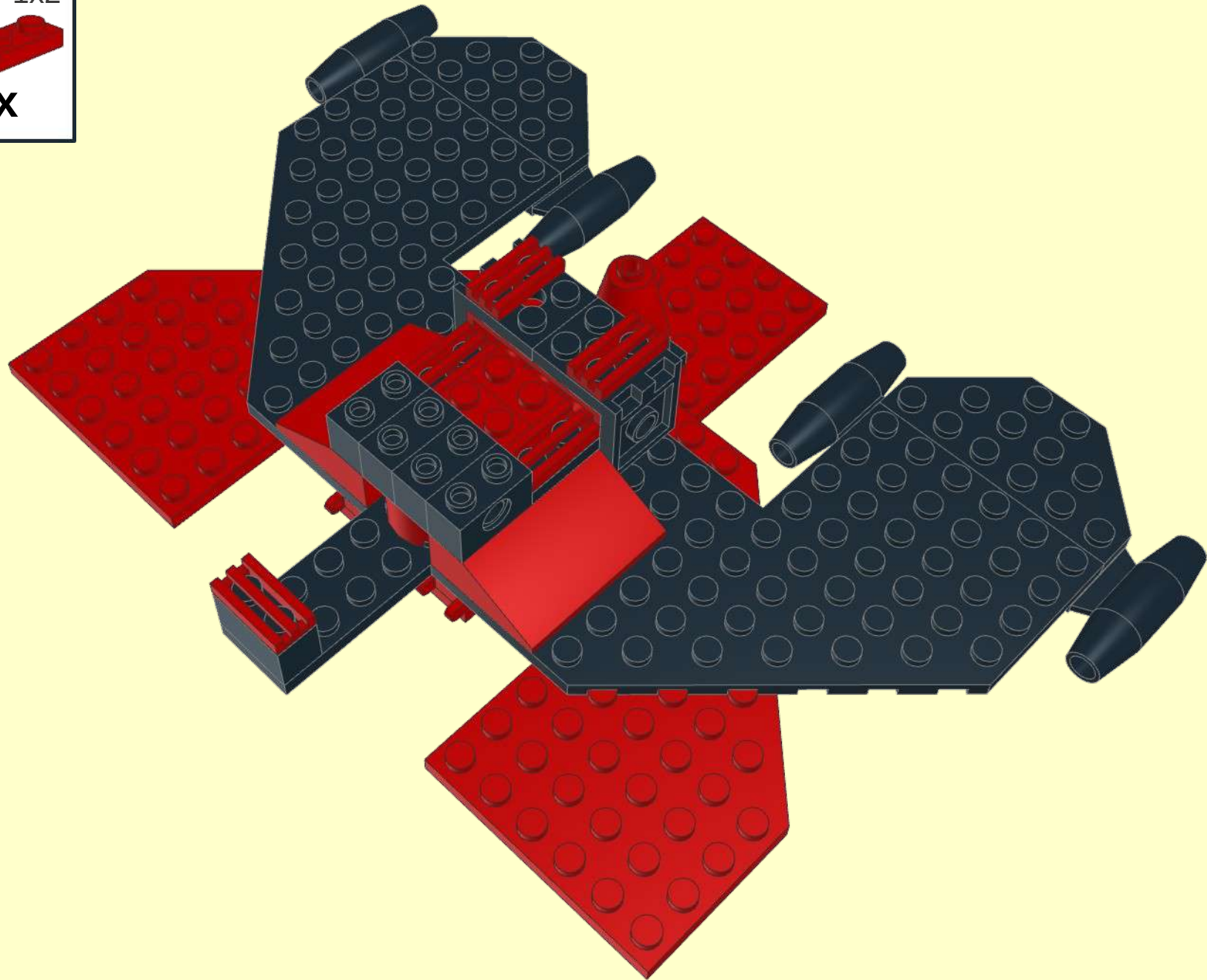

1x2	1x2
	
4x	2x

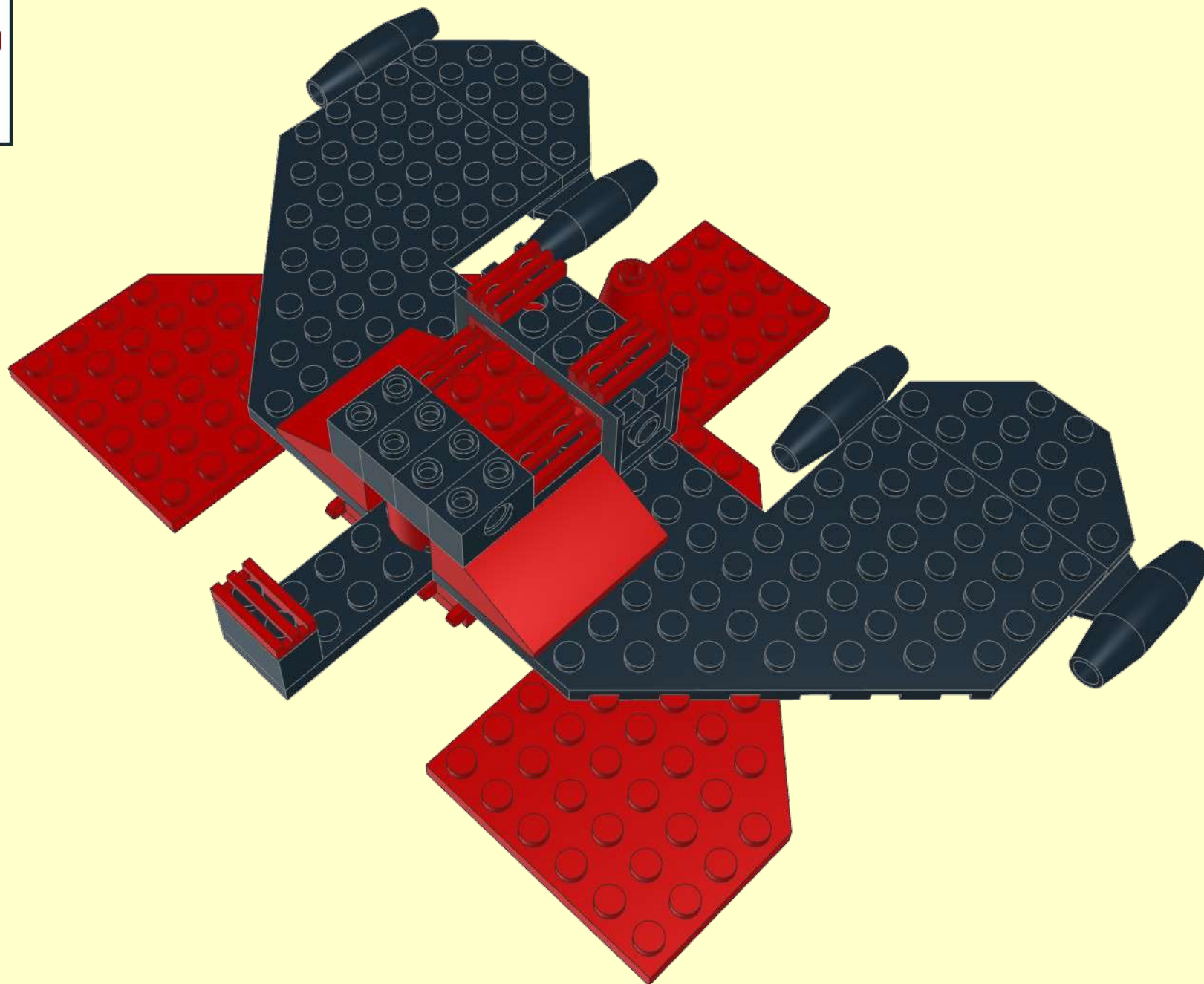
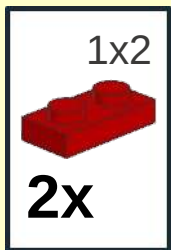

10

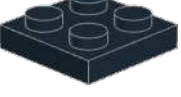

11

1x2	1x4
	
1x	1x
1x1	2x2
	
2x	1x

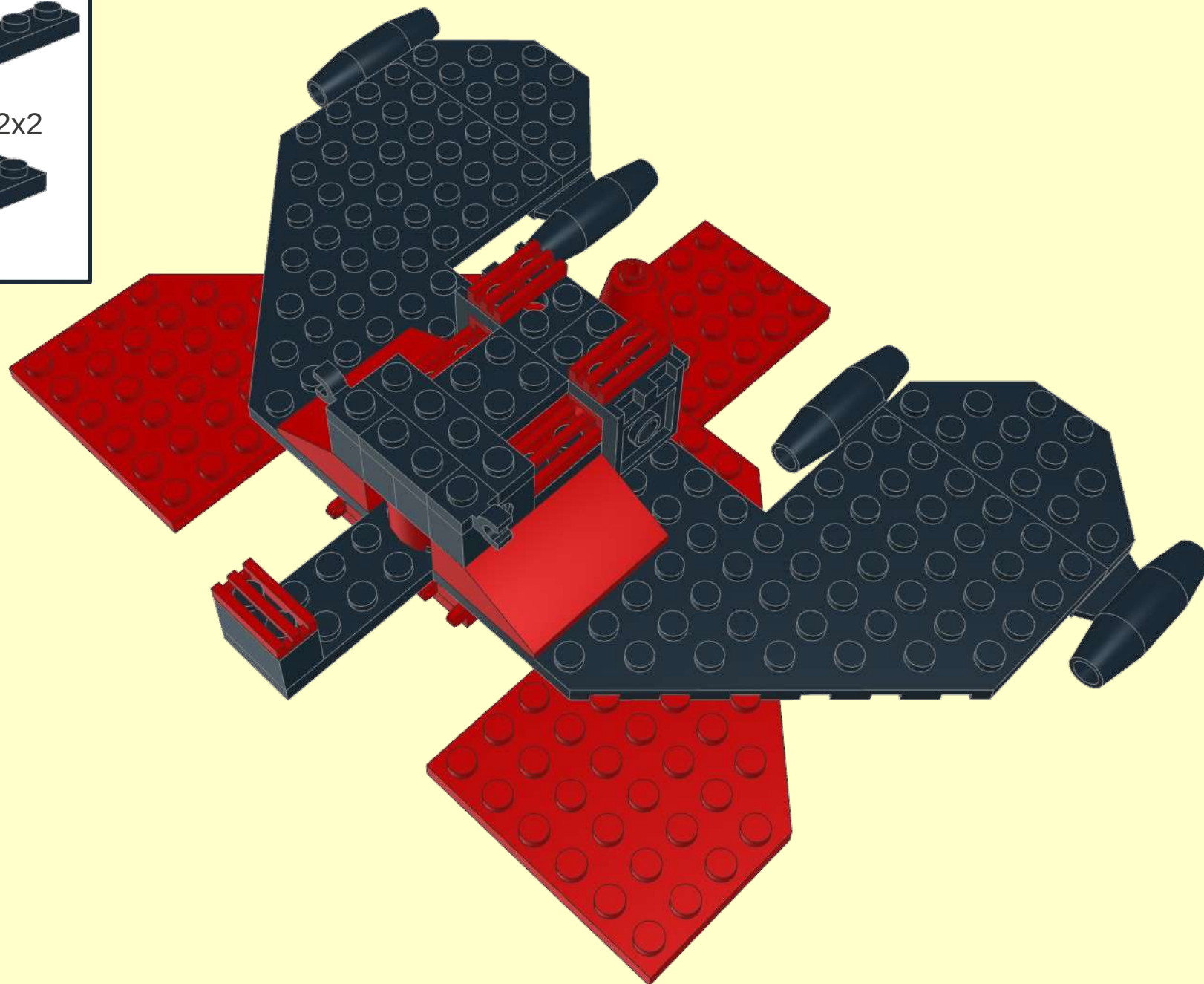

12

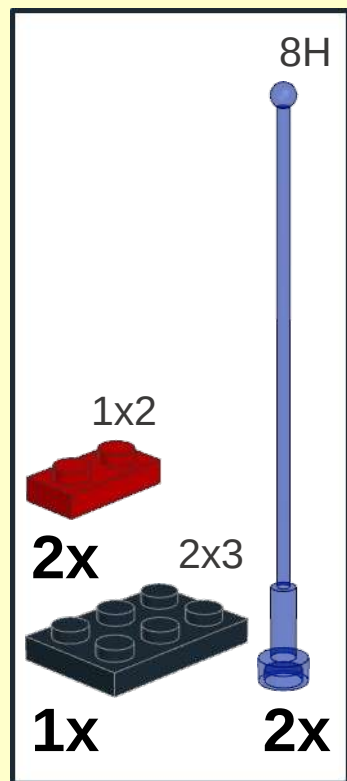

1x2
2x
1x
2x3
8H
2x

This inset box lists the required parts for step 12. It includes a red 1x2 brick, two dark grey 2x3 bricks, one red 1x2 brick, two blue 8H pins, and two blue bush pins. The quantities are indicated by '1x', '2x', and '8H'.

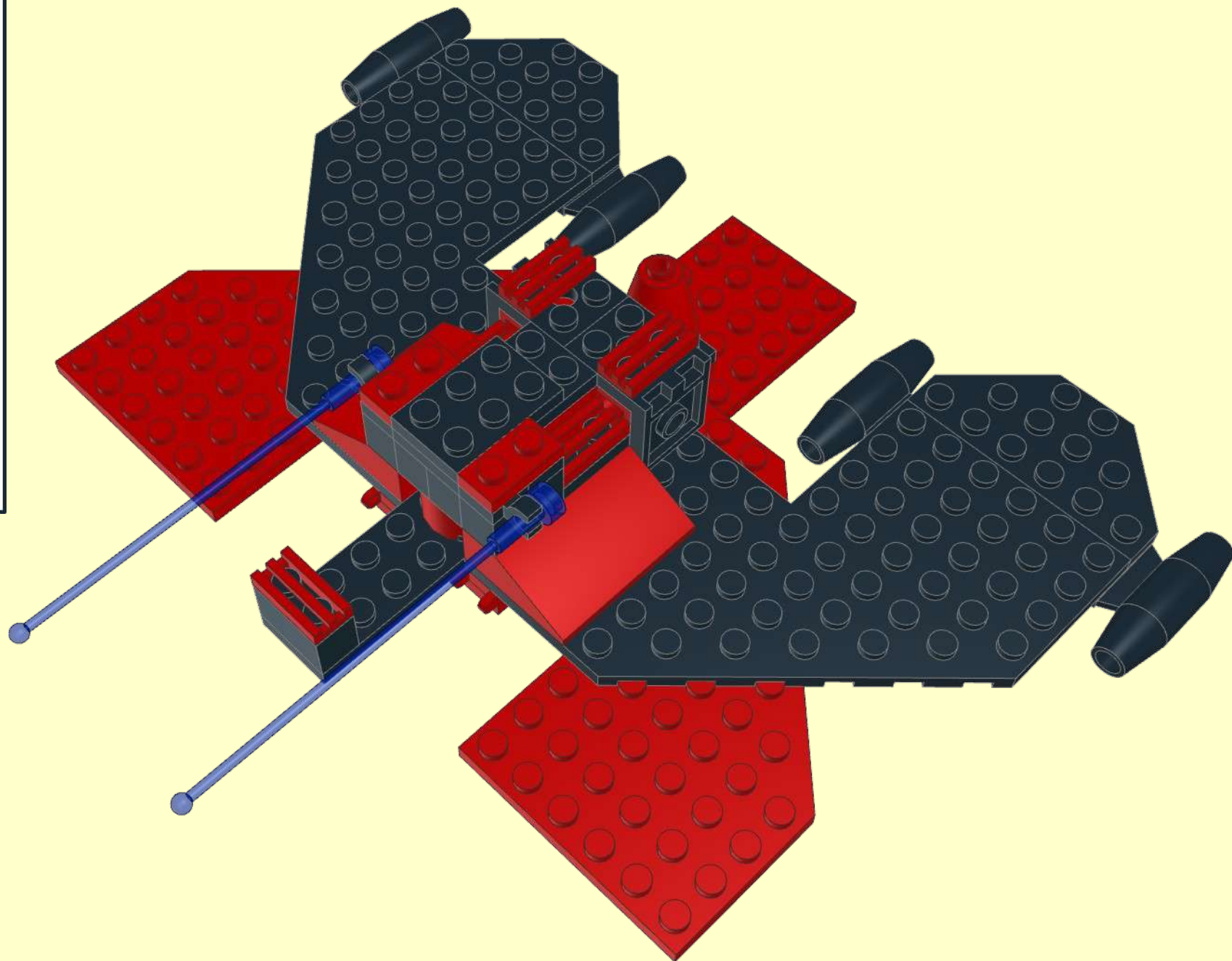

13

333x4

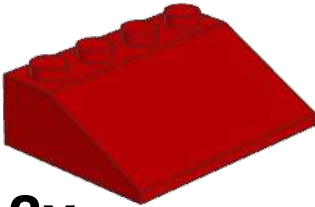

2x

2x4x2

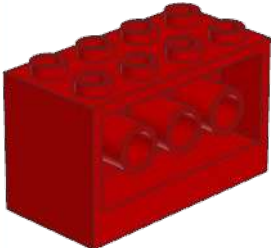

1x

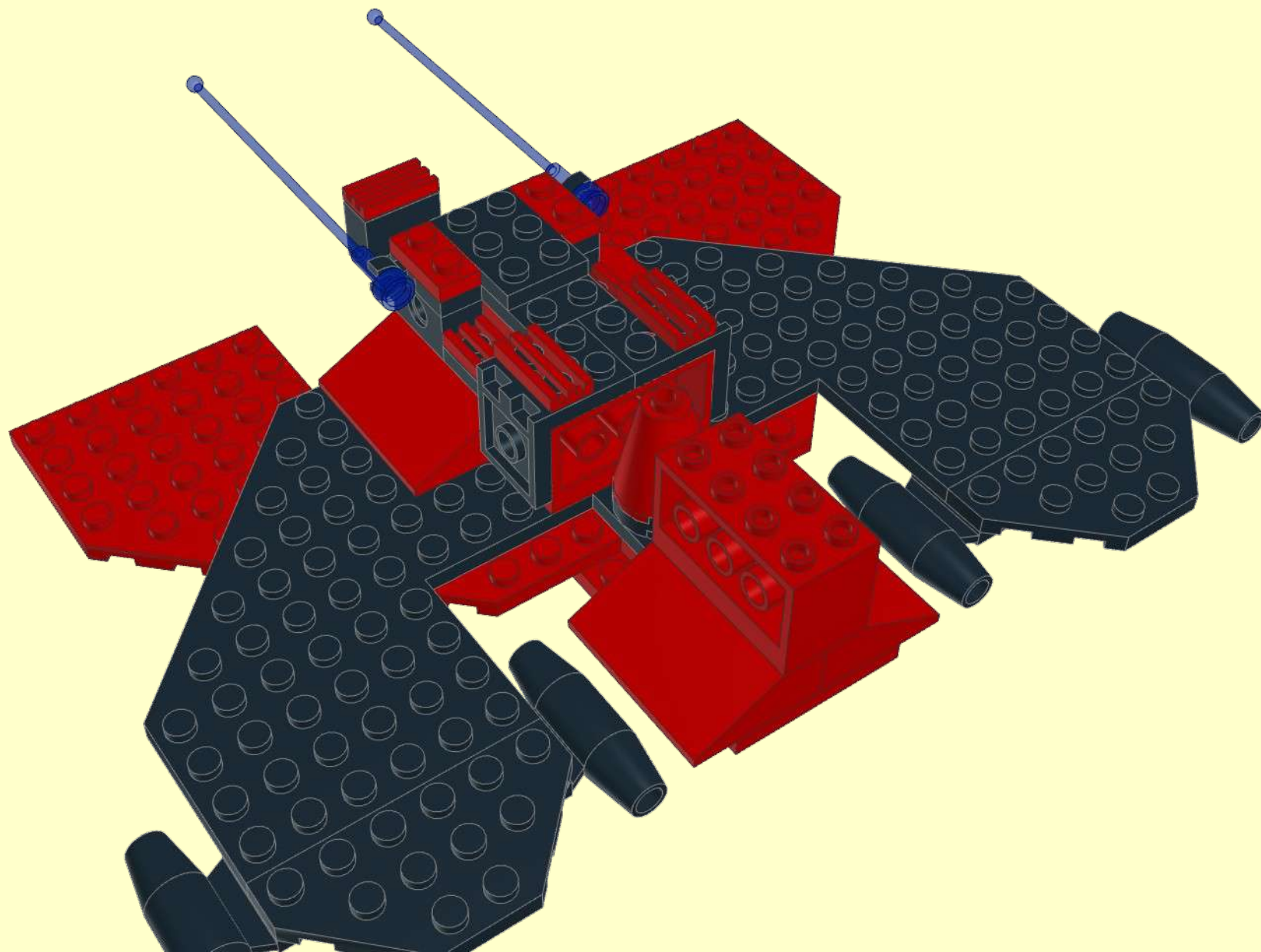

14

4x2x2

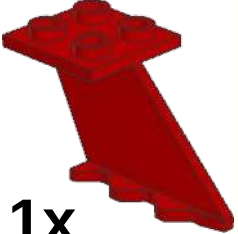

1x

2x3



1x

2x2

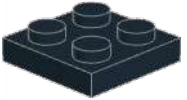

1x

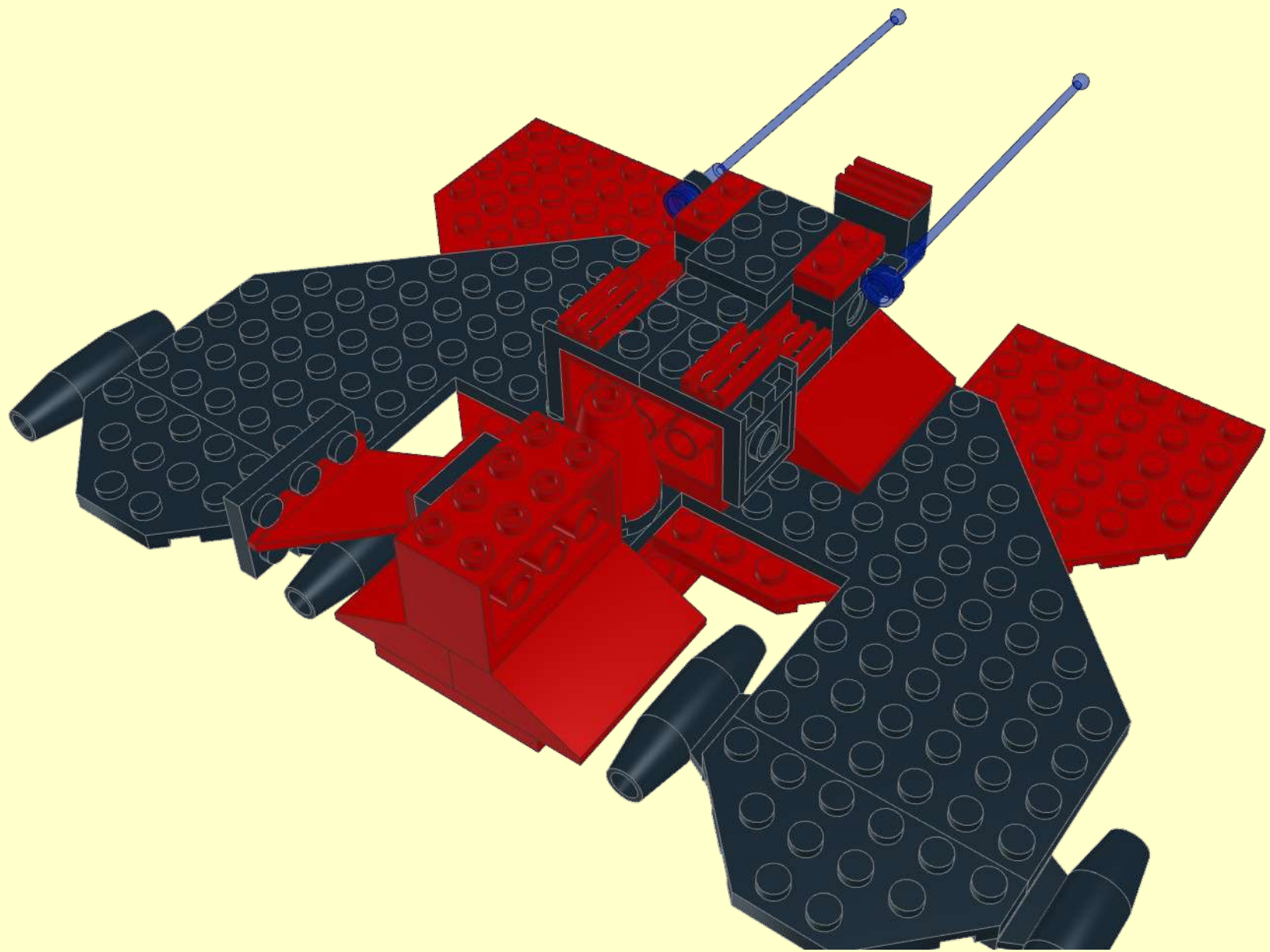

15

4x2x2

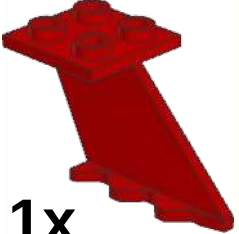

1x

2x3



1x

2x2

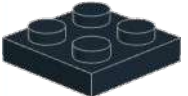

1x

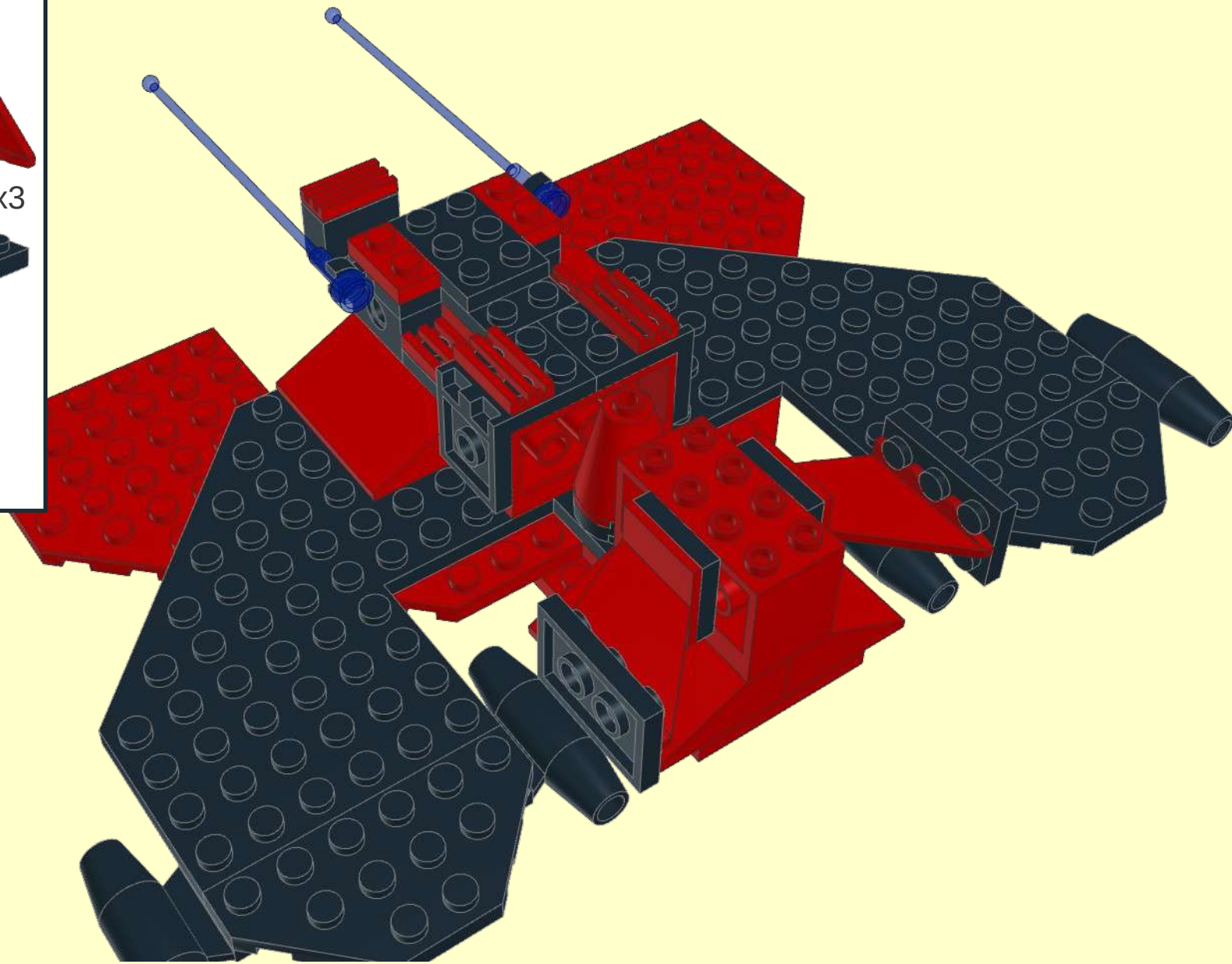

16

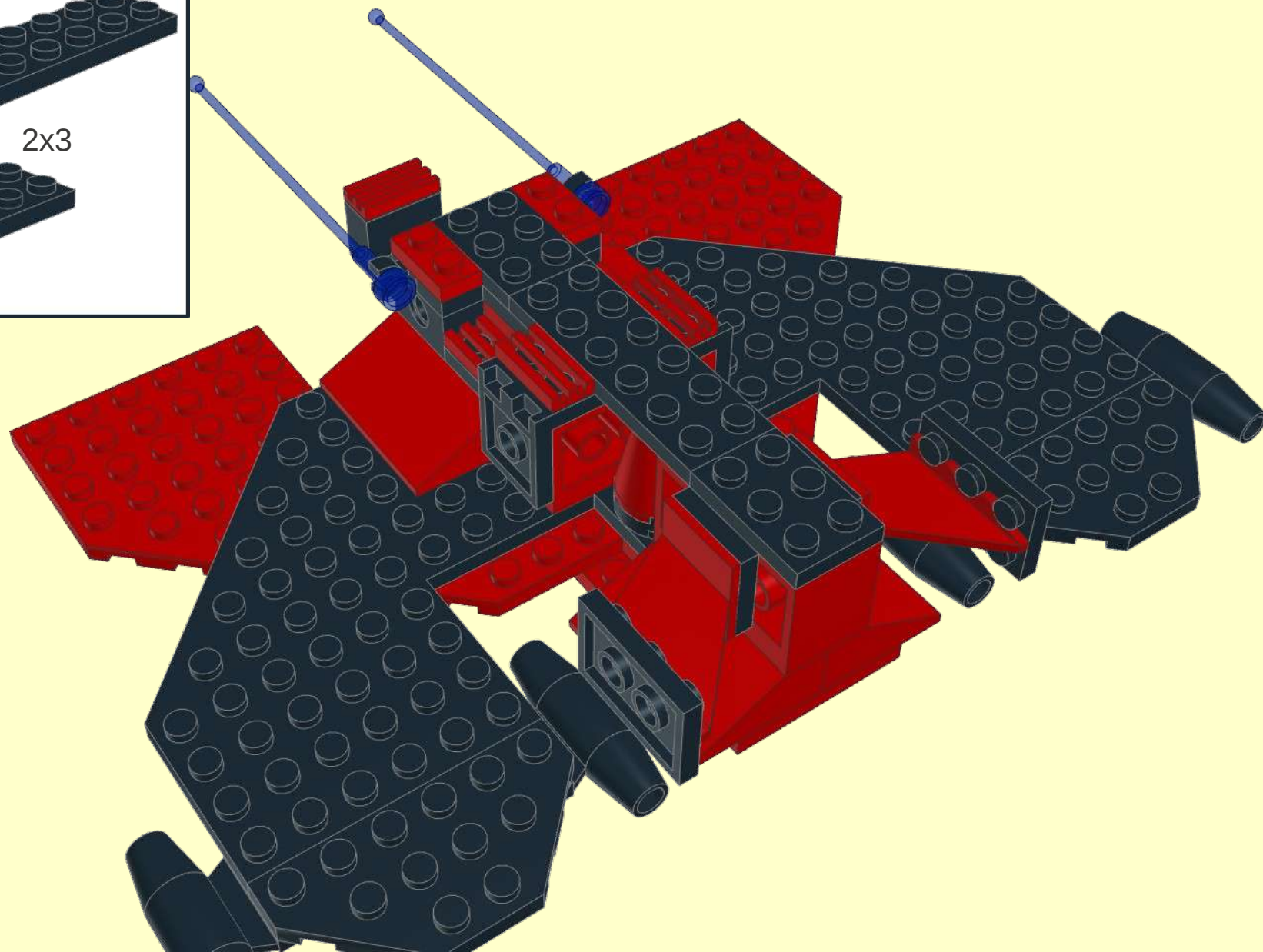
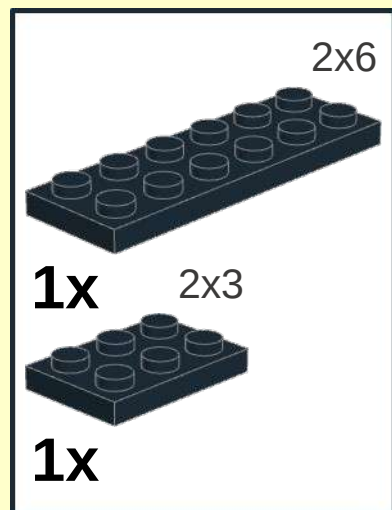

17

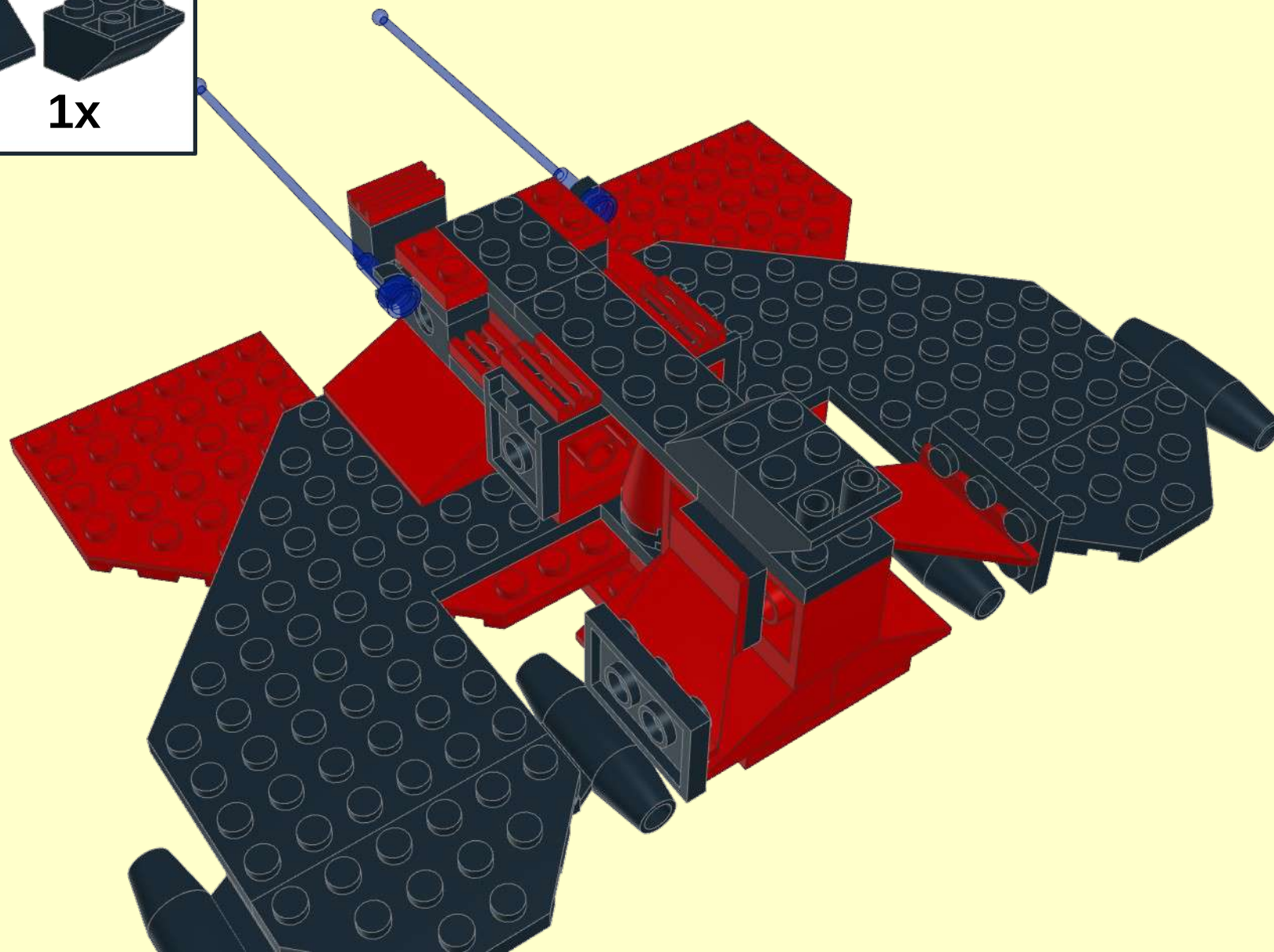
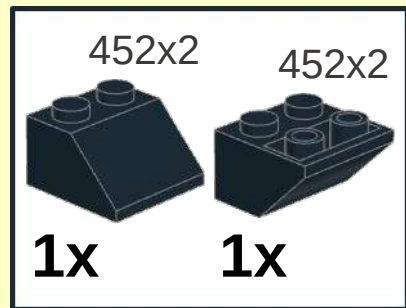

18

1x2	1x2
2x	1x

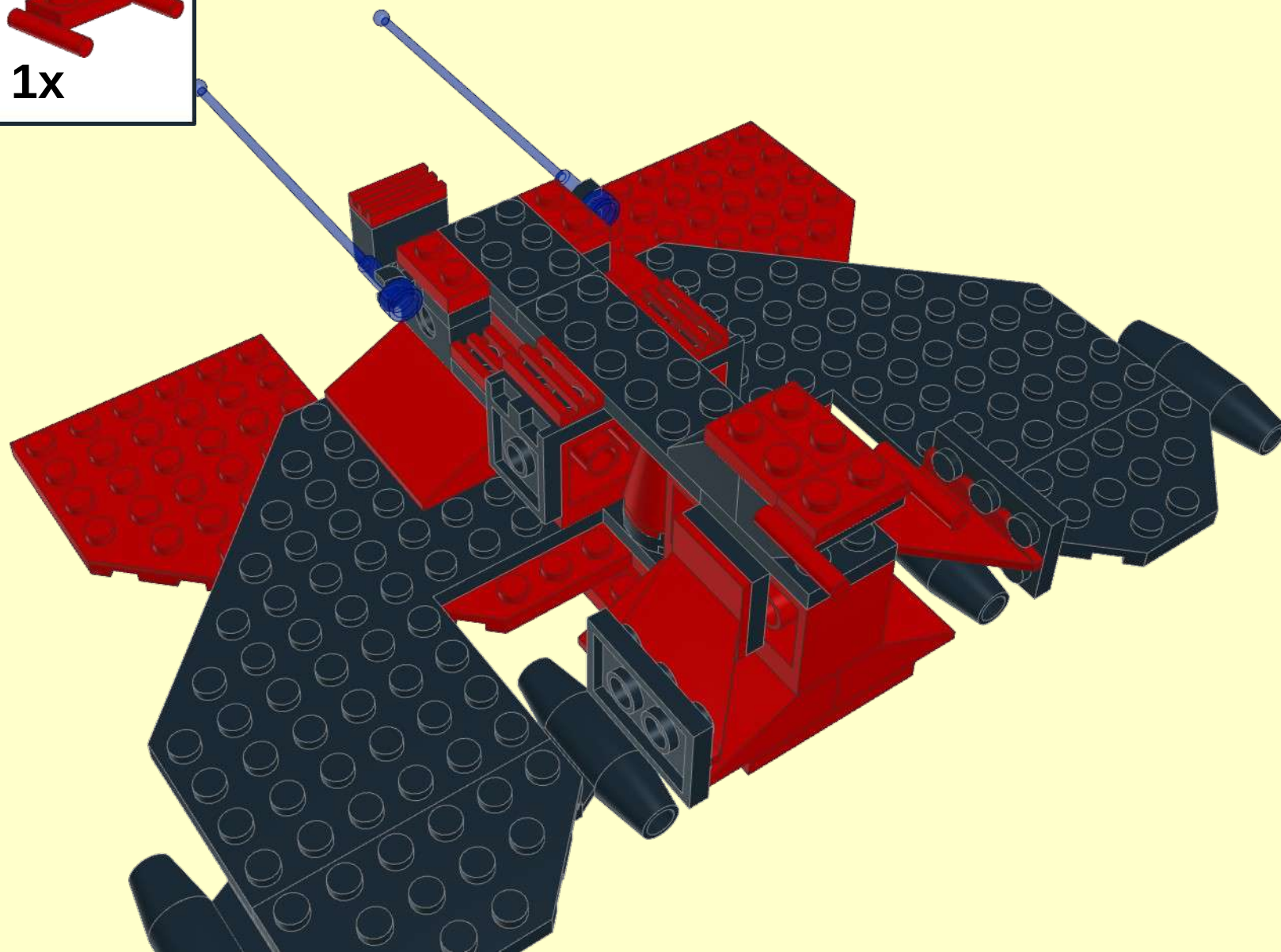

19

	2x2
	
1x	2x

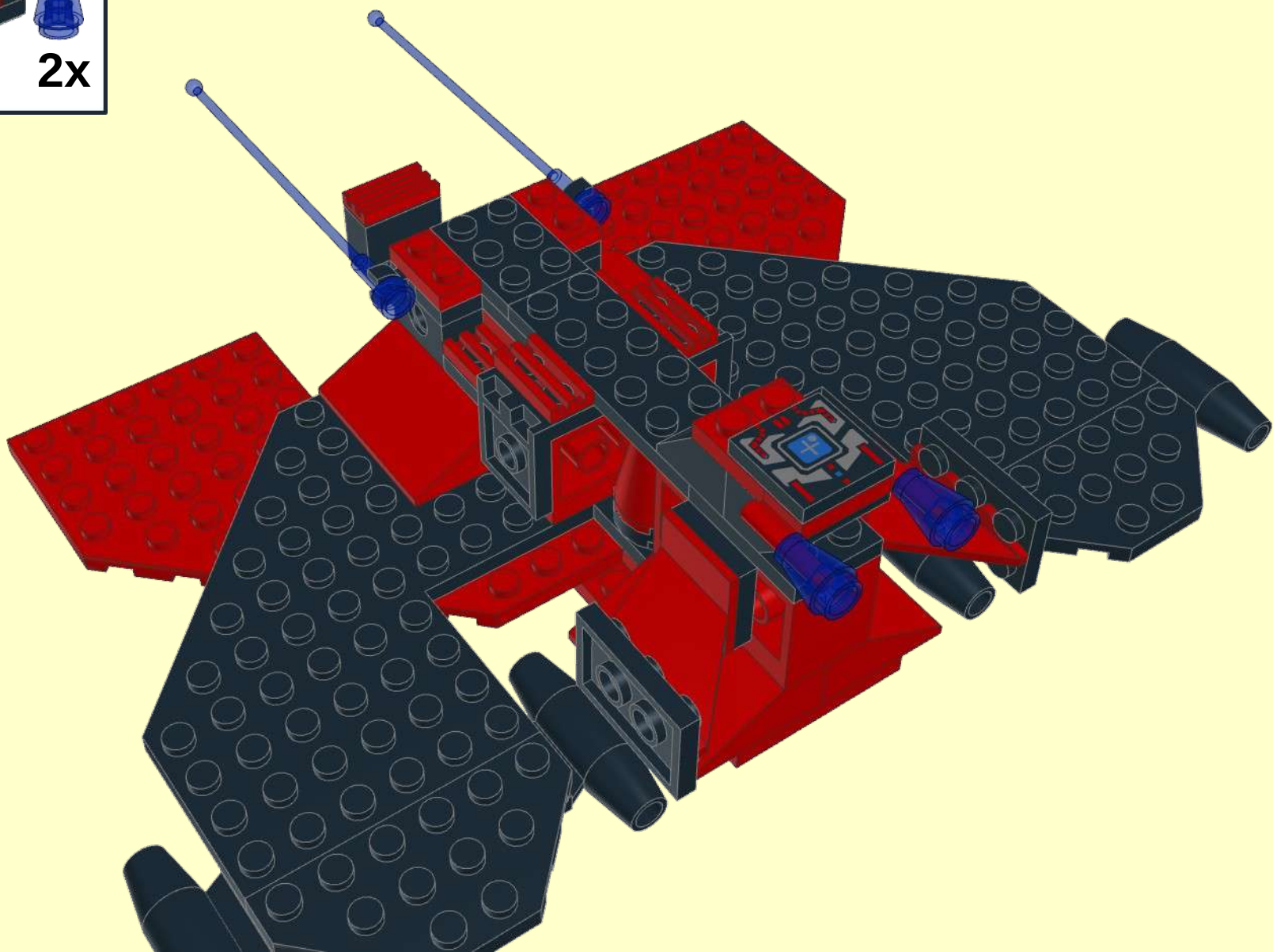

20

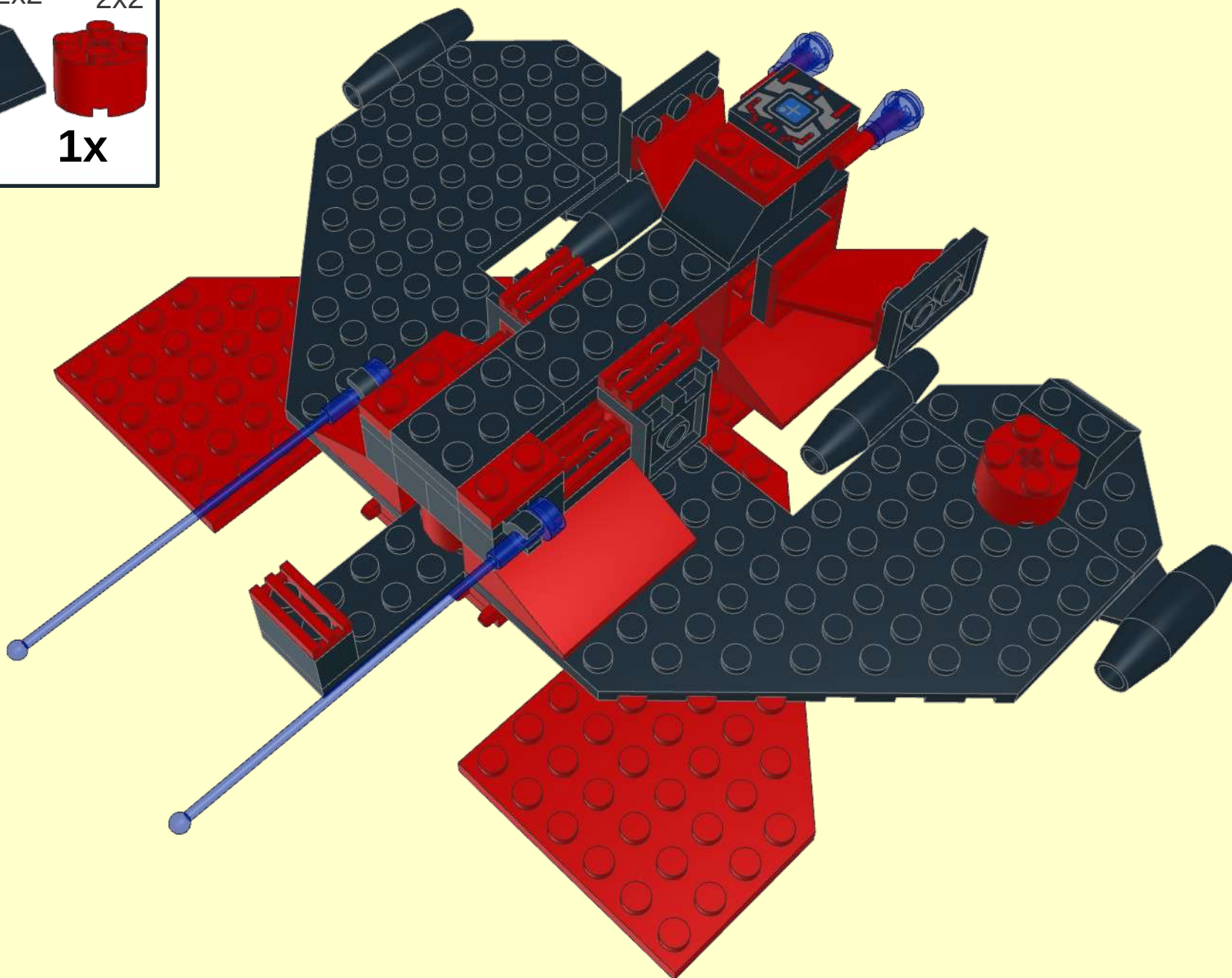
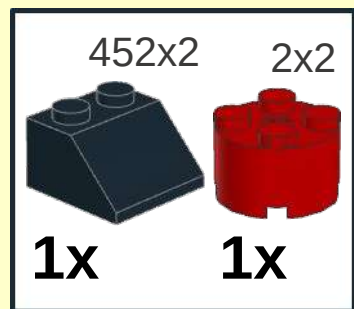

21

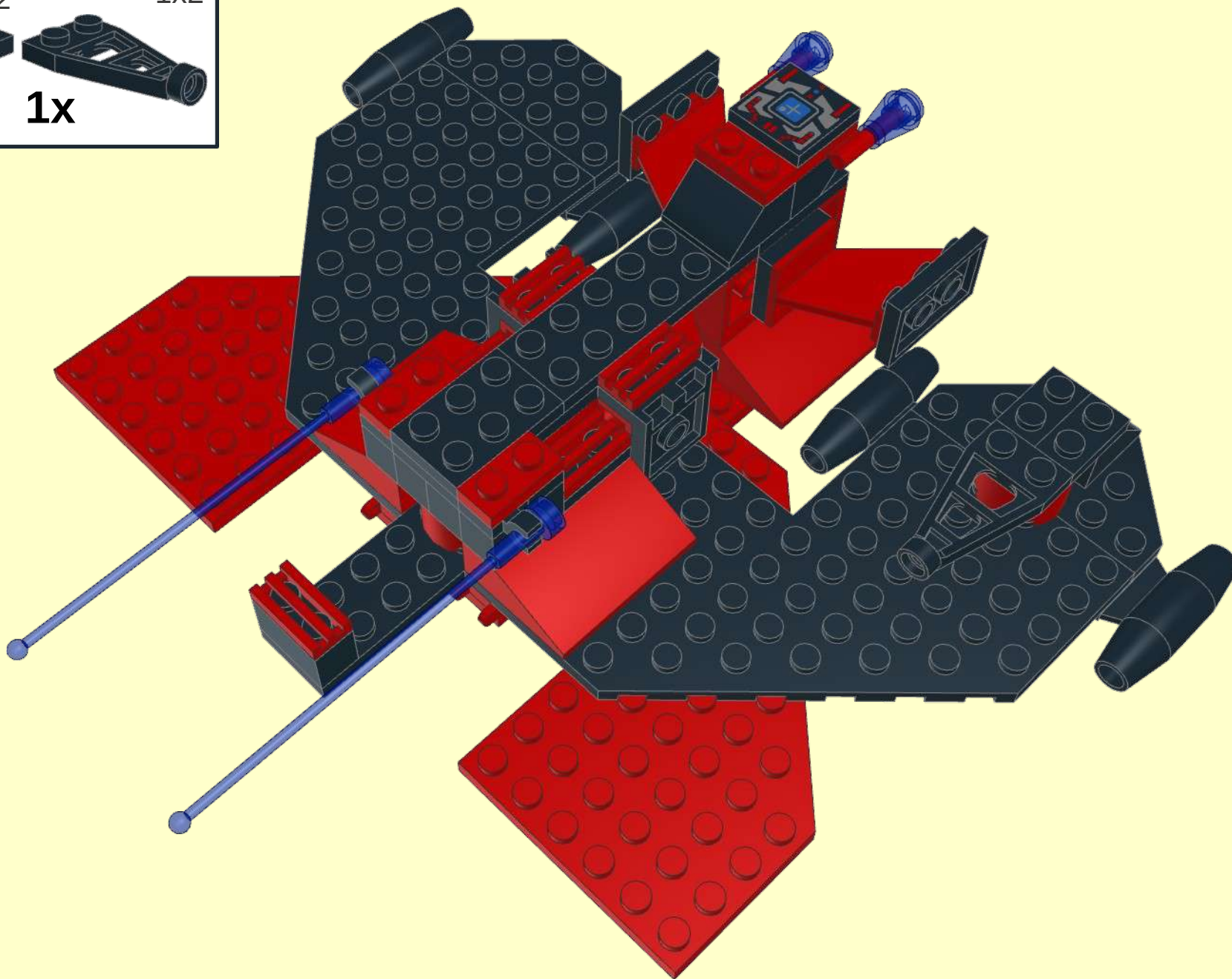
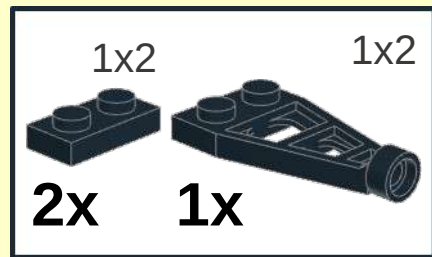

22

	2x2		1x1		2x2
1x		2x	1x		

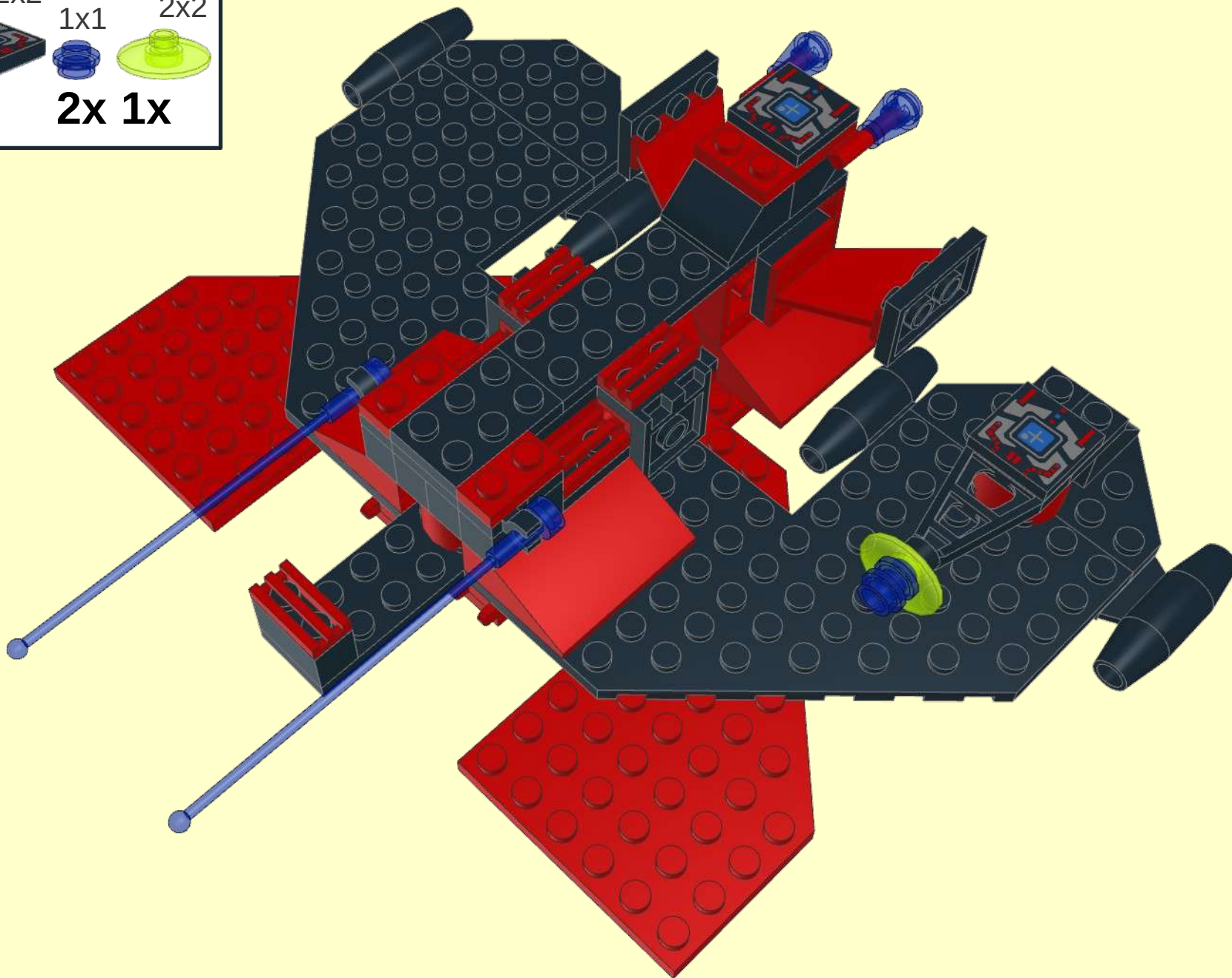

23

4x1x3

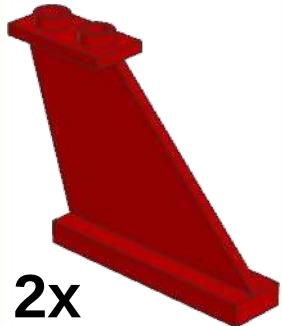

2x

1x2



2x

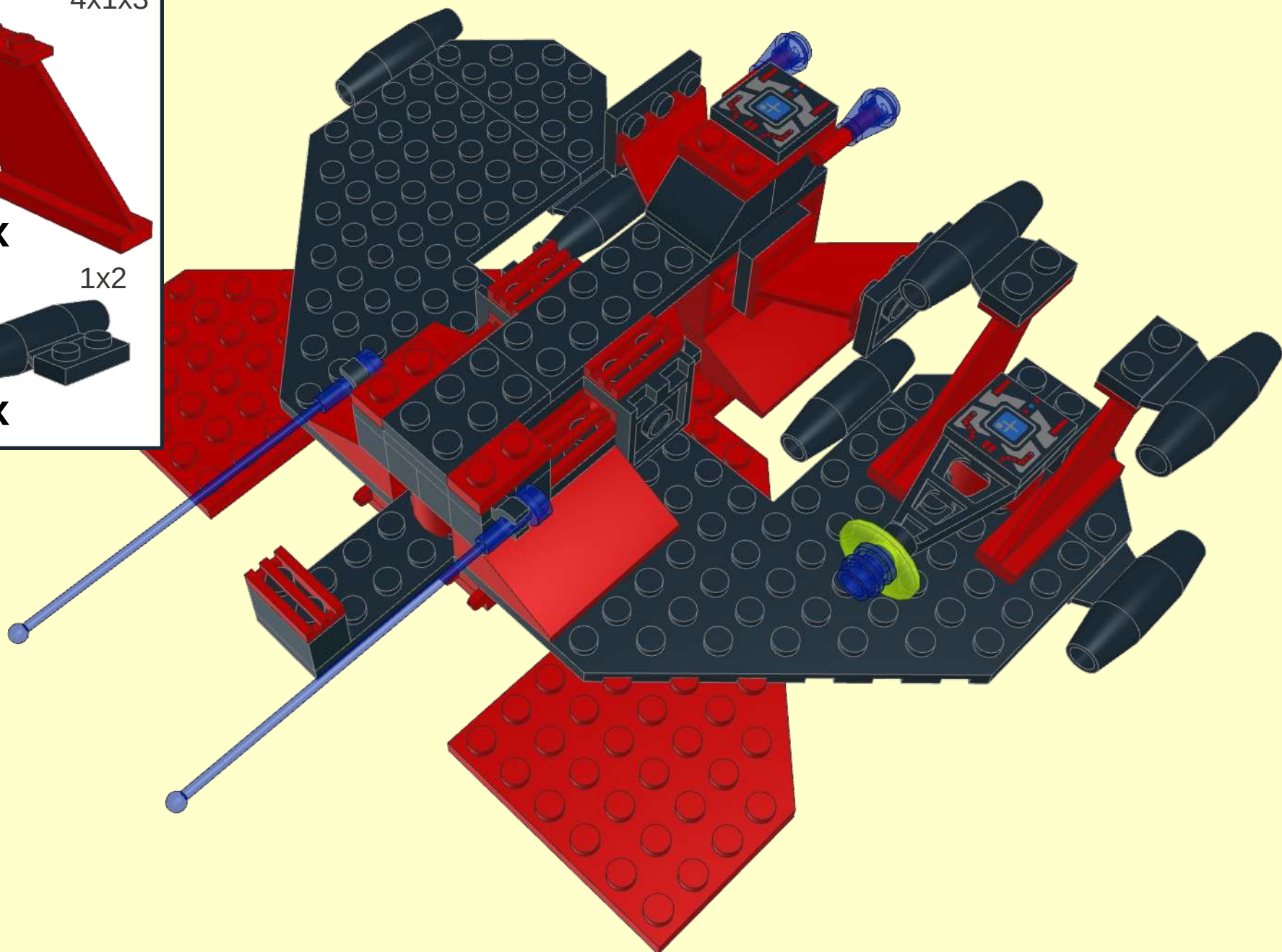

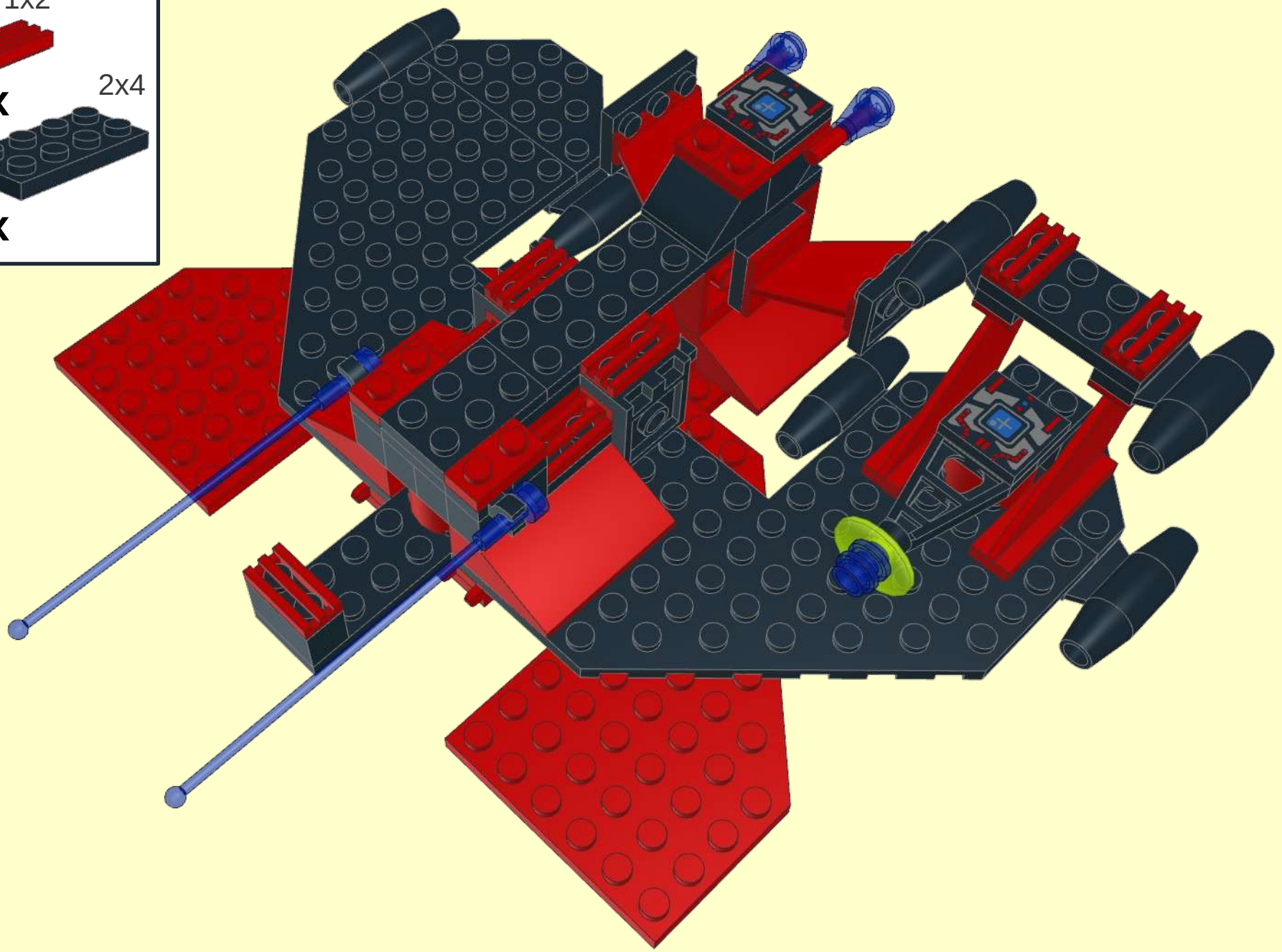
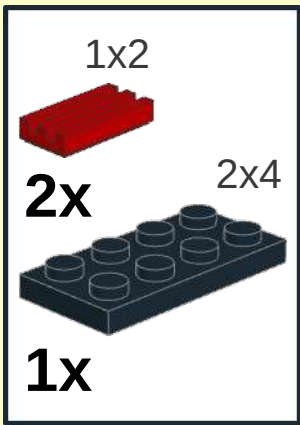

24

1x2
2x
2x4
1x



25

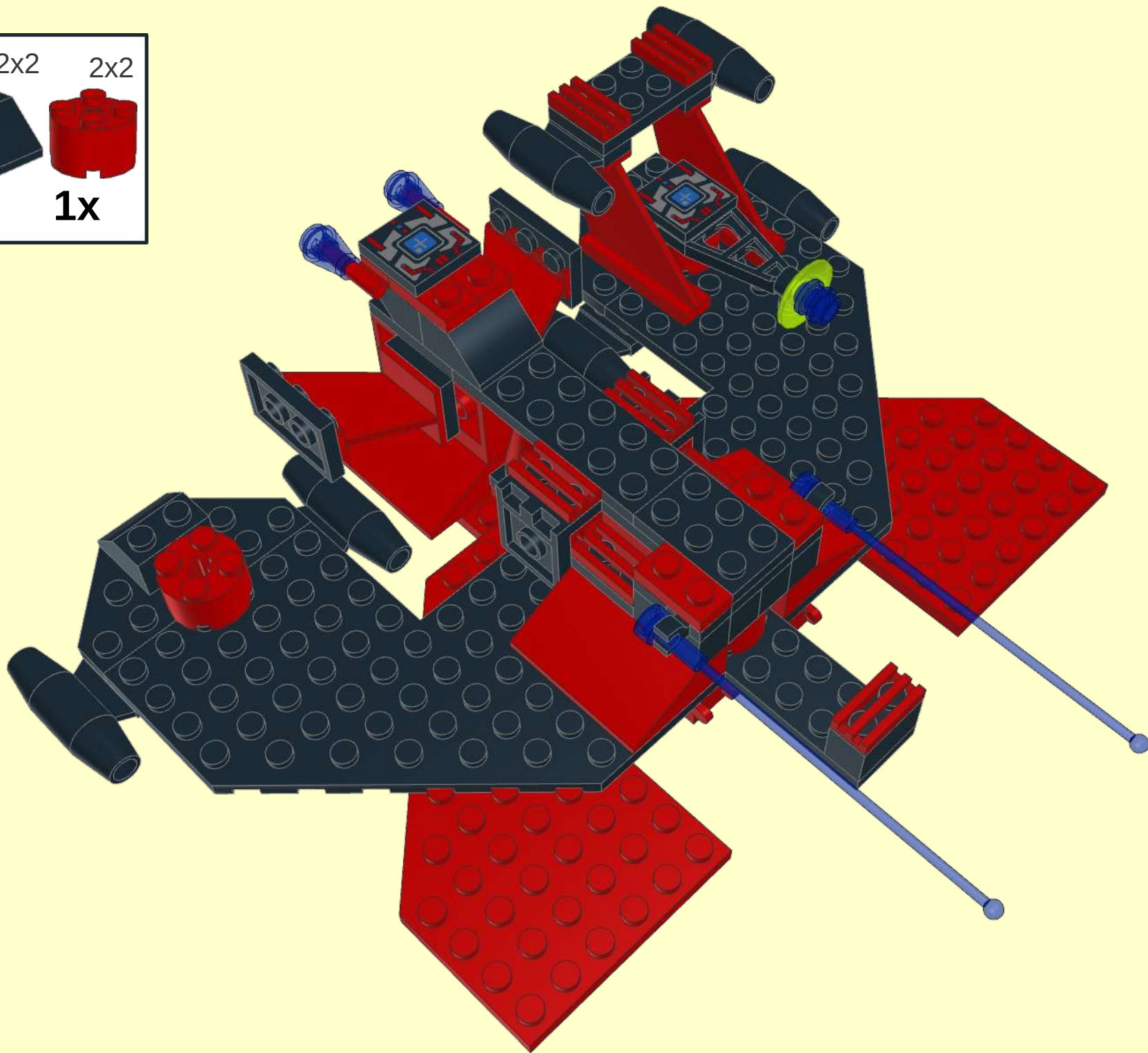

	45x2		2x2
1x		1x	

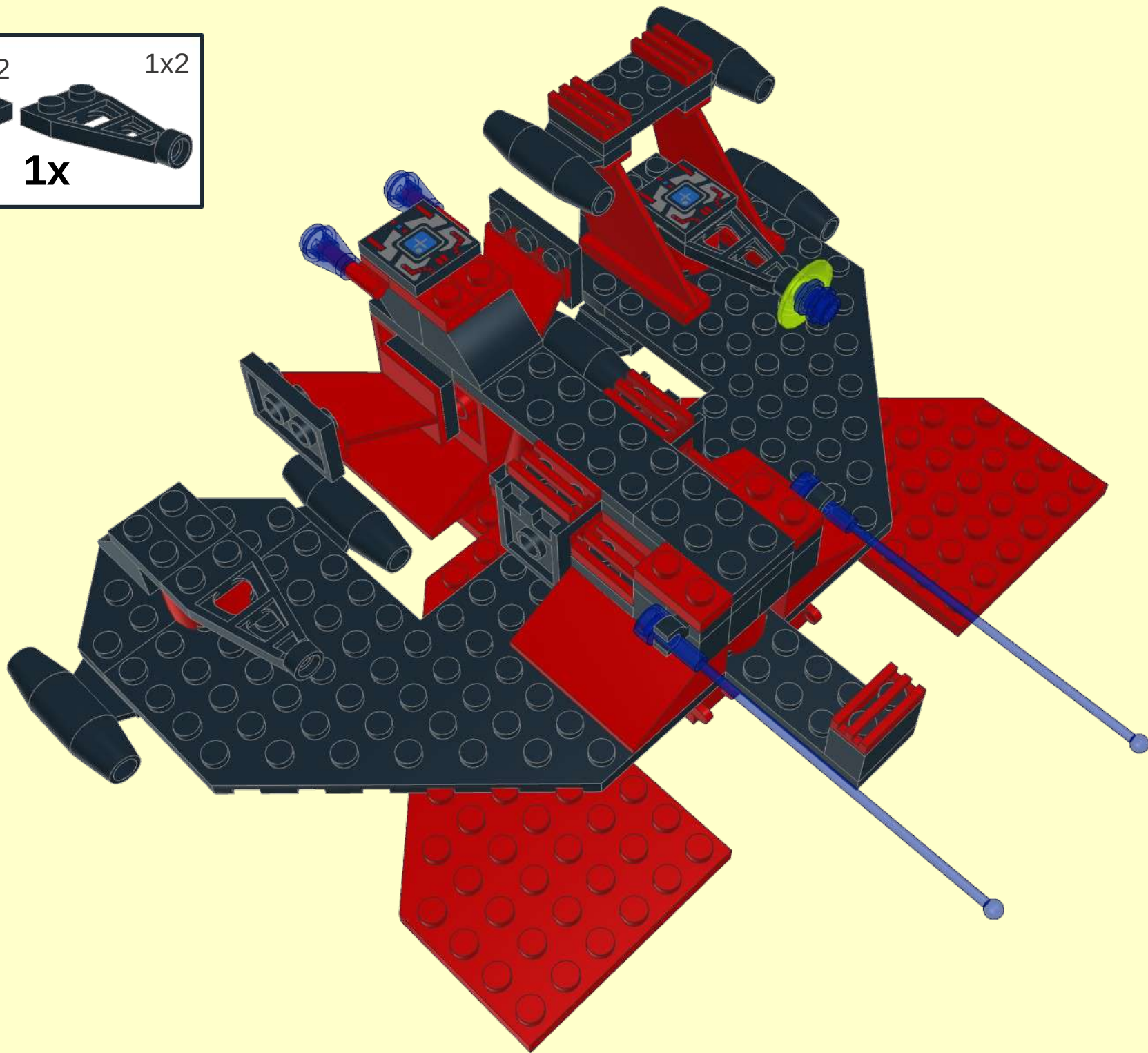
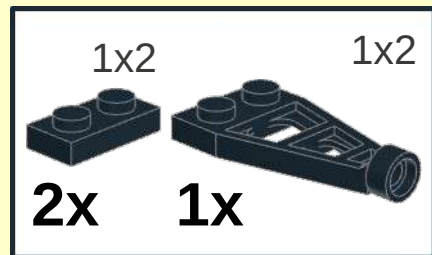

26

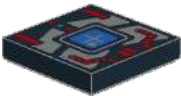

27

	2x2		1x1		2x2
1x		2x		1x	

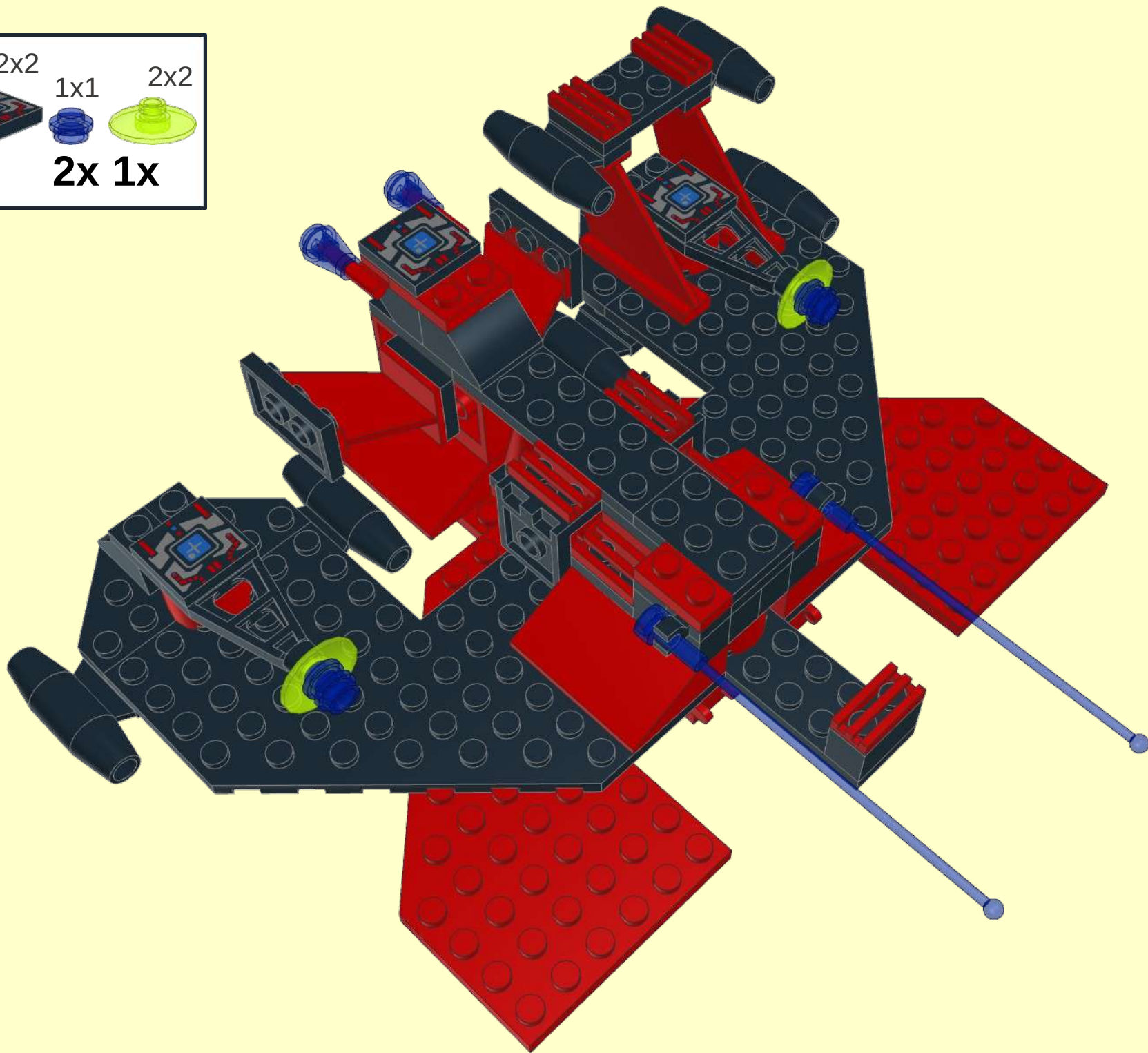

28

4x1x3

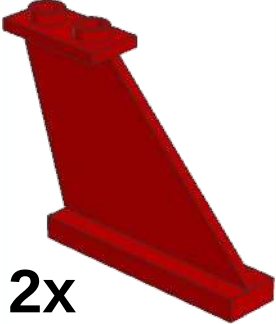

2x

1x2



2x

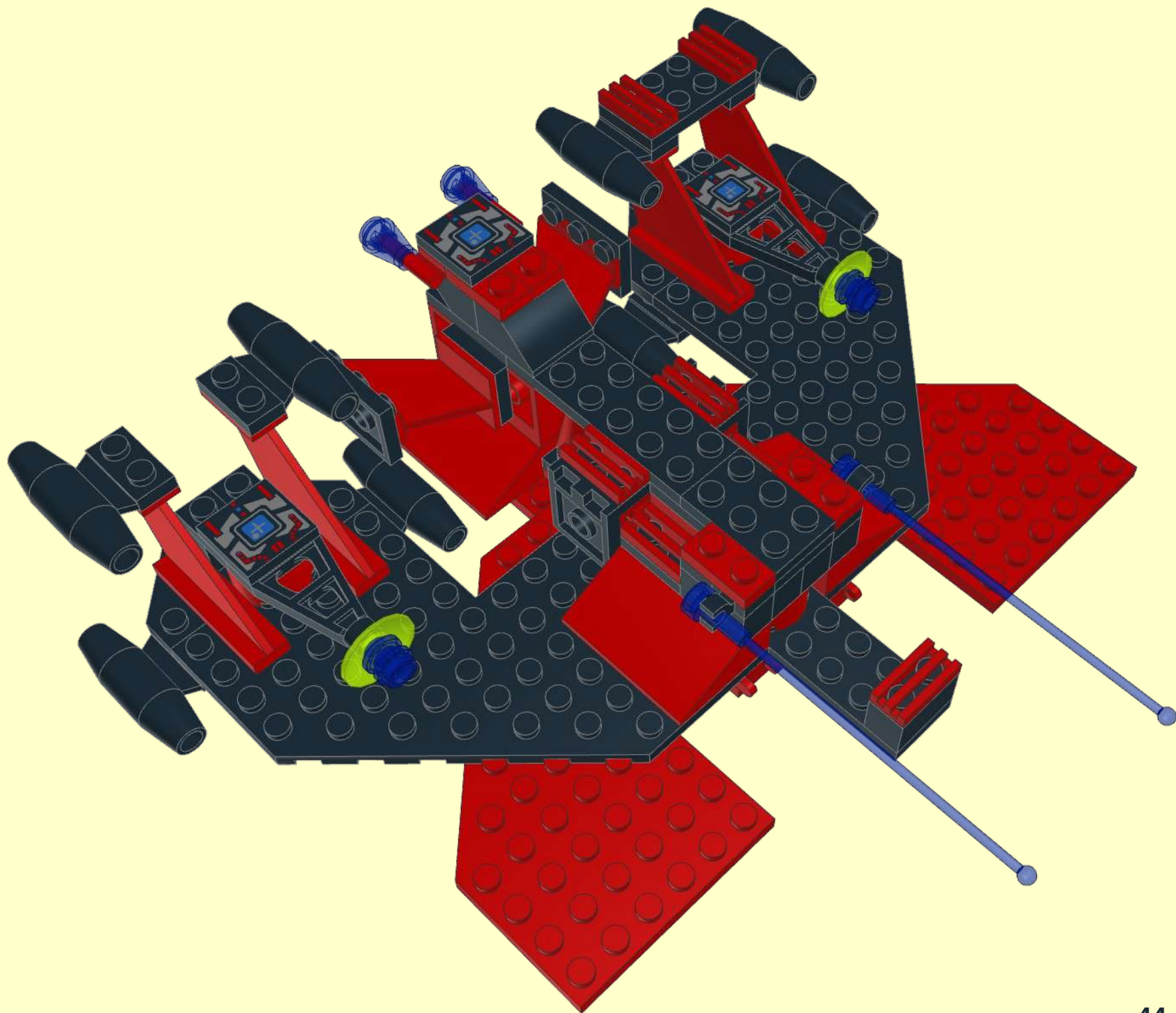

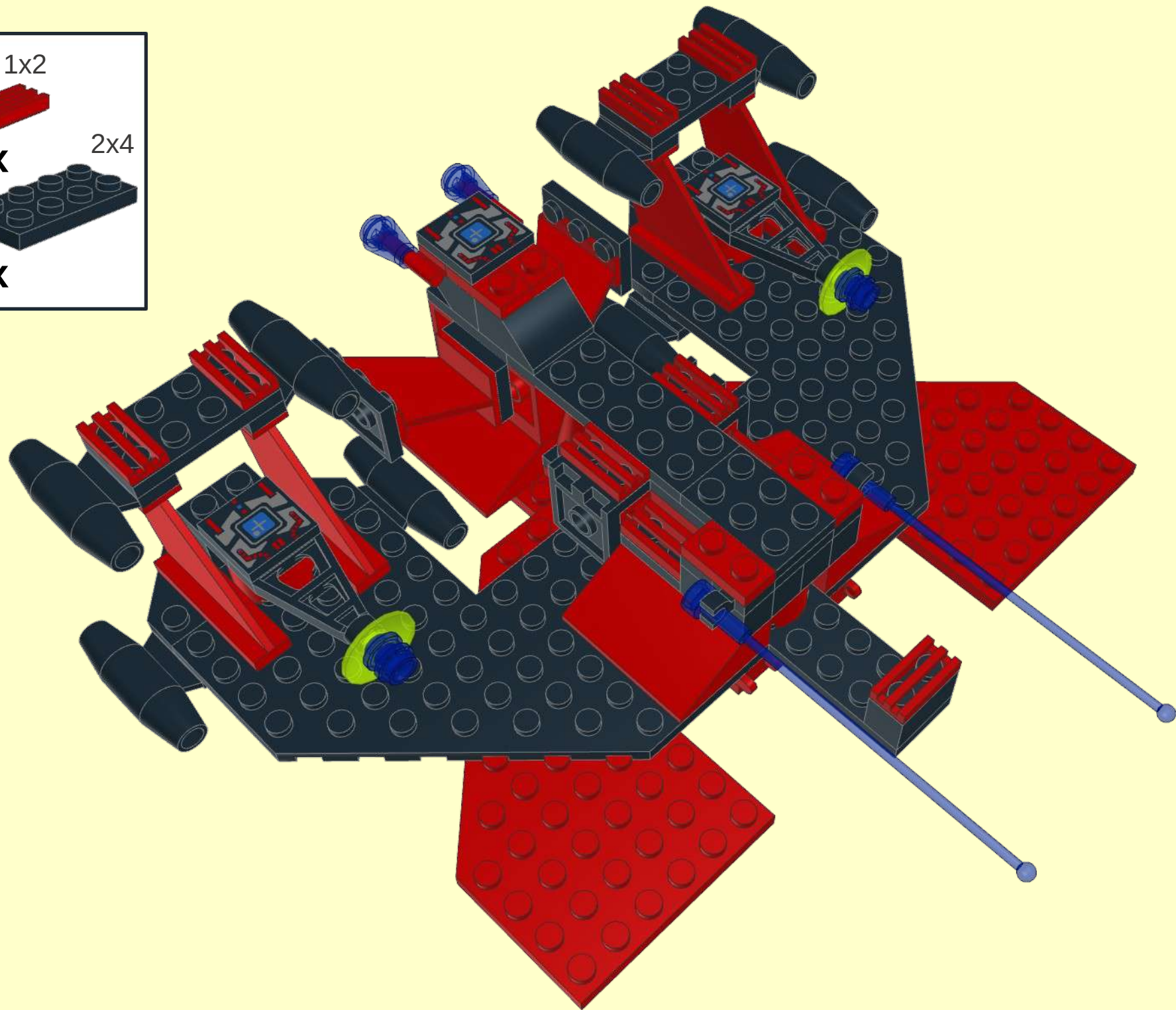

29

1x2
2x
2x4
1x



30

		
2x2	452x2	2x2
1x	1x	2x

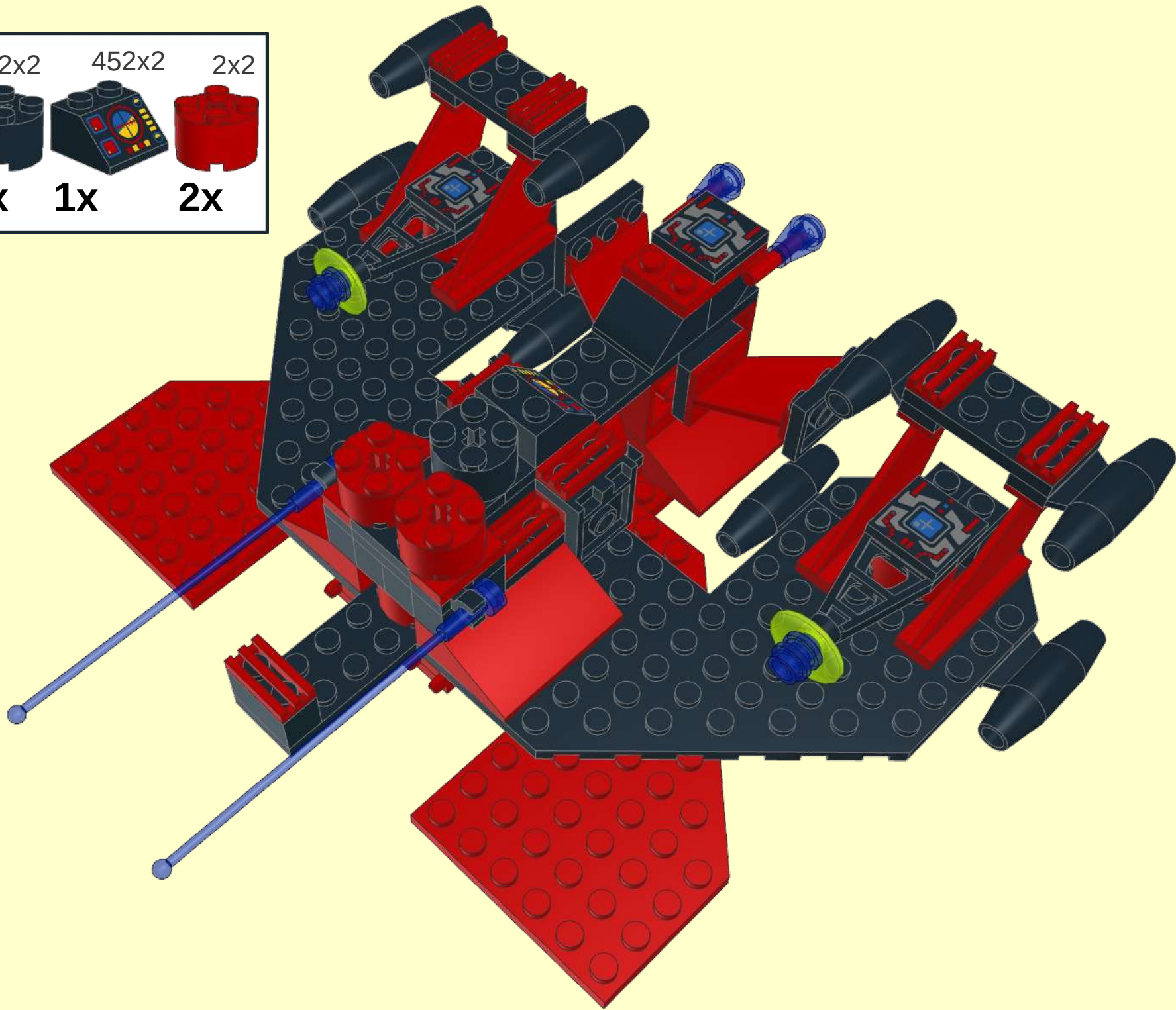

31

	1x4
2x	1x4
1x	

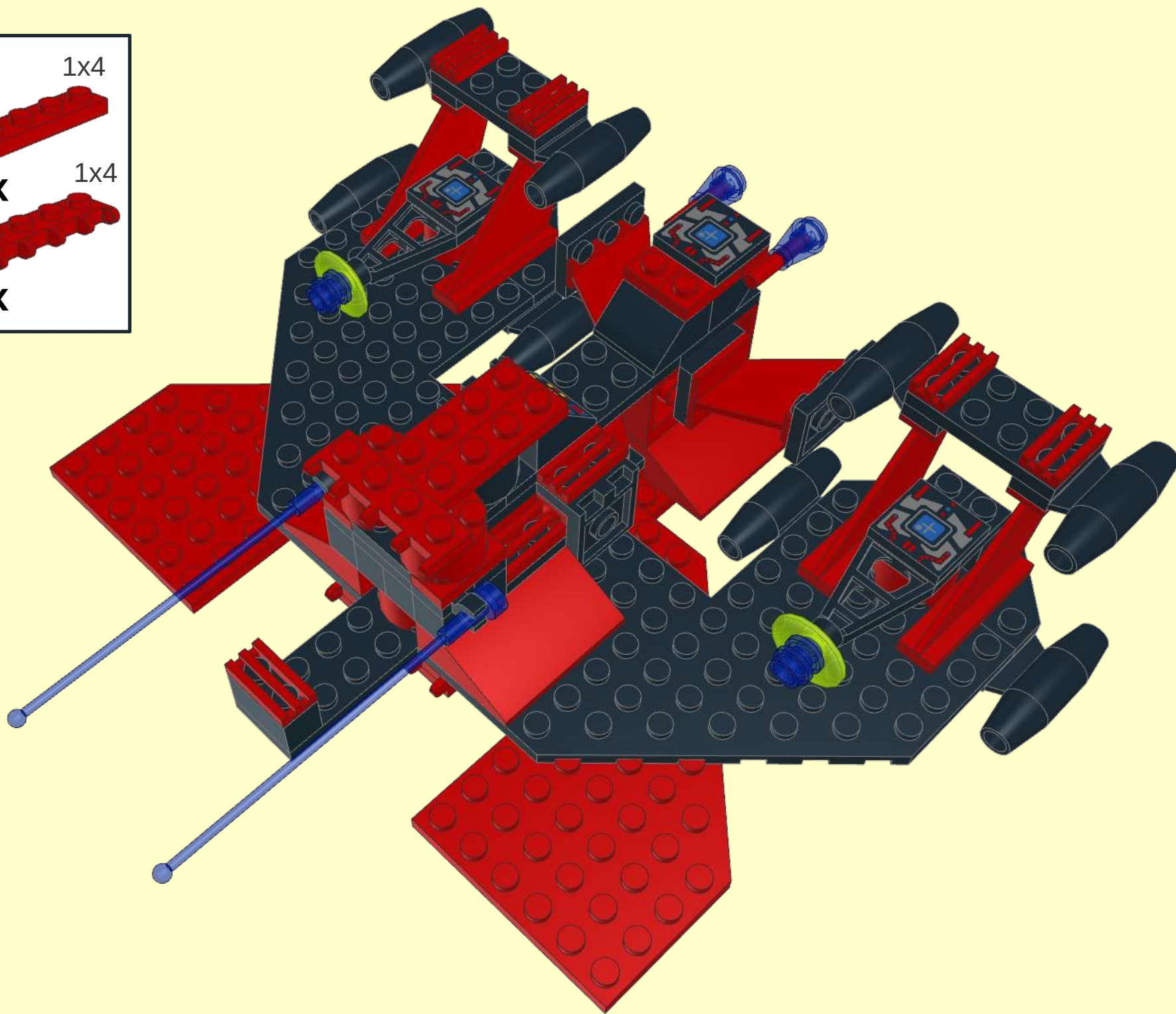

32

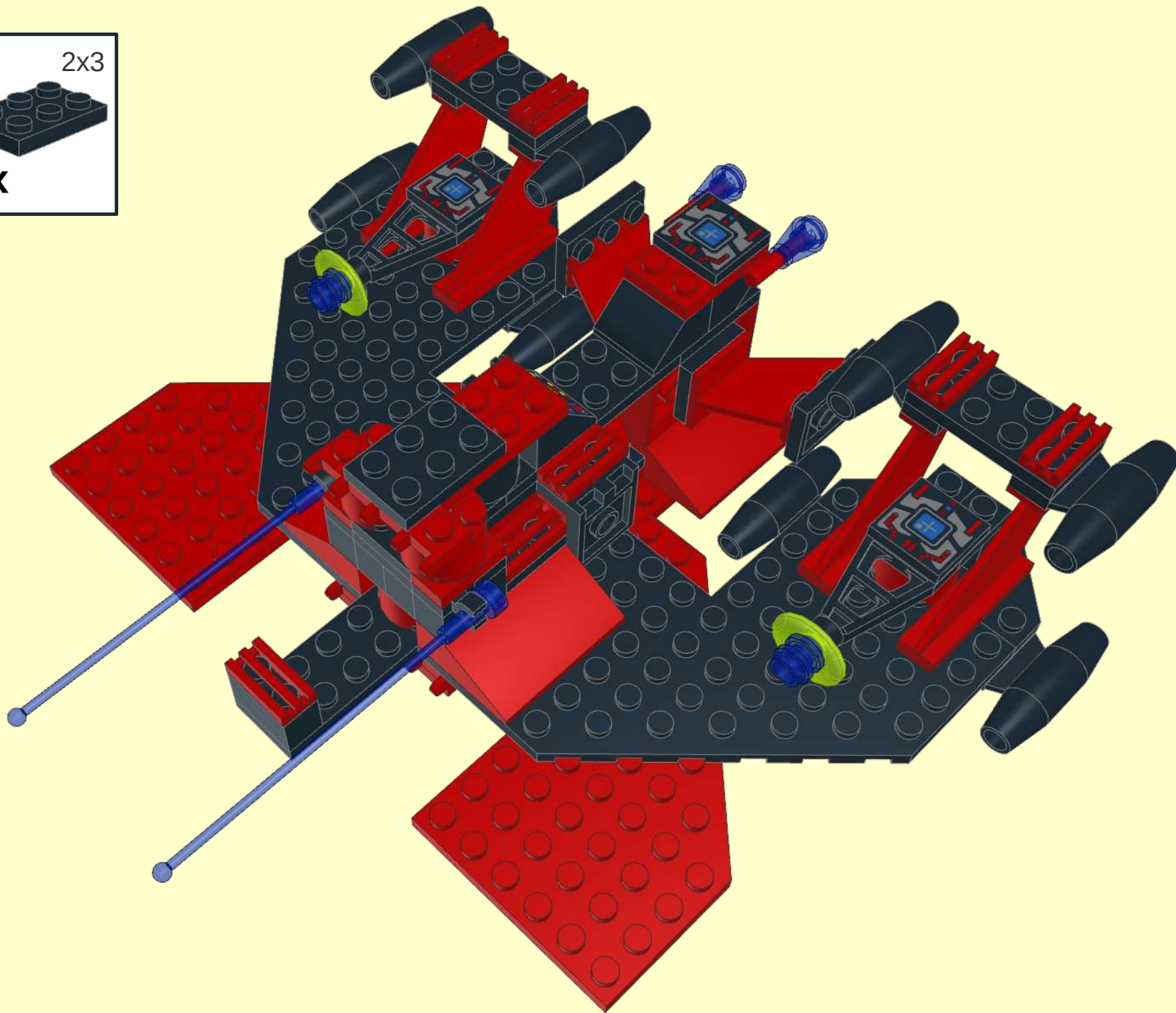

33

10x4x2

