

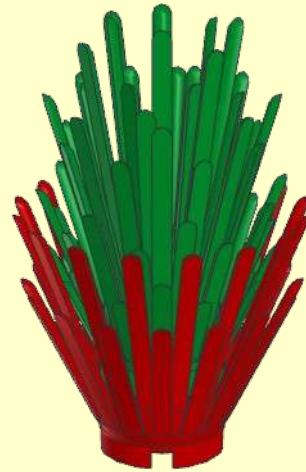

1x	1x
1x	1x
2x	
1x	1x
1x	1x

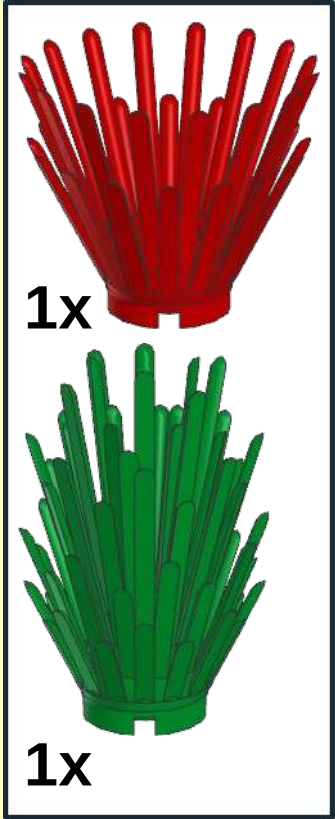

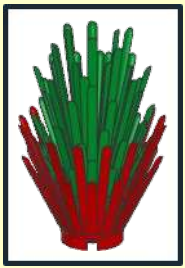



1

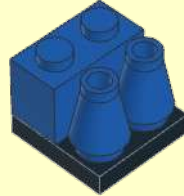
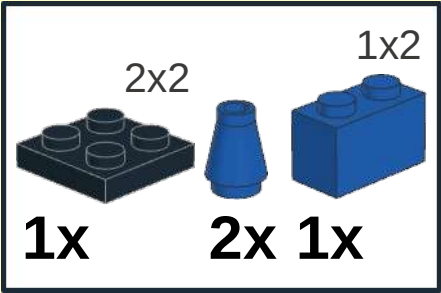

2

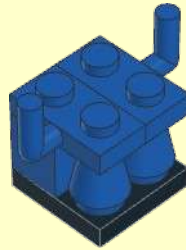
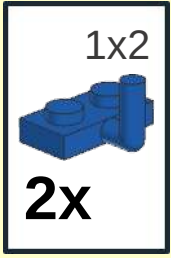

3

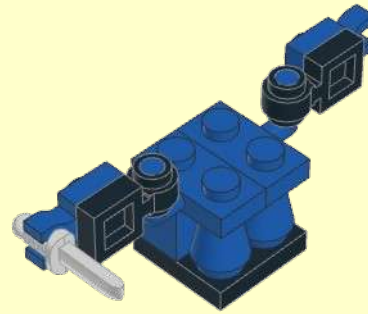
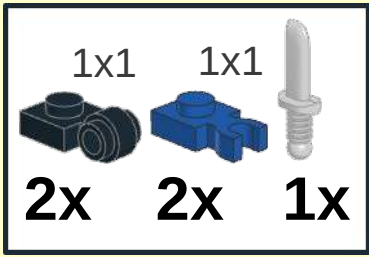

4

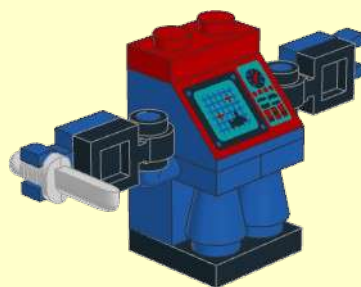
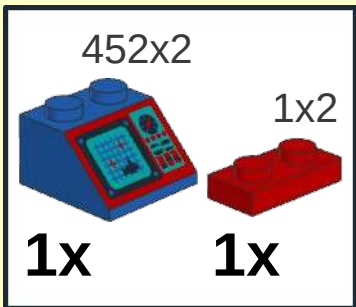

1

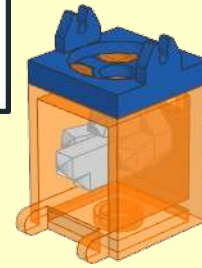
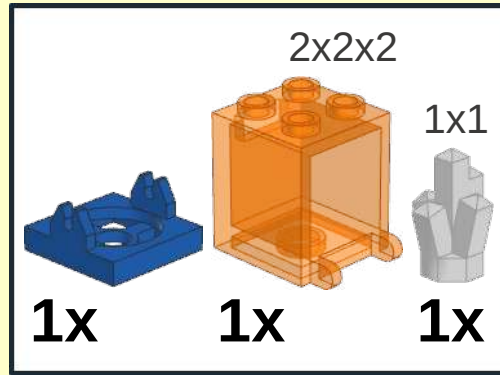



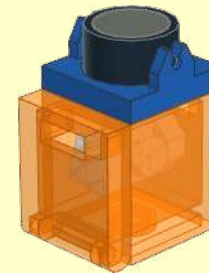
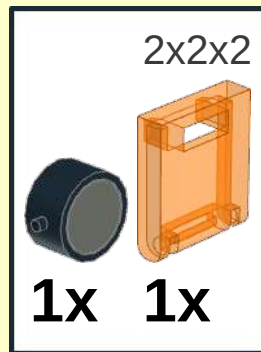

2

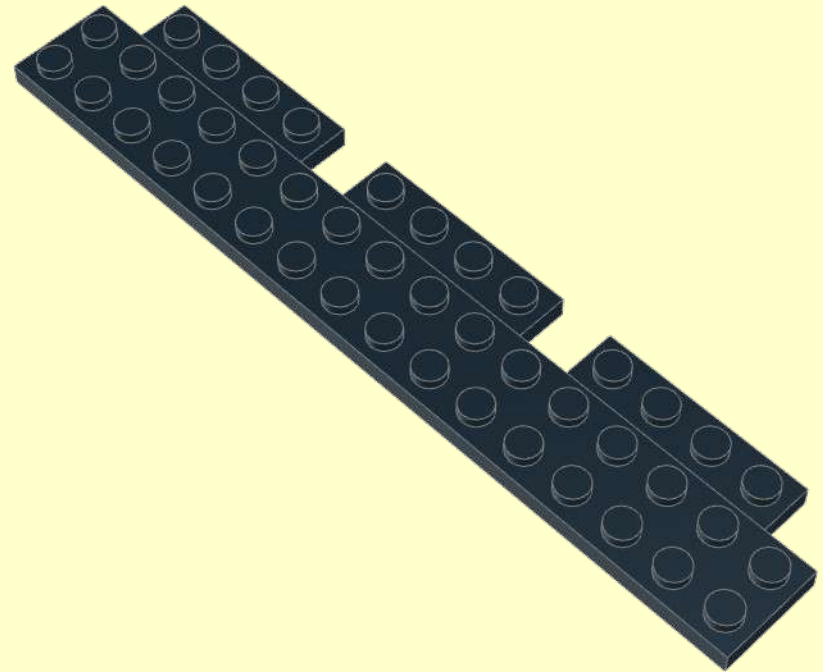
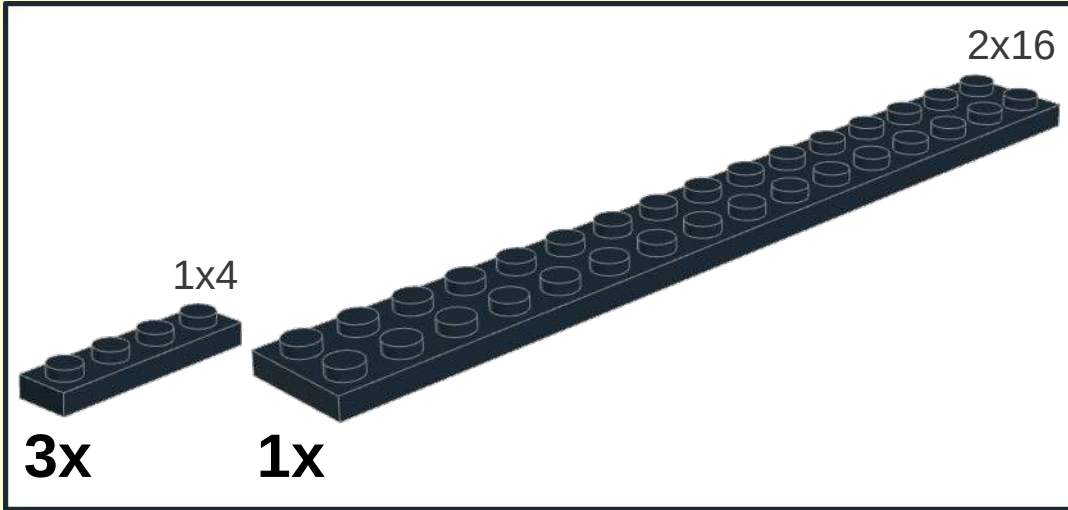

1



2

- 1x3 
- 2x 
- 1x1 
- 2x 1x3 
- 2x 

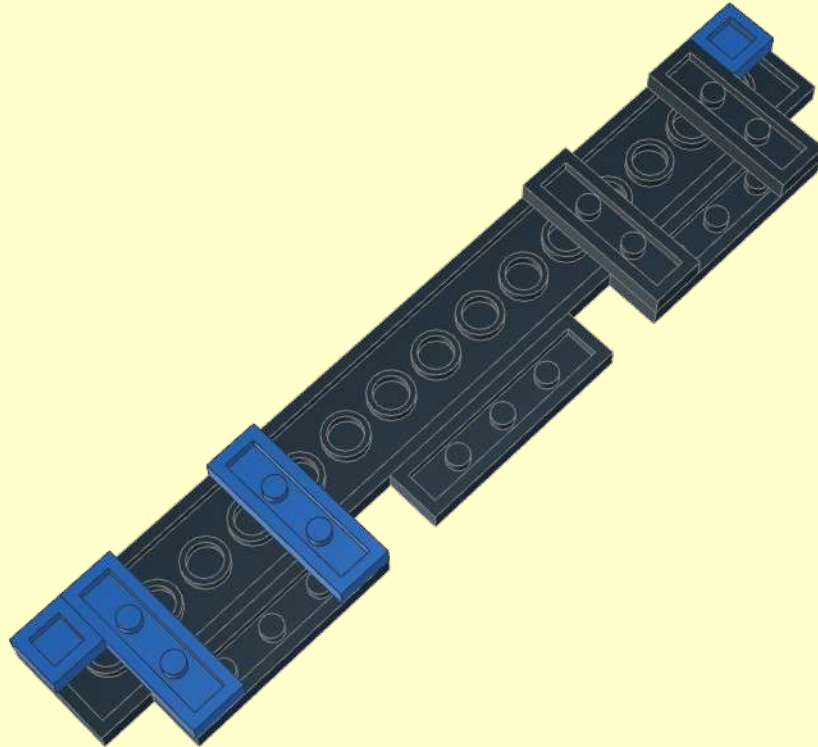

3

2x4

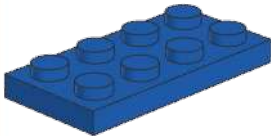

1x

4x4



1x

4x4

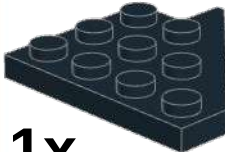

1x

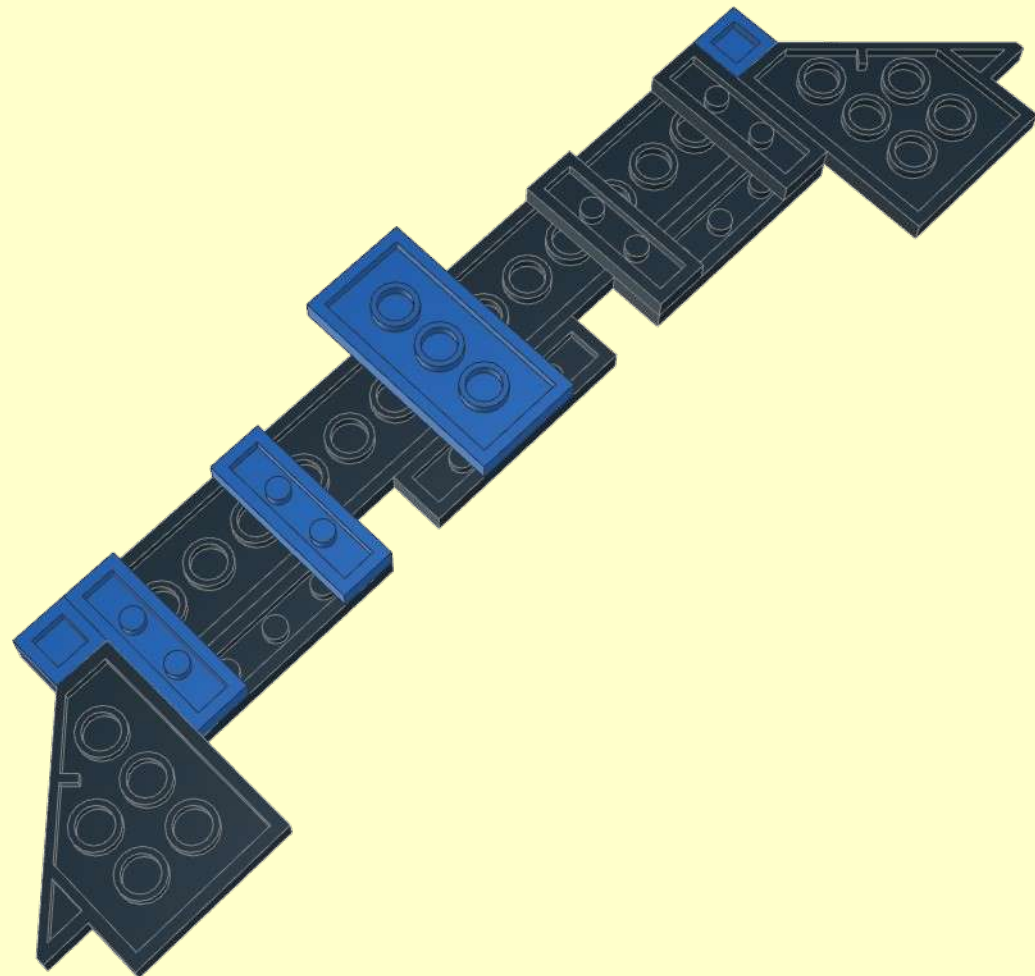

4

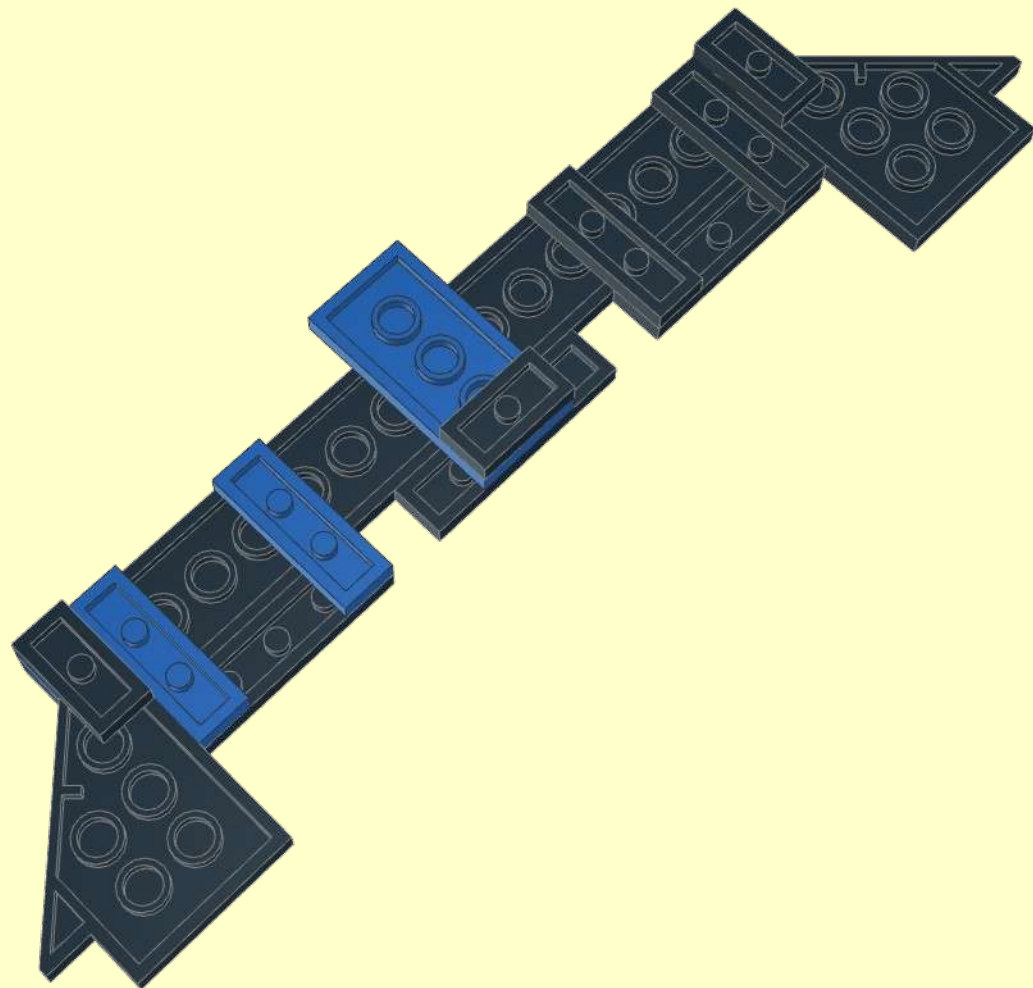
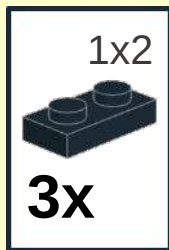

5

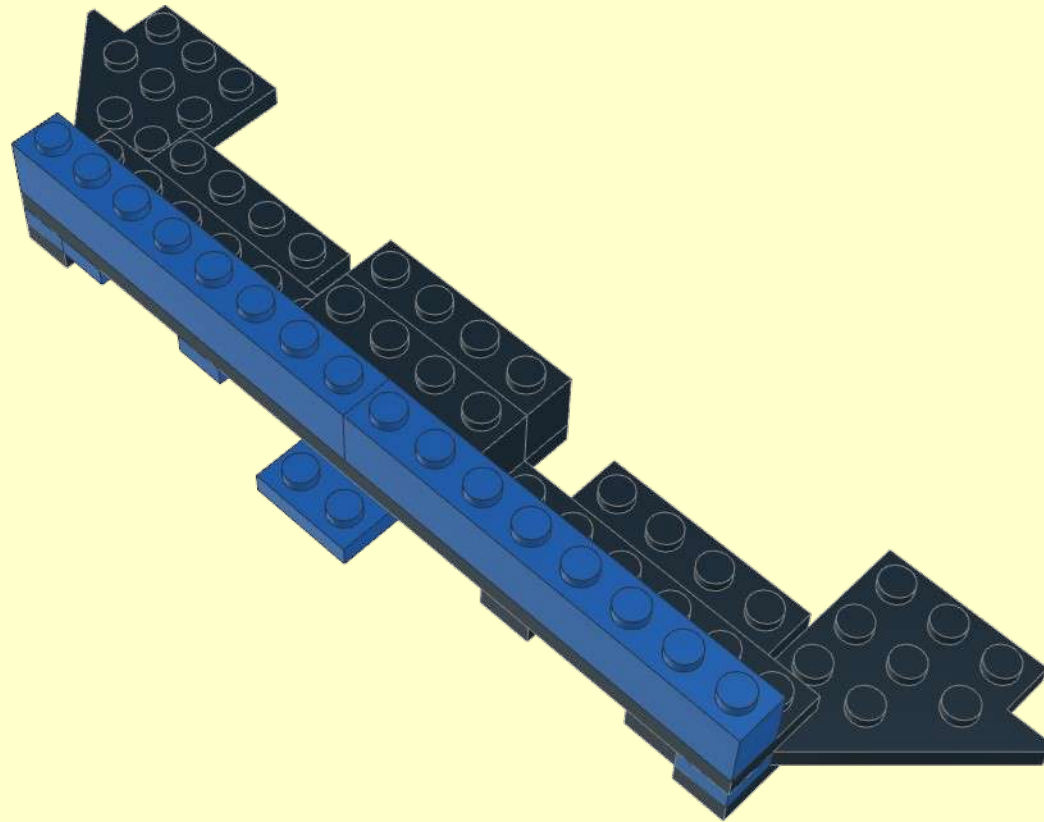
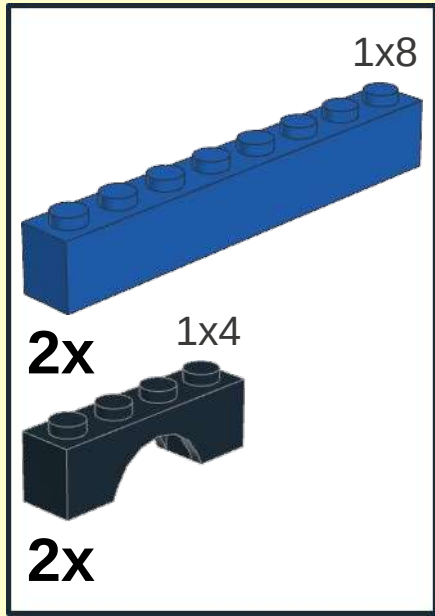

6

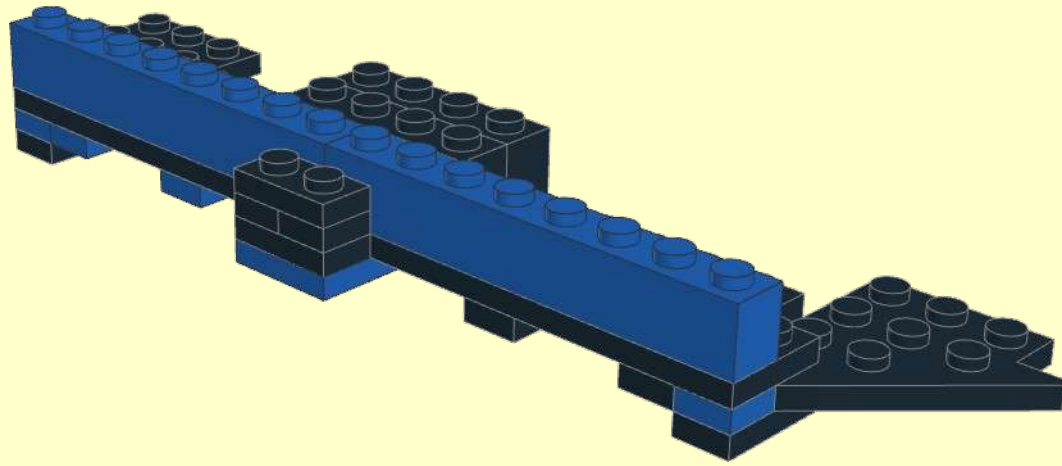
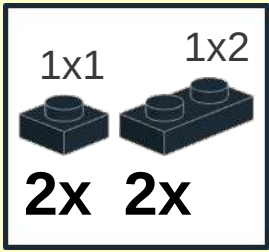

7

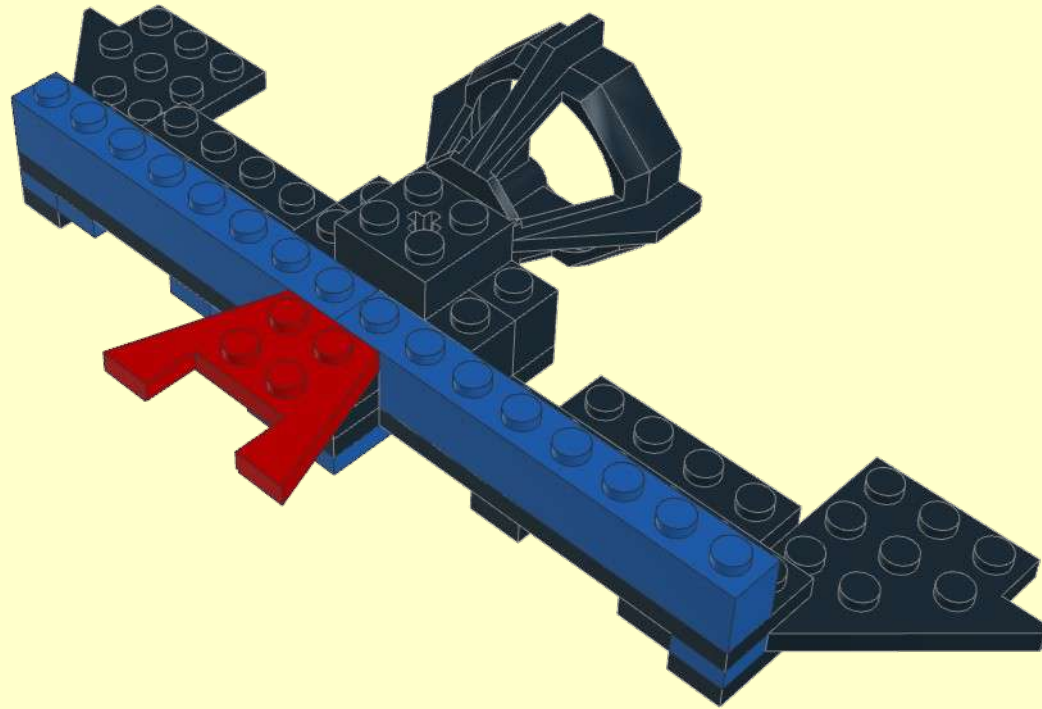
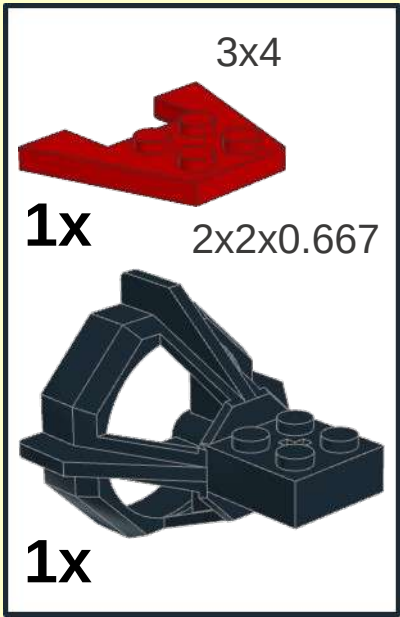

8

3B

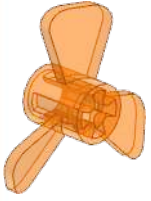

1x



1x

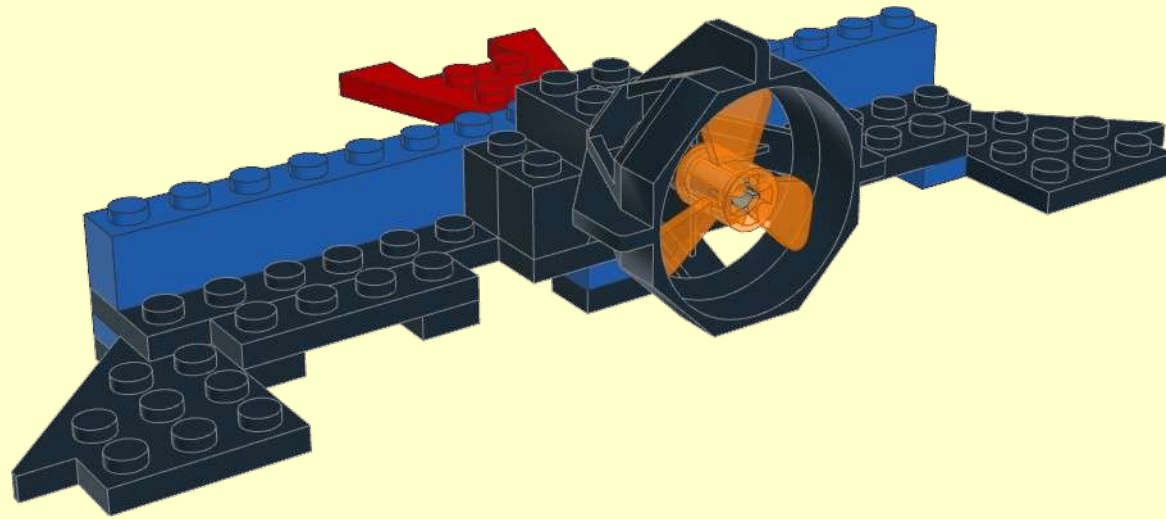

9

2x5x3.667



1x

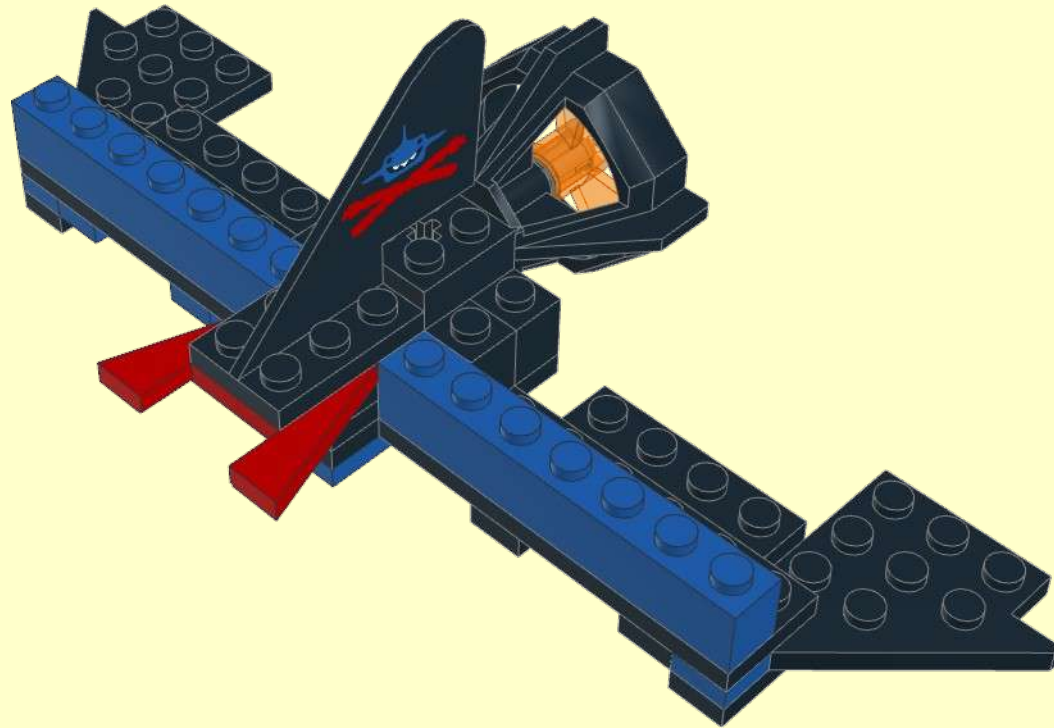

10

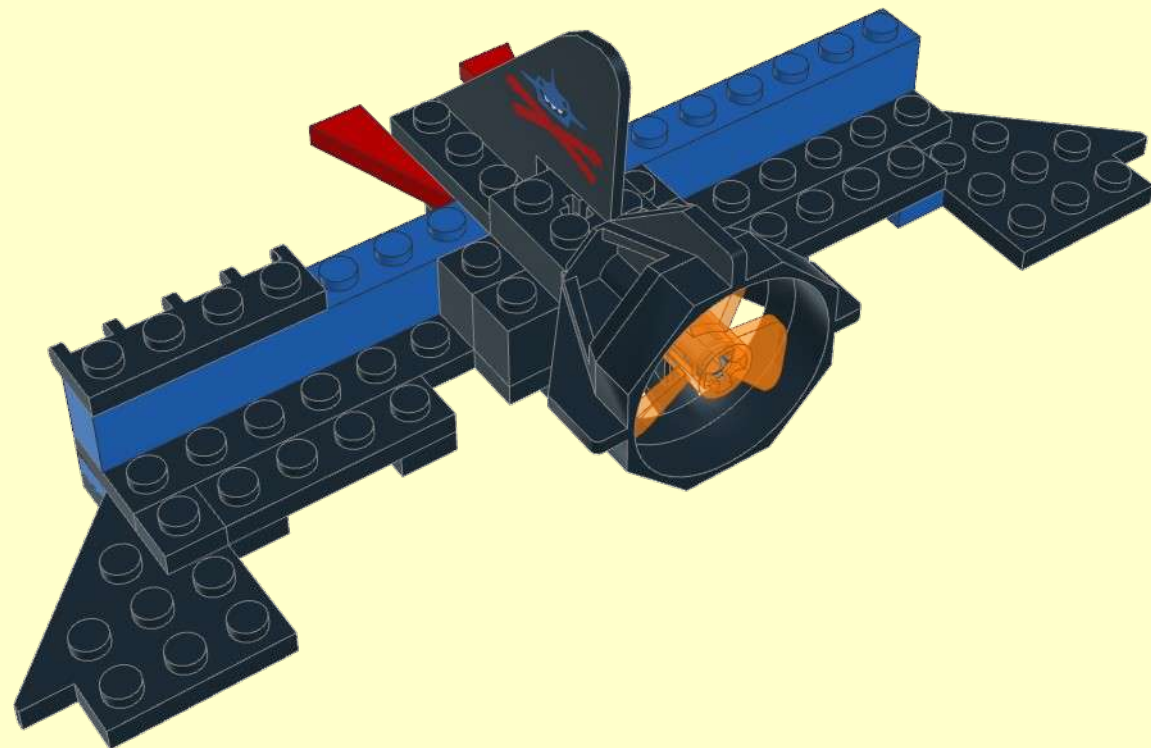
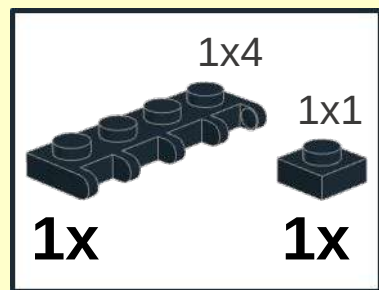

11

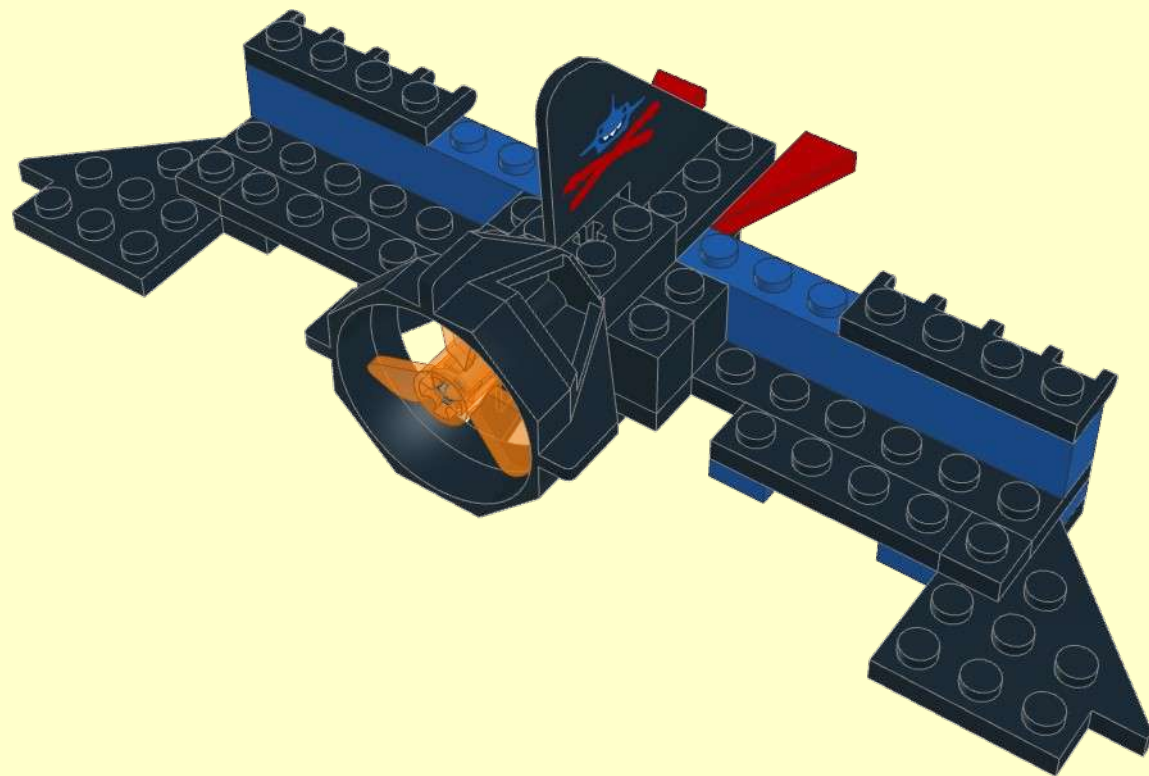
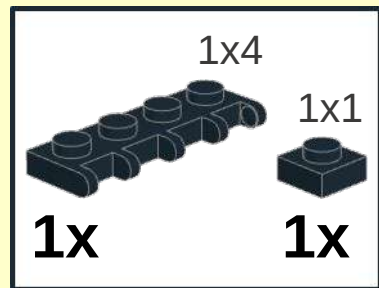

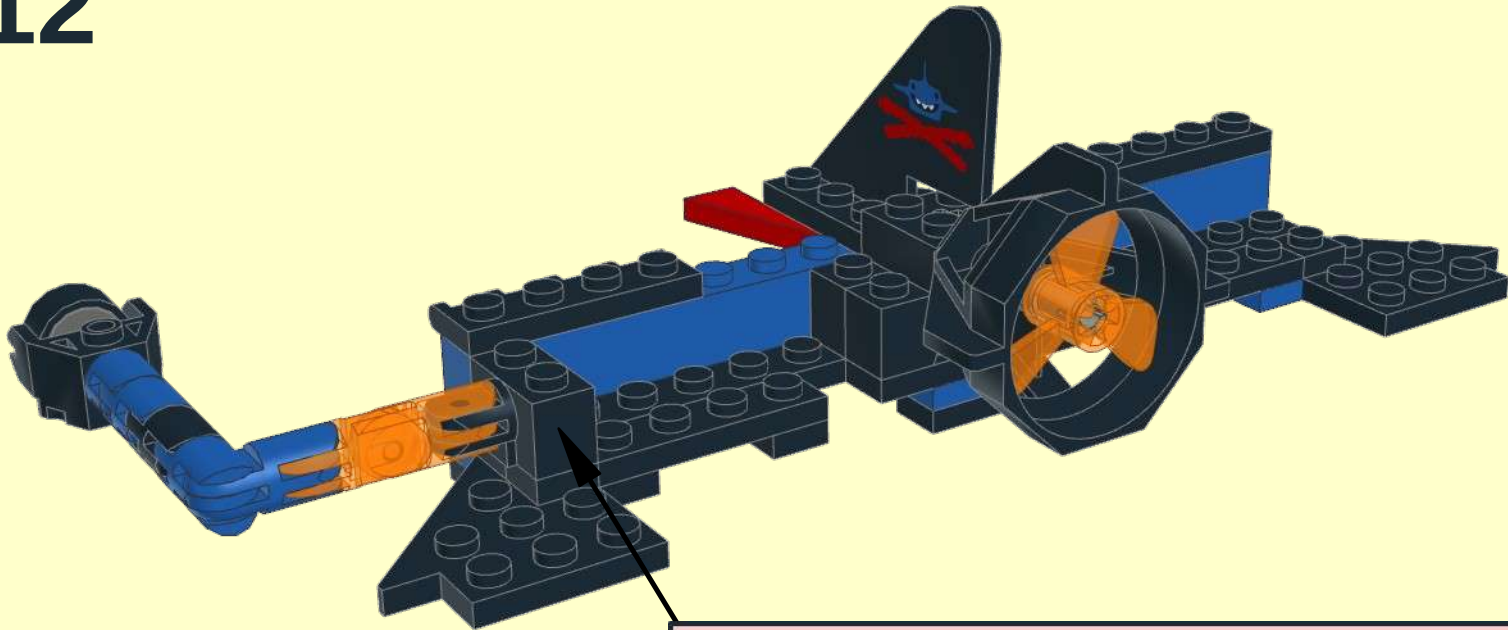

1

1x2

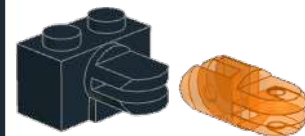

1x **2x**

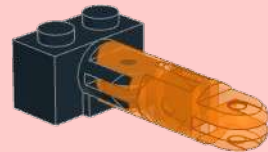

2



1x

1x **3x**

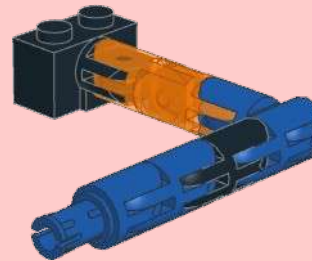

3



1x **1x**

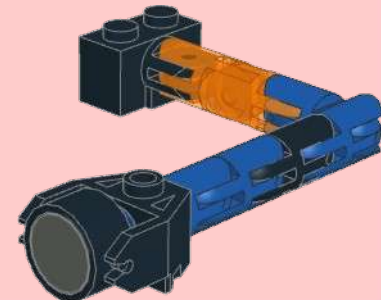

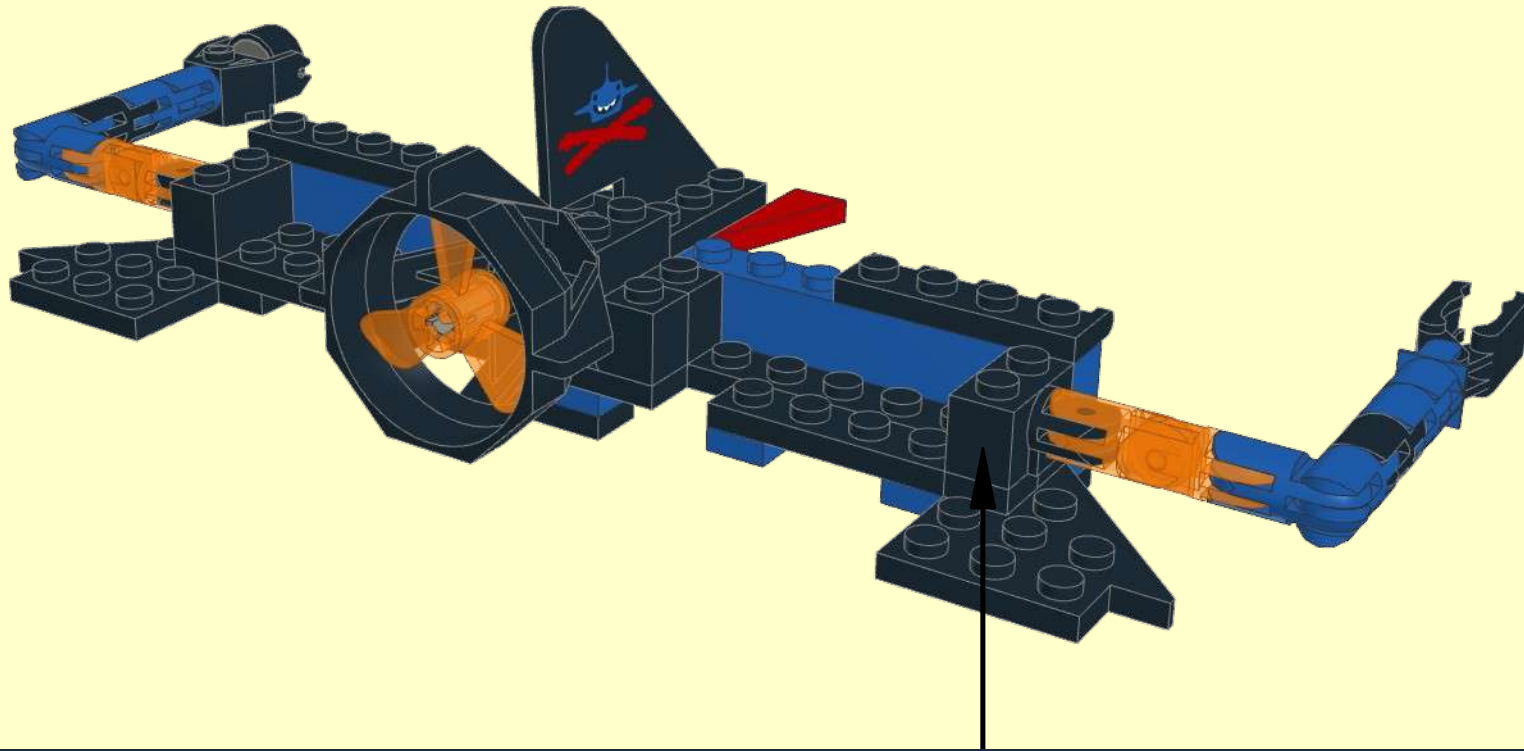

1

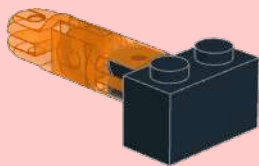
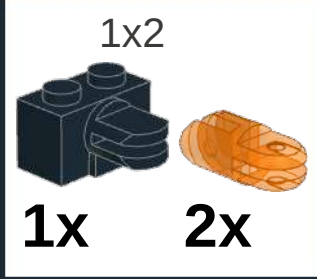

2

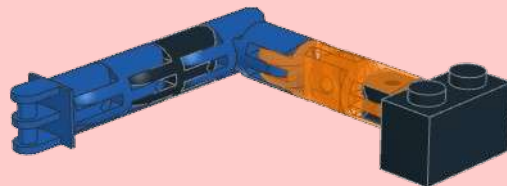

3

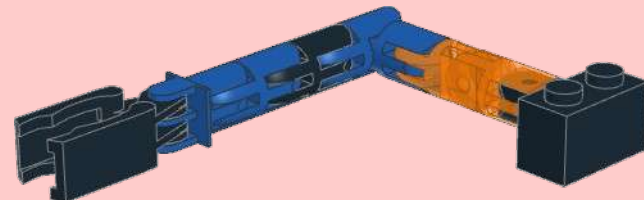

14

10x4x2



1x

10x4x2

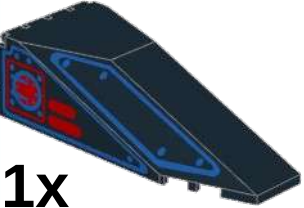

1x

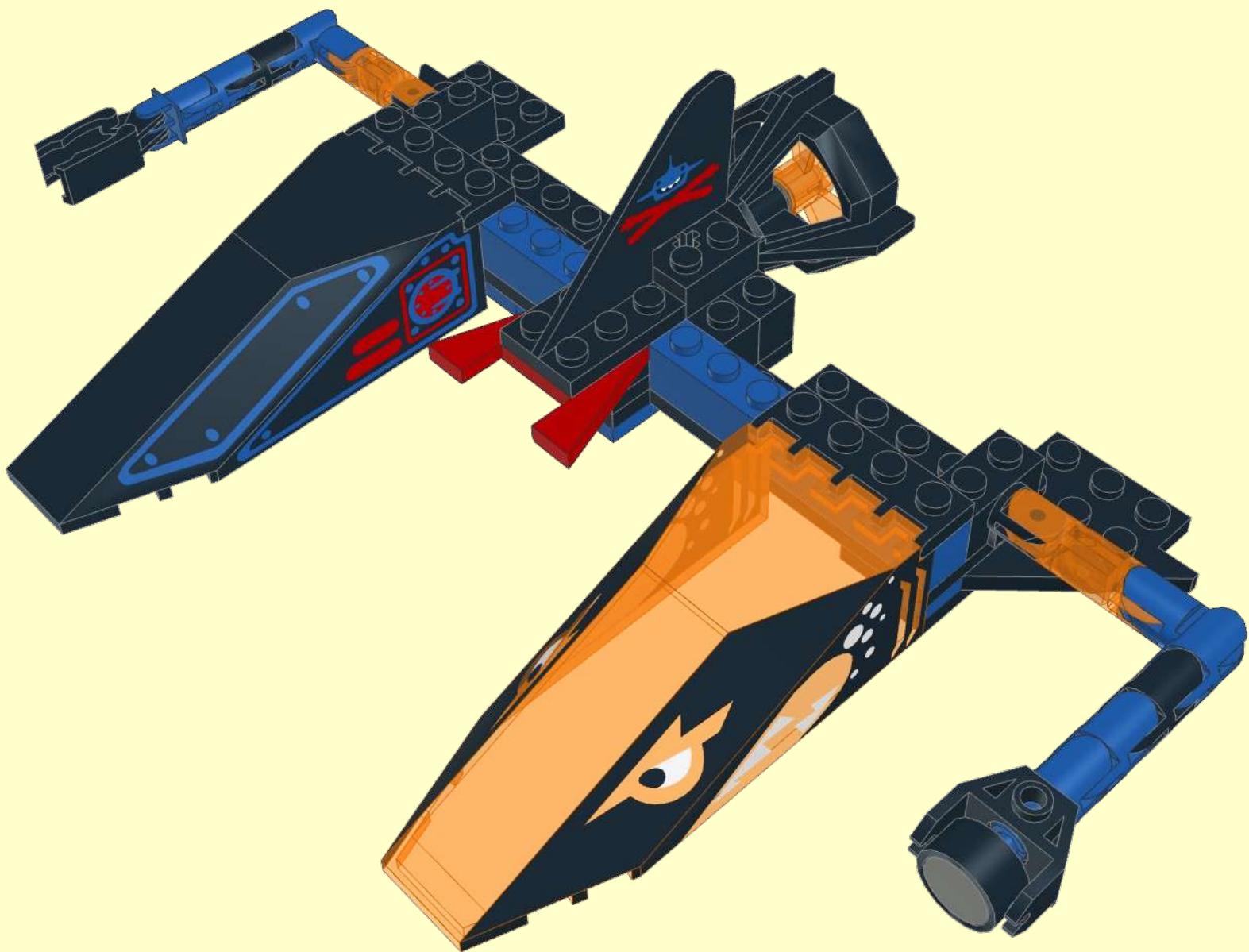

5

