

6929 - Surveyor  
Alternate Build  
Design and Instructions  
by DrewG (2021)

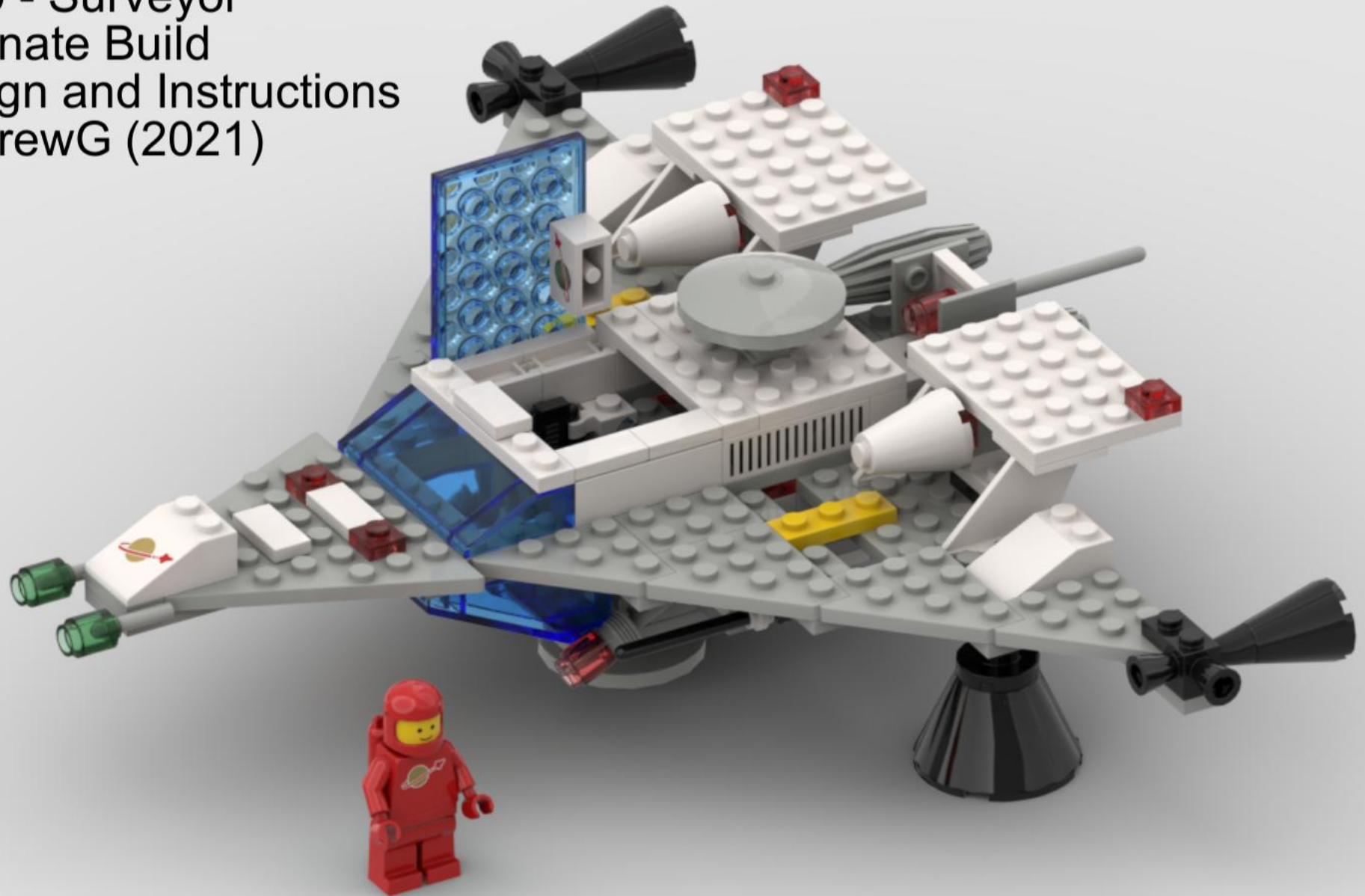

Please give credit when modifying these instructions  
and don't sell the design or instructions

1

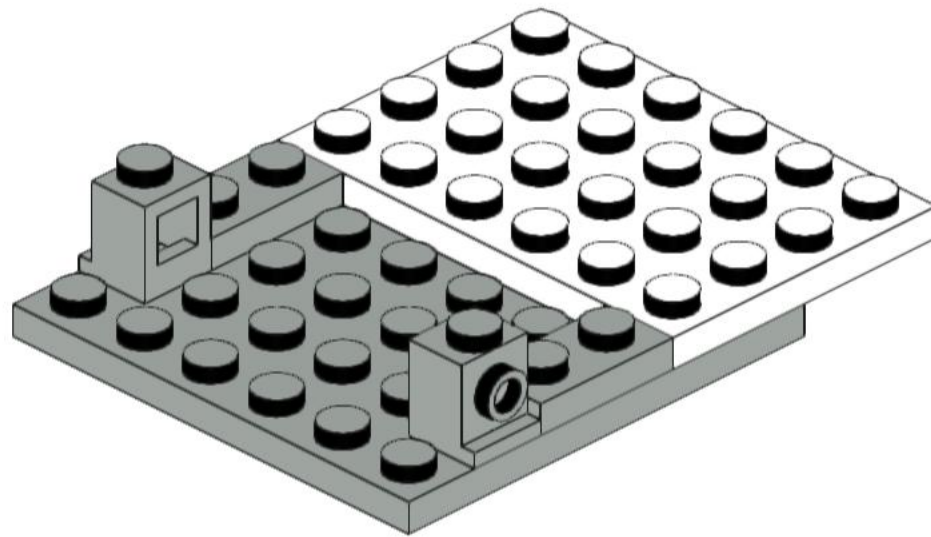
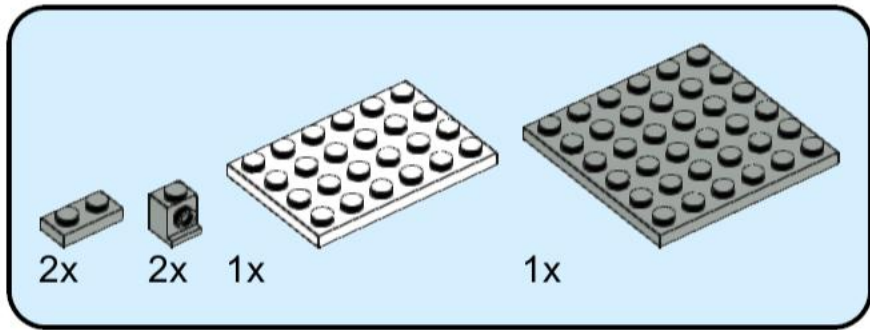

2

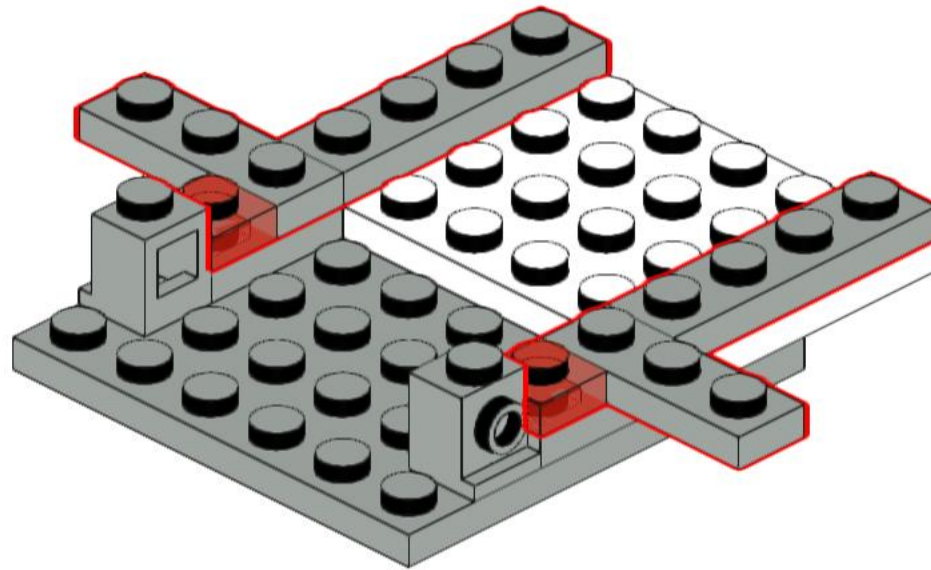
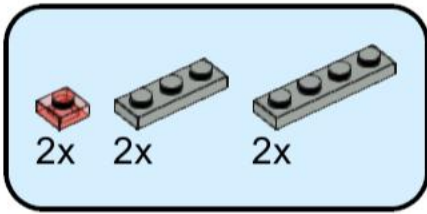

3

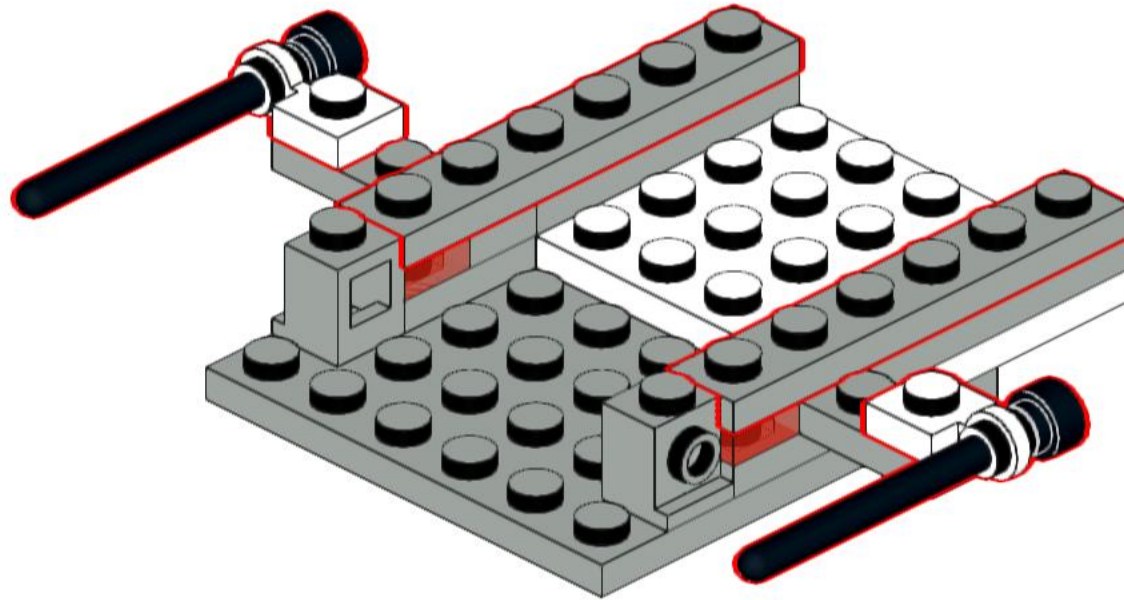
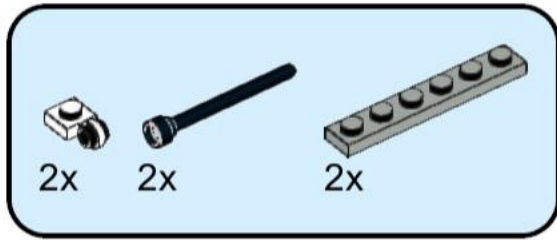

4

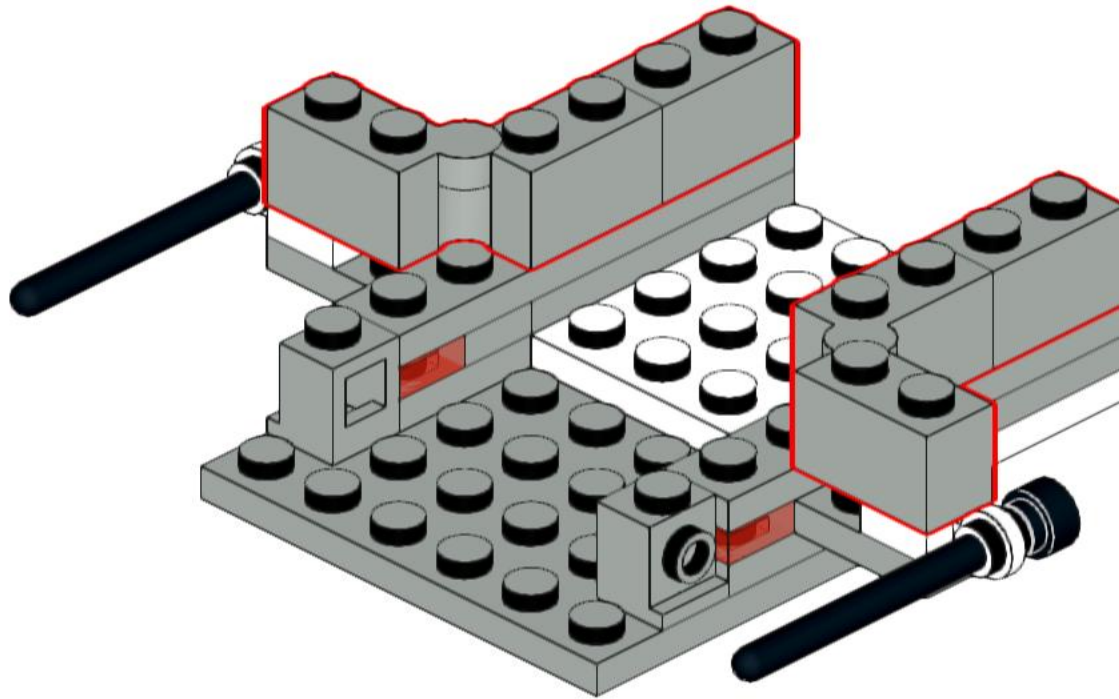
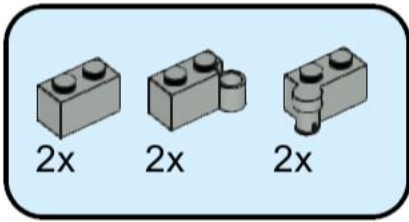

5

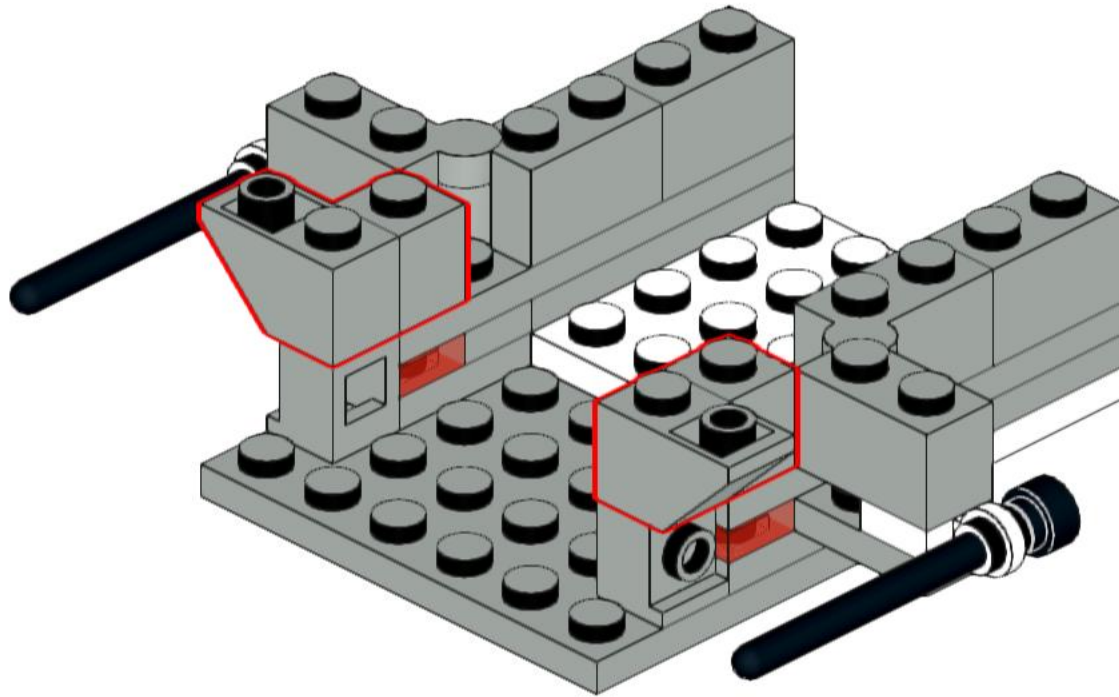
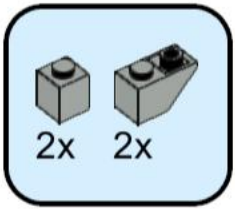



6

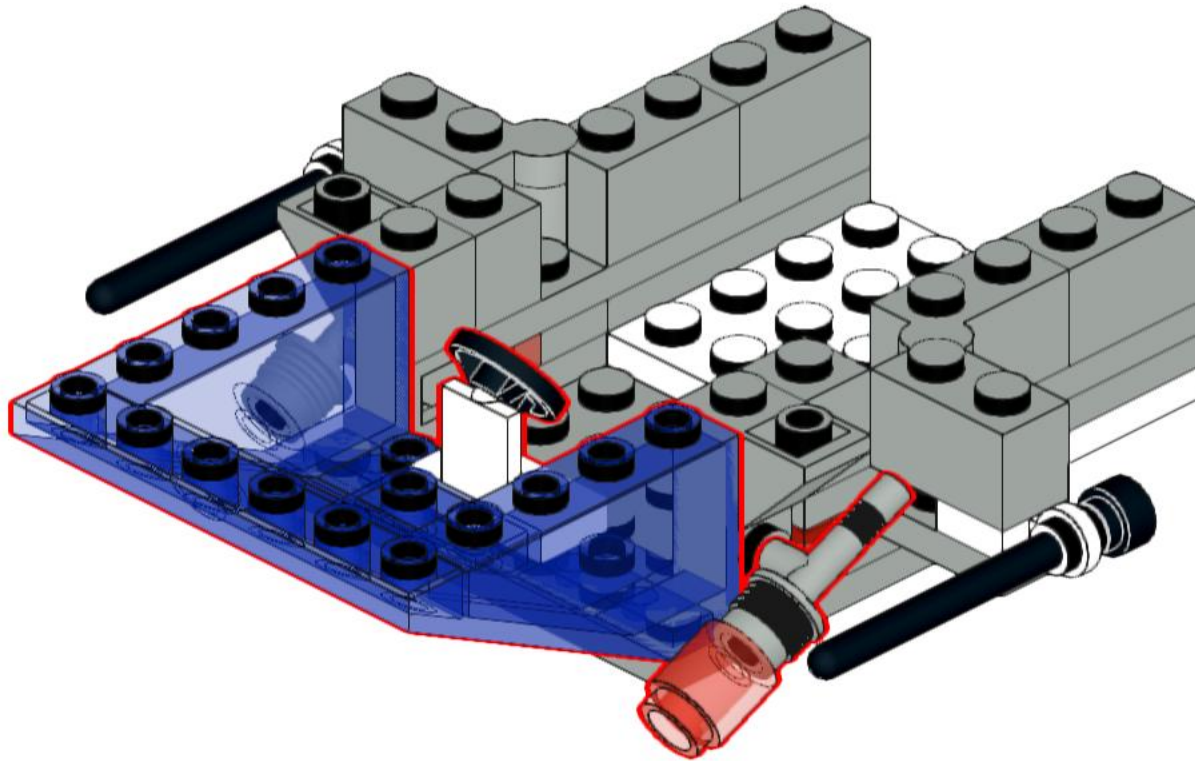
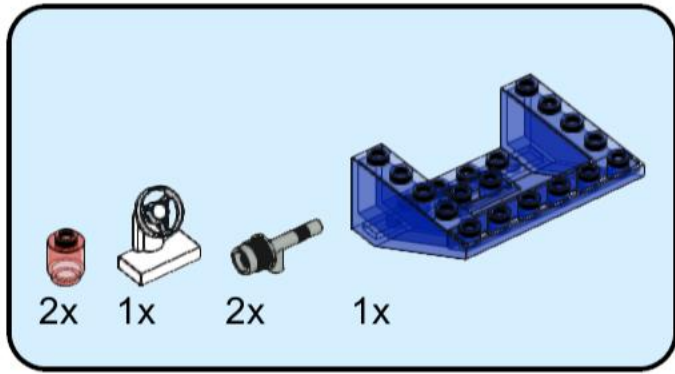

7

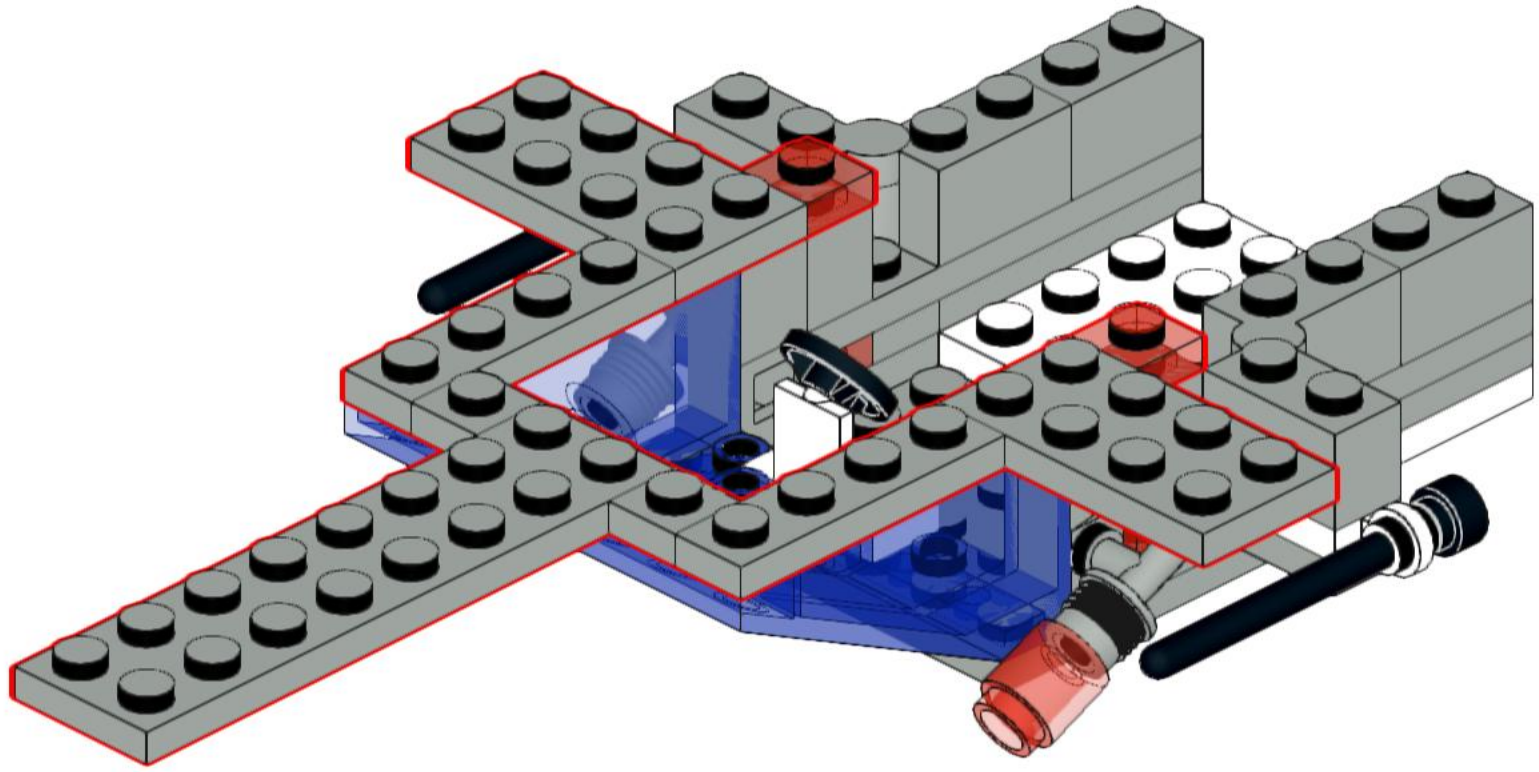
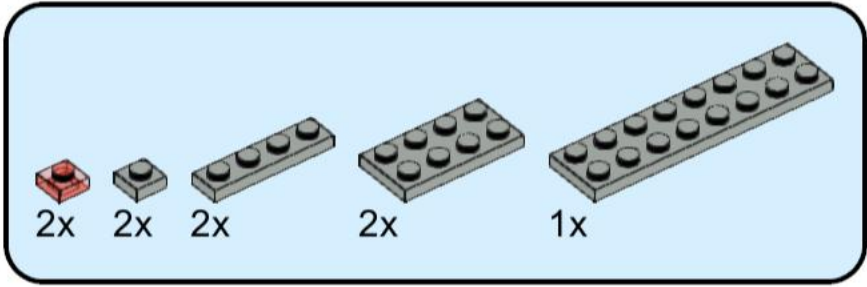



8

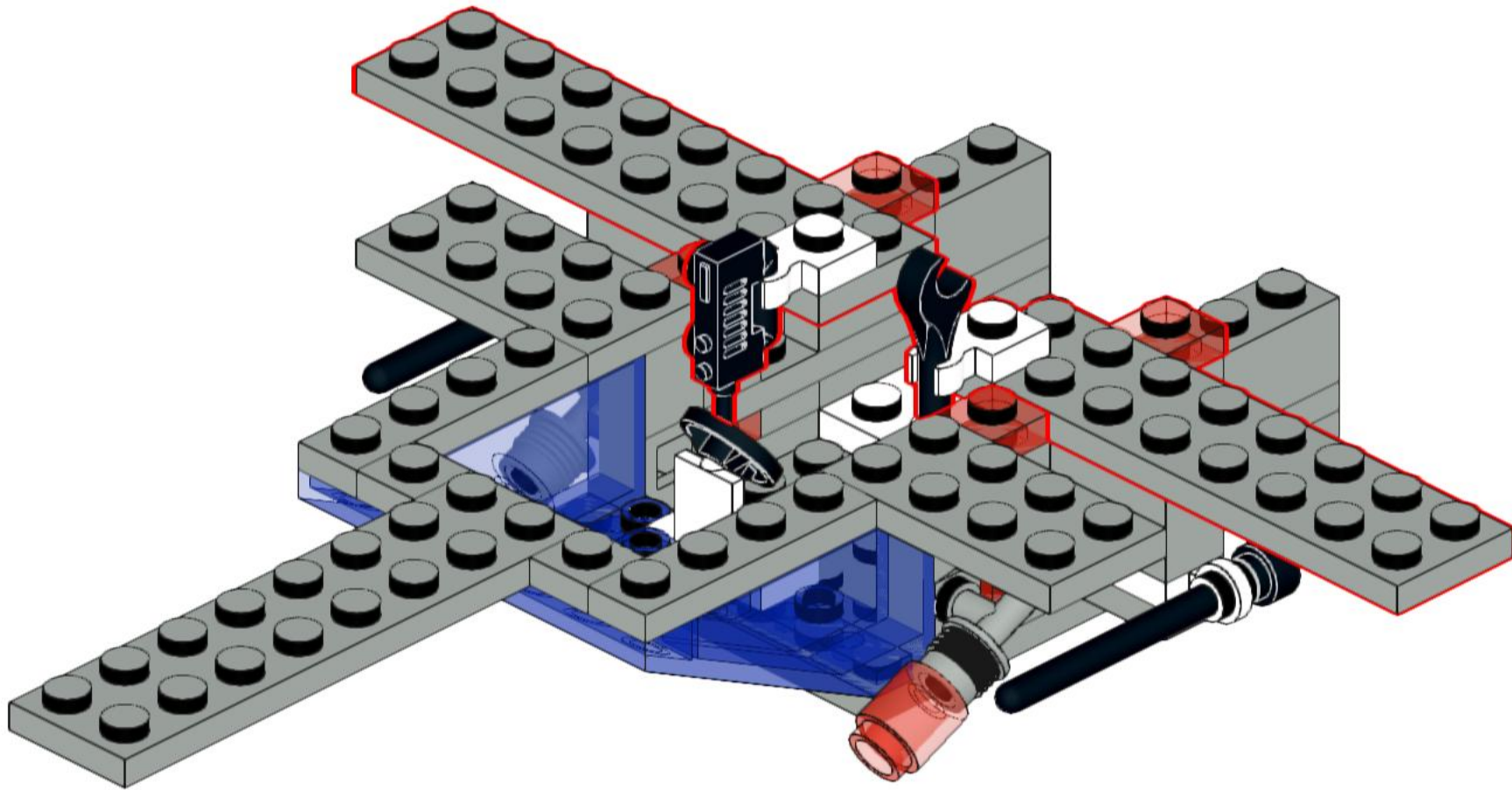
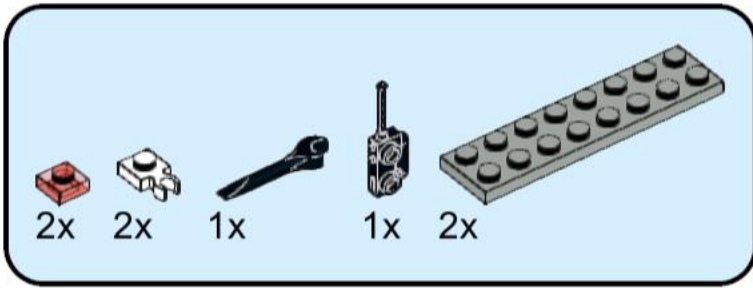

9

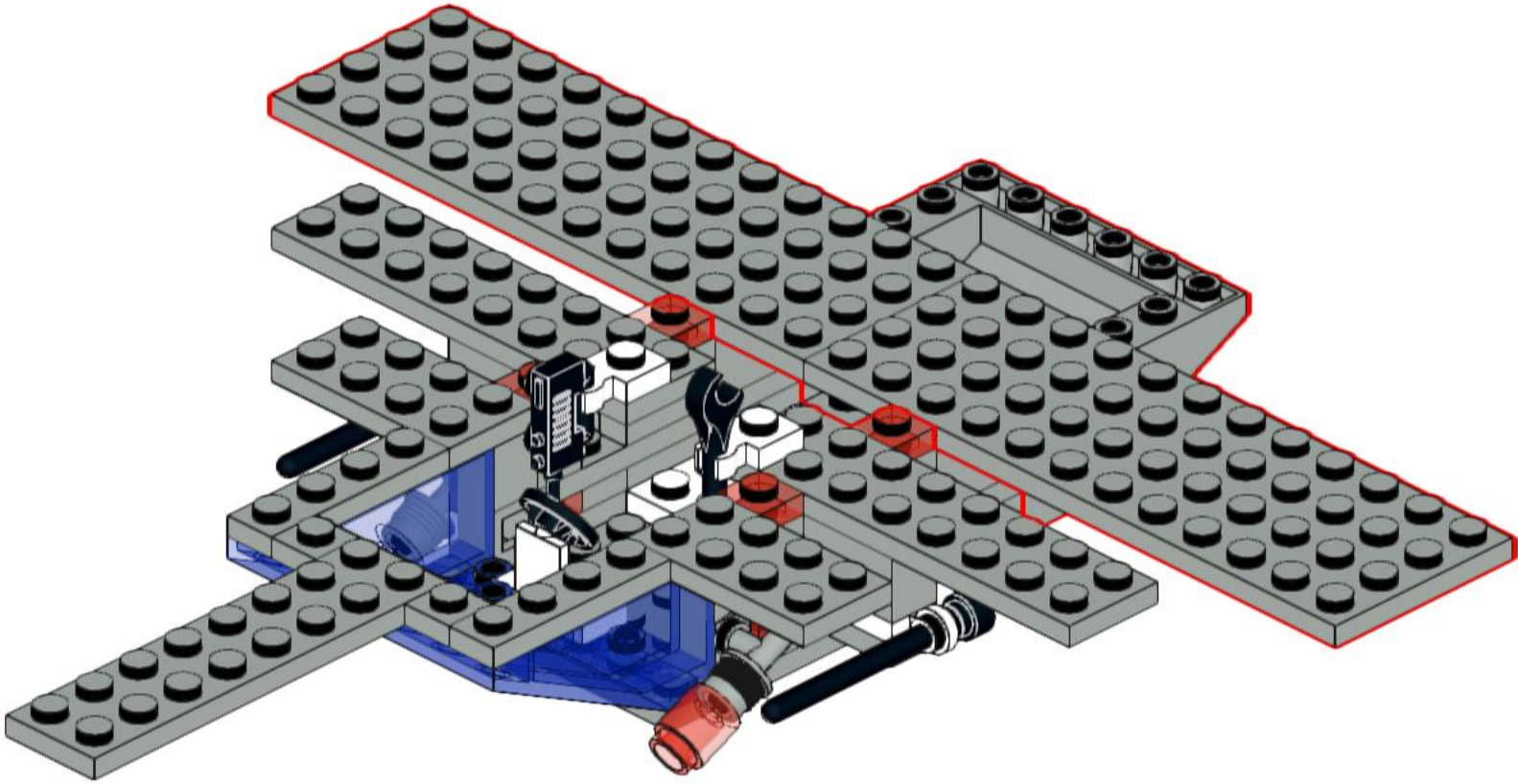
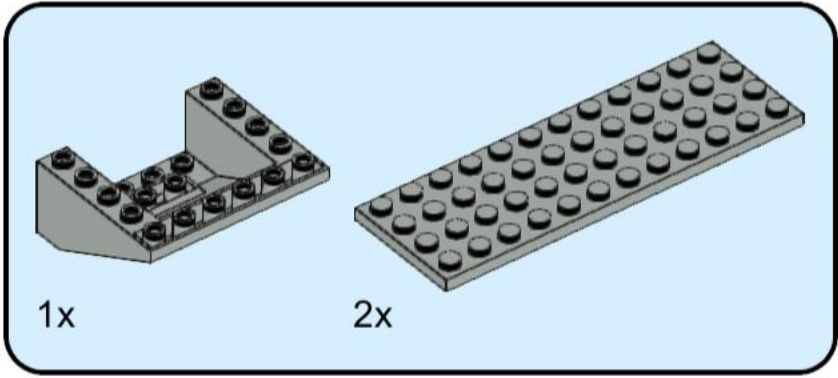

10

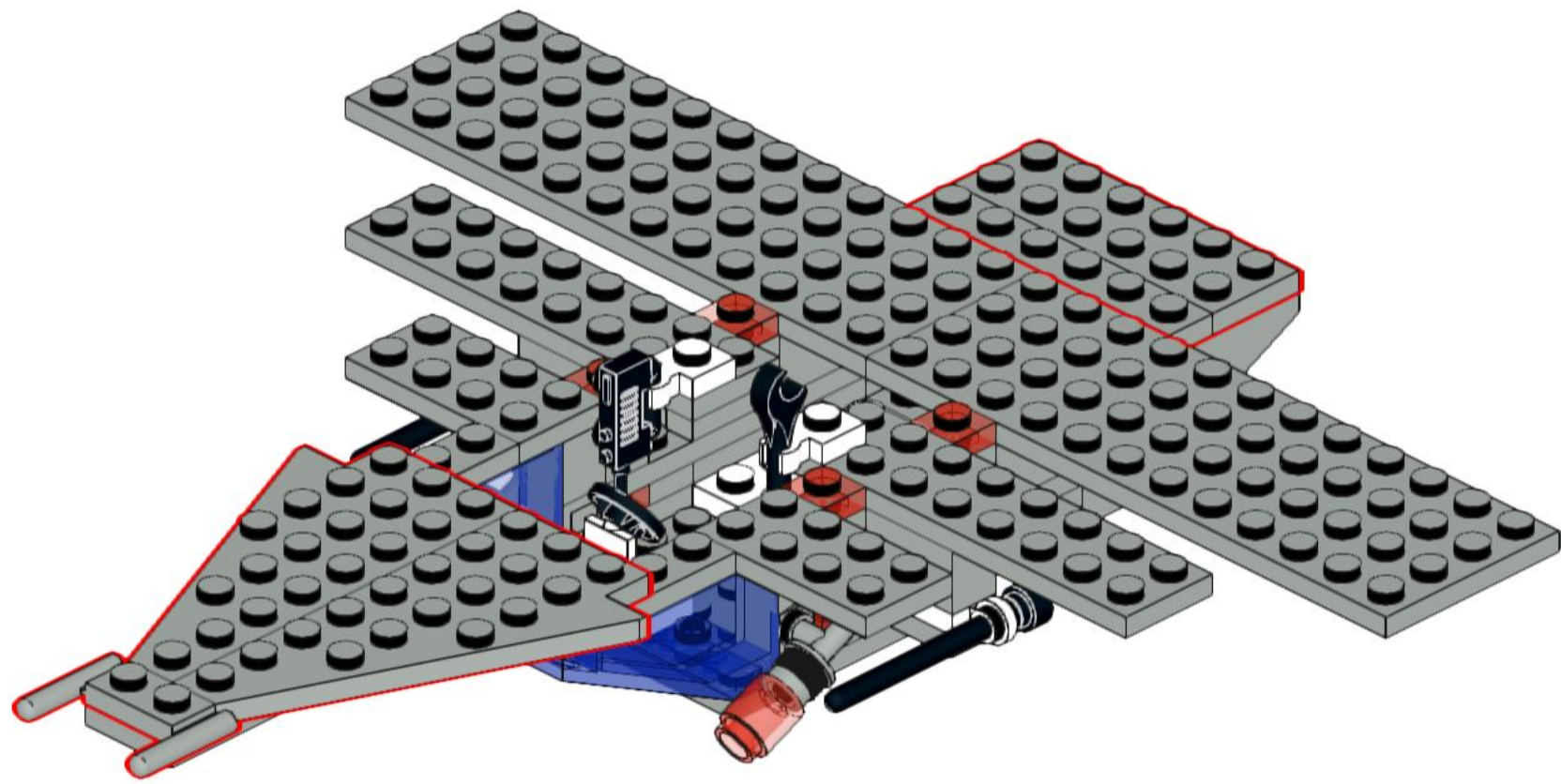
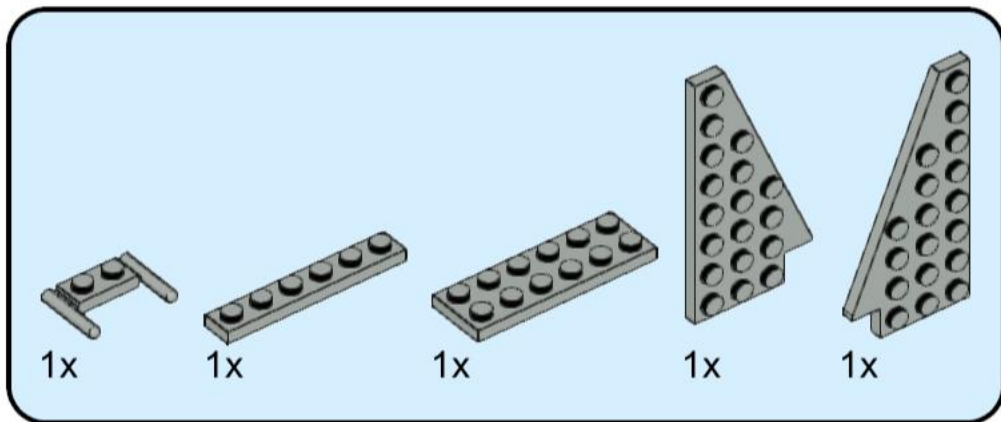



11

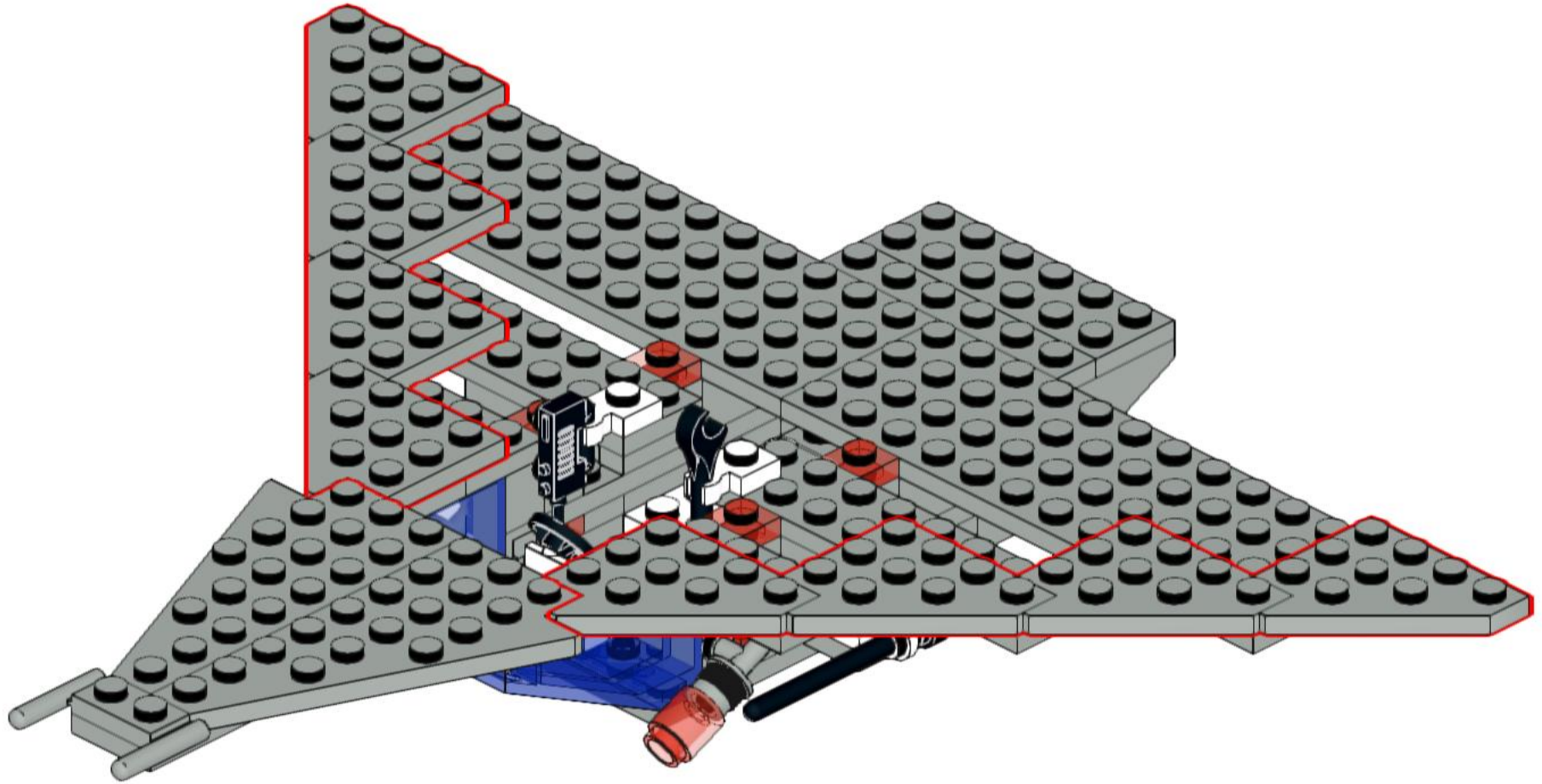
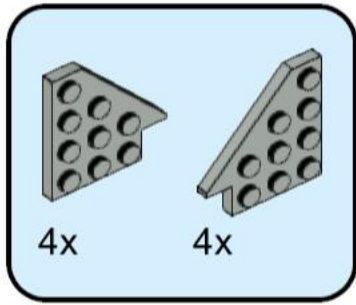

12

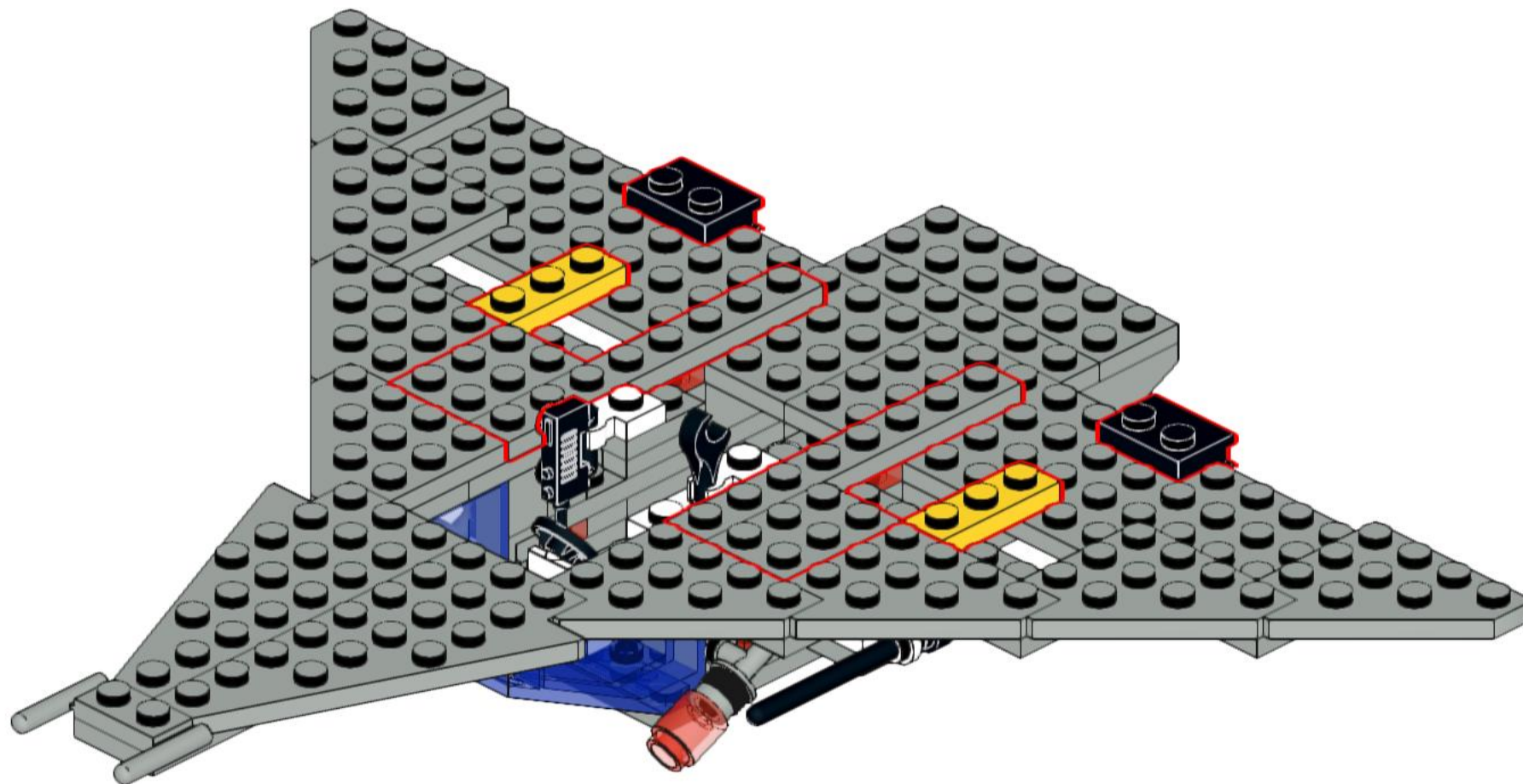
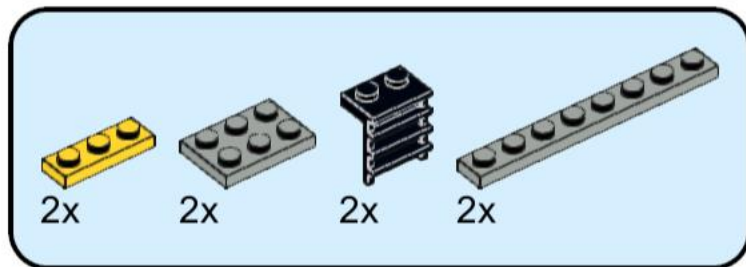



13

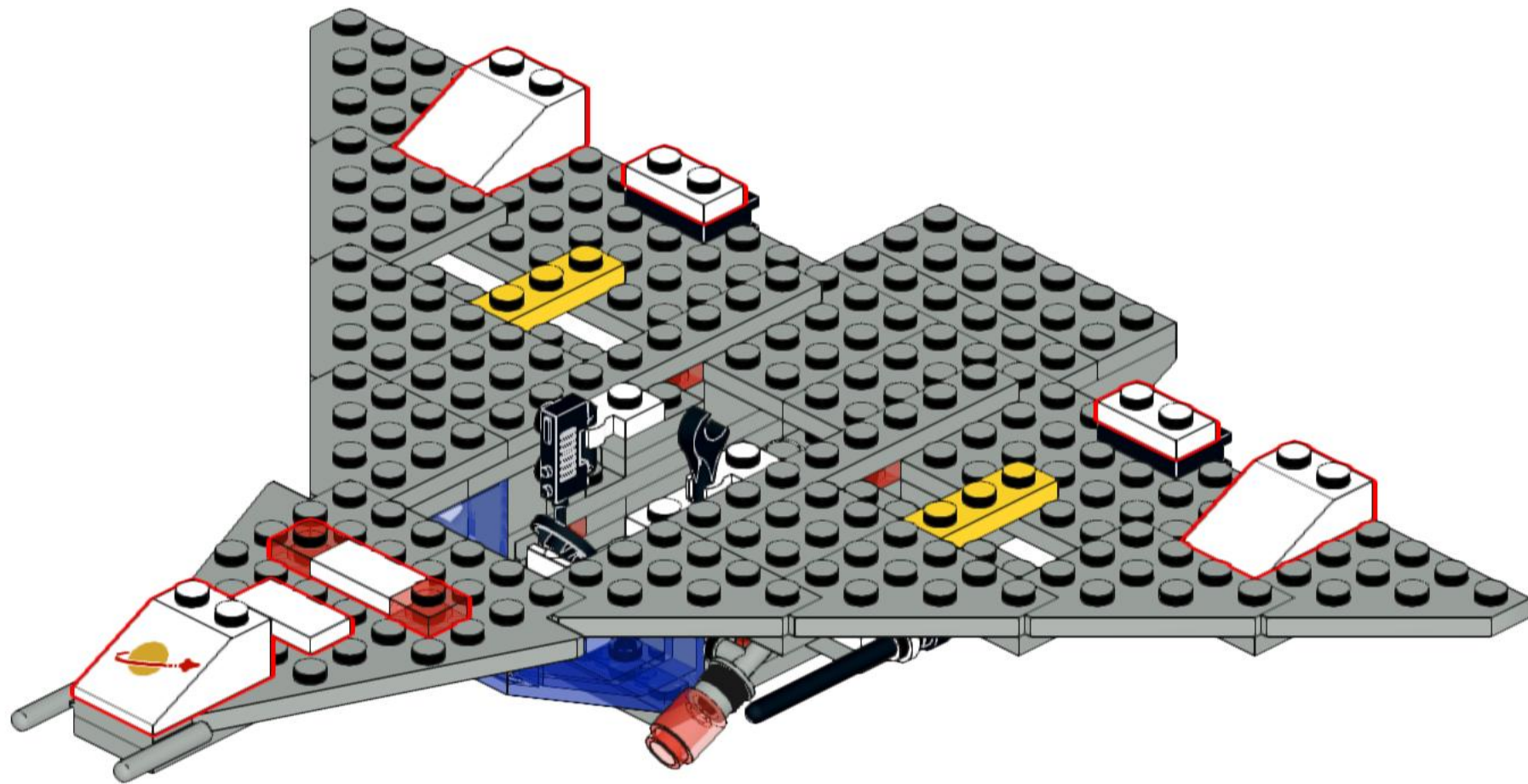
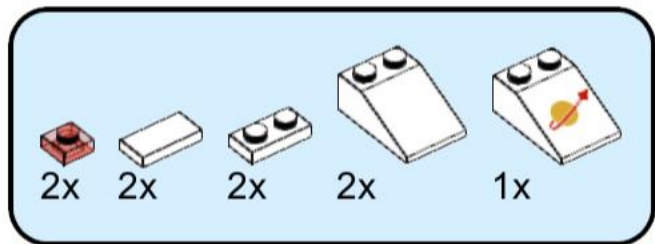

14

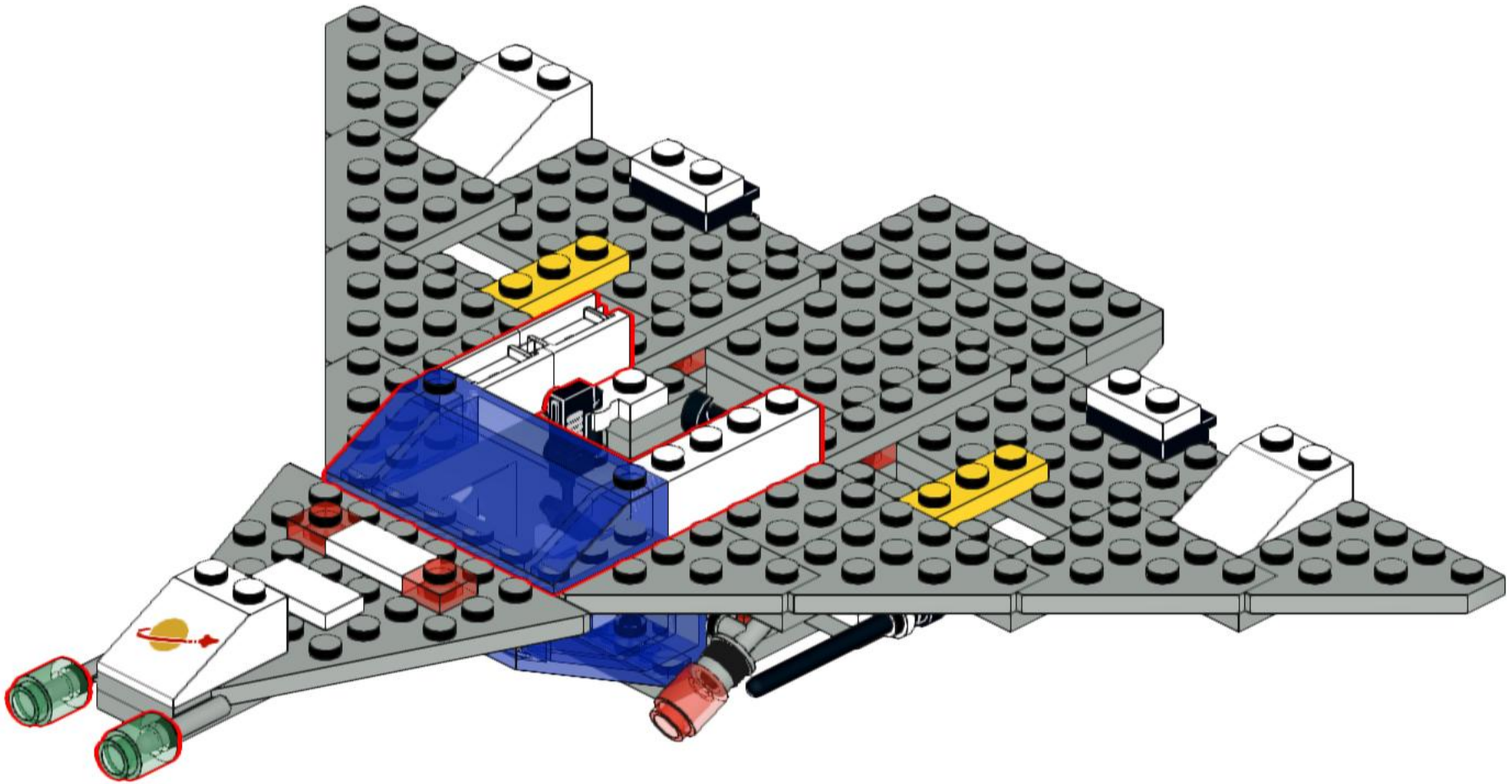
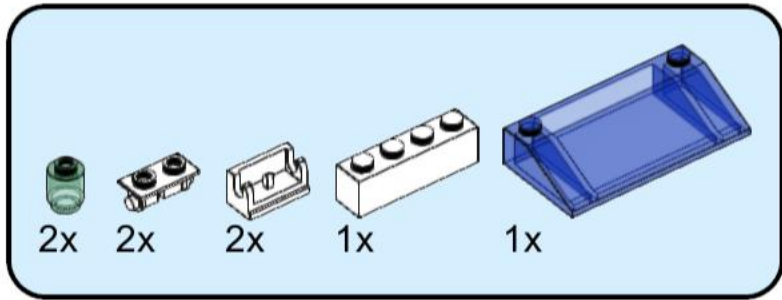

15

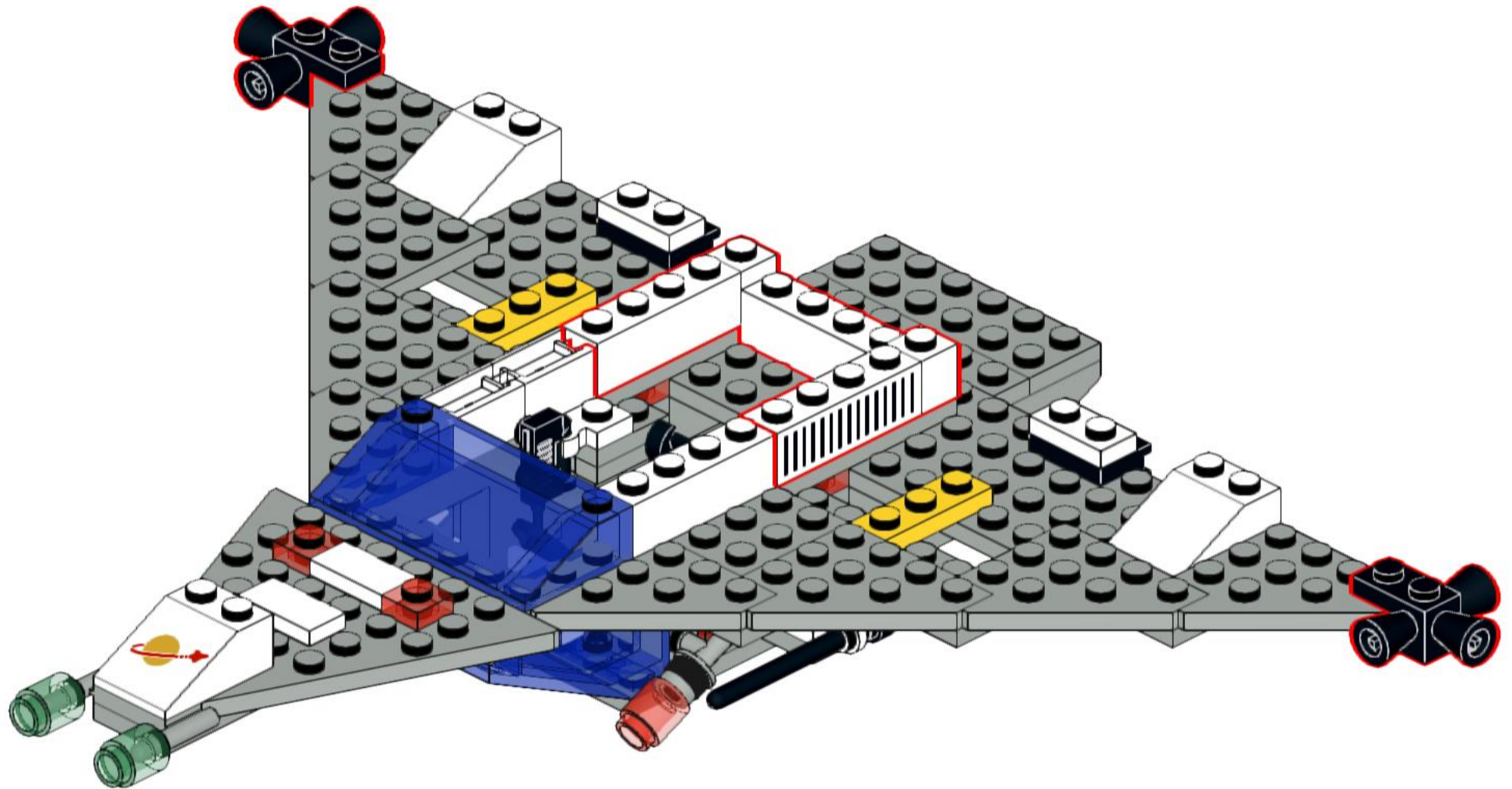
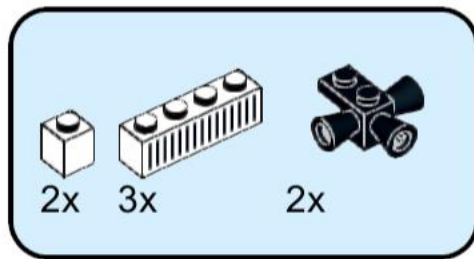



16

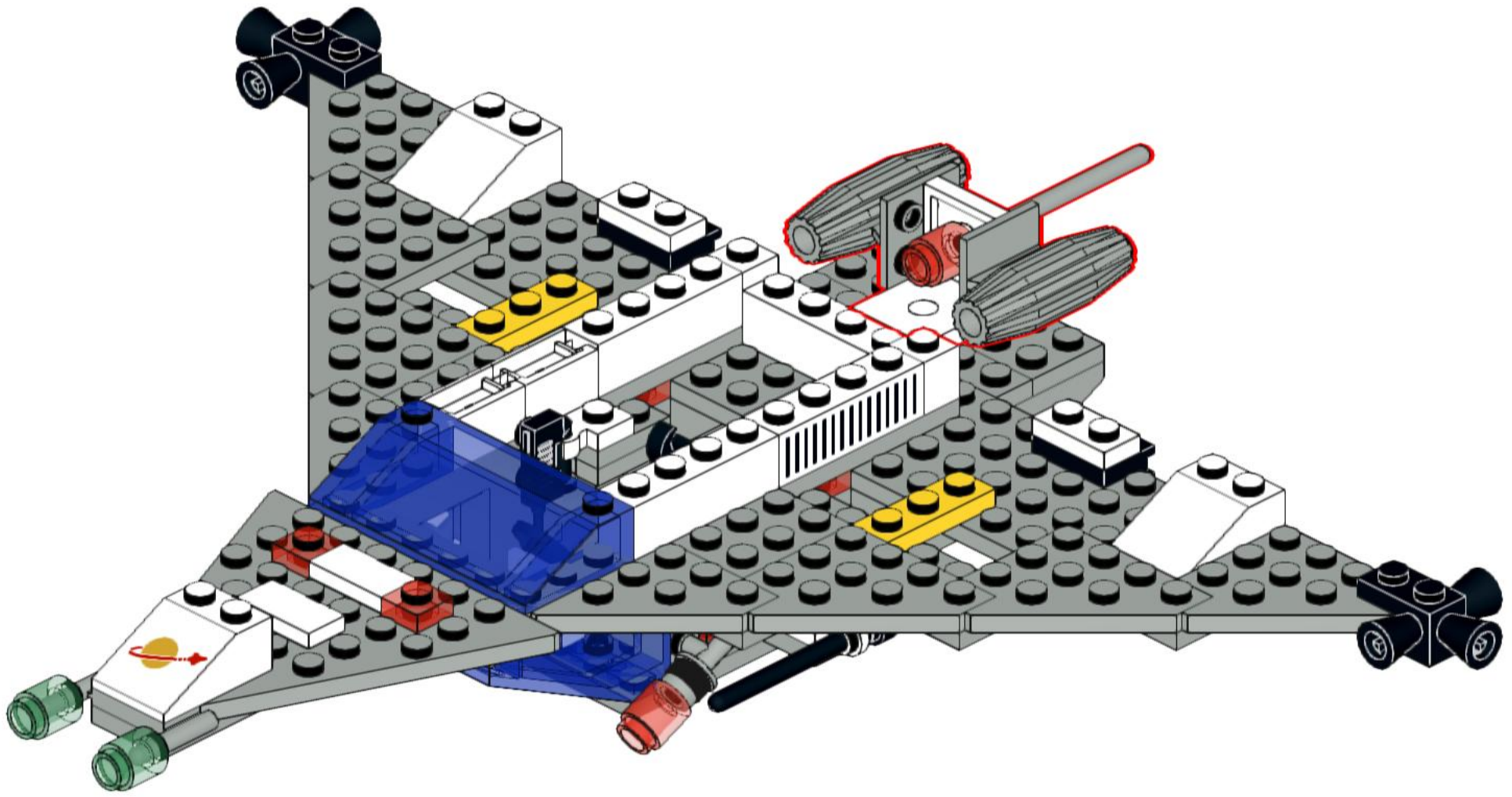
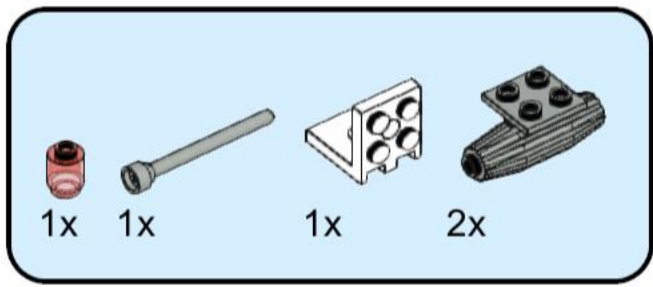

17

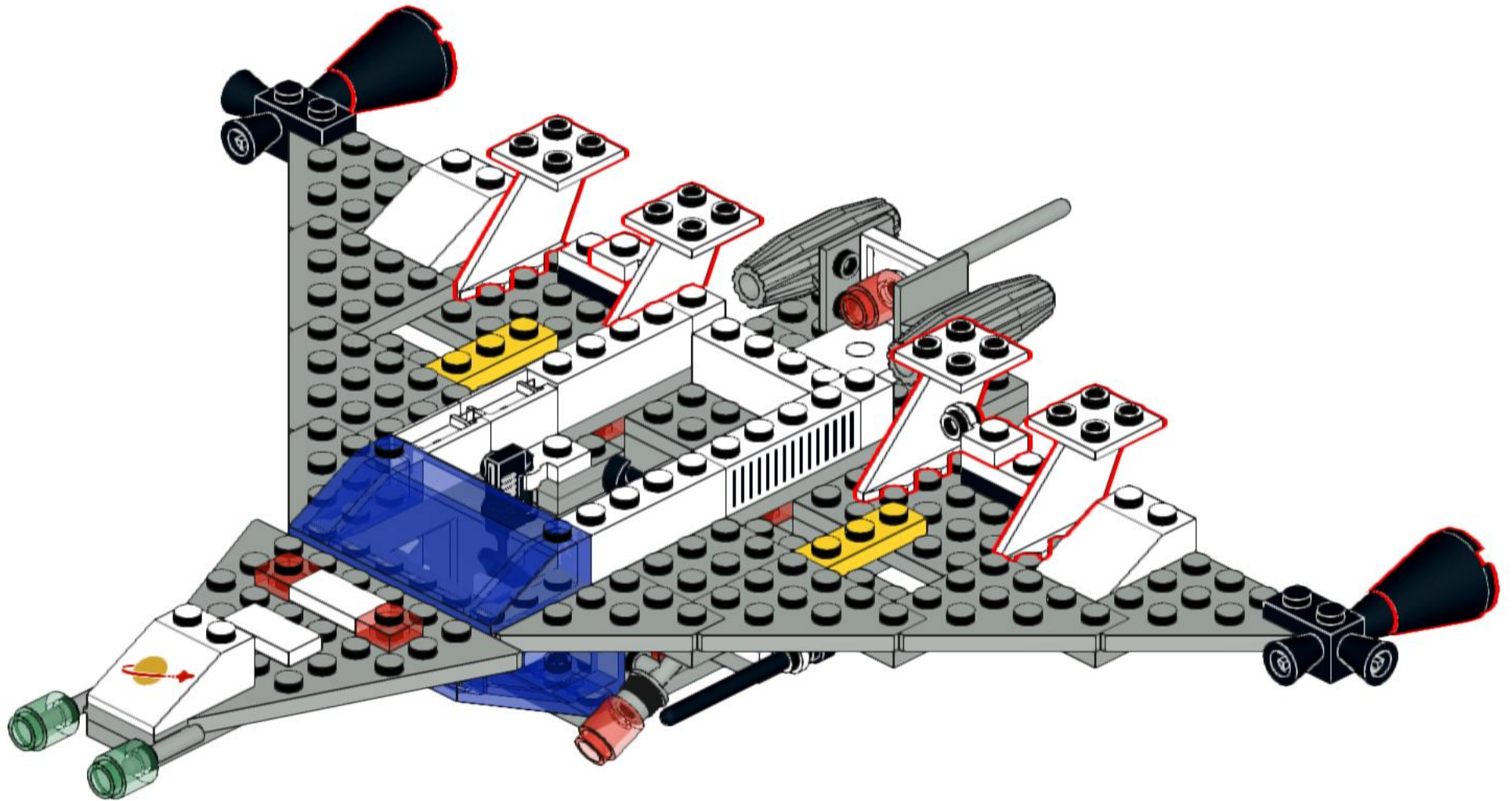
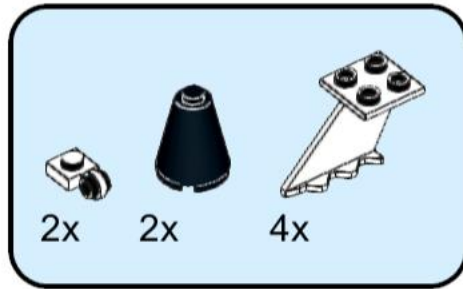



18

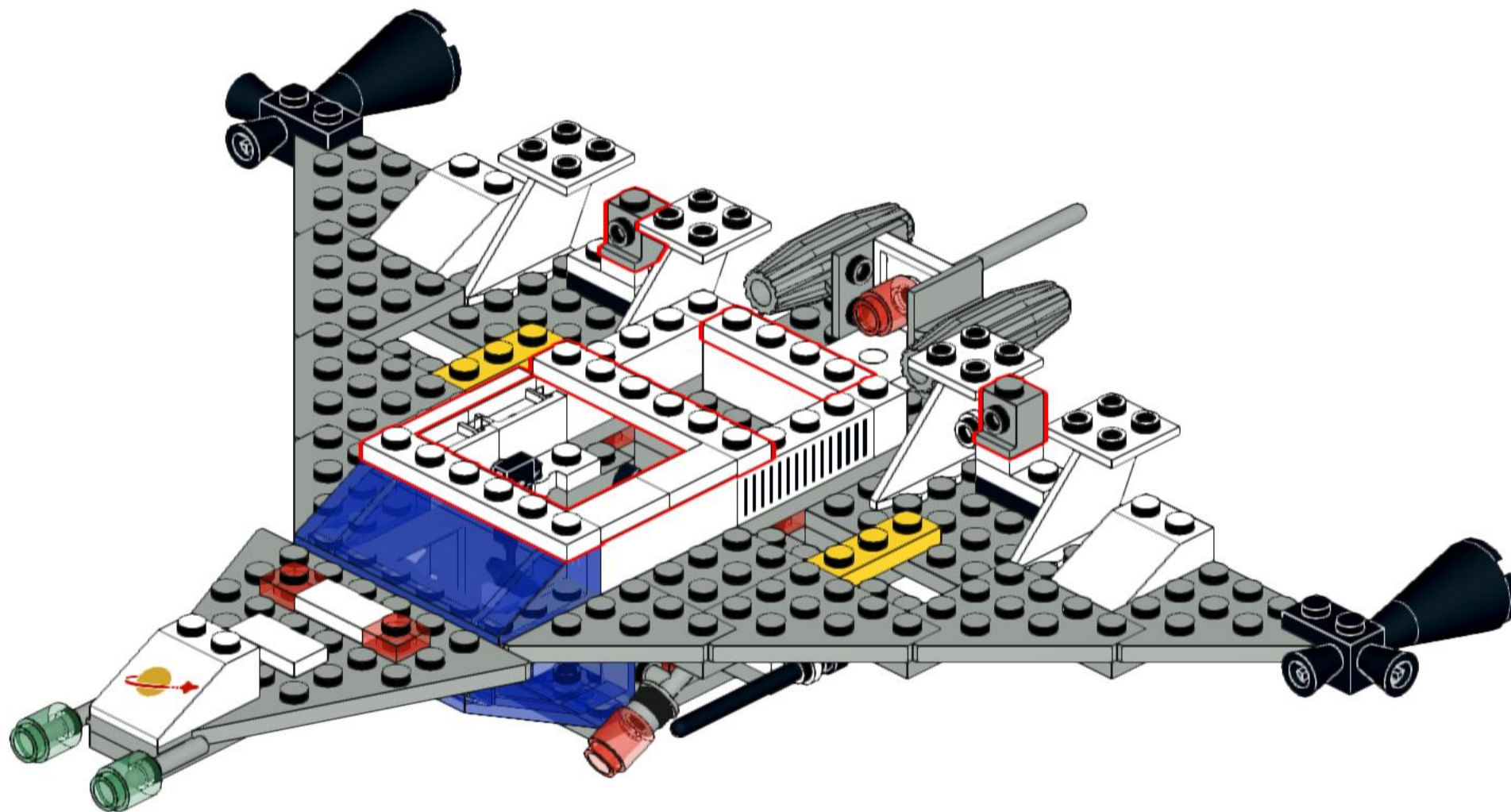
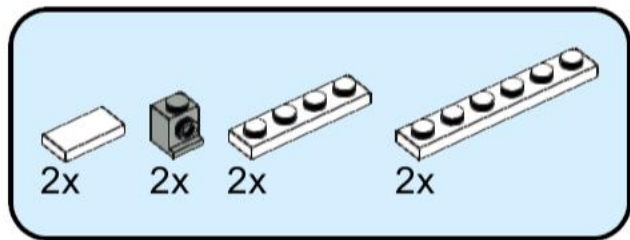

19

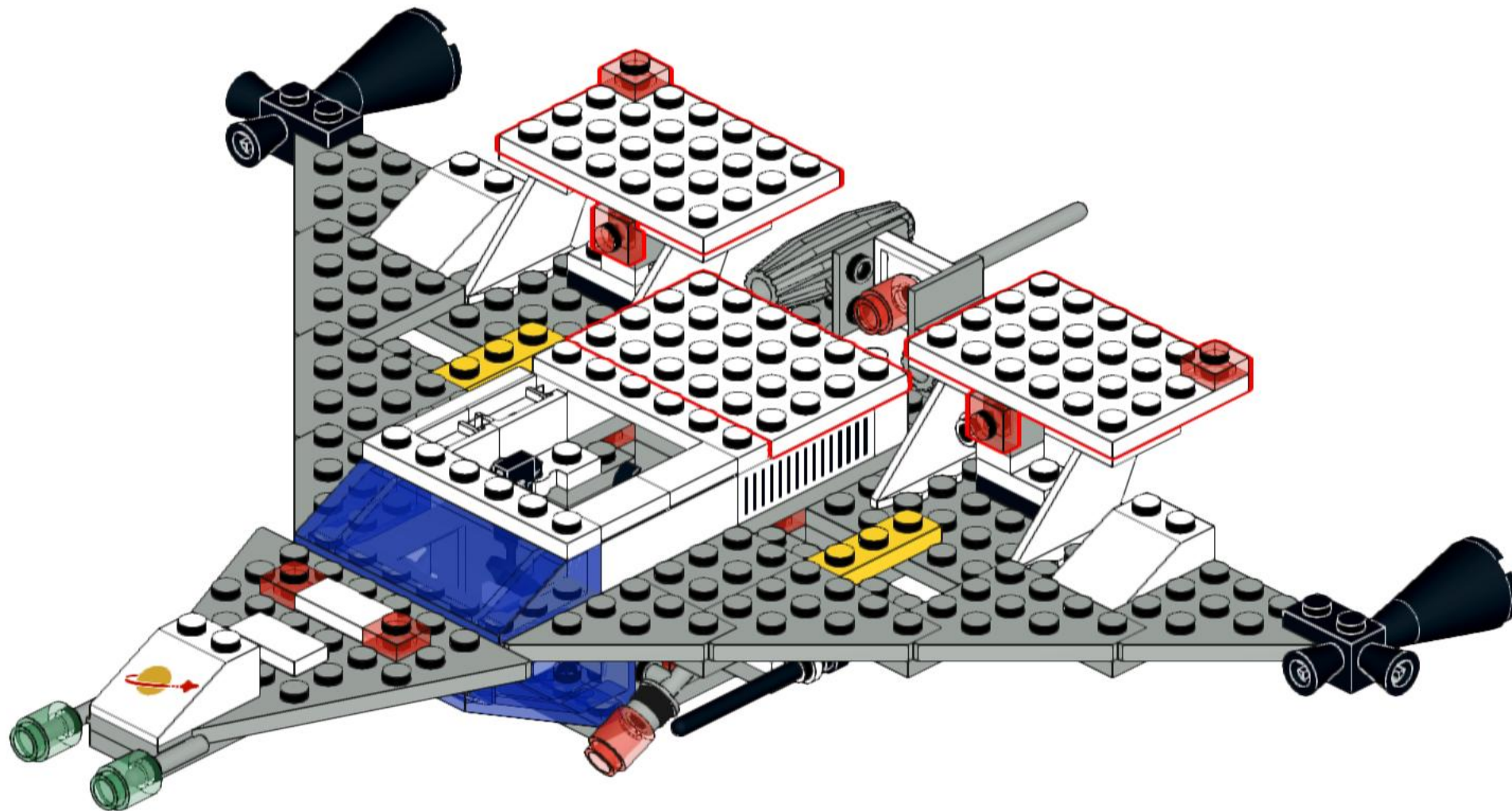
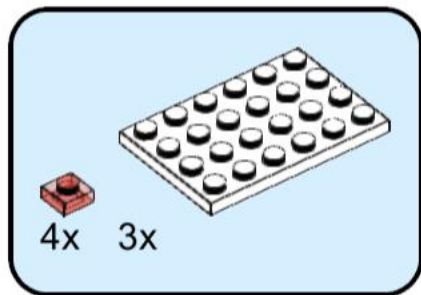





21

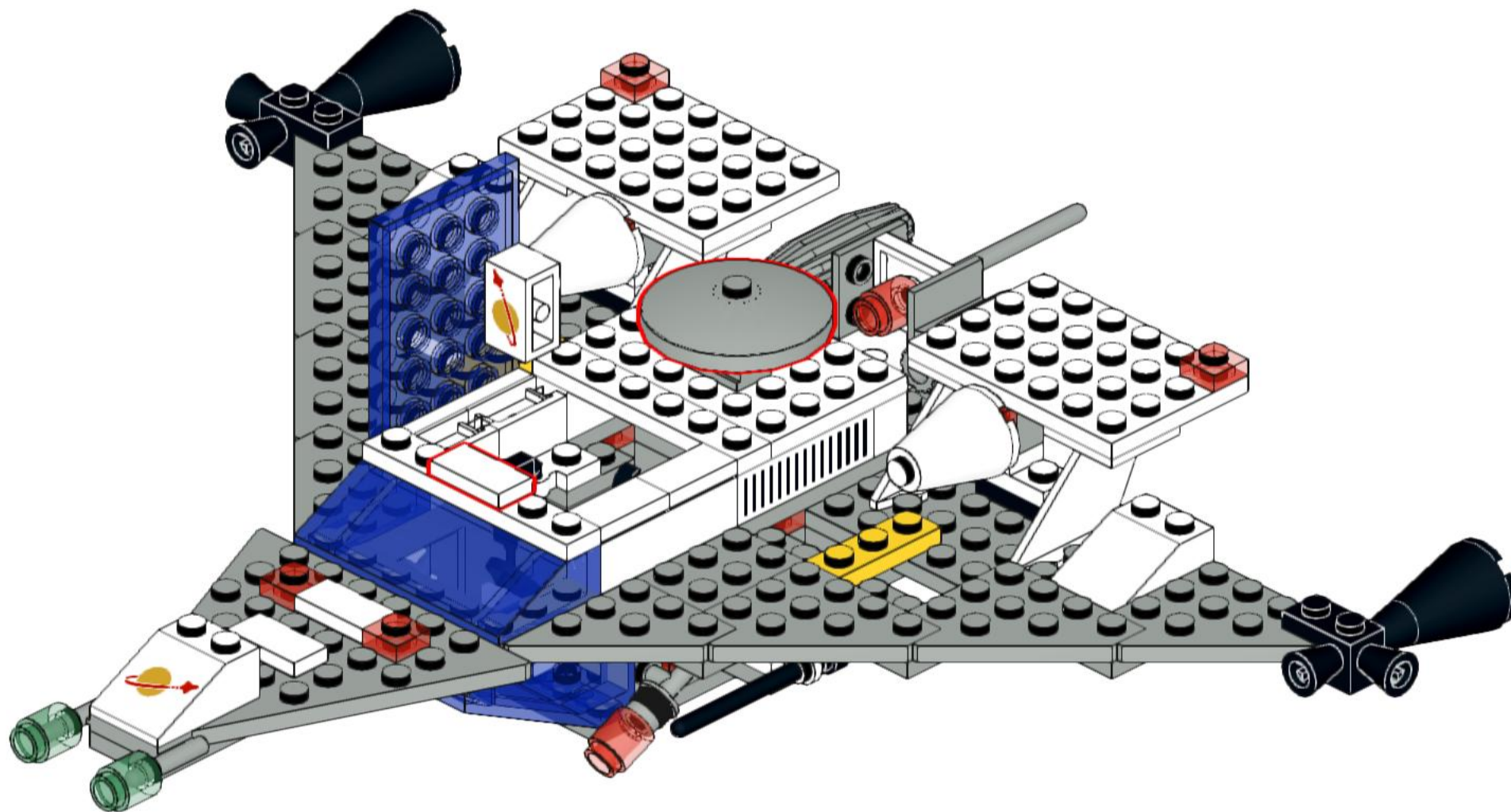
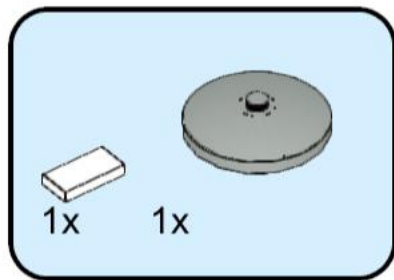

22

2x 3x 1x 1x

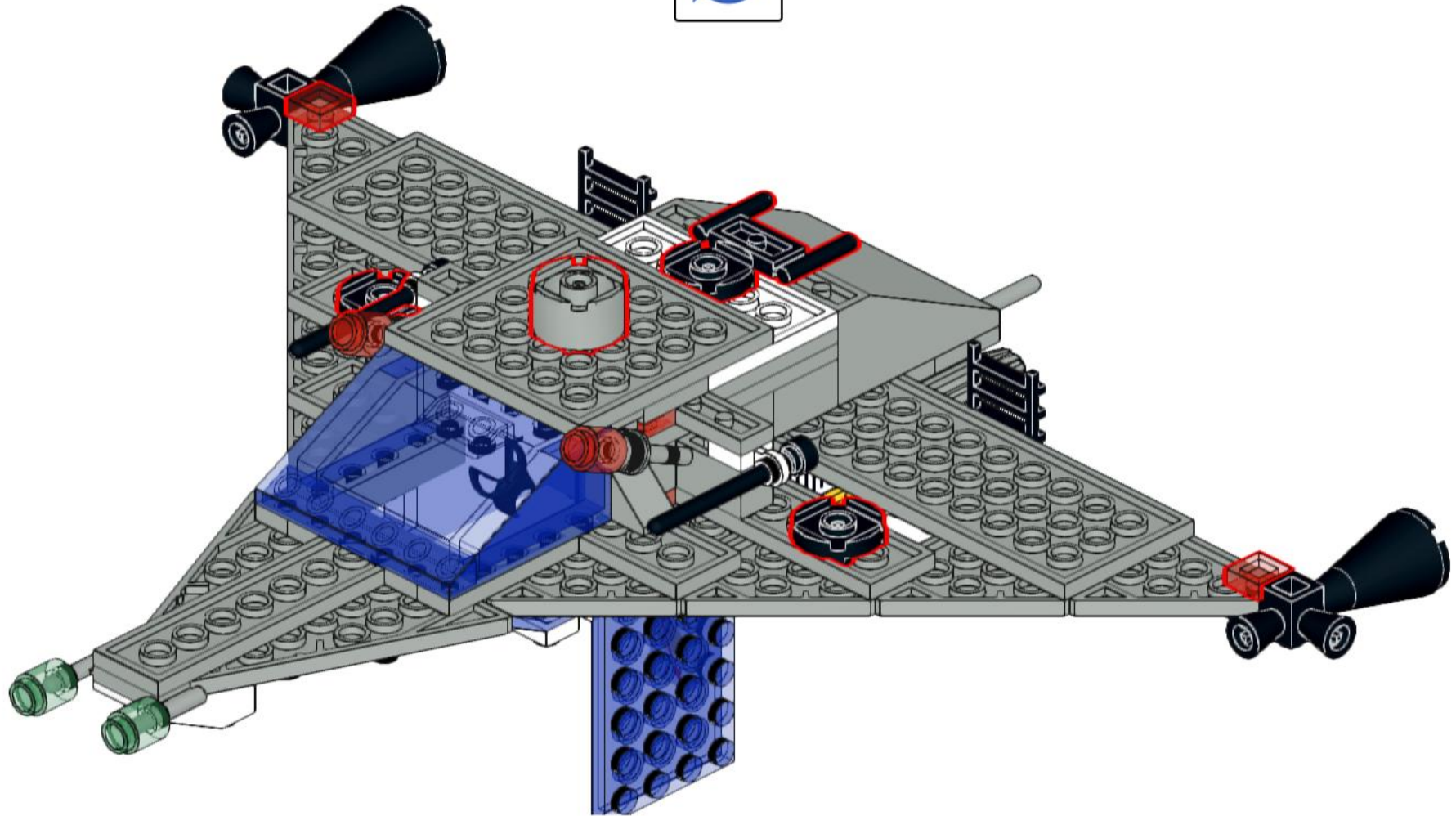
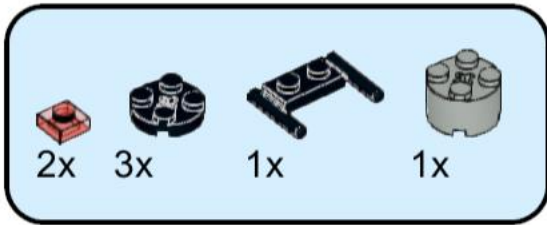





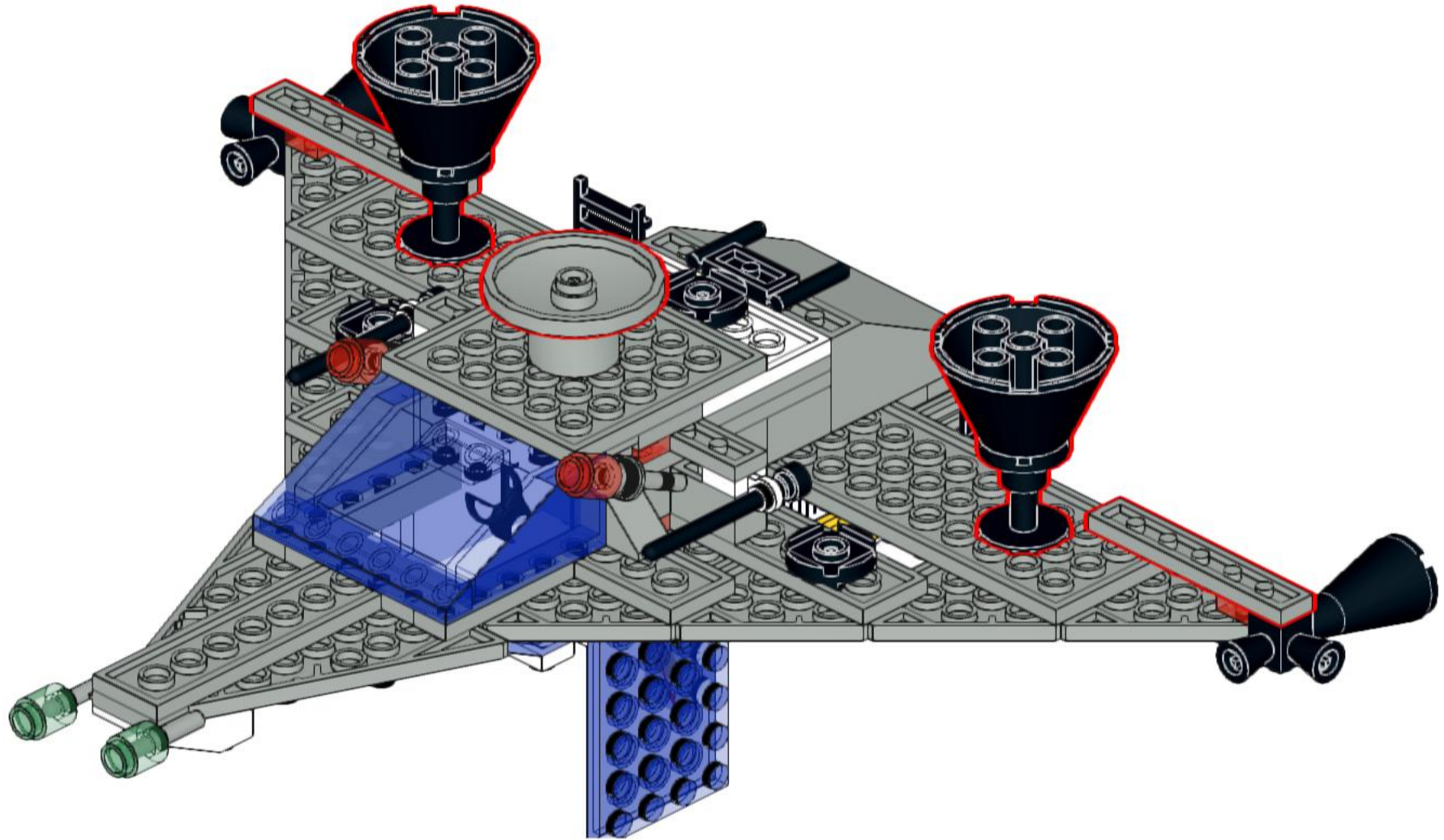
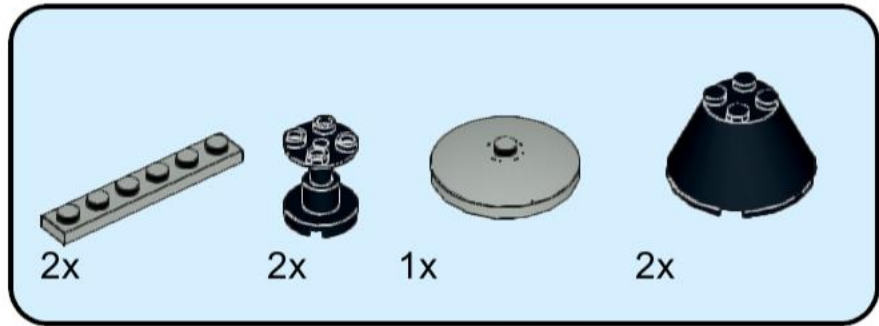



23

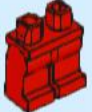

24

							
2x	1x	1x	1x	1x	1x	1x	1x

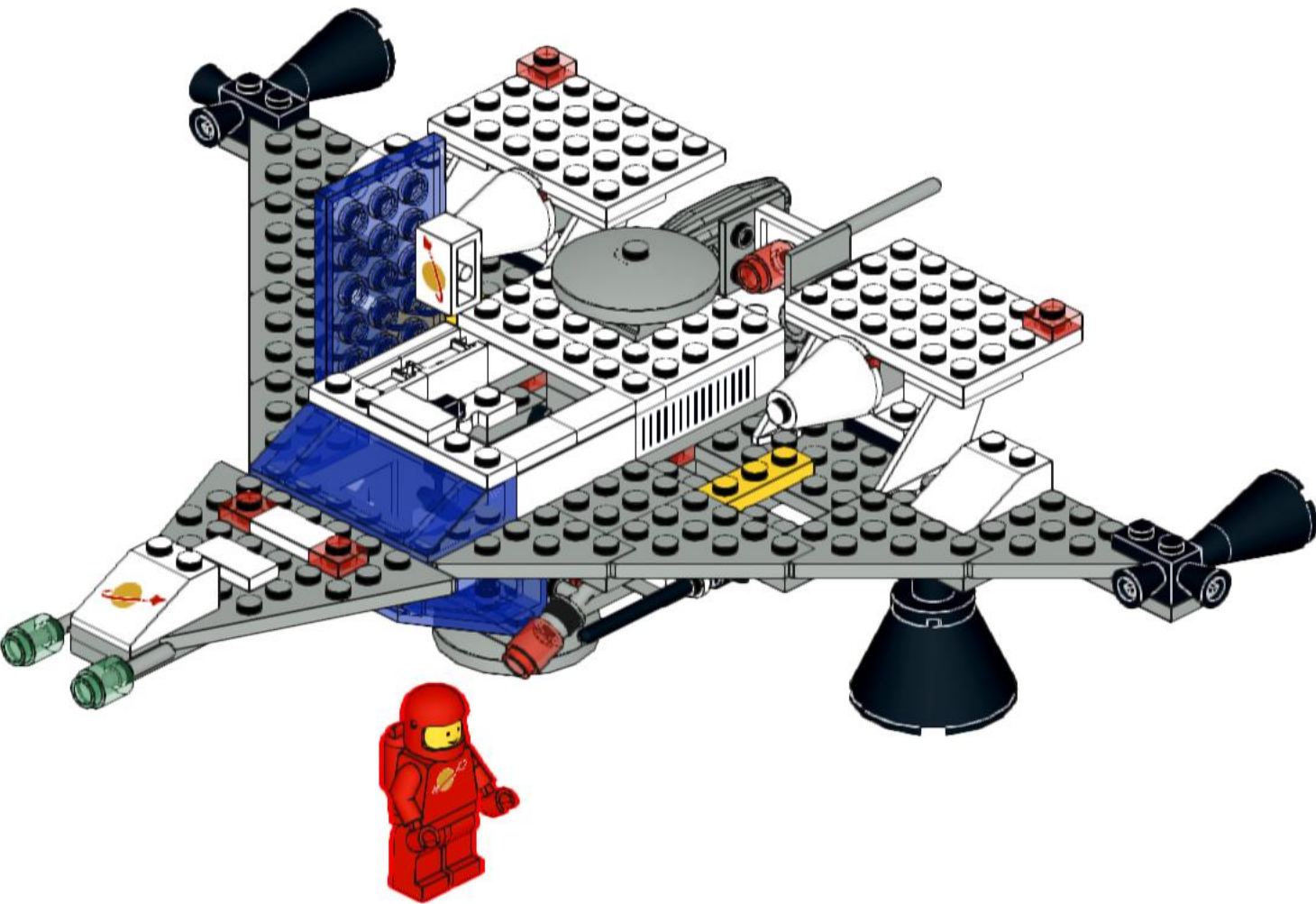



3x  
4032, 11



2x  
3942a, 11



2x  
3943a, 11



1x  
3938, 9

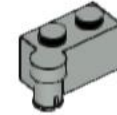

2x  
3830, 9

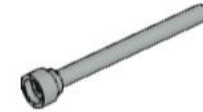

1x  
3957, 9



2x  
4175, 11



1x  
3962a, 11



2x  
3024, 9

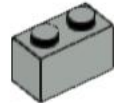

2x  
3004, 9



2x  
3623, 9



2x  
4229, 9



1x  
4006, 11



4x  
4070, 9



2x  
3665, 9



2x  
3021, 9

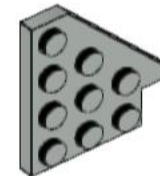

4x  
3935, 9



1x  
3839a, 11



2x  
3963, 11



2x  
3005, 9

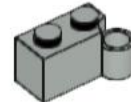

2x  
3831, 9

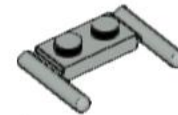

1x  
3839a, 9



2x  
3957, 11



2x  
3023, 9



2x  
3959, 9

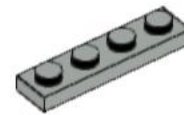

4x  
3710, 9



4x  
3936, 9



2x  
3940b, 11

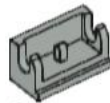

1x  
3937, 9

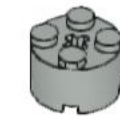

1x  
3941, 9



2x  
3020, 9





2x  
3960, 9



5x  
3666, 9



1x  
3795, 9

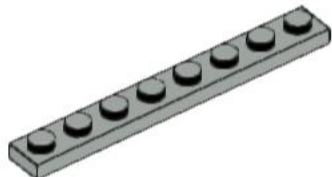

2x  
3460, 9

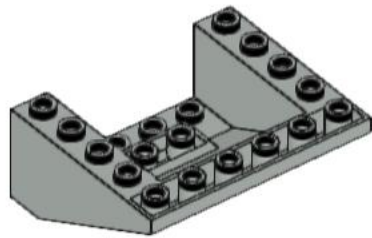

1x  
4228, 9

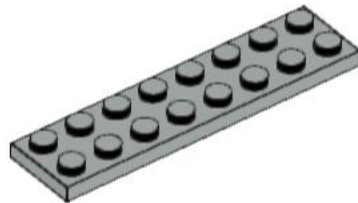

3x  
3034, 9

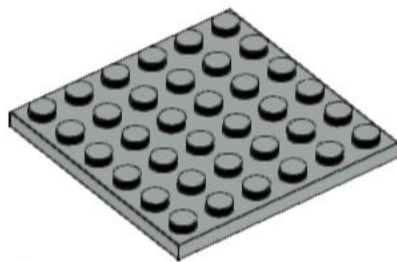

1x  
3958, 9



1x  
3933a, 9

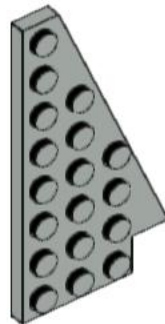

1x  
3934a, 9

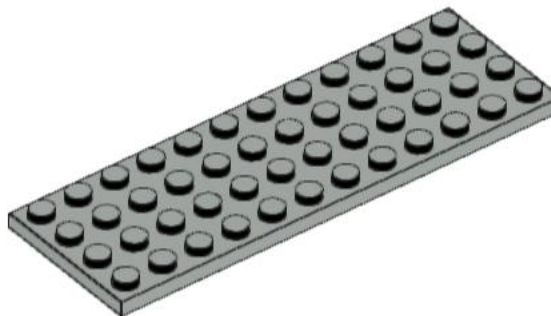

2x  
3029, 9



2x  
3005, 1



2x  
4085a, 1



5x  
3069b, 1



2x  
3023, 1



4x  
4081a, 1



2x  
3937, 1



2x  
3938, 1

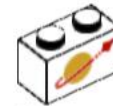

1x  
3004p90, 1

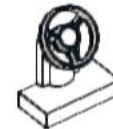

1x  
3829c01, 1



2x  
3942a, 1

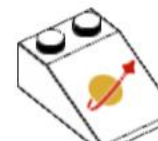

1x  
3298p90, 1

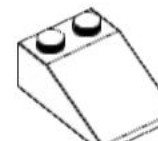

2x  
3298, 1

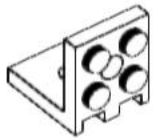

1x  
3956, 1

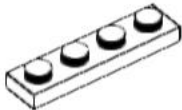

2x  
3710, 1

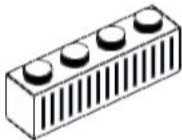

3x  
3010p04, 1

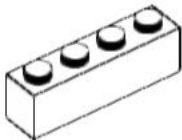

1x  
3010, 1

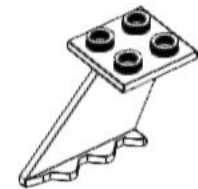

4x  
3479, 1

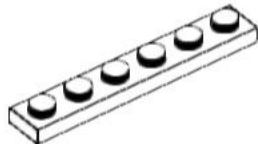

2x  
3666, 1

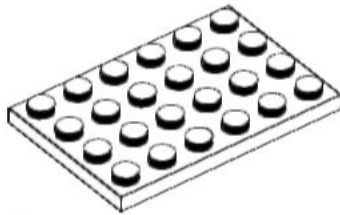

4x  
3032, 1



2x  
983, 5



1x  
981, 5



1x  
982, 5



1x  
193a2, 5



1x  
3838, 5



1x  
973p90, 5

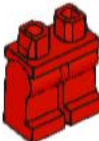

1x  
970c00, 5



1x  
3626ap01, 3

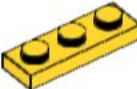

2x  
3623, 3



14x  
3024, 17



3x  
3062b, 17



2x  
3062b, 20

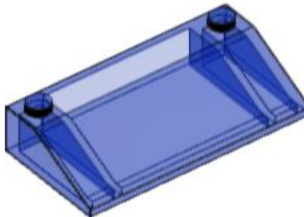

1x  
3939, 14

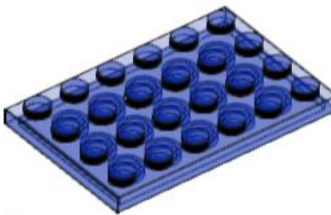

1x  
3032, 14

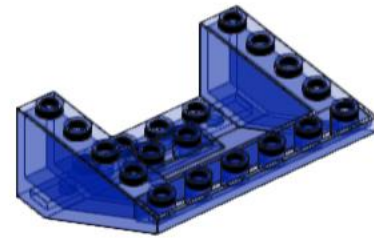

1x  
4228, 14