

1

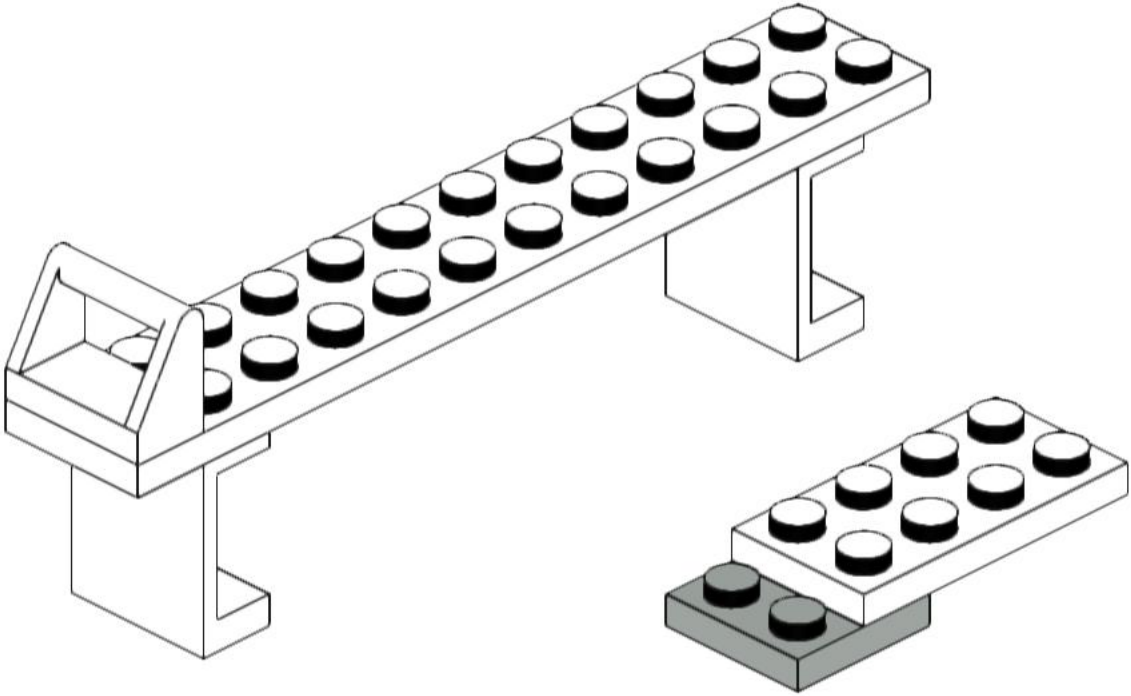

2

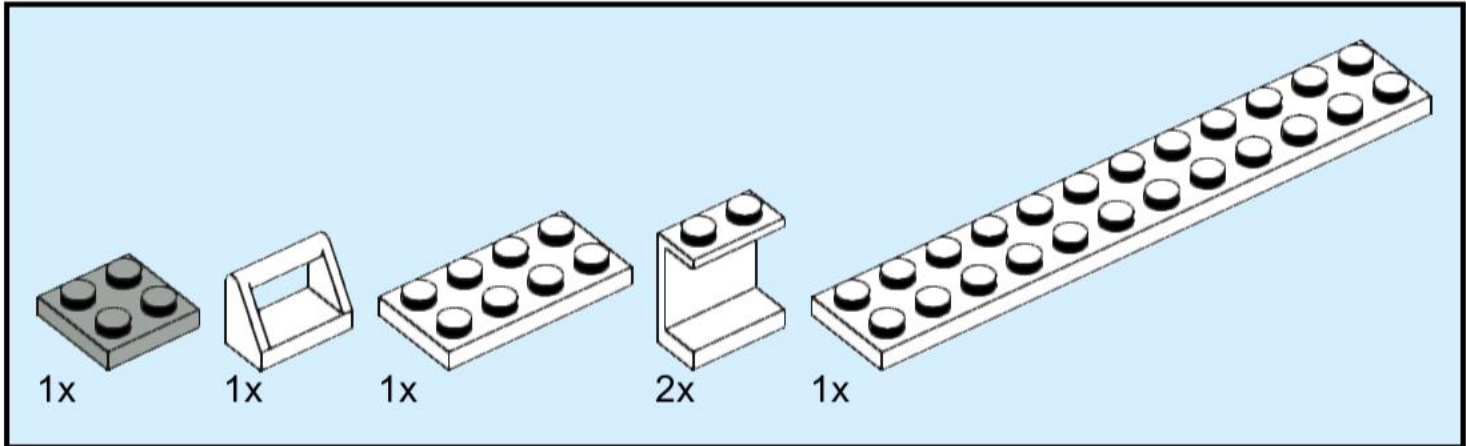

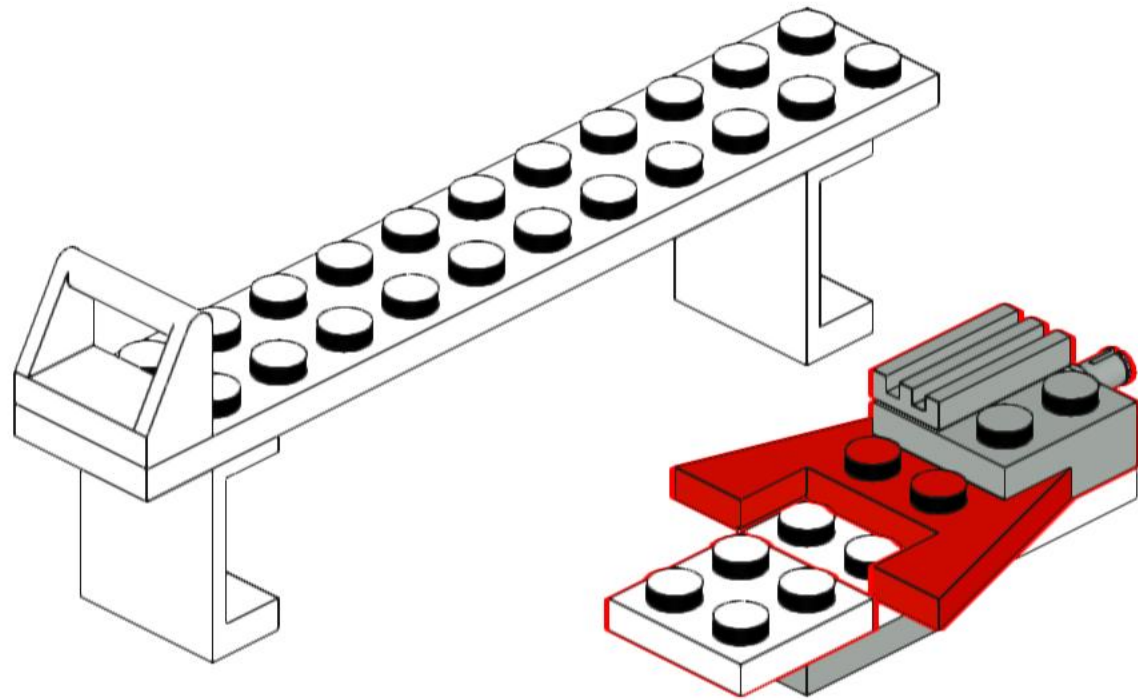
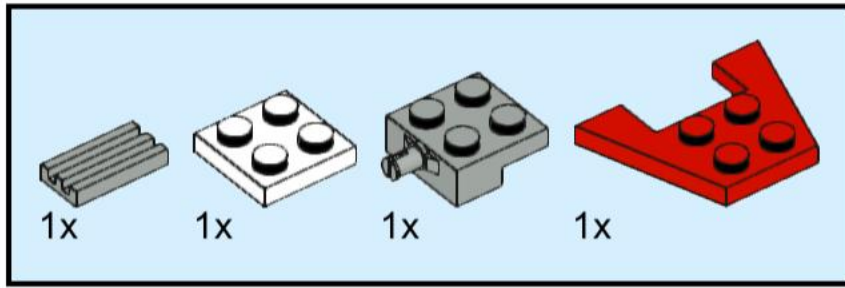

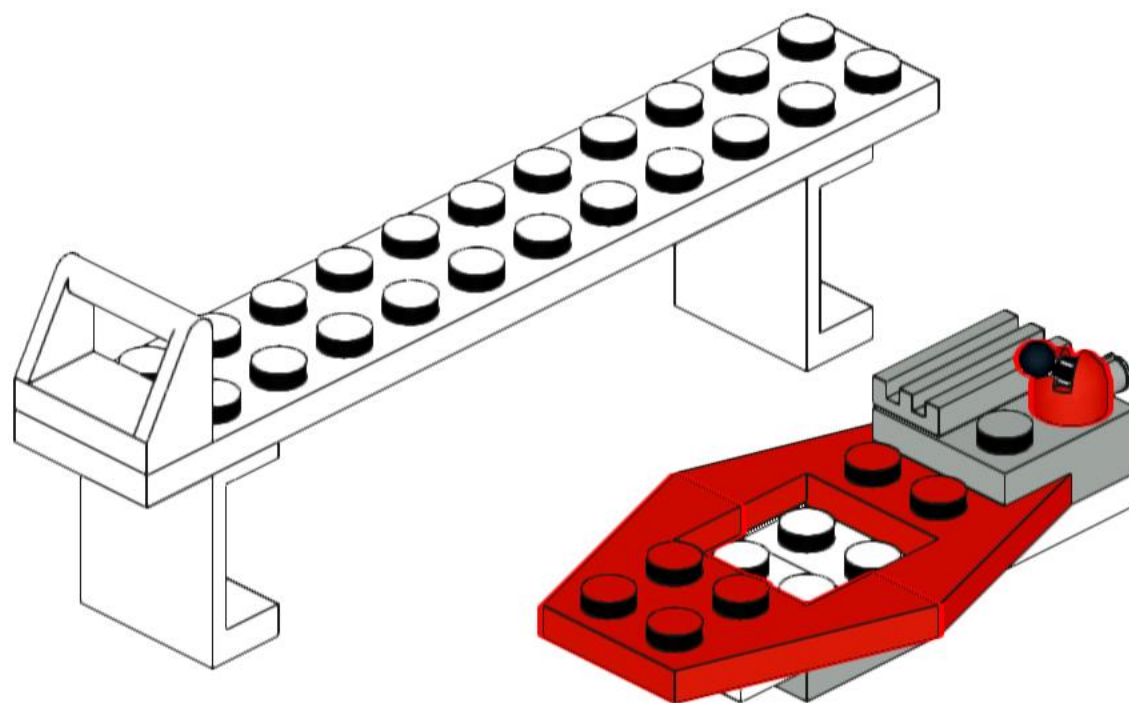
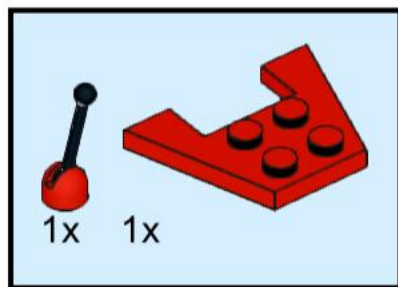



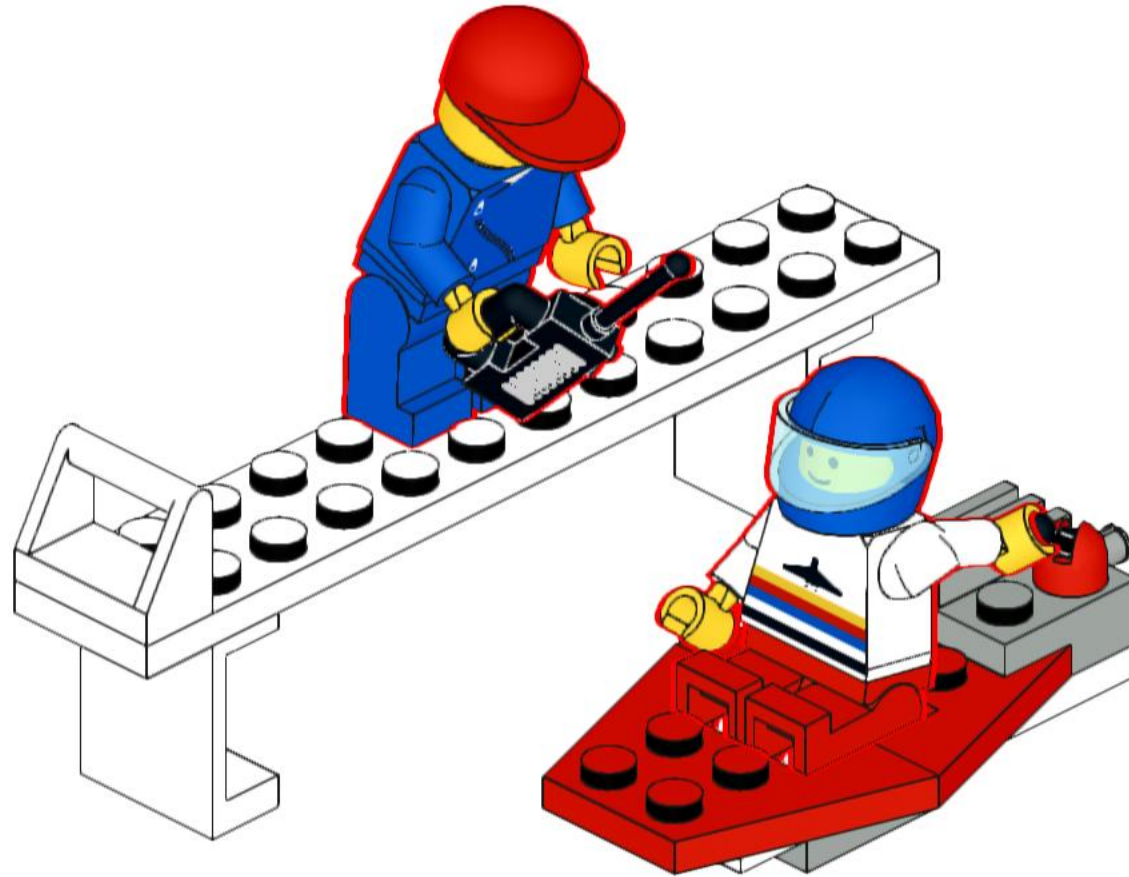



3



4

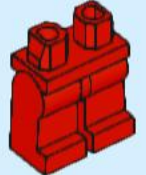

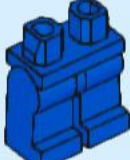
- 4x  1x 
- 1x  1x  1x 
- 1x  2x  1x 
- 1x  1x 
- 1x  1x 
- 1x  1x 