



6885
SATURN BASE MAIN TEAM
(CRATER CRAWLER)
ALTERNATE MODEL (1988)

INSTRUCTIONS

CONCEPT BY LEGO
PHOTOGRAPHY & INSTRUCTIONS
BY COSMIC.BRICK



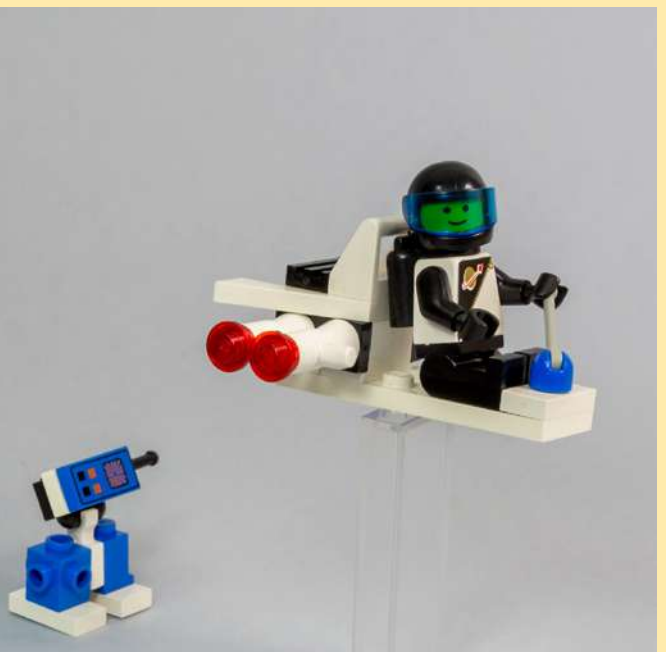
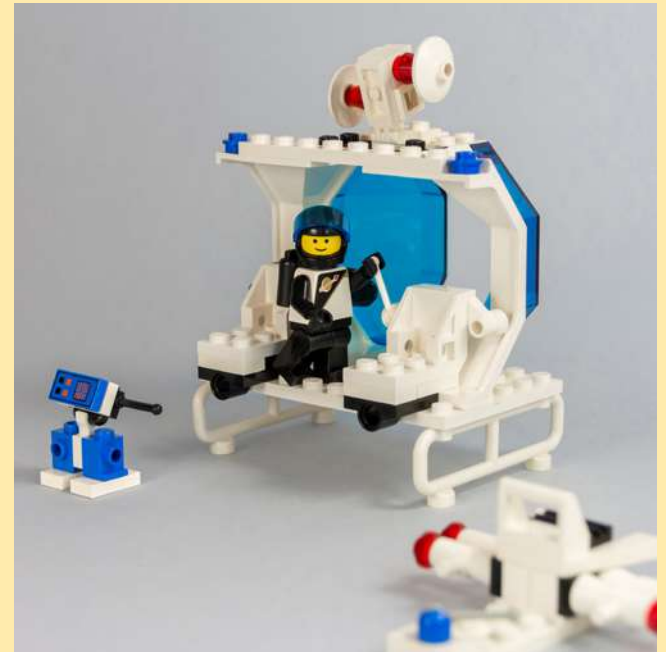

1

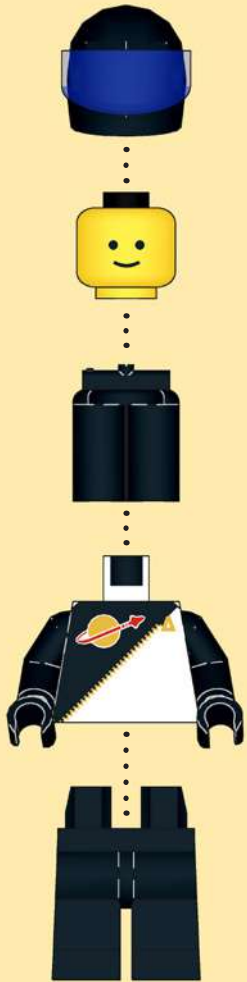

2

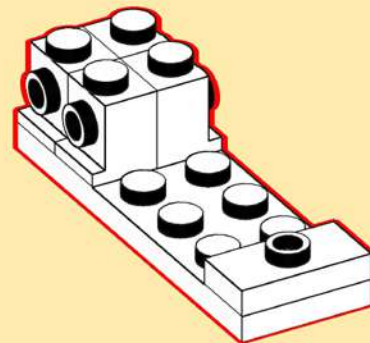
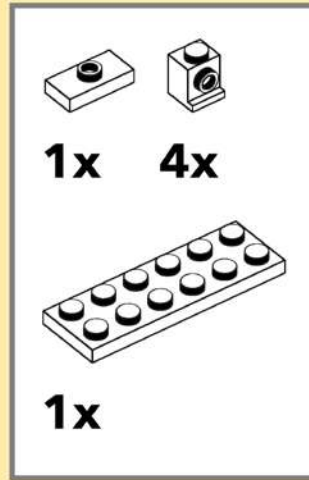

3

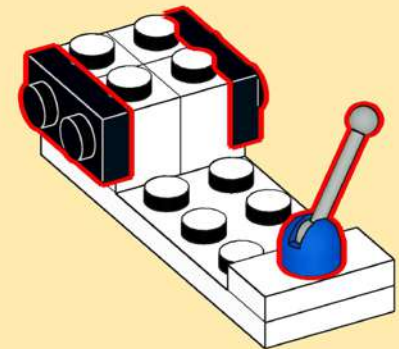

4

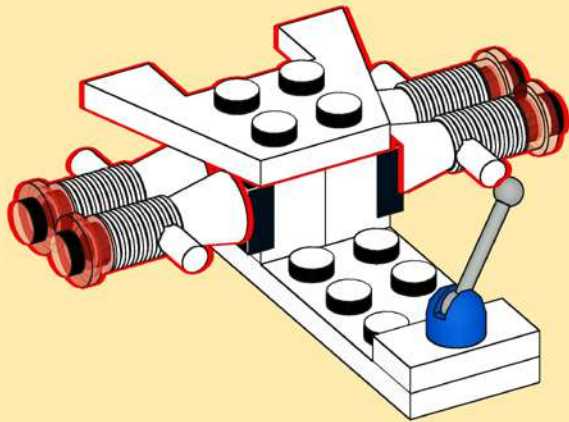
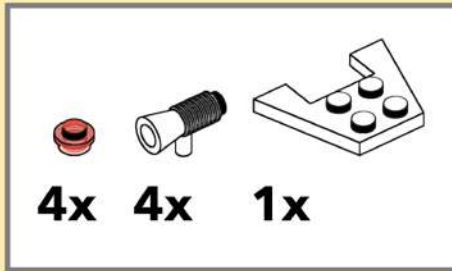

5

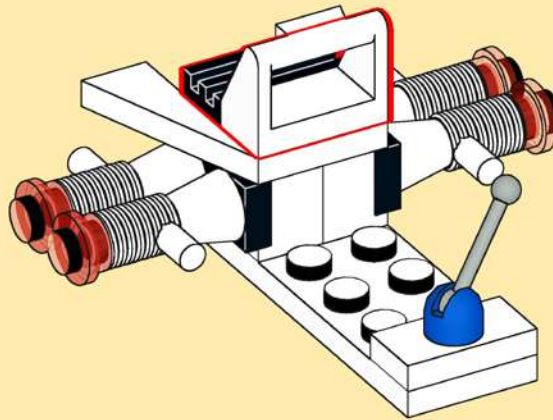
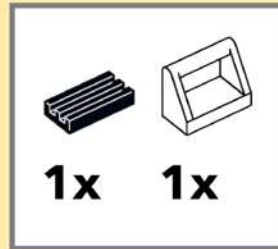

6

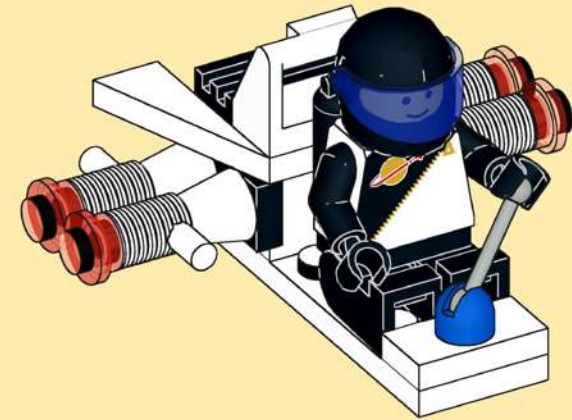

1

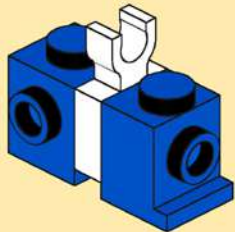
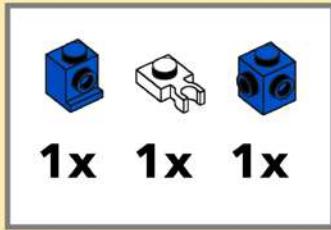

2

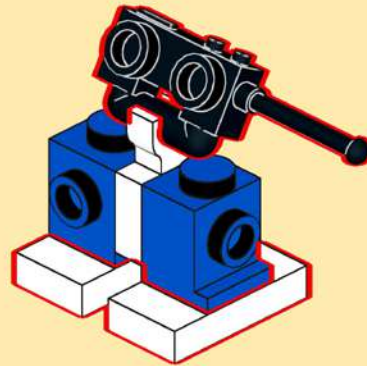
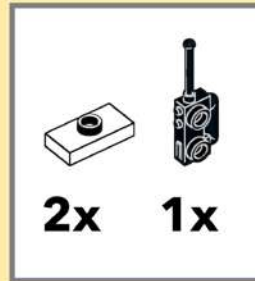

3

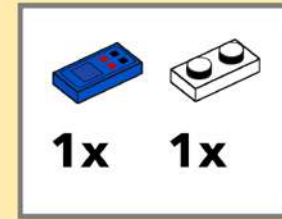

1

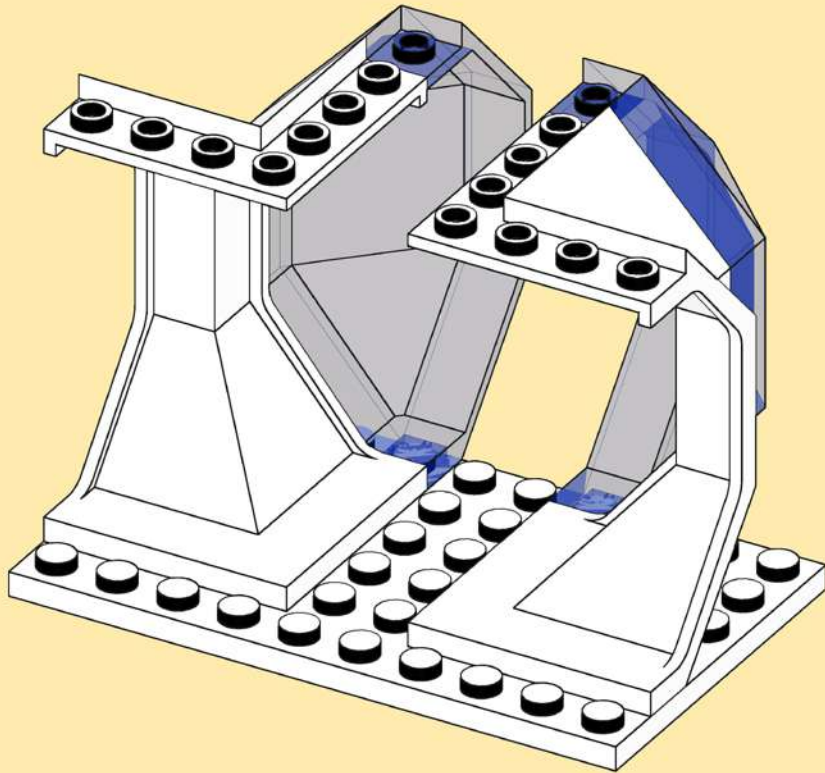
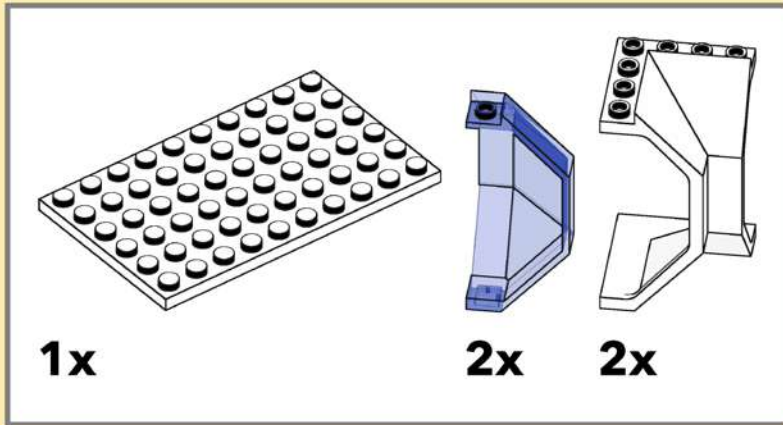

2

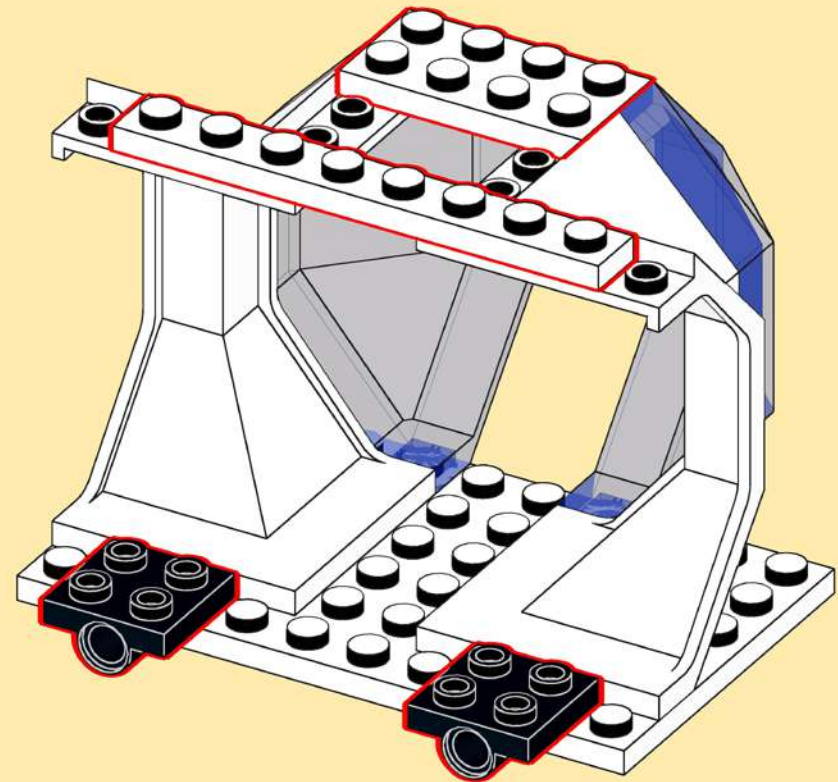
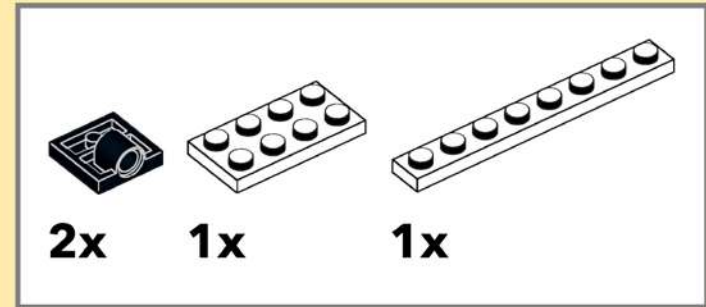

3

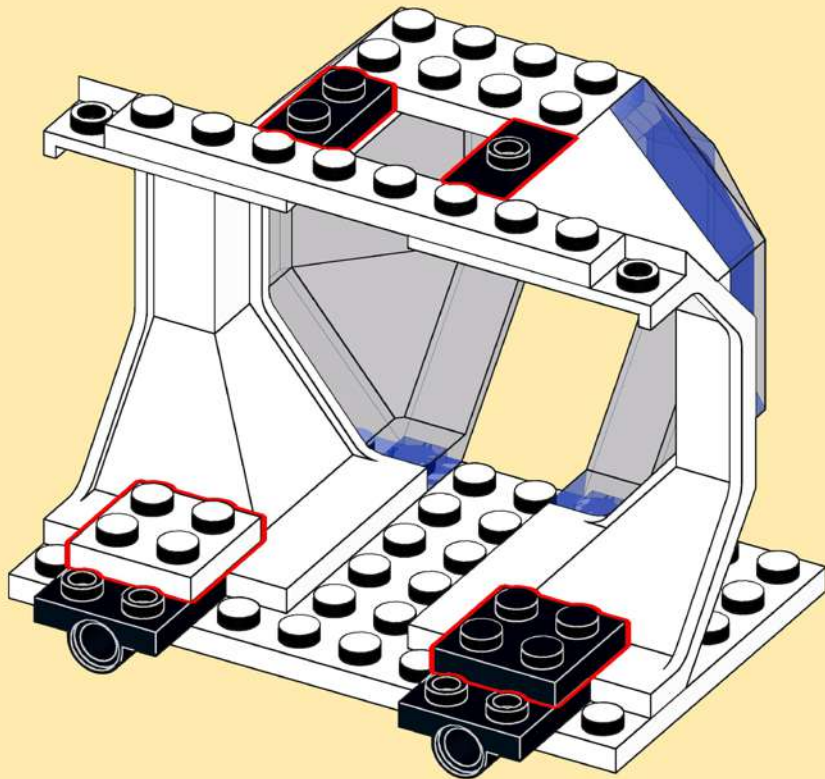
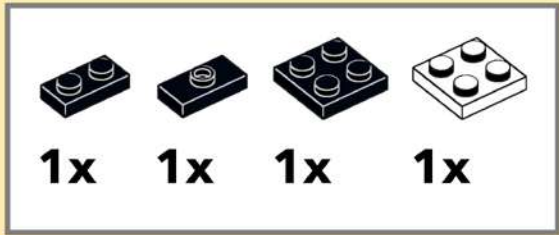

4

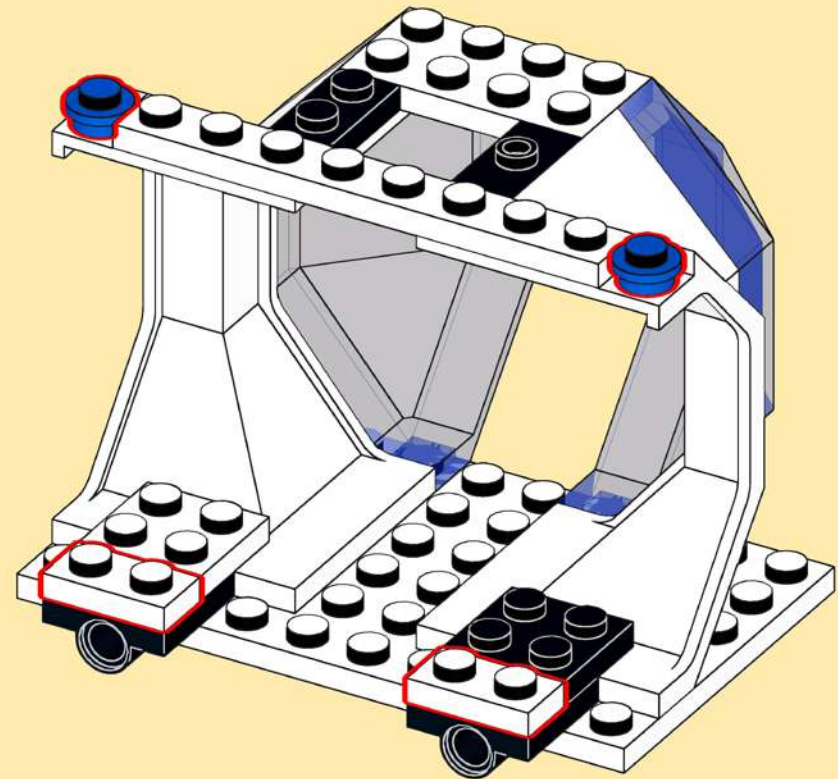
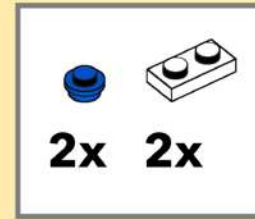

5

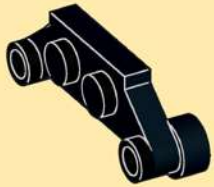

6



7

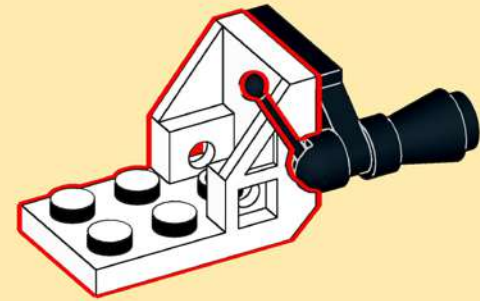
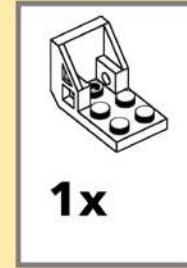

8

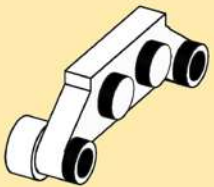
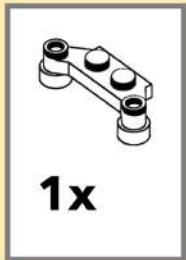

9

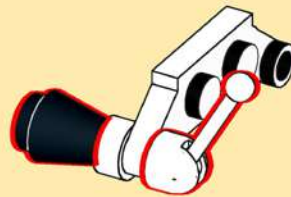

10

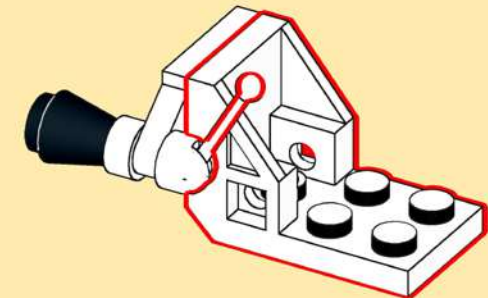
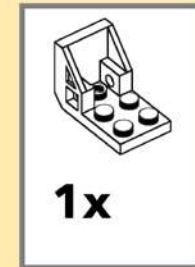

11

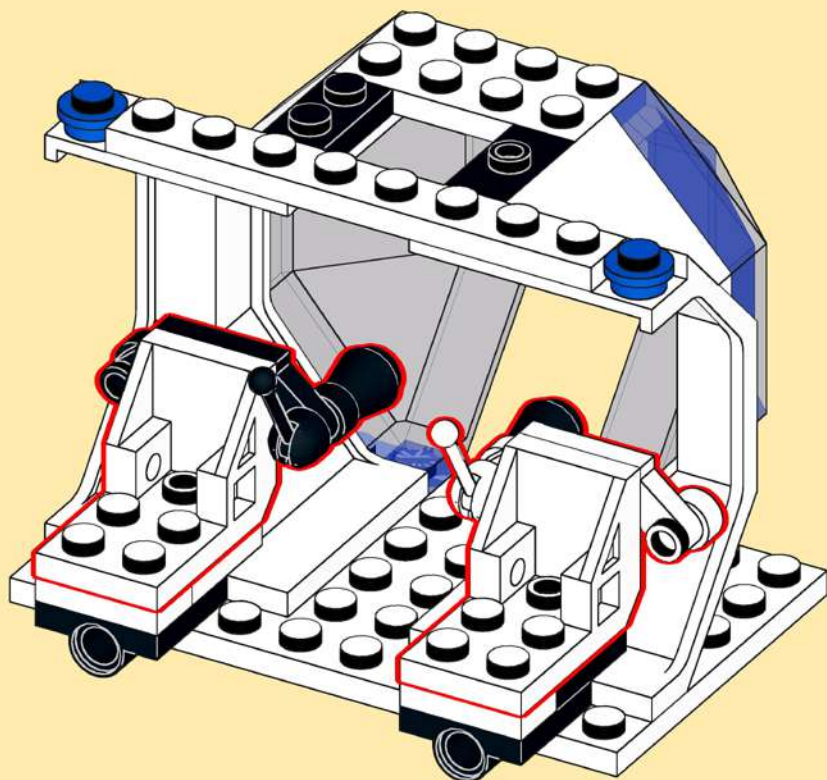

12

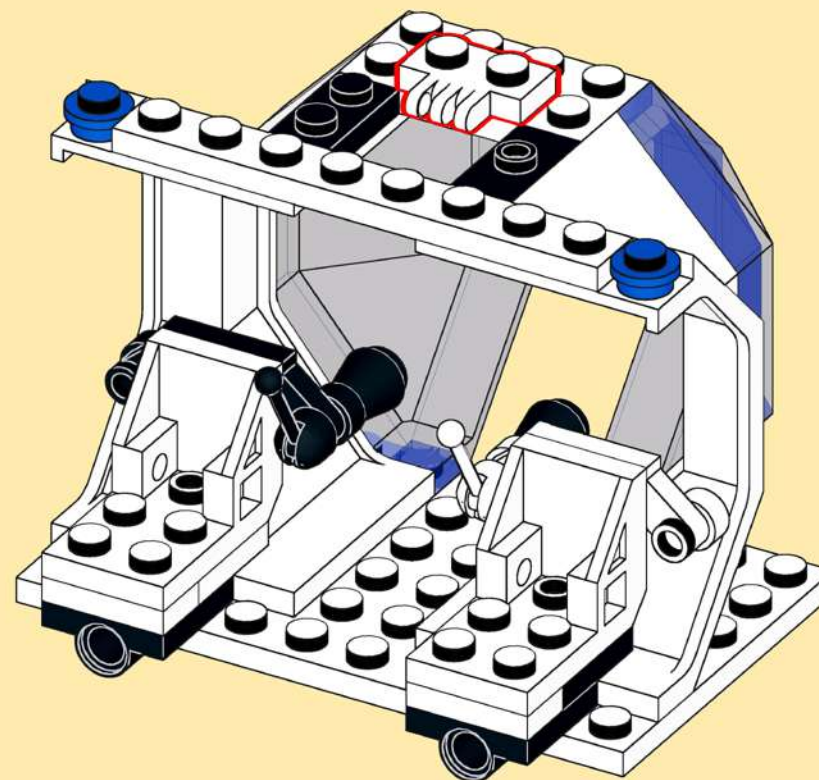
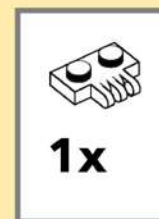

13

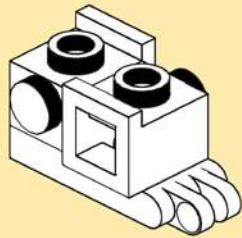
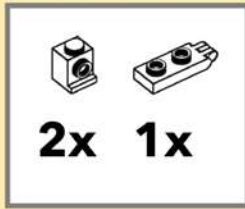

14

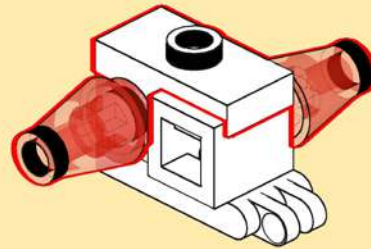
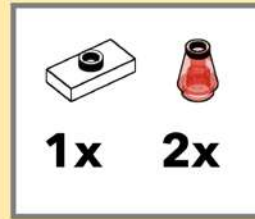

15

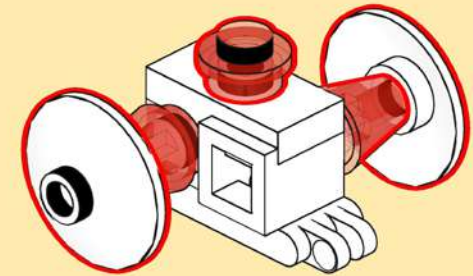
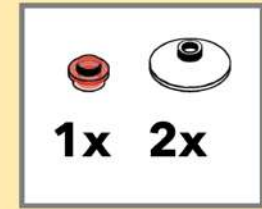

16

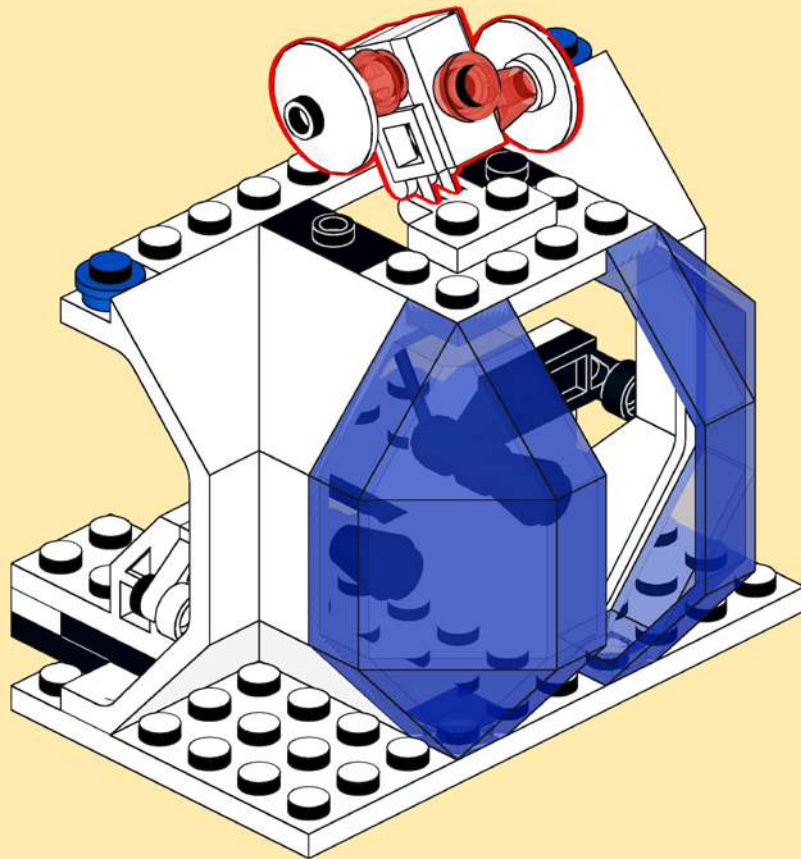

17

