



6986
MISSION COMMANDER
ALTERNATE MODEL (1989)

INSTRUCTIONS

CONCEPT BY BJARNE TVESKOV & LEGO
PHOTOGRAPHY & INSTRUCTIONS
BY COSMIC.BRICK



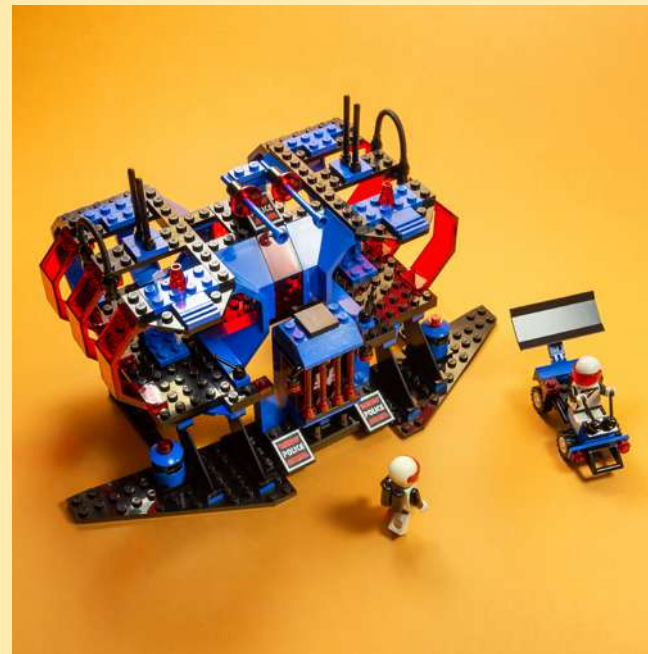

1

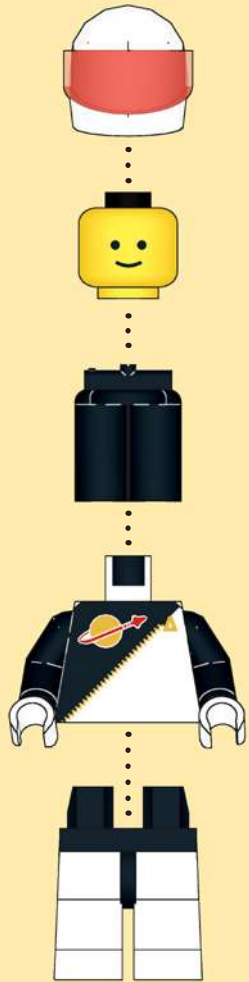

2



1

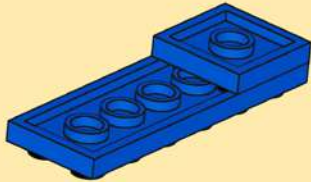
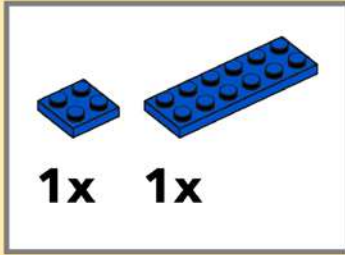

2

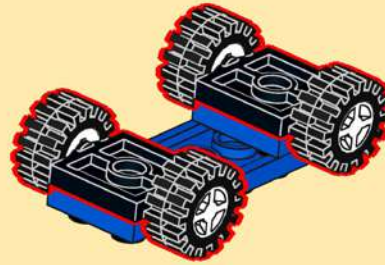
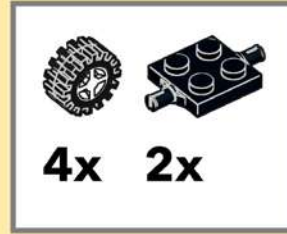

3

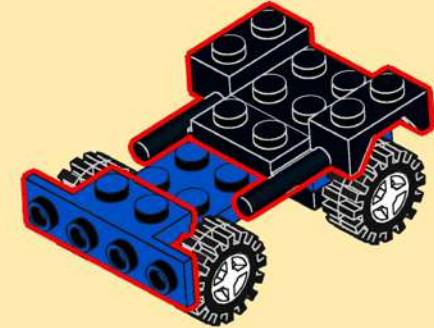
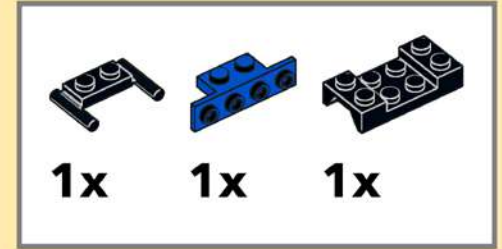

4

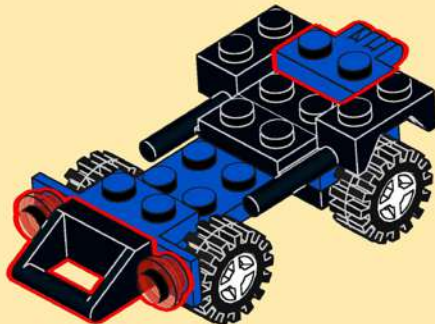
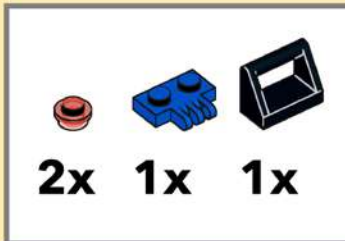

5

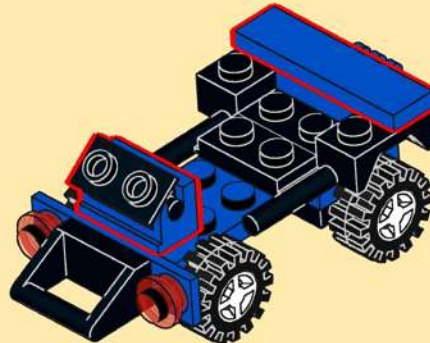
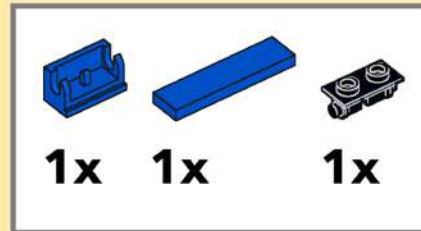

6

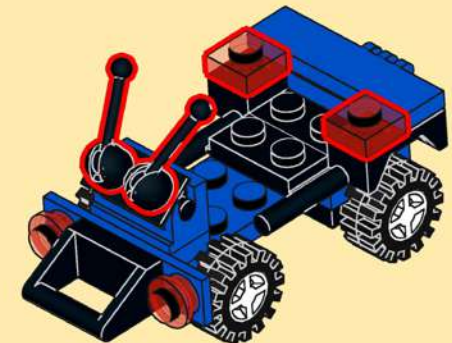
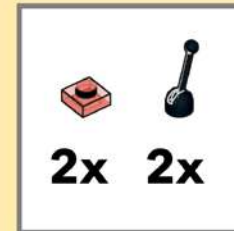

7

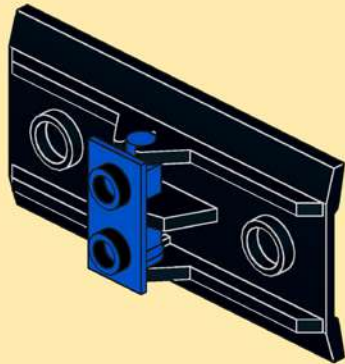
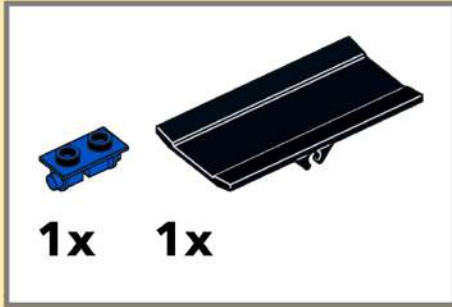

8

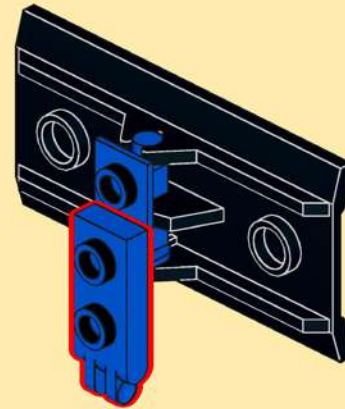
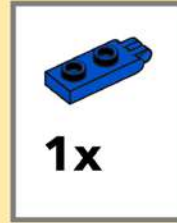

9

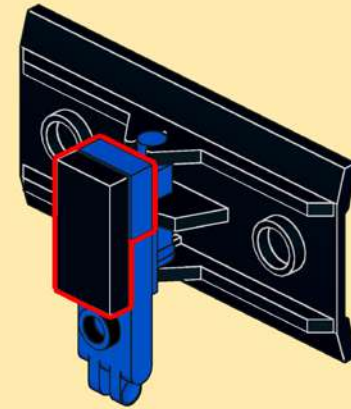
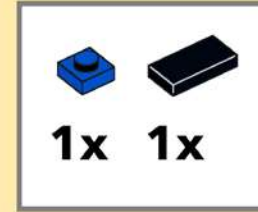

10

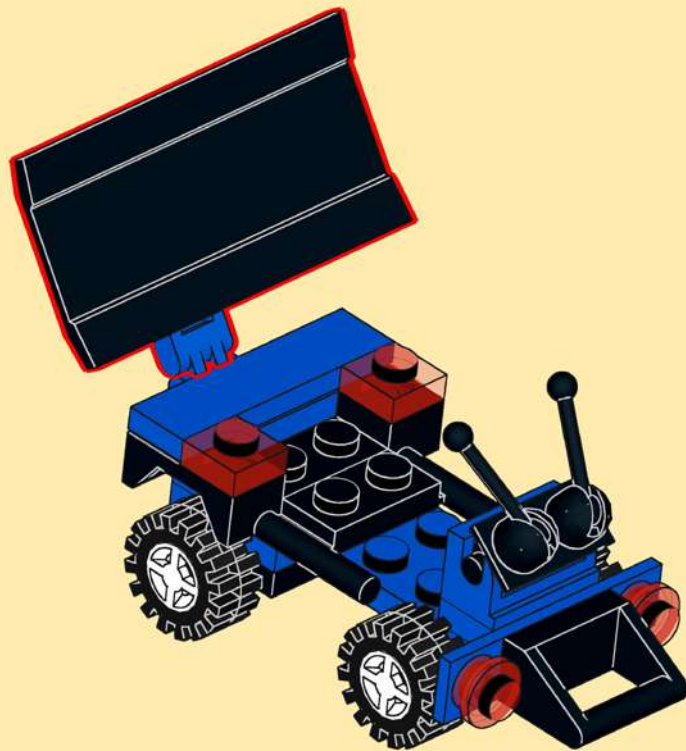

11

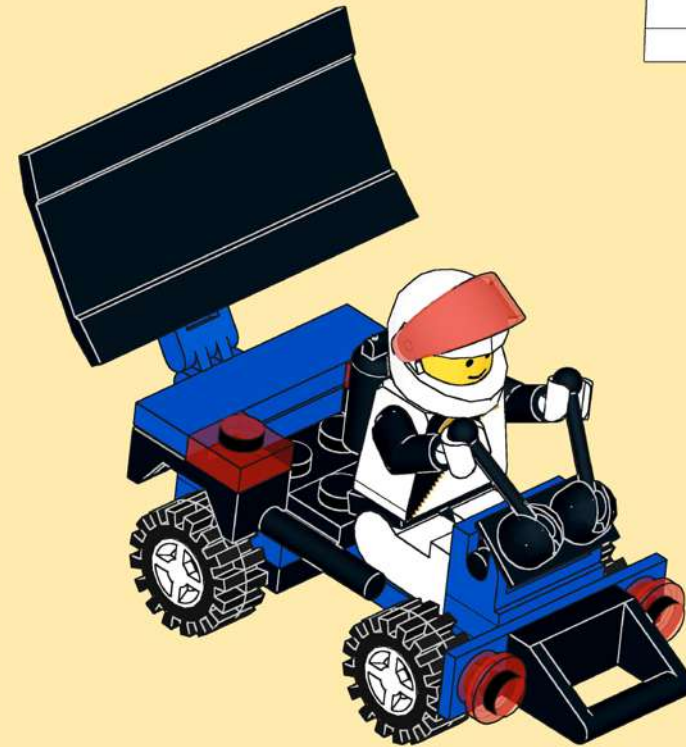

1

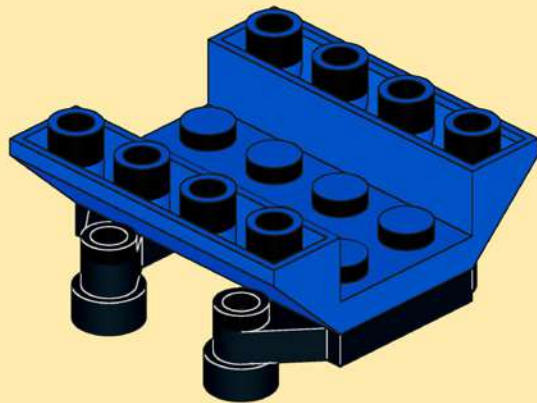
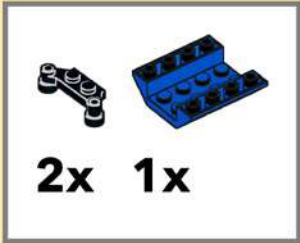

2

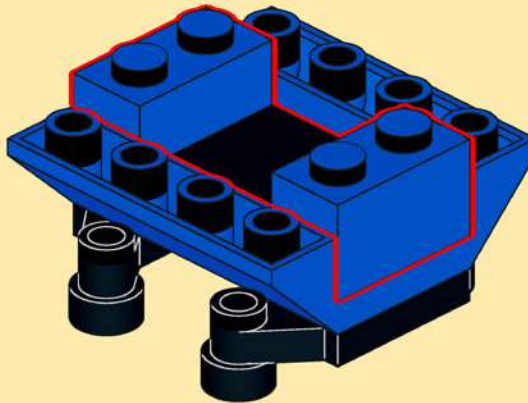
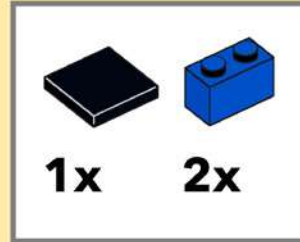

3

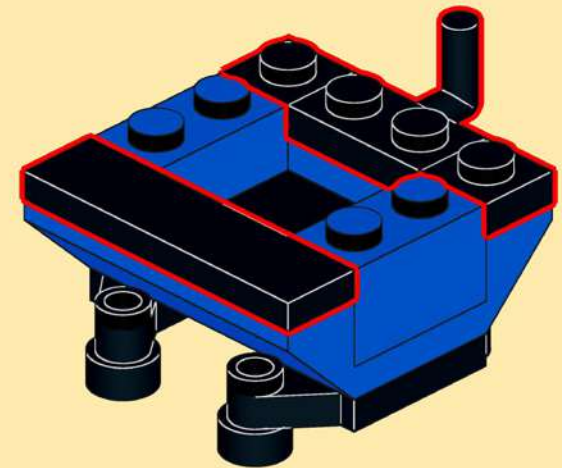
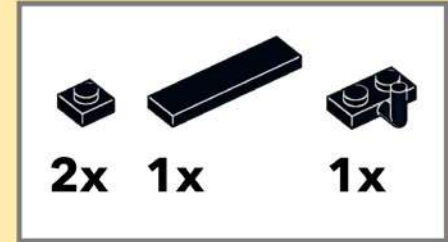

4

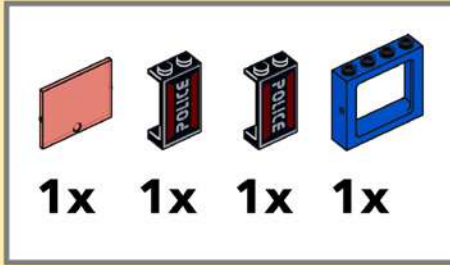

5

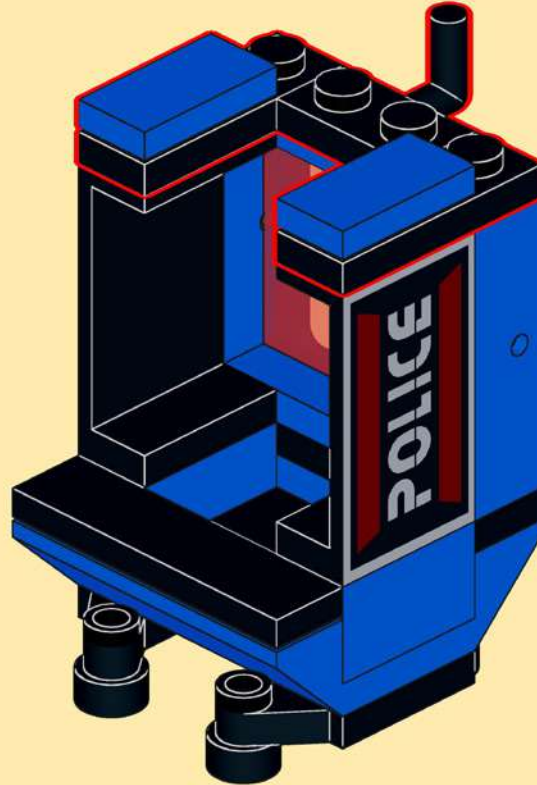
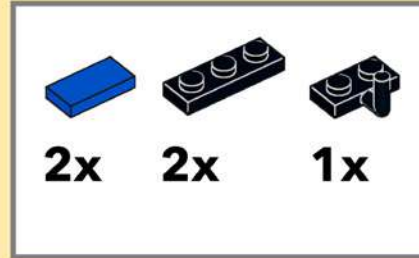

6

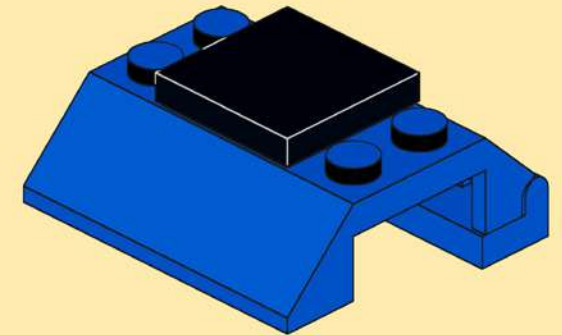
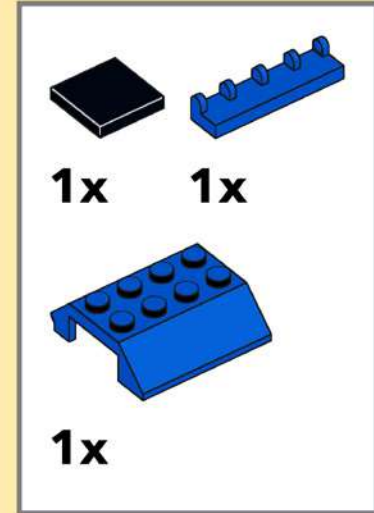

7

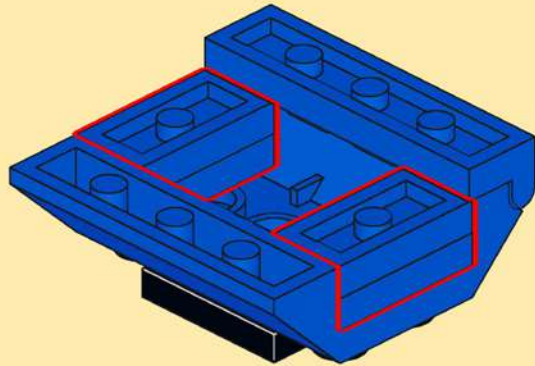
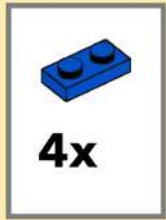

8

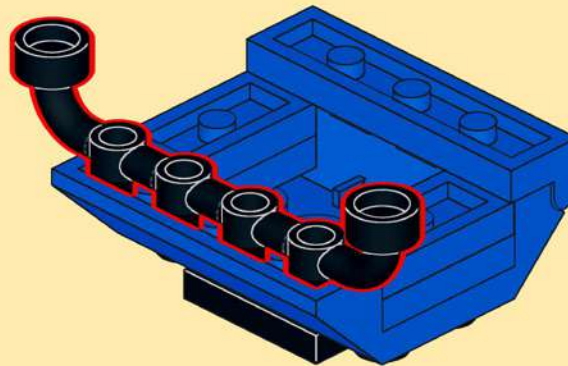

9

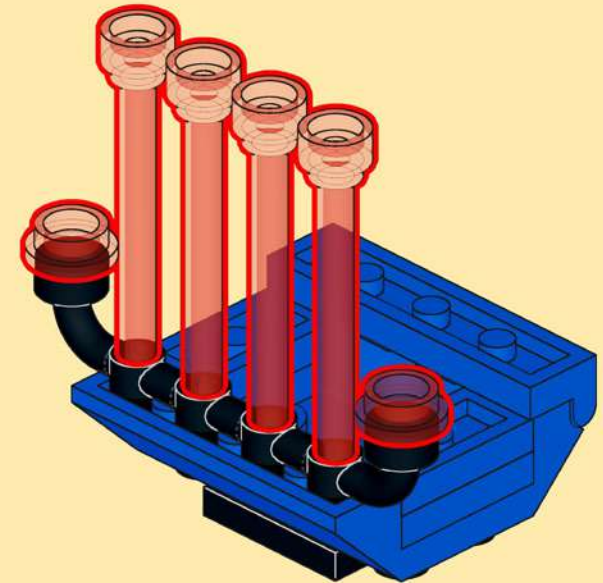
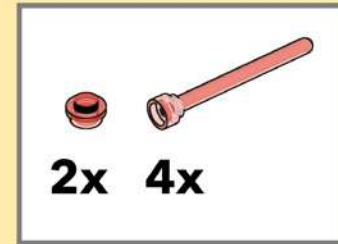

10

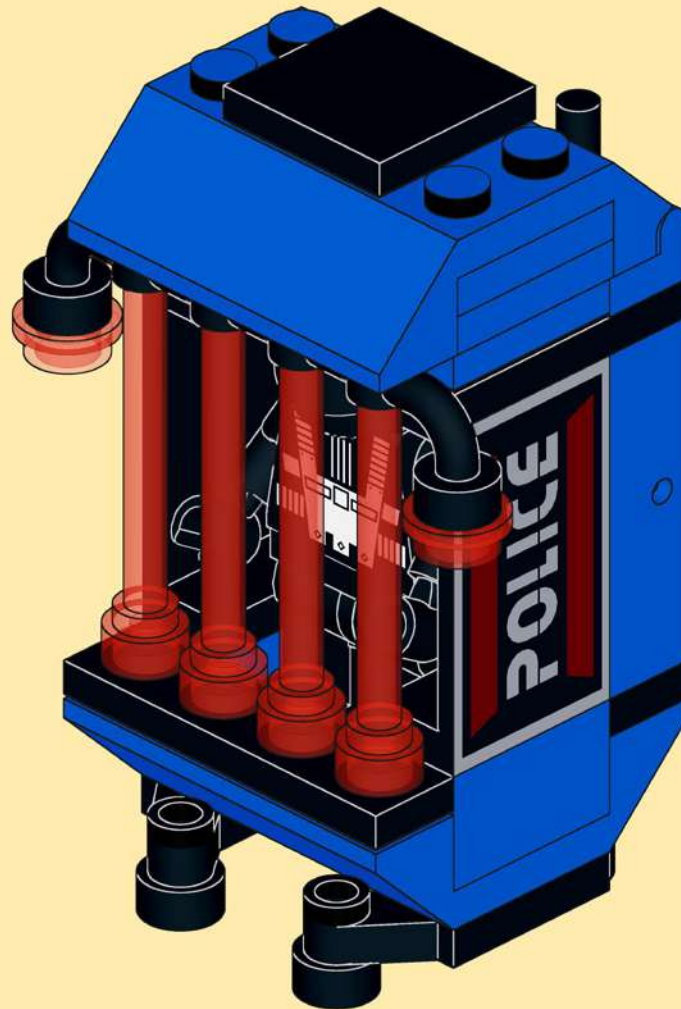

1

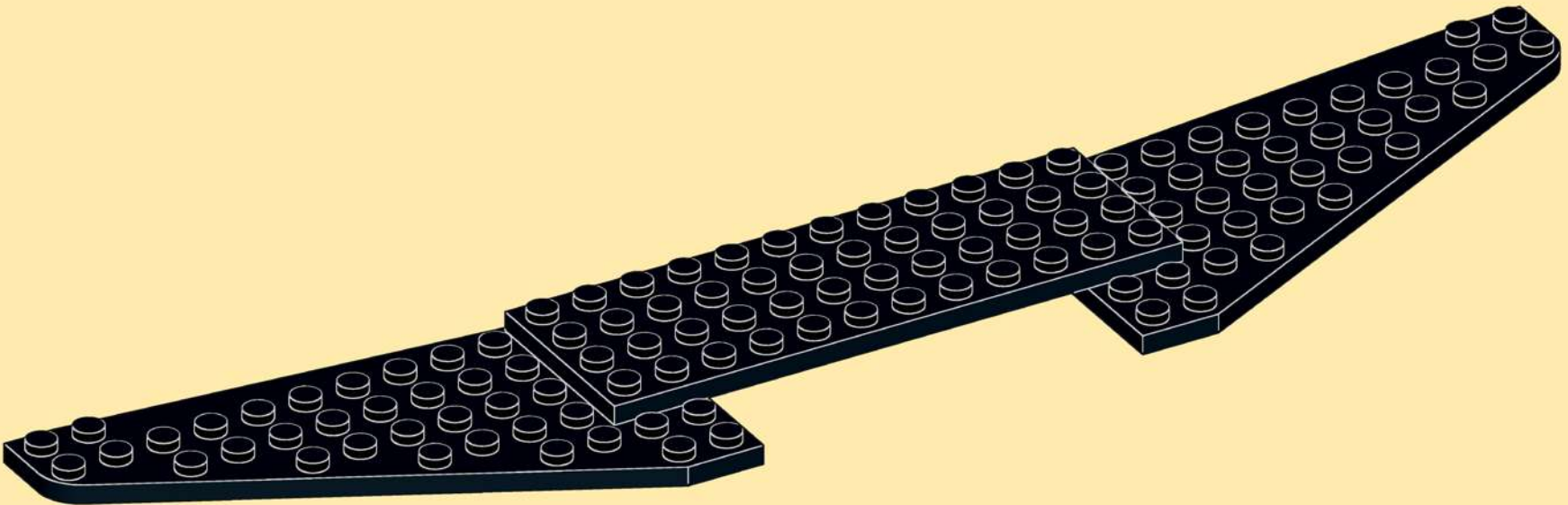
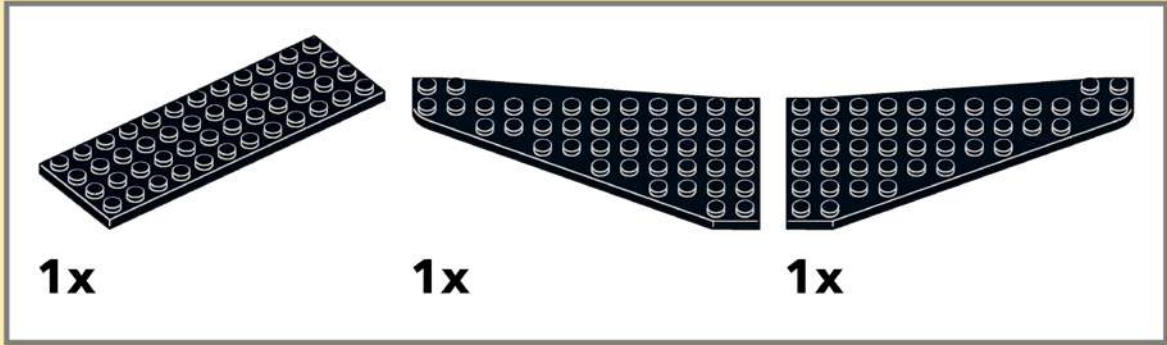

2

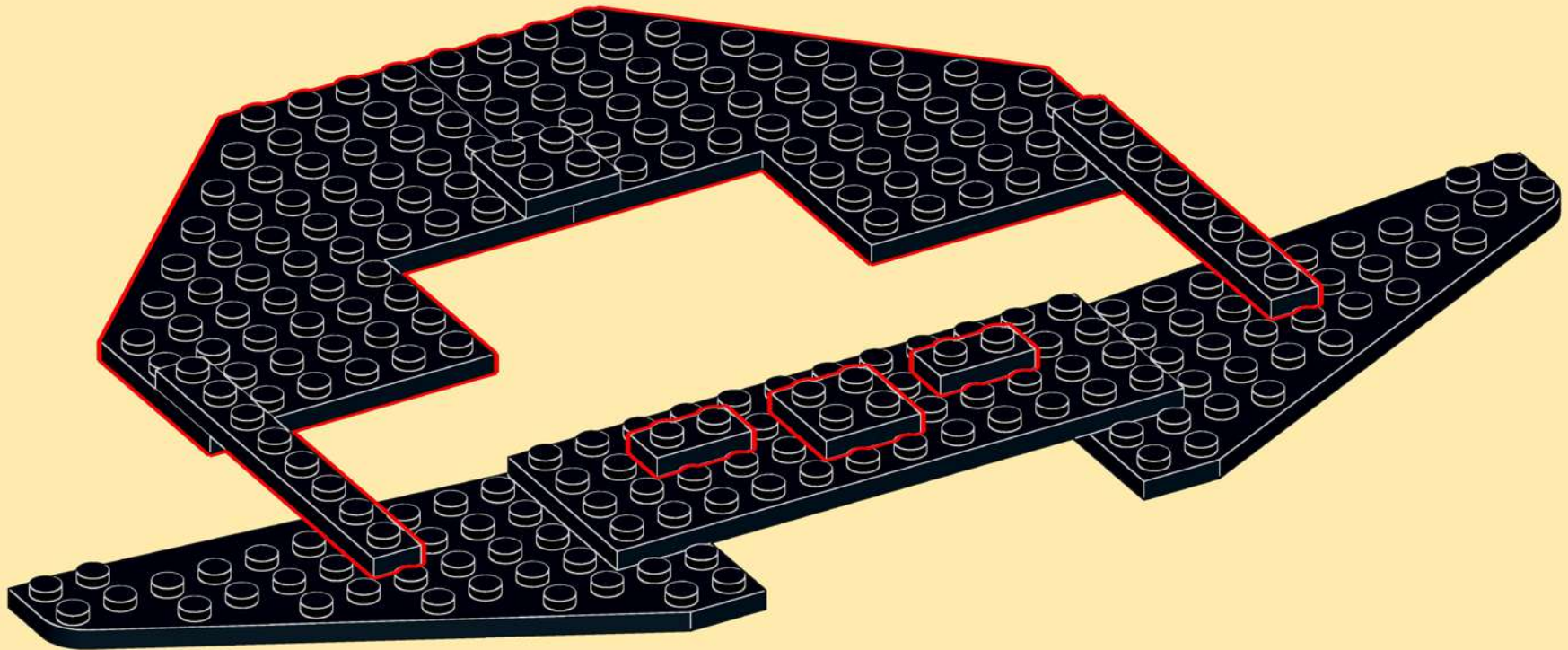
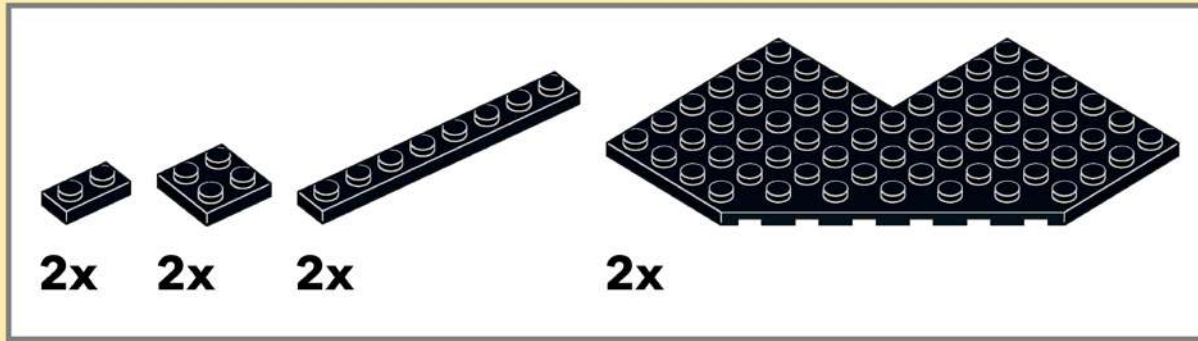

3

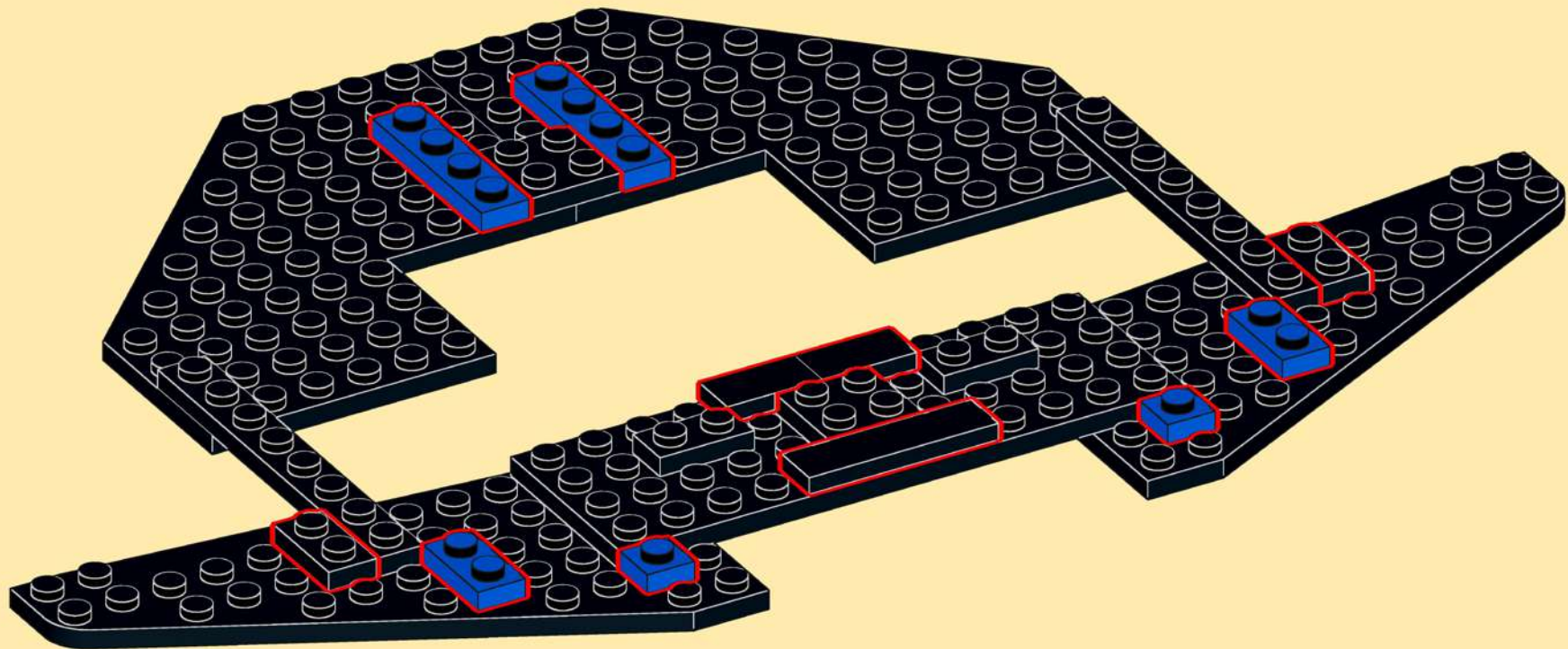
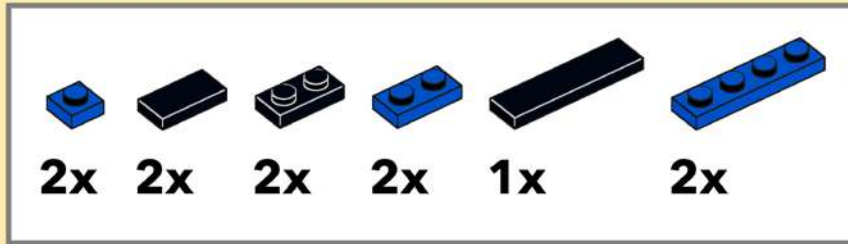

4

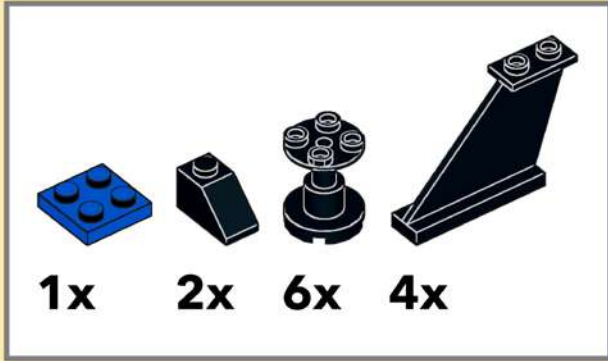

Accuracy

Whilst this build is aimed to be an exact replica of the back wall depiction, please note the two slopes and this far right support piece aren't shown in the original image.

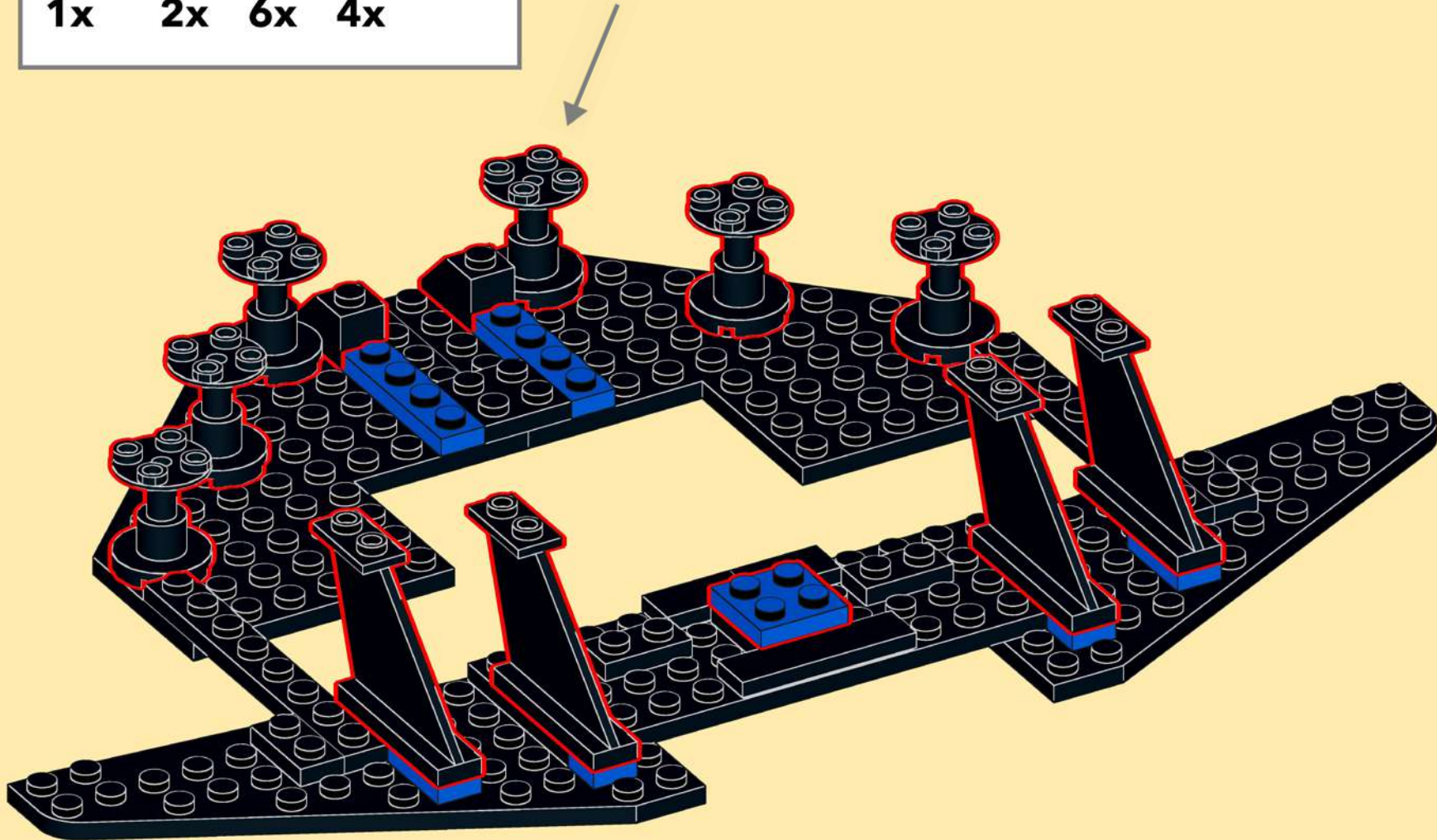

5

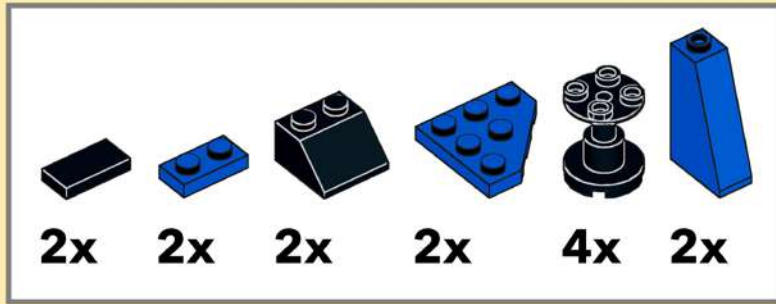

Accuracy

Whilst this build is aimed to be an exact replica of the back wall depiction, please note the two 2x2 slopes aren't shown in the original image.

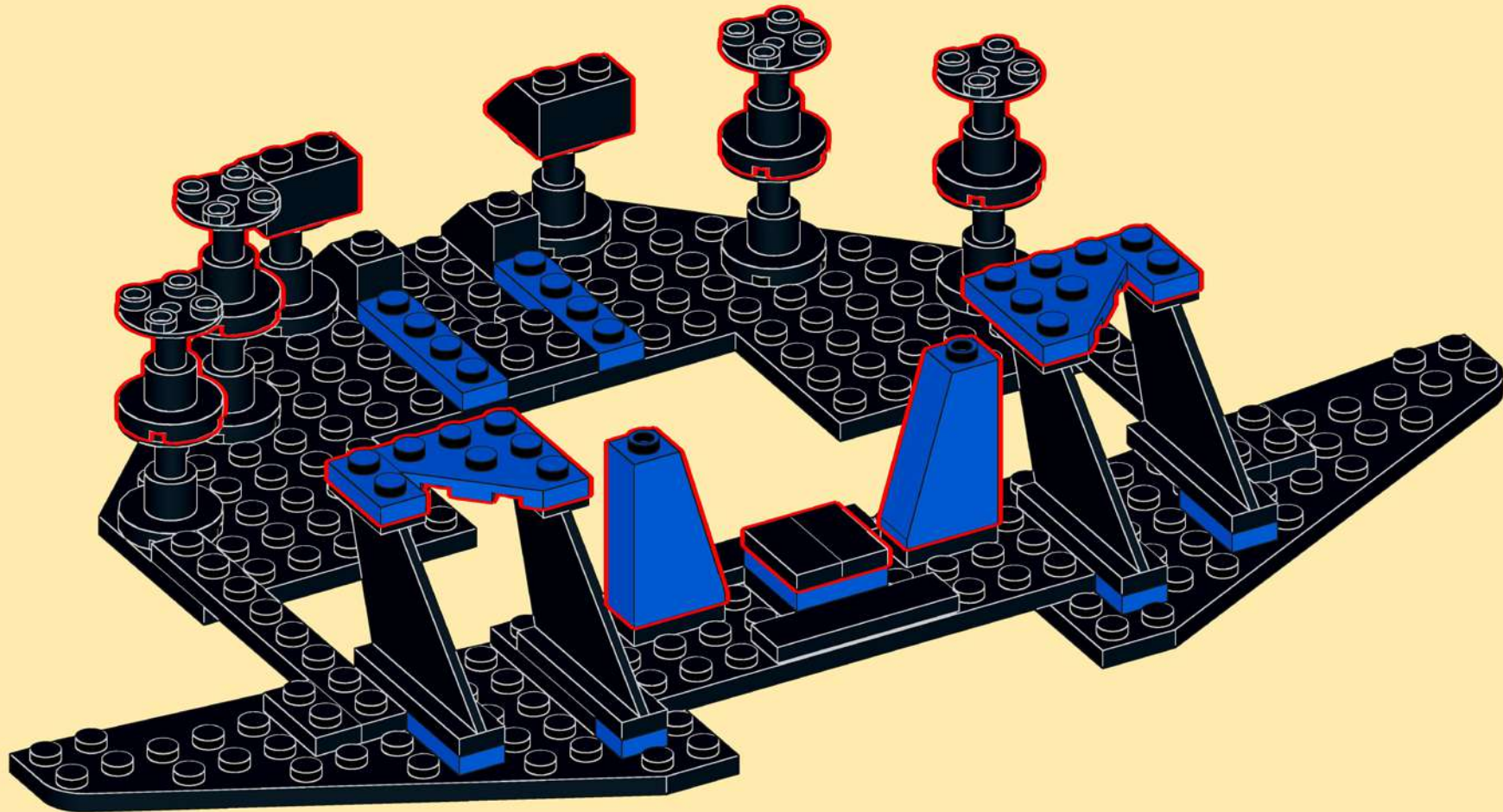

6

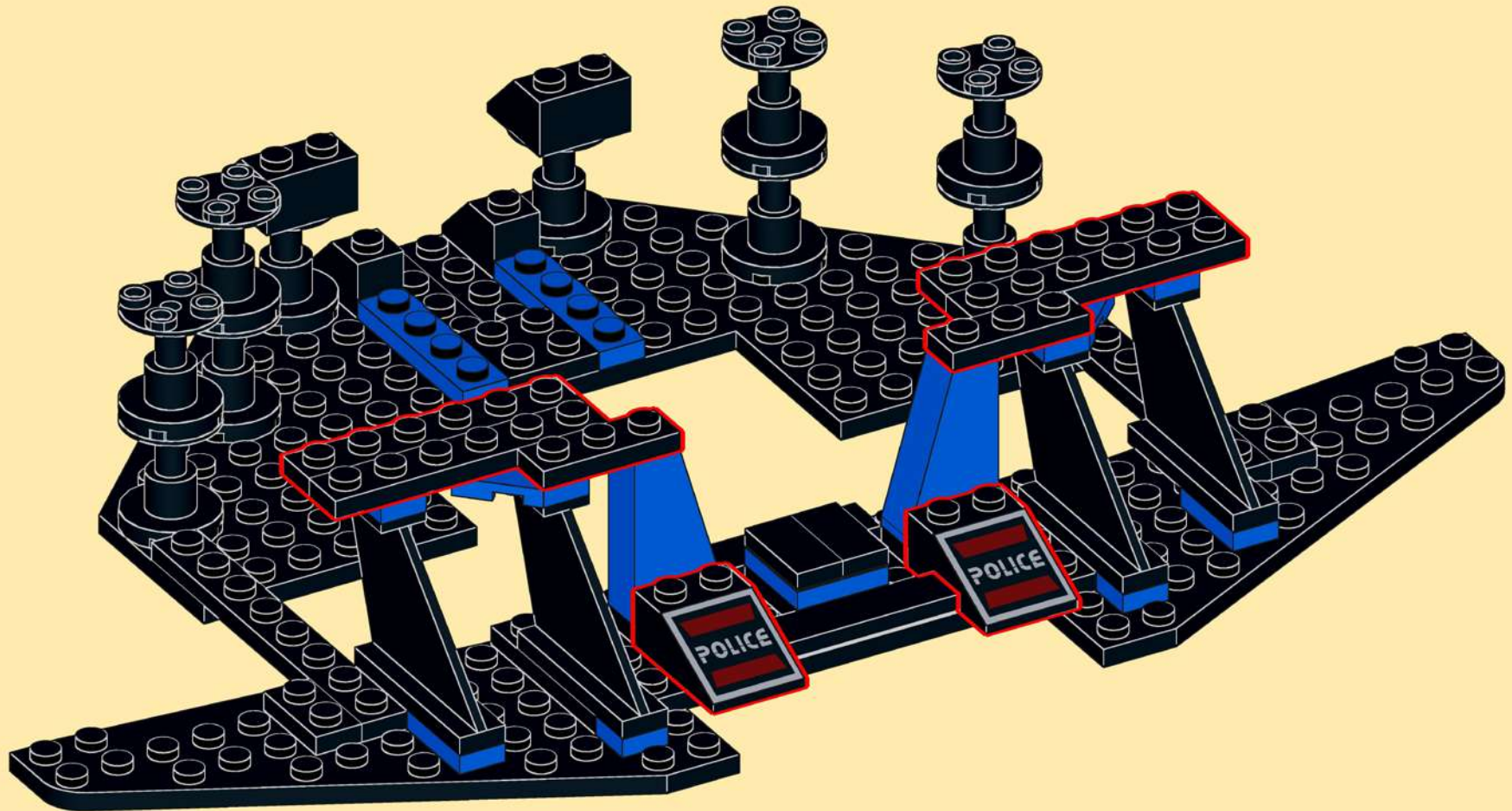

7



2x

1

2

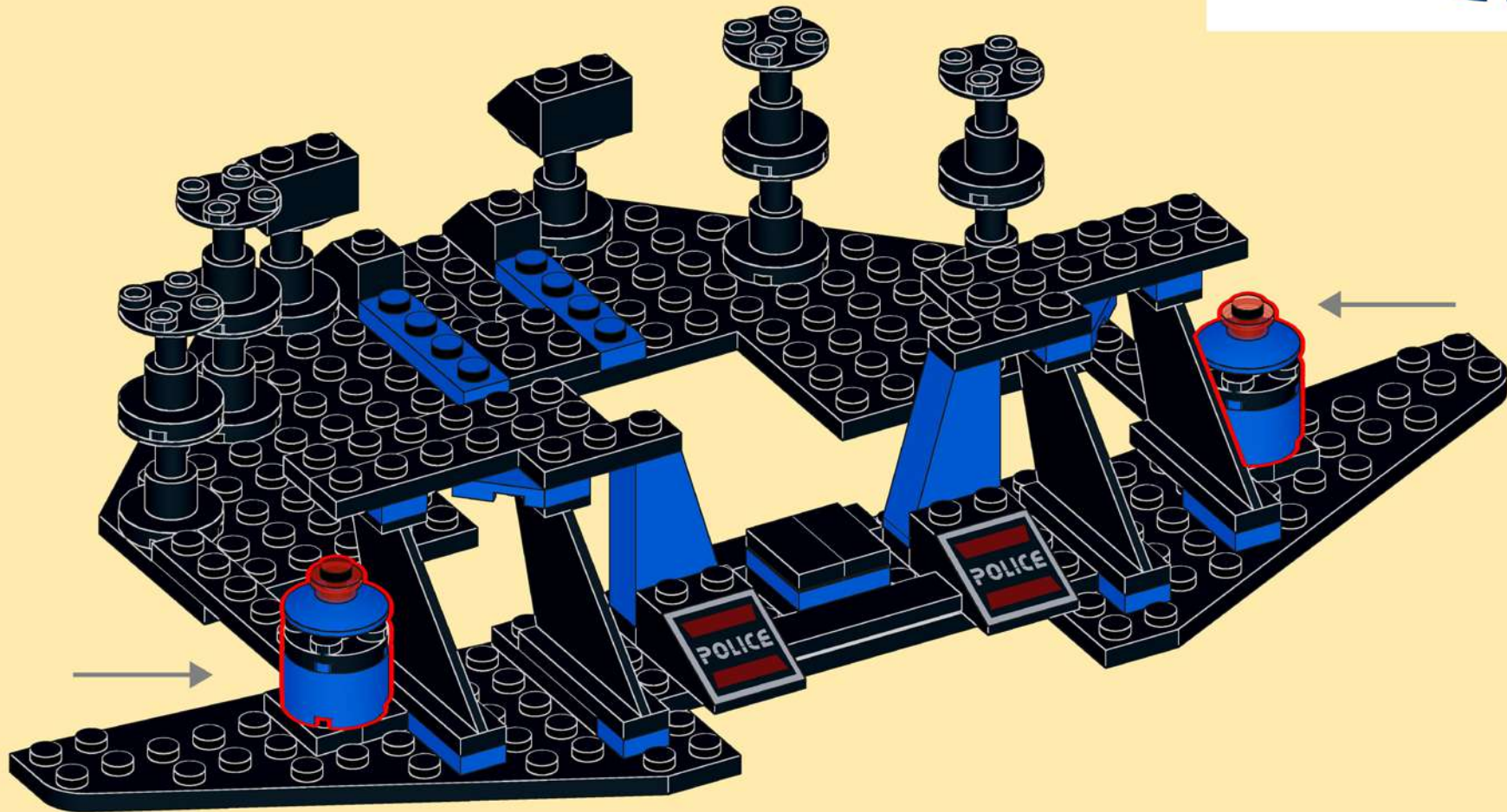
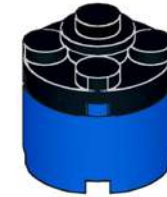

8

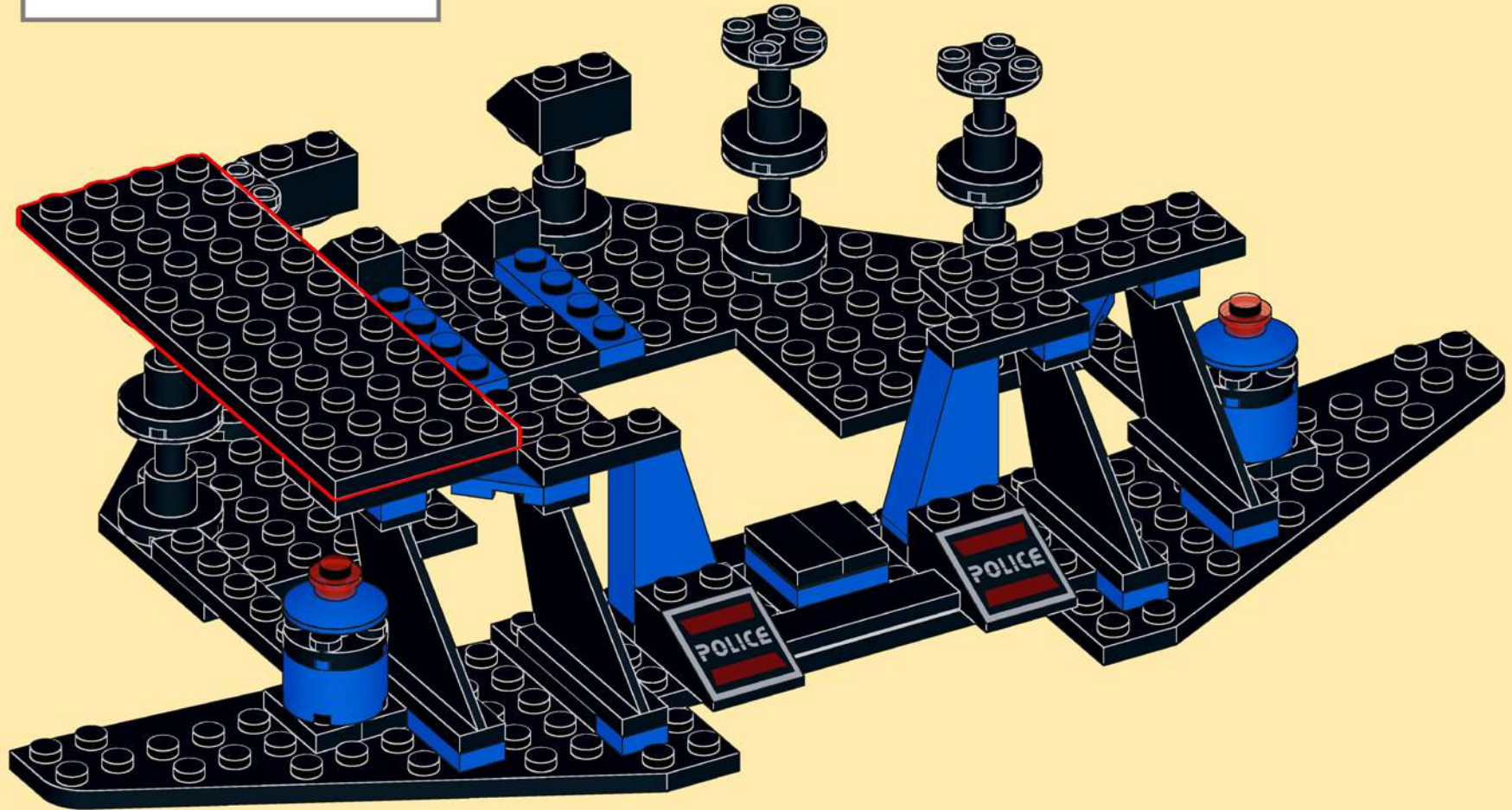

9

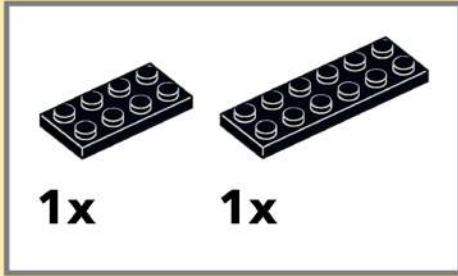

10

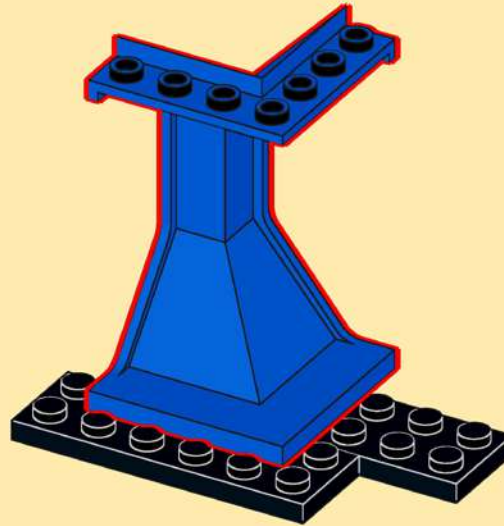
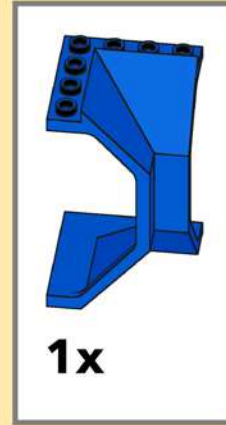

11

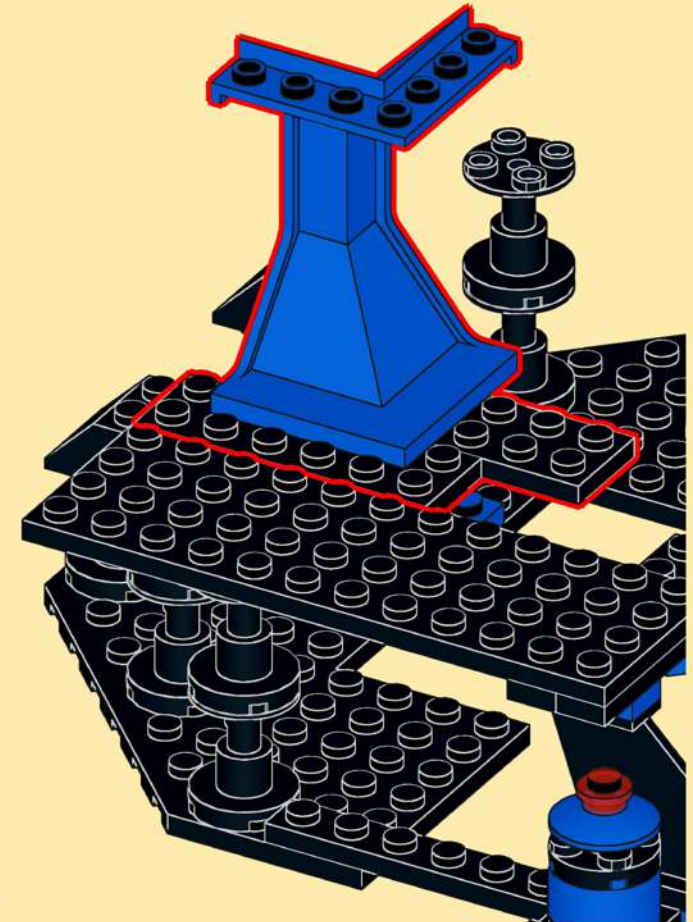

12

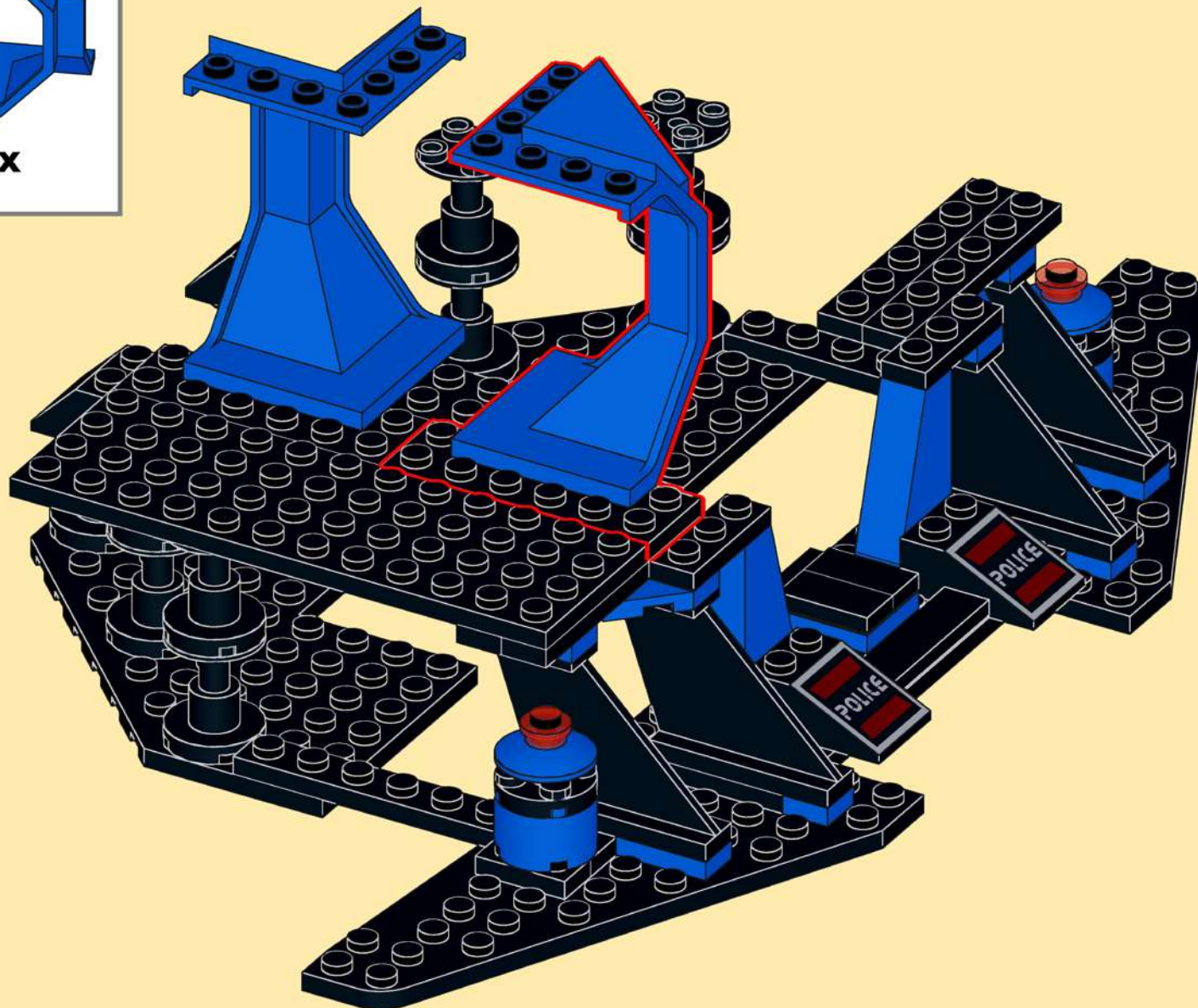
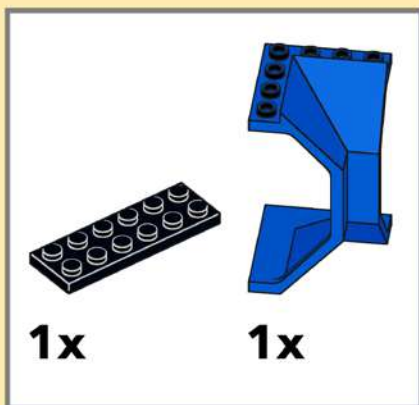

13

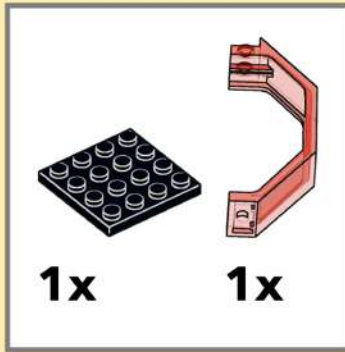

14

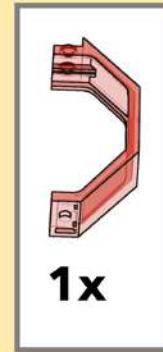

15

Construction tip

At this point the corridor floor is very unstable. Please be careful, and see it through until step 22, as this model gets its stability via the plates placed on the roof.

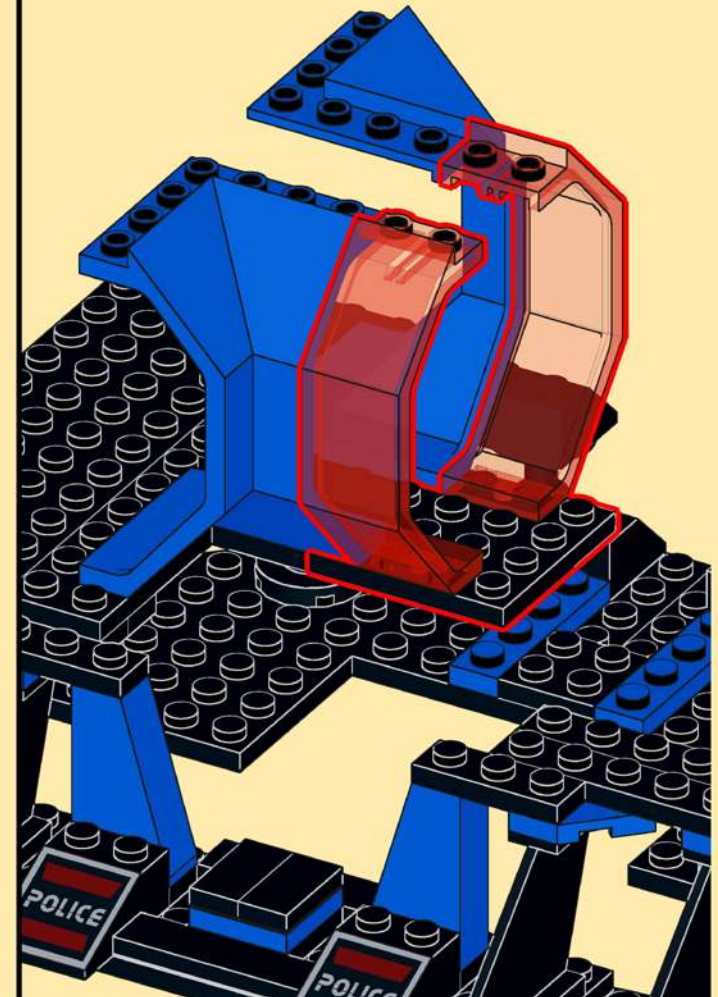

16

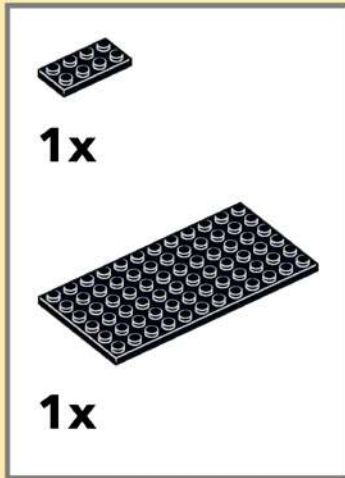

17

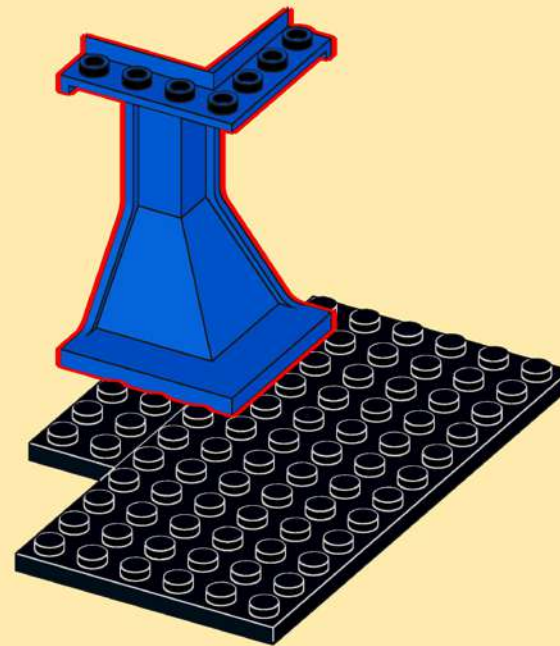
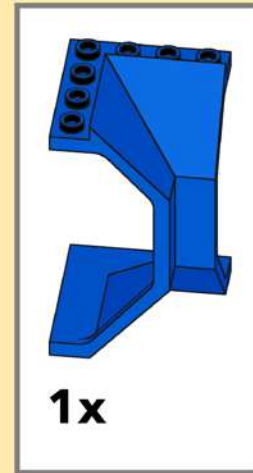

18

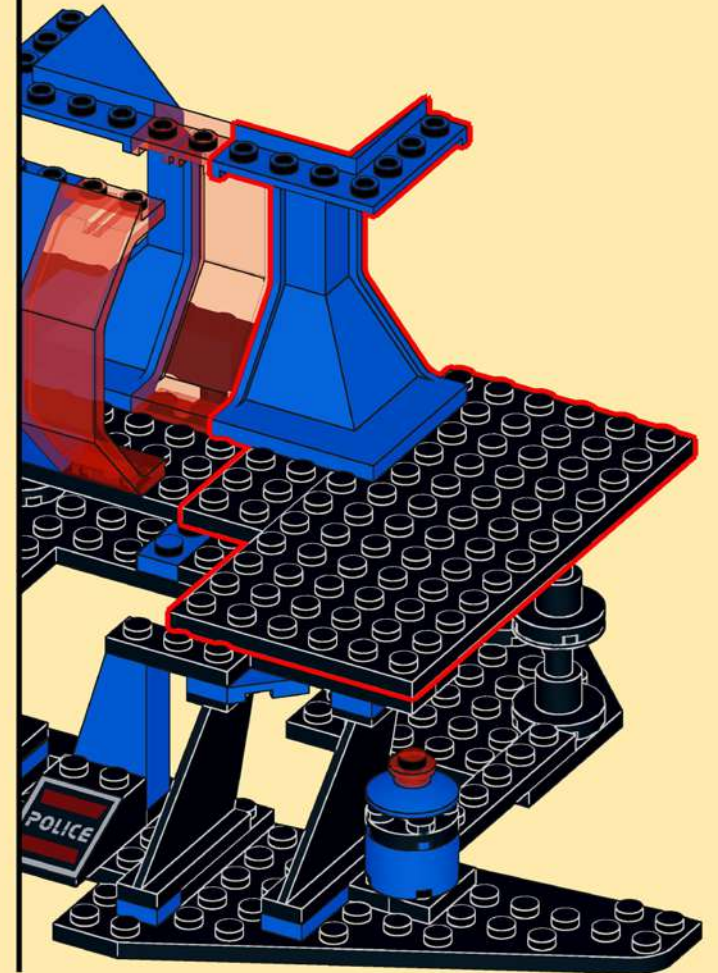

19

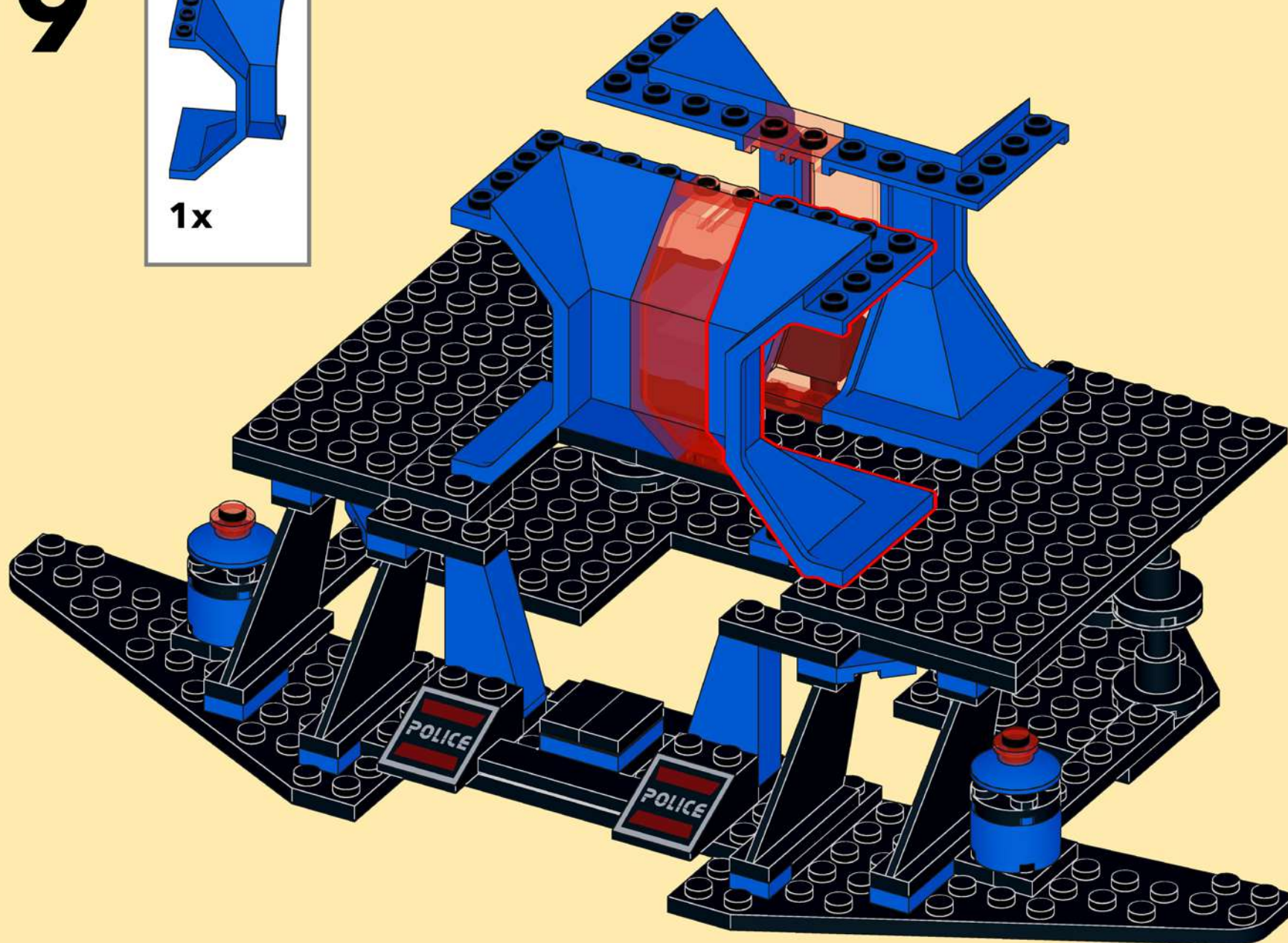
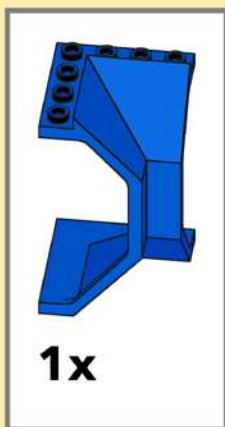

20

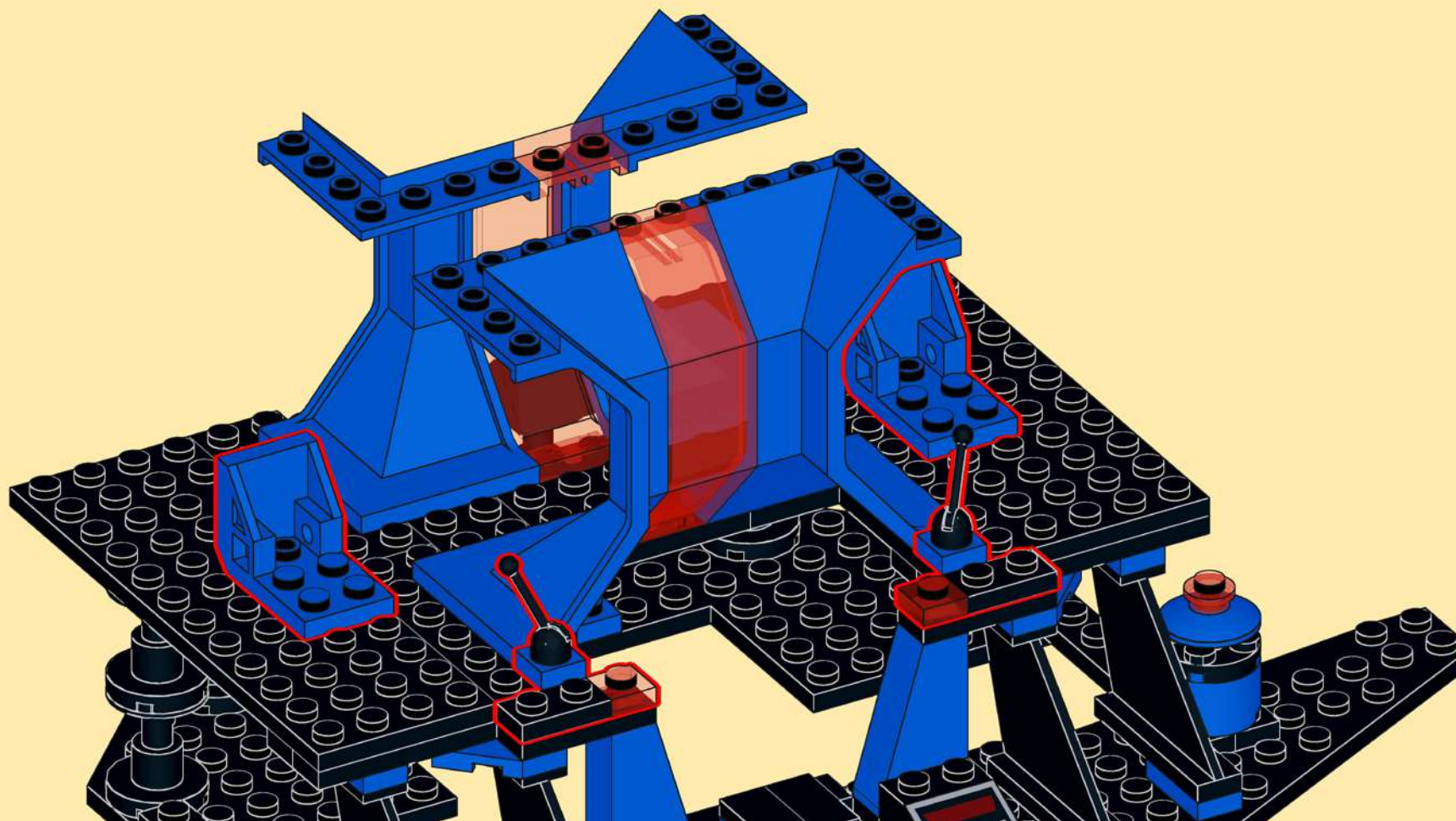

21

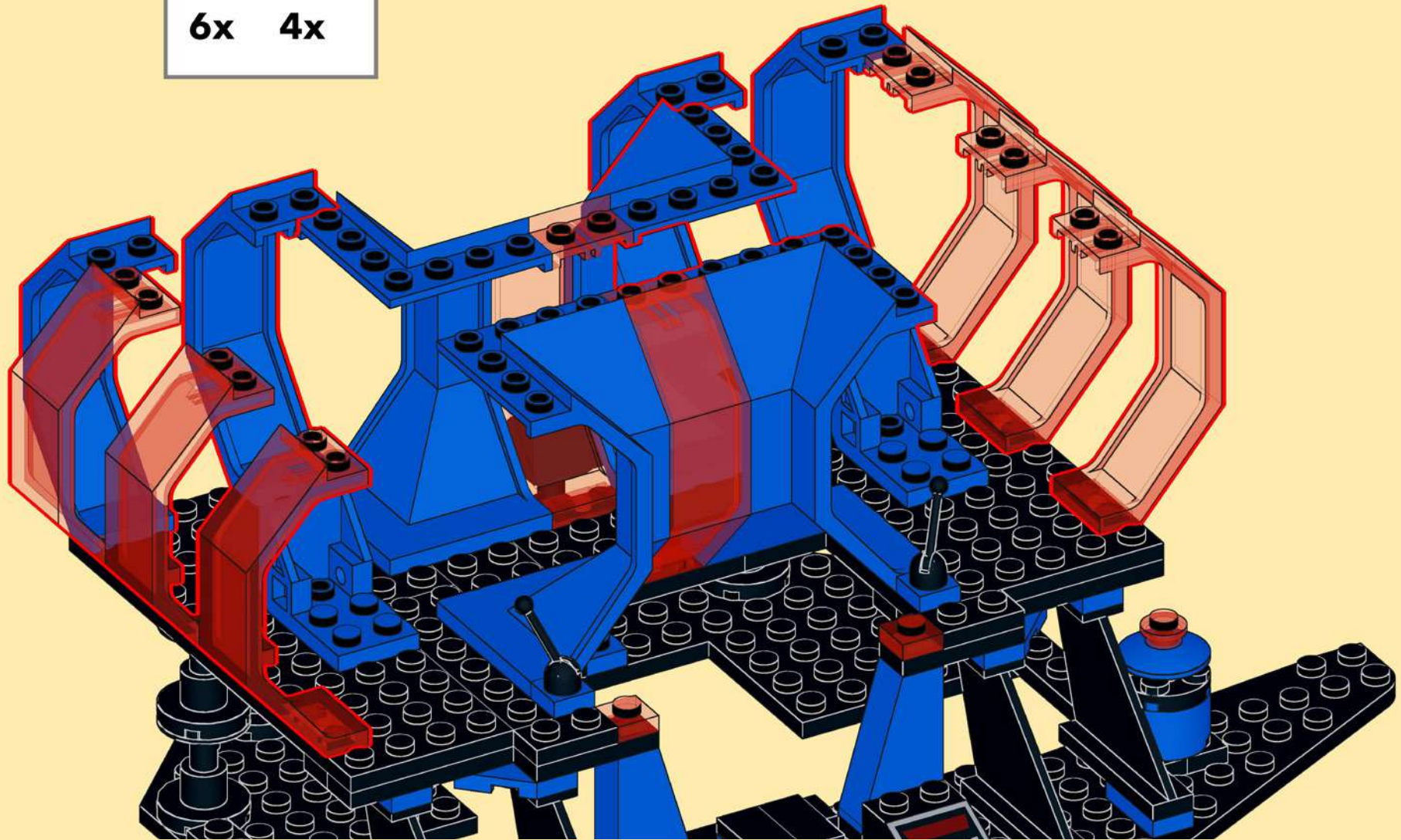
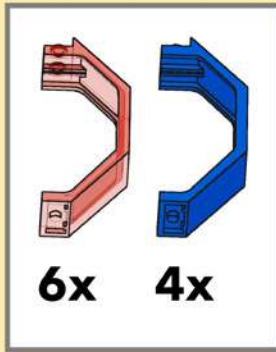

22

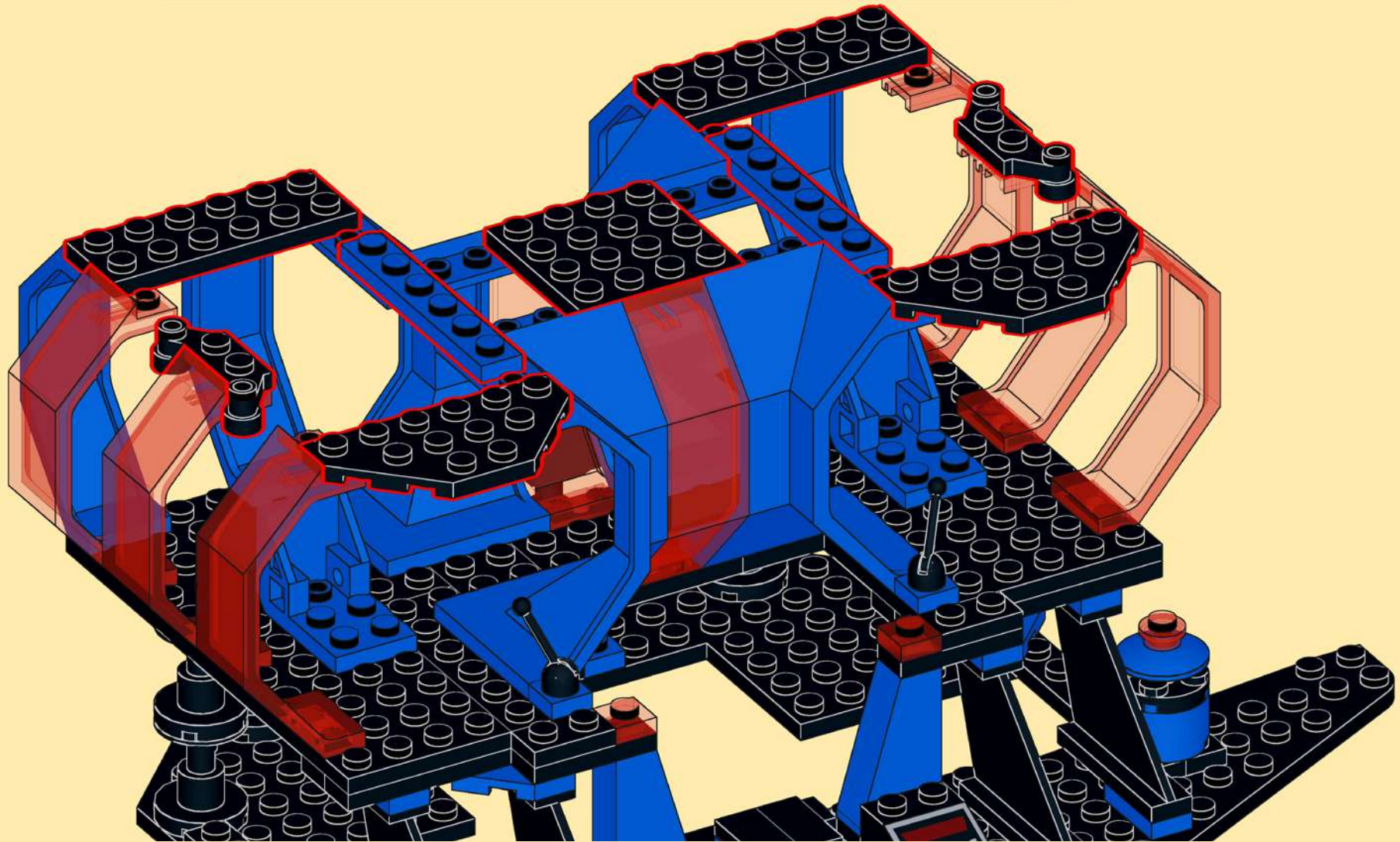
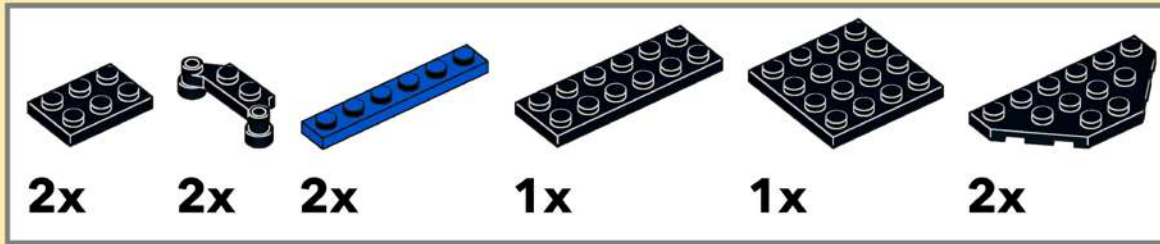

23

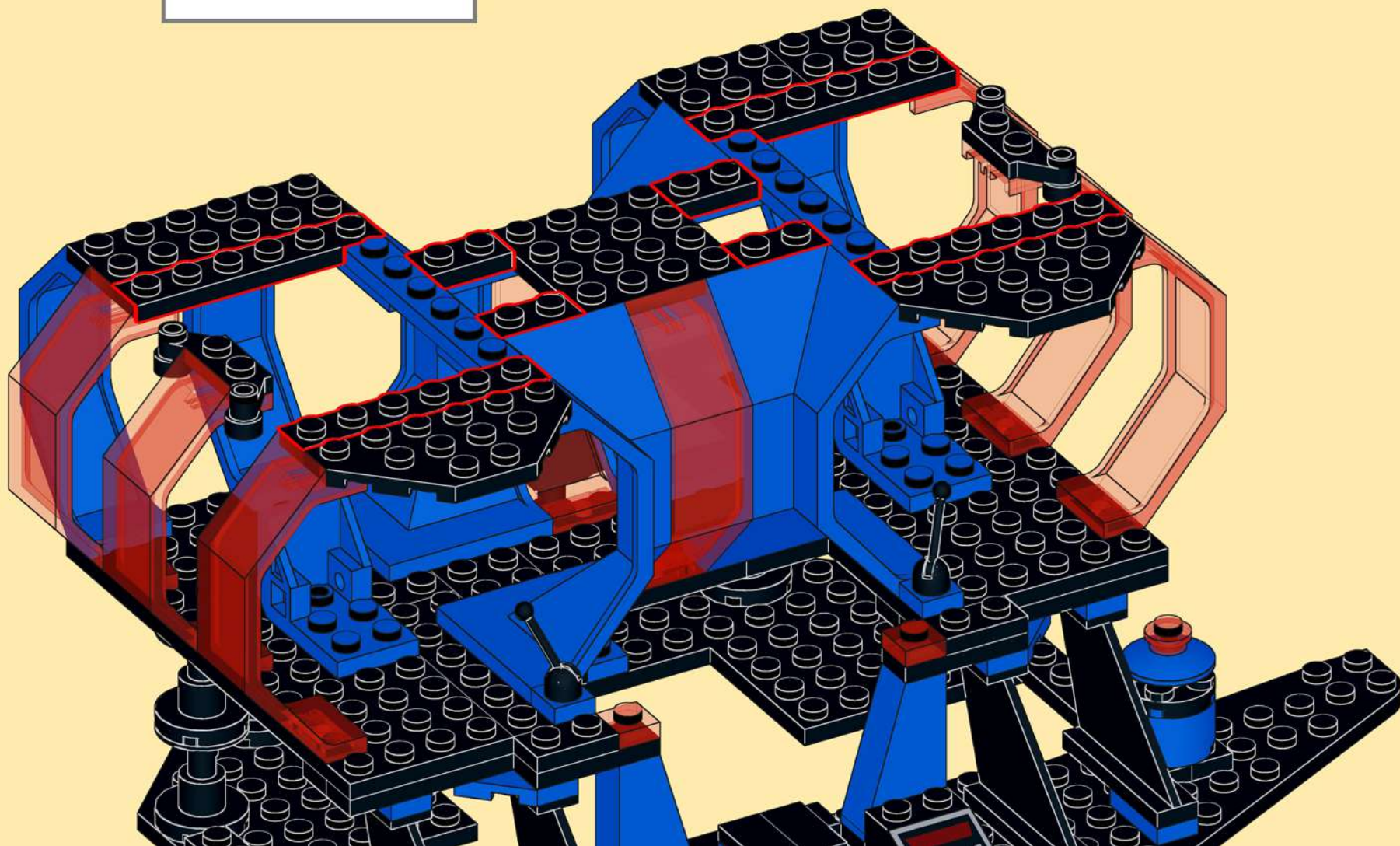
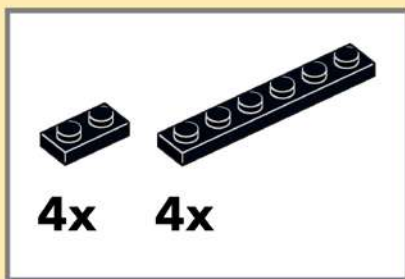

24

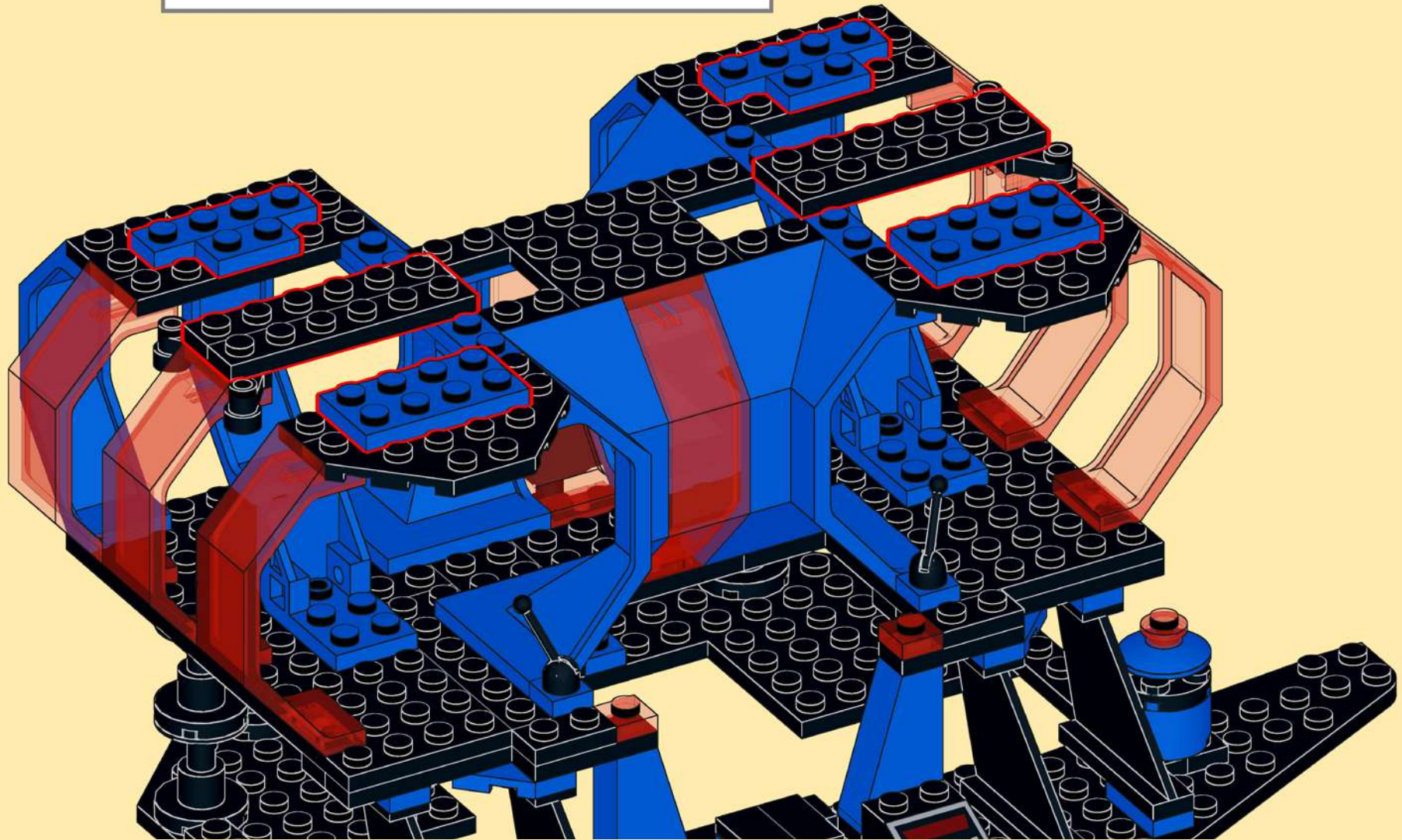
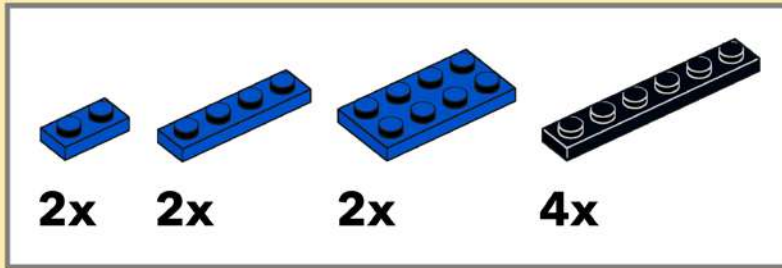

25

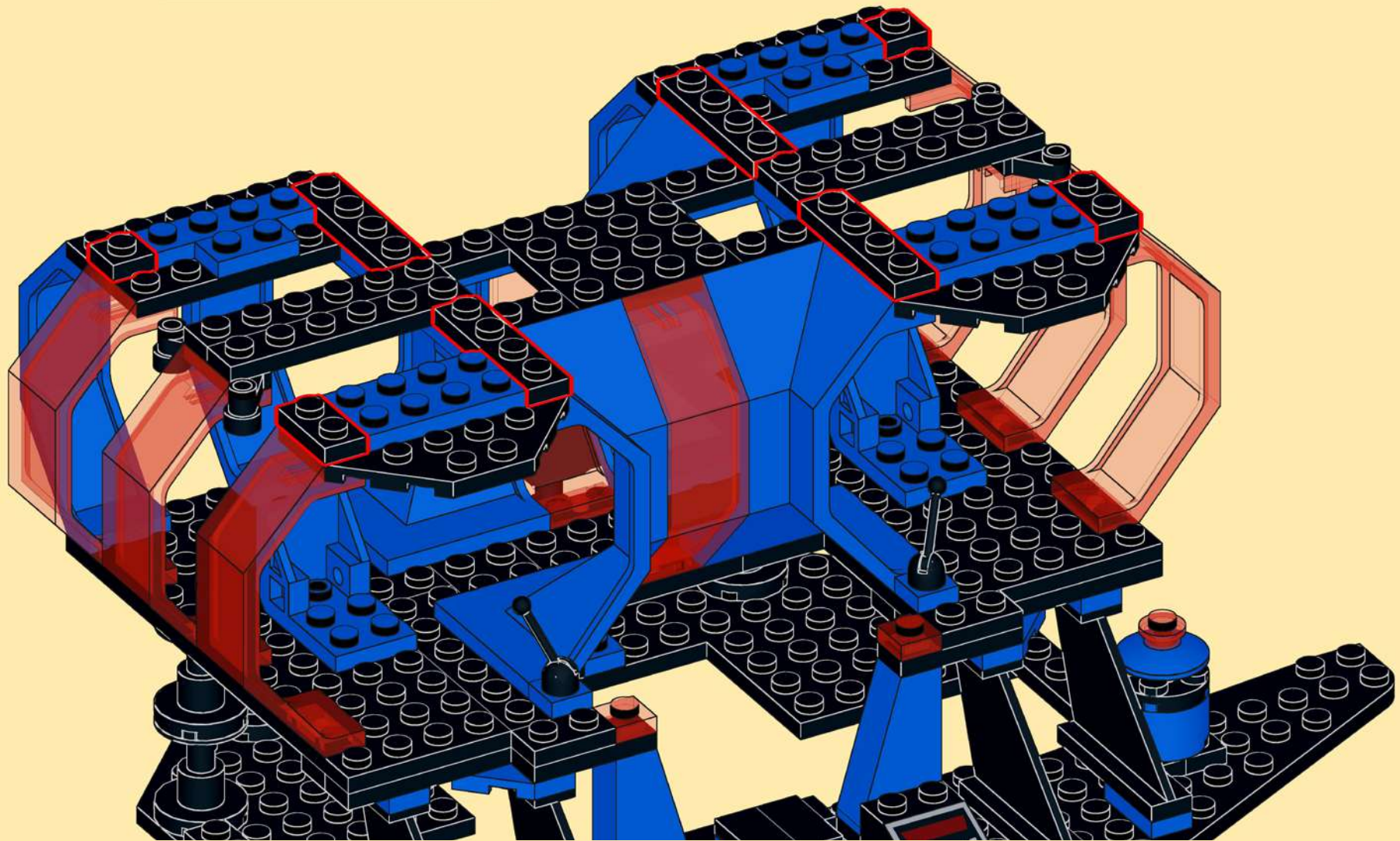
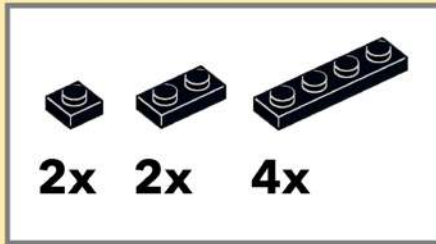

26

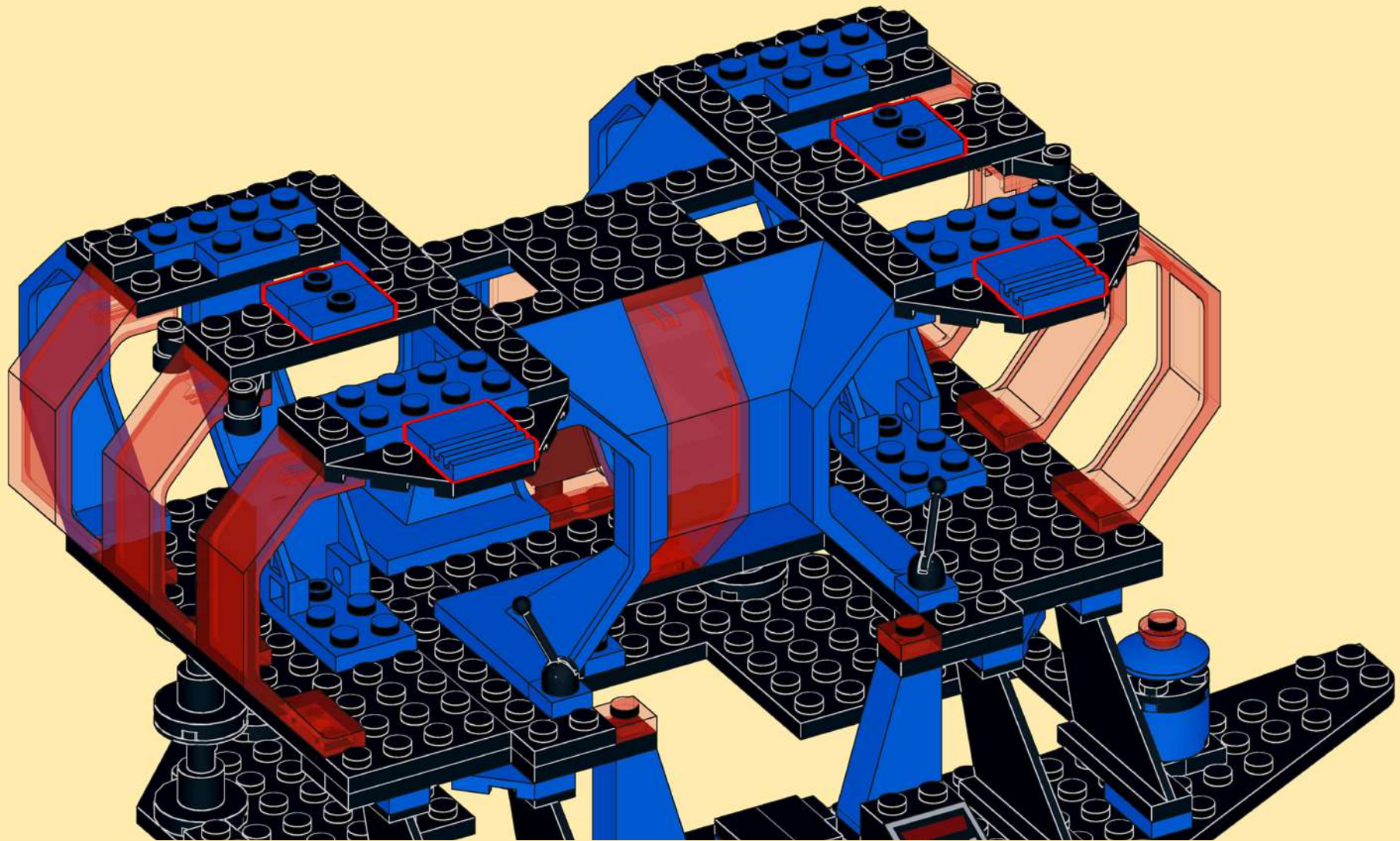
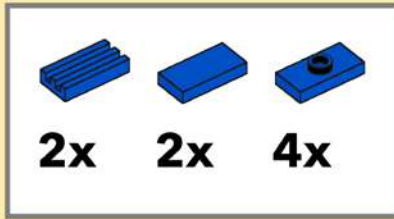

27

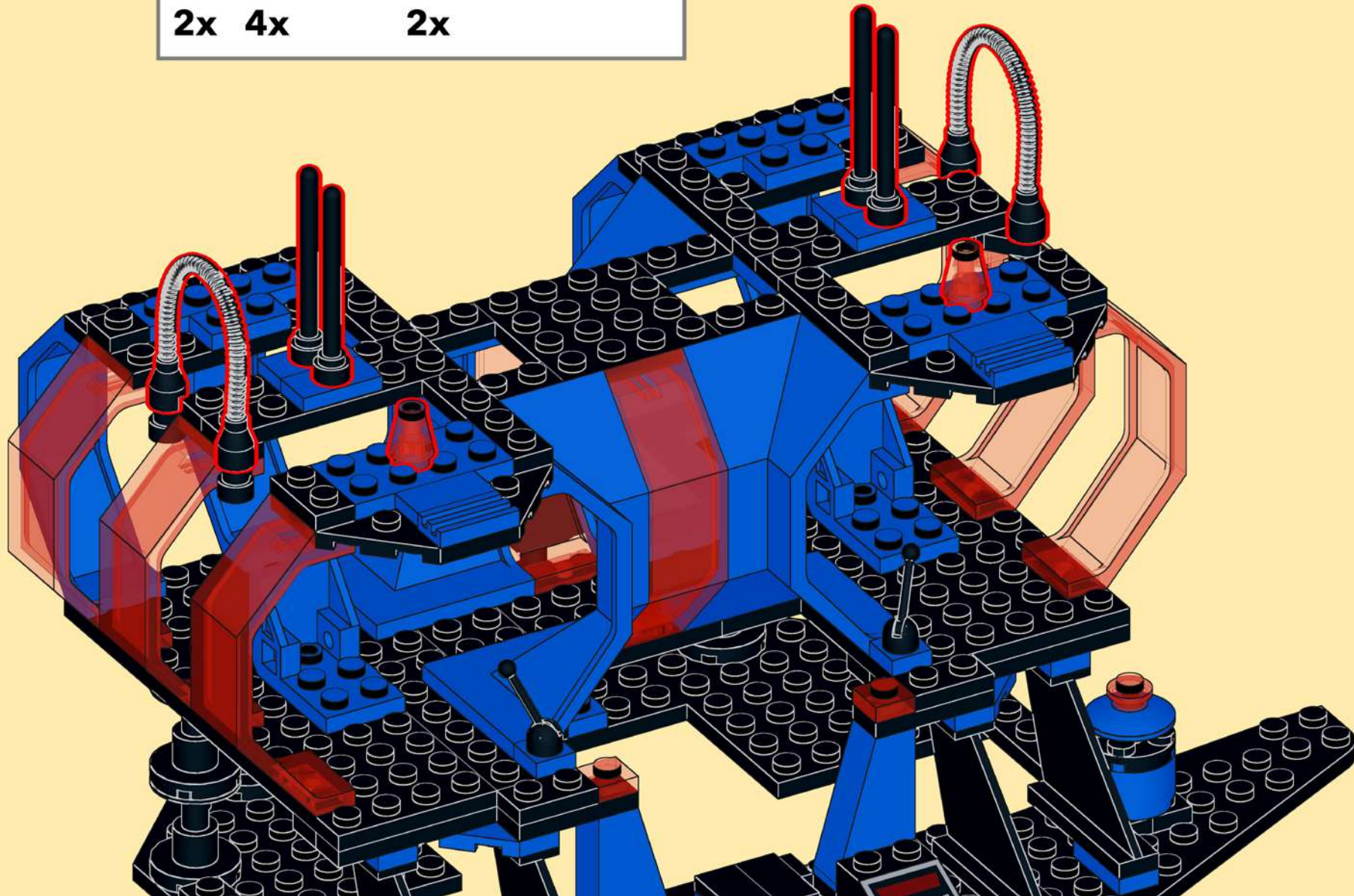

28

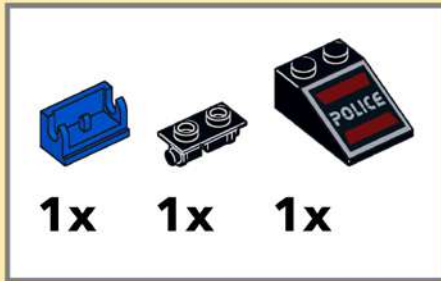

29

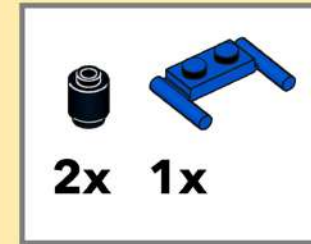

30

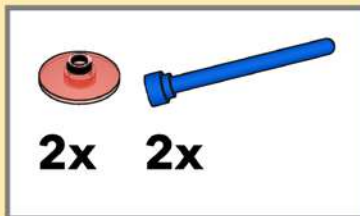

31

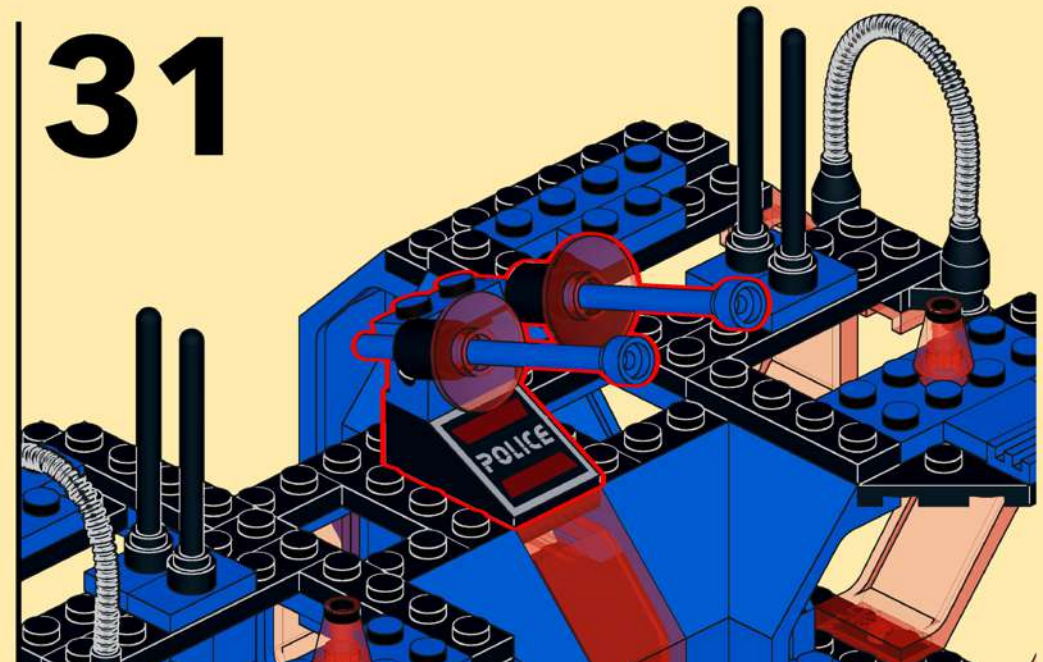

32

