



6986
MISSION COMMANDER
ALTERNATE MODEL (1989)

INSTRUCTIONS

CONCEPT BY BJARNE TVESKOV & LEGO
PHOTOGRAPHY & INSTRUCTIONS
BY COSMIC.BRICK





1

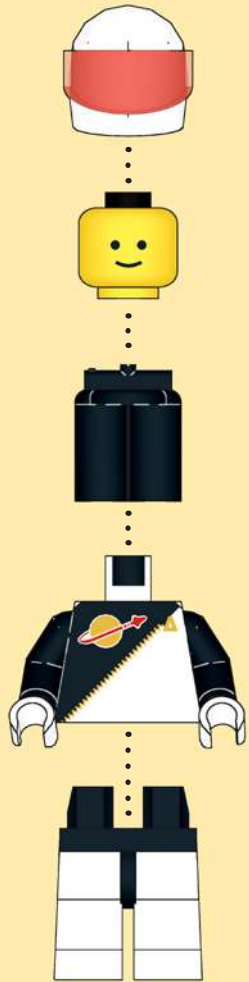

2



1

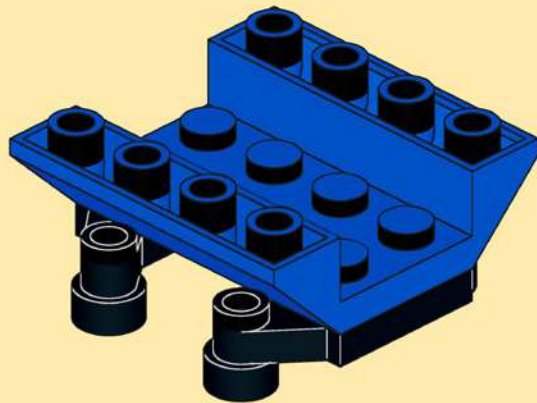
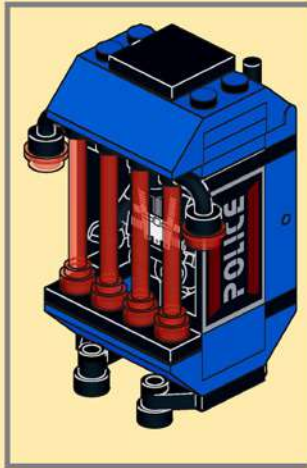
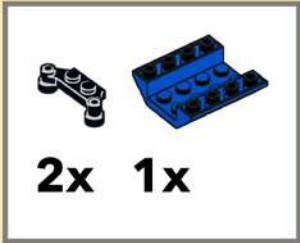

2

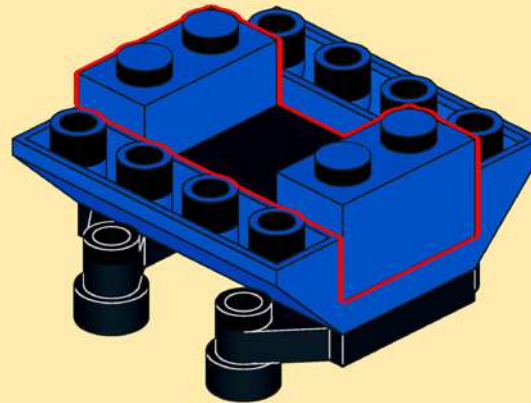
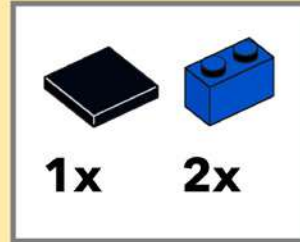

3

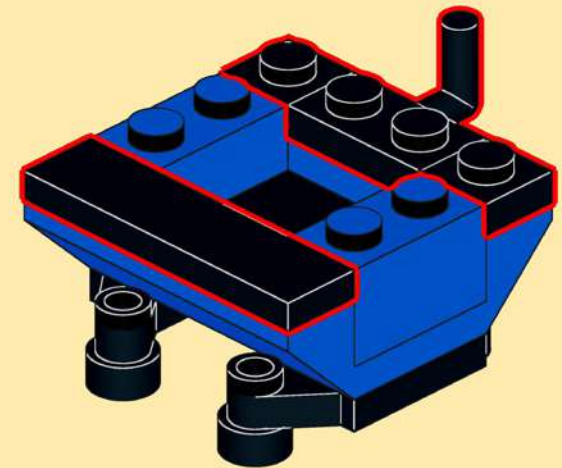
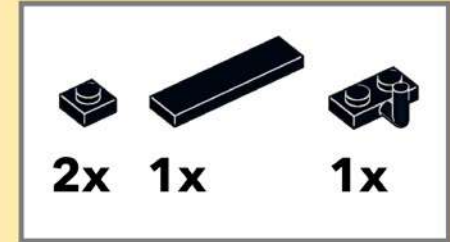

4

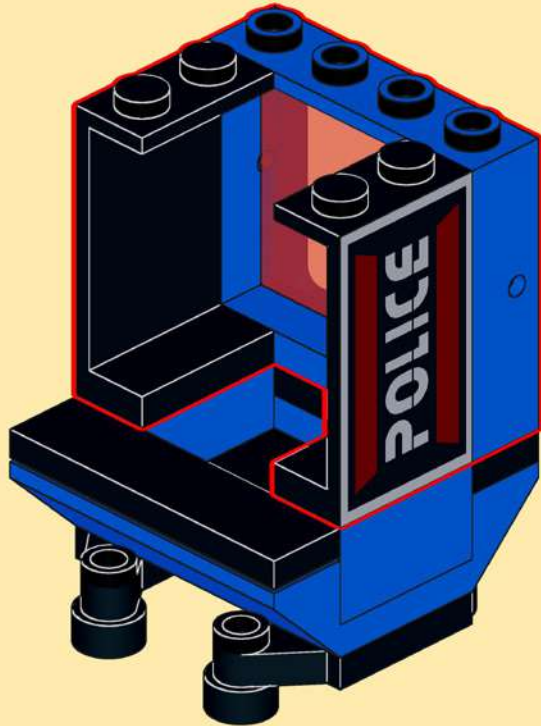
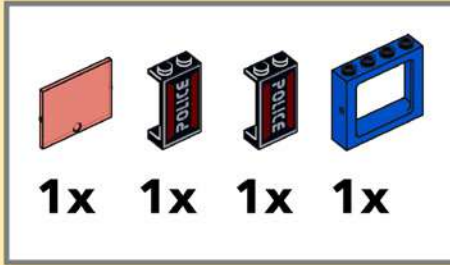

5

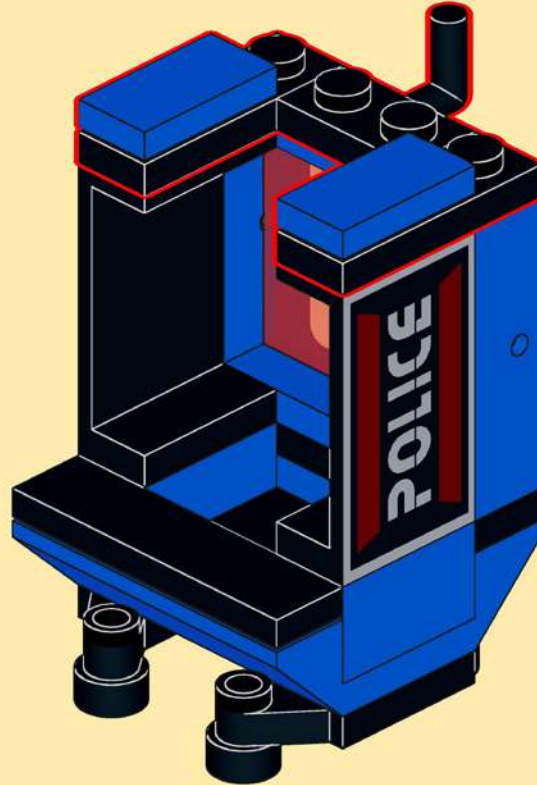
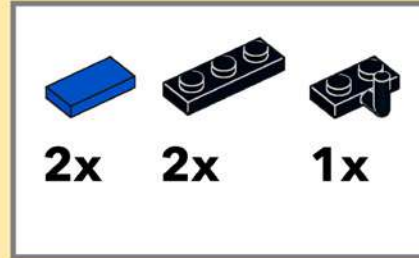

6

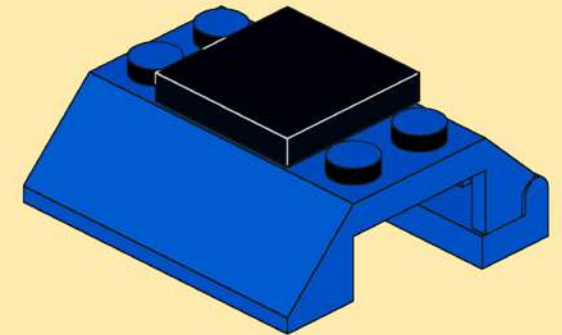
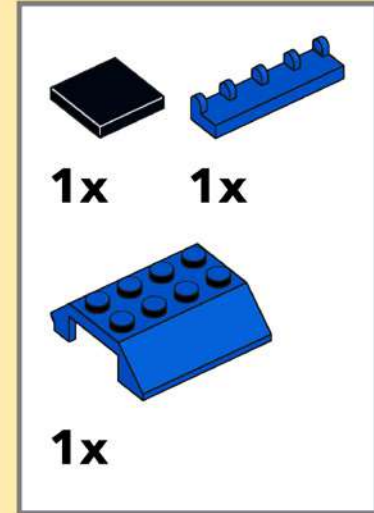

7

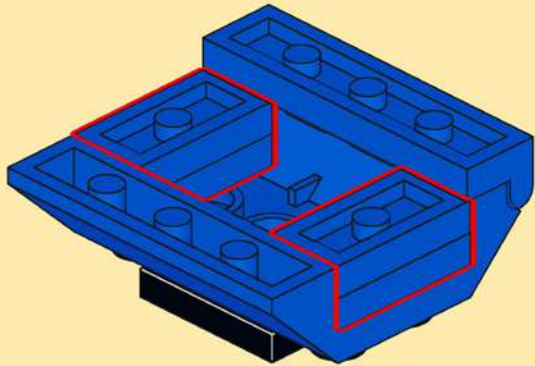
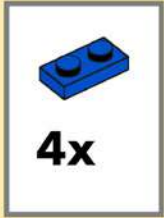

8

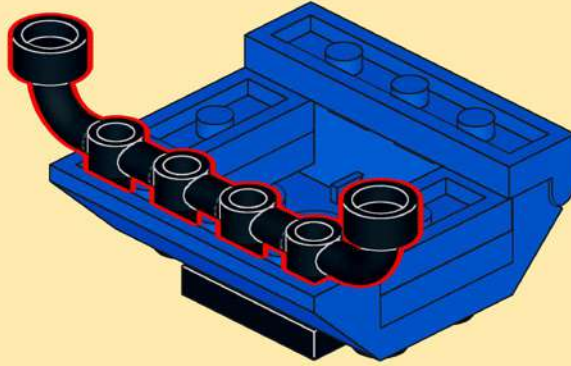
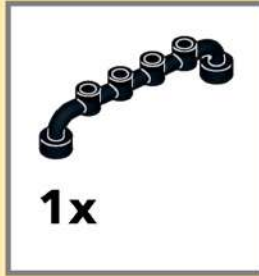

9

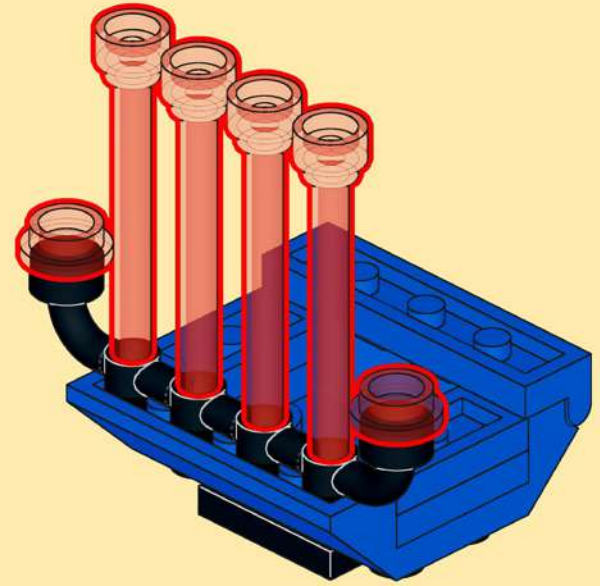
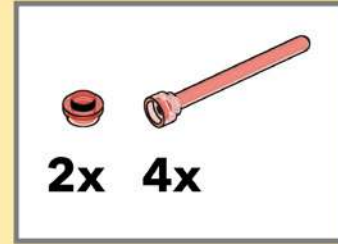

10

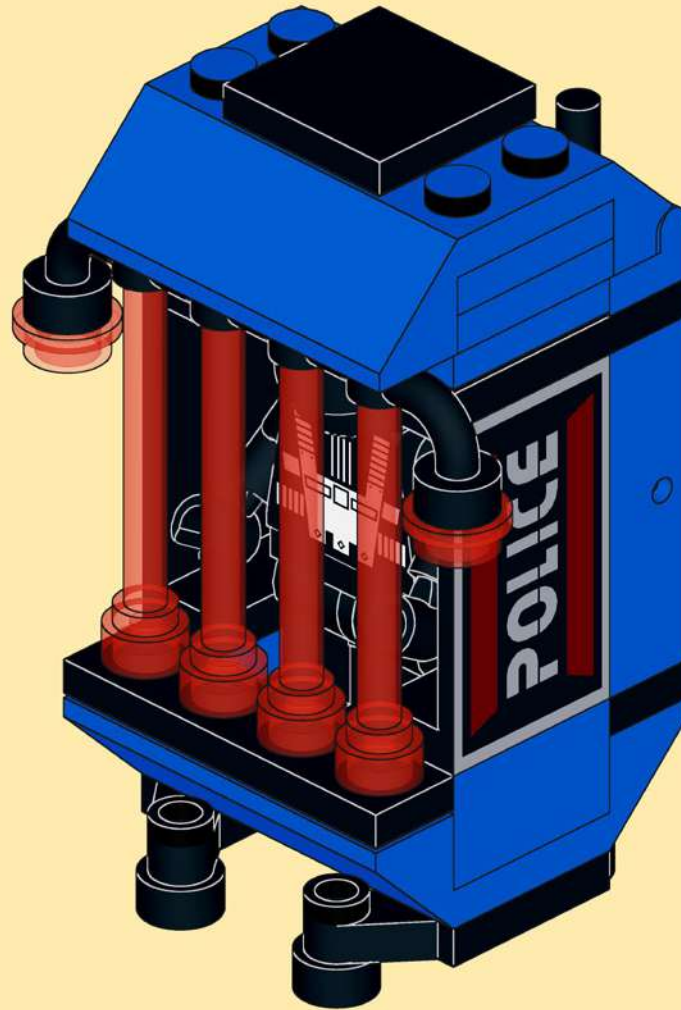

1

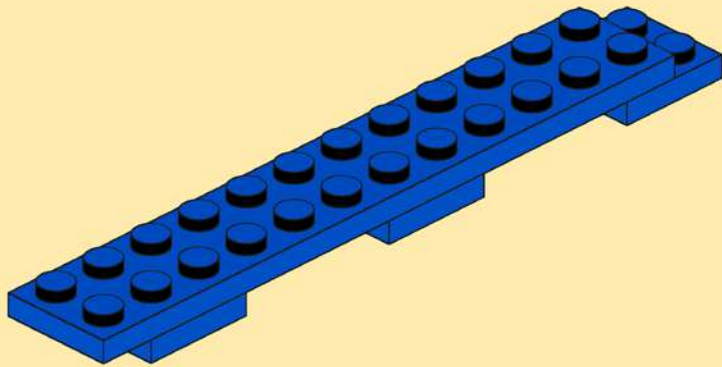
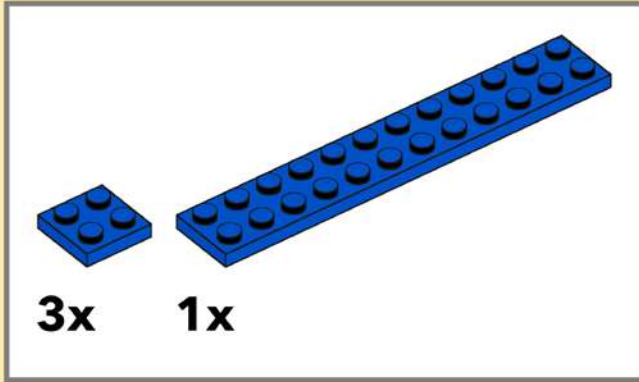

2

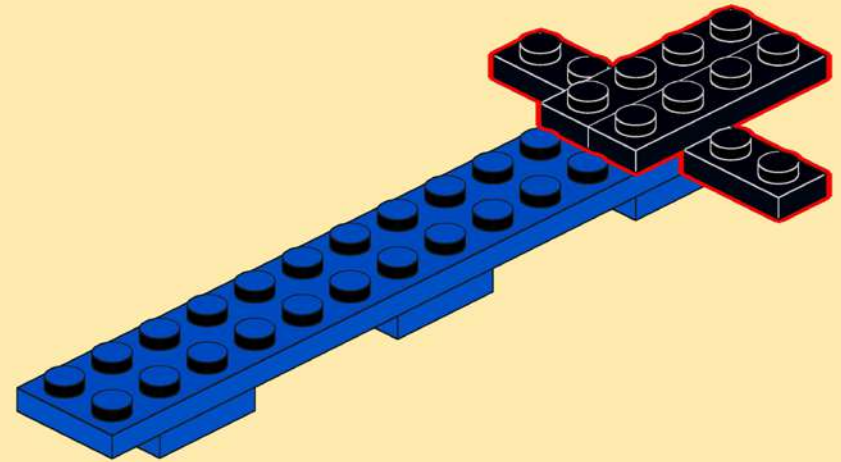
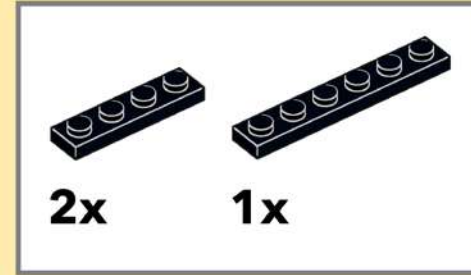

3

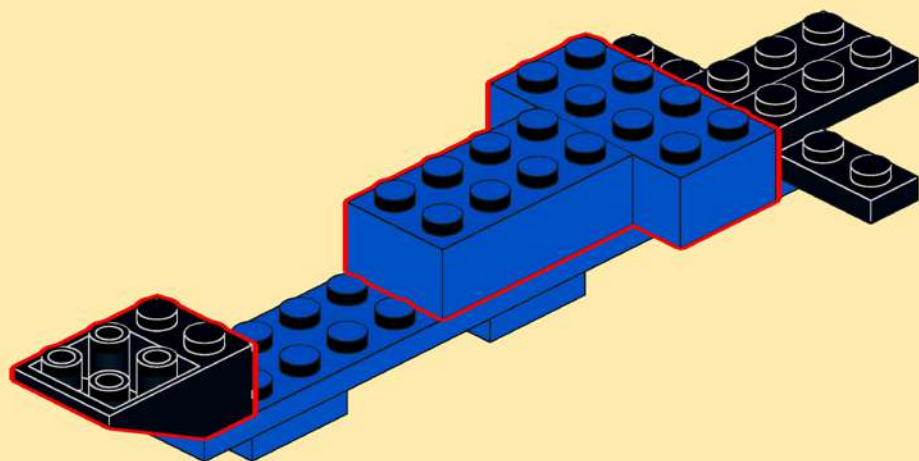
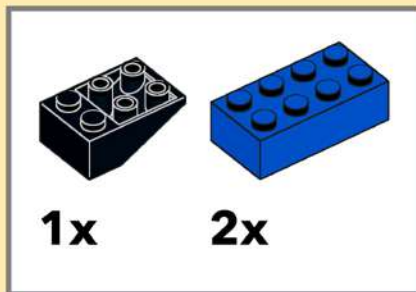

4

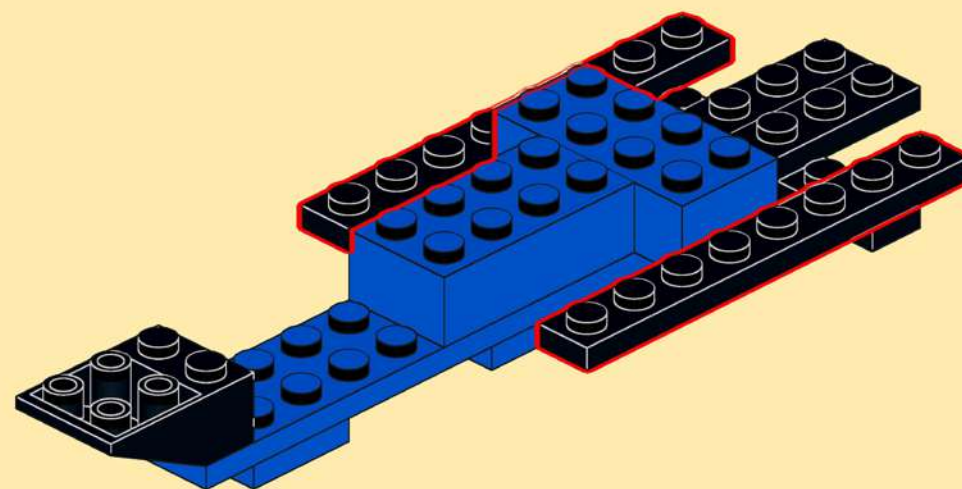

5

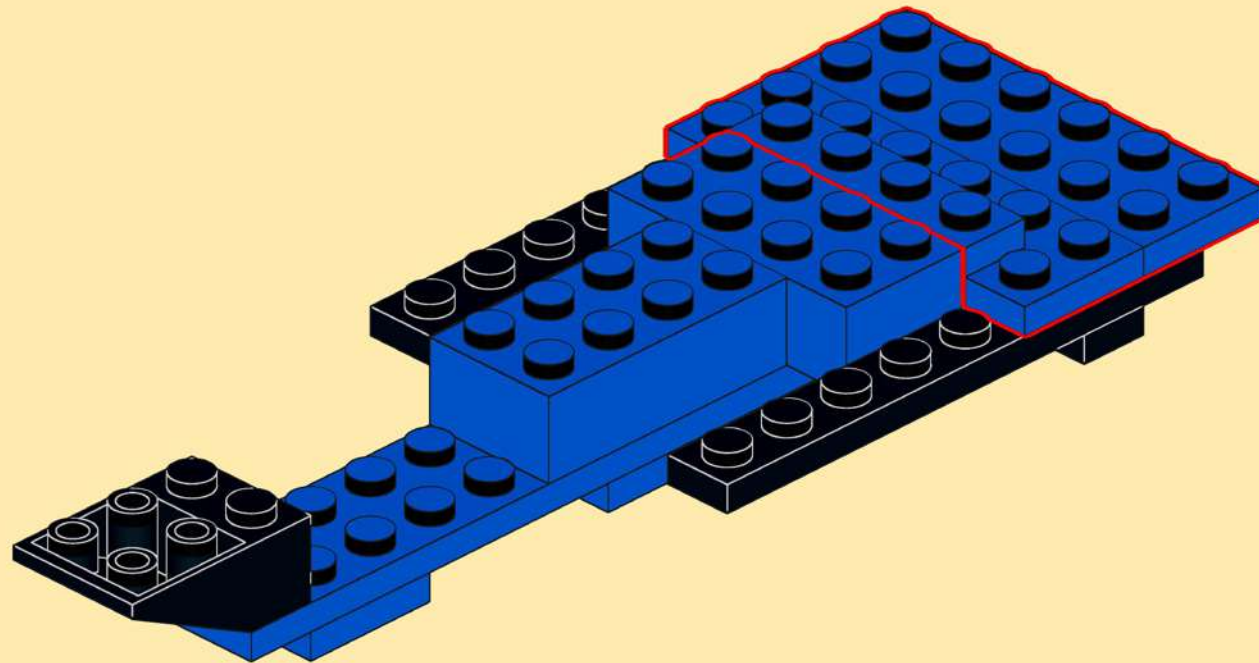
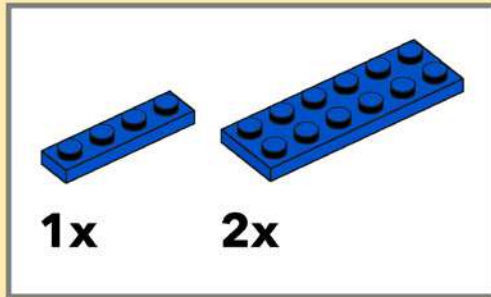

6

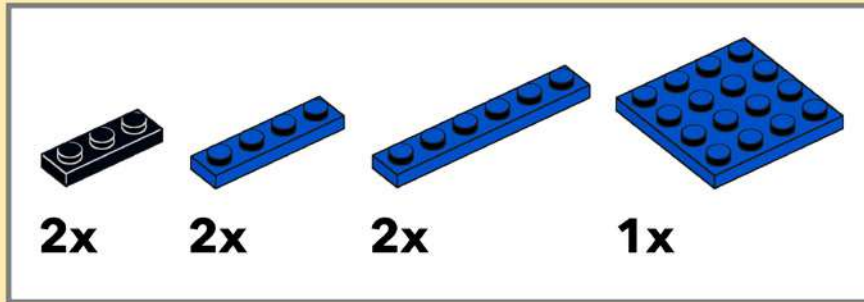

Accuracy

Whilst this build is aimed to be an exact replica of the back wall depiction, please note the the prison cell will not fully connect to the main body. To solve this, set the two 1×6 plates one stud more outward.

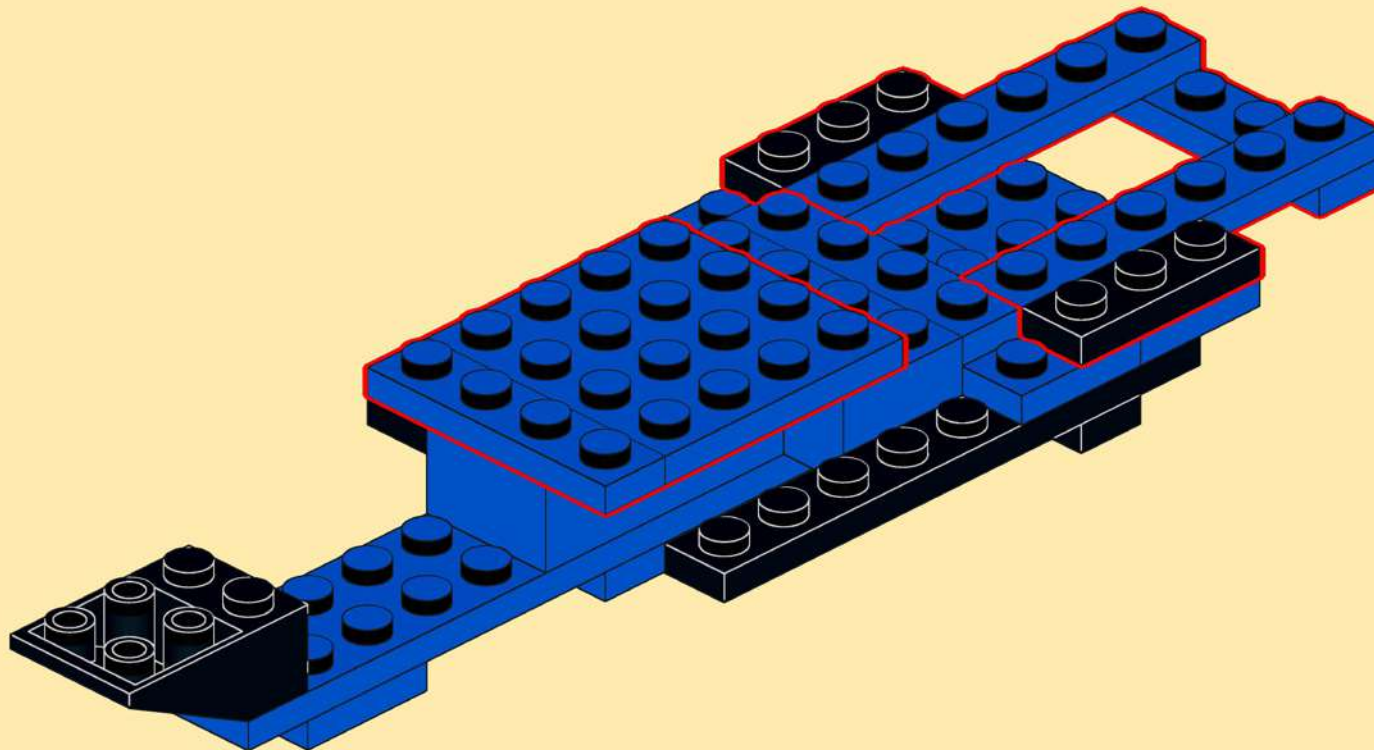

7

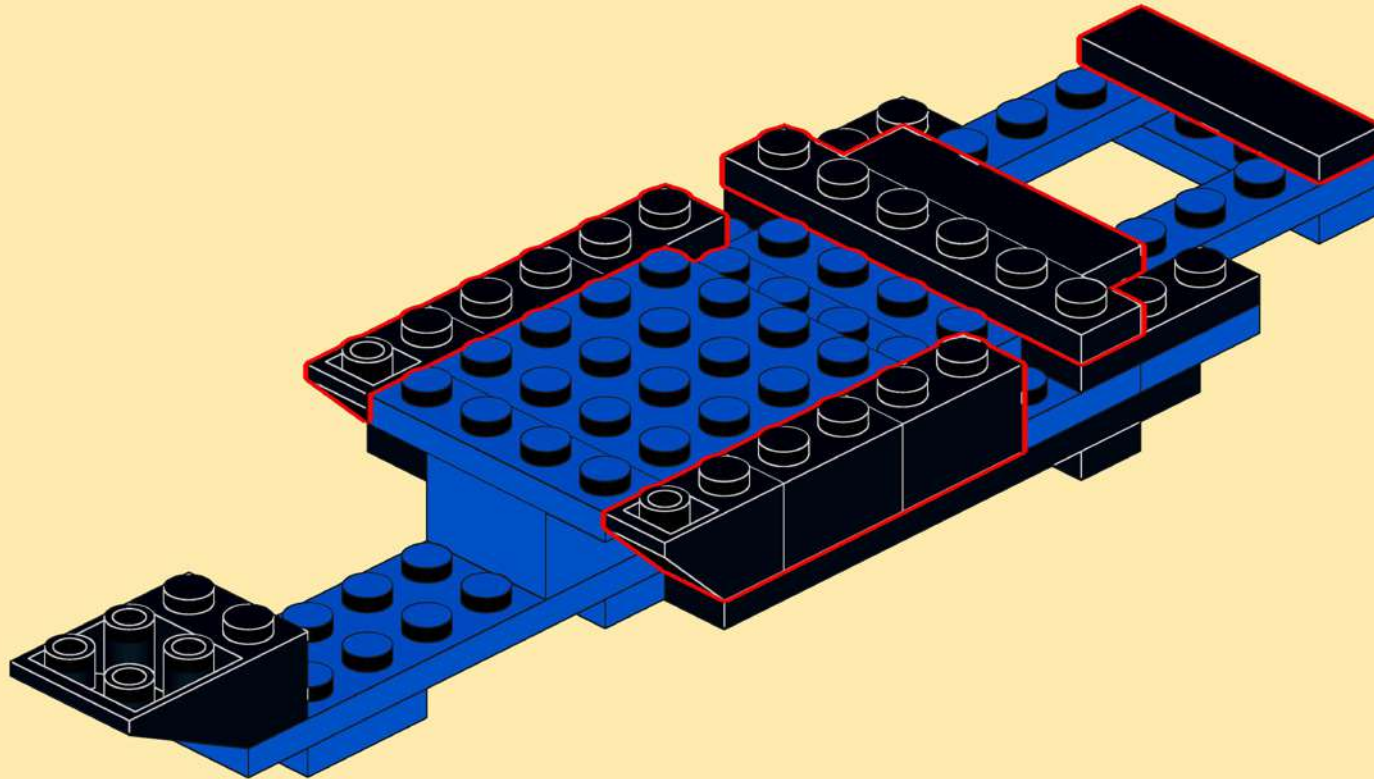
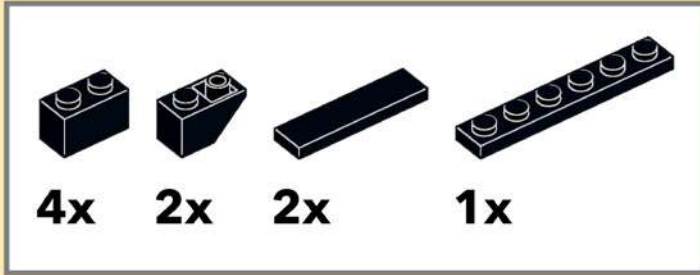

8

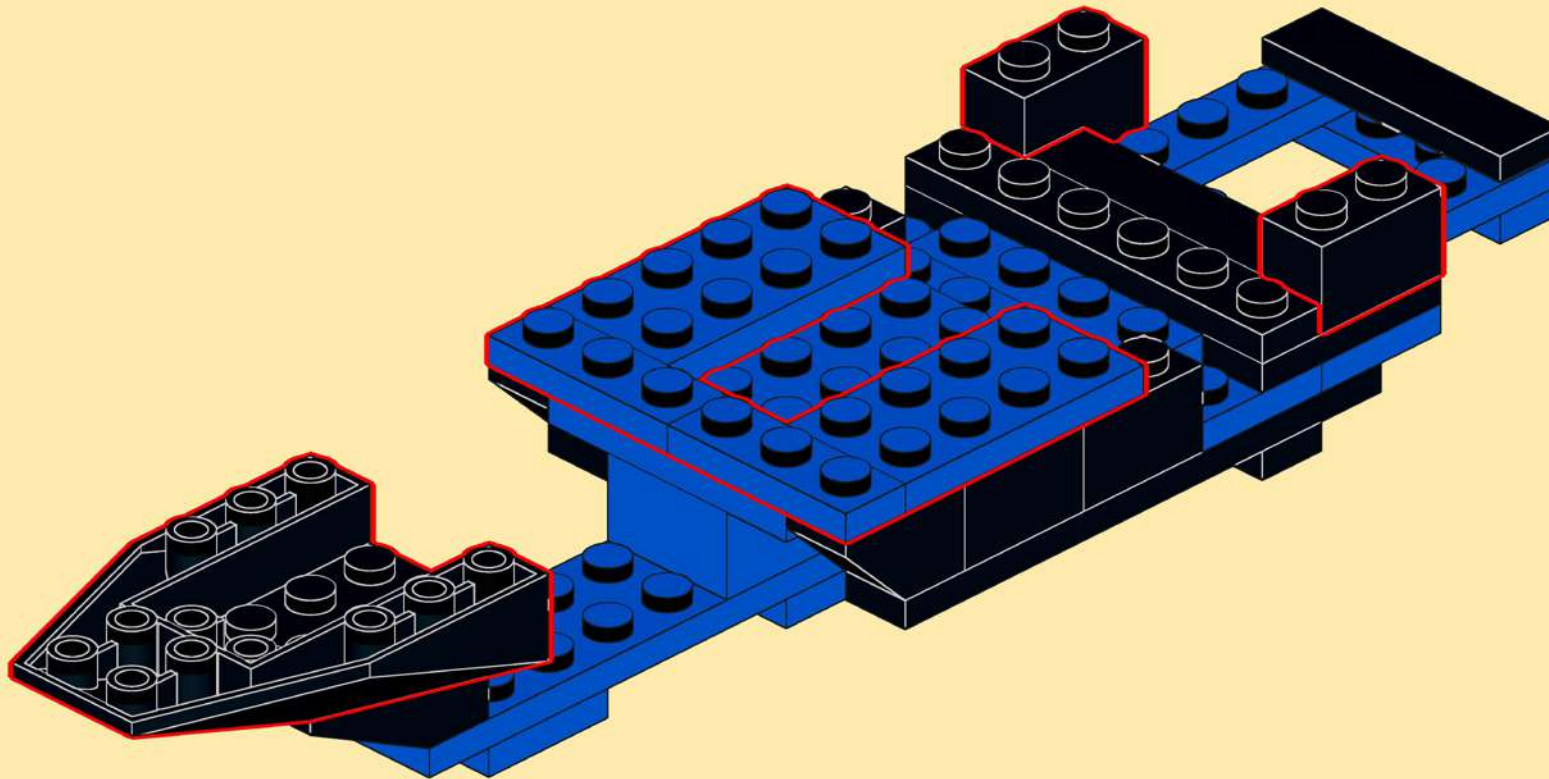
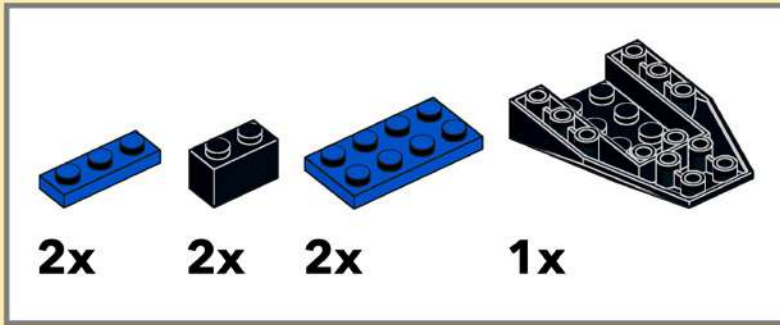

9

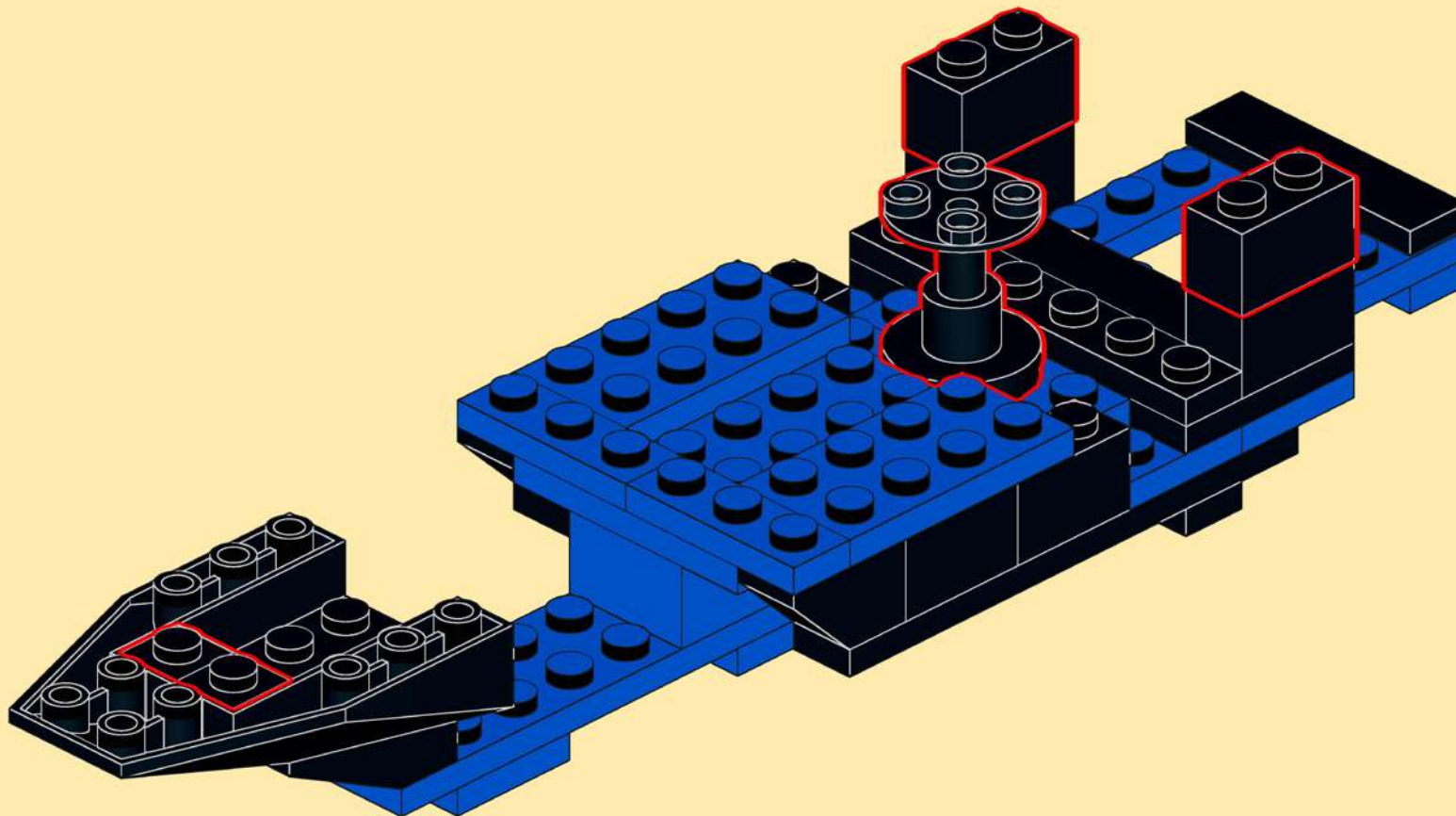
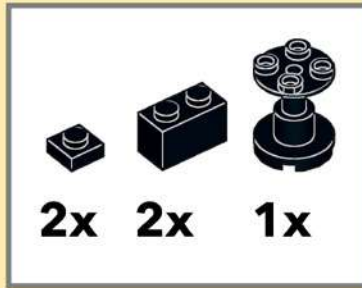

10

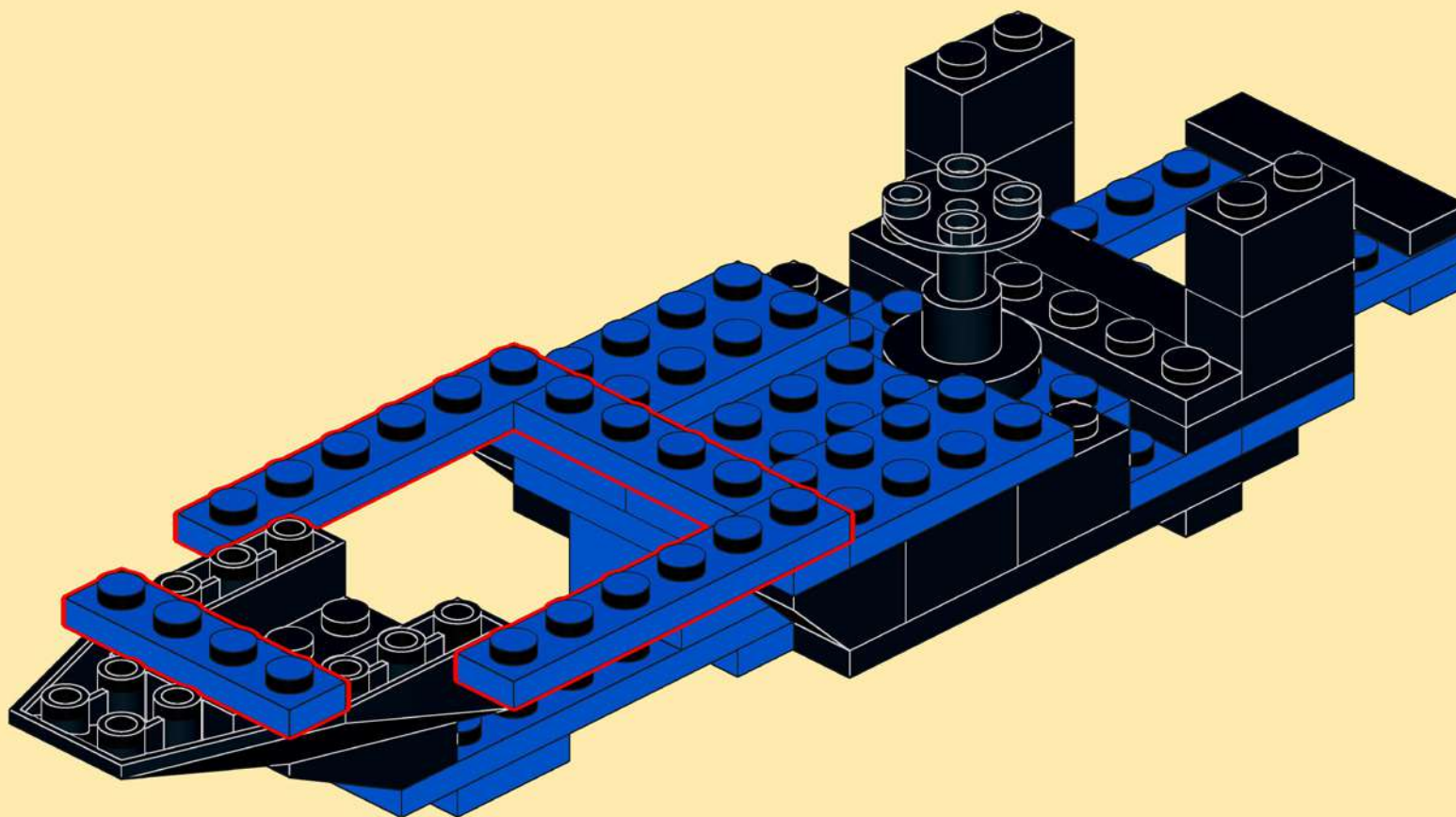
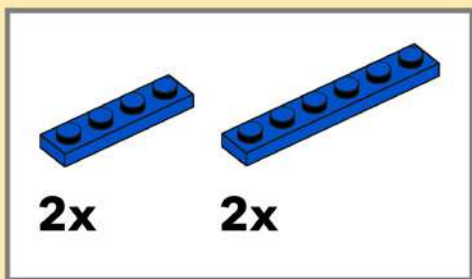

11

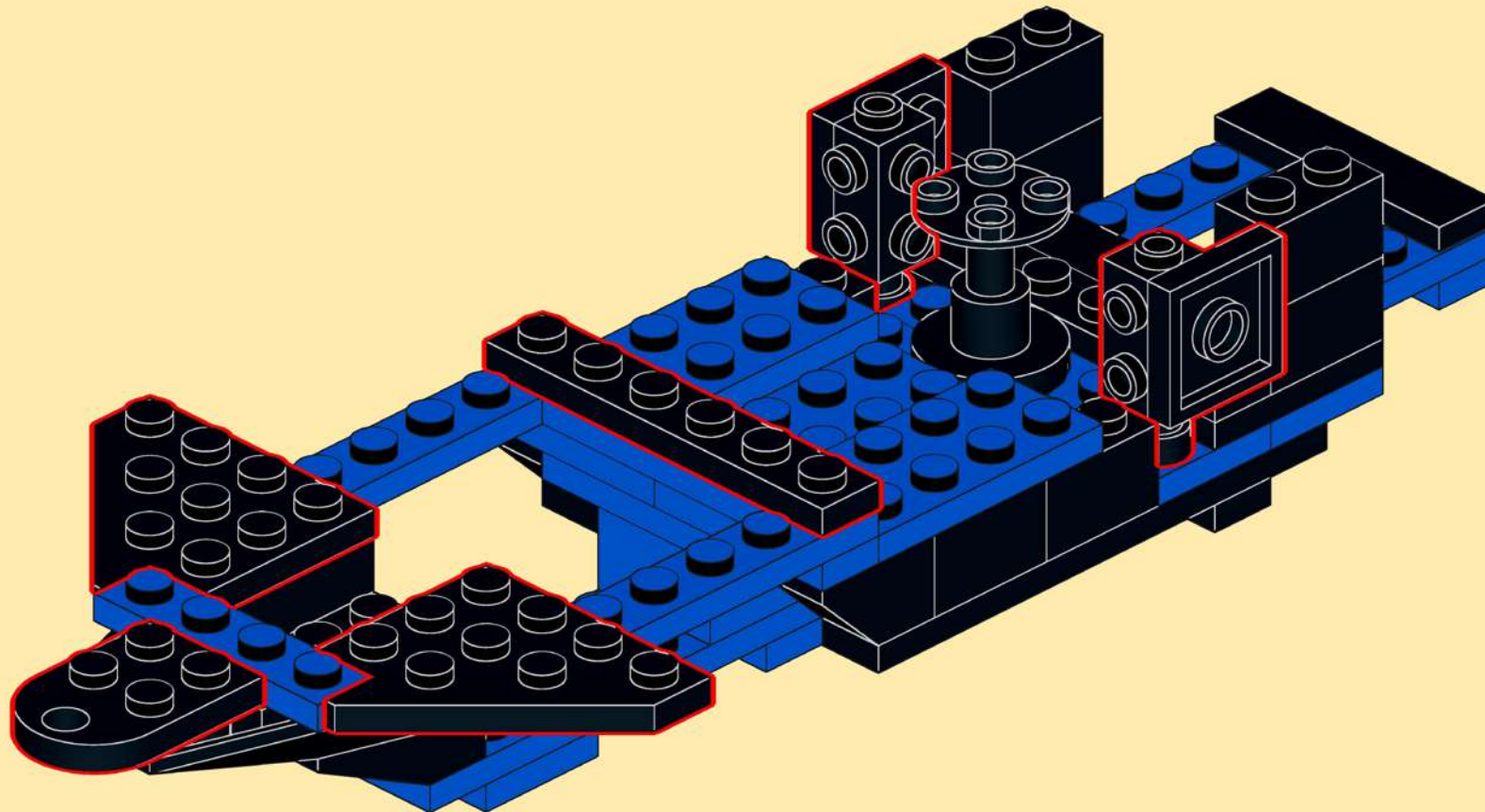
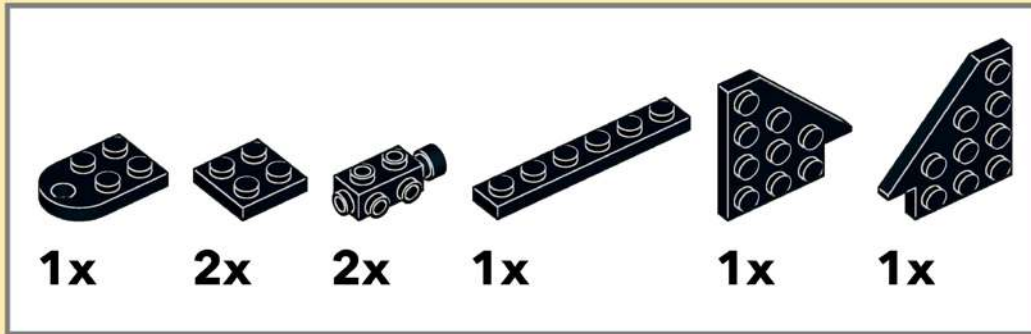

12

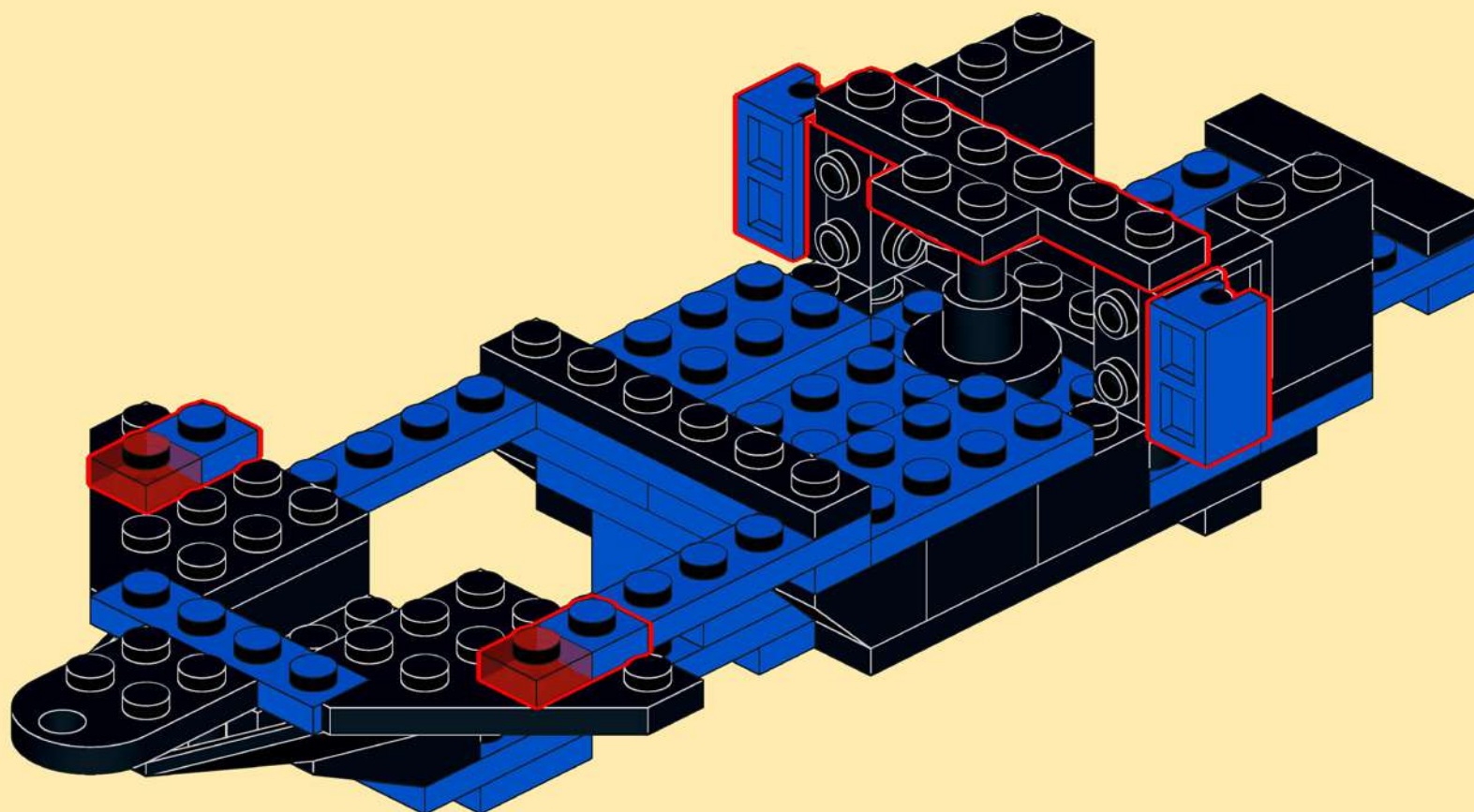
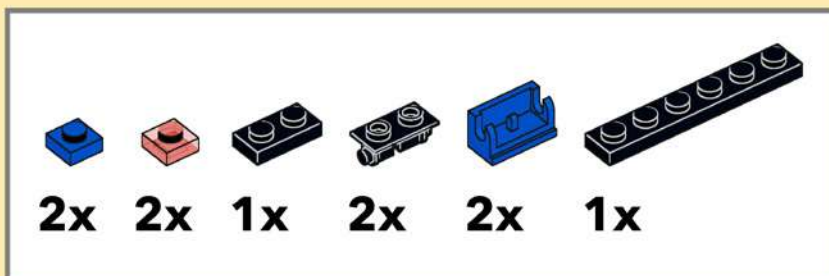

13

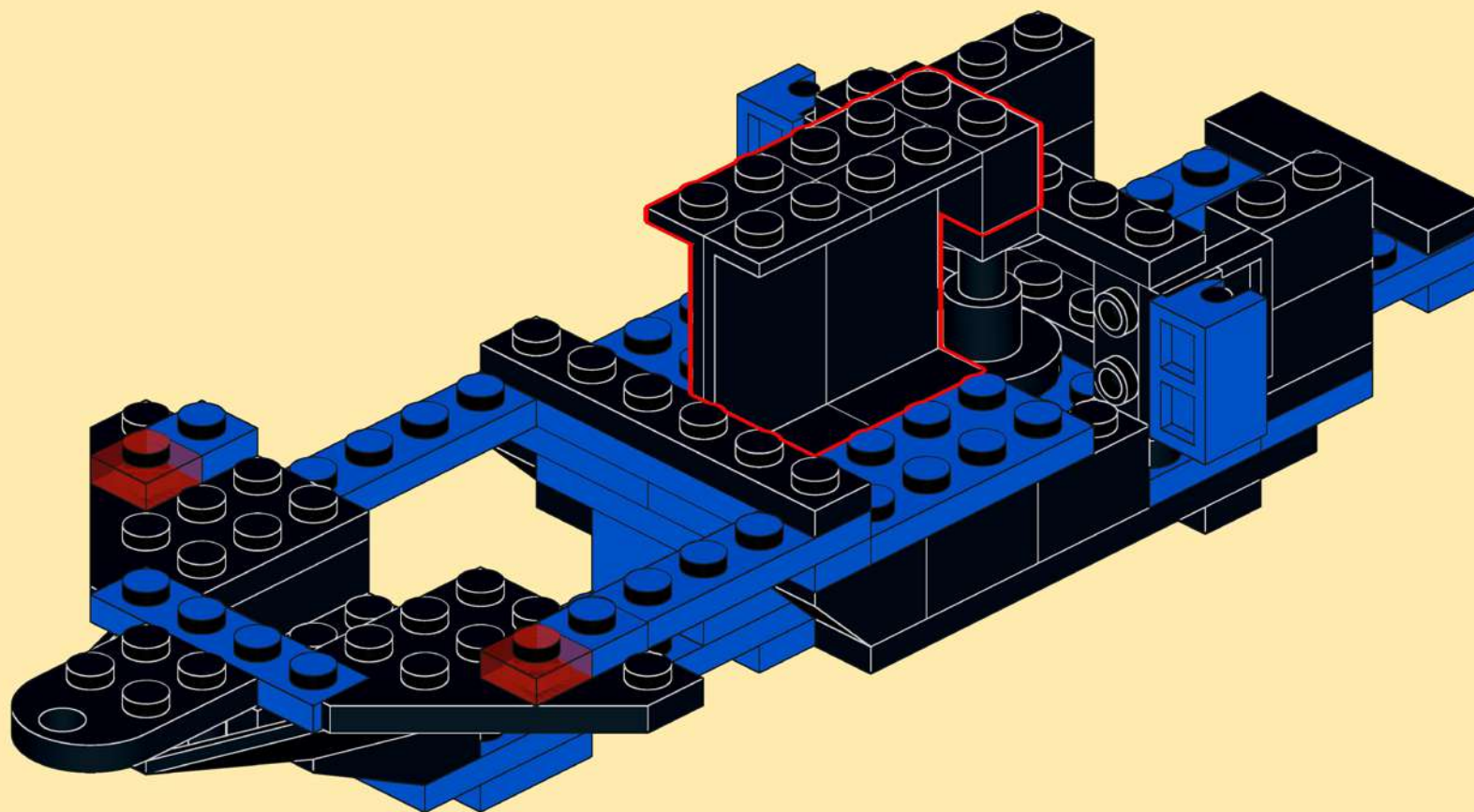
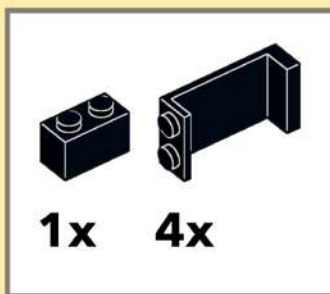

14

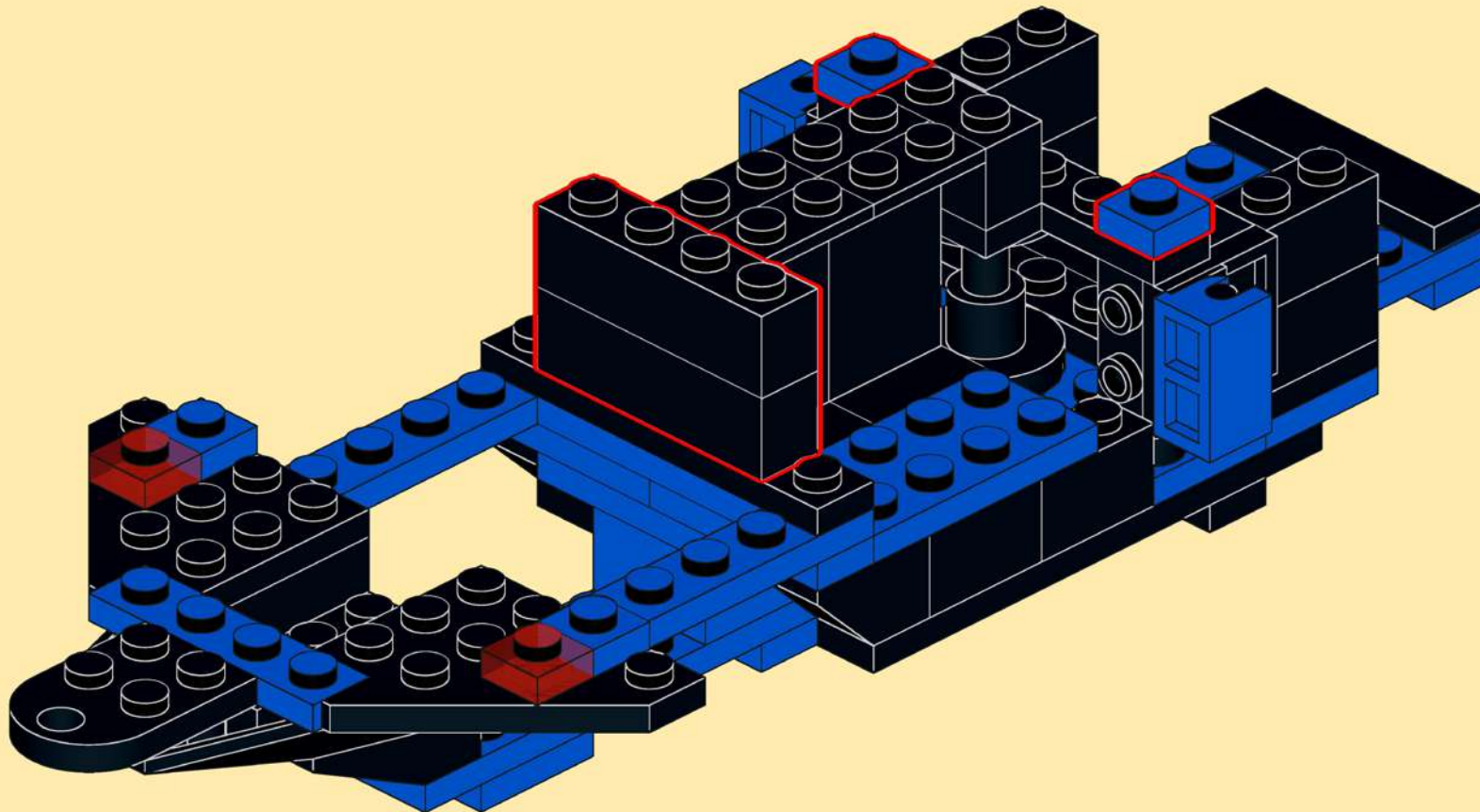
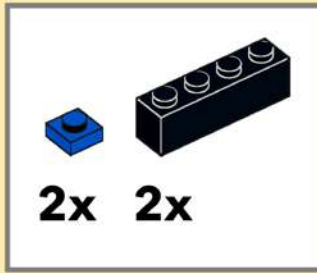

15

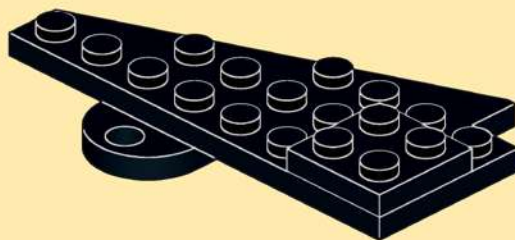
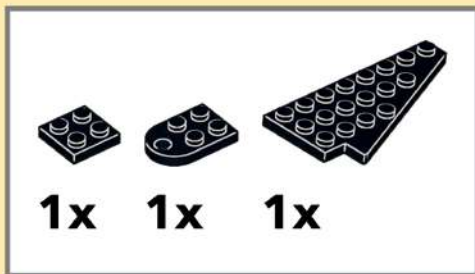

16

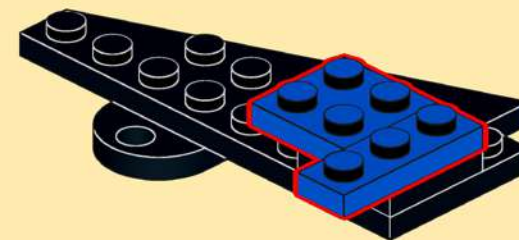
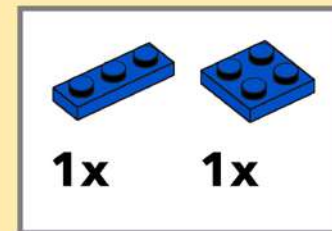

17

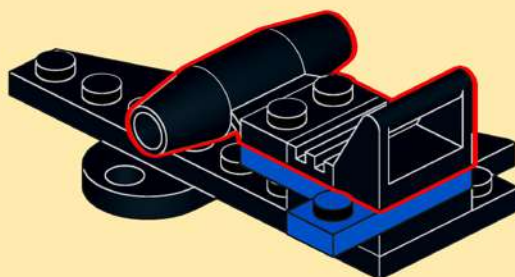
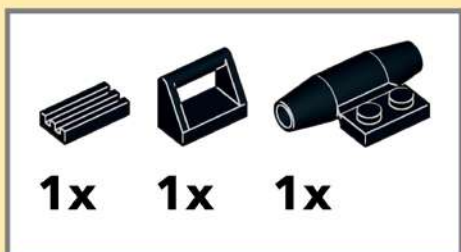

18

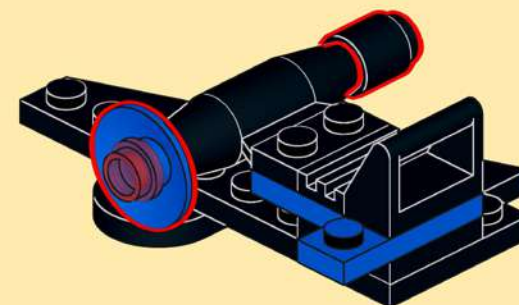

19

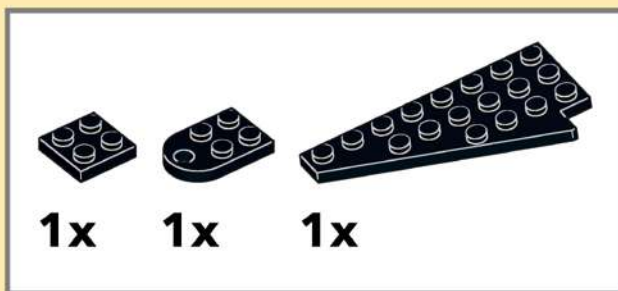

20

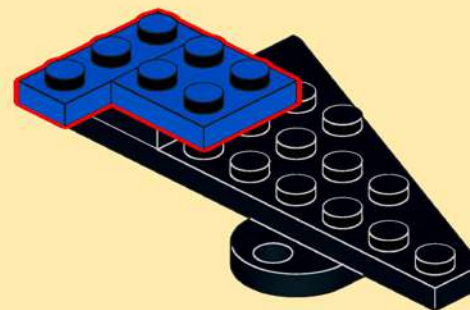
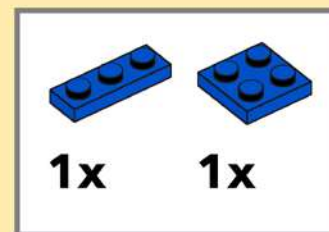

21

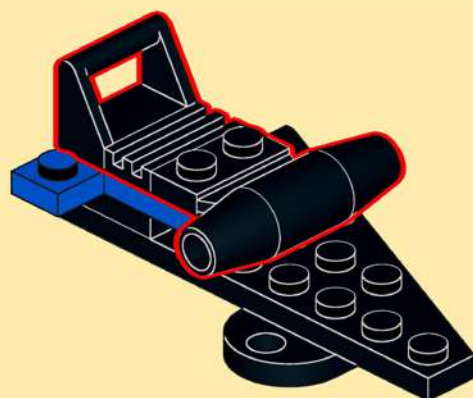
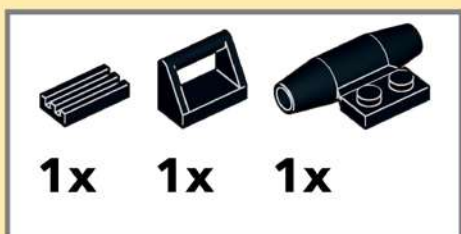

22



23

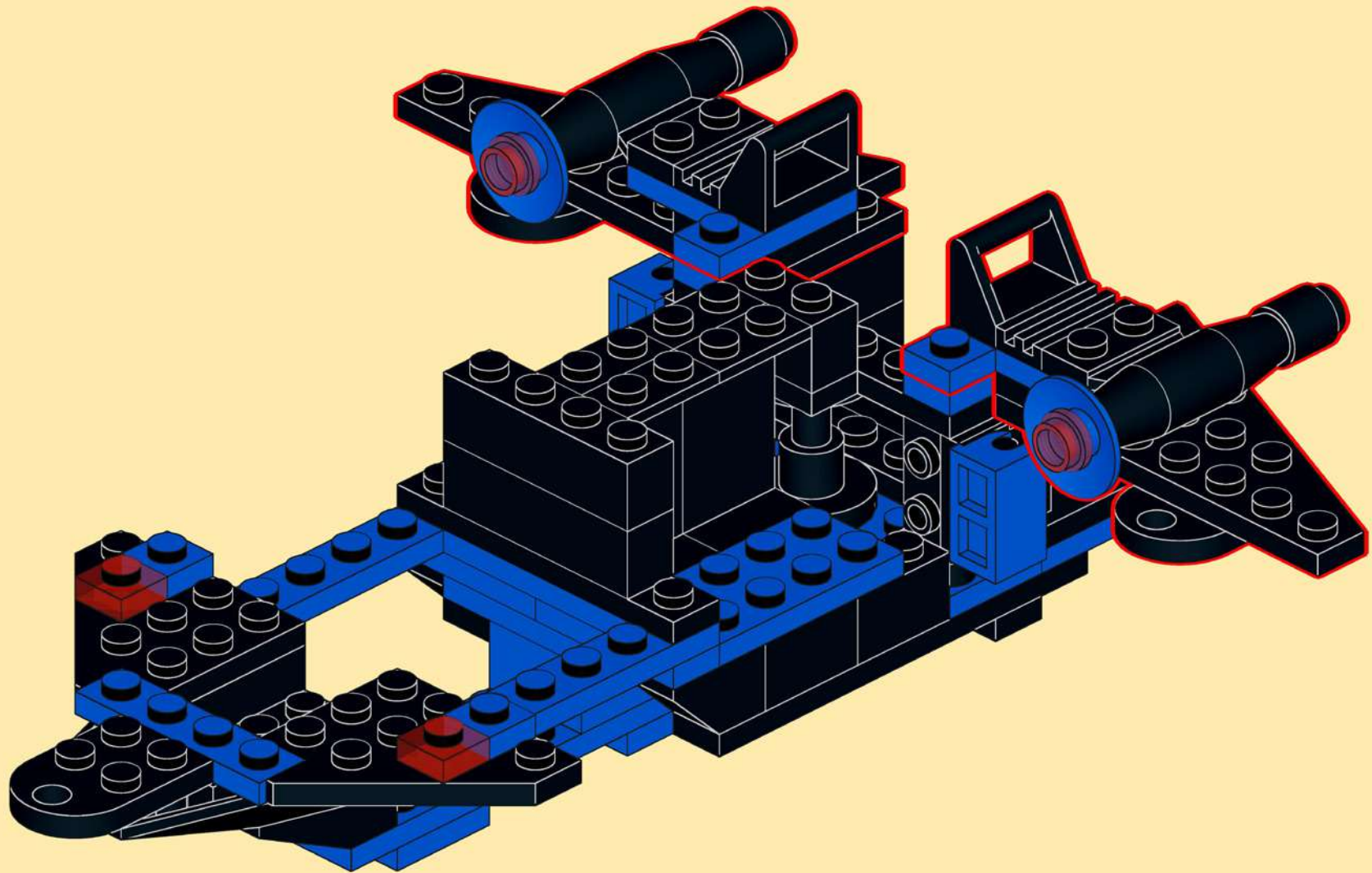

24

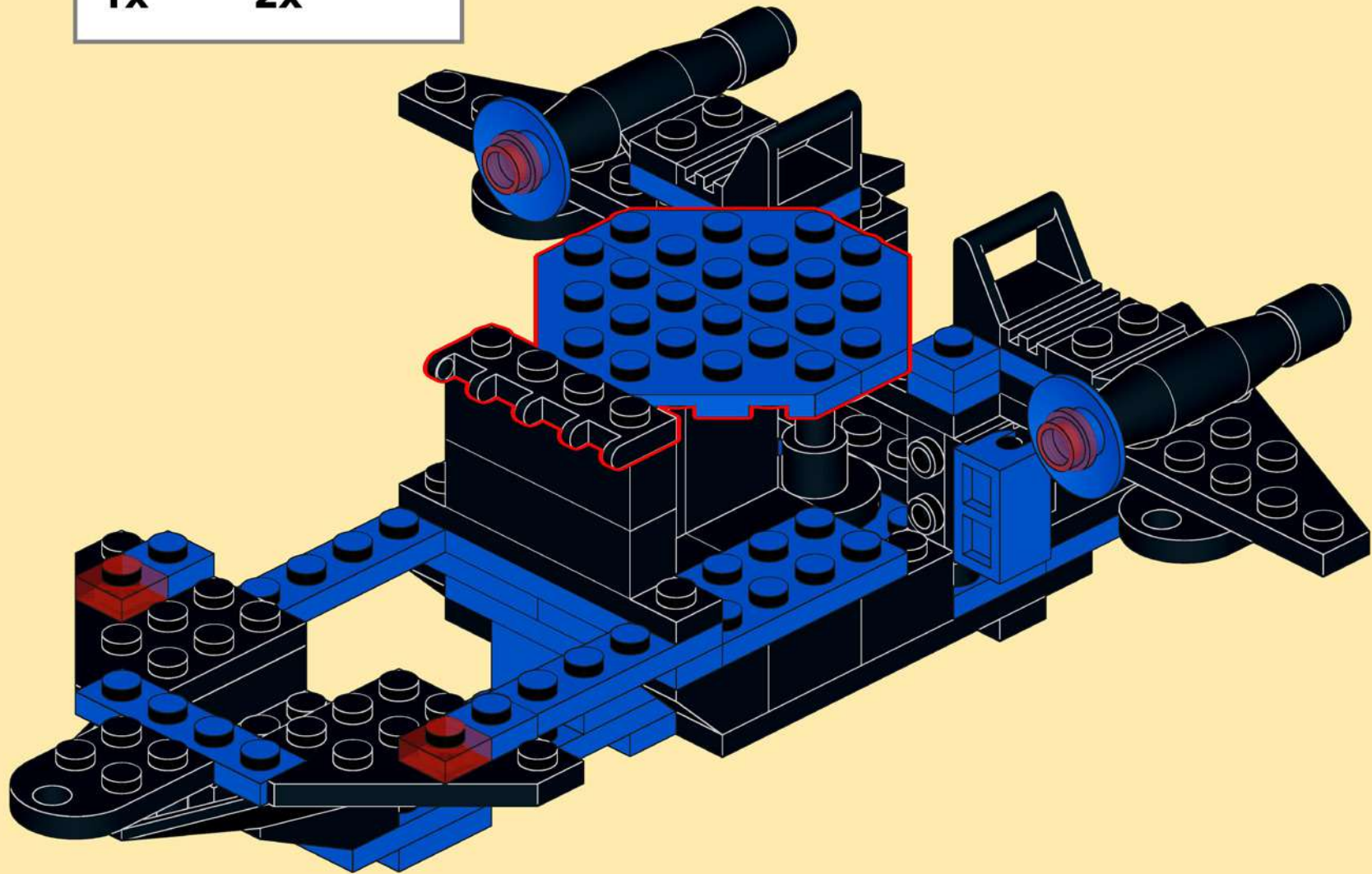
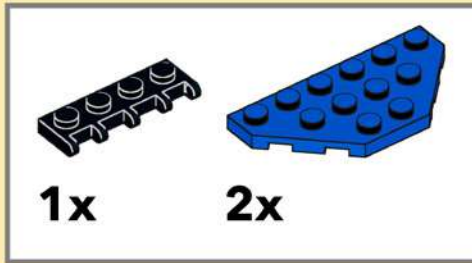

25

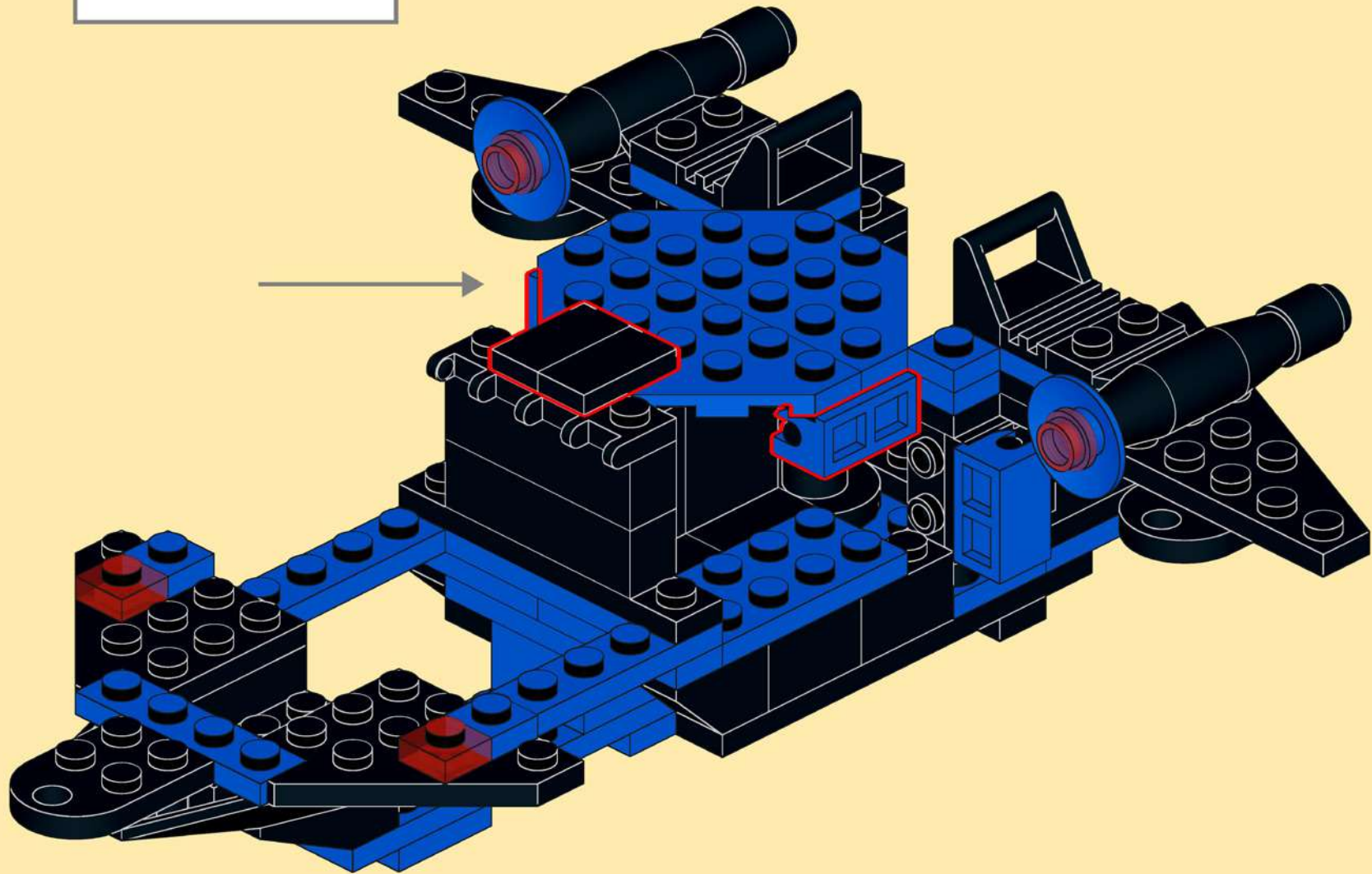
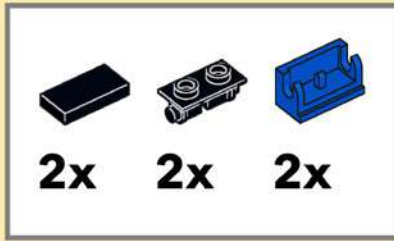

26

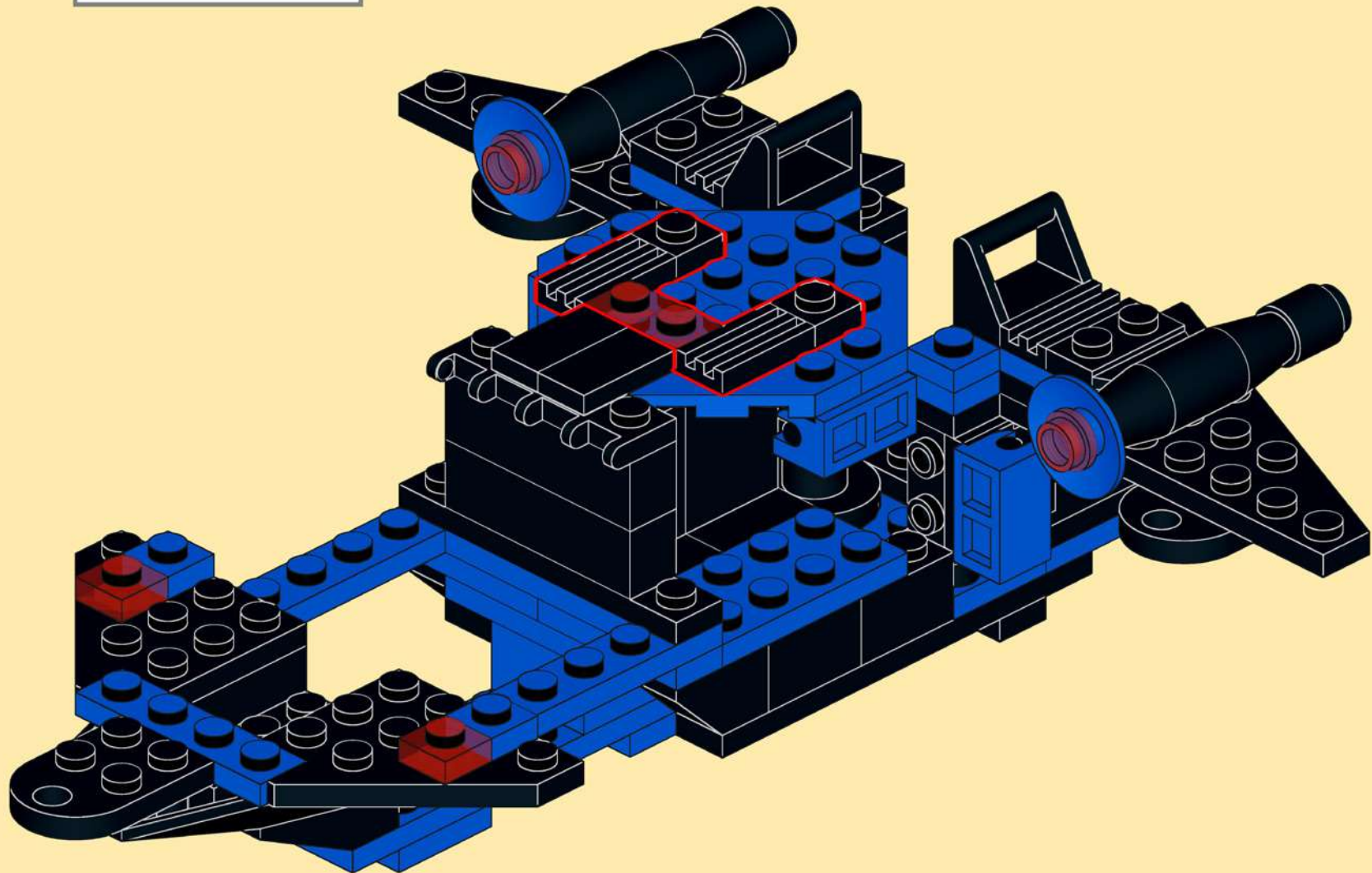
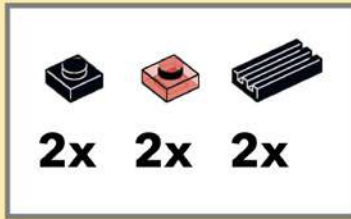

27

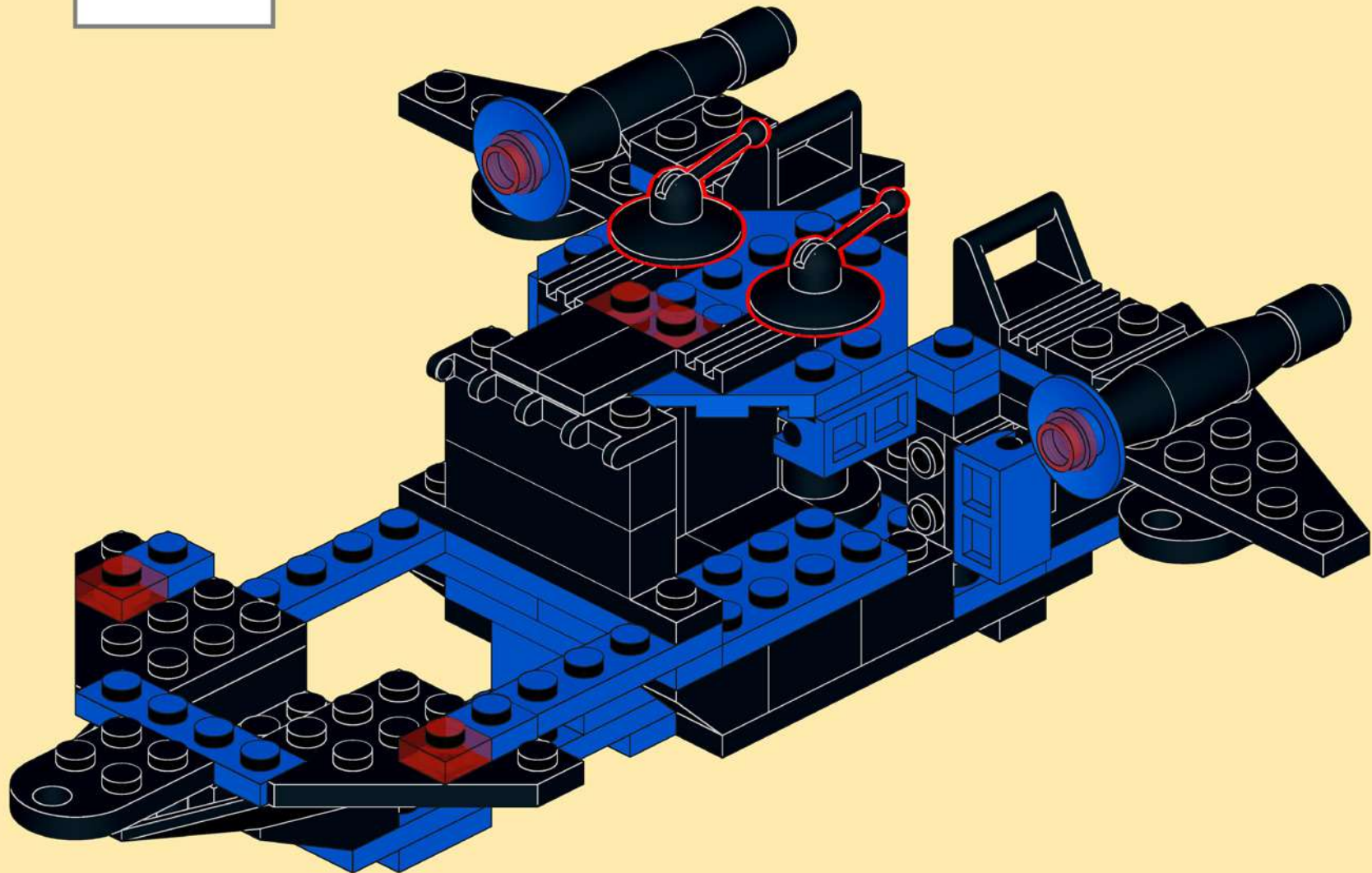

28

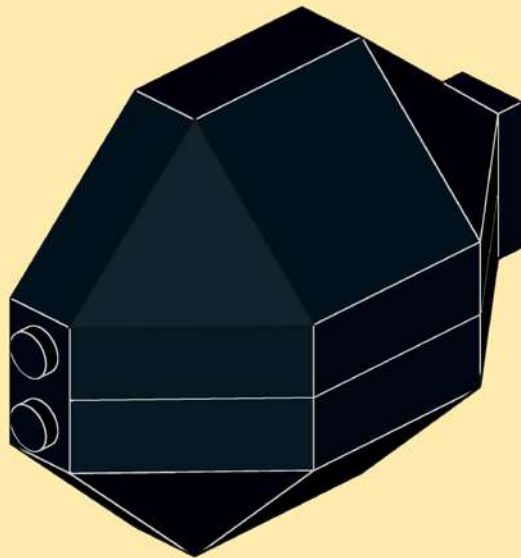
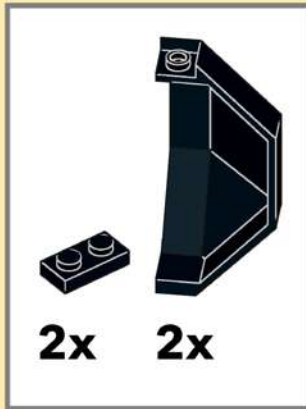

29



Stability issue

Whilst this build is aimed to be an exact replica of the back wall depiction, please note the black side panels are only connected with two studs on each side. Handle with care.

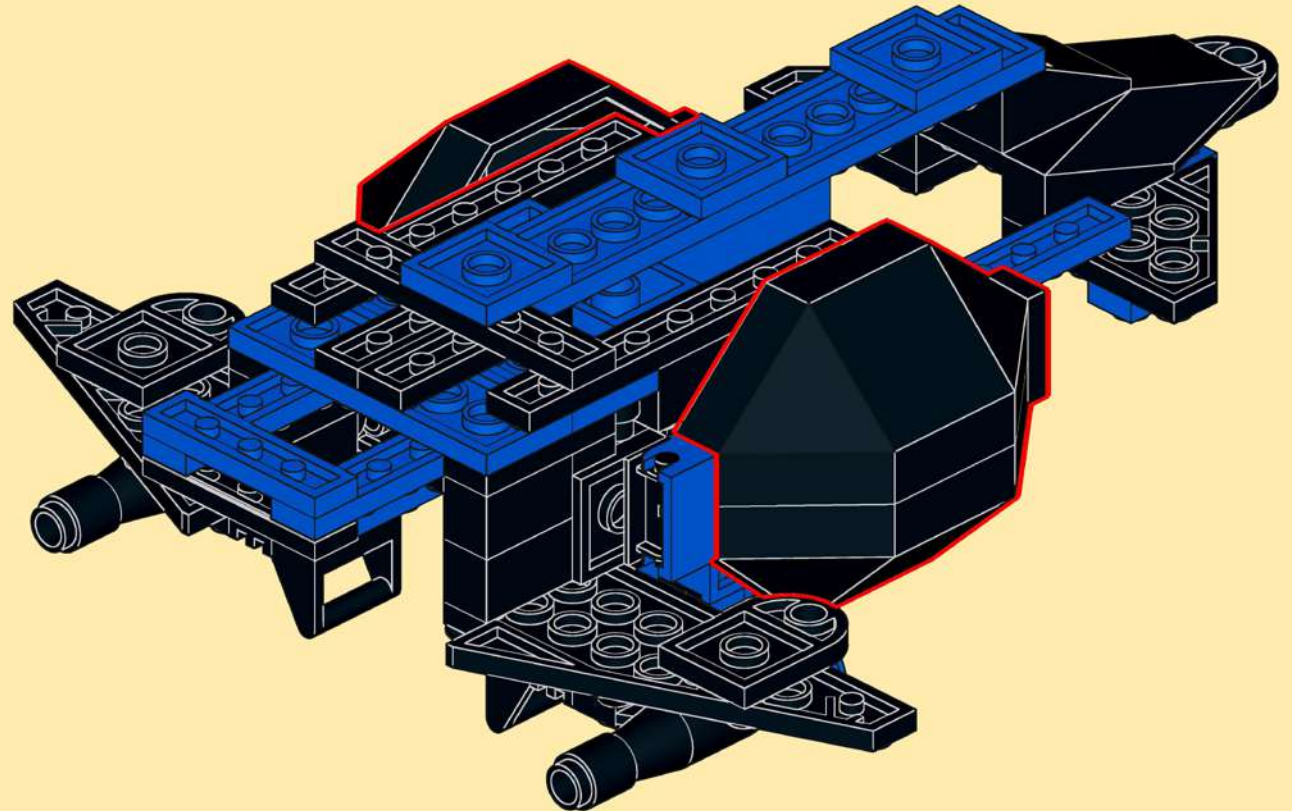

30

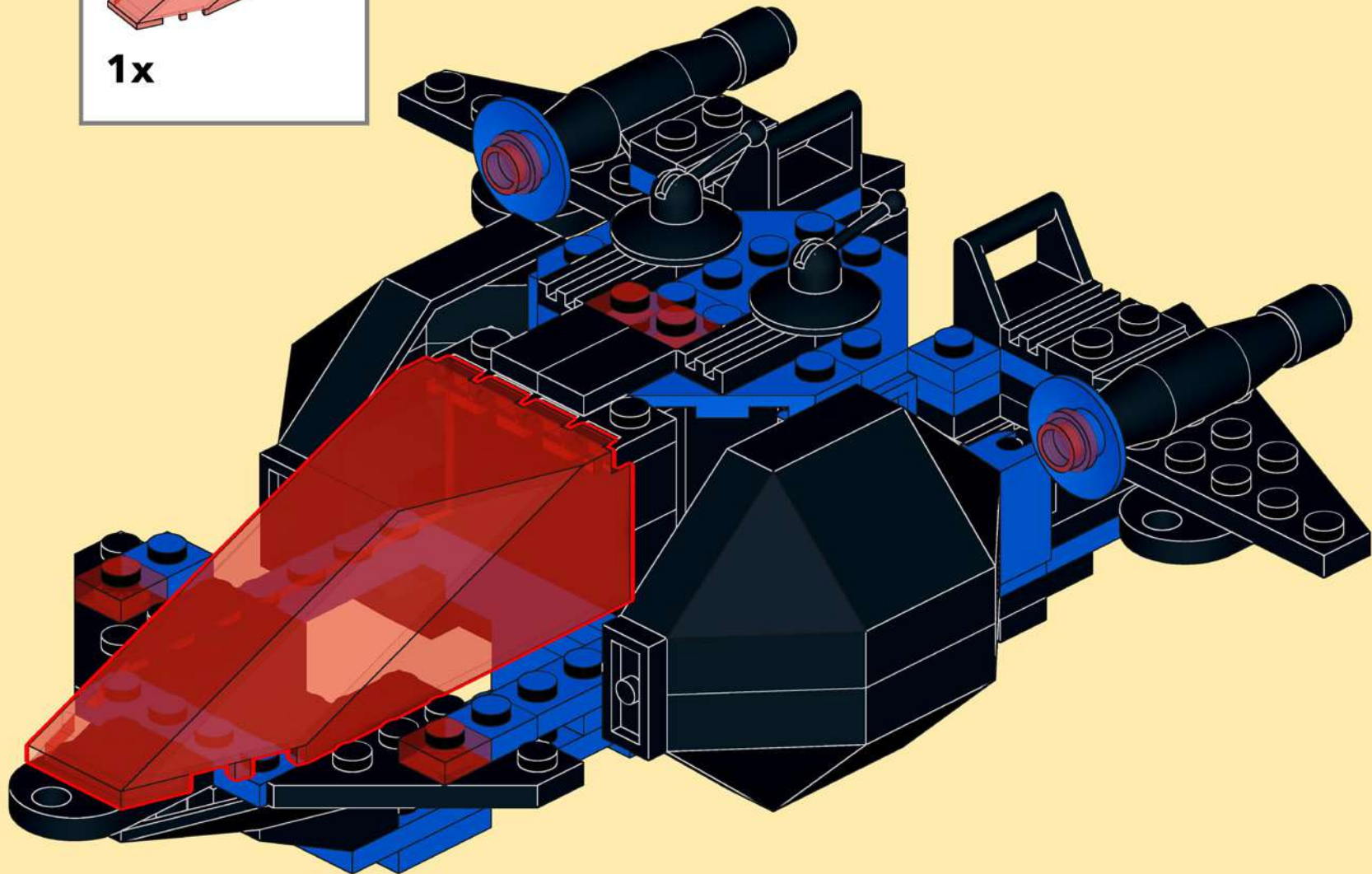
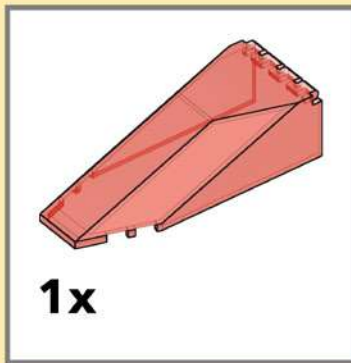

31

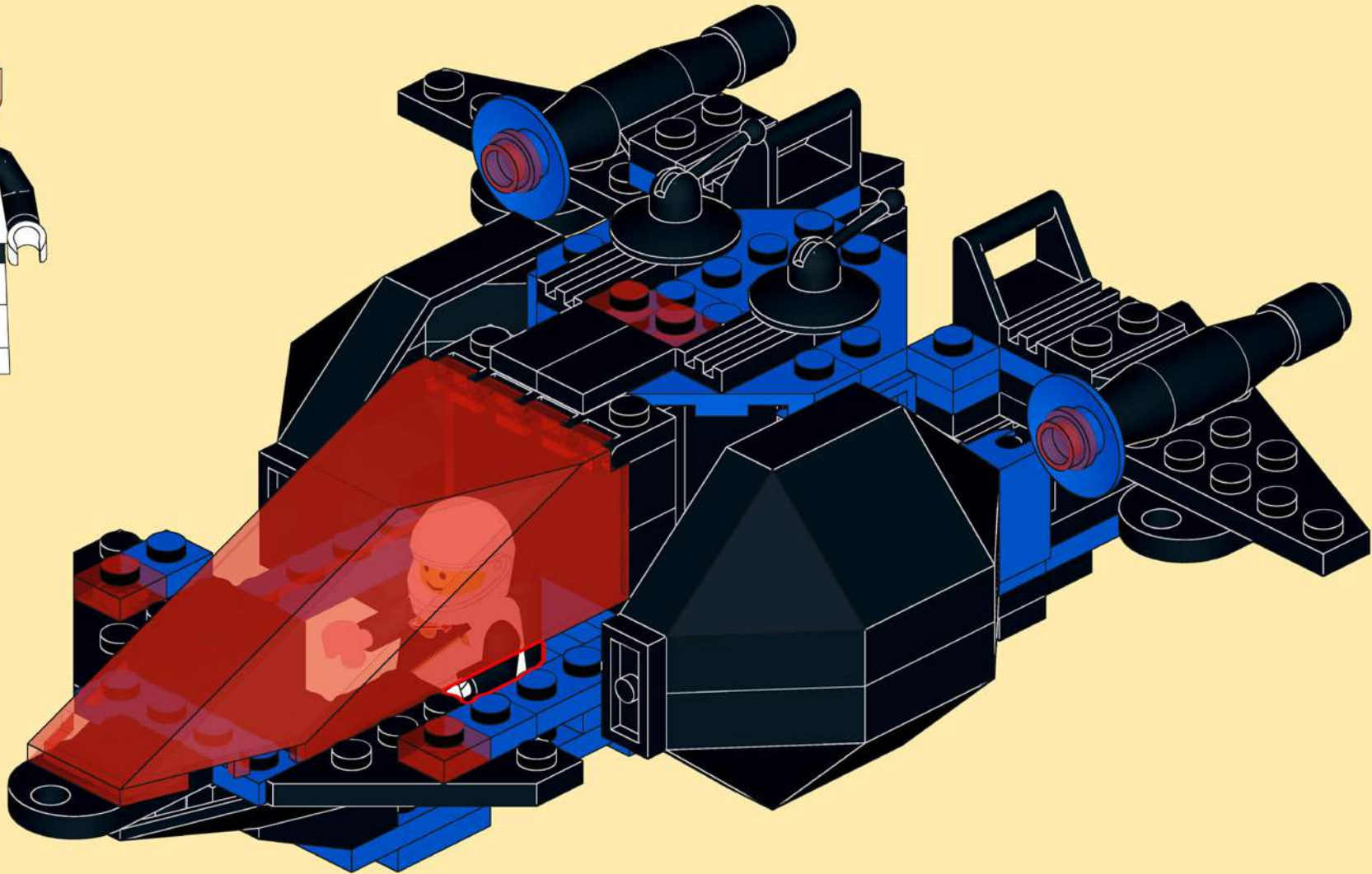

32

