



M-Tron walker, 1987, note the early greebling.



M-TRON WALKER PROTOTYPE (1987)

INSTRUCTIONS

CONCEPT BY LEGO
PHOTOGRAPHY & INSTRUCTIONS
BY COSMIC.BRICK

Introduction

This M-Tron Walker is a prototype from 1987, as depicted in the awe inspiring interview with Jens Nygaard Knudsen by Mark Stafford, in BrickJournal issue 6, vol. 2 released in 2009.

This thing that should not be is a “Magna-Tron” prototype, now known as M-Tron. This thing is definitely the odd man out as a different color scheme was used. It uses colors which in hindsight were applied with Blacktron II. The same goes for that jet pack built in (released in sets from 1991).

Although this is the third mecha from the article page, it's not transforming. I absolutely love the looks and part usage with just the right amount of trans-neon green. Accompanied with the caption “Note the early greebling”, this futuristic looking model stands out with its details. Almost entirely built with minifig utensils (which bring a lot of texture) and a few basic bricks this small prototype is quite the attraction.

It's not hard to assemble, but maybe these steps come in handy as this prototype consists of two halves only connecting by sticking a modified plate with handlebars into the front of the jet pack (which doesn't make it the most stable build around).

The jet pack is mounted using a plain black torso (without arms) and a round 1x1 brick (or black minifigure head) underneath the front wedge plate. Beware though, as it easily falls apart when adding or removing a minifig. I'm a big fan of the versatile chainsaw part introduced in sets since 1990, and this build is a another good example why.

So all in all a bit fragile, but the legs are immense fun! The articulation is very flexible, which makes it really easy to display it like something from Boston Dynamics or have it moving like a galloping and rearing space horse (see page 4), yee-haw!

Have fun building!
Chris (cosmic.brick)



Excerpt from “The Truth About Space!”

Comparison

Photo from Niels Milan Pedersen's personal LEGO archives, as published in BrickJournal issue 6, volume 2 (2009).



M-Tron walker, 1987, note the early greebling.

Replica model by @cosmic.brick.



The model

Replica model by @cosmic.brick.



M-TRON WALKER PROTOTYPE (1987)
MODEL INSTRUCTIONS

 **MORE EXCITING MODELS**
@COSMIC.BRICK

4 / 14

Get your parts ready!



1x
3062b
Black



1x
973
Black



4x
2516
Black

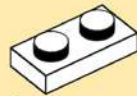

1x
3023old
White



1x
4590
White



1x
2447
Trans-Neon Green



1x
3023old
Black



1x
970c02
Black



1x
4598
Black



1x
3069bp68
White

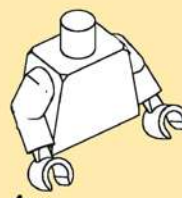

1x
973c00



4x
4740
Trans-Neon Green



1x
2446
Black



1x
3839b
Black



1x
4859
Black



2x
4592c02
White

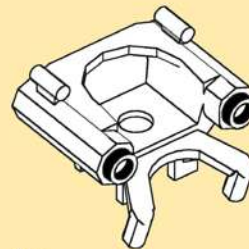

1x
6023
White

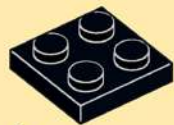

1x
3022
Black



1x
4590
Black



4x
4479
Black

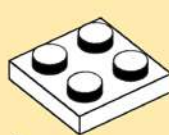

1x
3022
White



1x
3626ap01
Yellow



8x
4735
Black

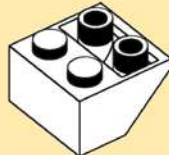

1x
3660
White



2x
73590c03a
Black

1

No air tanks?

These building steps show how to build an exact replica of the original model. Every M-Tron prototype depicted in the article uses minifigs without air tanks. Feel free to add them nonetheless.

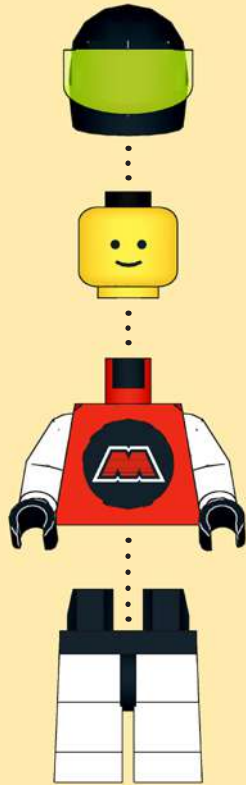

2

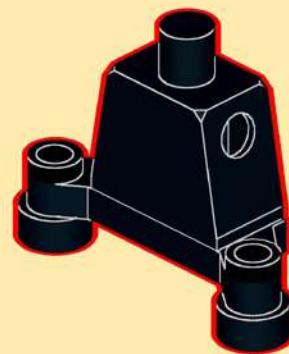

3

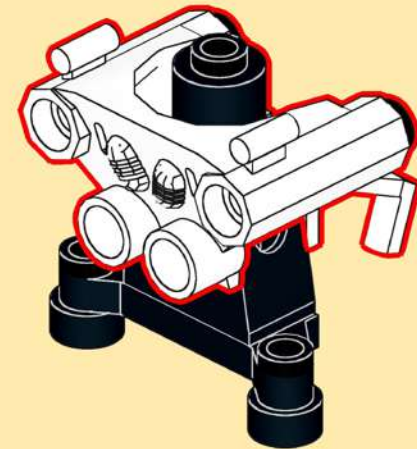
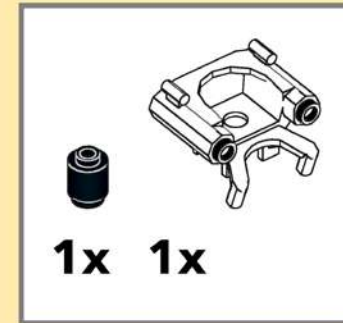

4

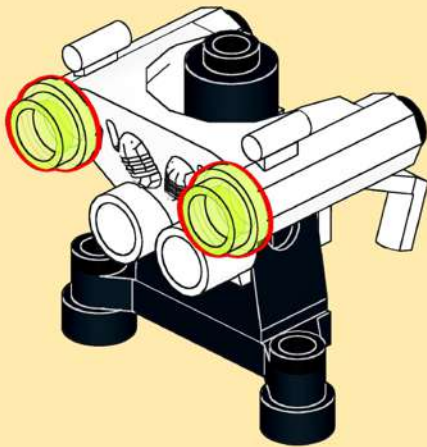

5

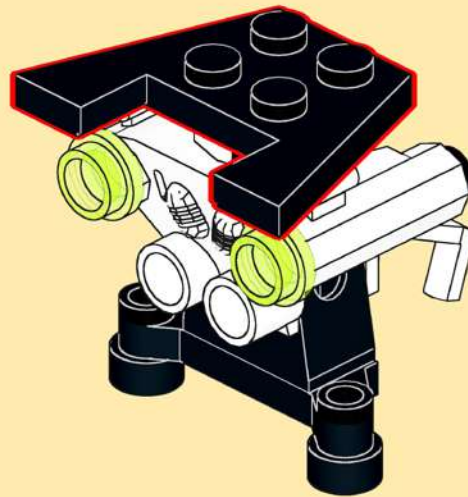

6

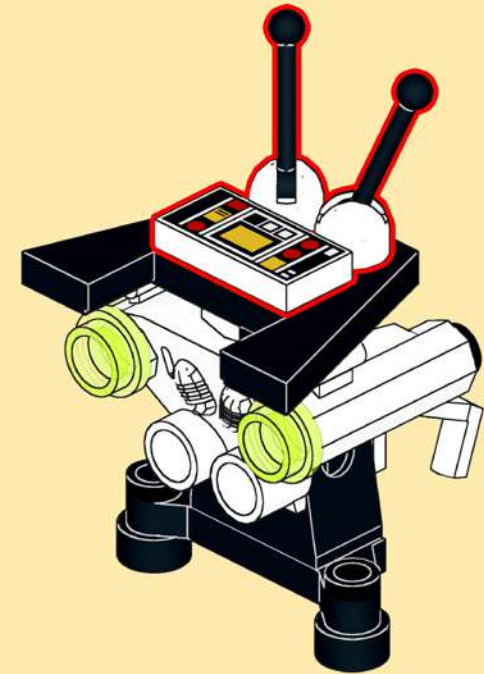
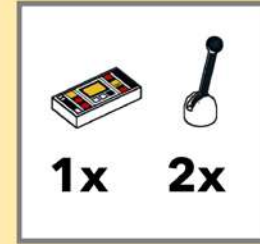

7

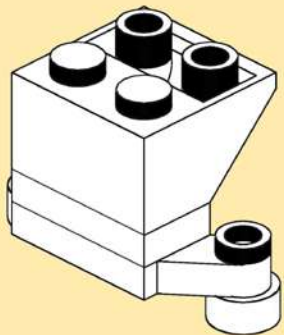
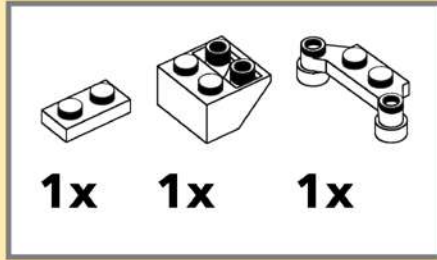

8

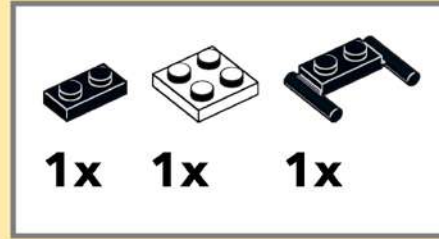

9

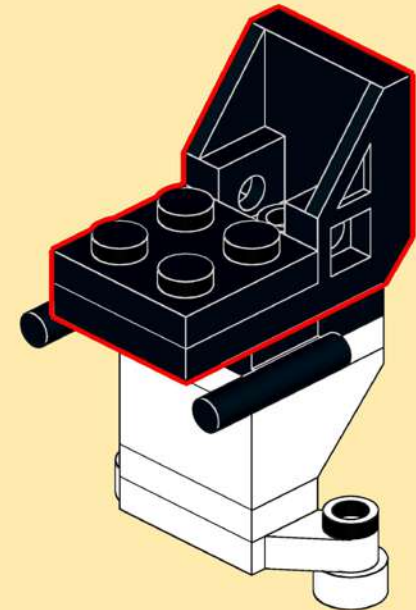
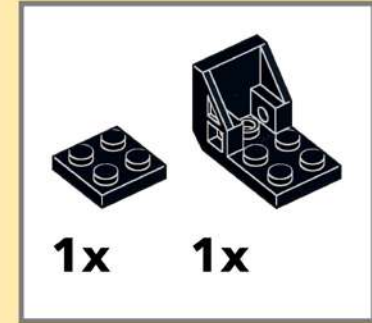

10

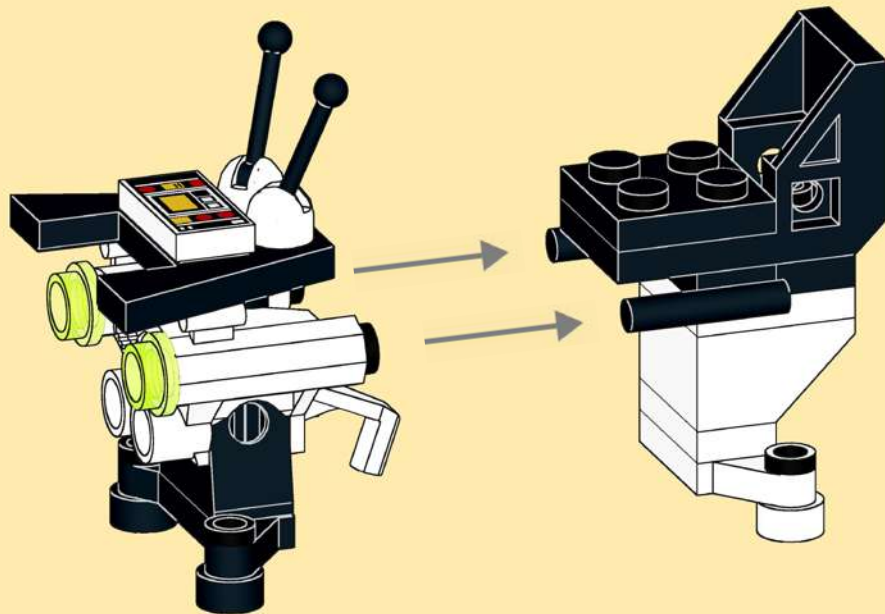

11

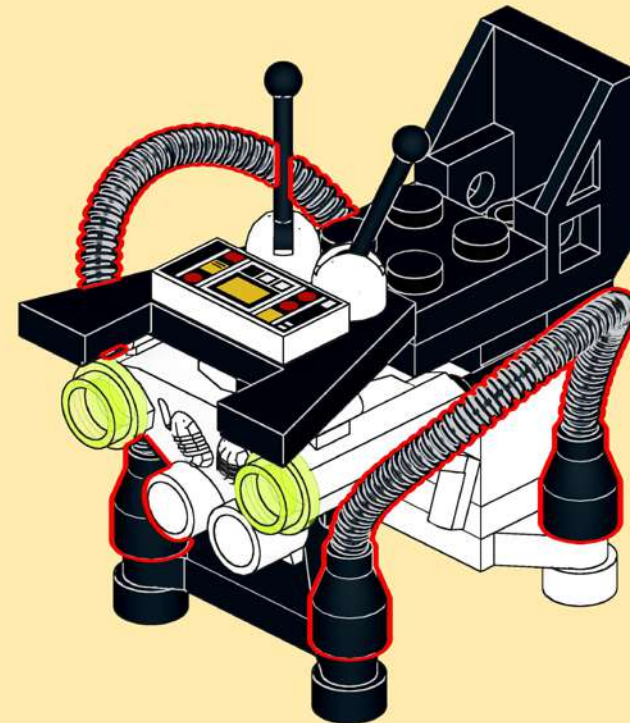

12

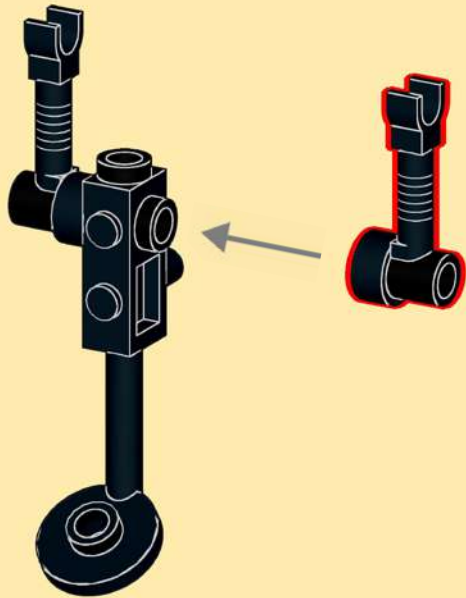
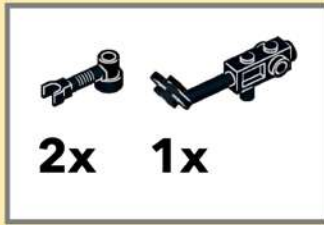

13



14

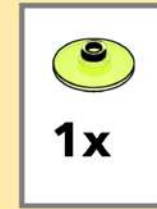

15

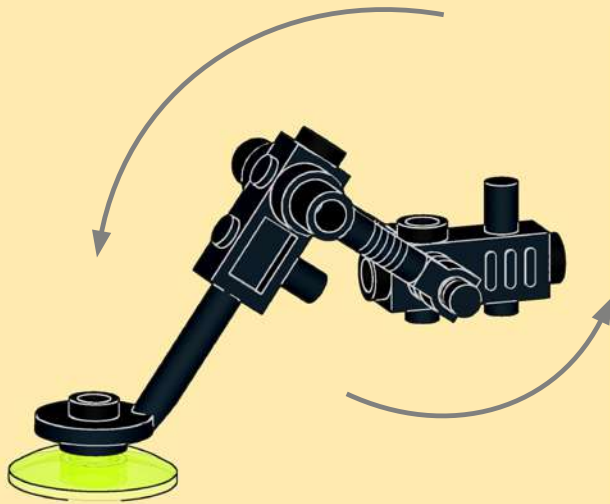

16

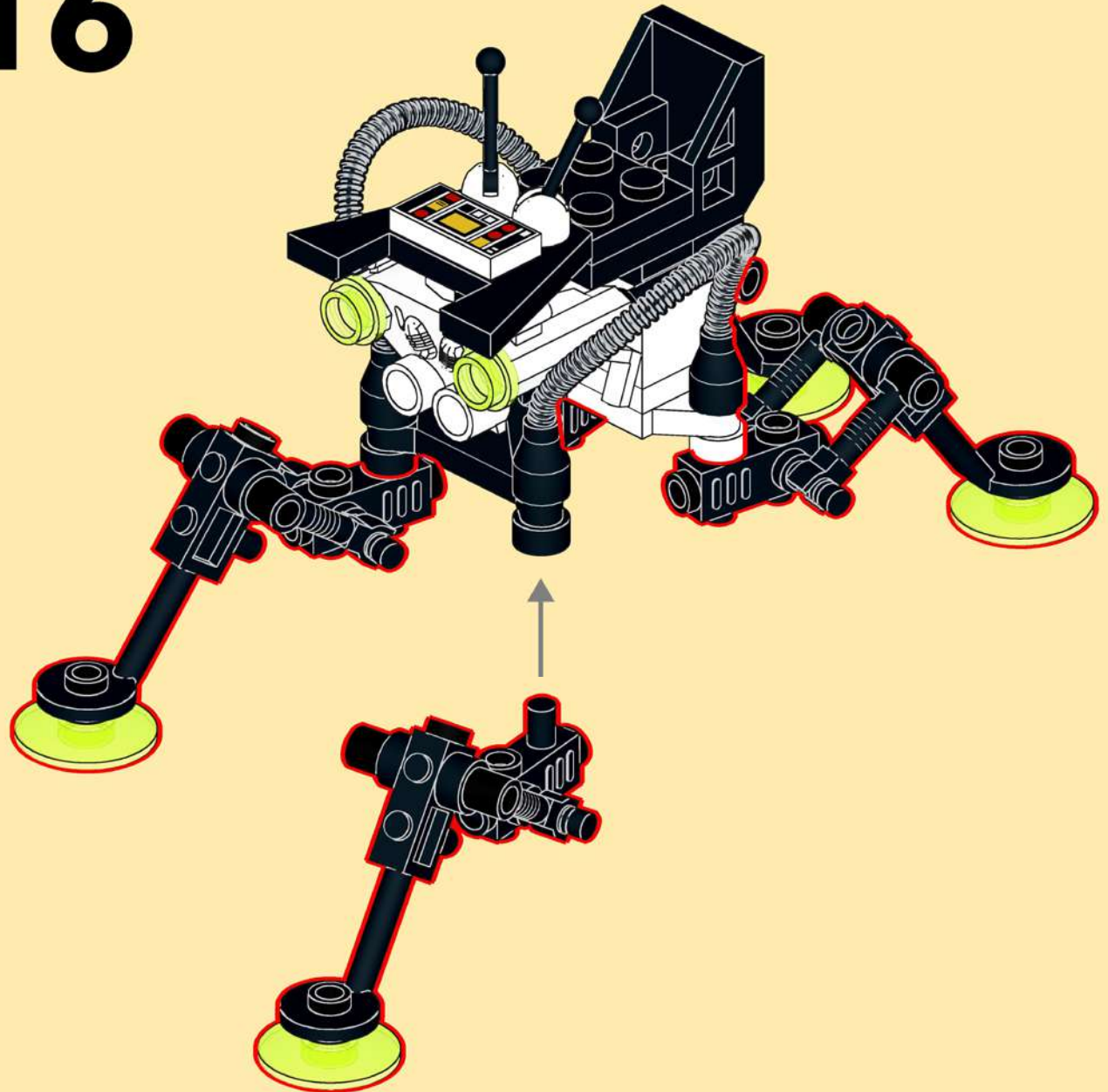

17

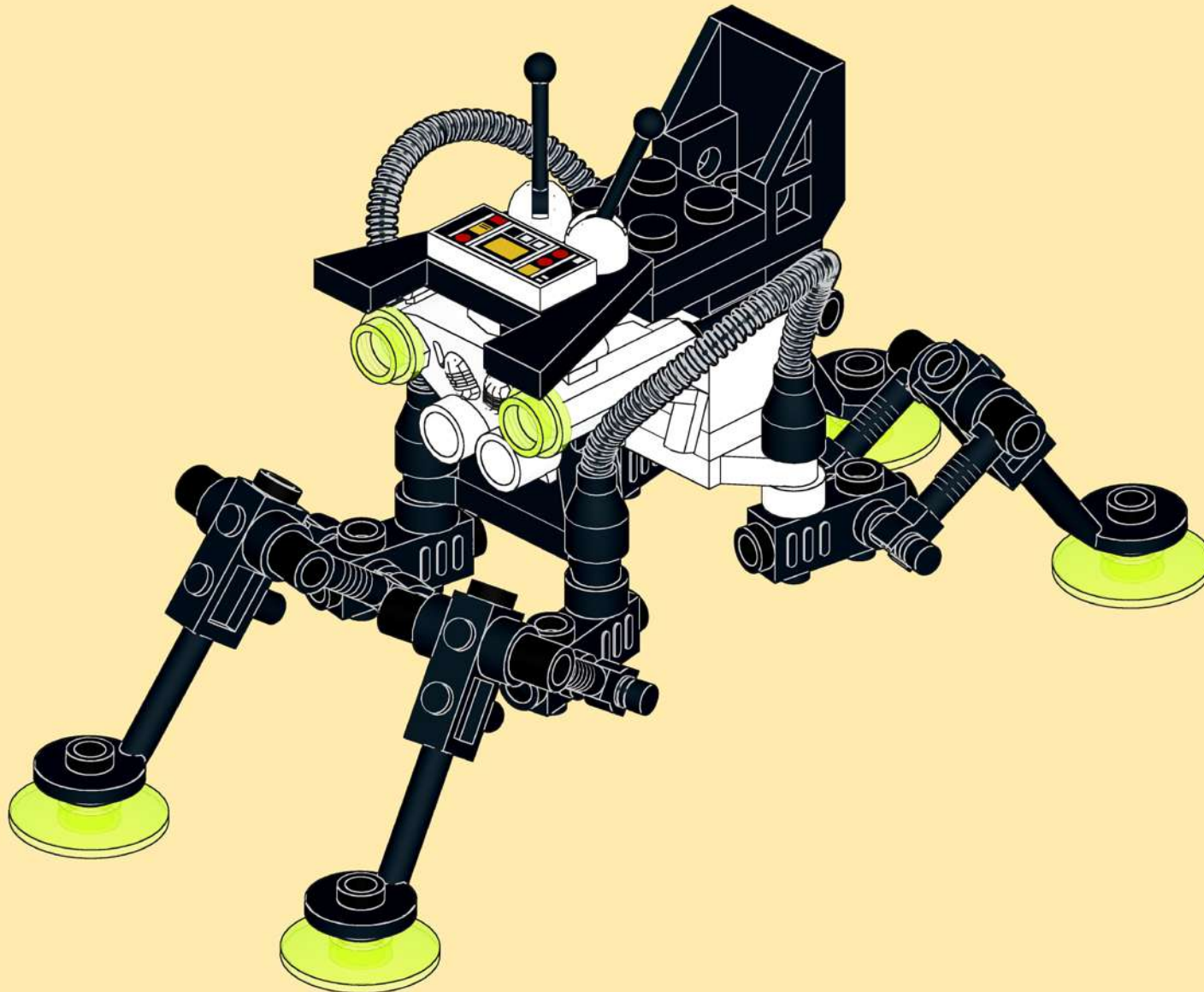

18

