

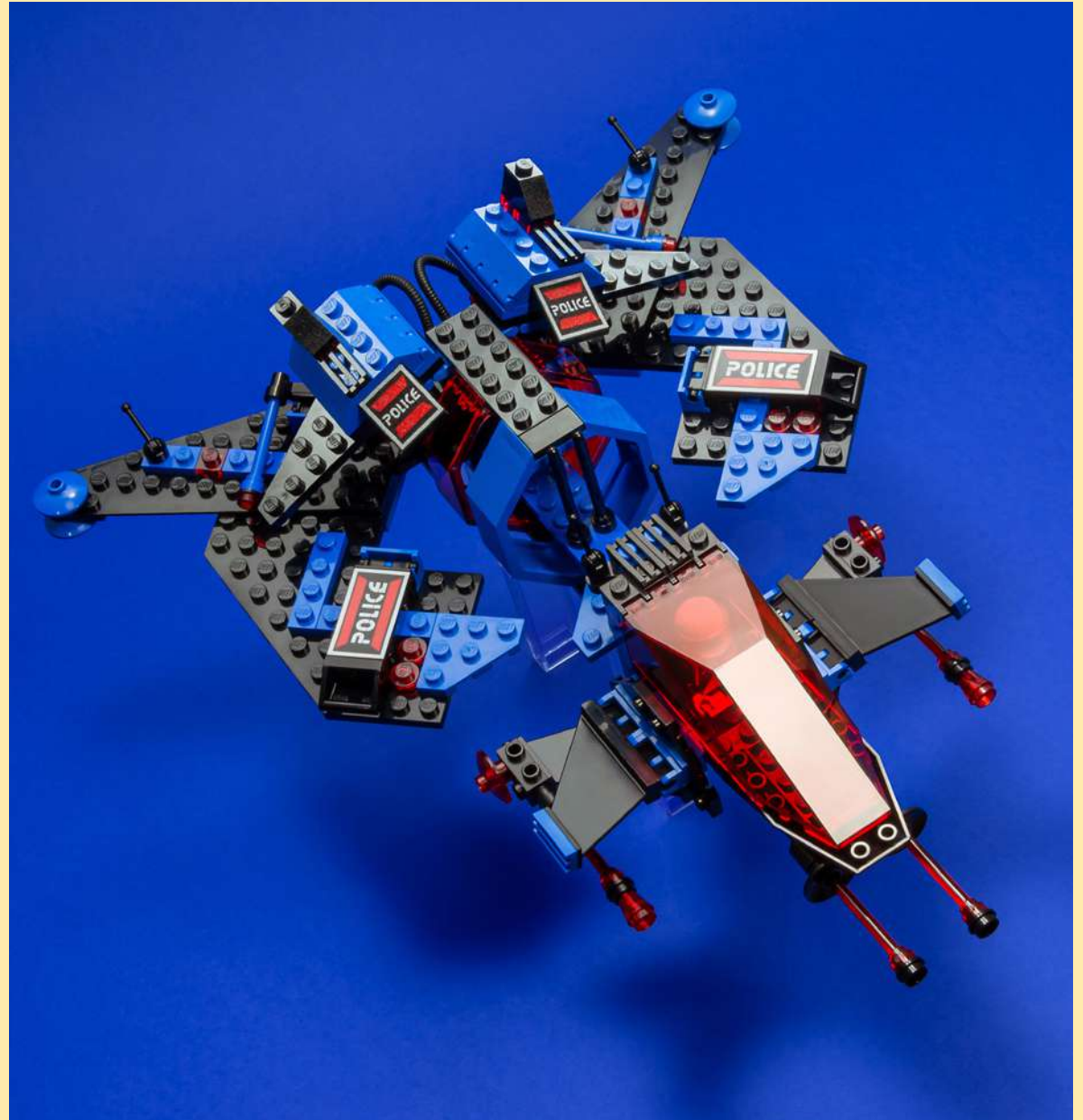

6986
MISSION COMMANDER
ALTERNATE MODEL (1989)

INSTRUCTIONS

CONCEPT BY BJARNE TVESKOV & LEGO
PHOTOGRAPHY & INSTRUCTIONS
BY COSMIC.BRICK





1

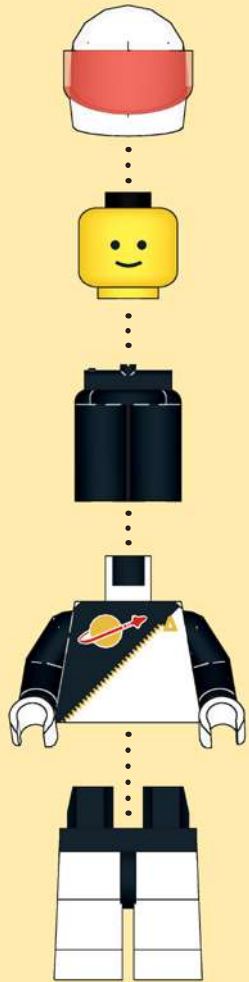

2

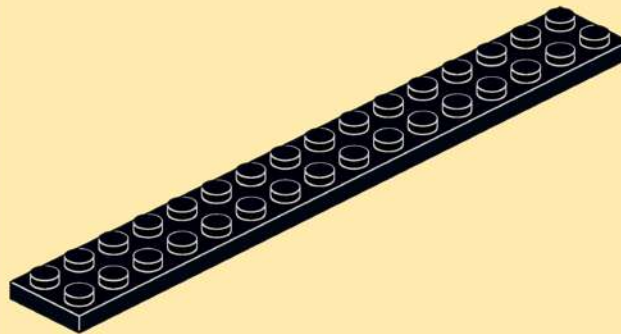
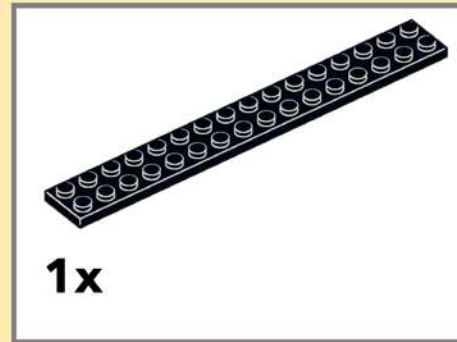

3

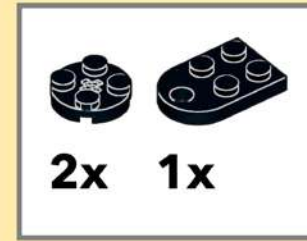

Accuracy

This build is aimed to be an exact replica of the back wall depiction. The parts in this step are not visible in the original image. Leaving them out will not affect the build.

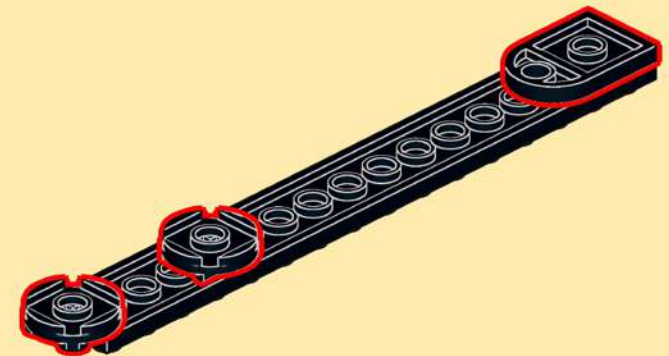

4

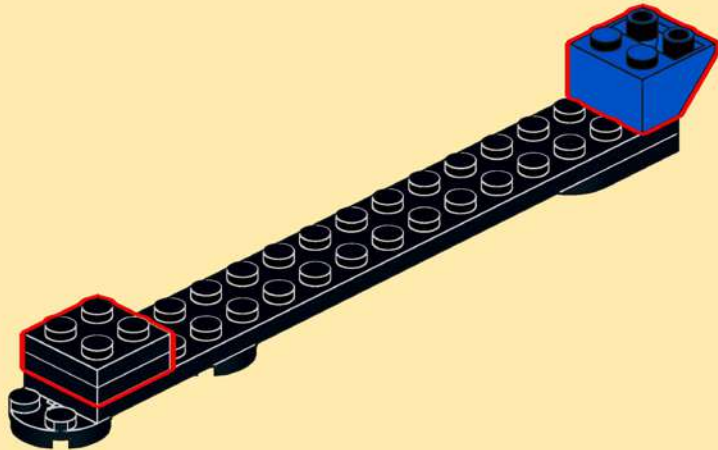
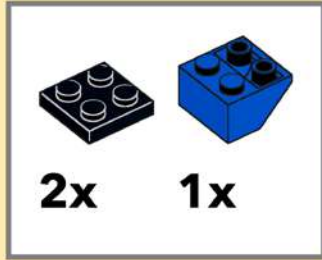

5

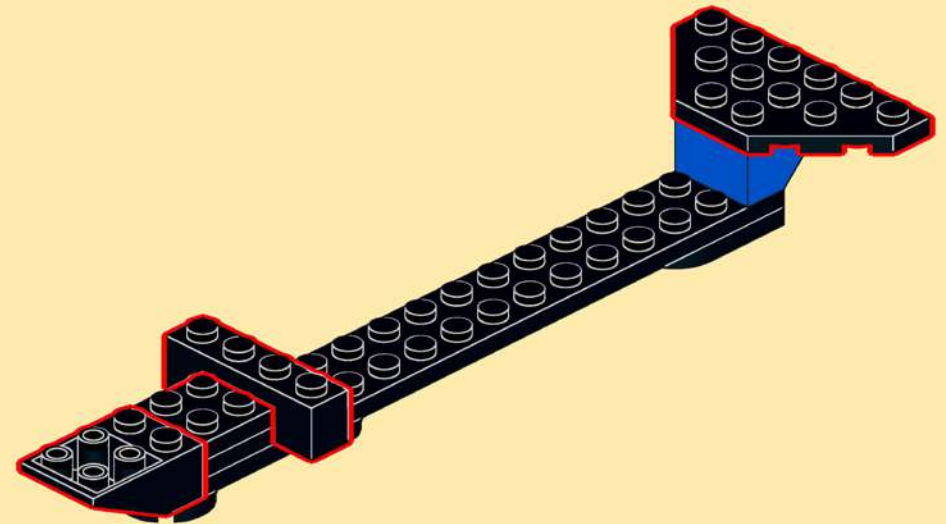
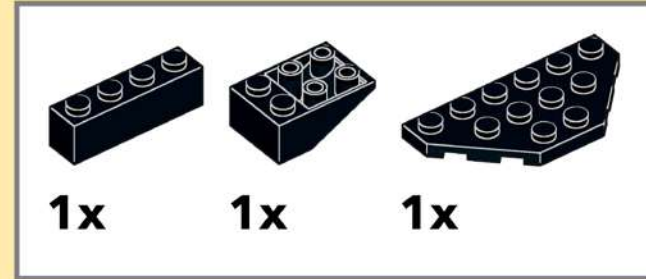

6

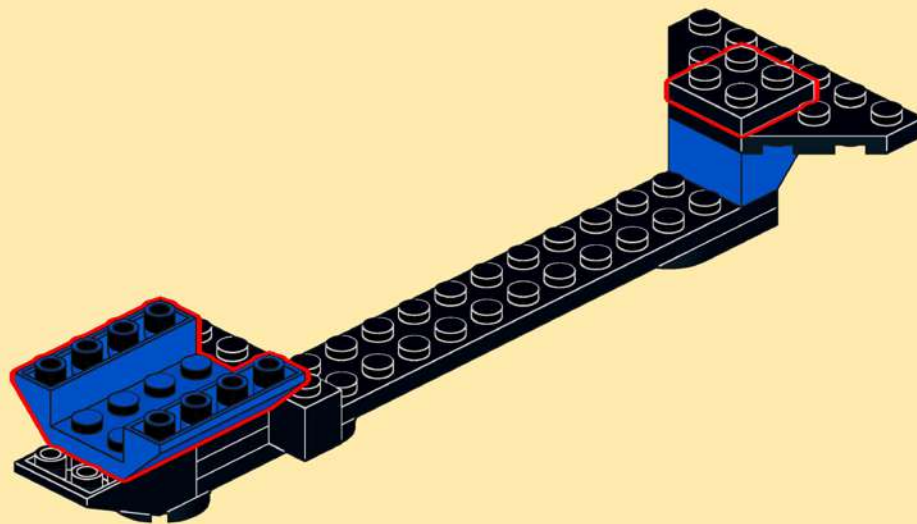
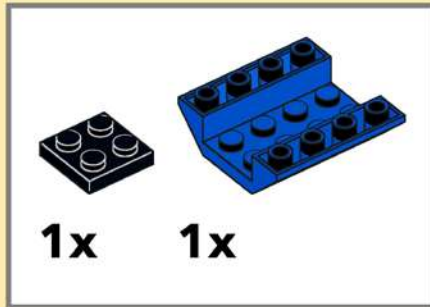

7

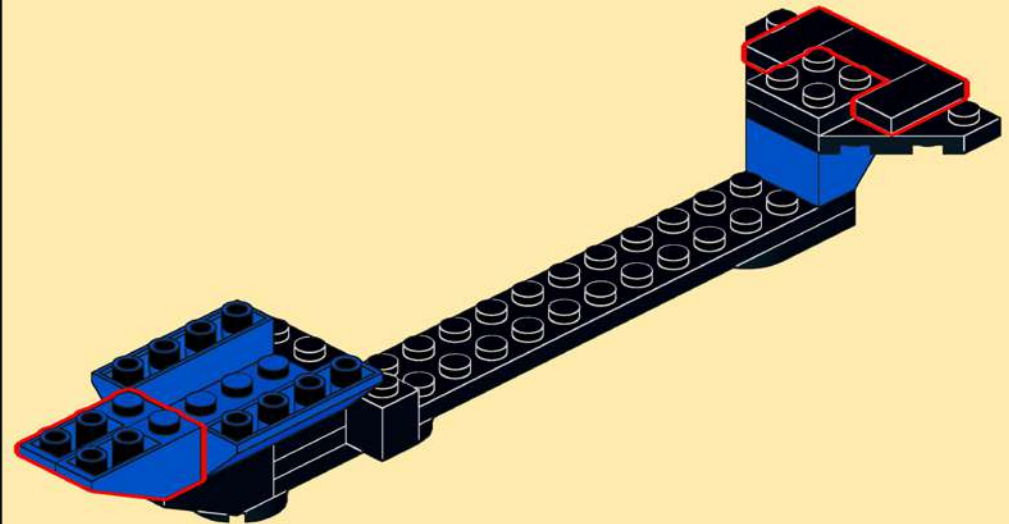
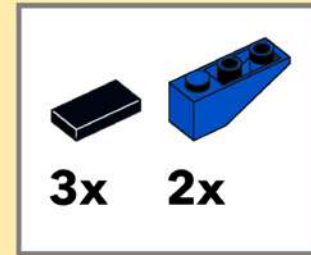

8

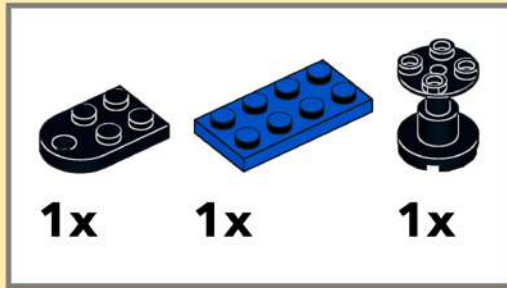

9

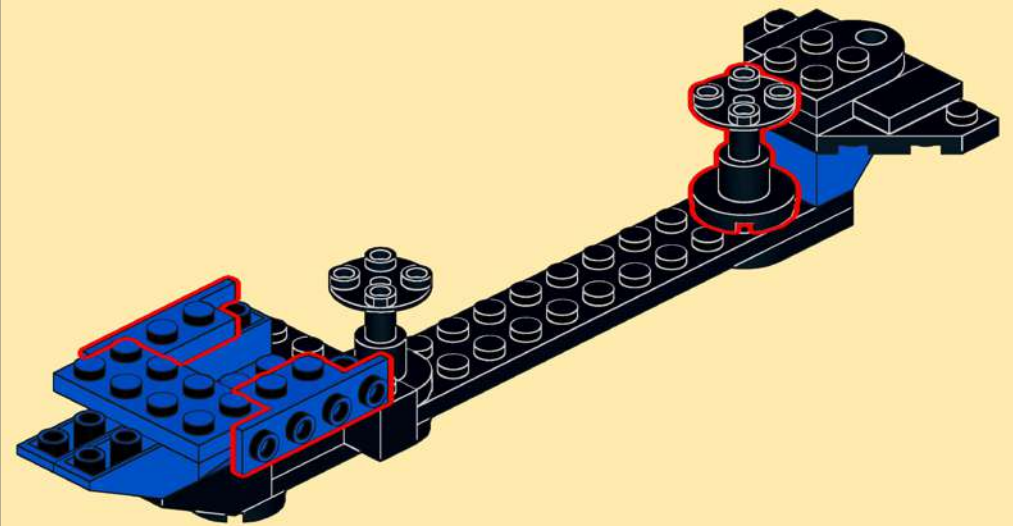
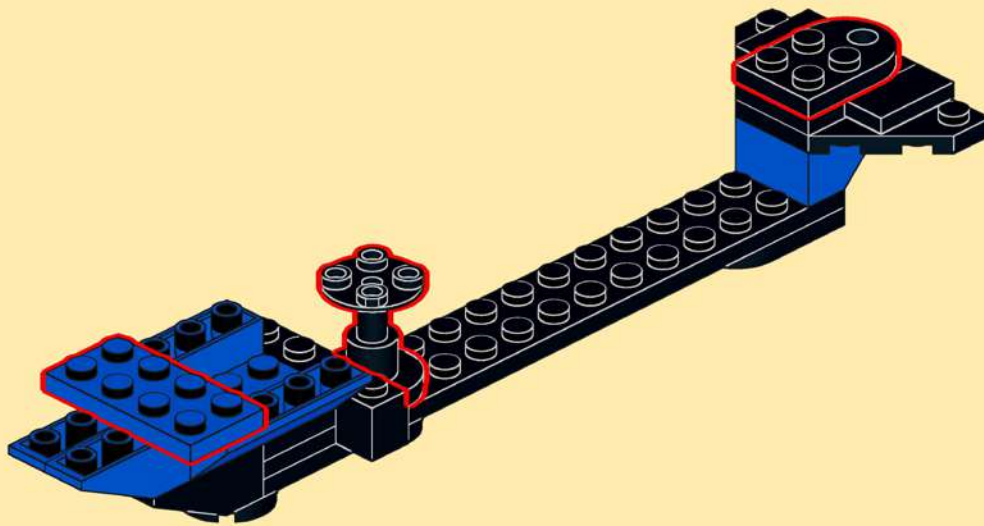
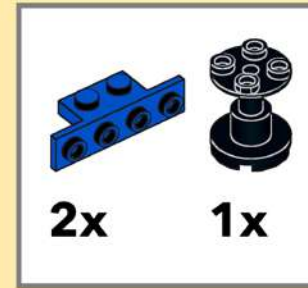

10

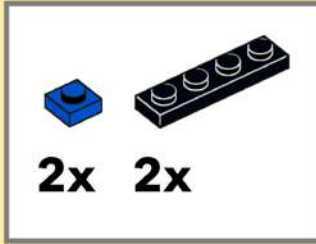

Accuracy

Whilst these four plates make the structure much stronger, this build is aimed to be an exact replica of the back wall depiction. Choose wisely, as the parts in this step are not visually used in the original. The replica as shown on front page of this document has these parts left out.

11

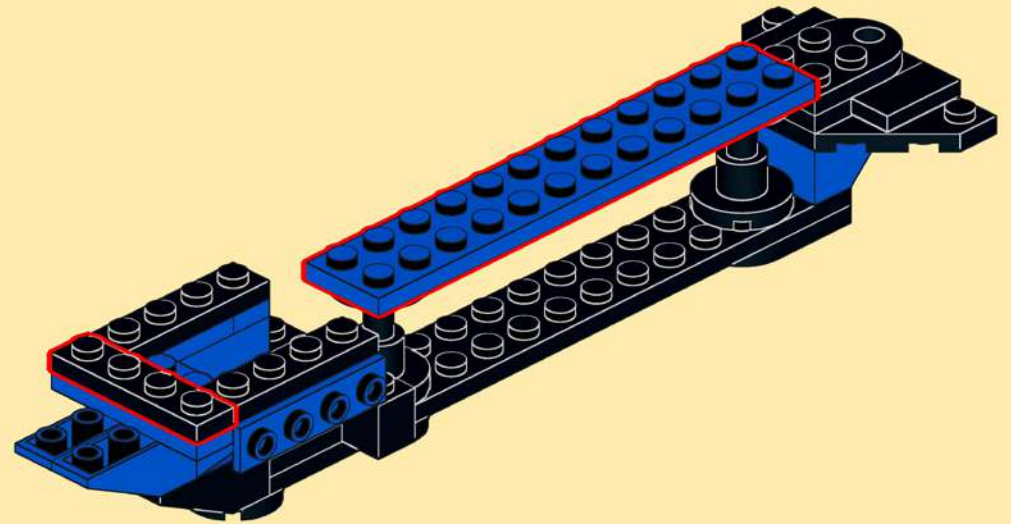
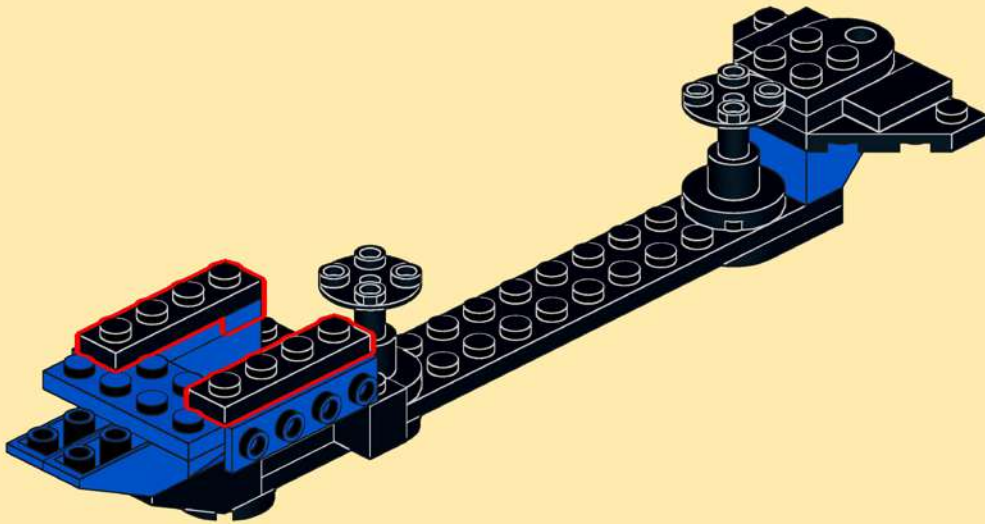
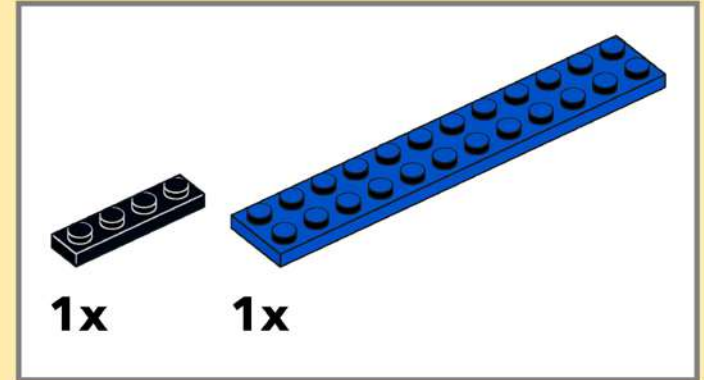

12

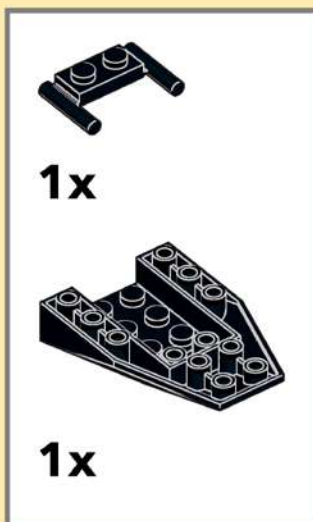

13

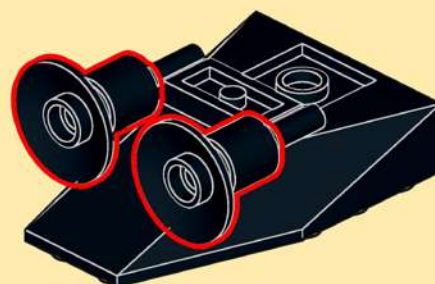
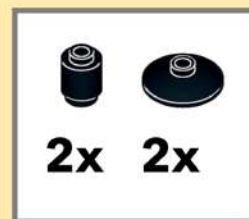

14

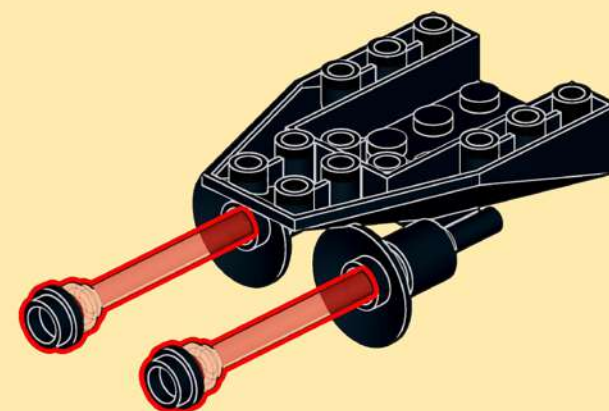
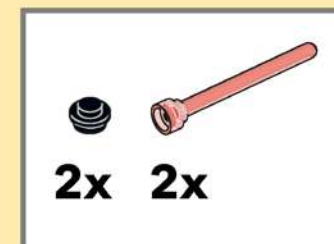

15

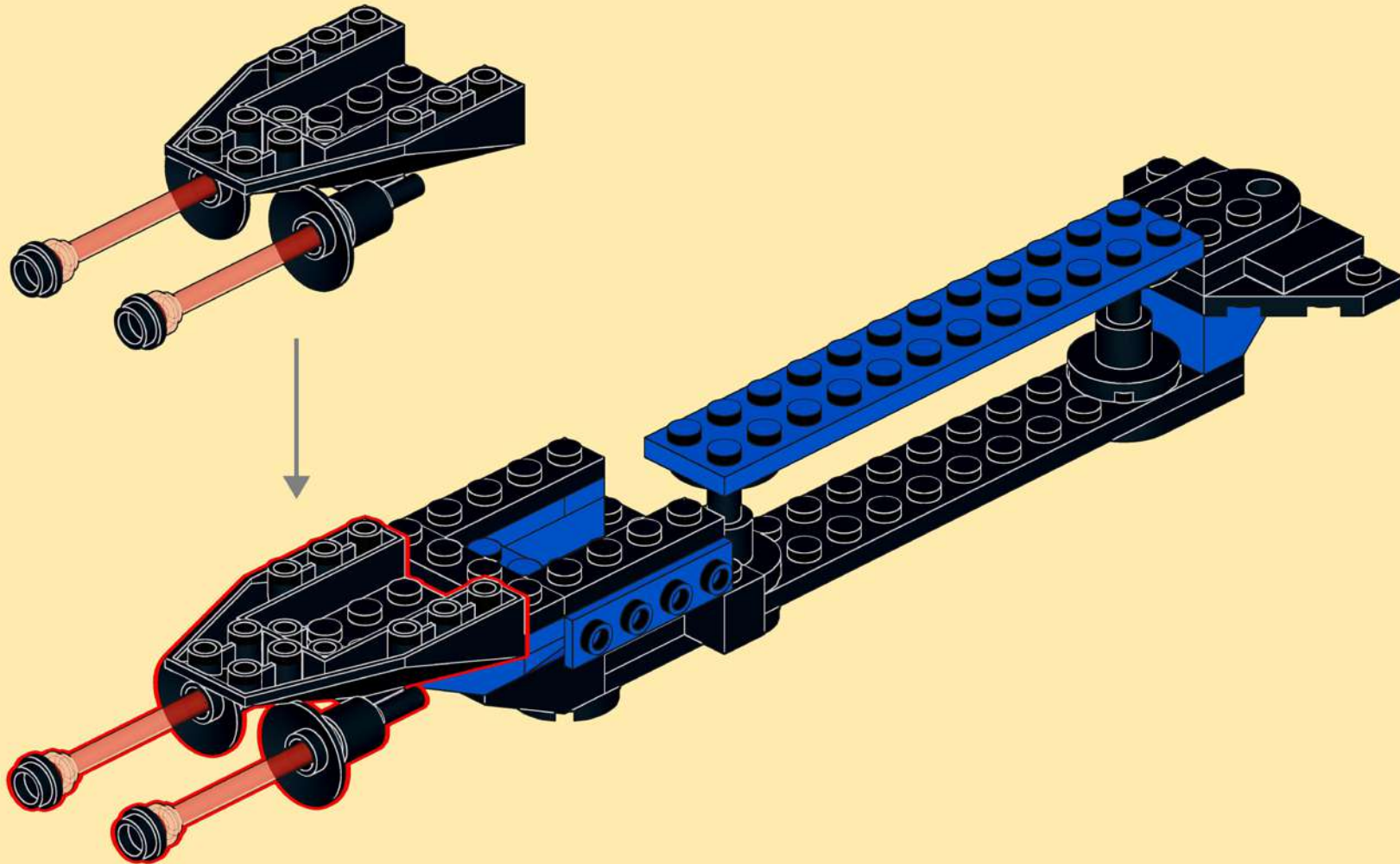

16

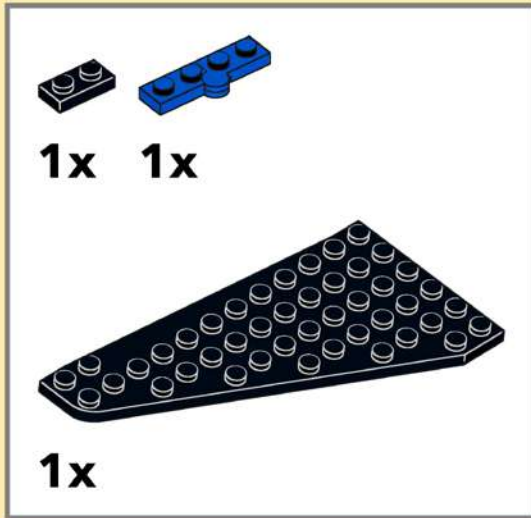

17

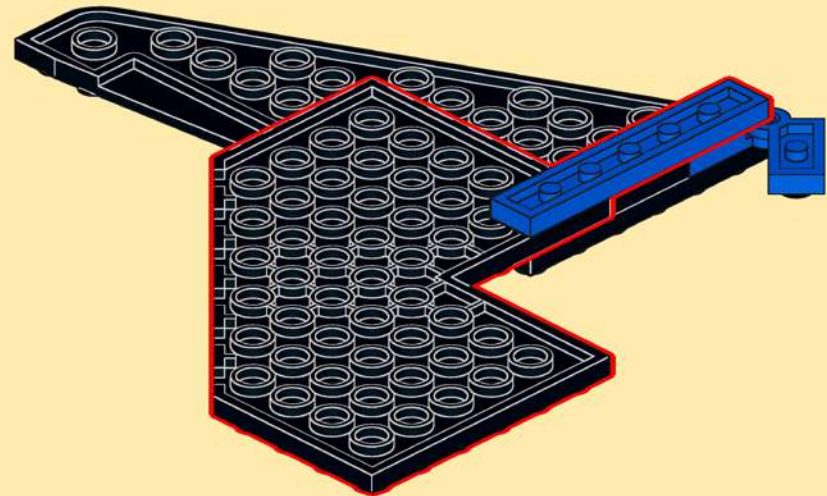
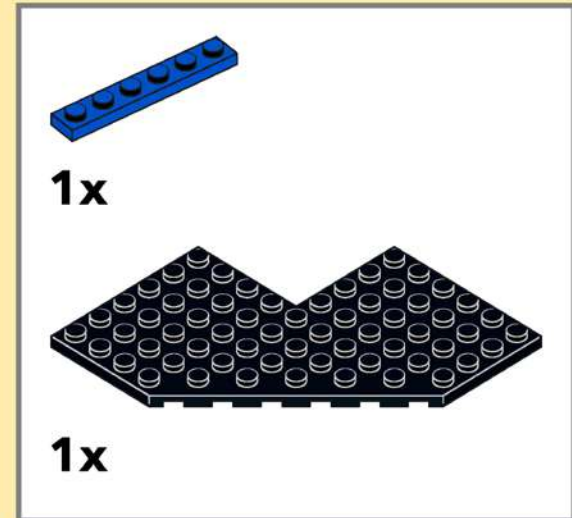

18

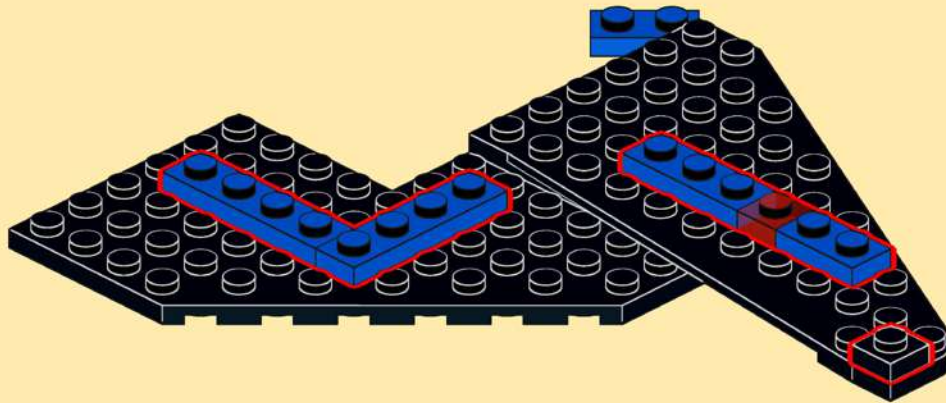
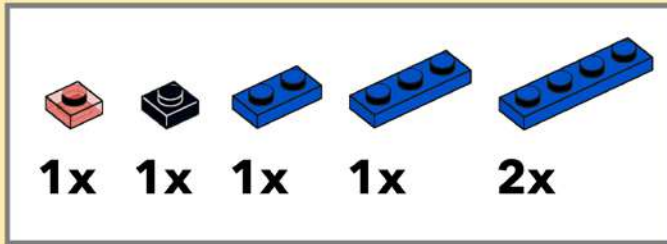

19

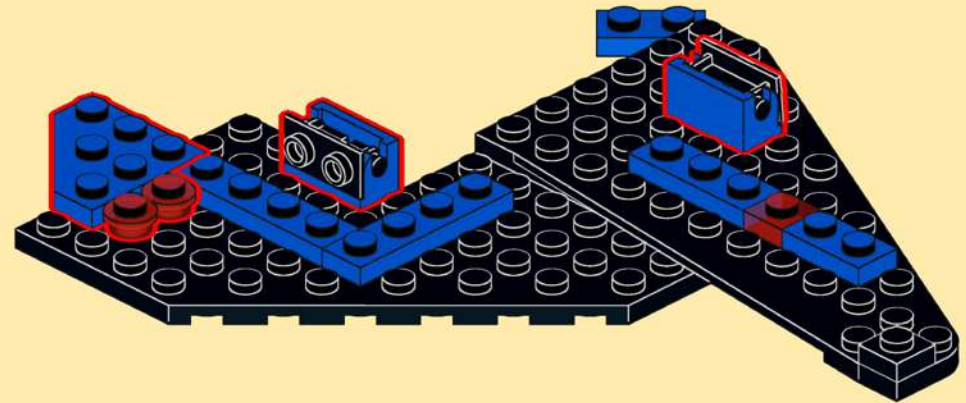
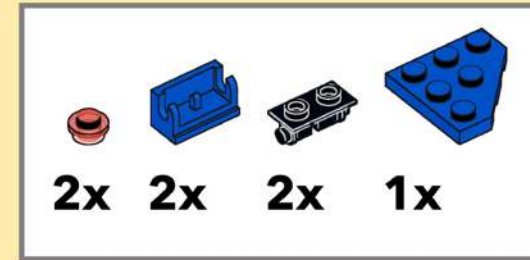

20

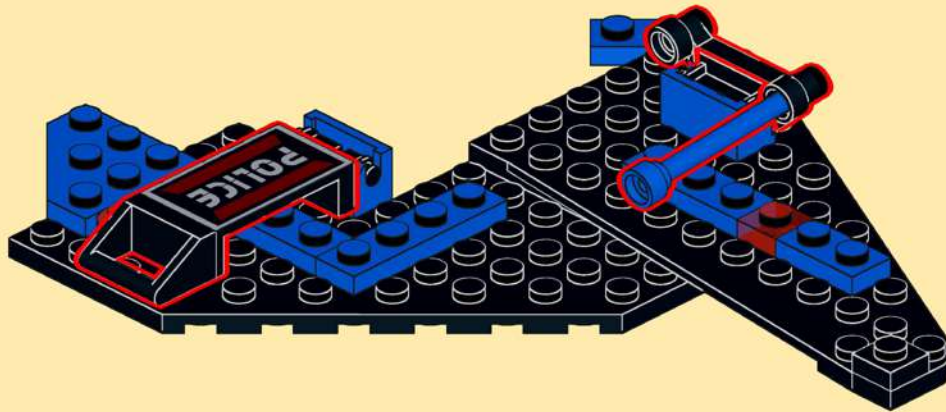
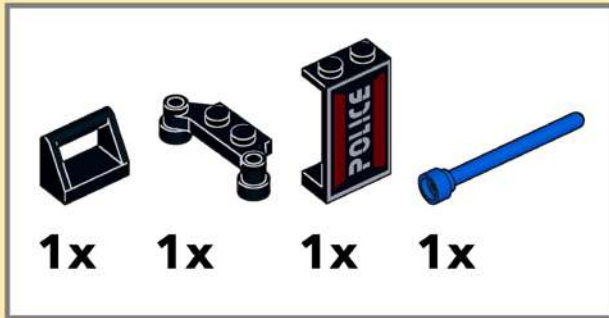

21

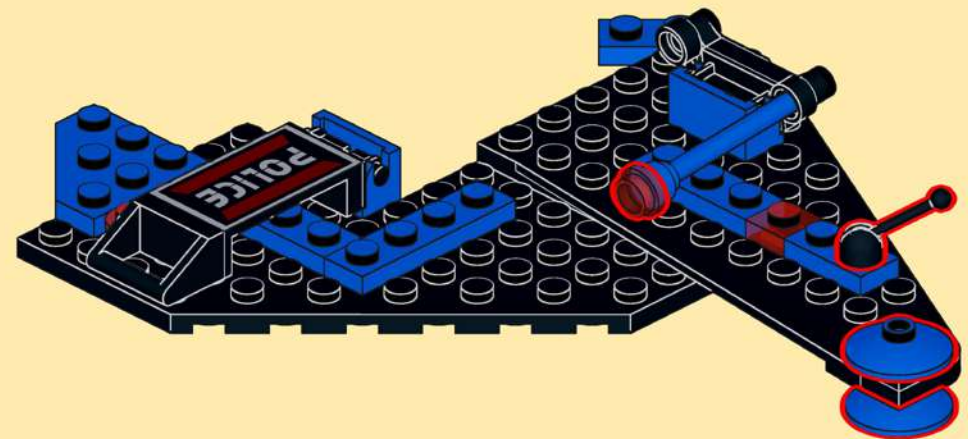

22

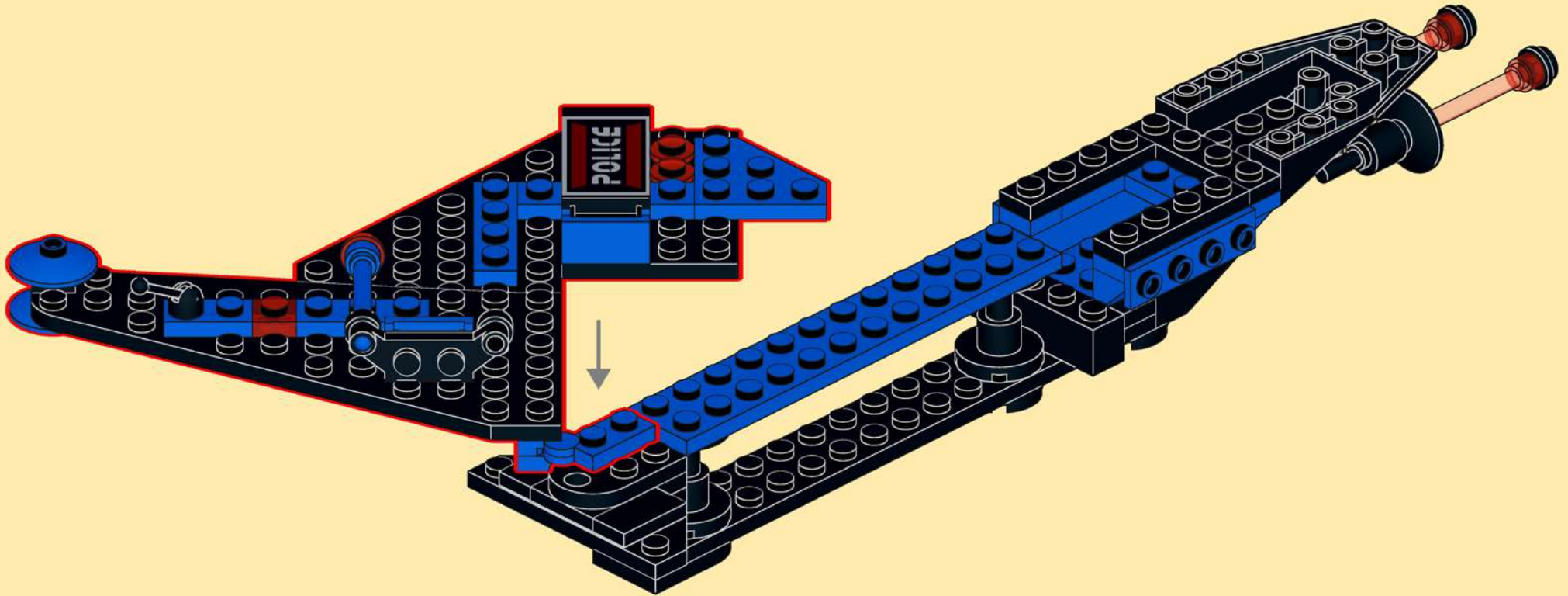

23

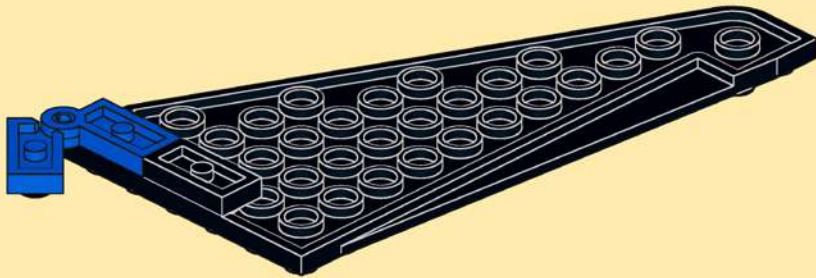
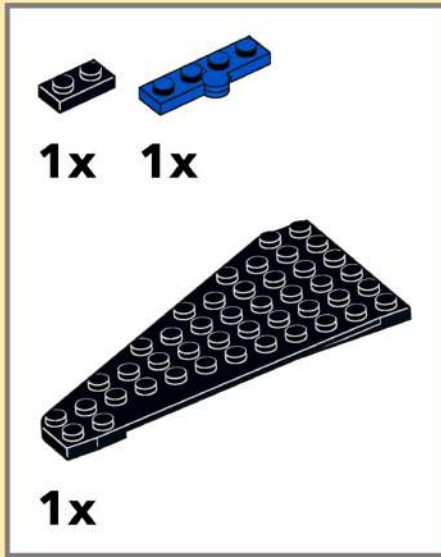

24

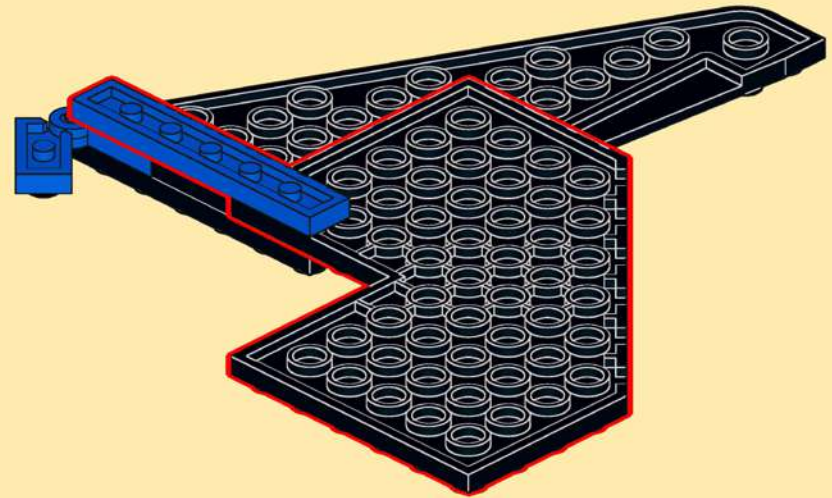
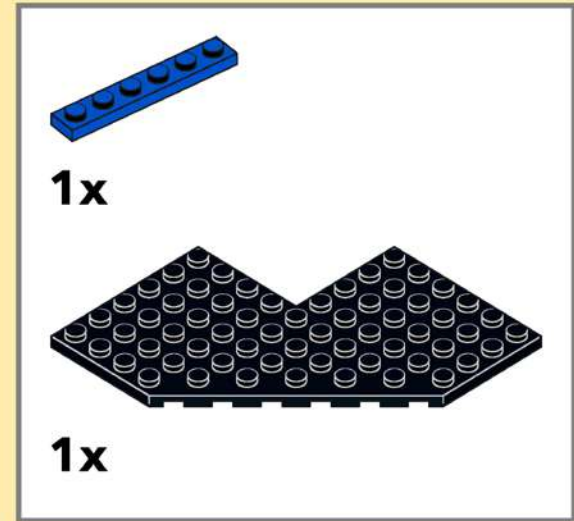

25

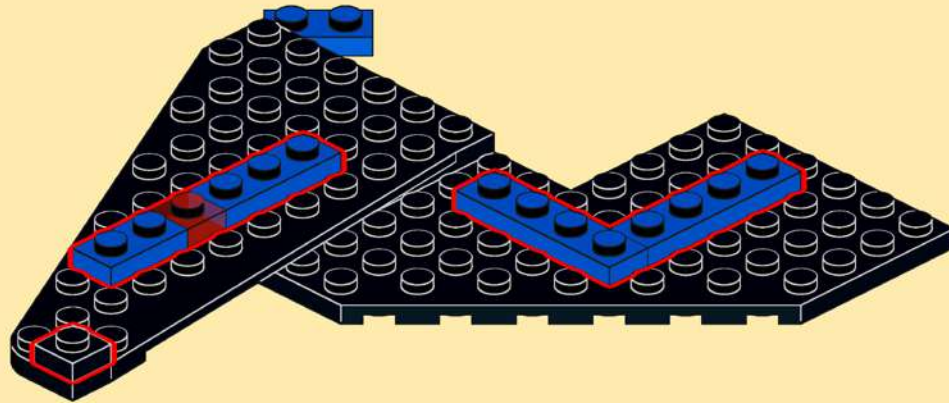
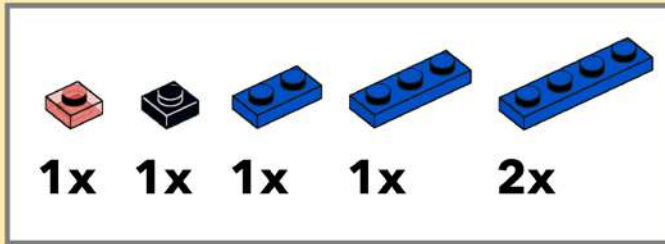

26

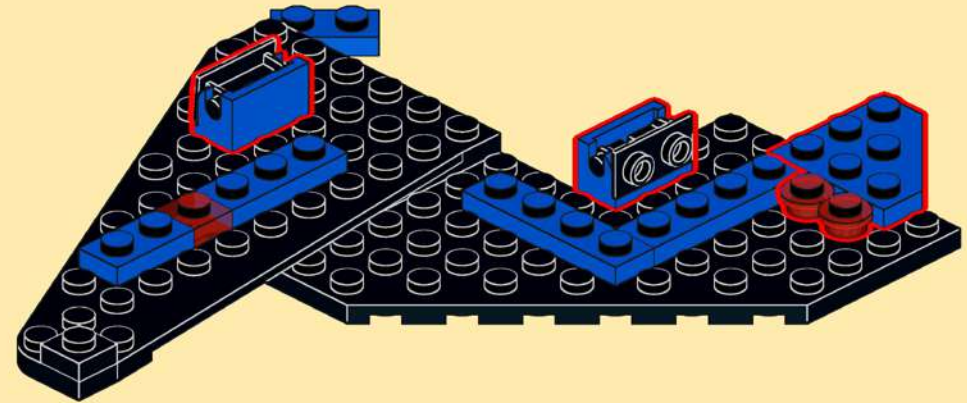
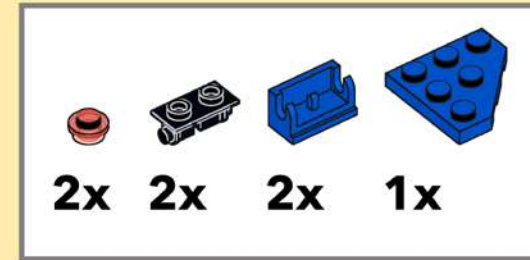

27

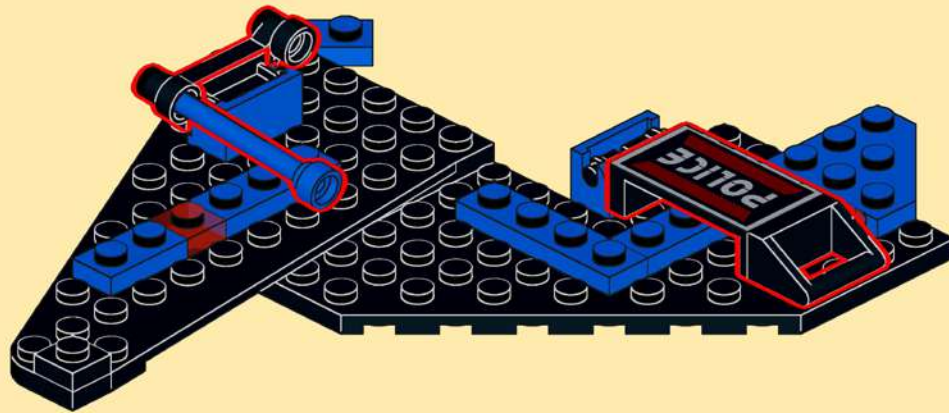
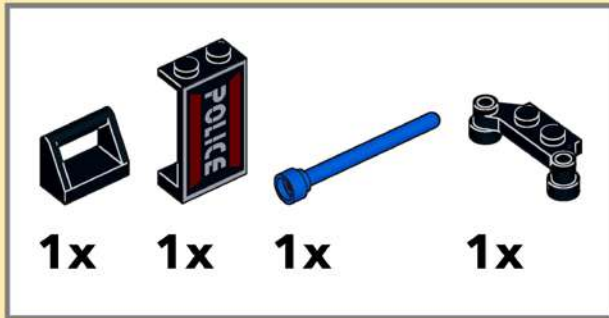

28

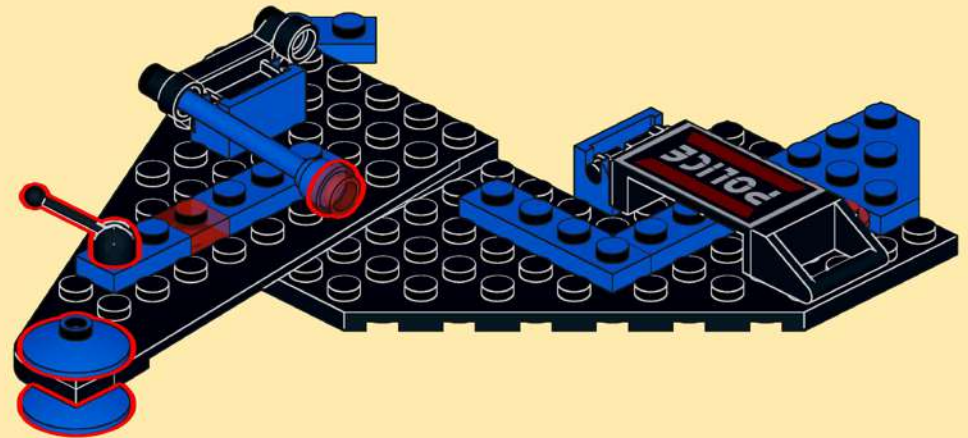

29

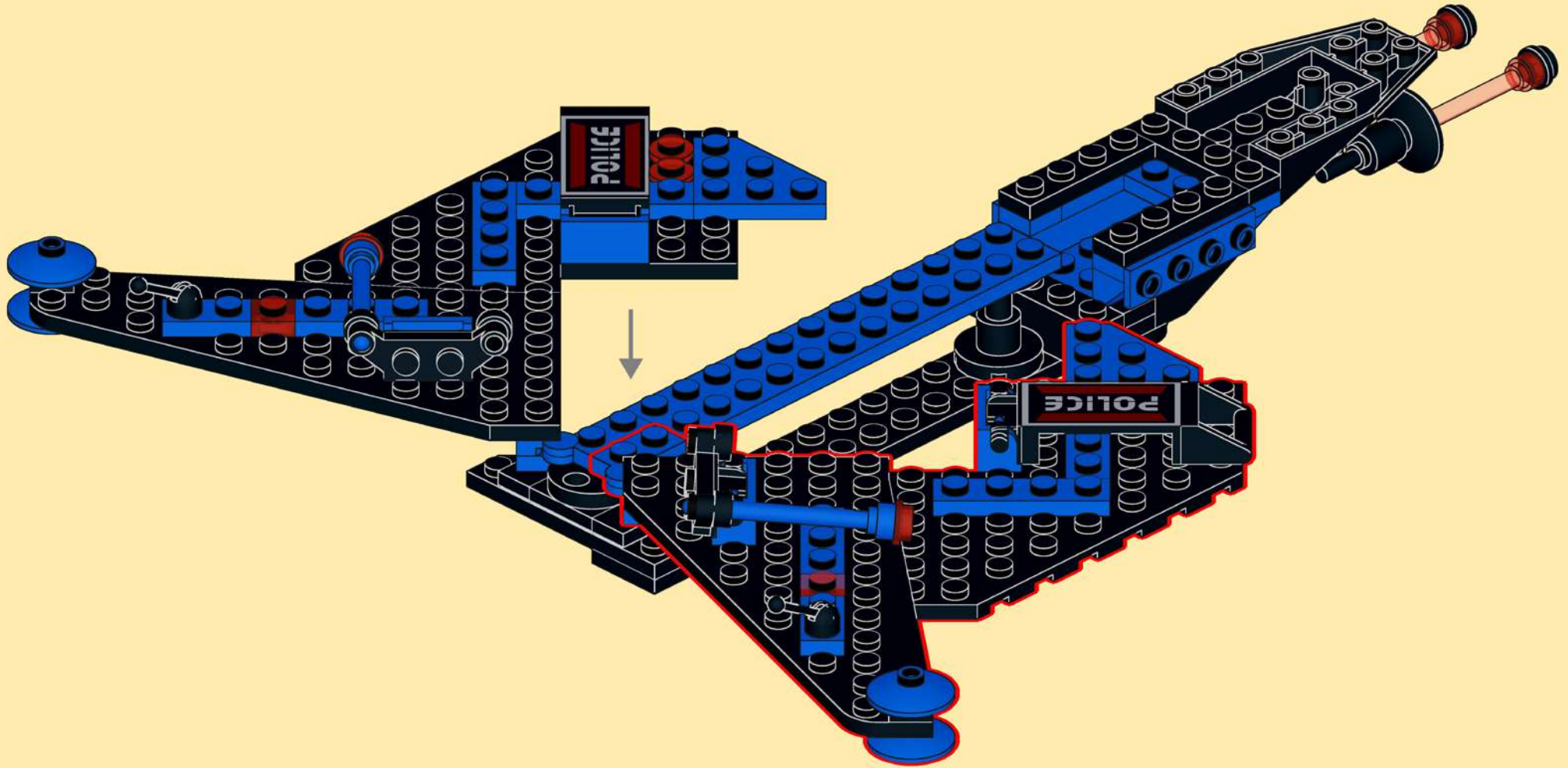

30

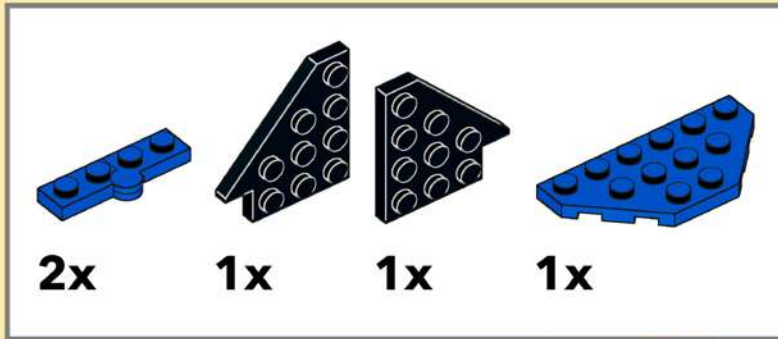

Construction tip

Adding these hinge plates immediately improves wing connection stability. If you are worried about bending, a bonus step is added at the very end of this document.

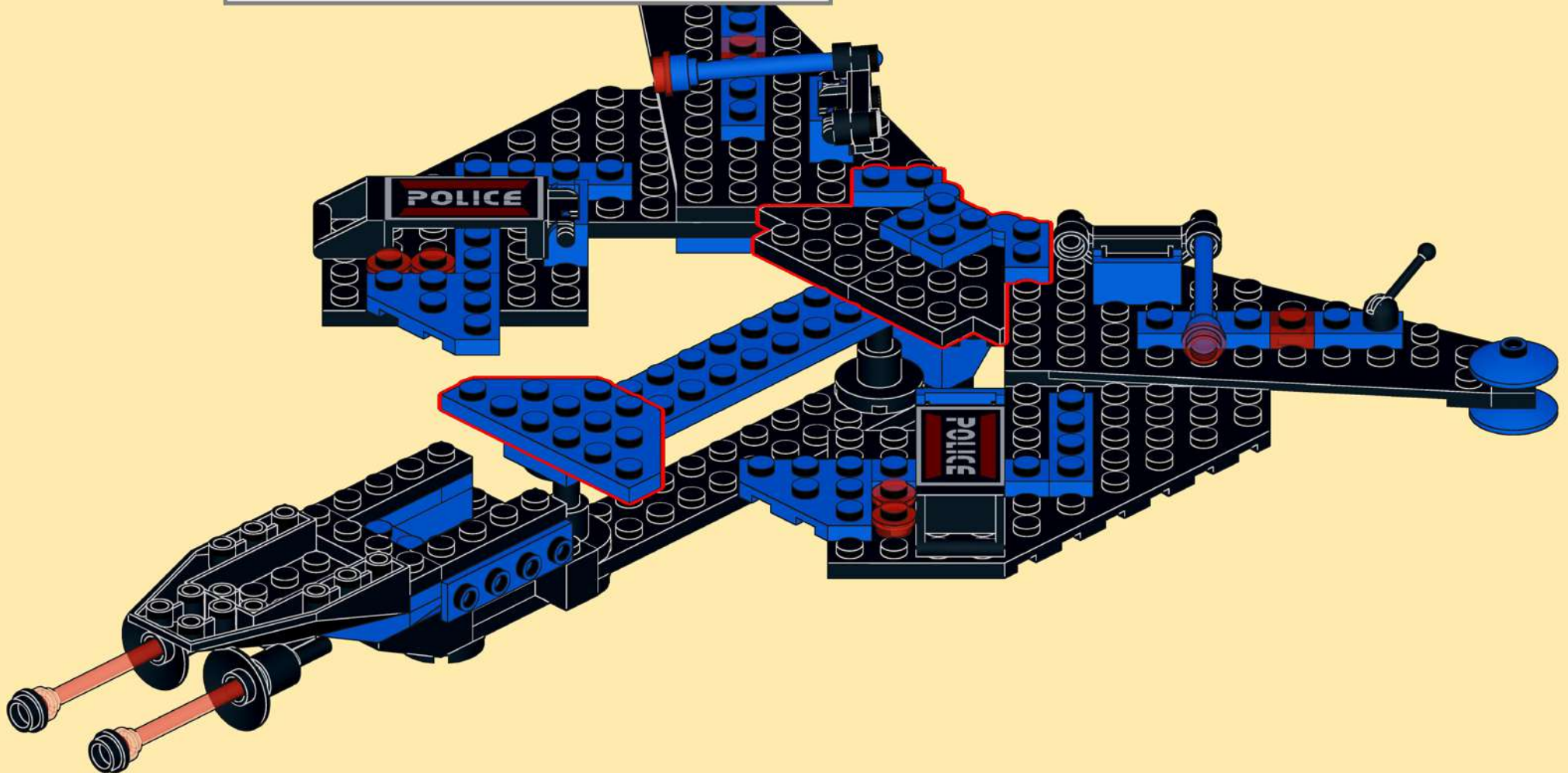

31

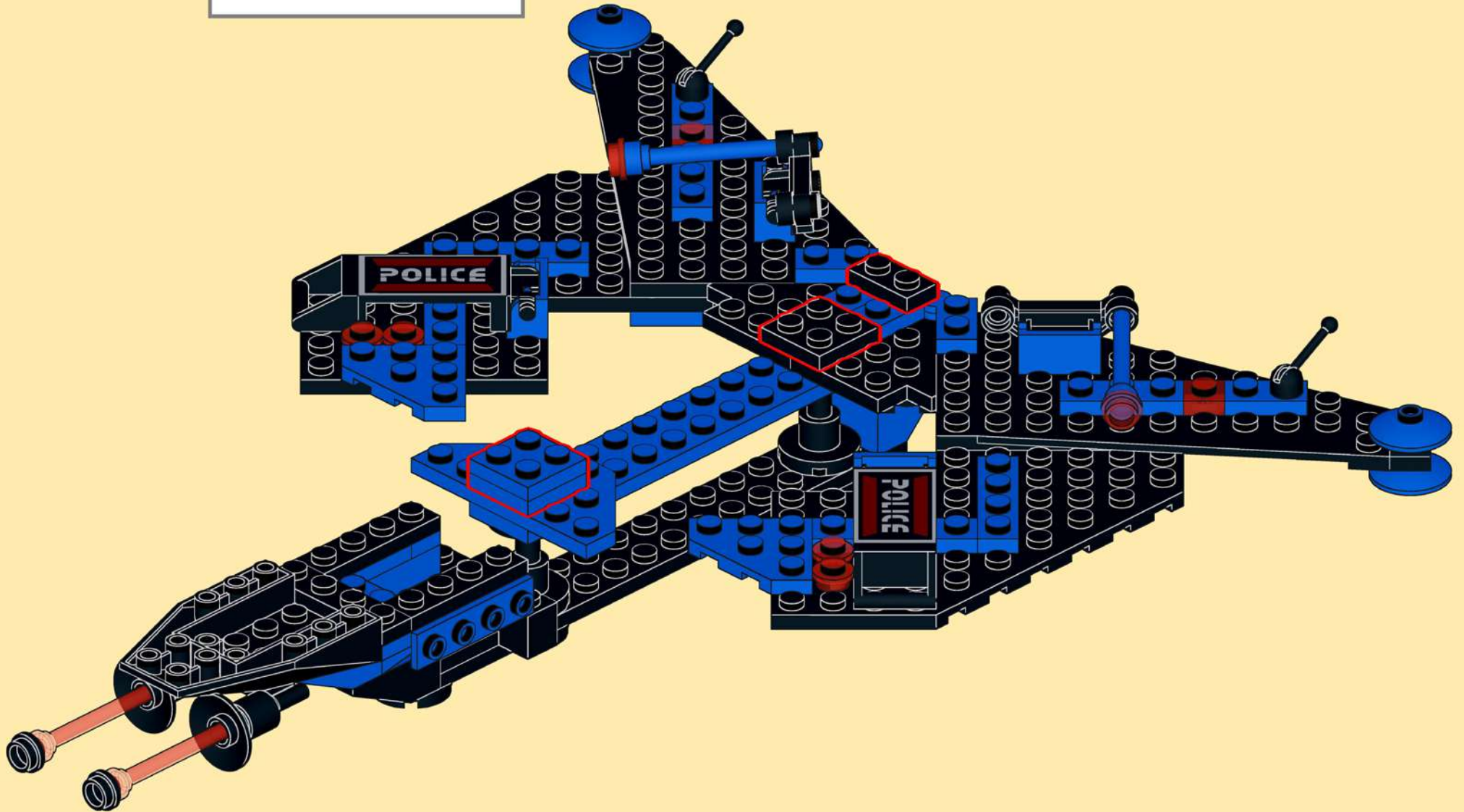
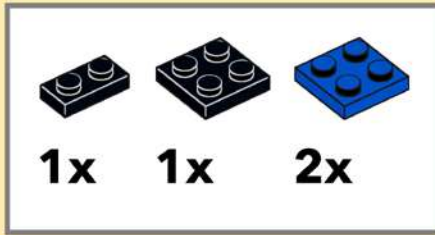

32

Accuracy

These four steps are creating a small section that is not visible in the box depiction. You can use other parts to your liking, as long as you end up with the same height and with the blue hinge plates in step 35.

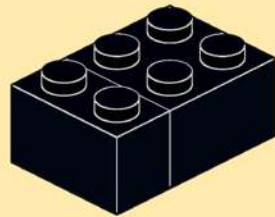
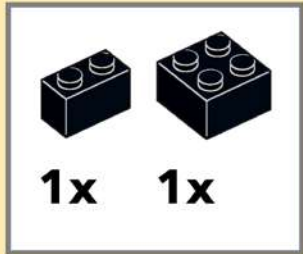

33

Construction tip

With this section entirely up to the builders imagination, these engine parts do however have a function, as they prevent the wings to be placed in step 58 from falling down.

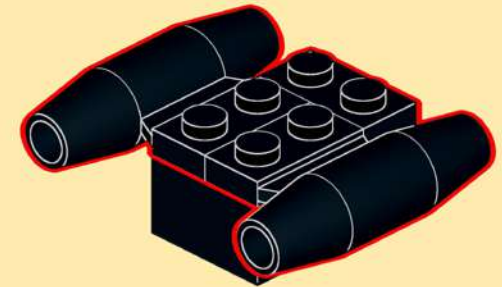
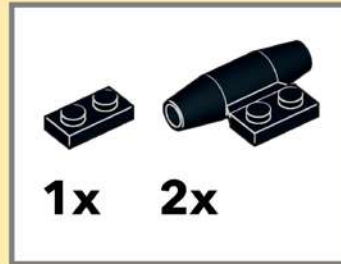

34

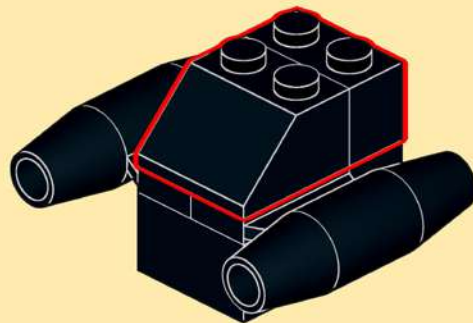
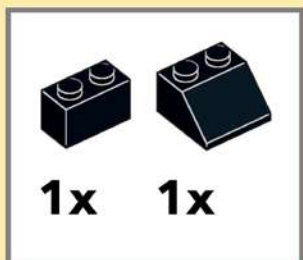

35

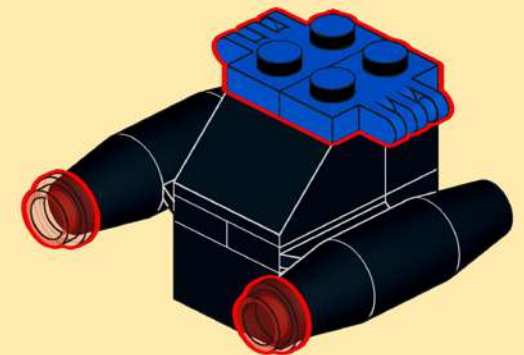

36

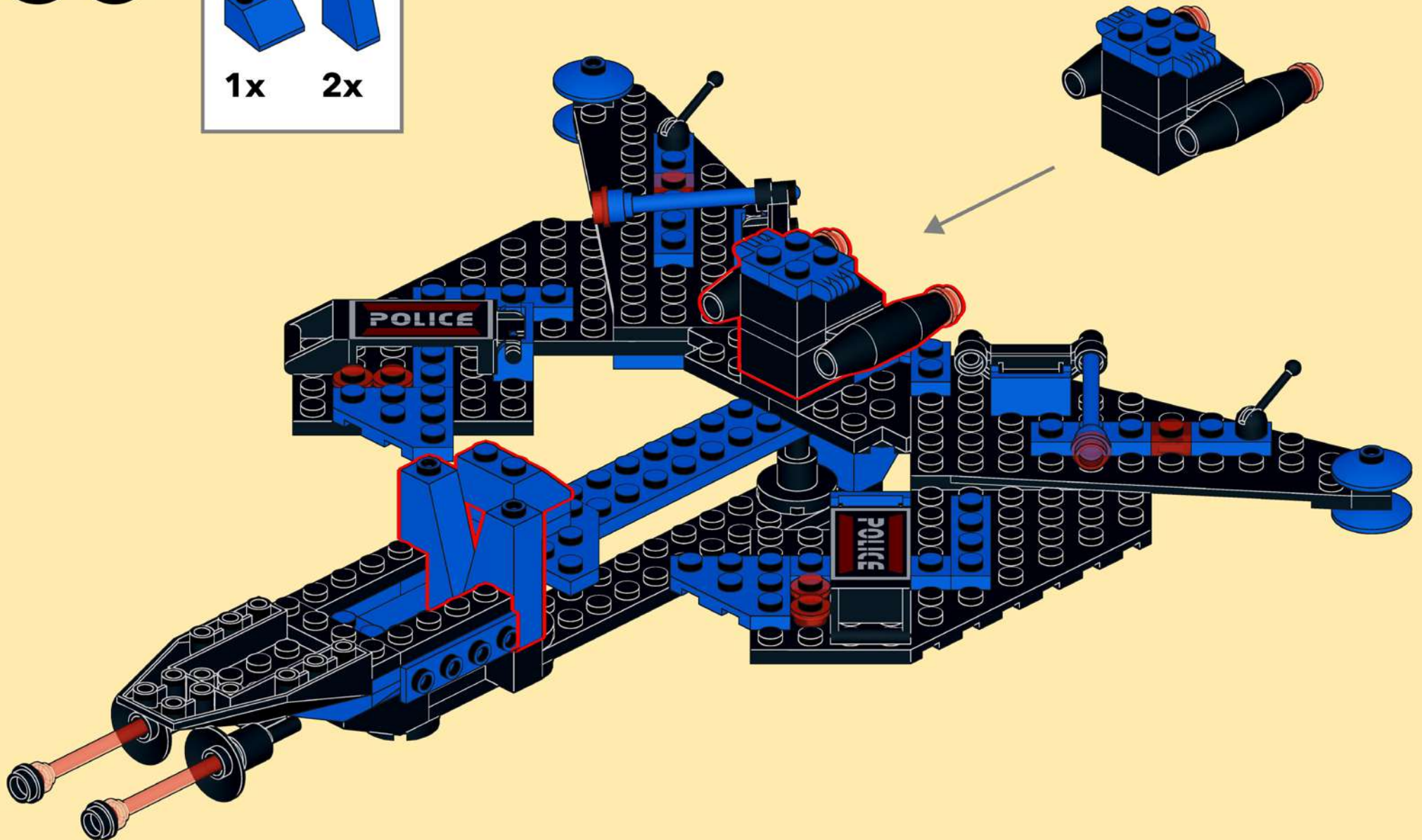
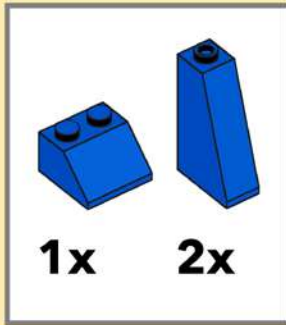

37

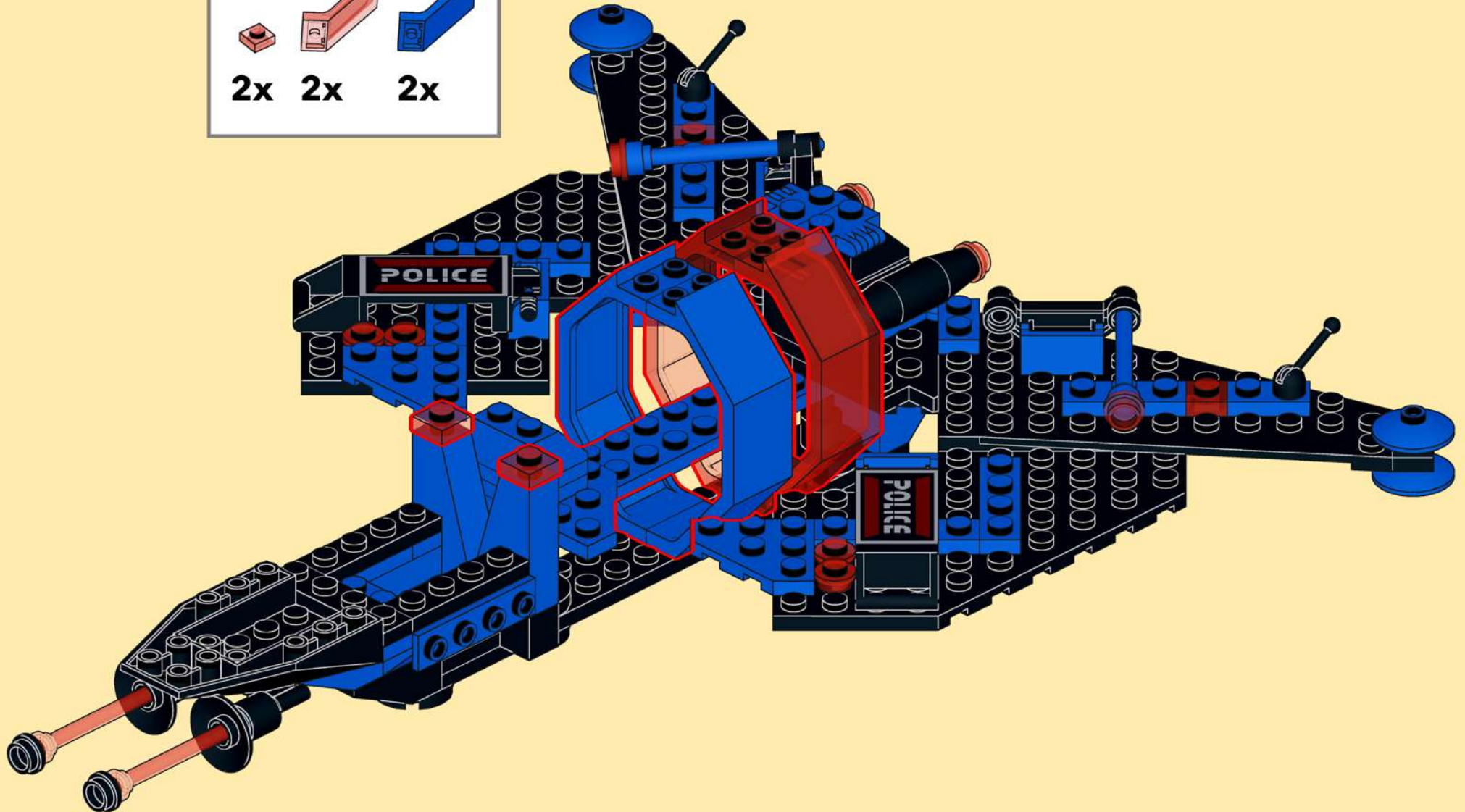
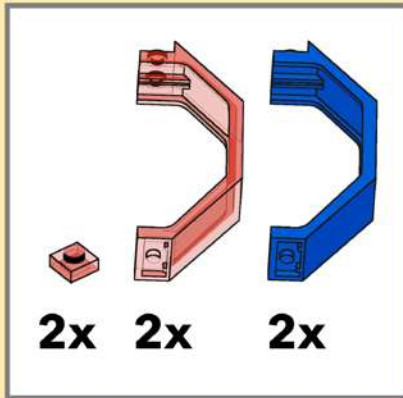

38

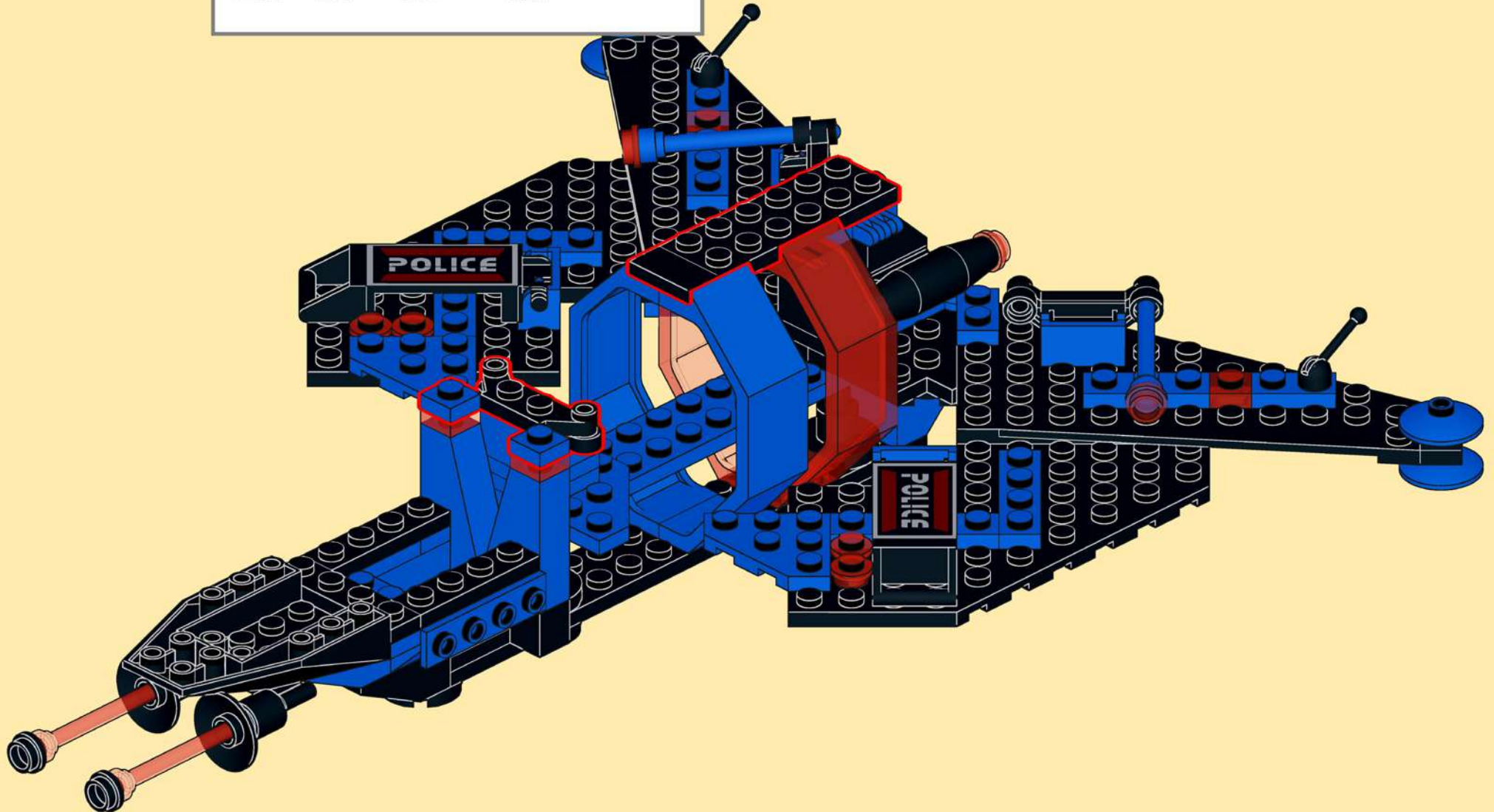
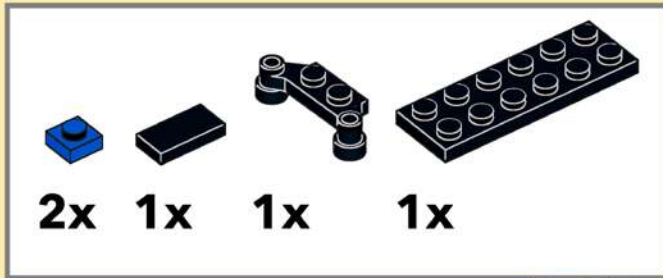

39

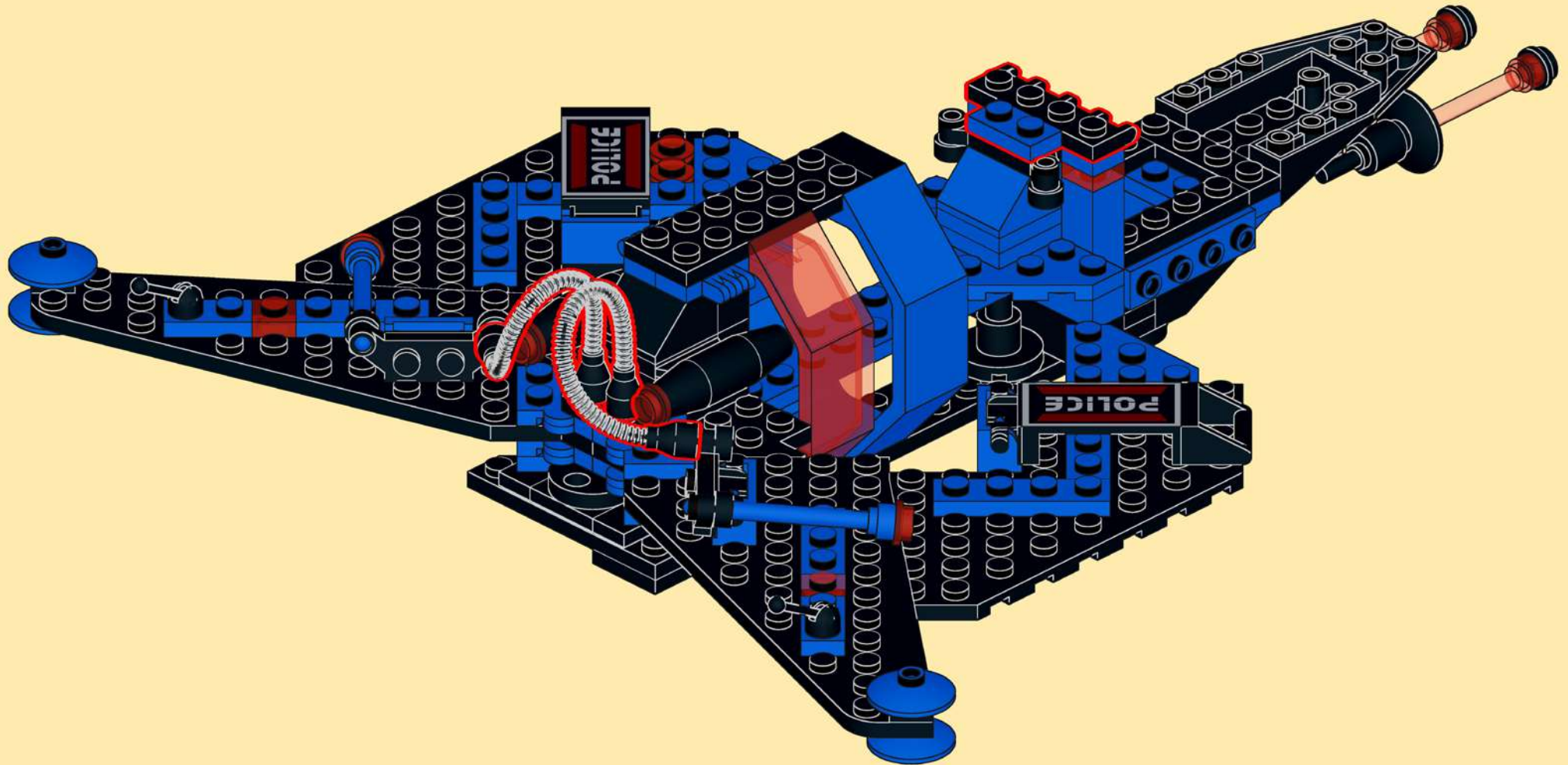
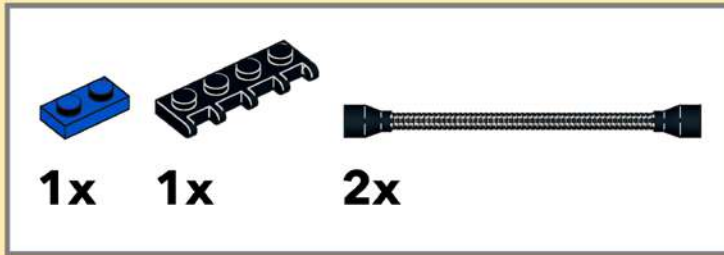

40

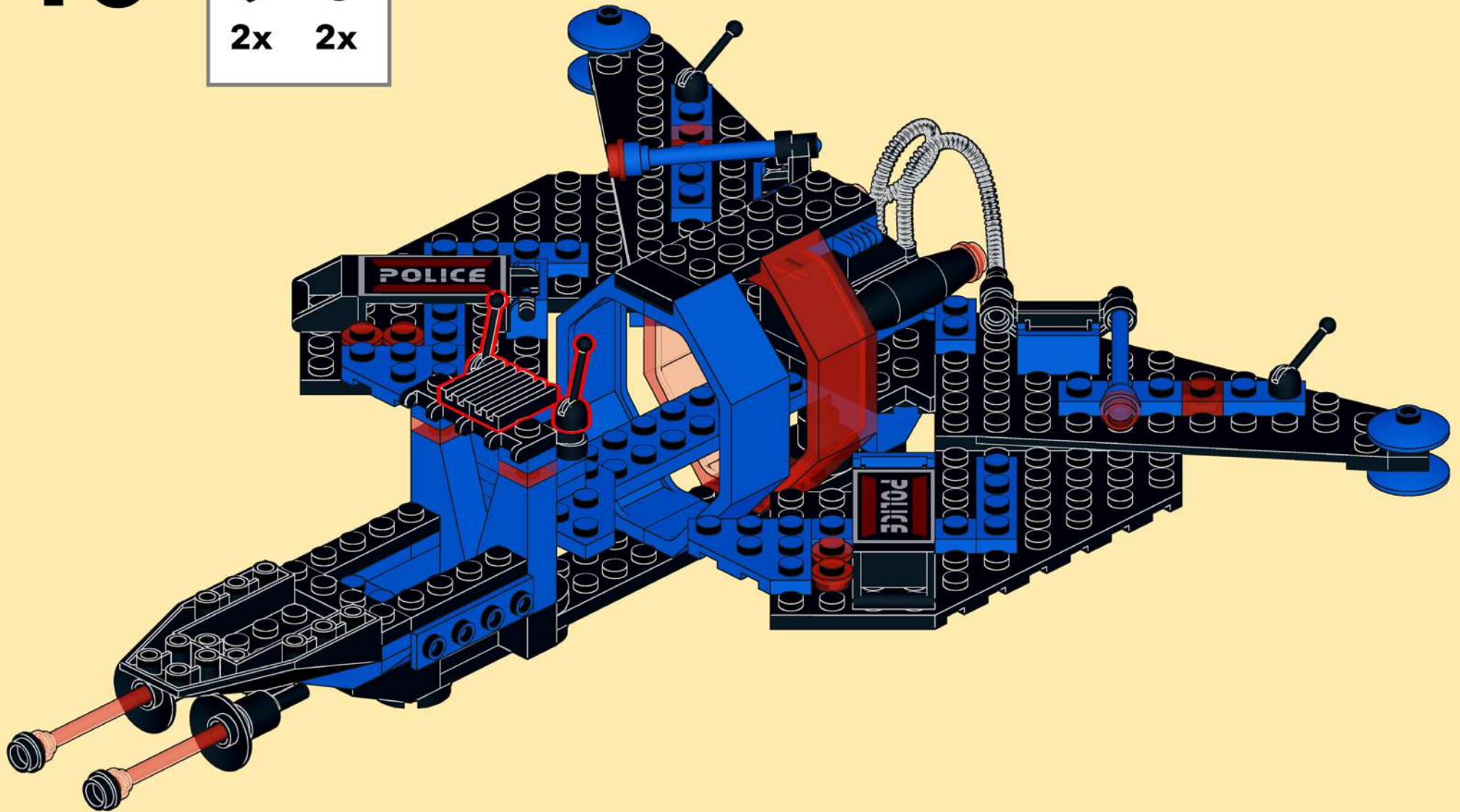

41

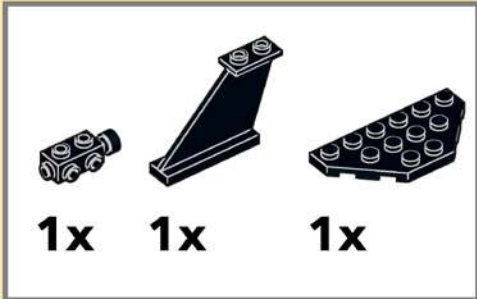

42

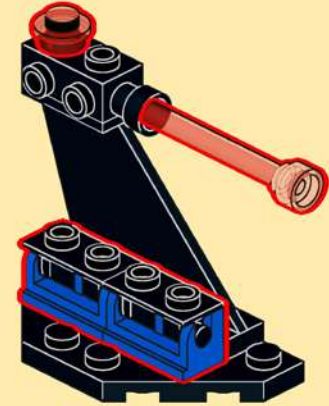
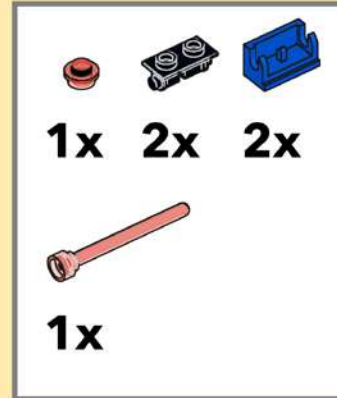

43

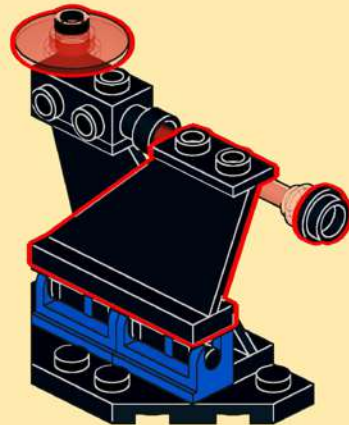
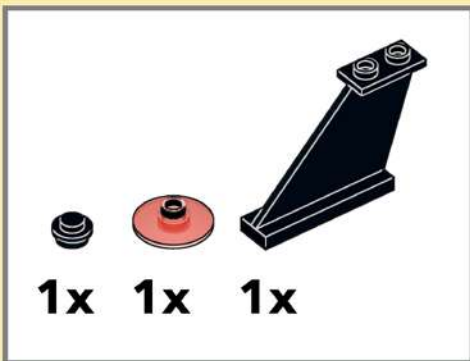

44

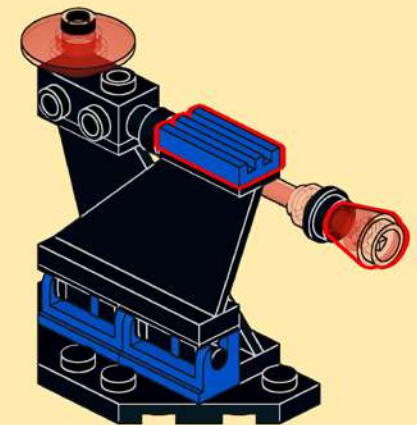
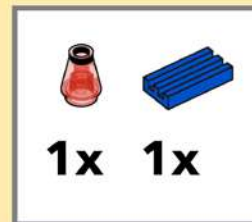

45

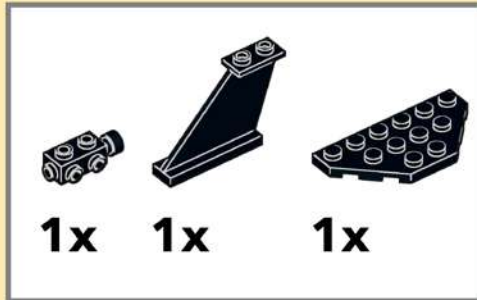

46

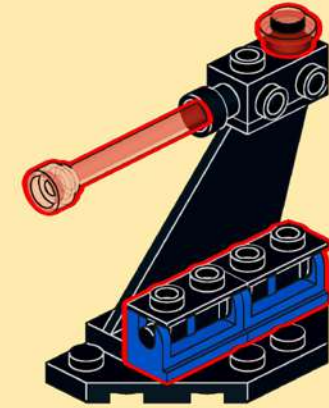
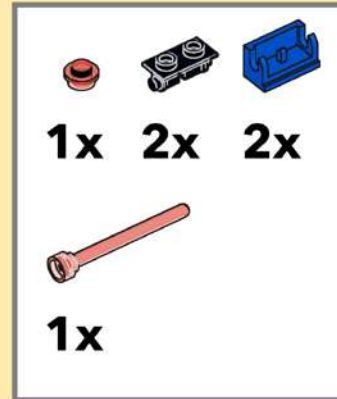

47

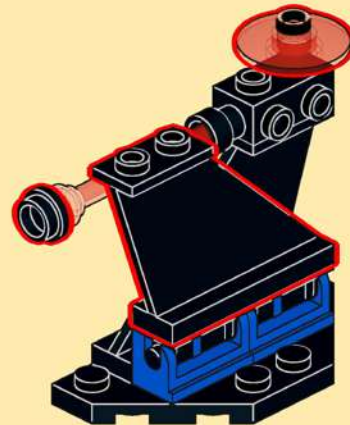
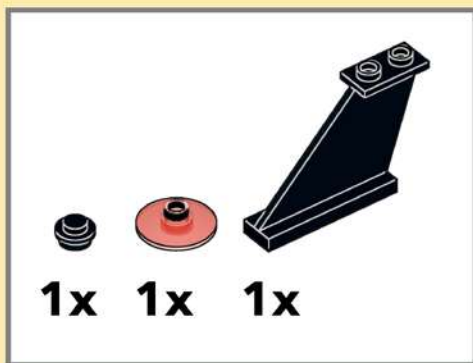

48

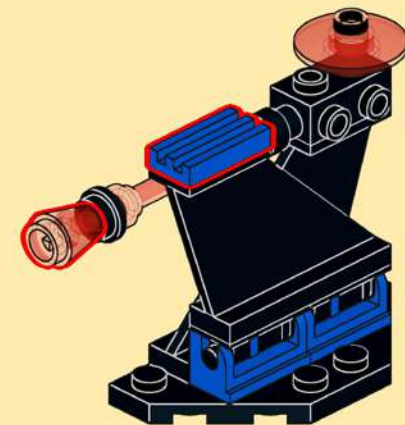
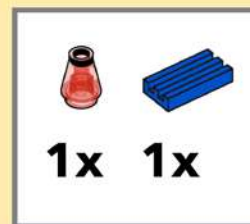

49

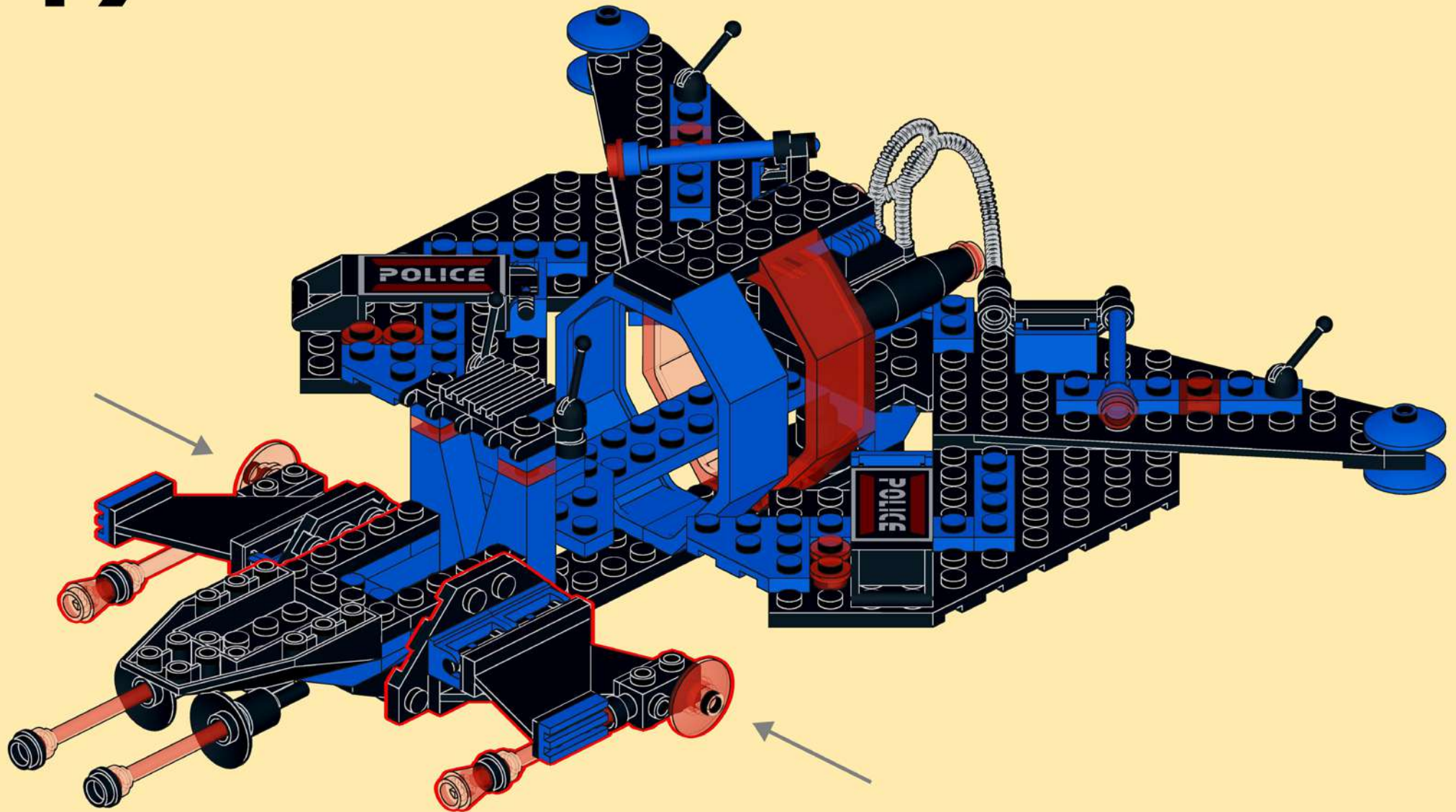

50

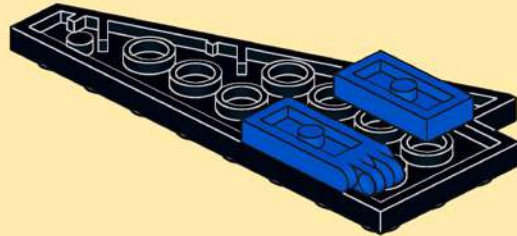
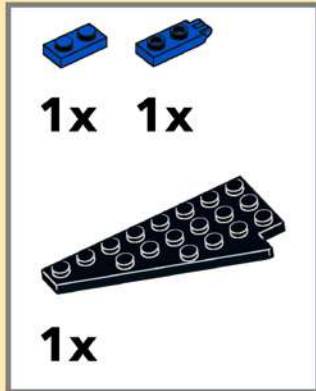

51

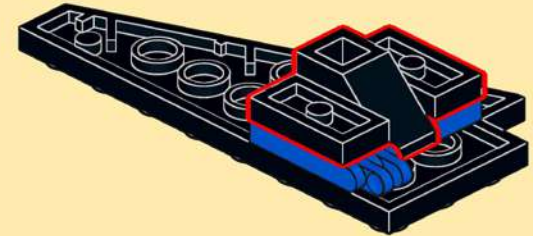
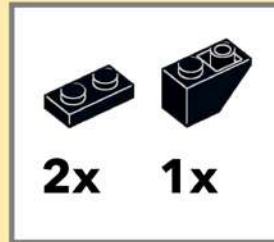

52

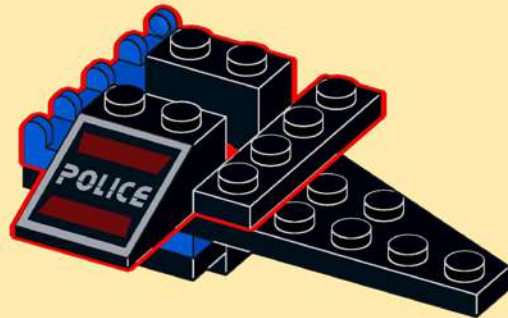
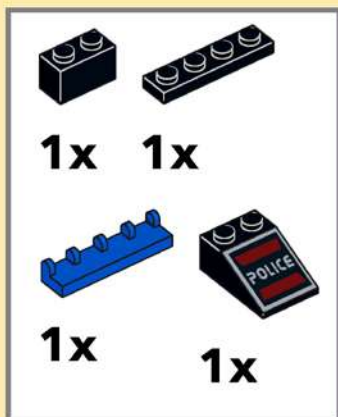

53

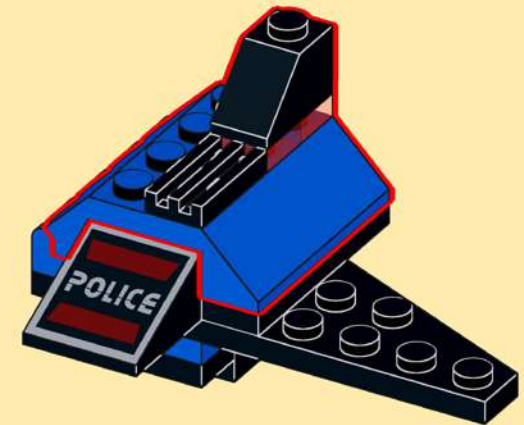
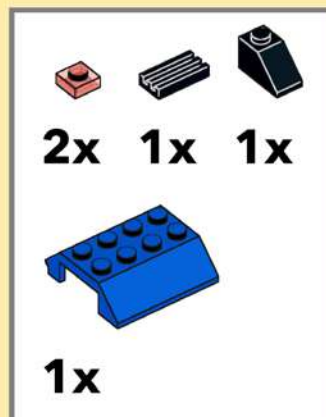

54

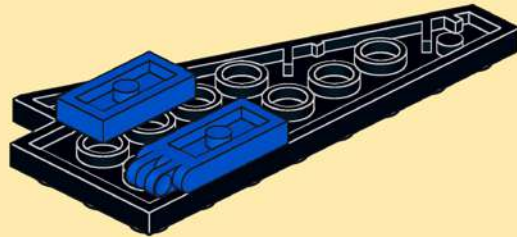

55

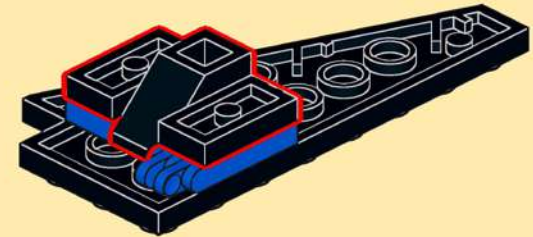
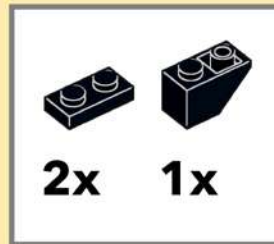

56

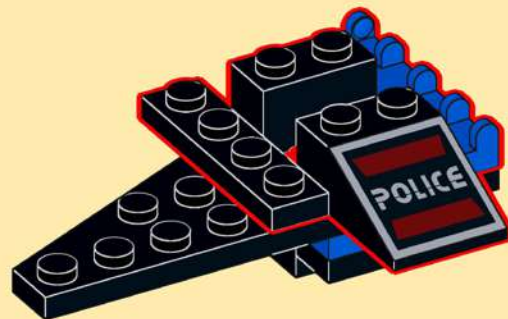
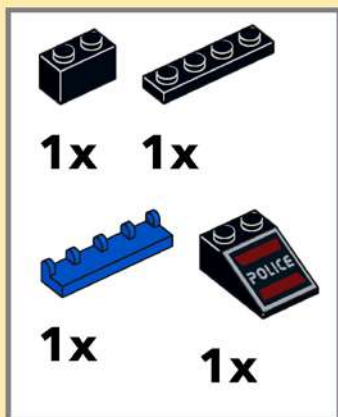

57

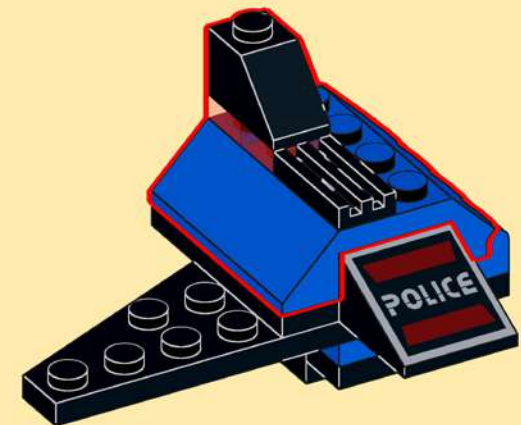
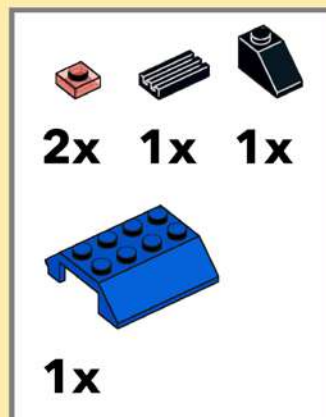

58

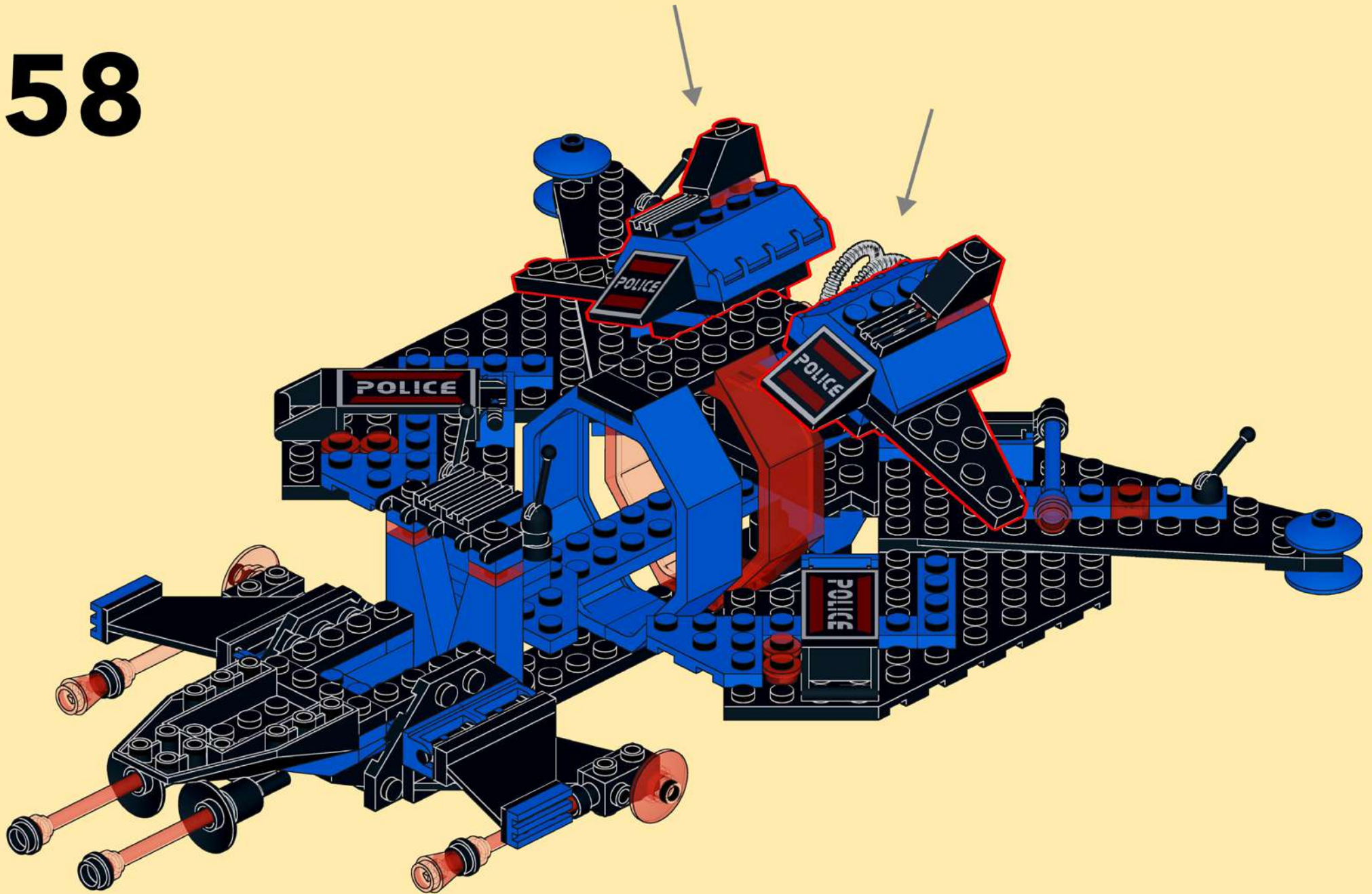

59

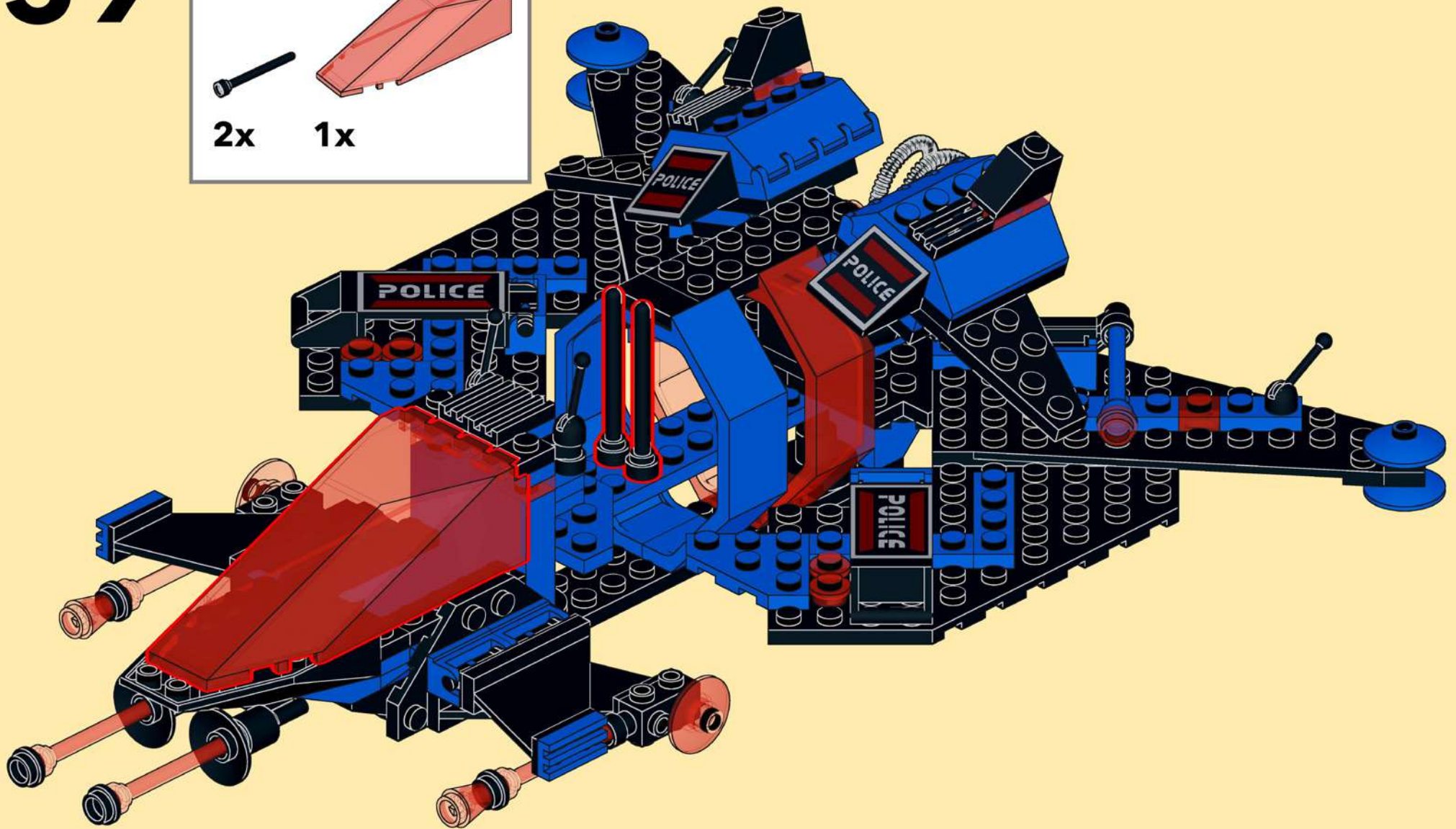
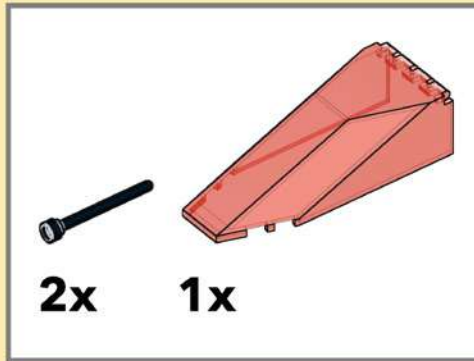

60

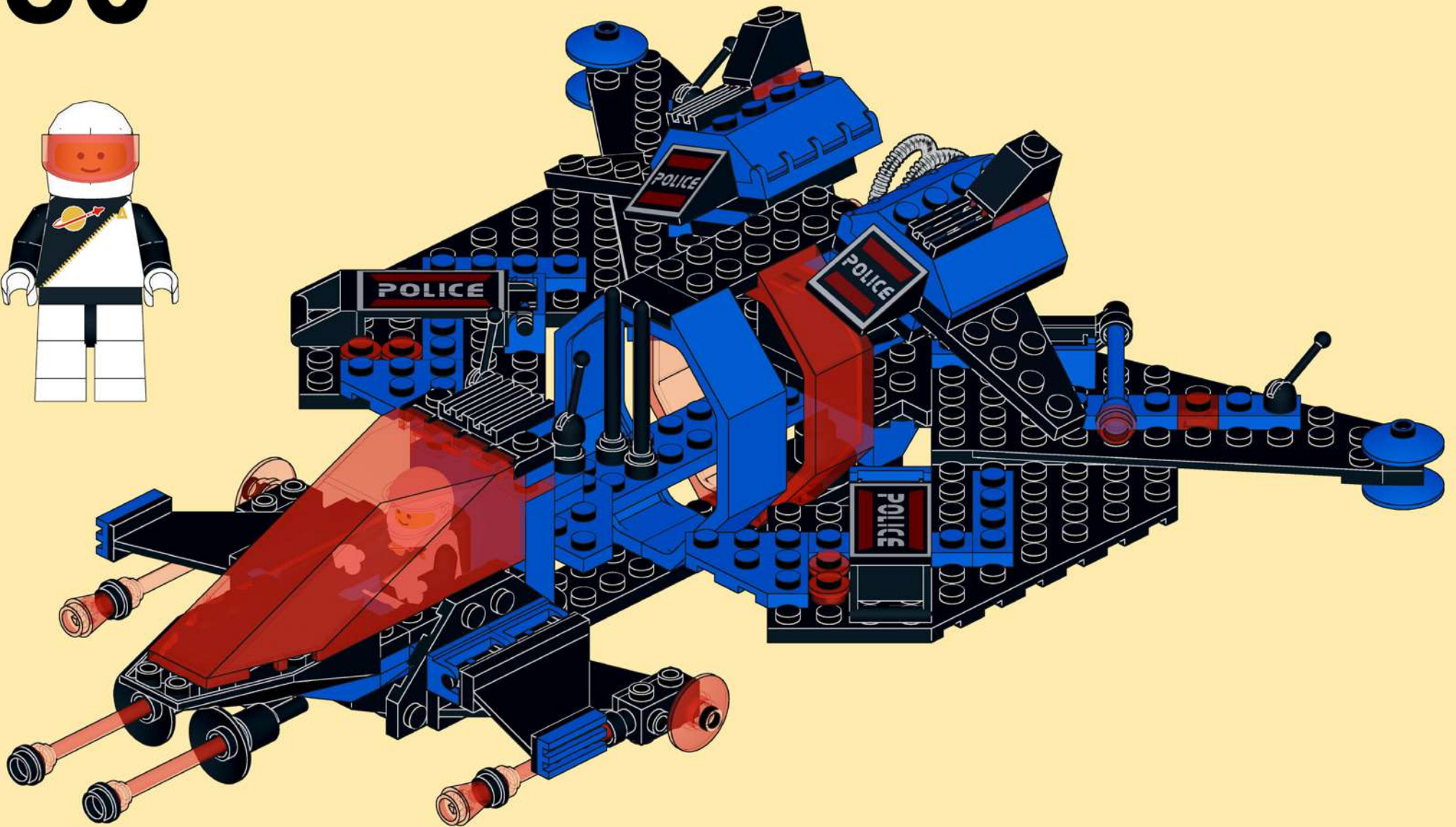

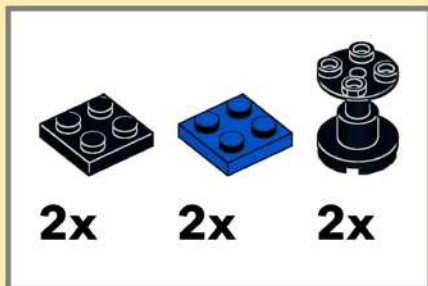

Optional building step

Whilst the wings are connected firmly, bending might still be possible over time. Feel free to add these supports to give the wings more stability when displayed.

