

6901 - Back C

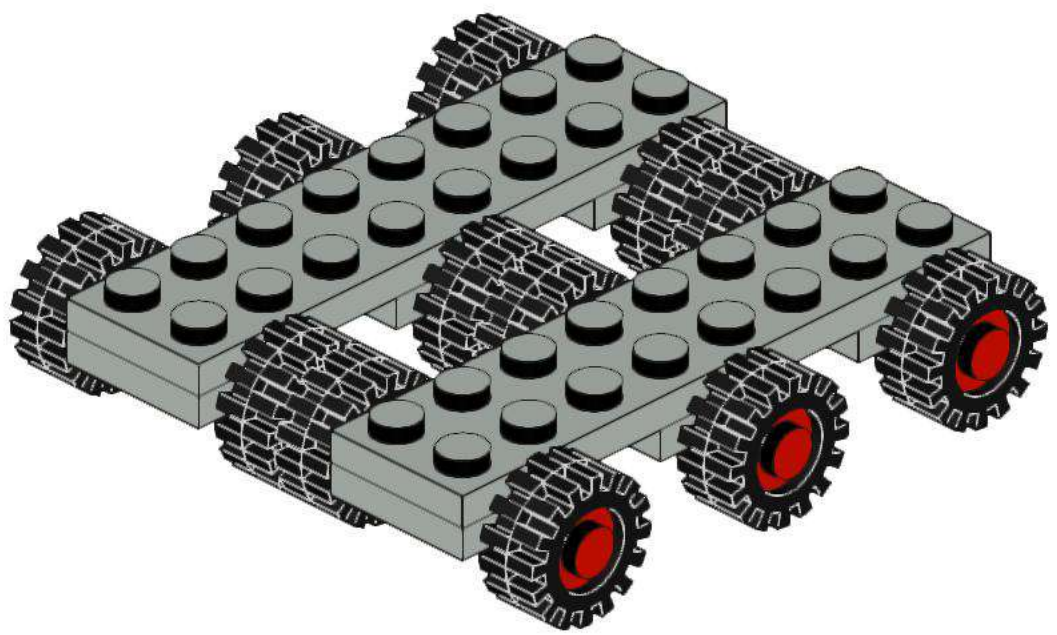

1

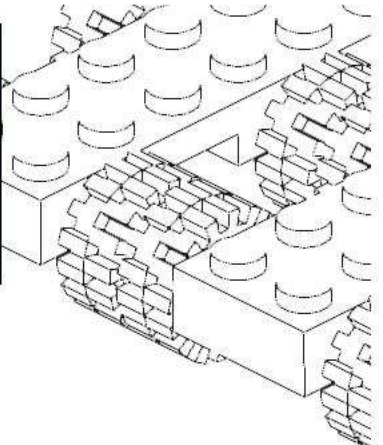
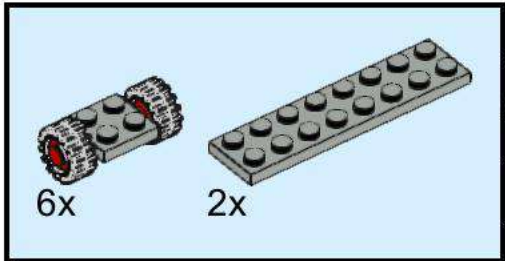

2

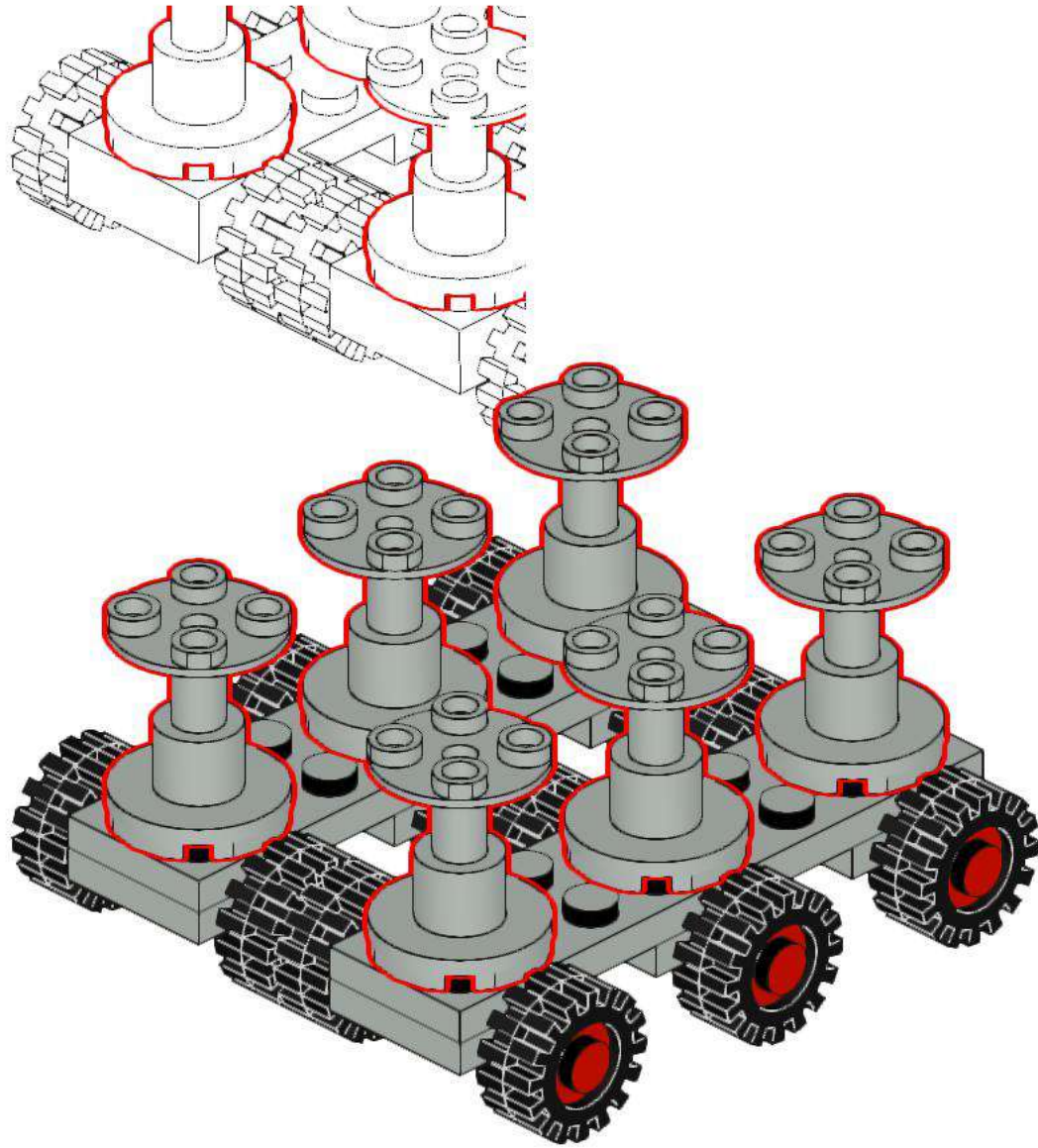
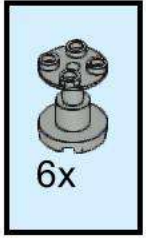

3

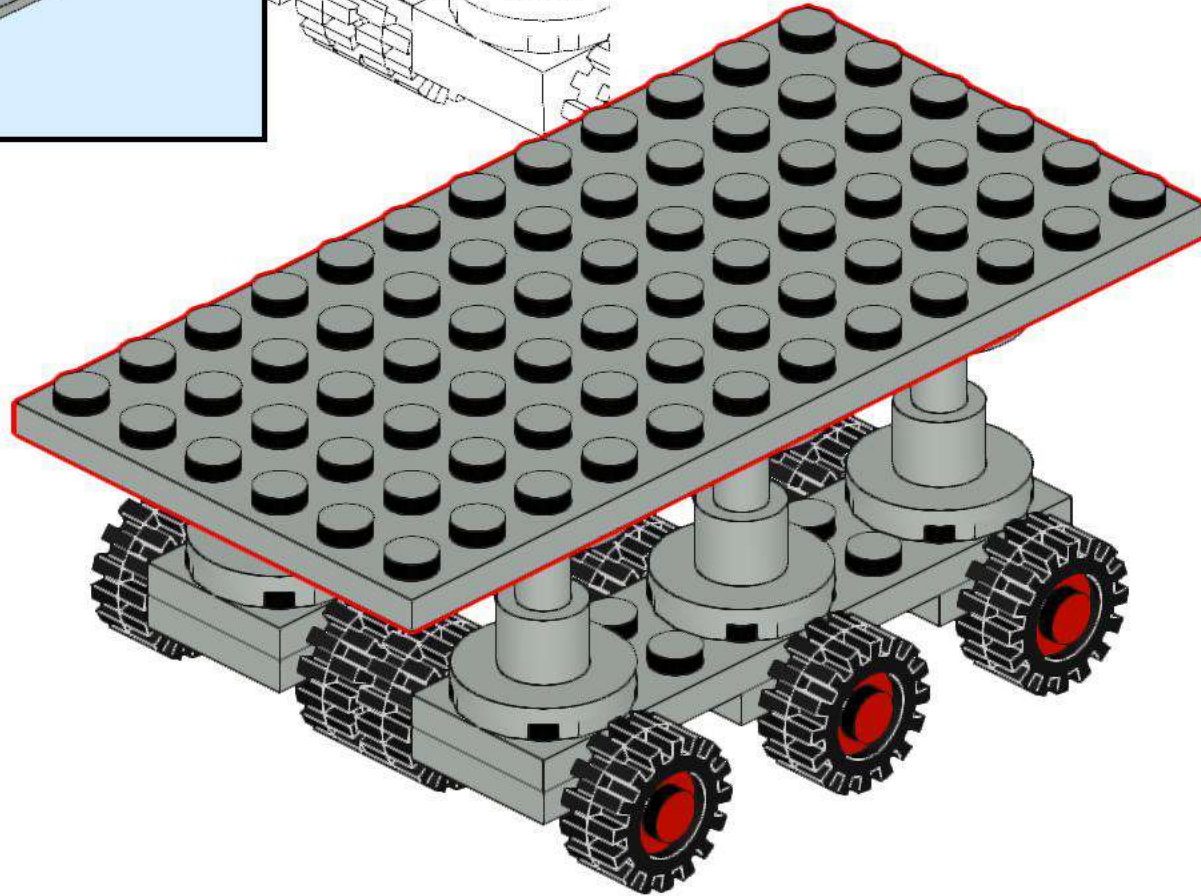
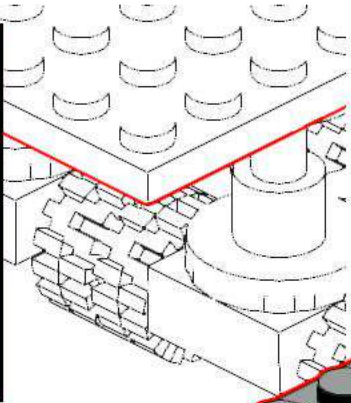
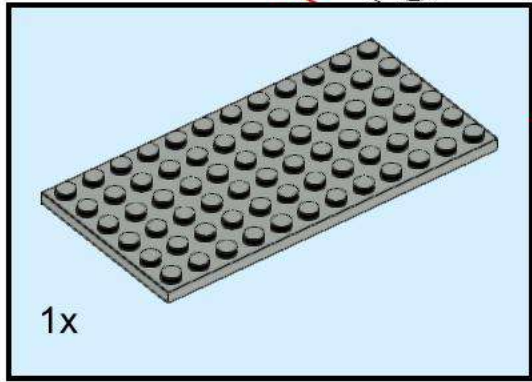

4

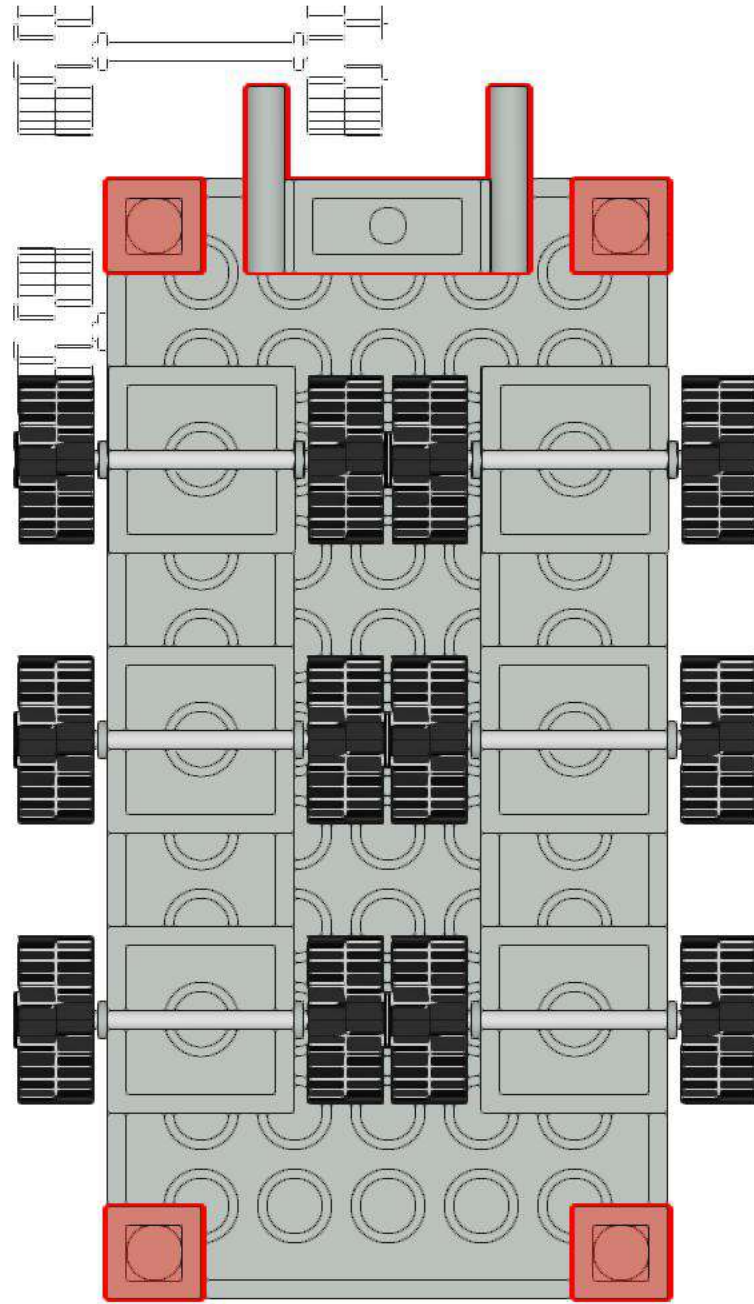
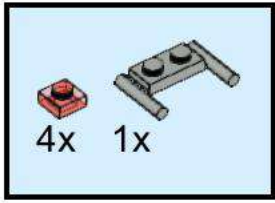

5

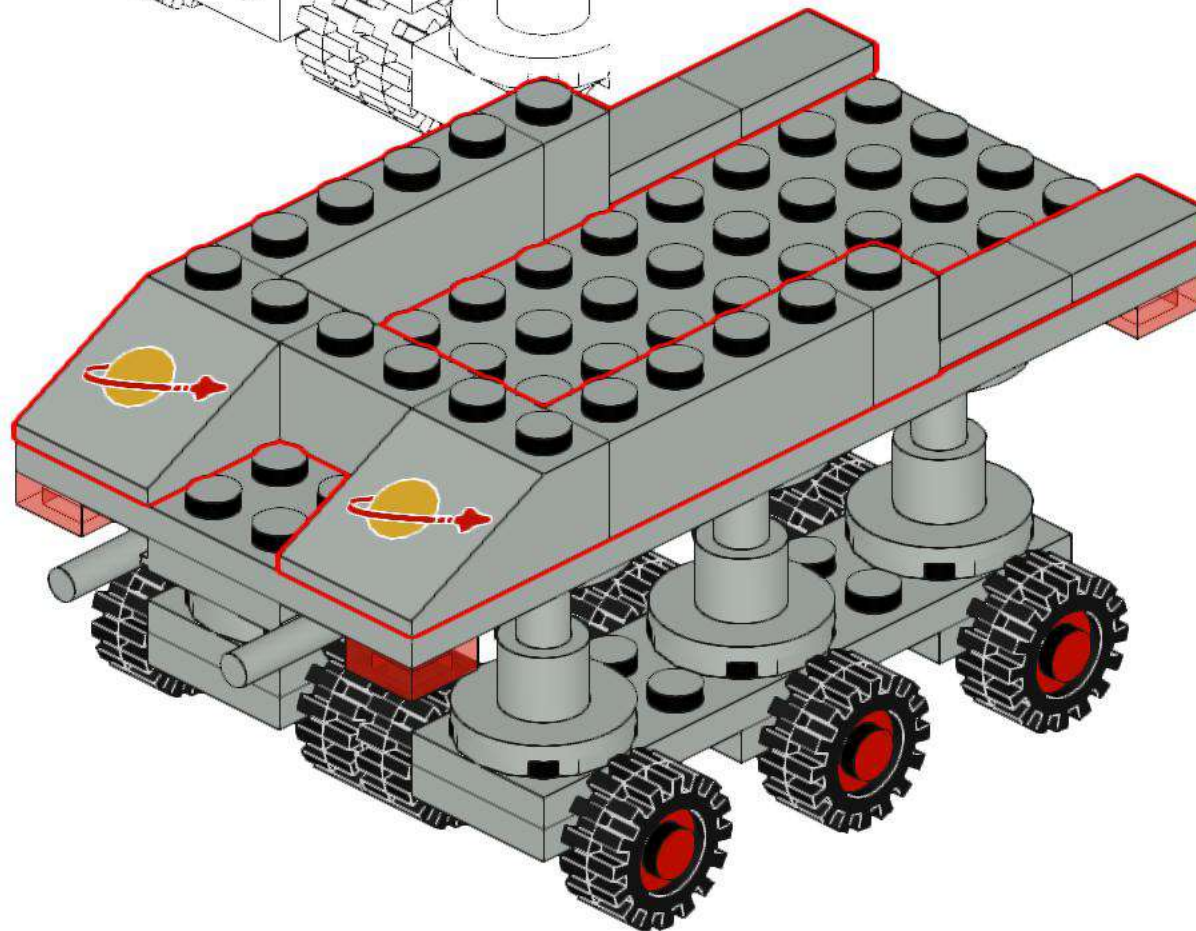
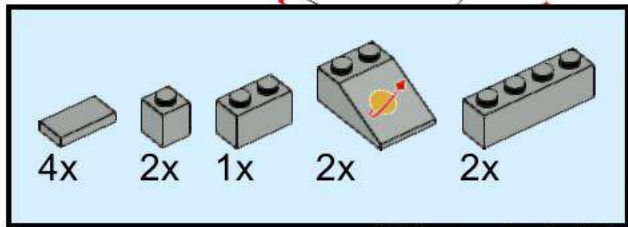

6

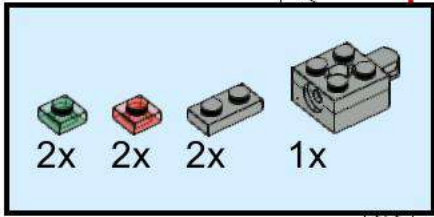



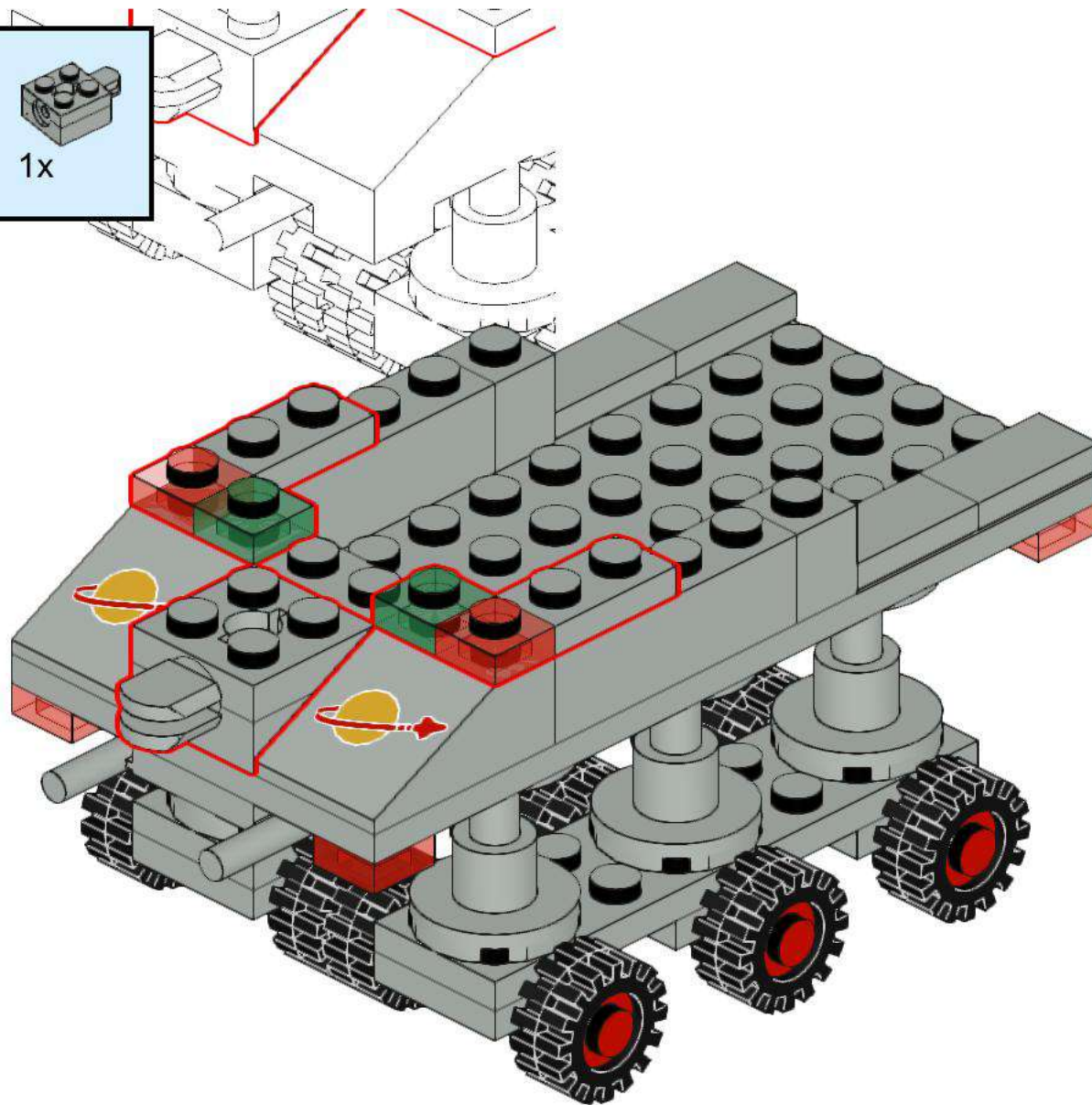

2x 2x 2x 1x

This inset box lists the required parts for step 6: two green 1x1 pins, two red 1x1 pins, two grey 1x2 Technic bricks with holes, and one grey 1x2 Technic brick with four holes.



7

			
1x	1x	5x	1x

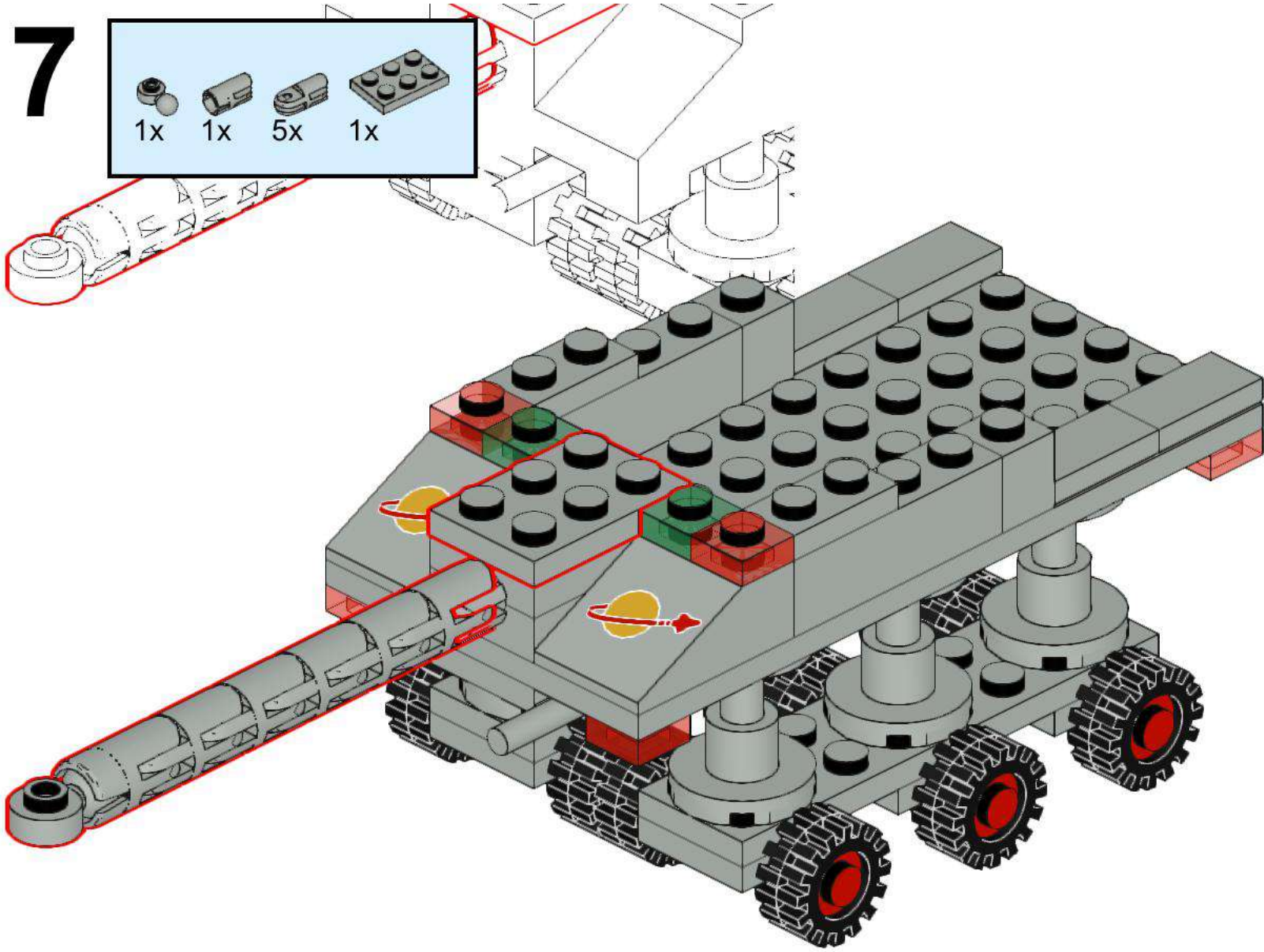

8

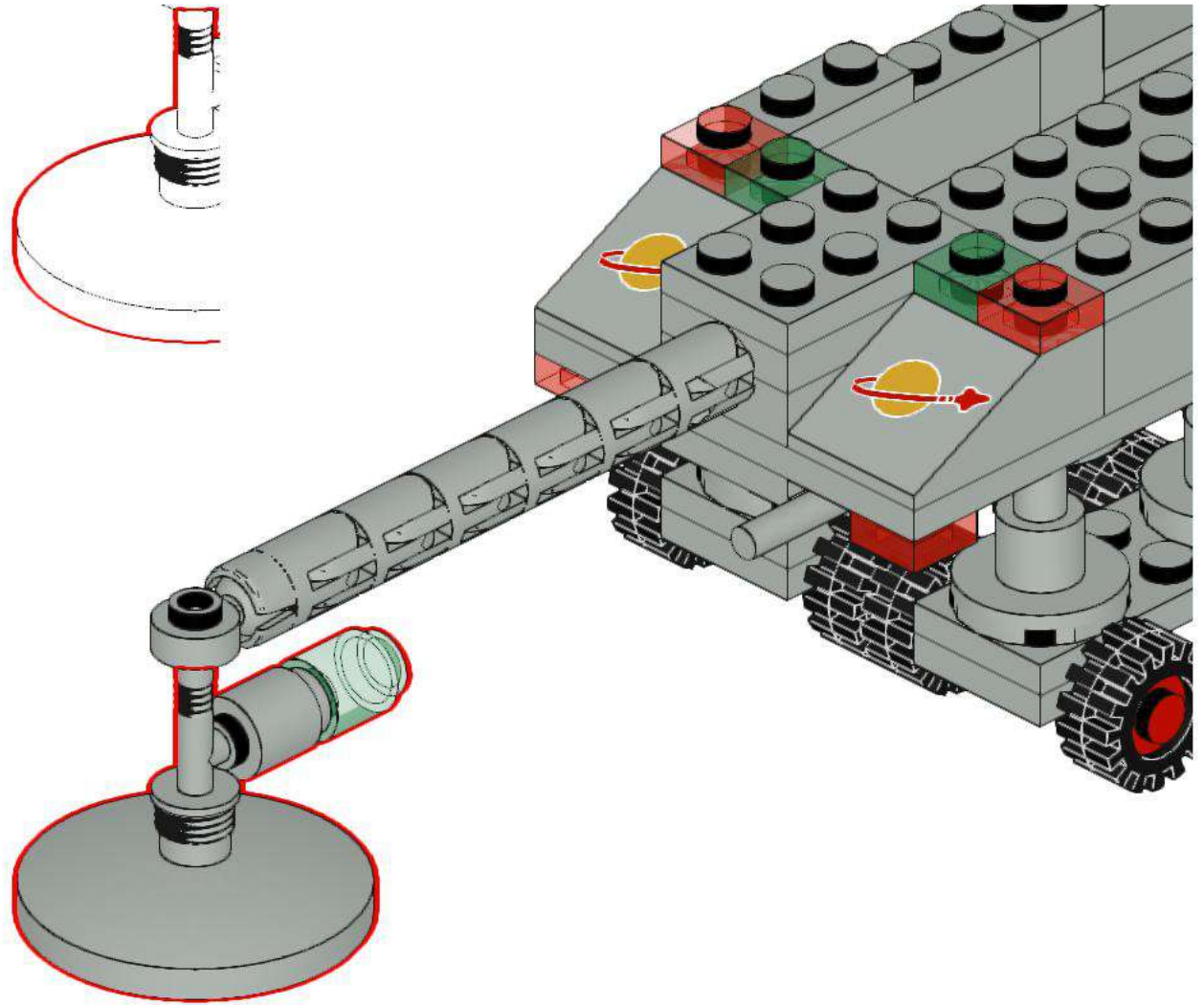
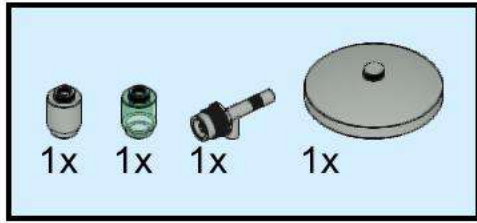

9

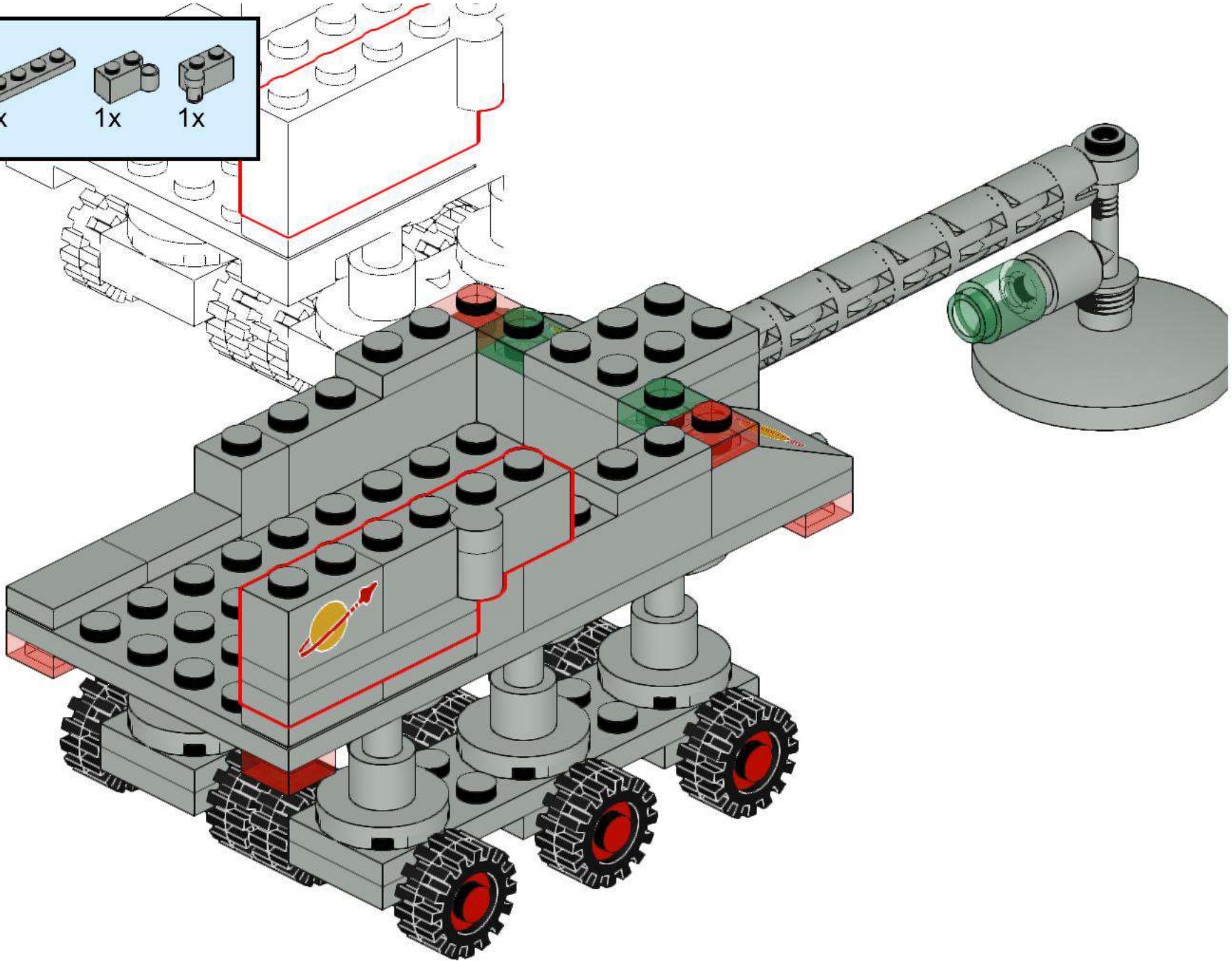
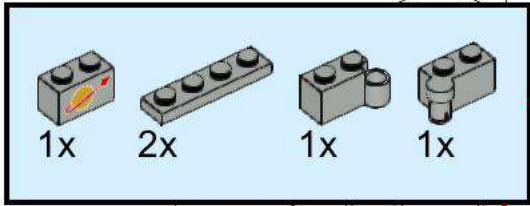

11

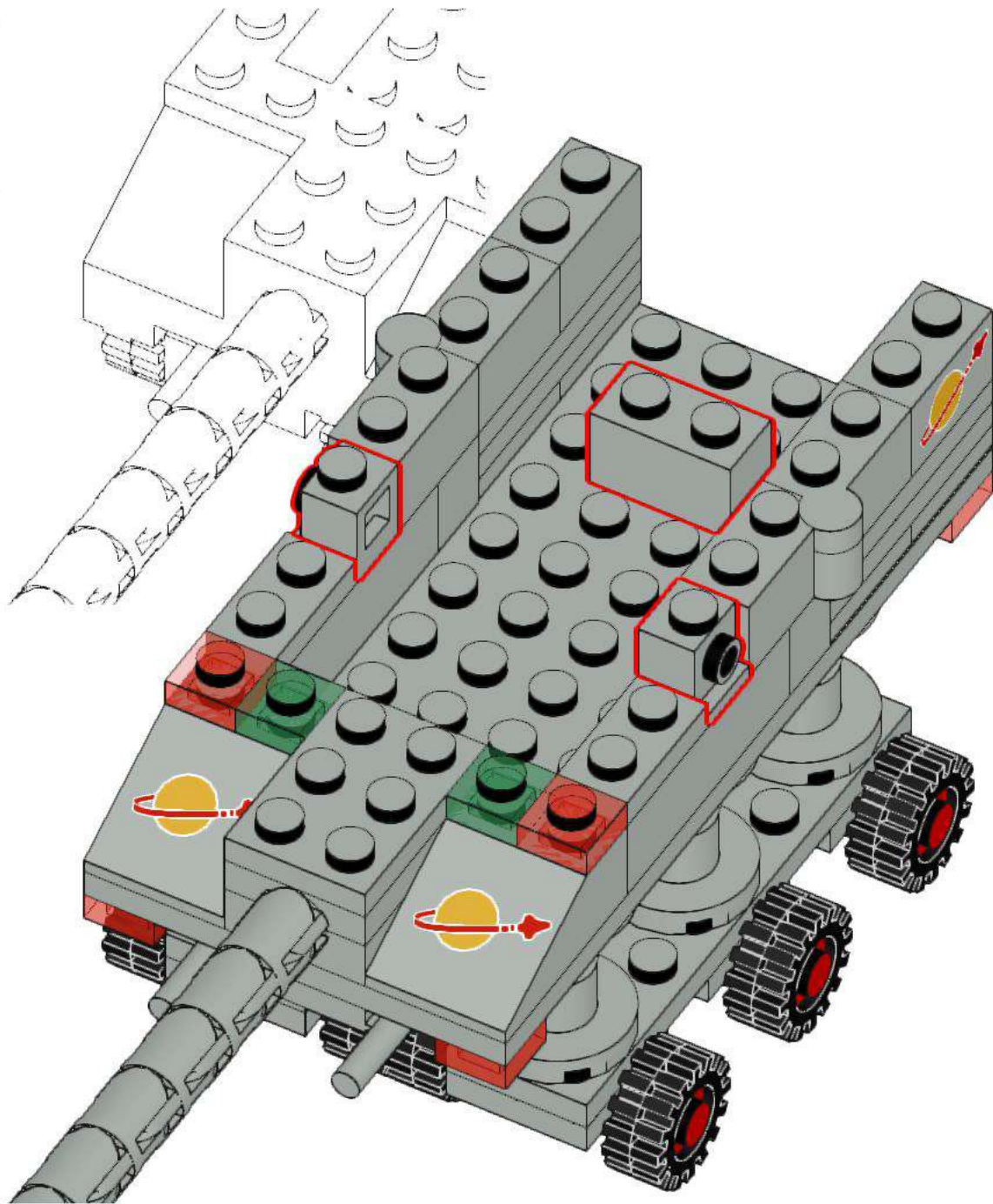
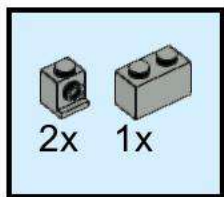

12

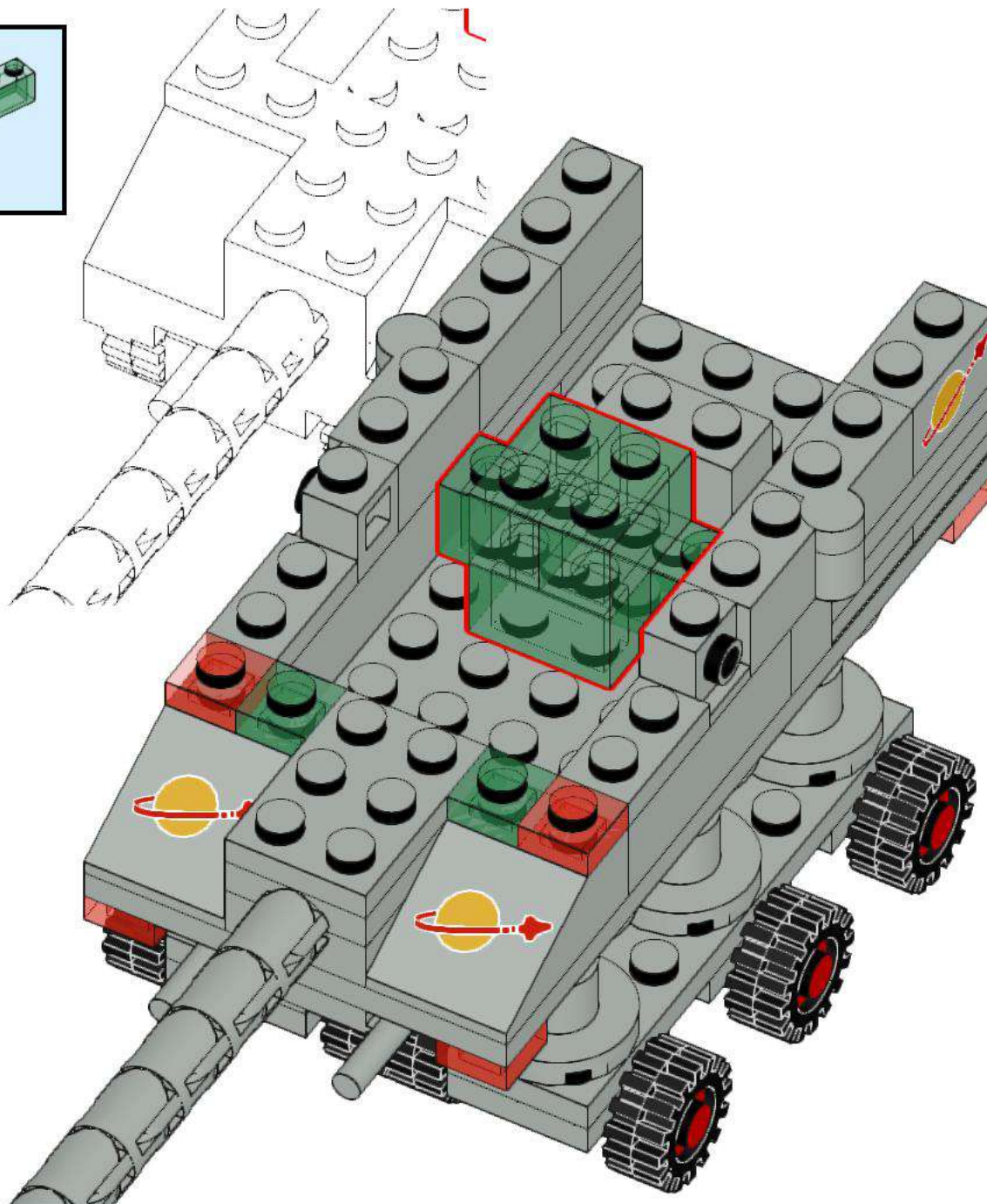
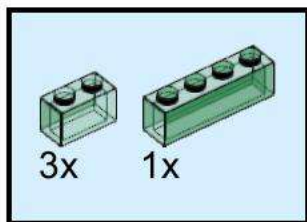

13

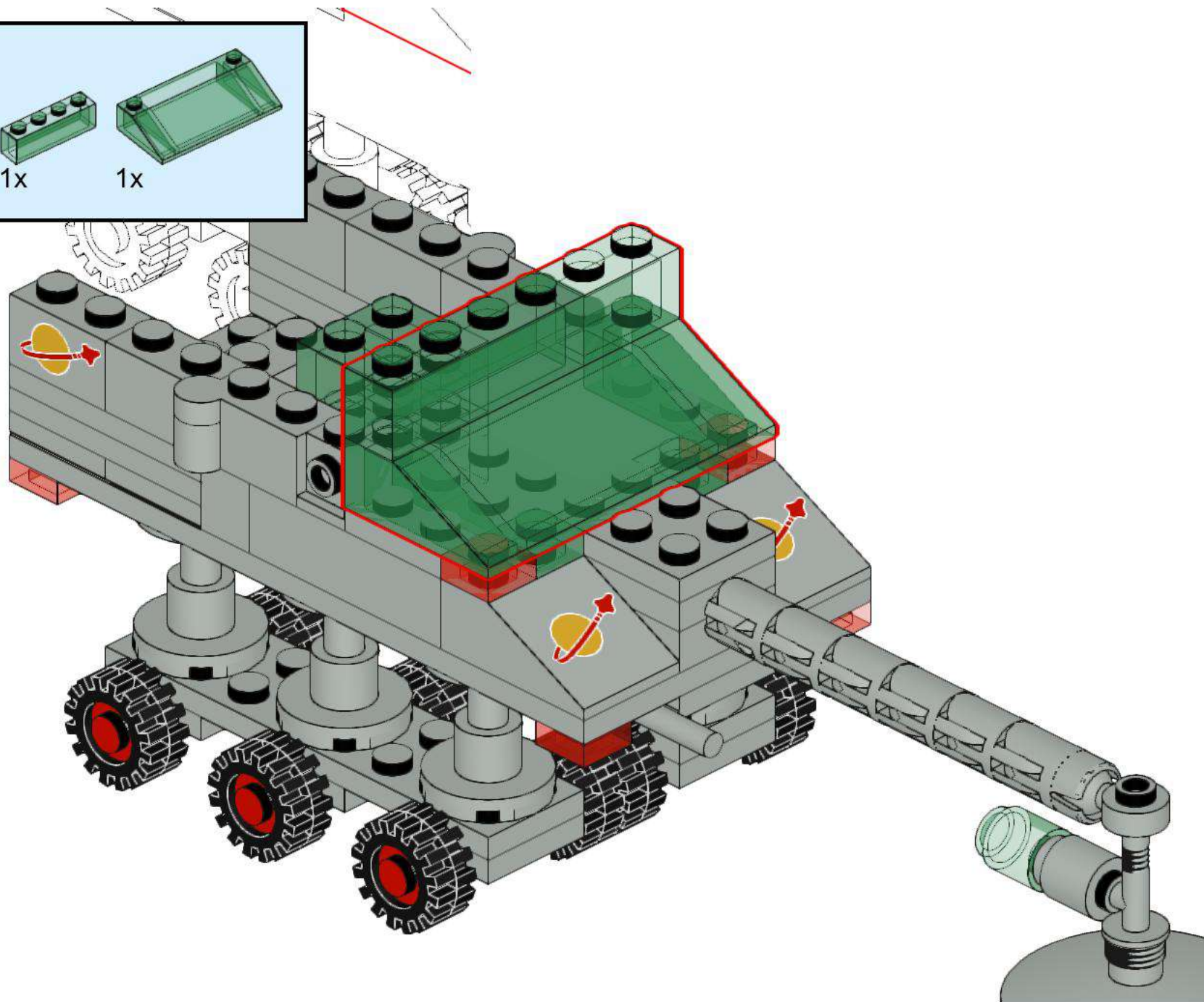
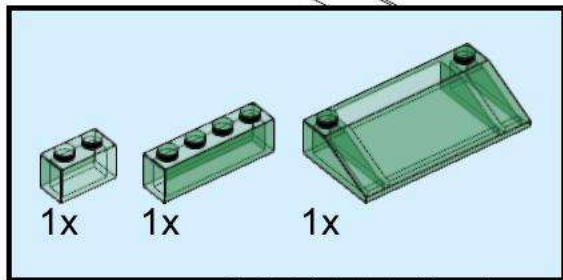

14

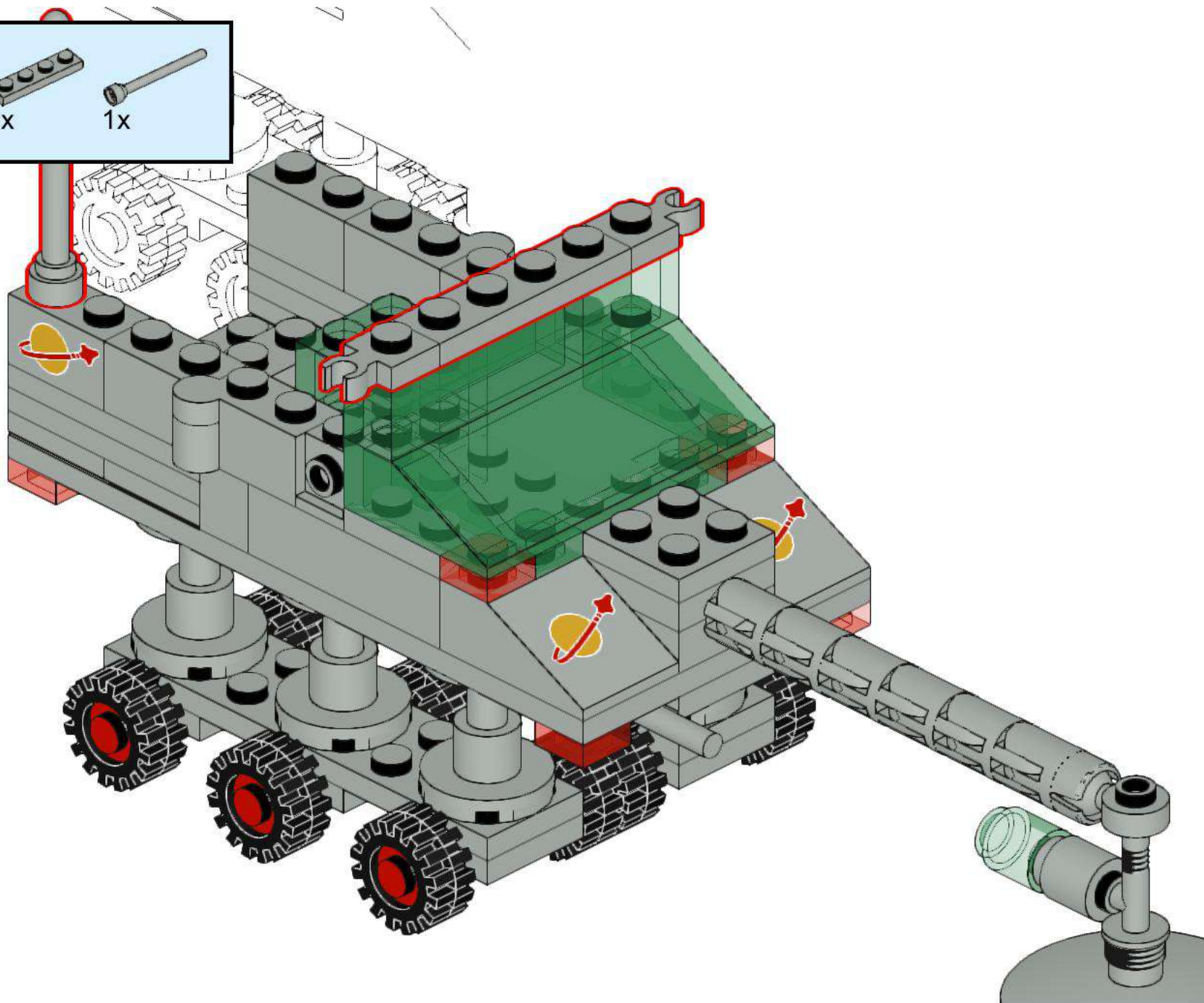
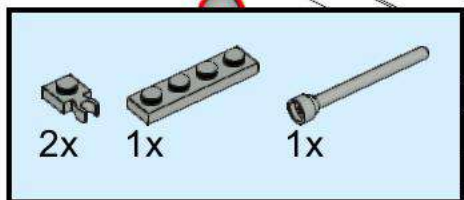

15



2x 2x 1x 1x

This inset box lists the required parts for step 15: two red pins, two grey pins, one black wrench, and one grey axle. The quantities are indicated by '2x' and '1x' below each corresponding part image.

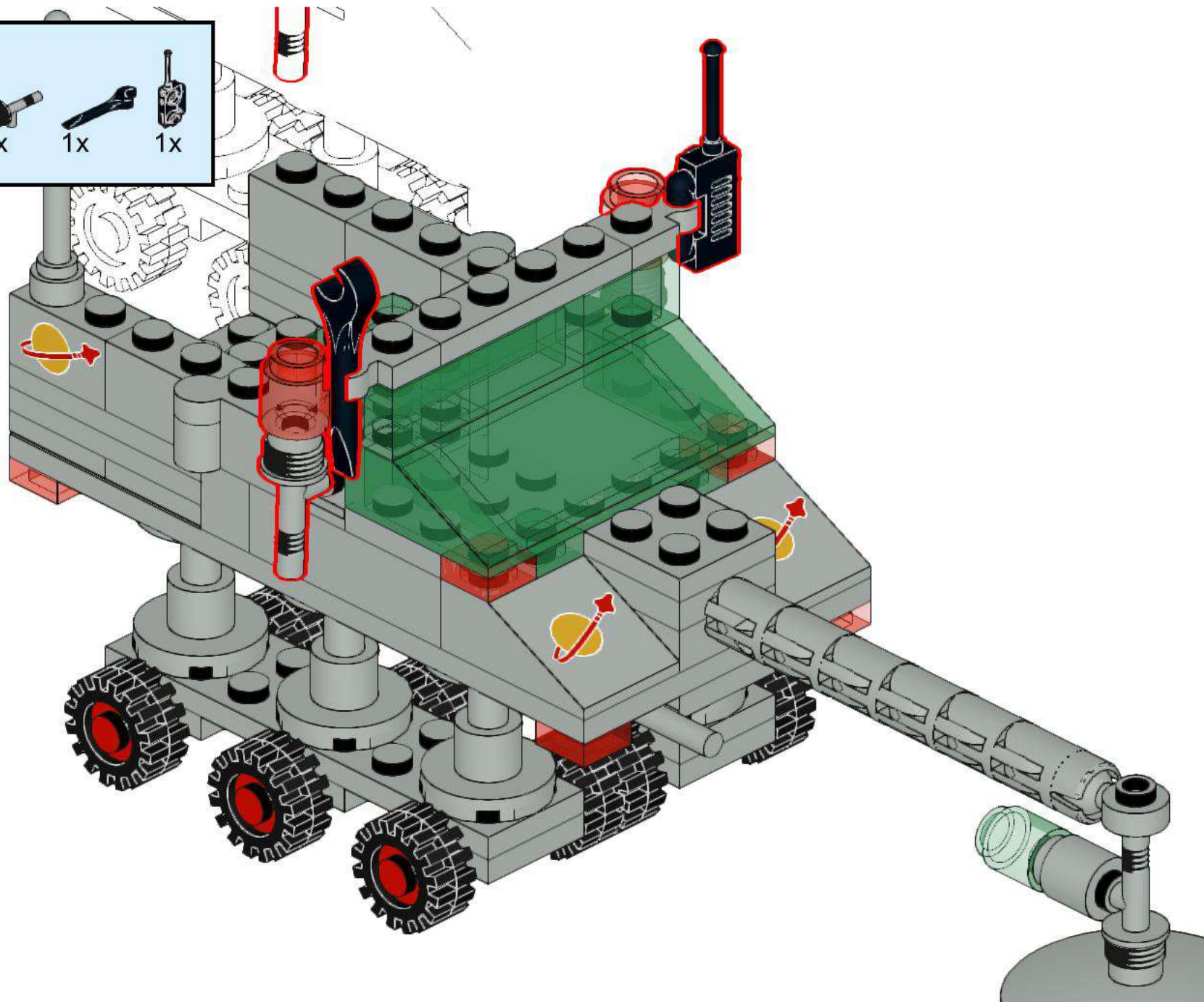

16

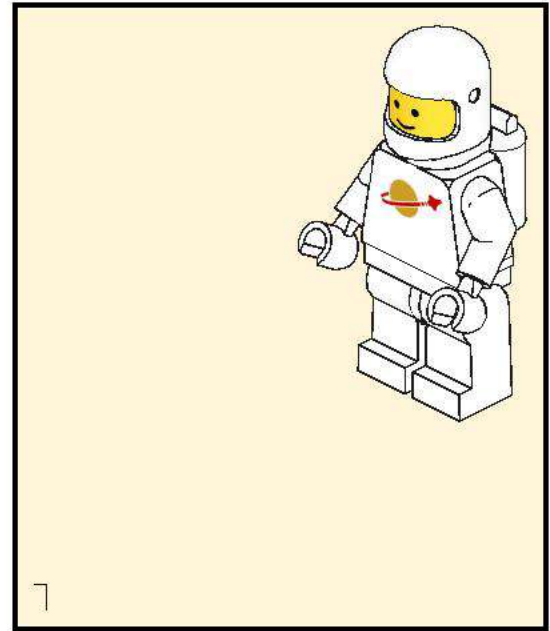
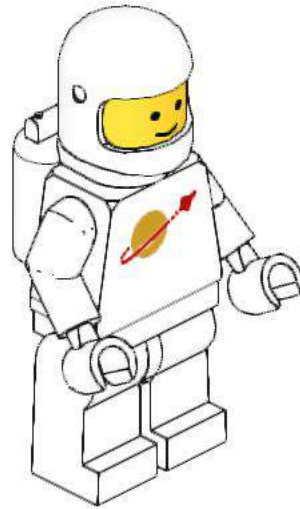
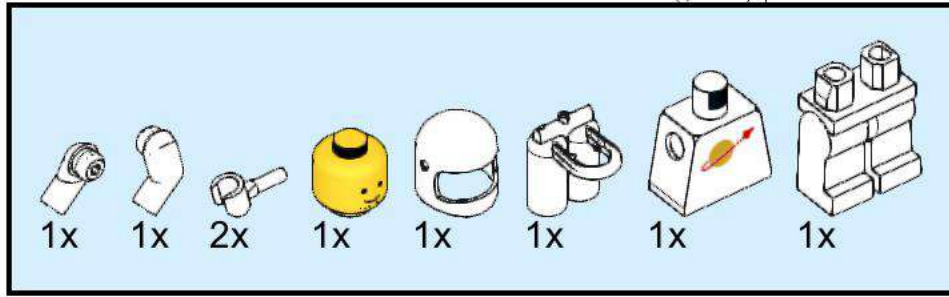

17

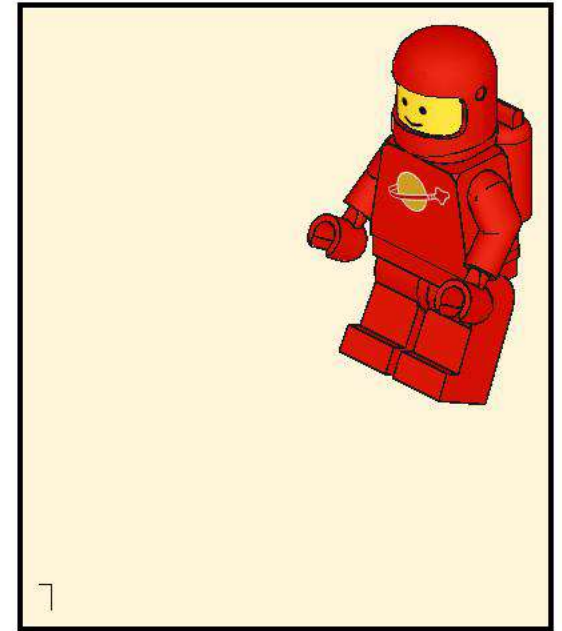
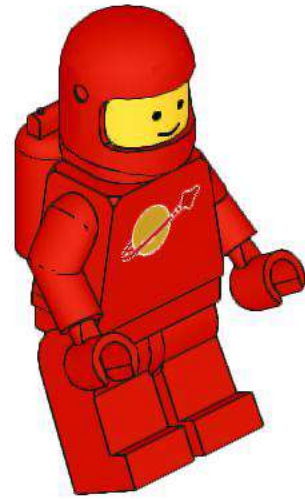
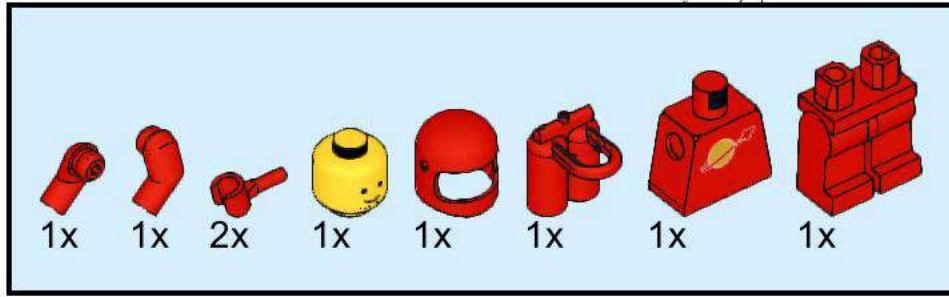

18

