

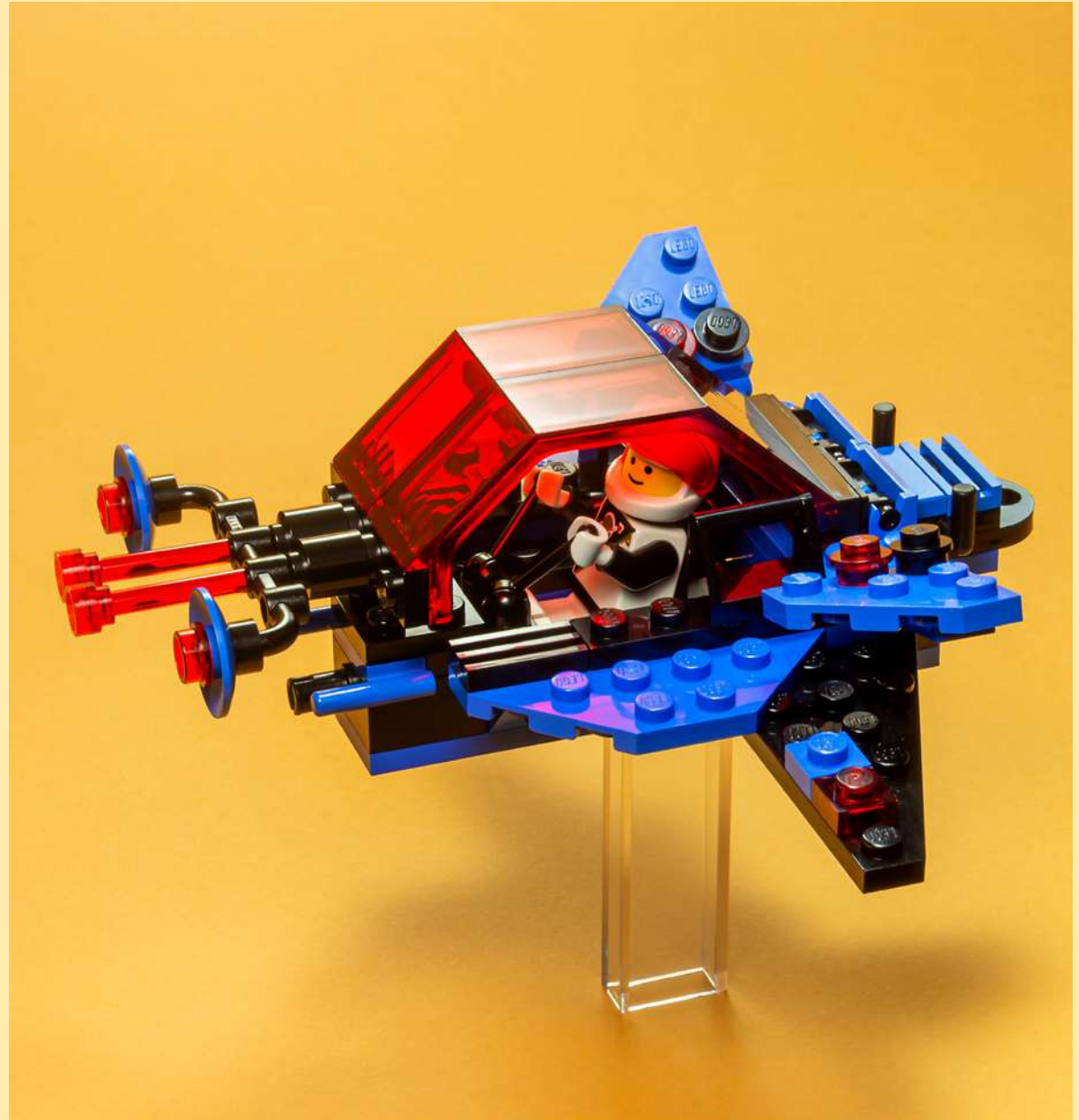

6986
MISSION COMMANDER
ALTERNATE MODEL (1989)

INSTRUCTIONS

CONCEPT BY BJARNE TVESKOV & LEGO
PHOTOGRAPHY & INSTRUCTIONS
BY COSMIC.BRICK



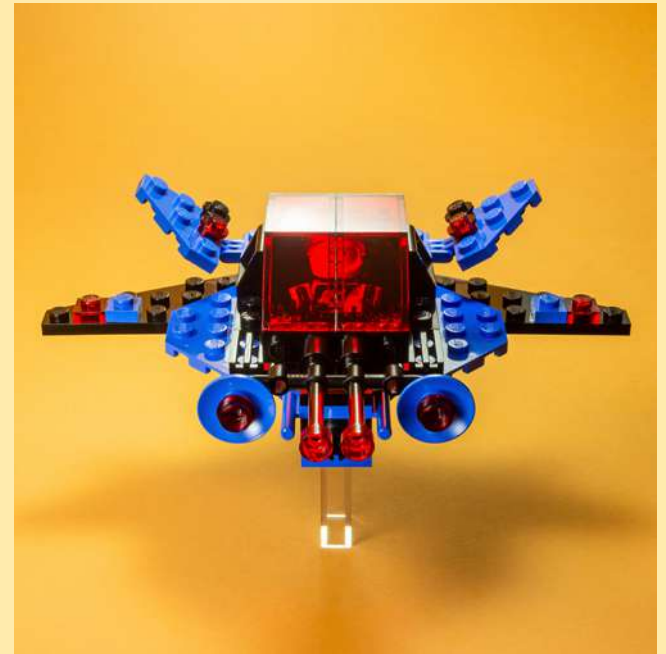

1

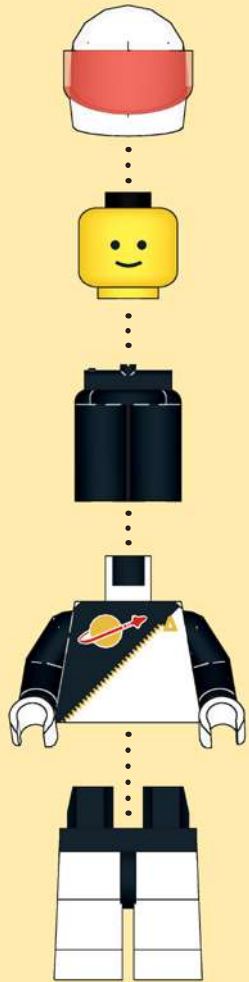

2

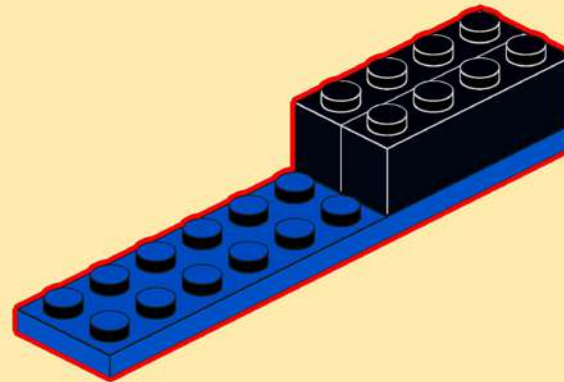
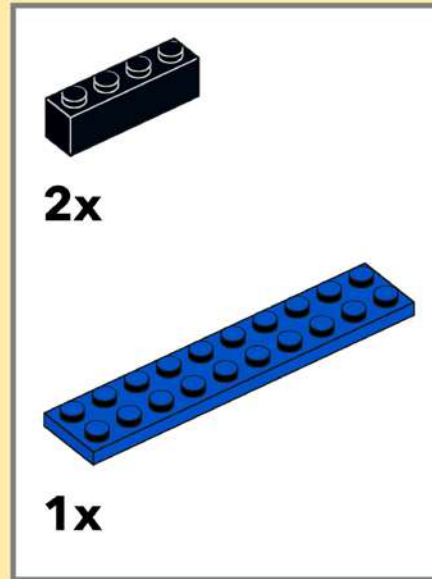

3

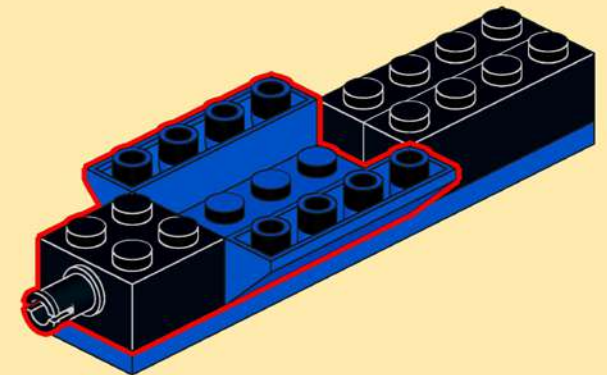
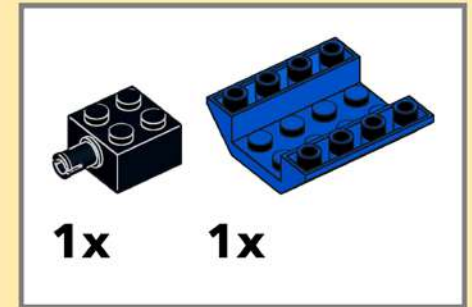

4

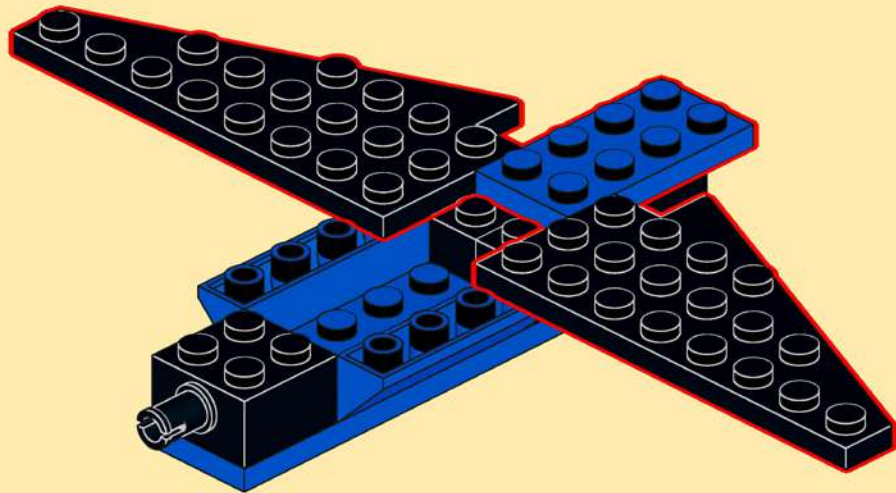
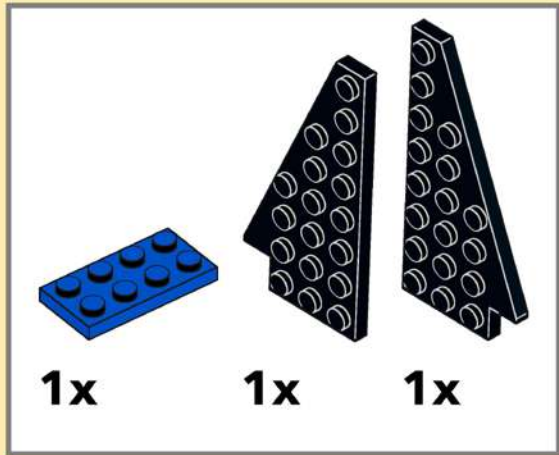

5

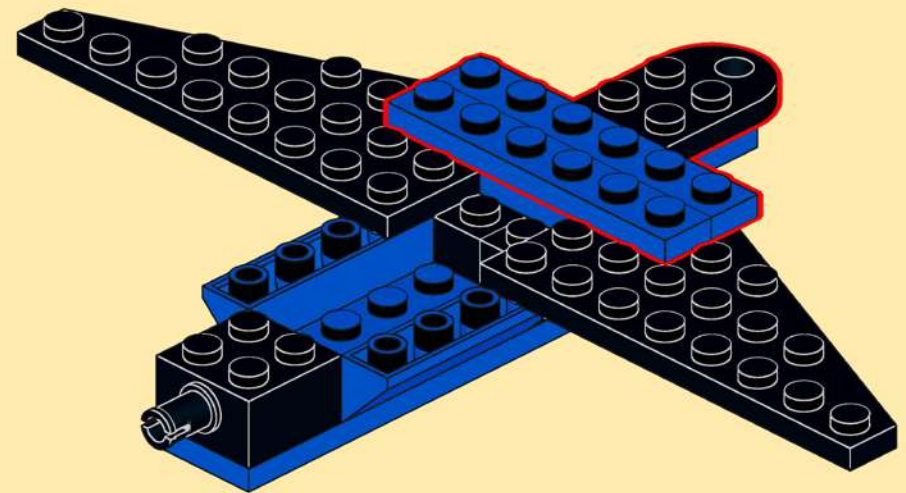
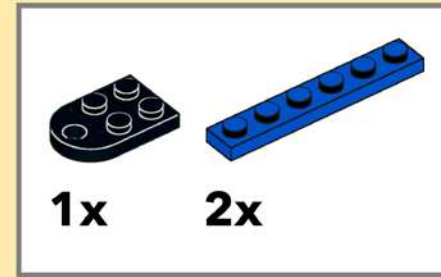

6

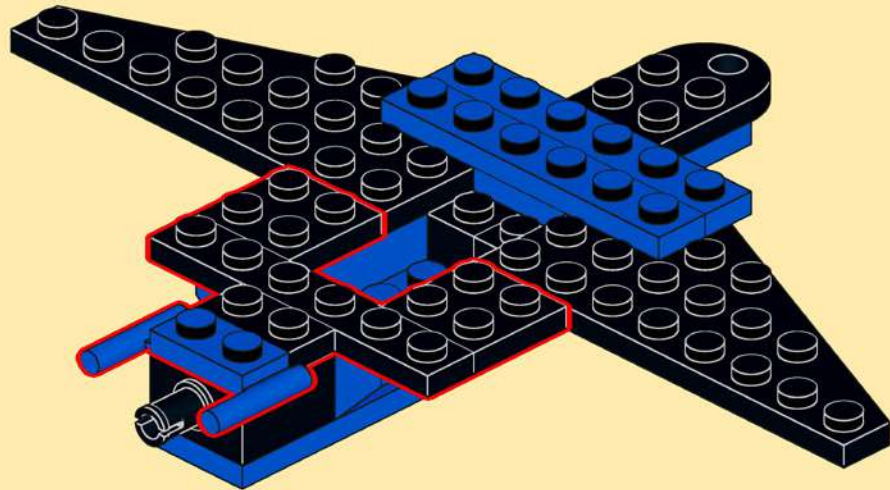
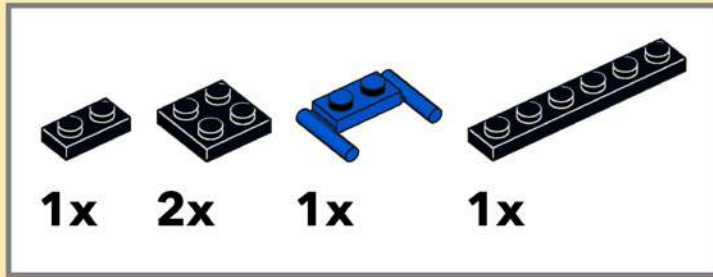

7

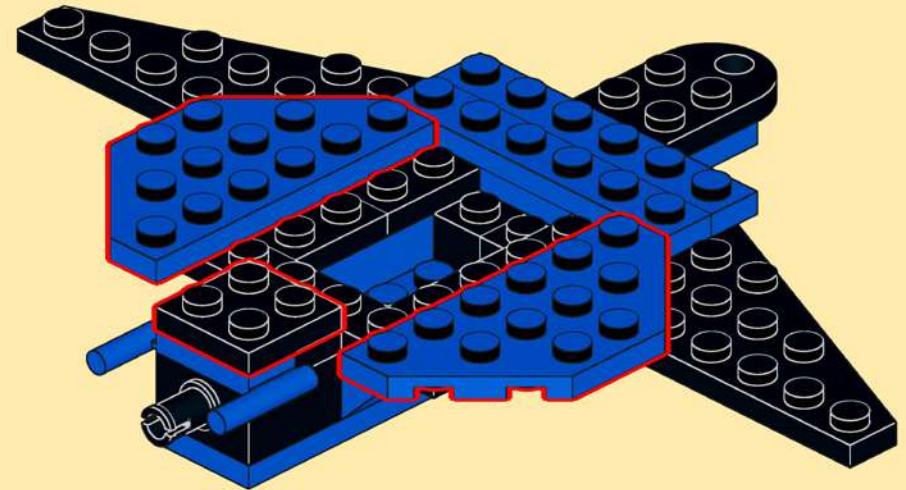
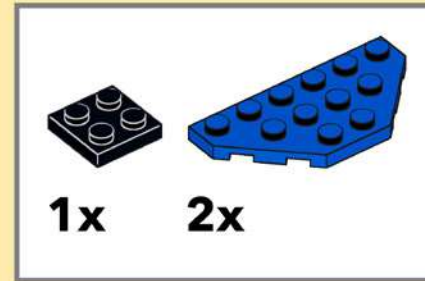

8

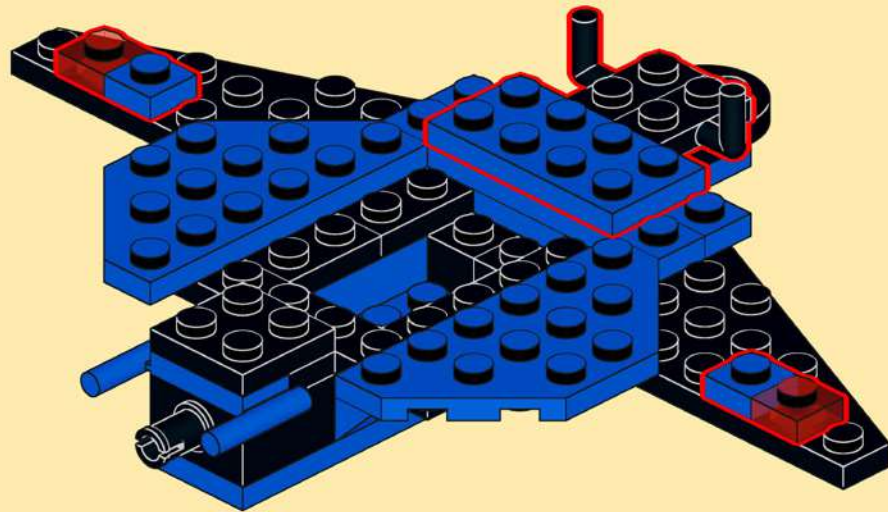
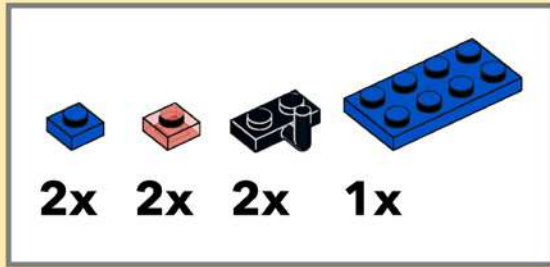

9

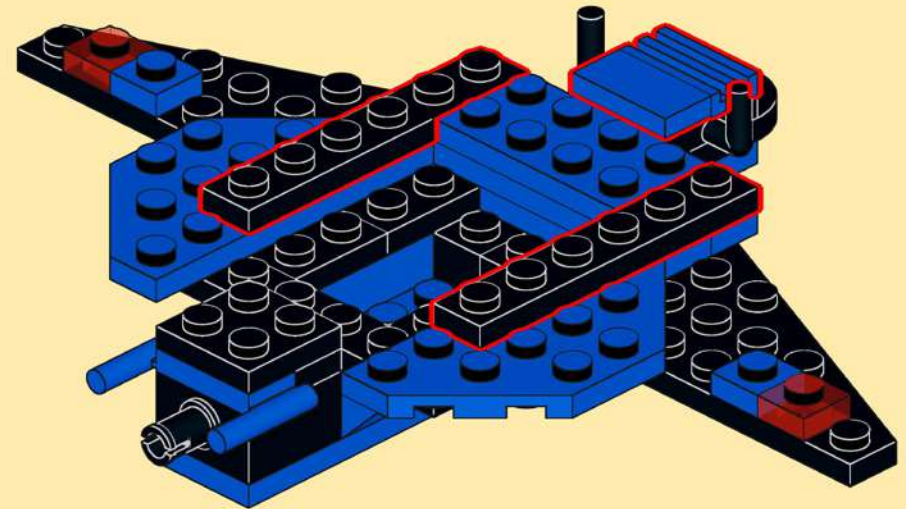
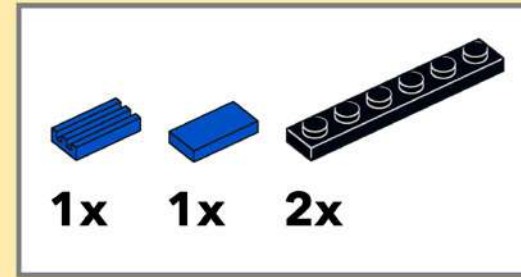

10

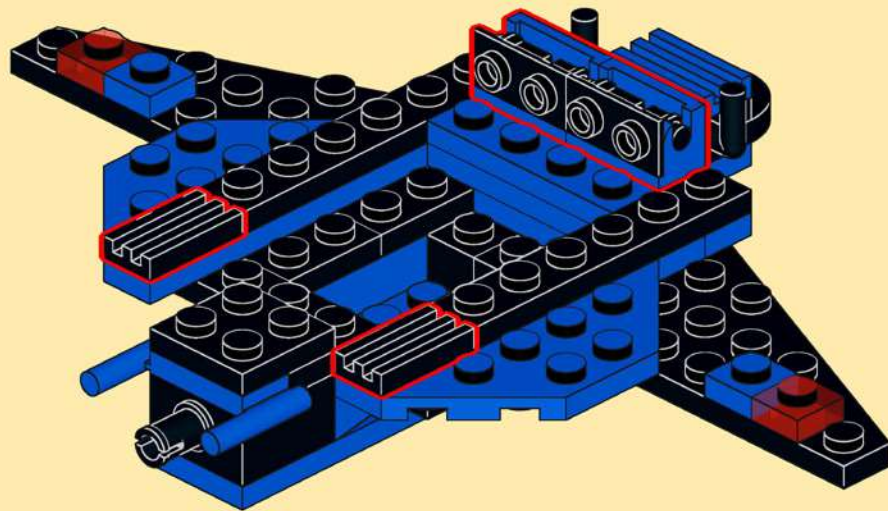
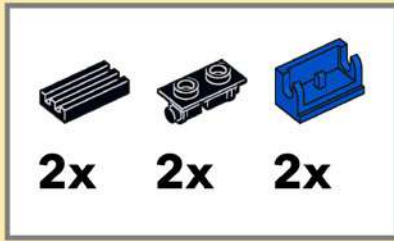

11

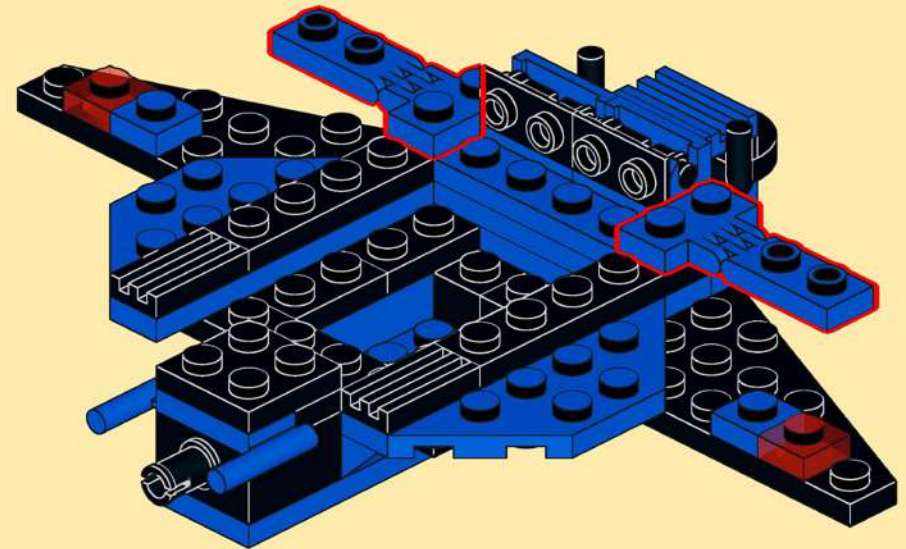
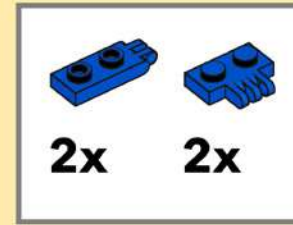

12

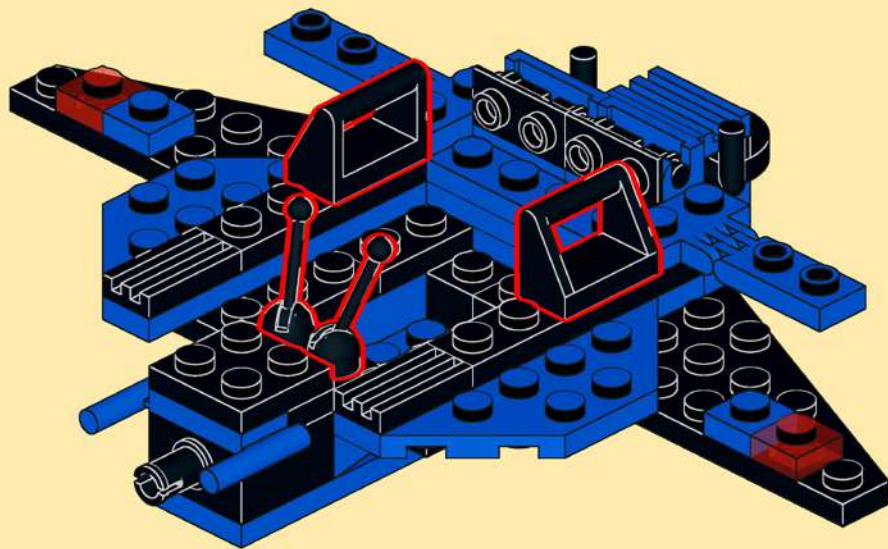

13

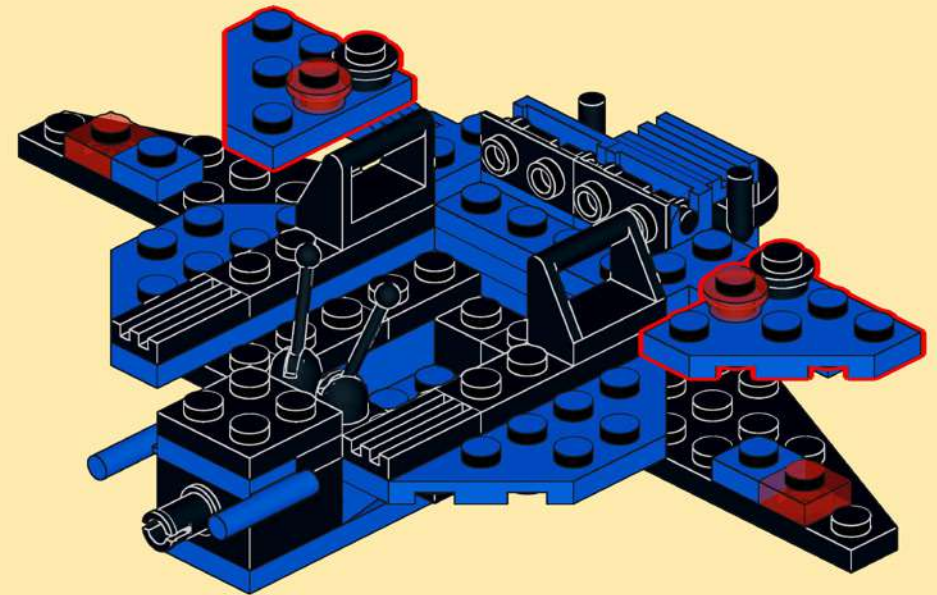
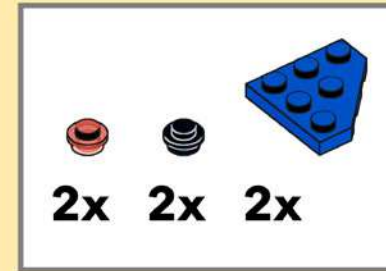

14

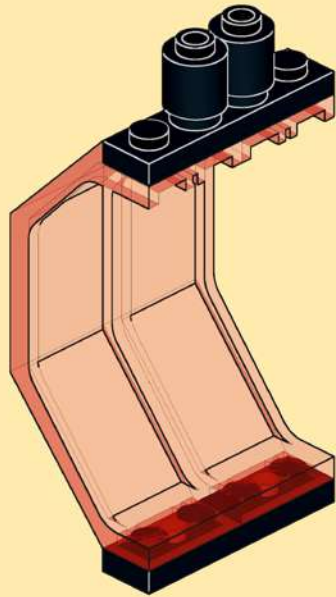
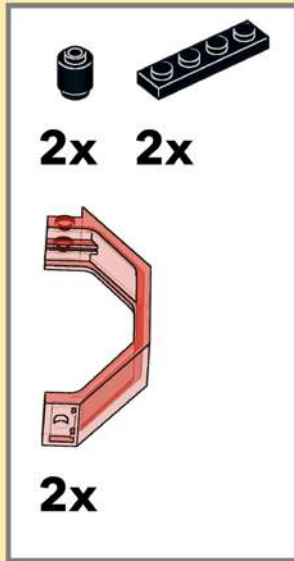

15

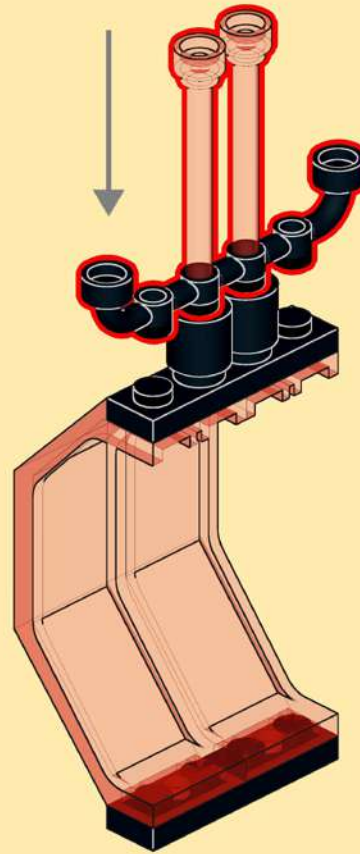
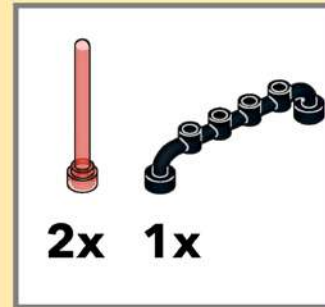

16

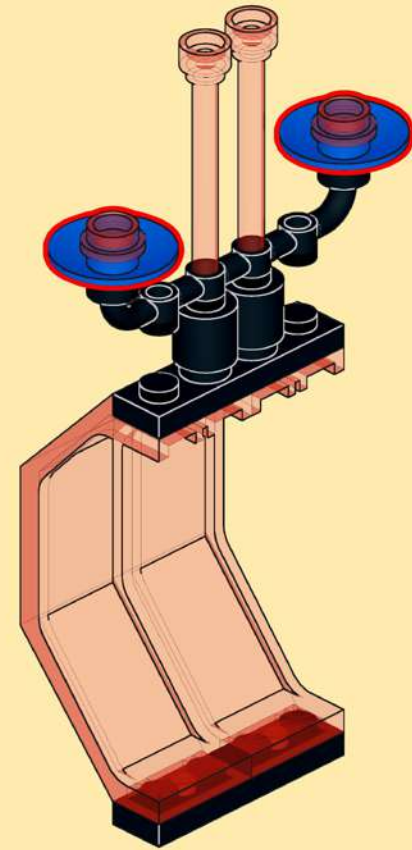
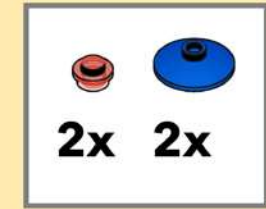

17

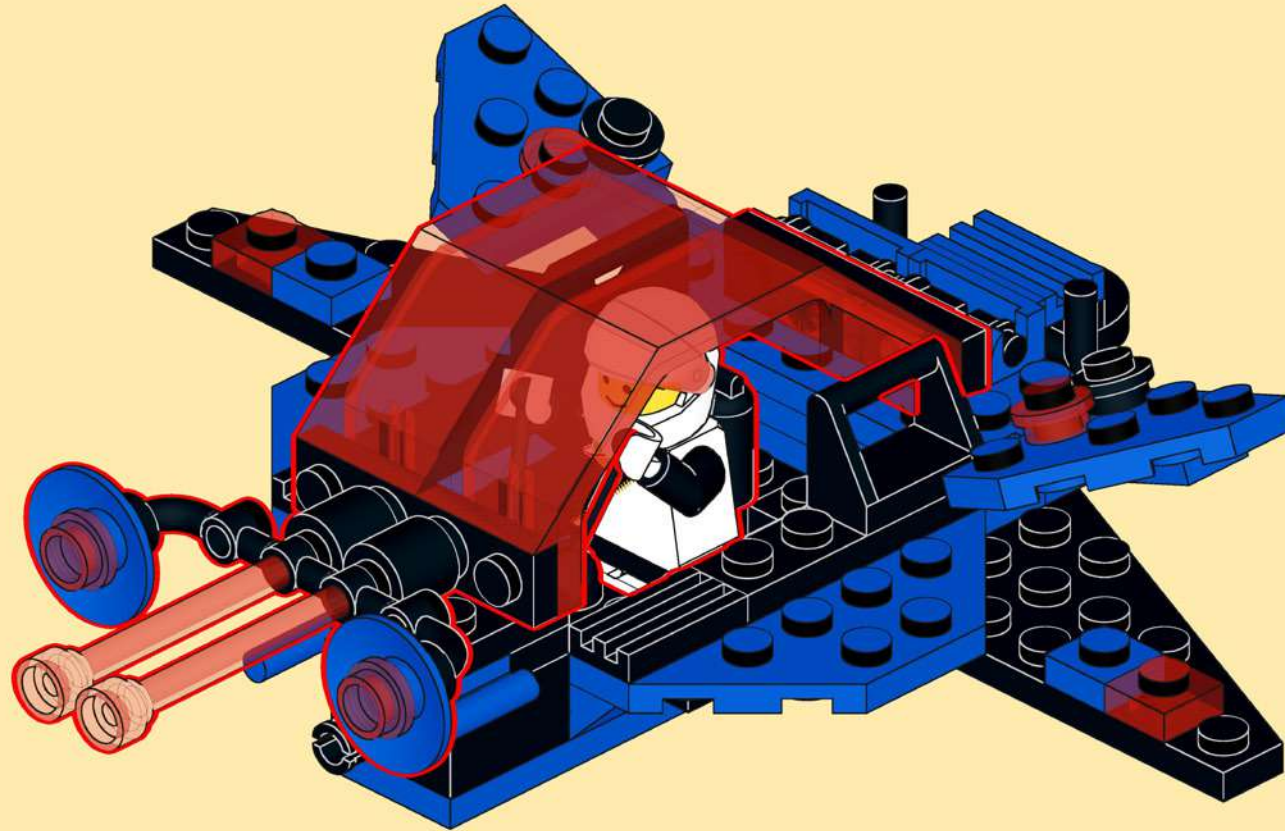

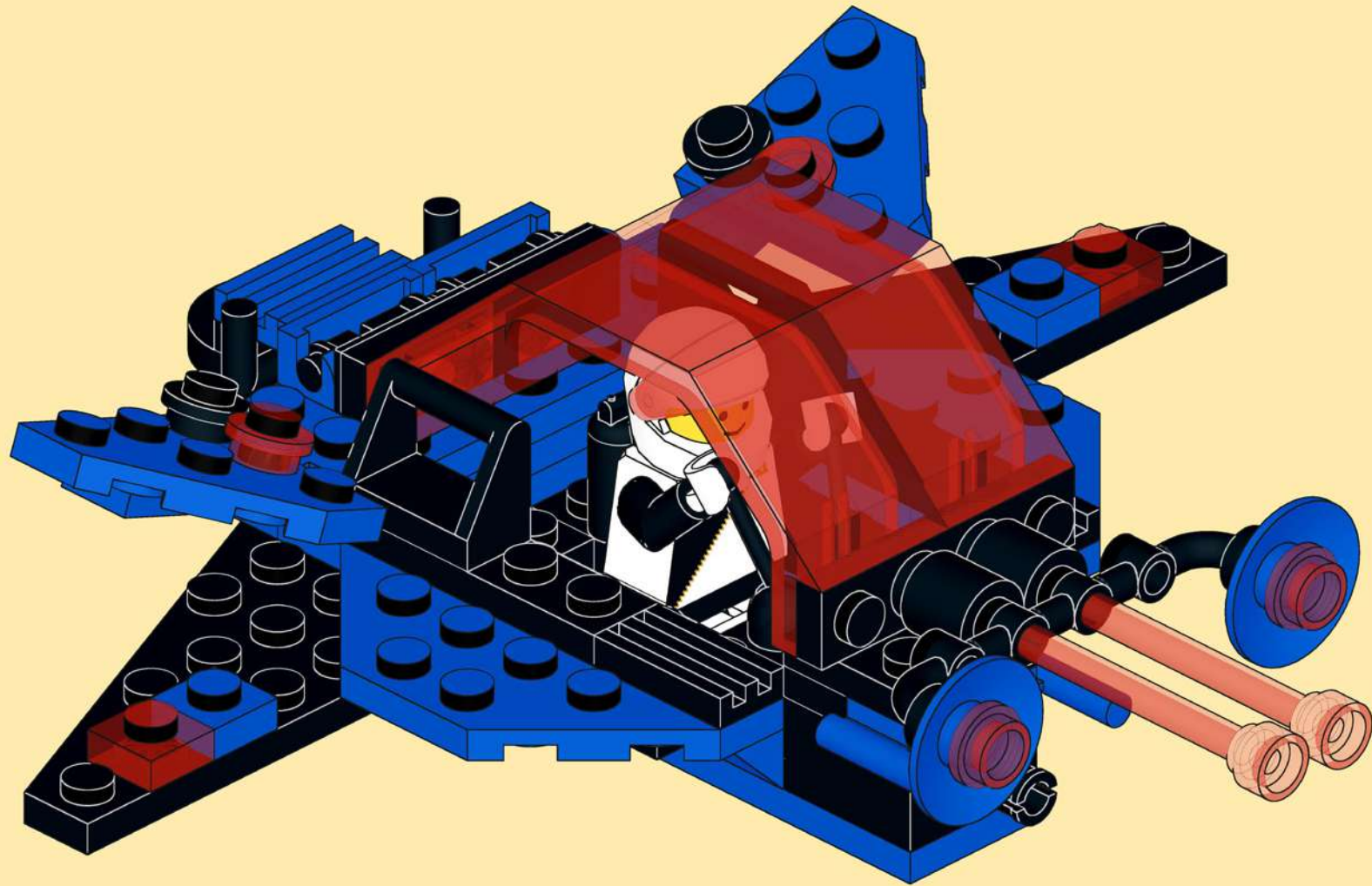

Build them all!

All three spaceships can be built with the parts coming from one copy of set 6986. Instructions are available for each back of the box model. Have fun building!

