



1616
SPACE COMBI-PACK
(SETS 1620 & 1621)
ALTERNATE MODEL (1990)

INSTRUCTIONS

CONCEPT BY BJARNE TVESKOV,
JØRN THOMSEN & LEGO
PHOTOGRAPHY & INSTRUCTIONS
BY COSMIC.BRICK





1616 SPACE COMBI-PACK
ALTERNATE MODEL INSTRUCTIONS

1

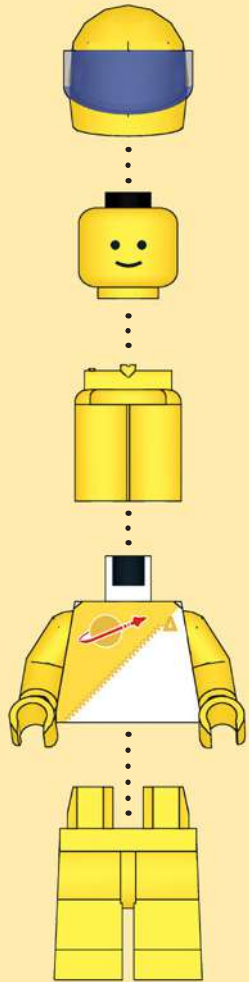

2

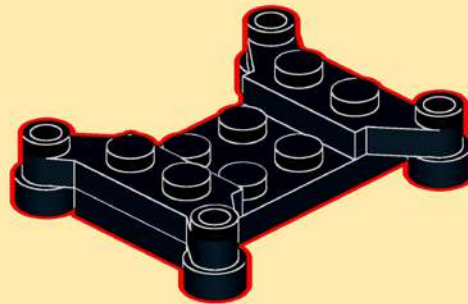
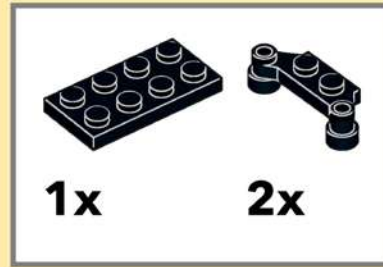

3

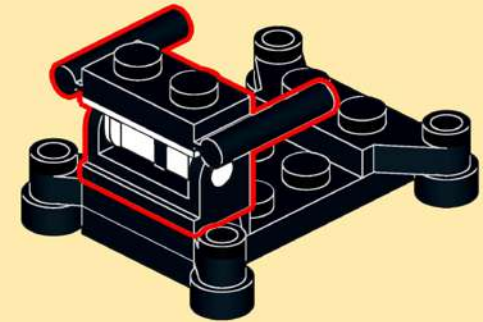
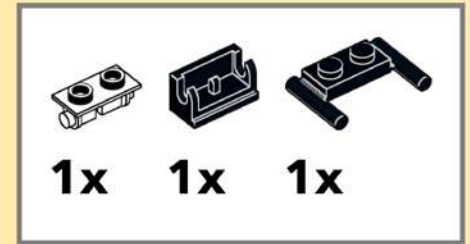

4

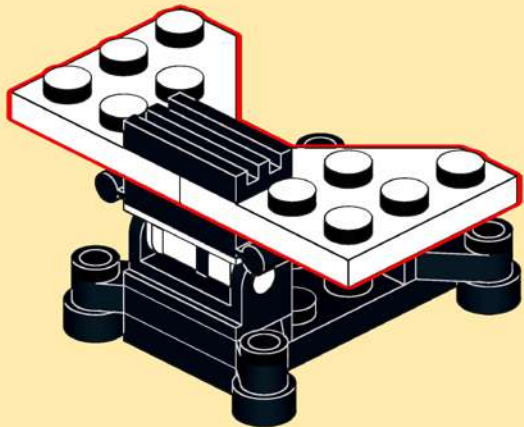
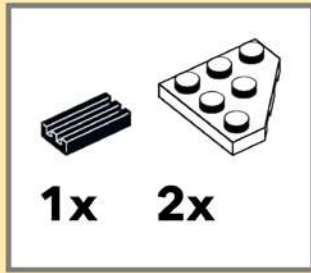

5

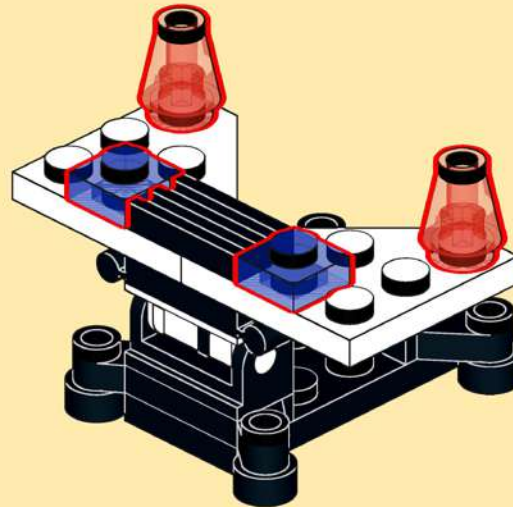

6



1

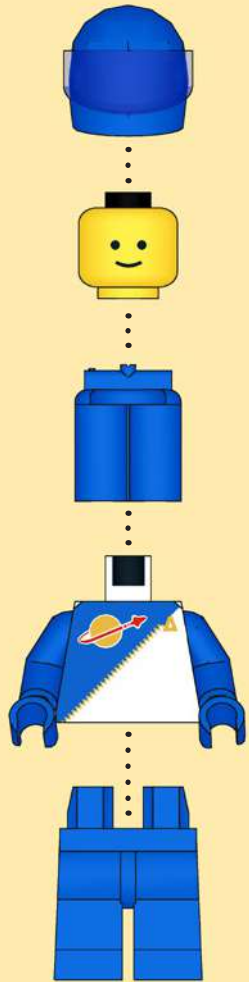

2

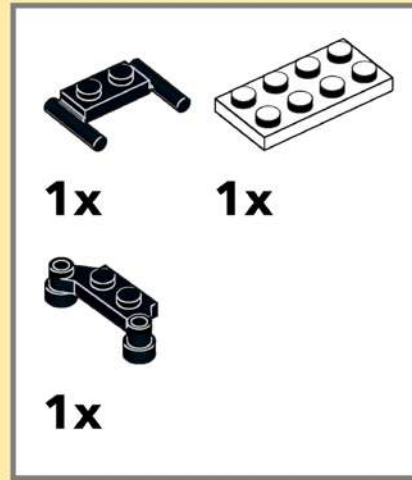

3

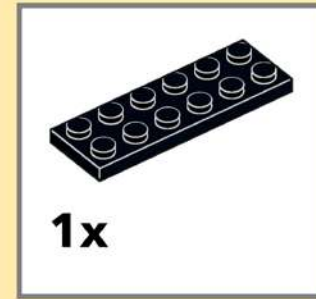

4

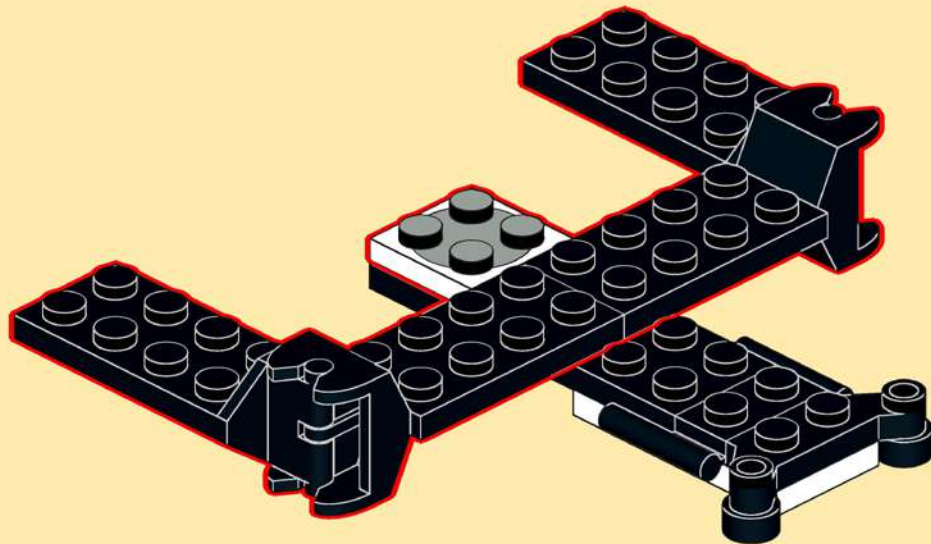
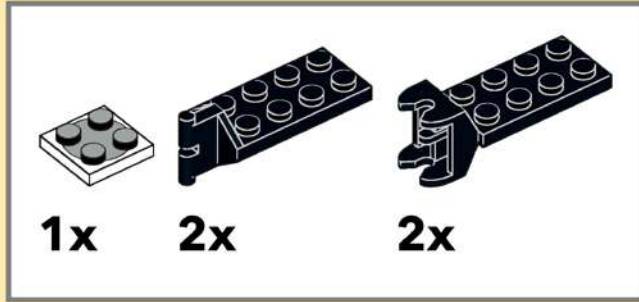

5

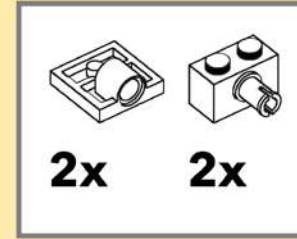

6

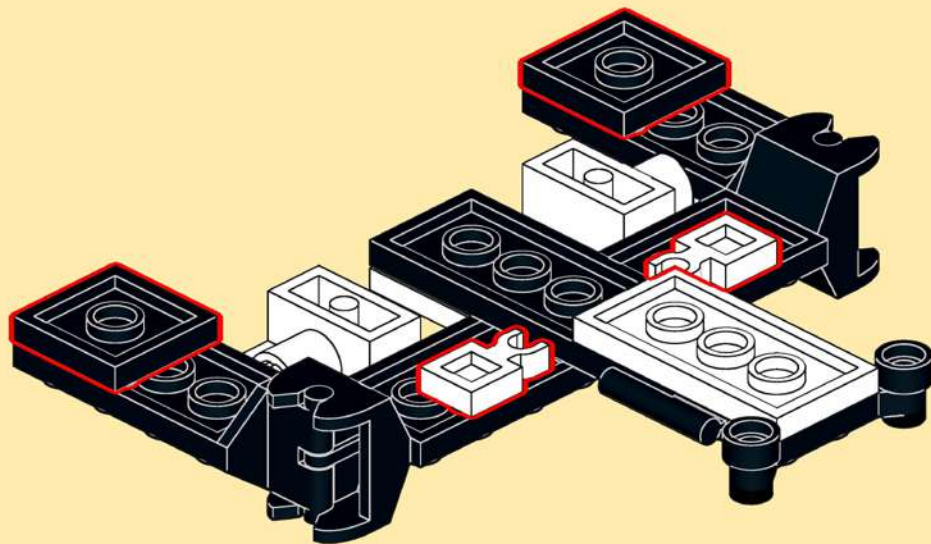
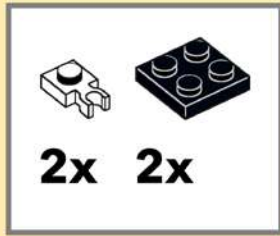

7

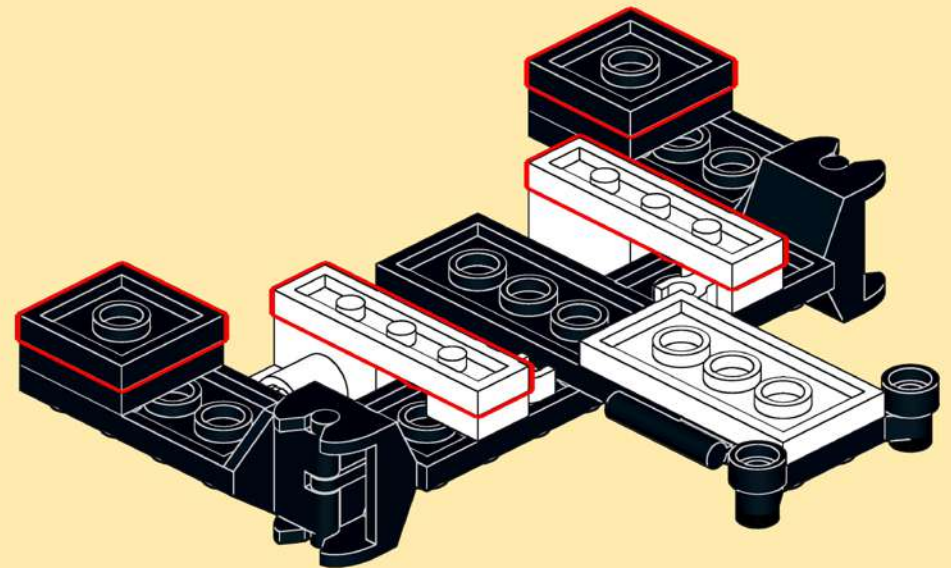
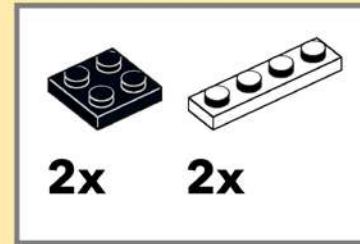

8

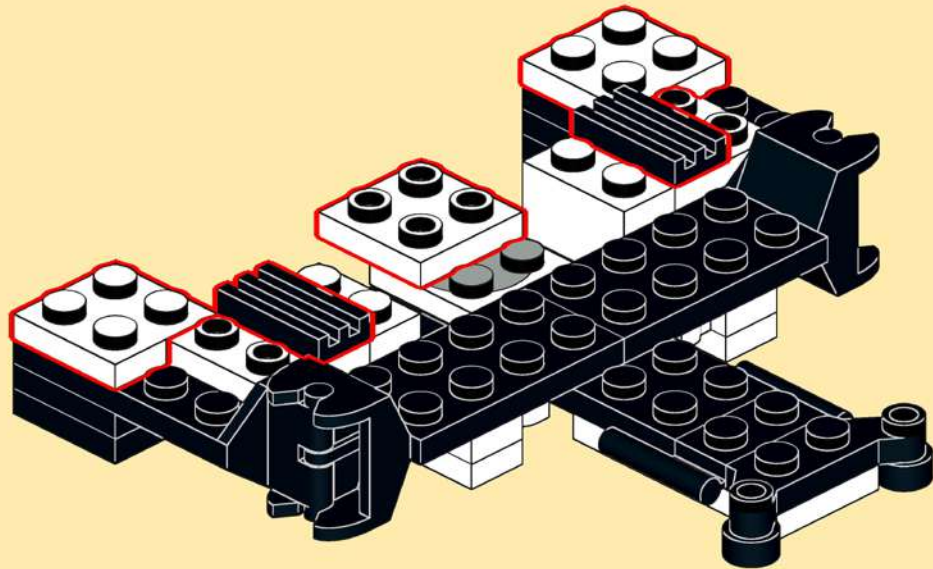
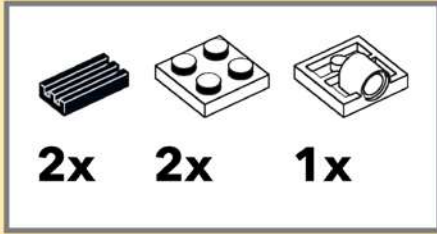

9

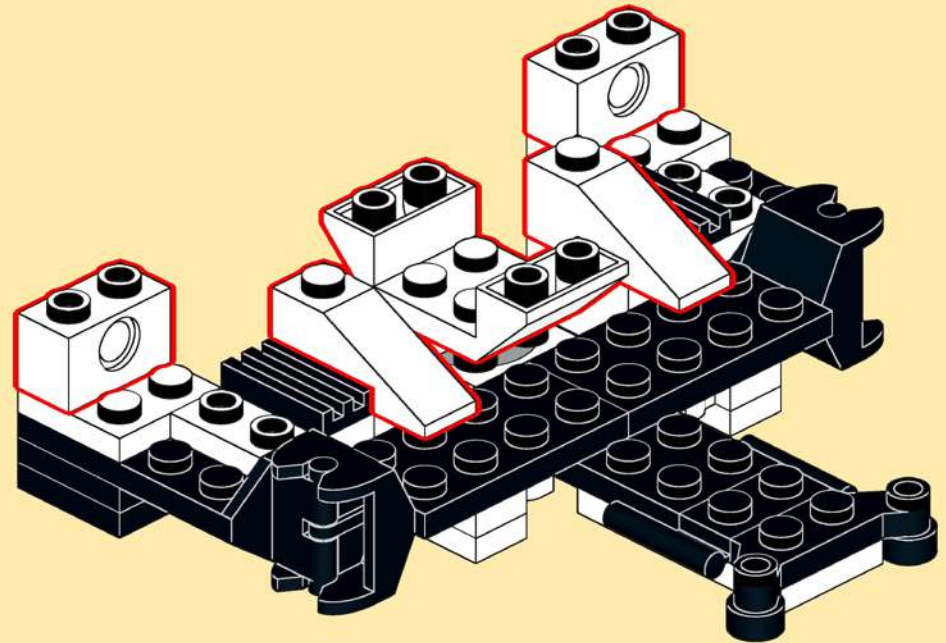
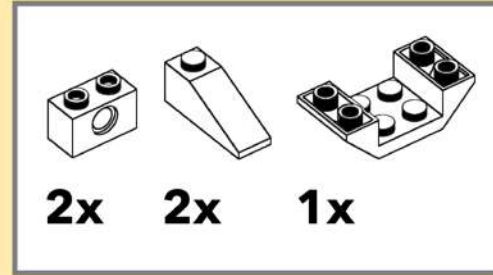

10

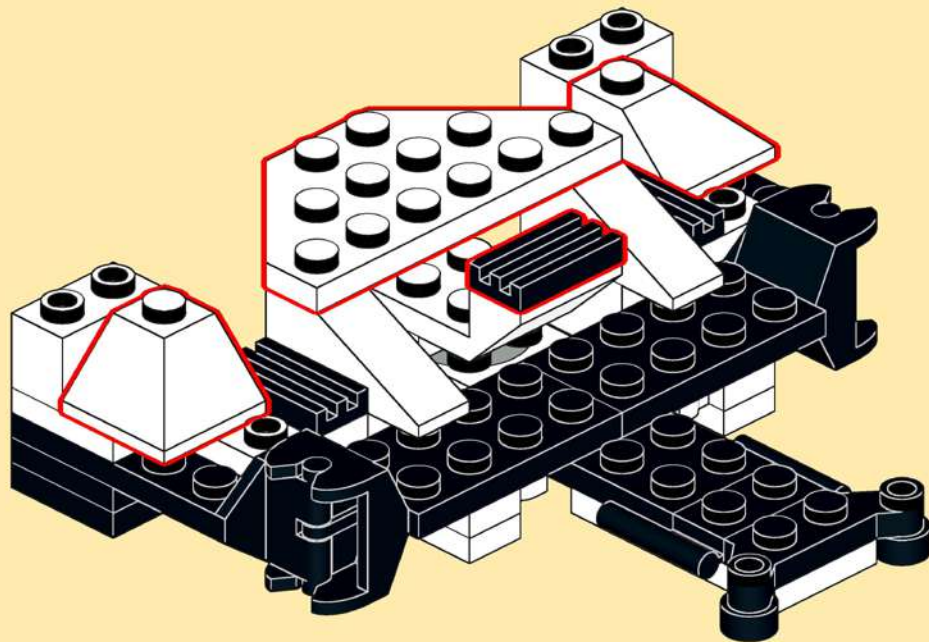
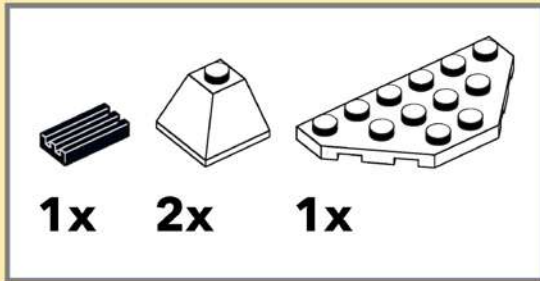

11

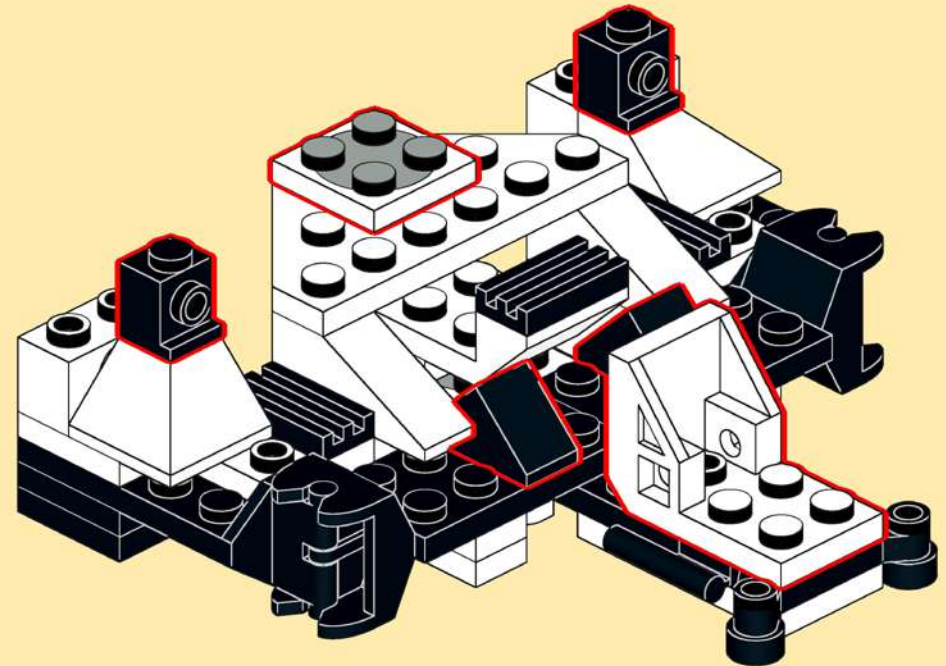
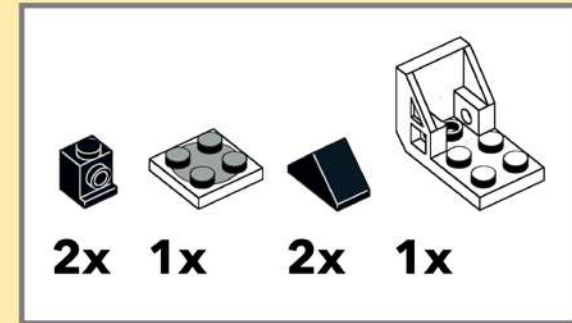

12

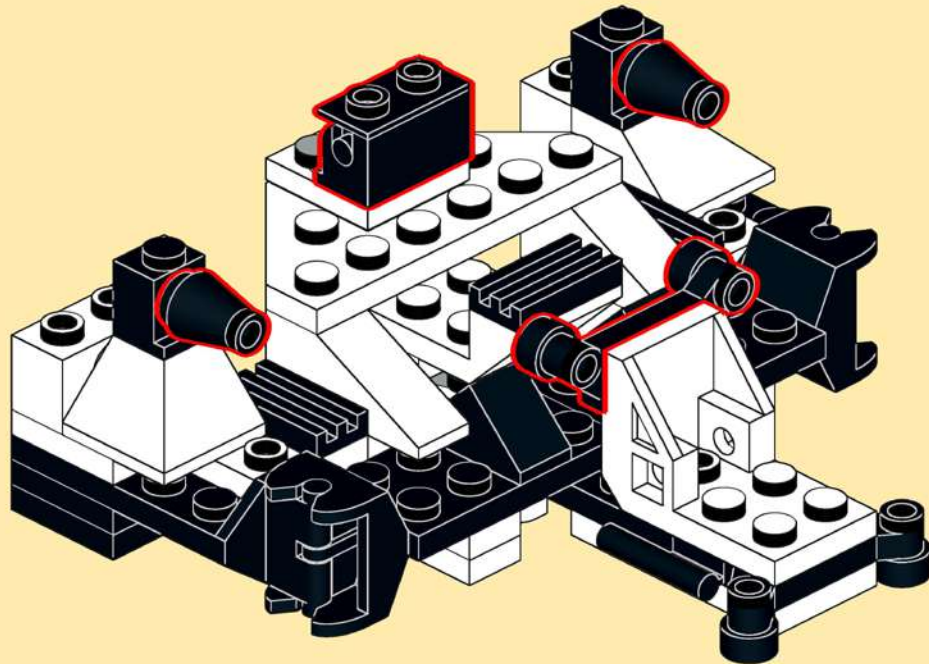
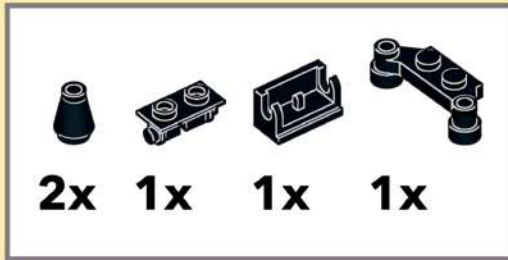

13

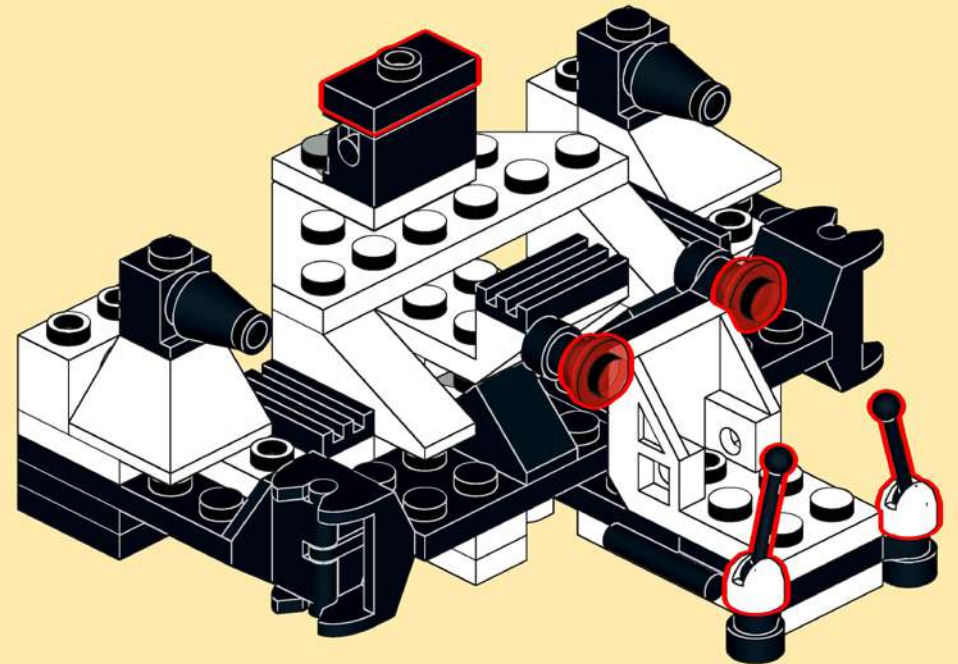
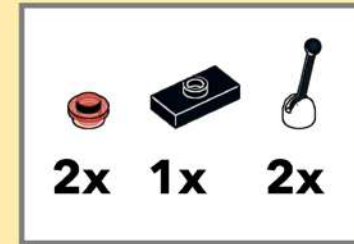

14

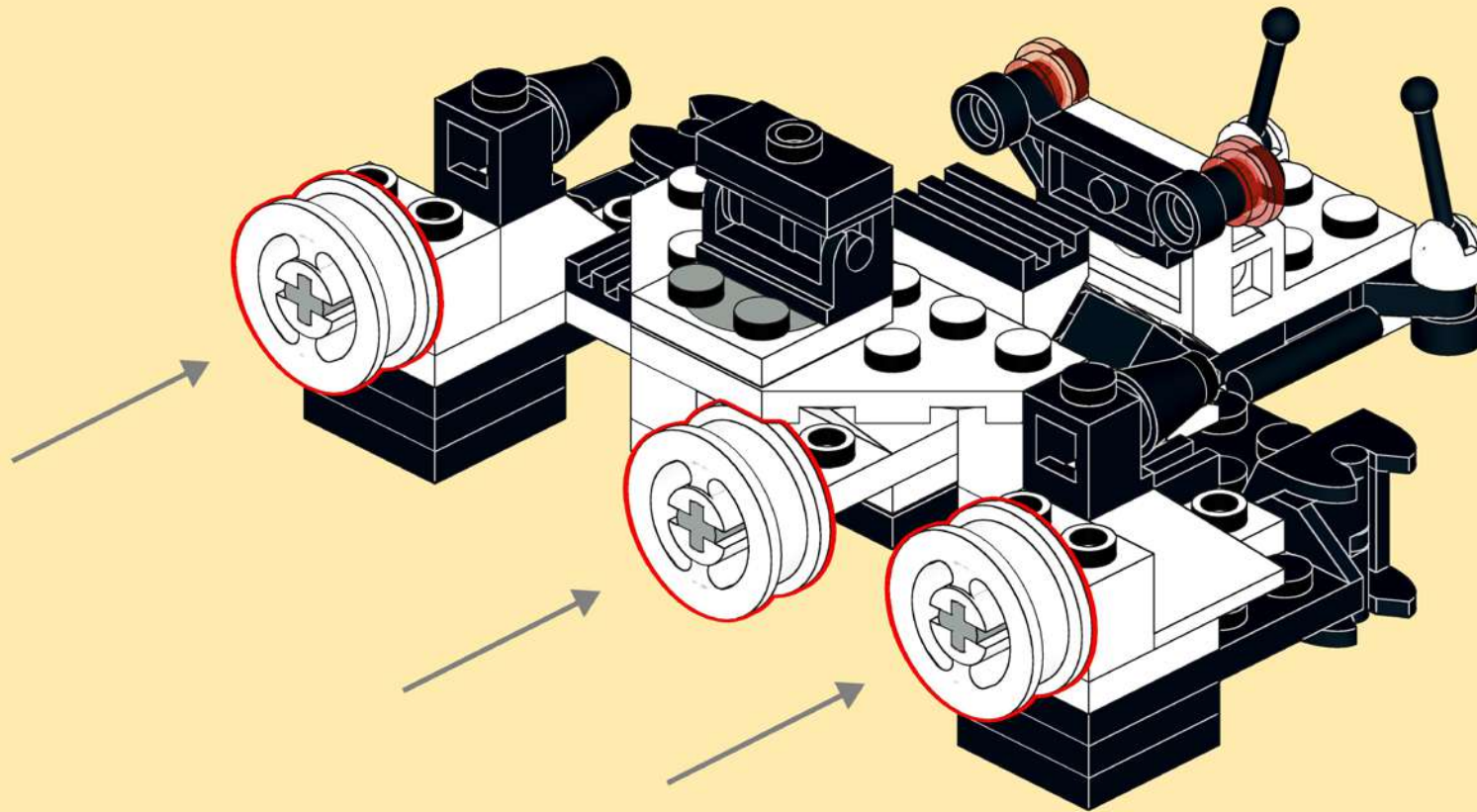
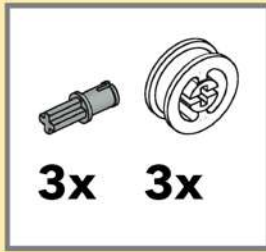

15



16

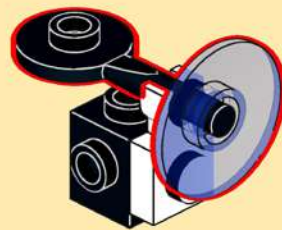
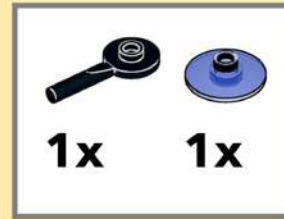

17

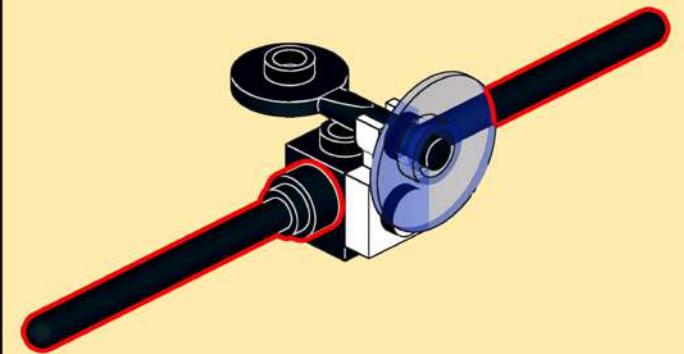
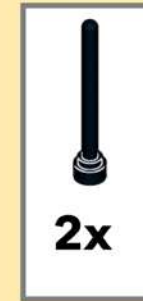

18

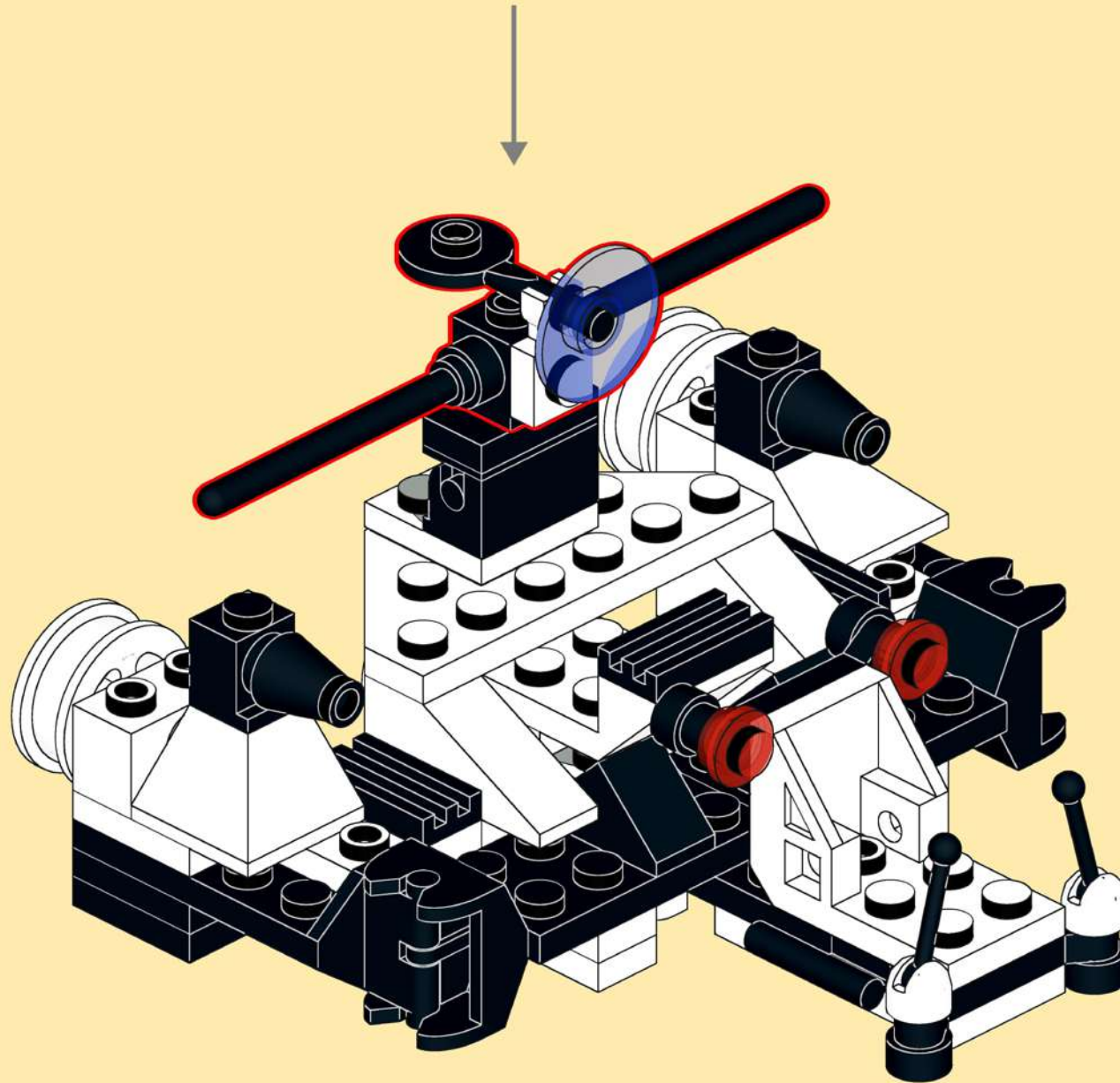

19

