



1616
SPACE COMBI-PACK
(SETS 1620 & 1621)
ALTERNATE MODEL (1990)

INSTRUCTIONS

CONCEPT BY BJARNE TVESKOV,
JØRN THOMSEN & LEGO
PHOTOGRAPHY & INSTRUCTIONS
BY COSMIC.BRICK





1

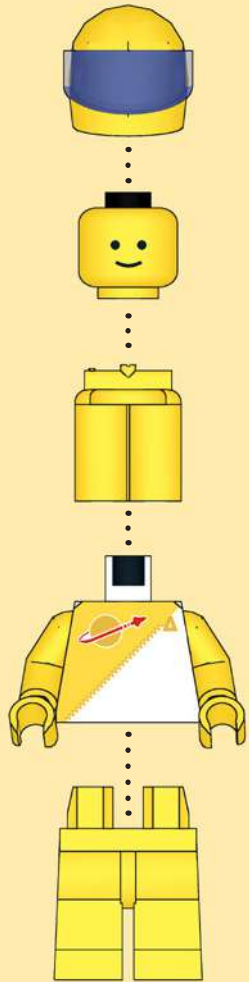

2

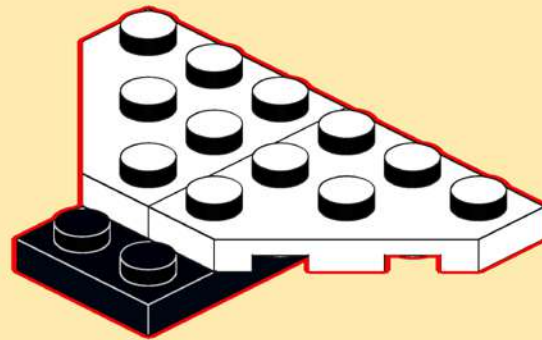
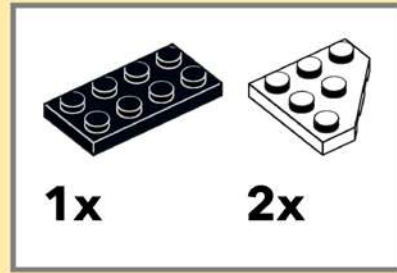

3

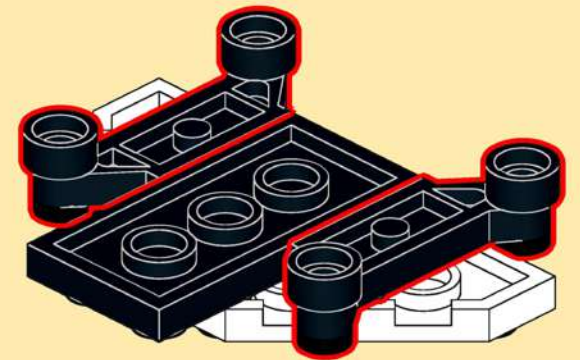
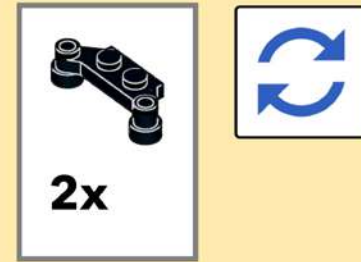

4

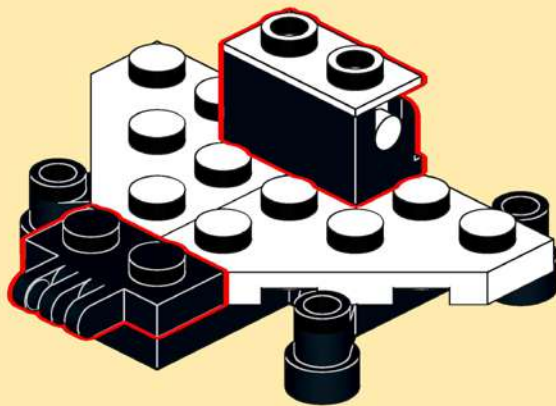
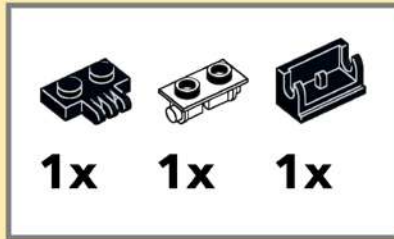

5

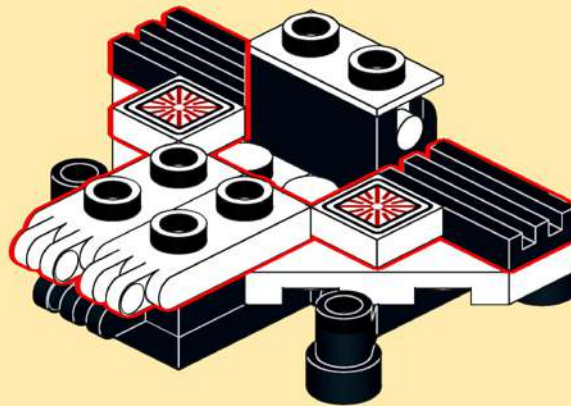
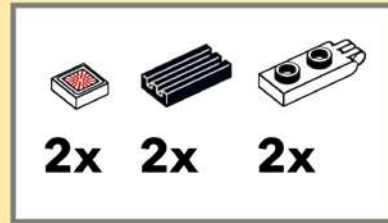

6

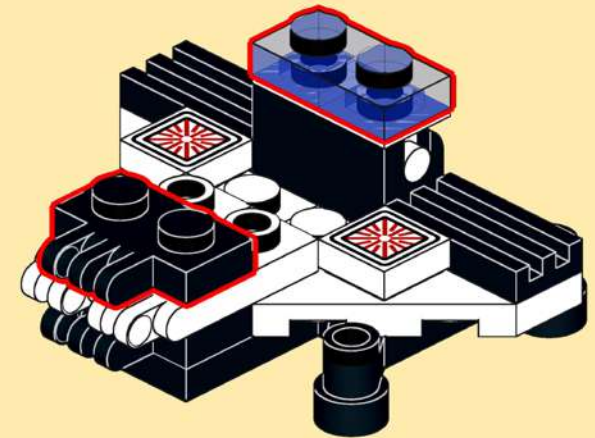
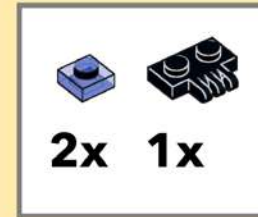

7

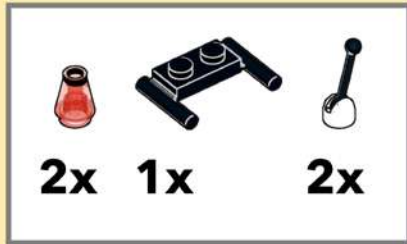

8

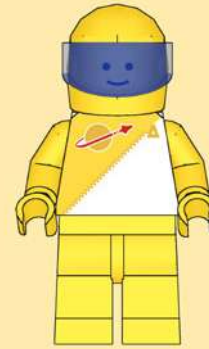

1

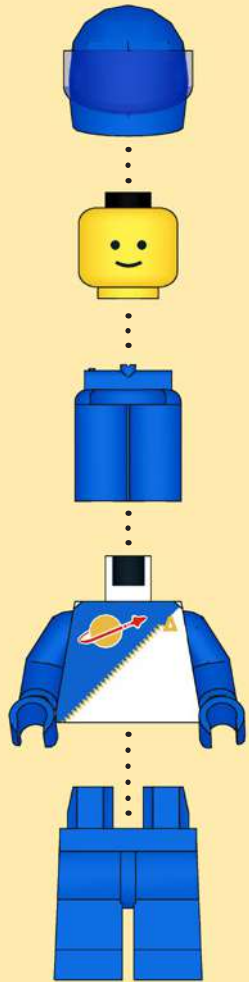

2

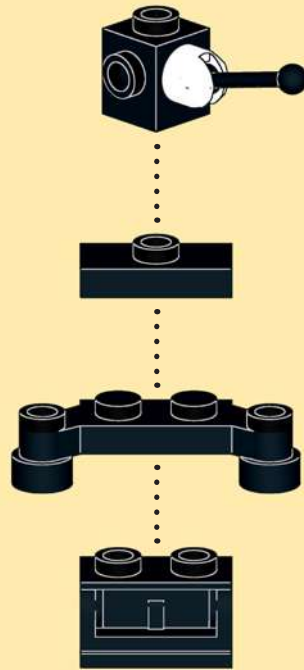

3

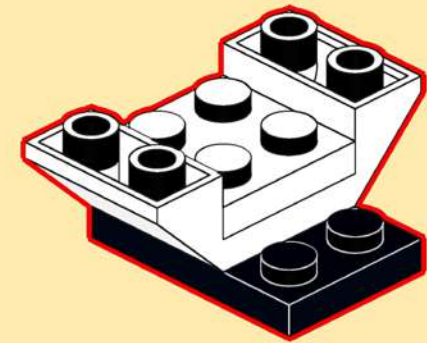
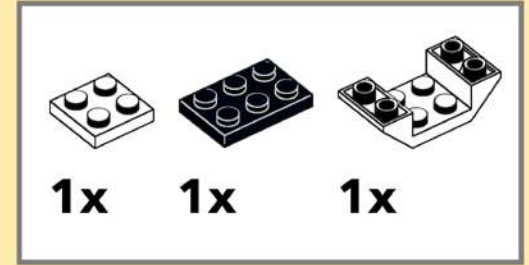

4

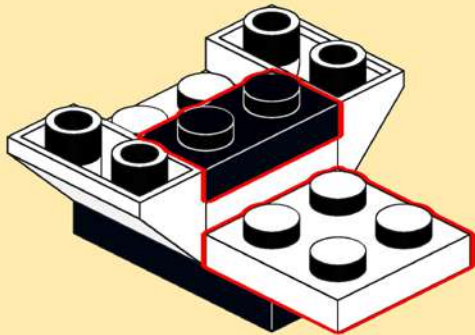
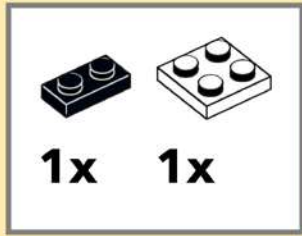

5

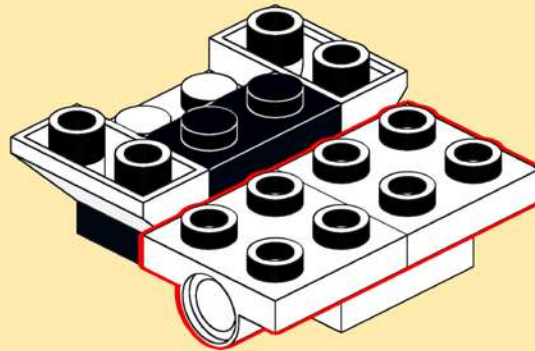
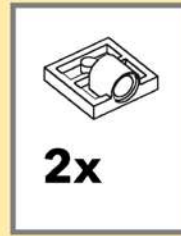

6

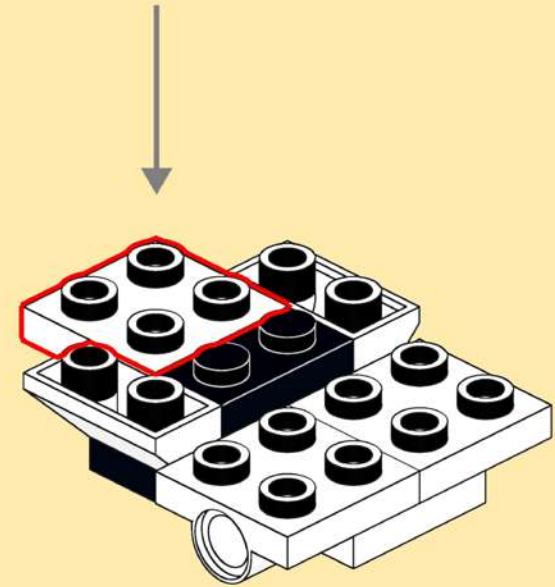
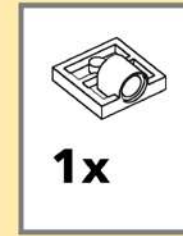

7

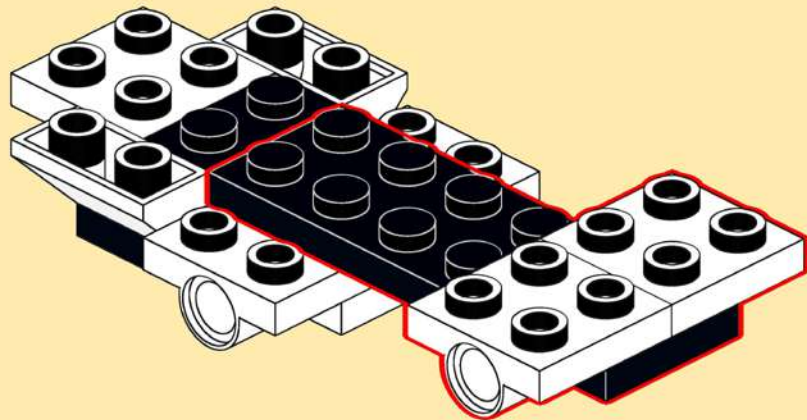
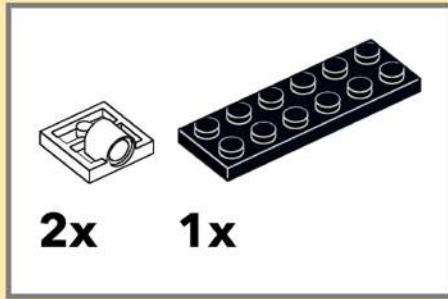

8

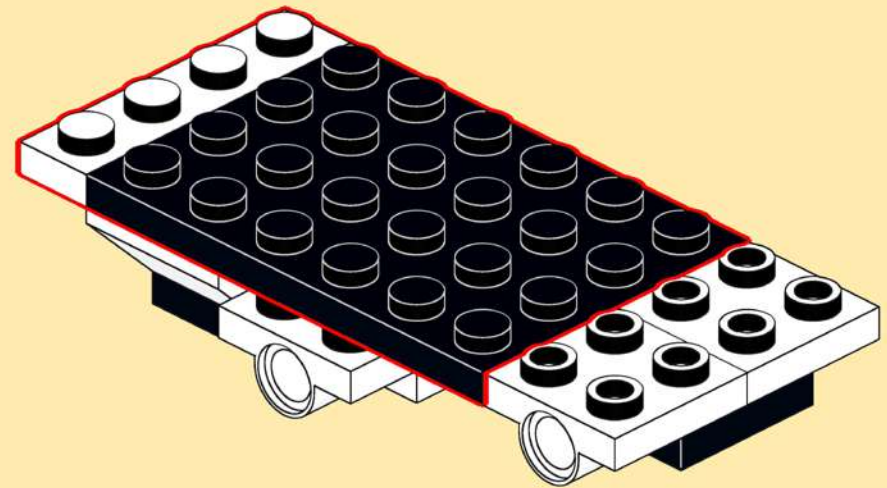
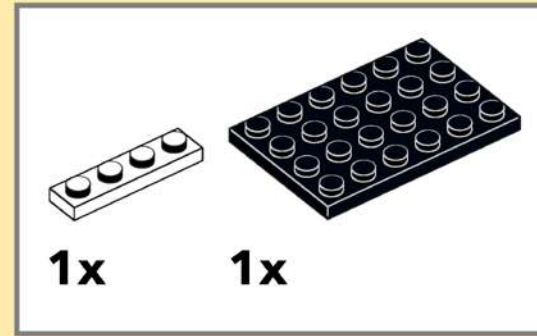

9

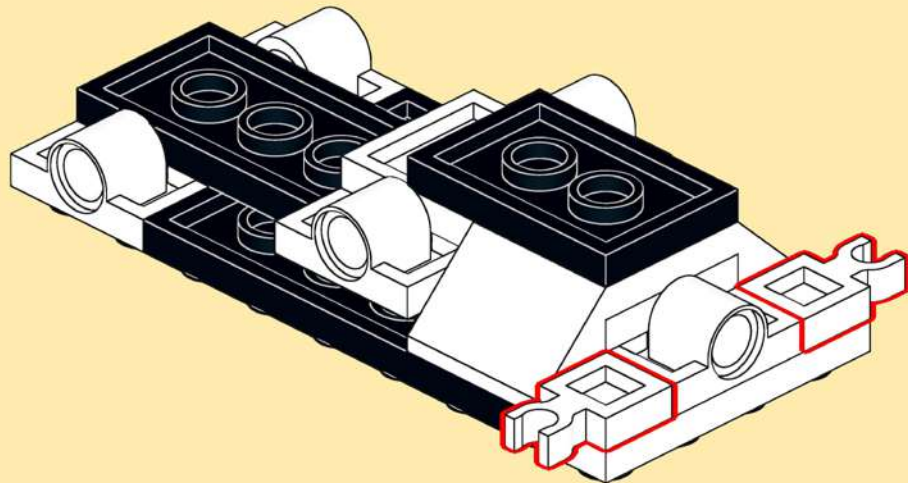

10

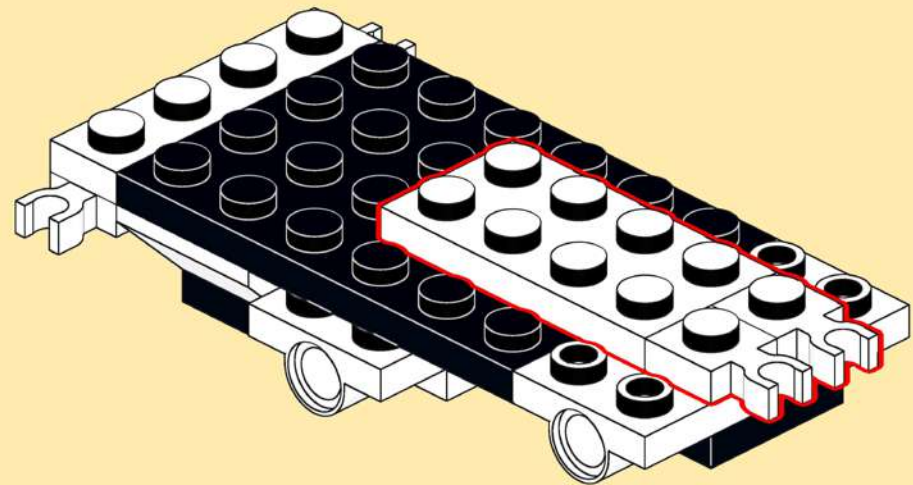
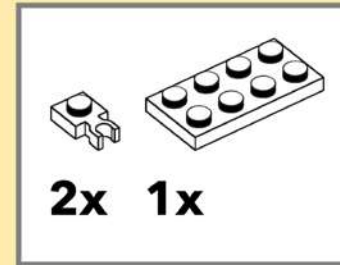

11

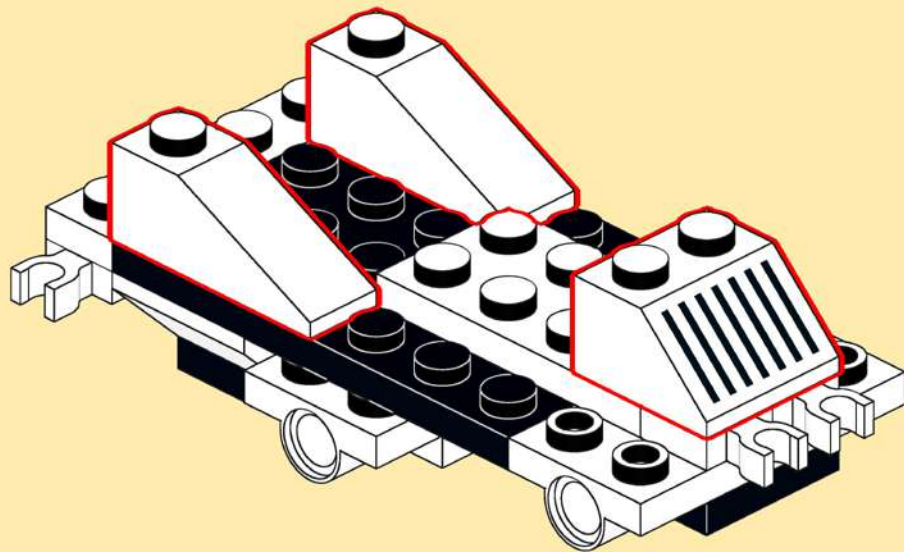
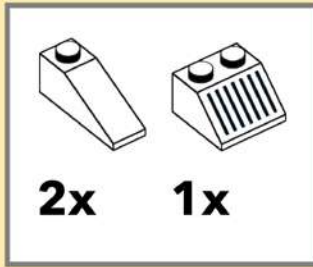

12

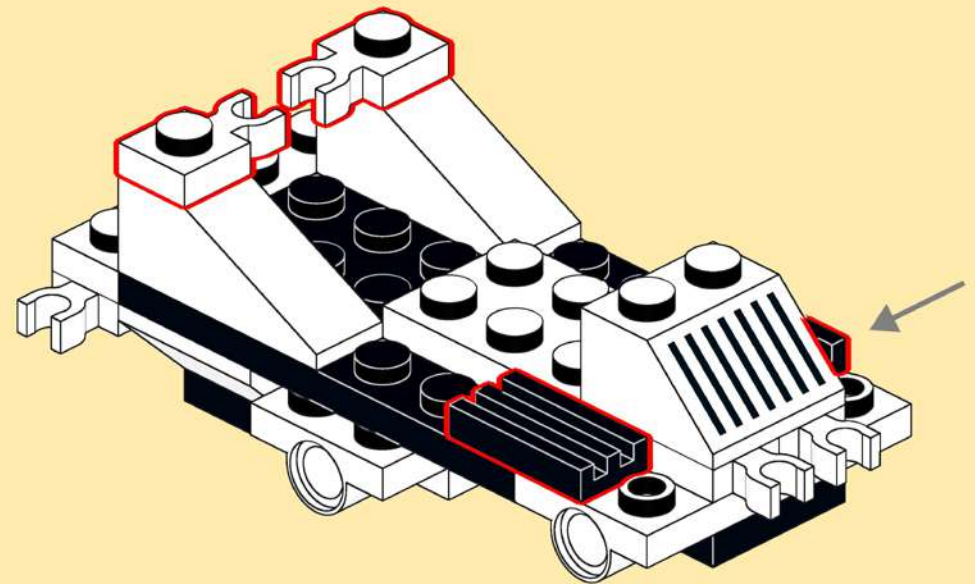
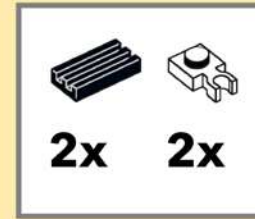



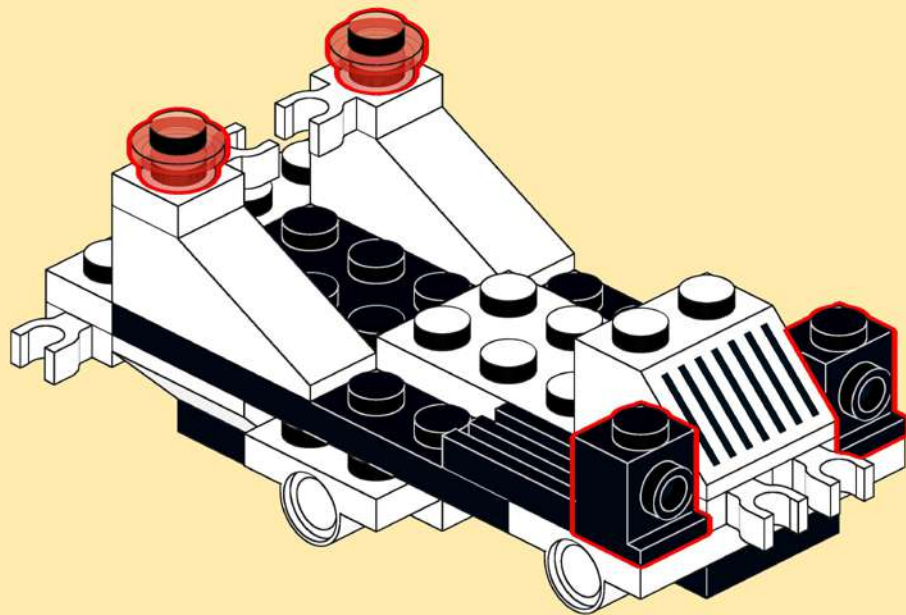

13

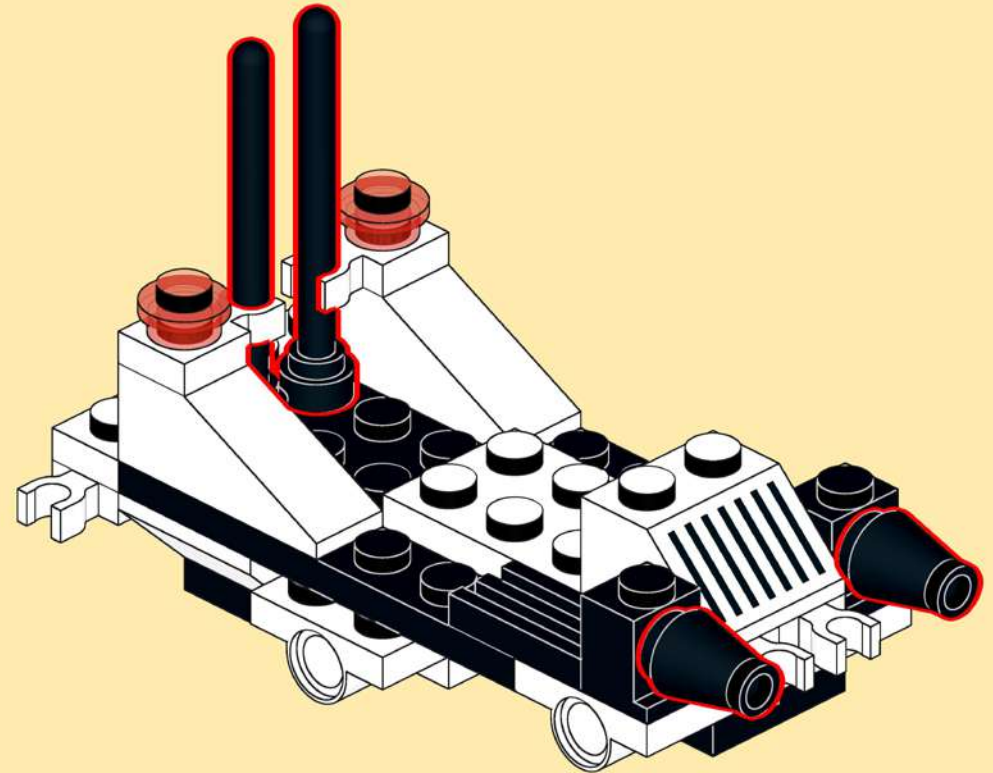

14

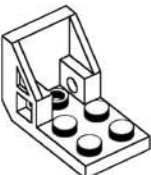

15

-  2x
-  1x
-  1x
-  1x
-  1x

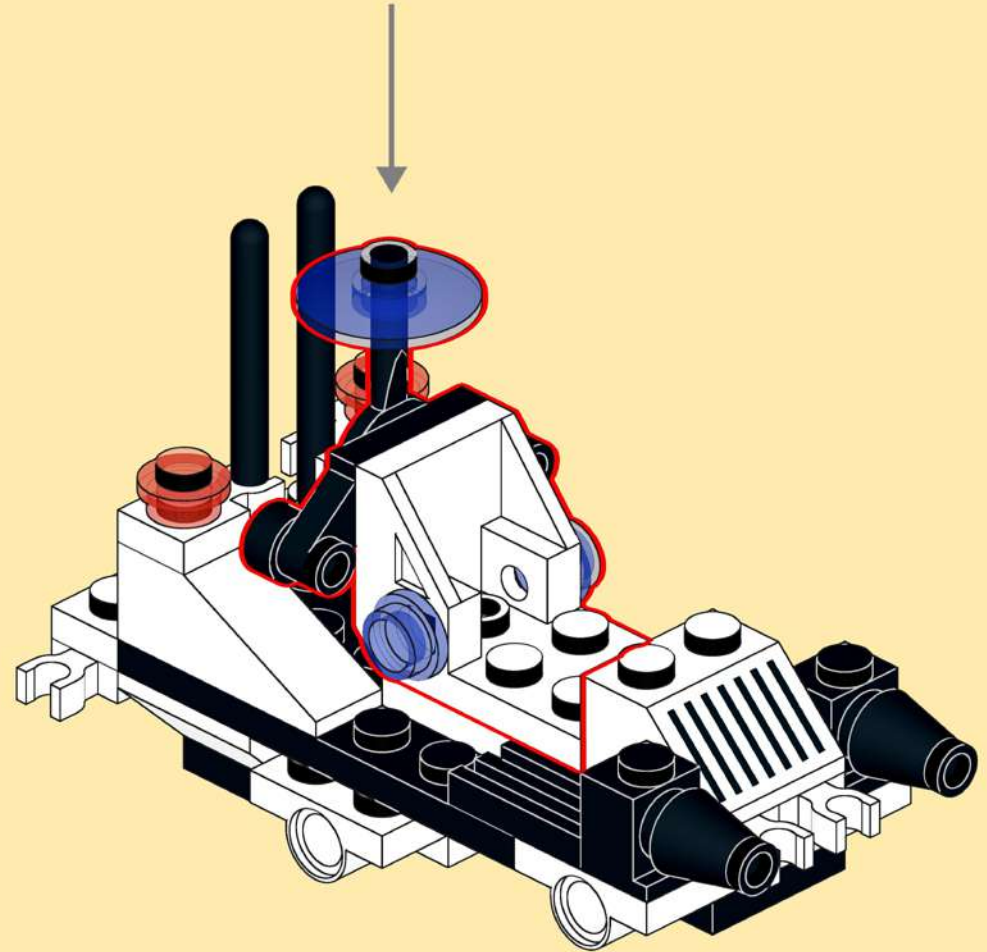
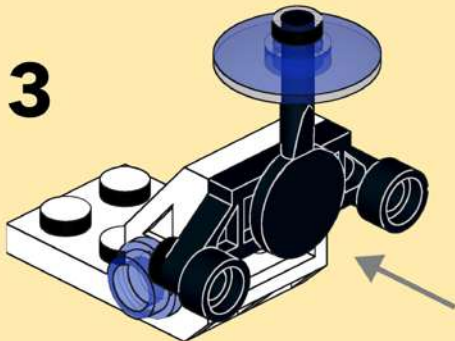
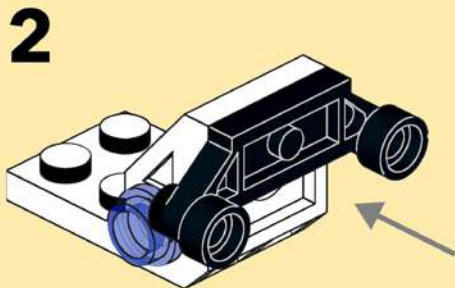
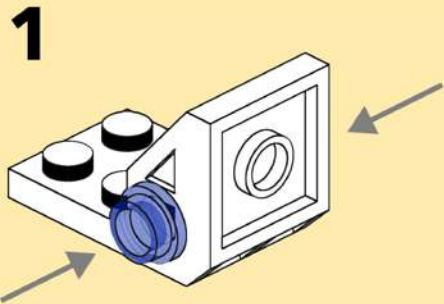

16

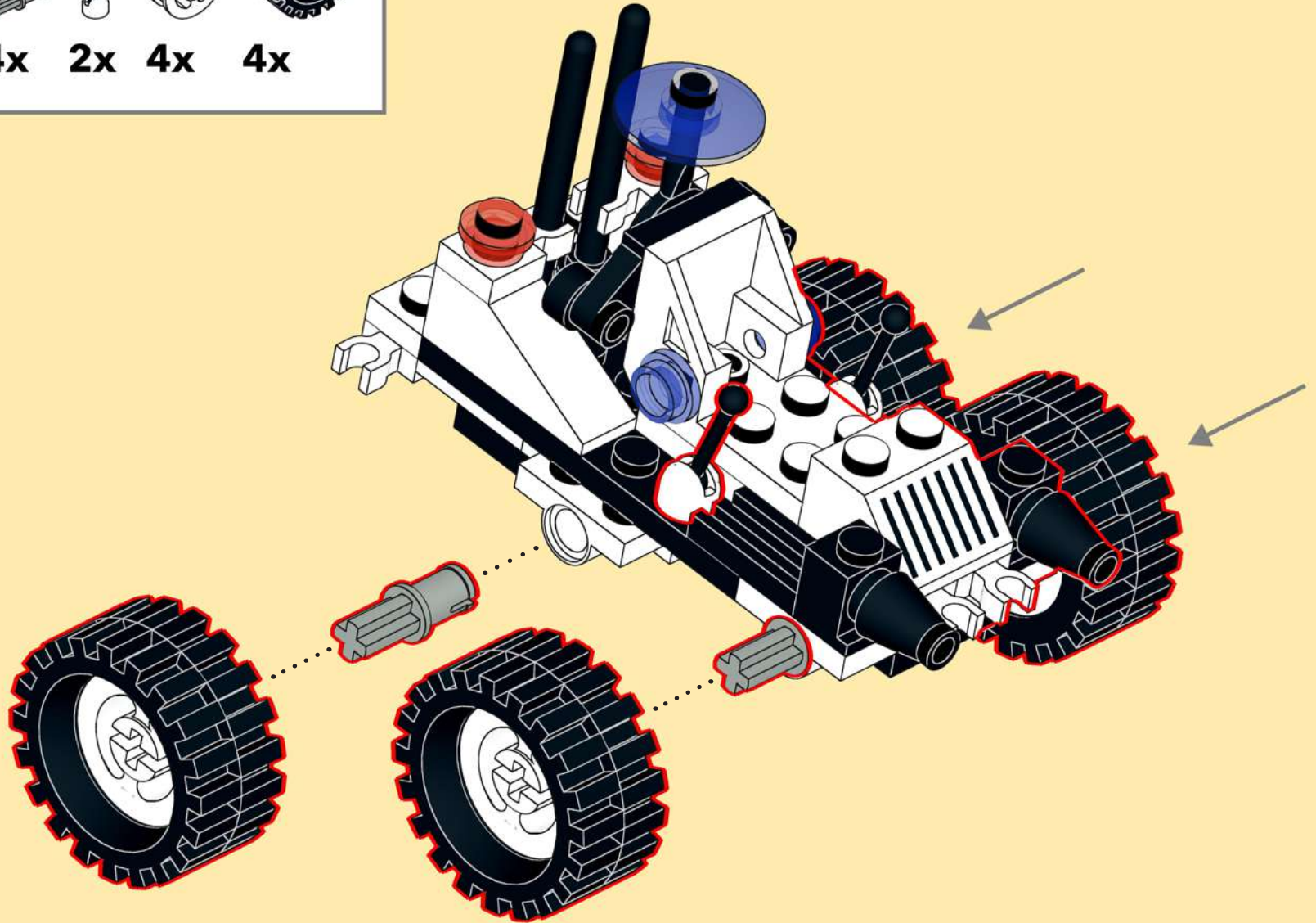
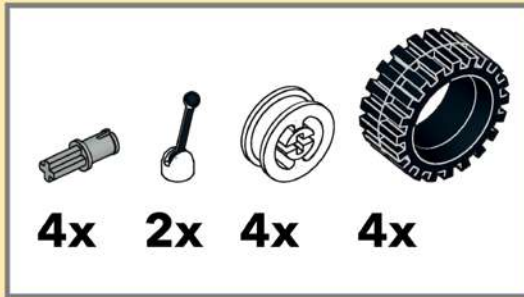

17

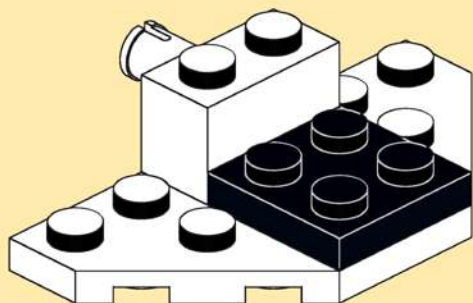
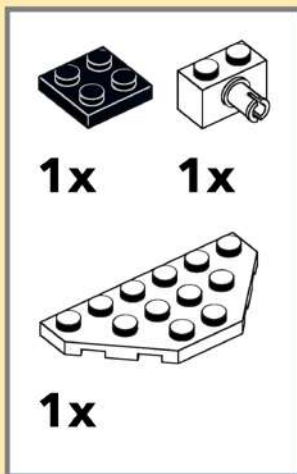

18

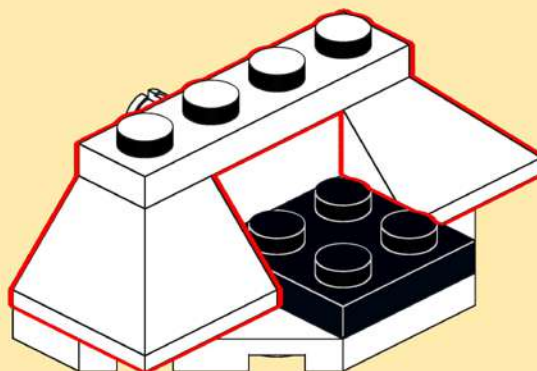
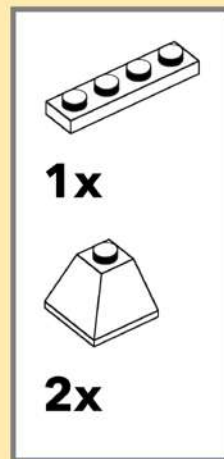

19

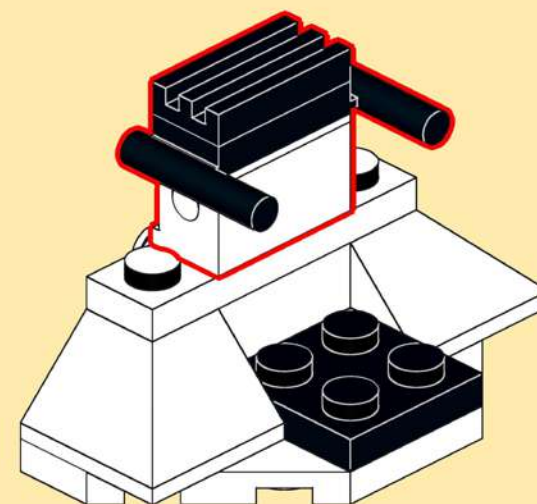
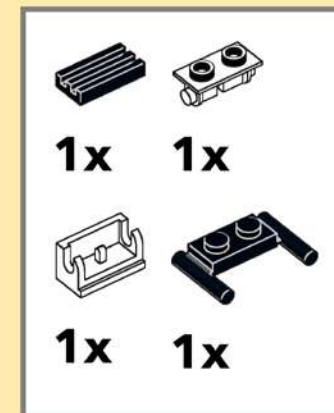

20

