

6066 Back B - Forestmen Windmill

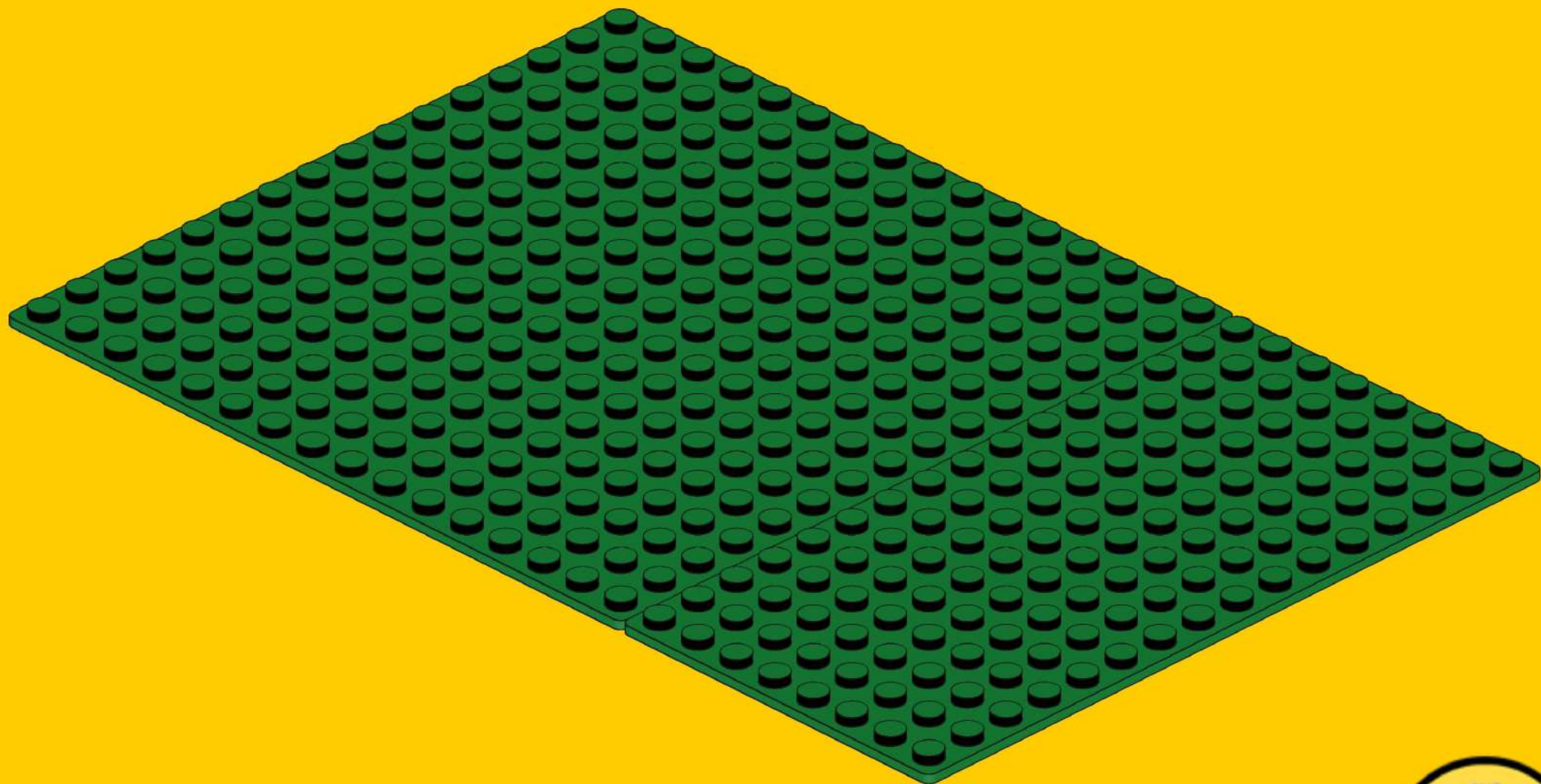

1



2

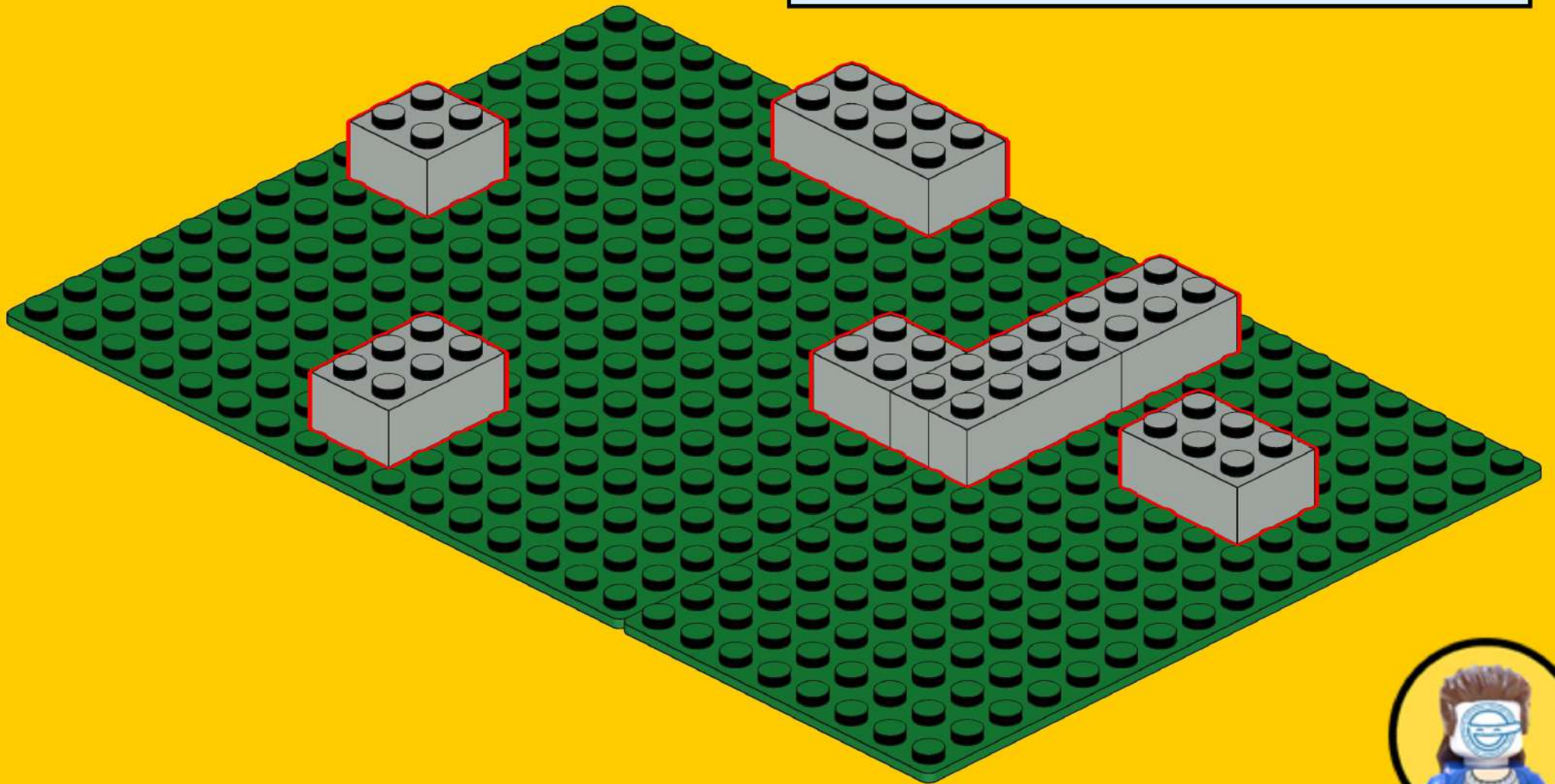
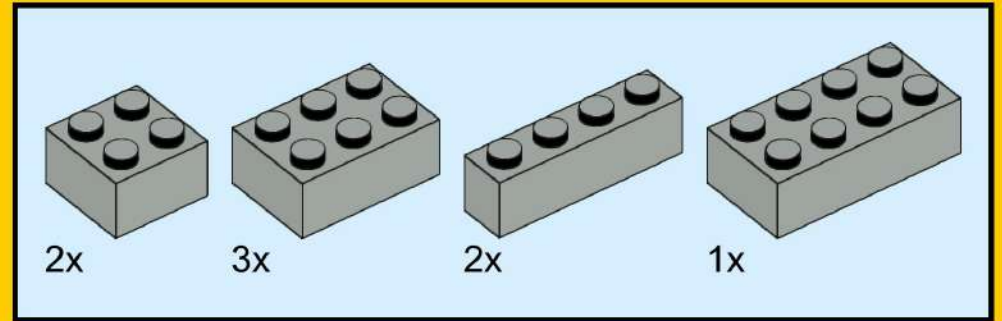

3

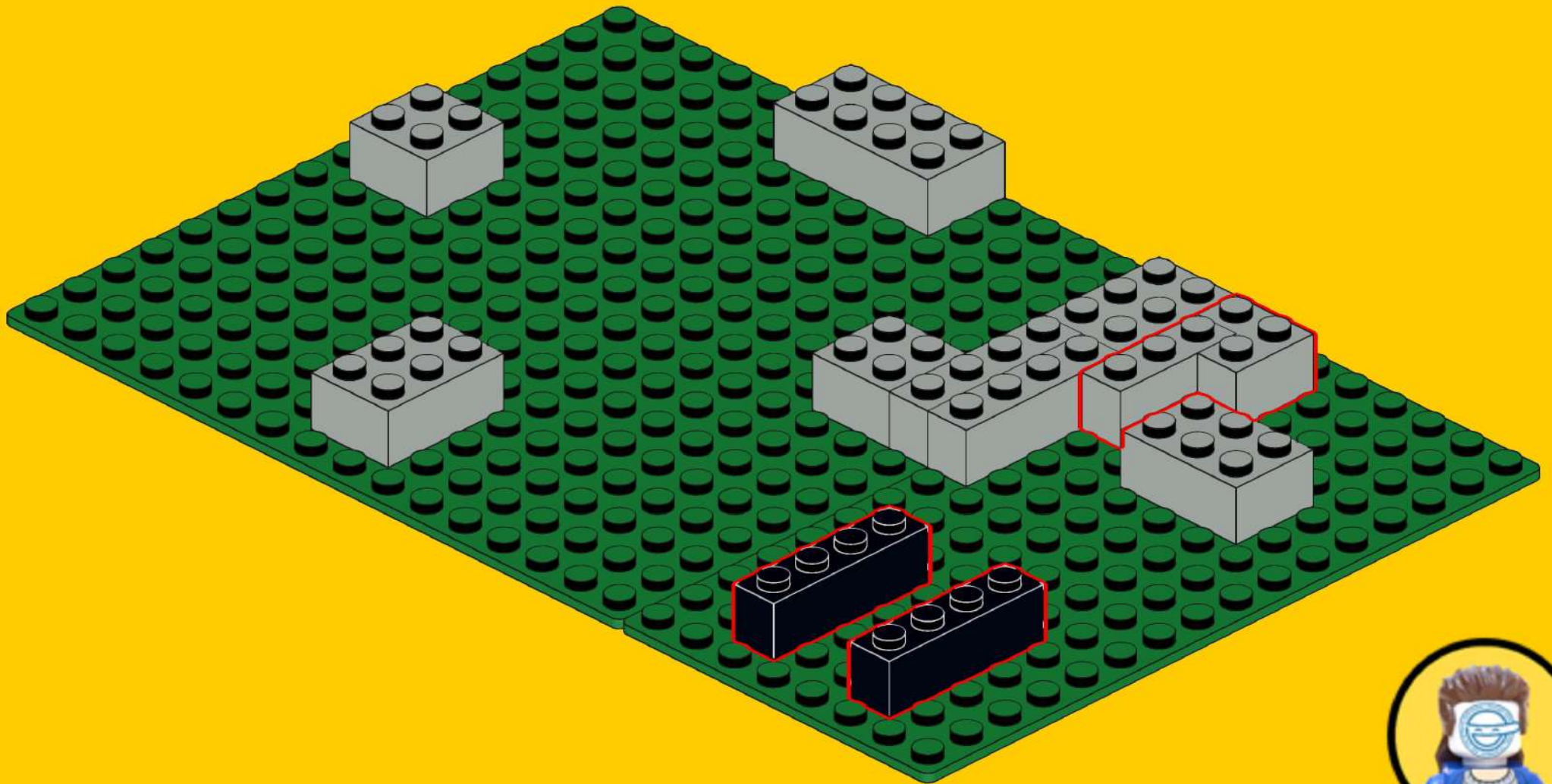
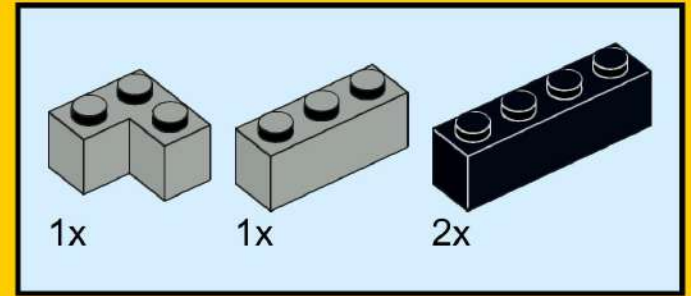

4

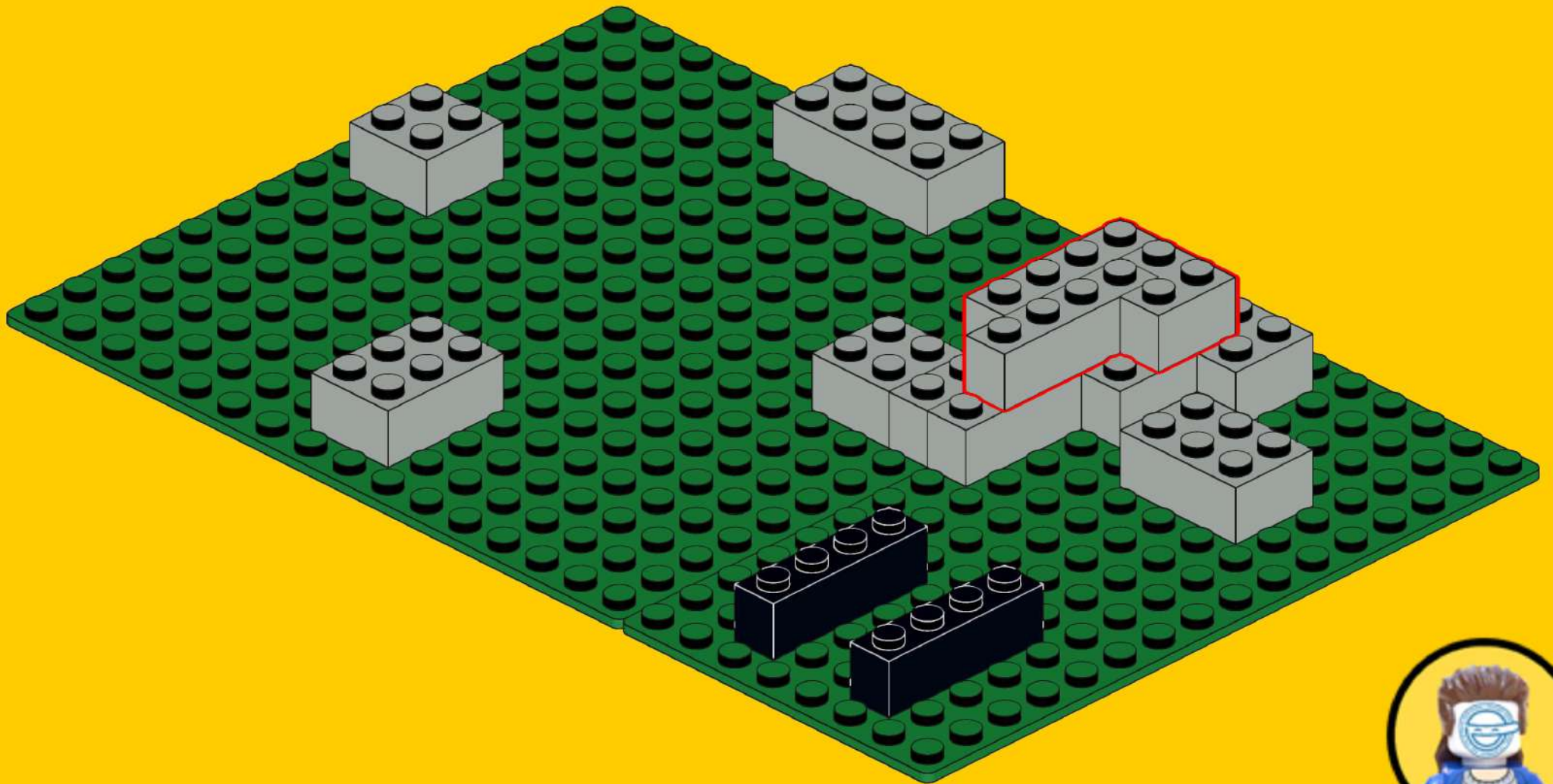
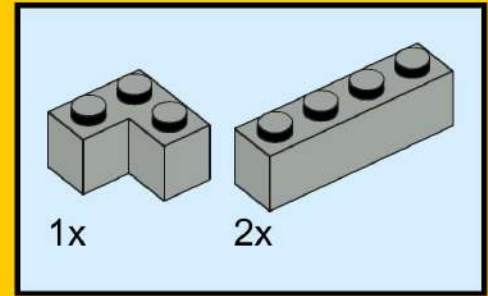

5

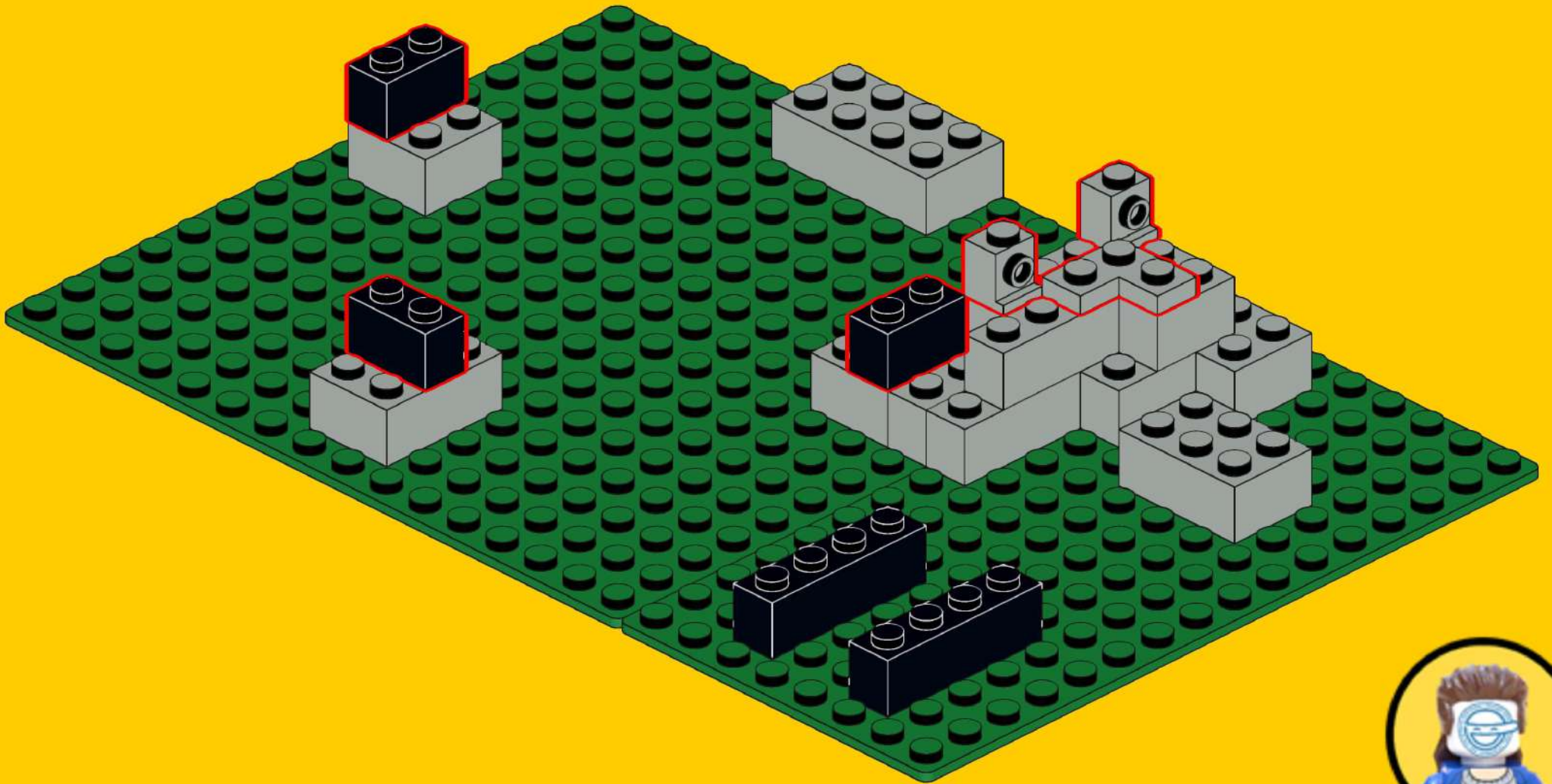
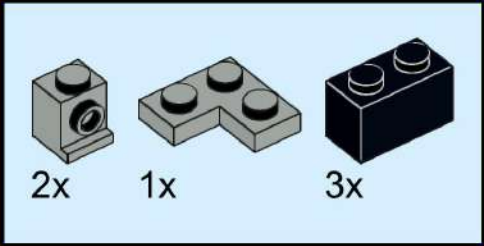

6

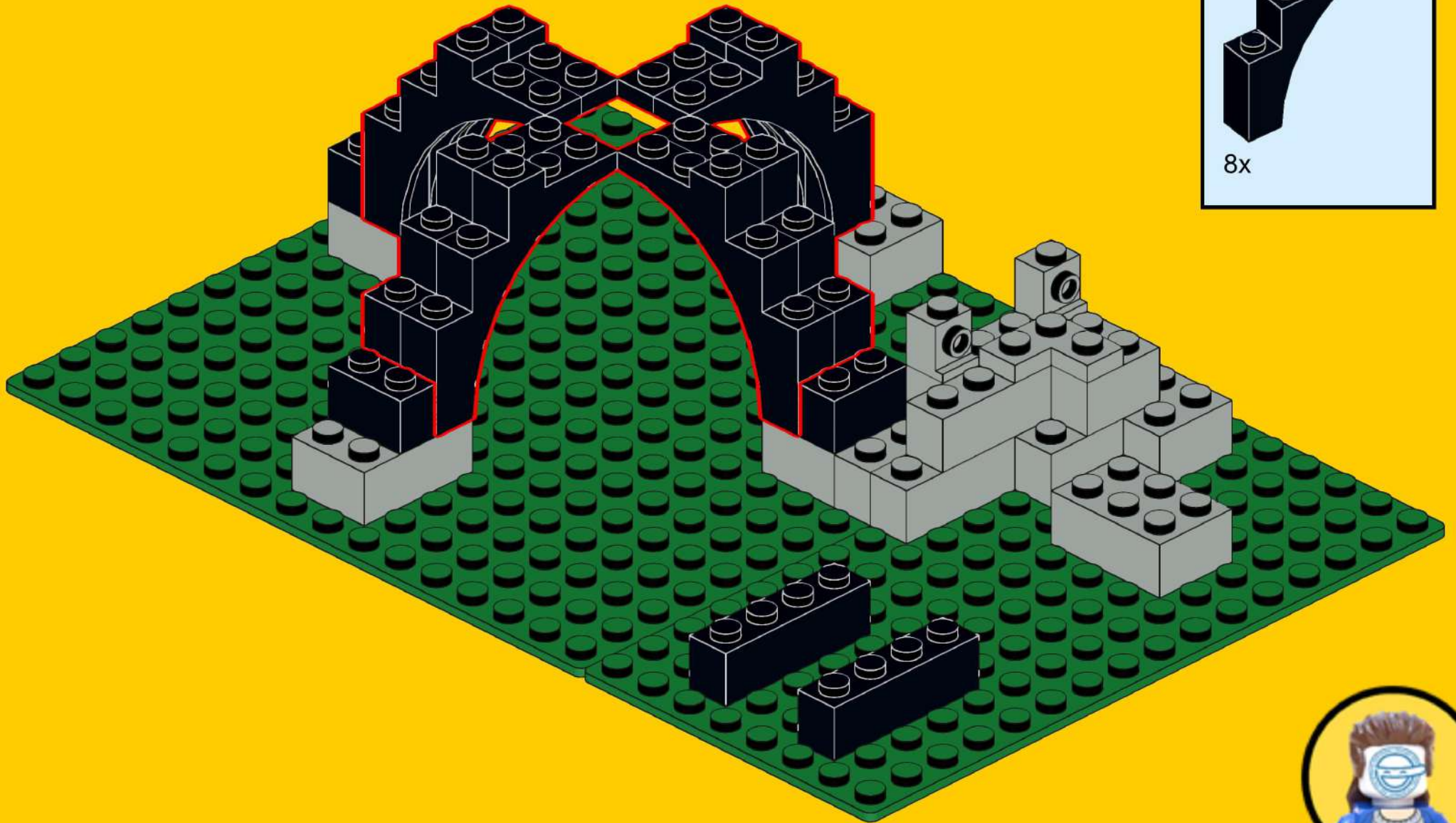

7

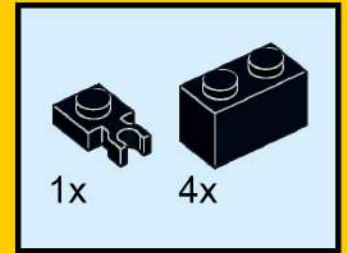

8

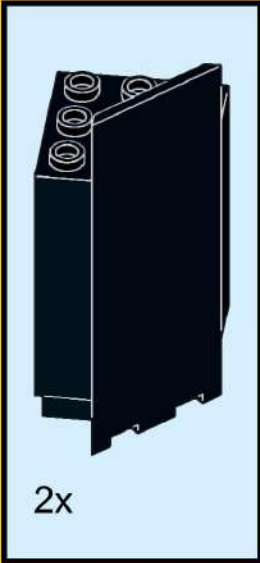
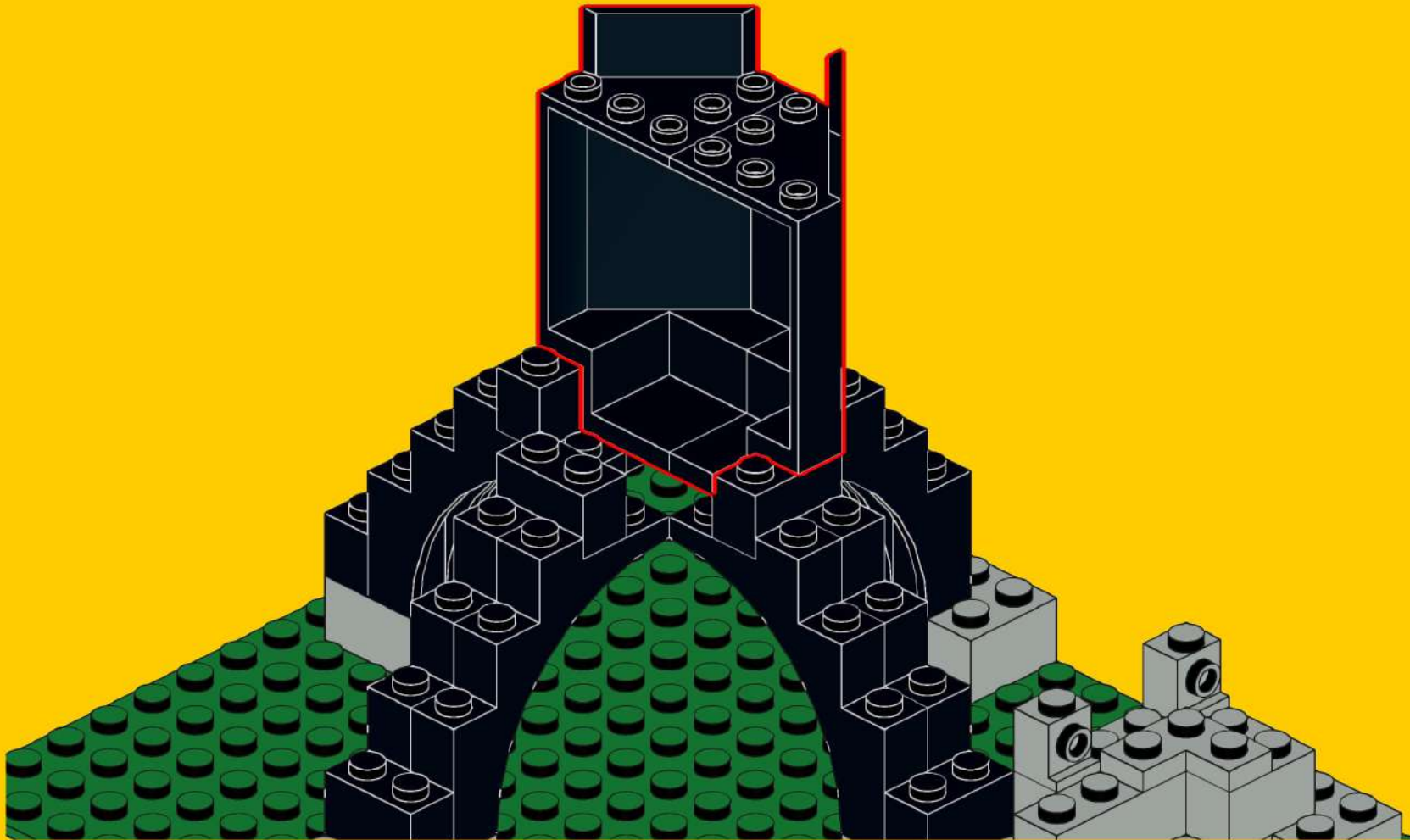

9

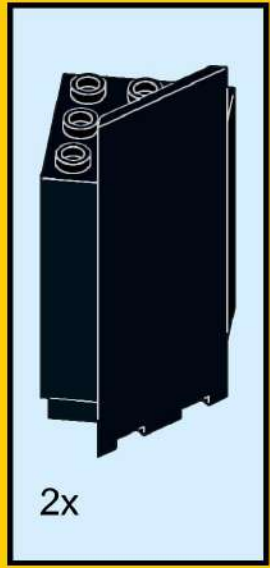
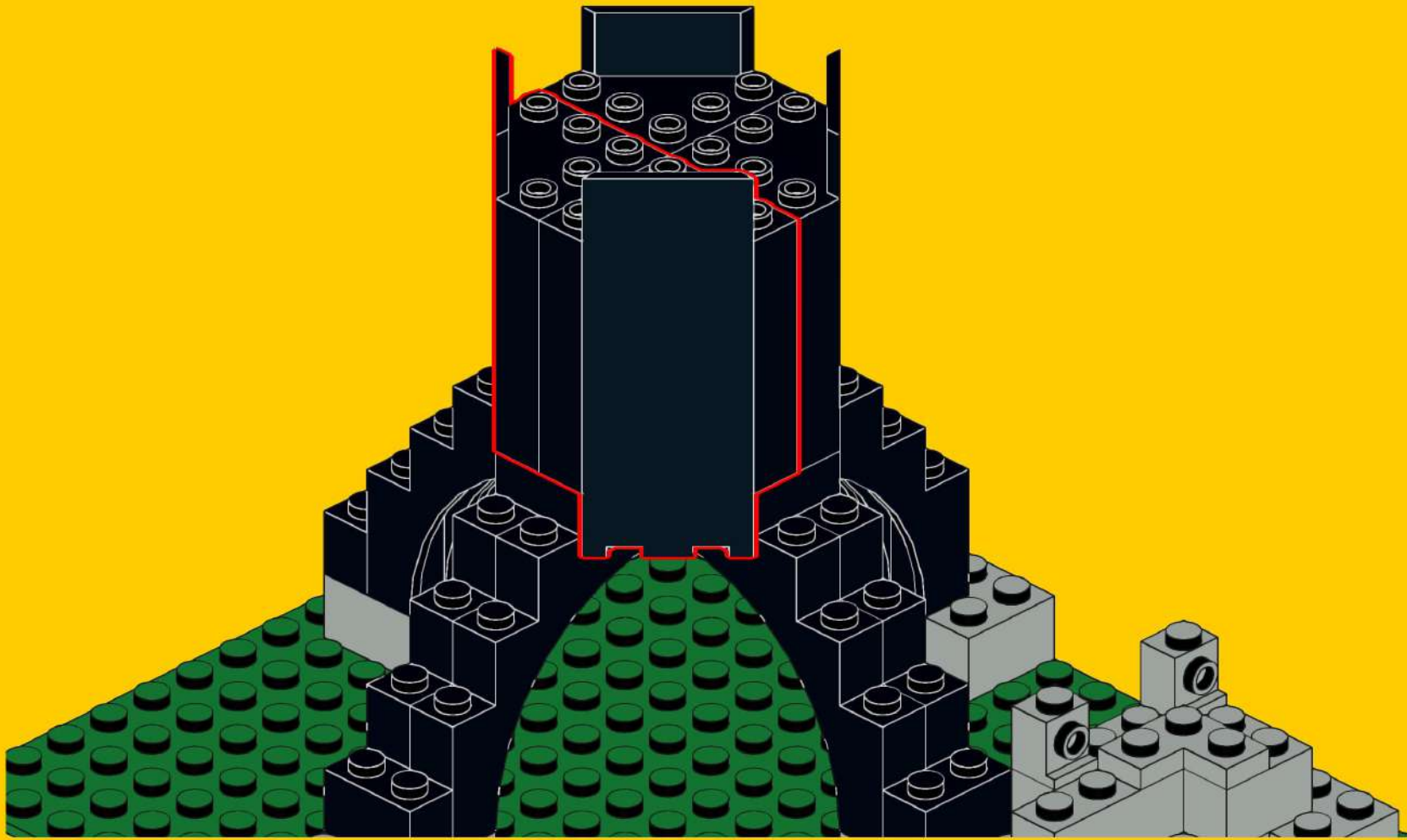

10

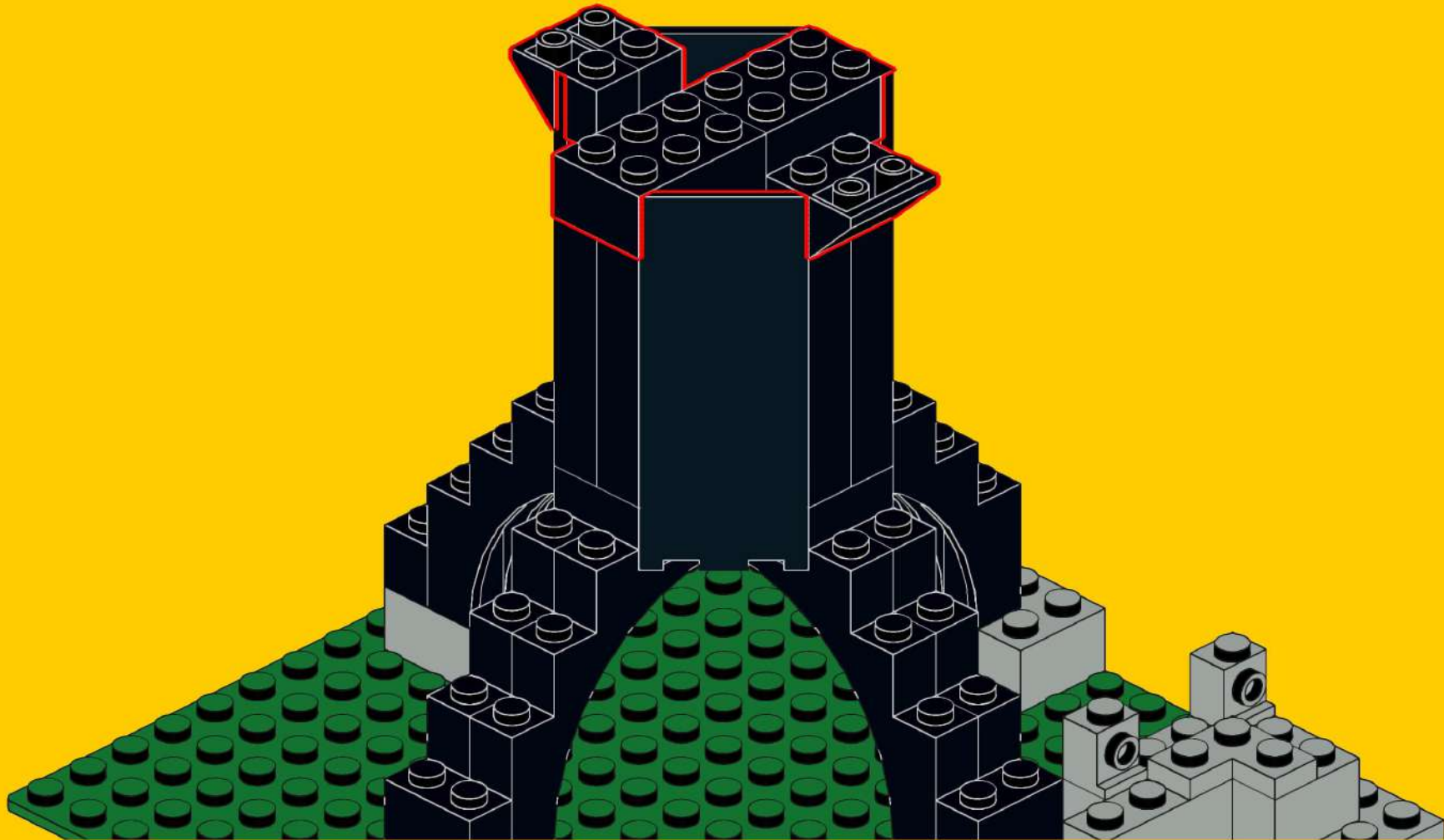
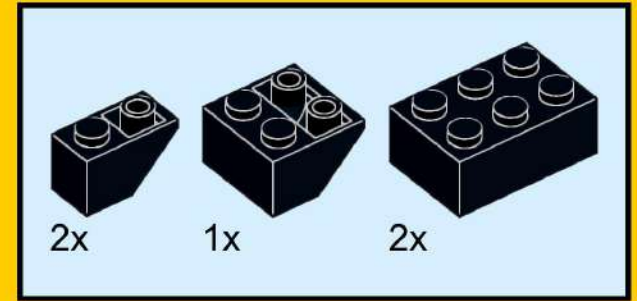

11

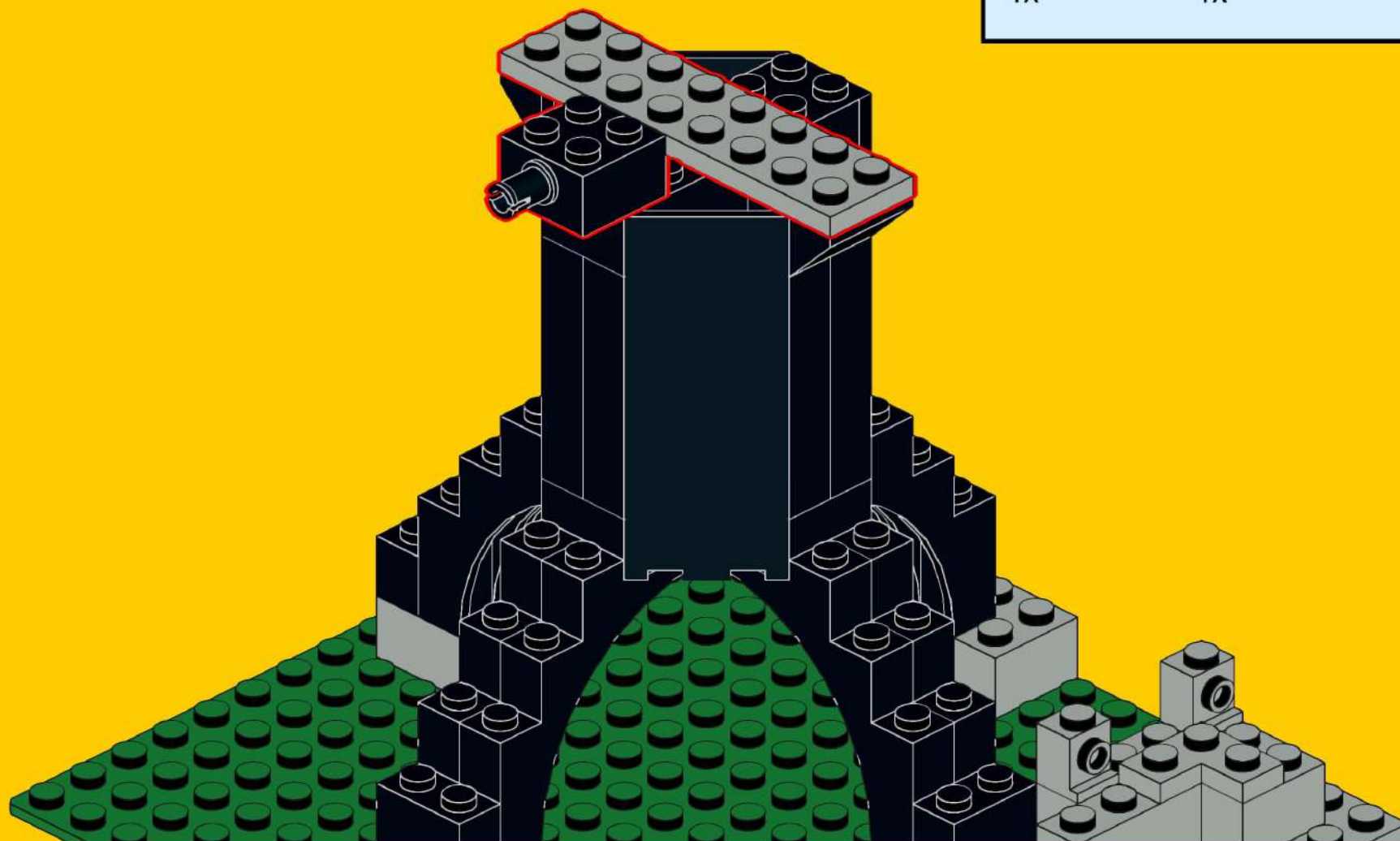
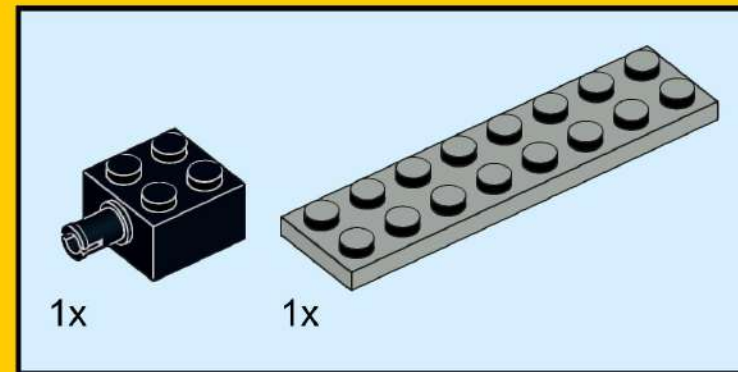

12

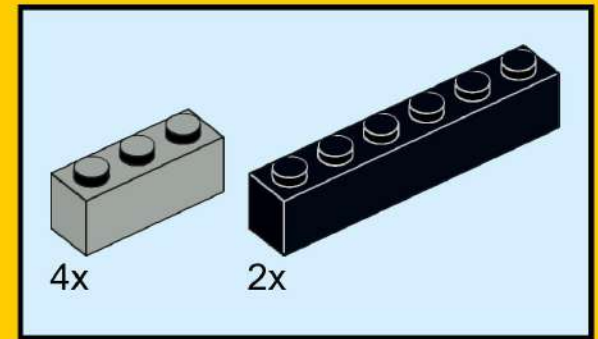

13

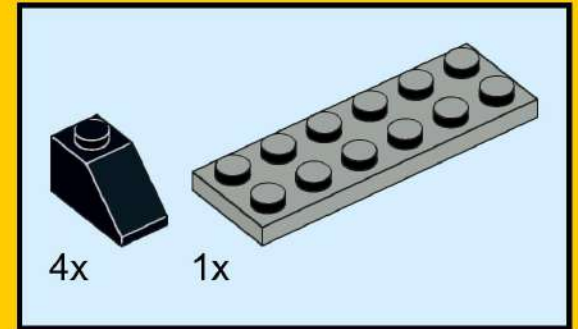

14

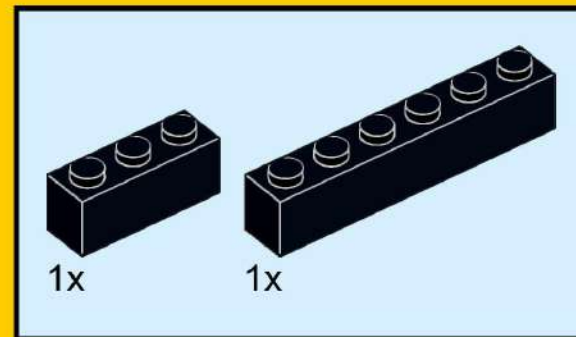

15

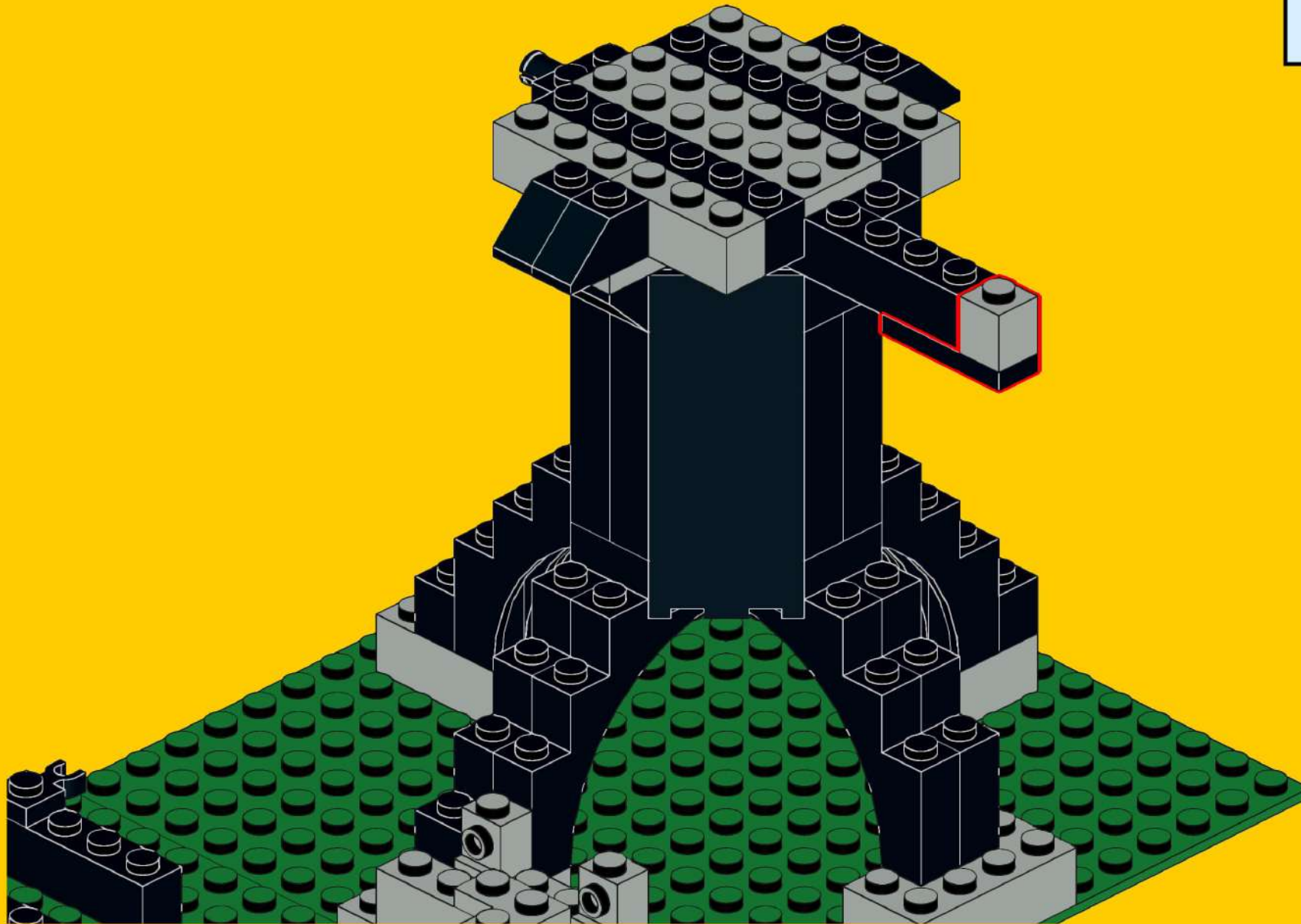
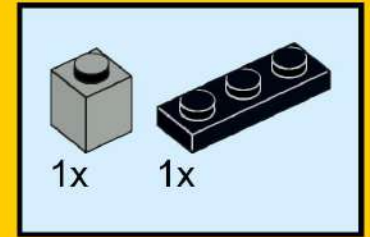

16

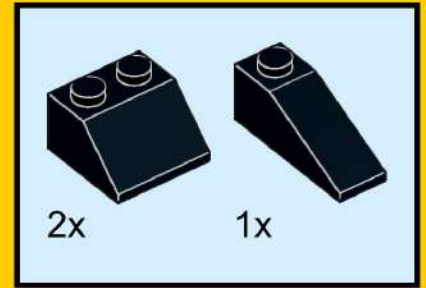
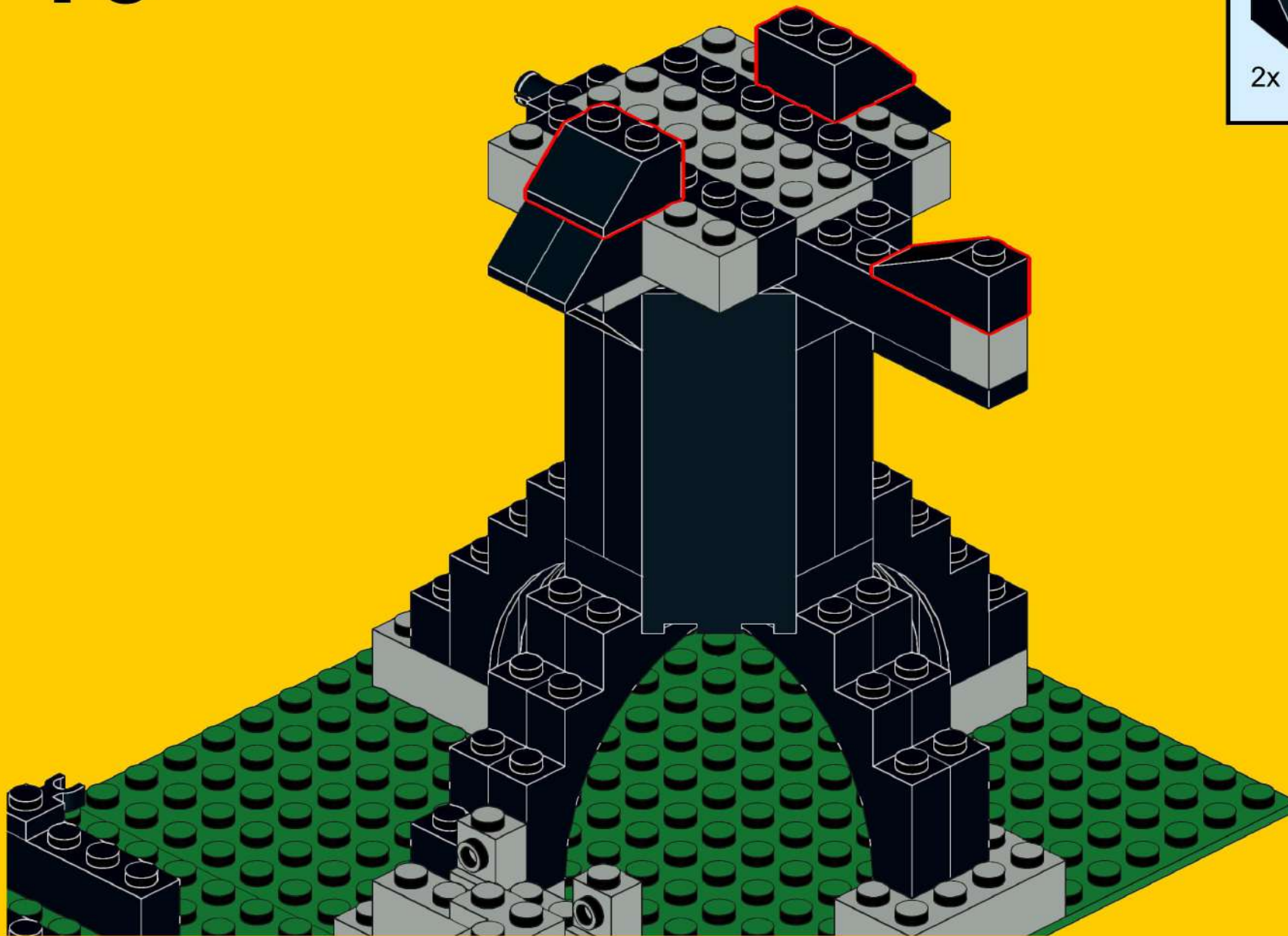

17

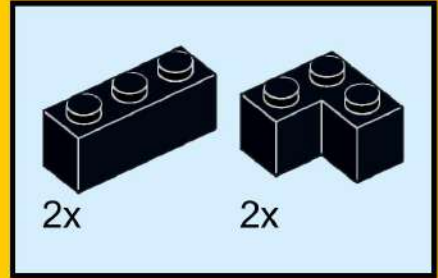
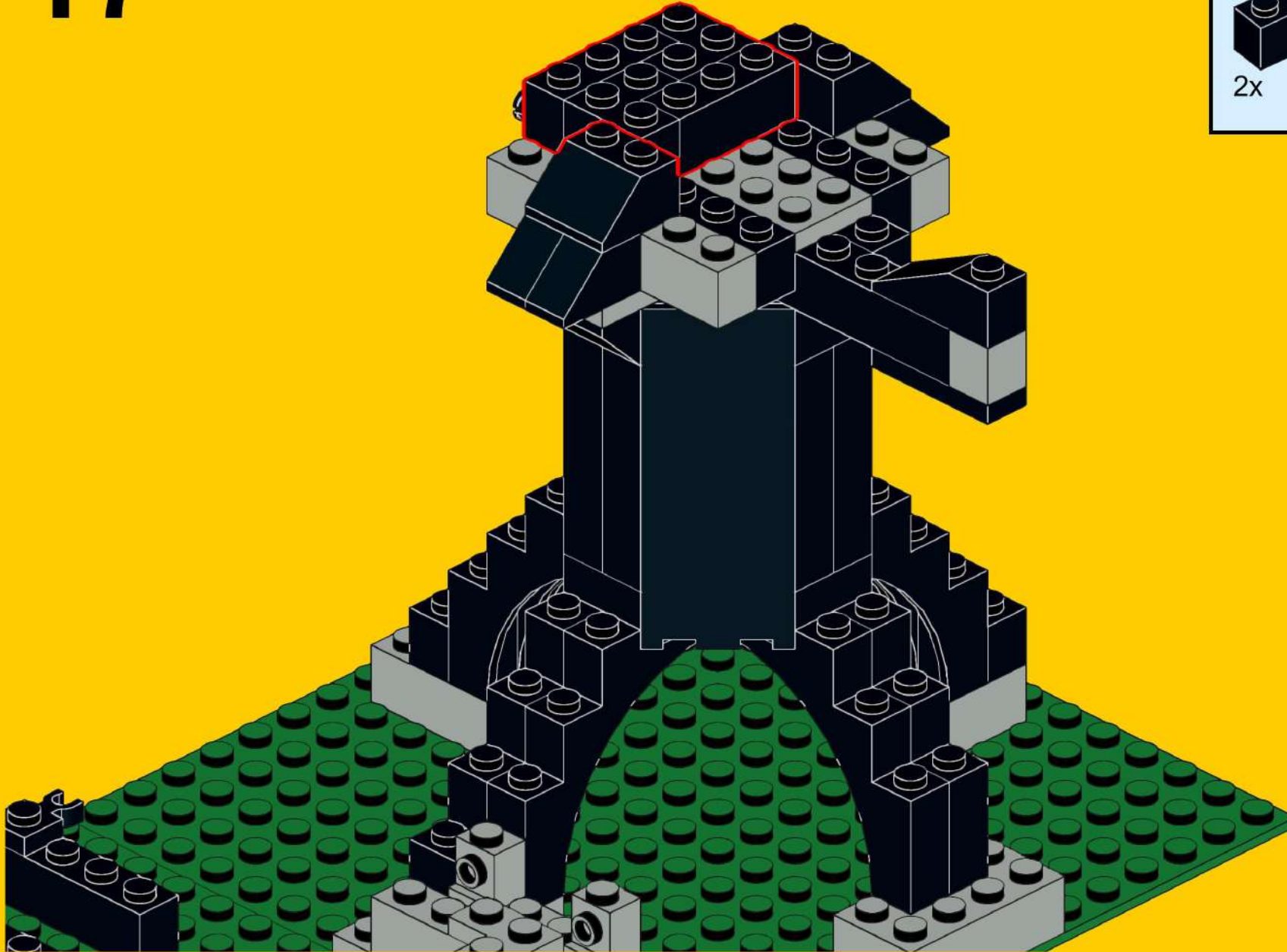

18

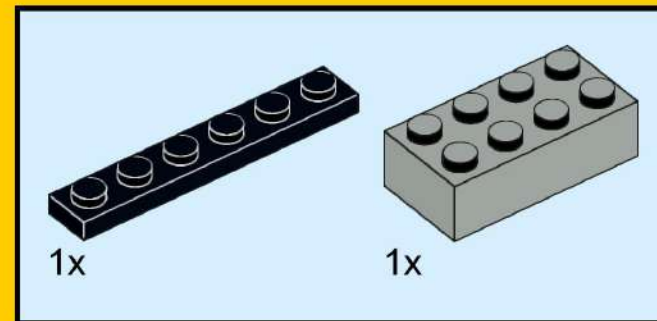
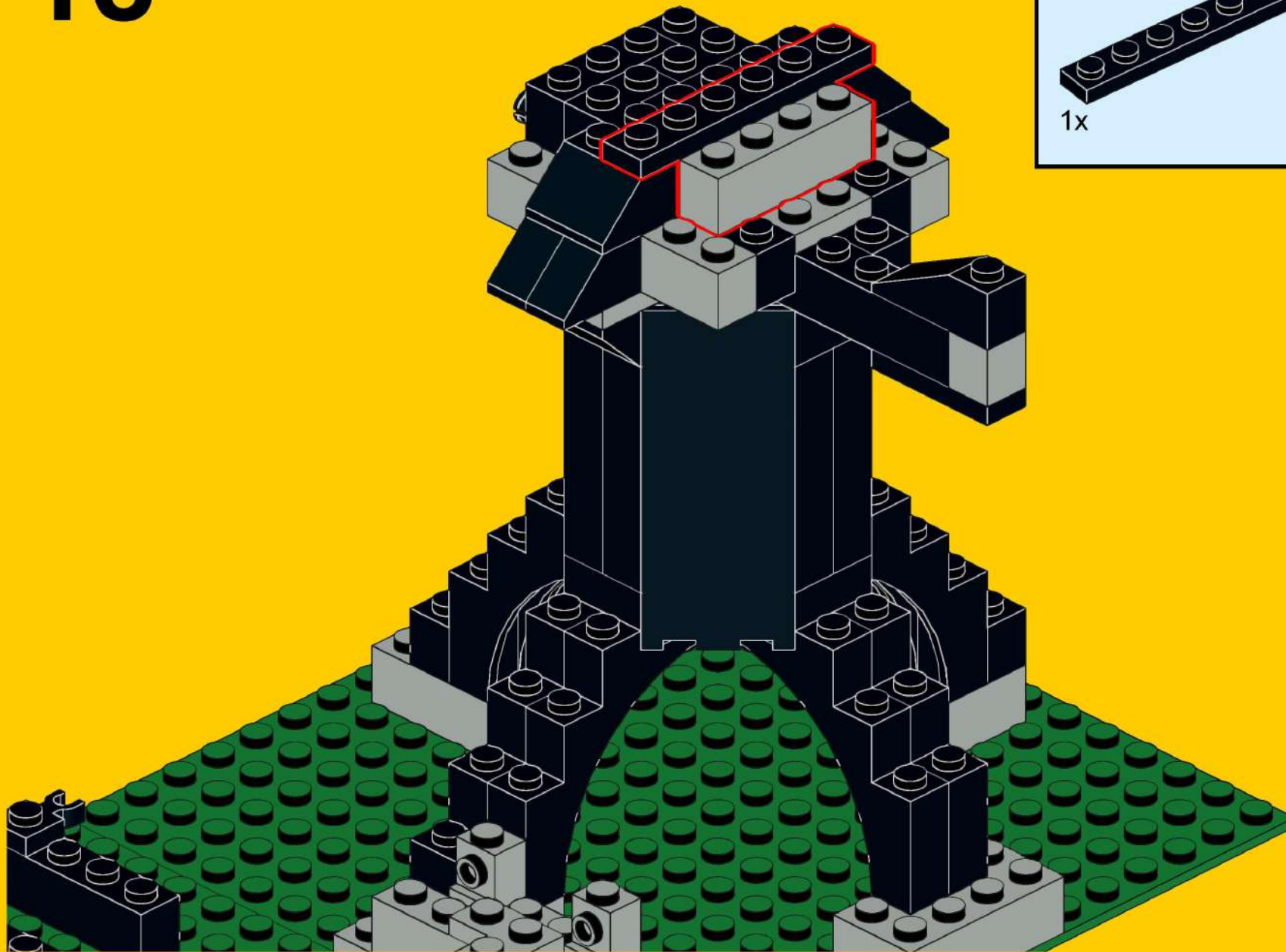

19

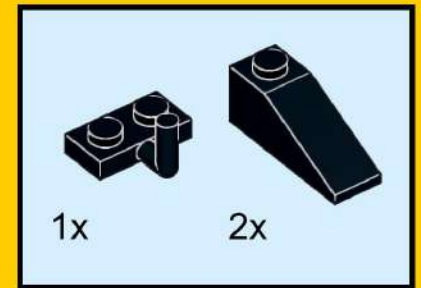
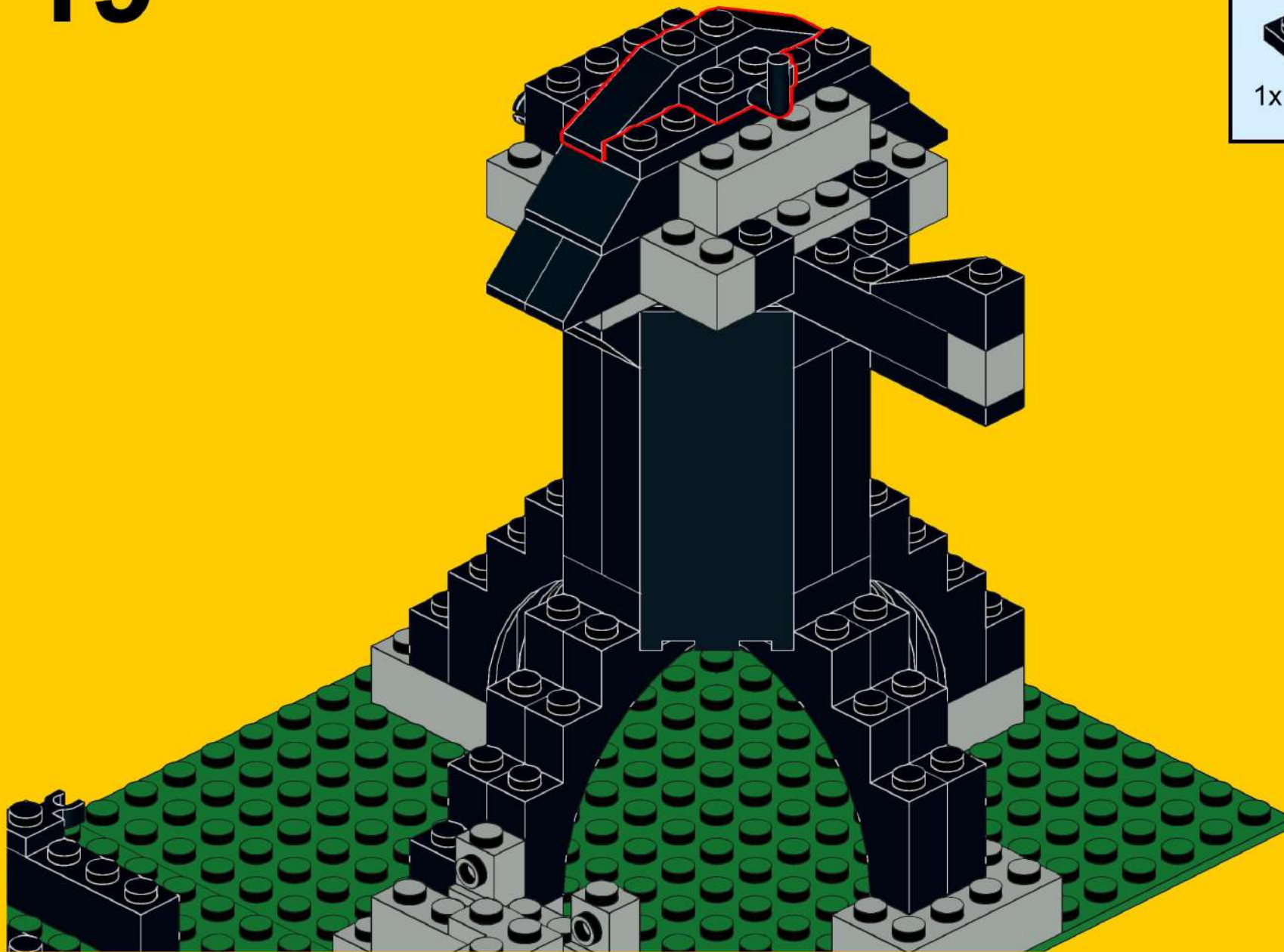

20

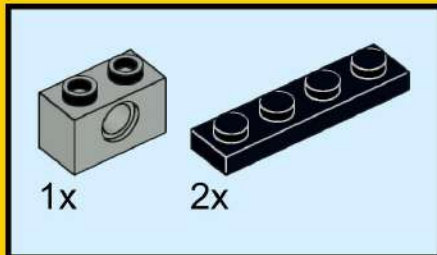
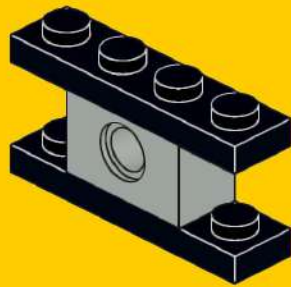
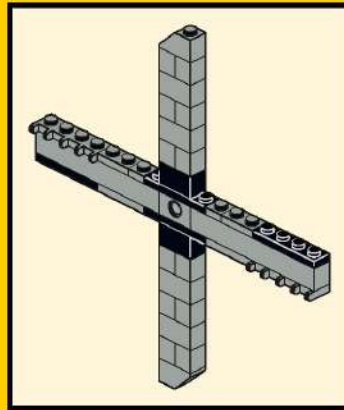

21

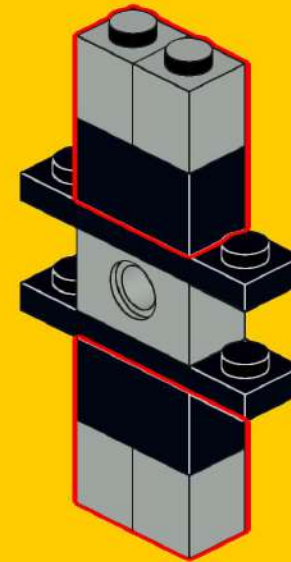
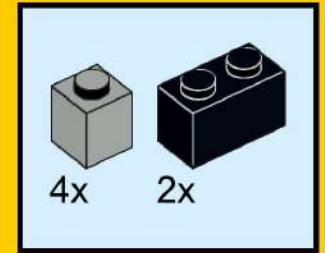

22

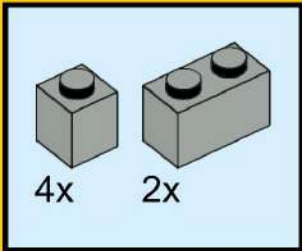
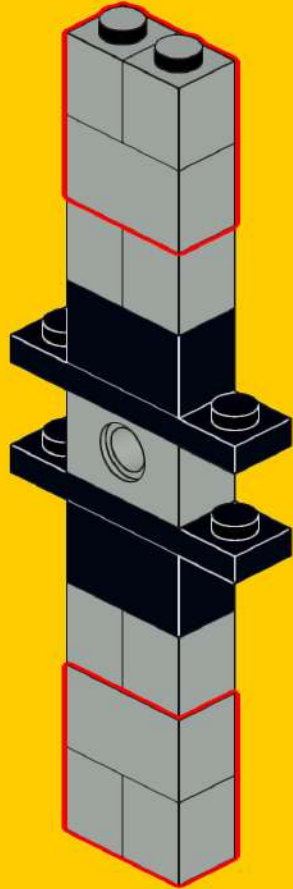

23

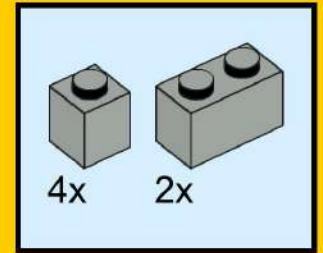
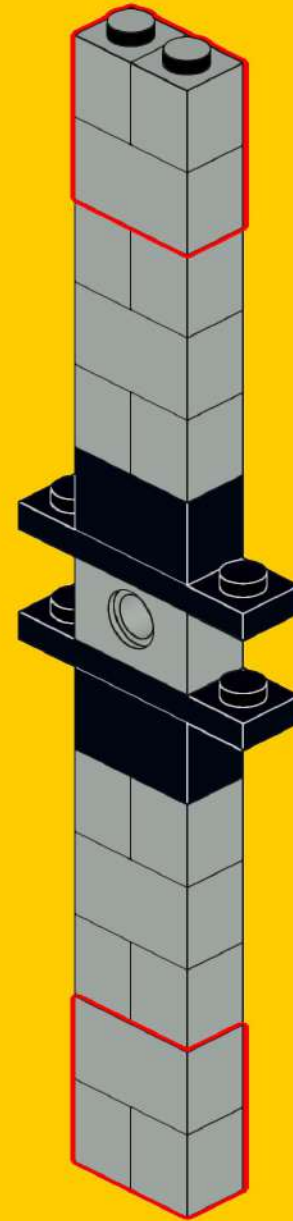

24

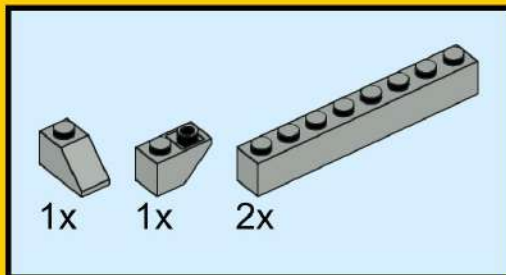
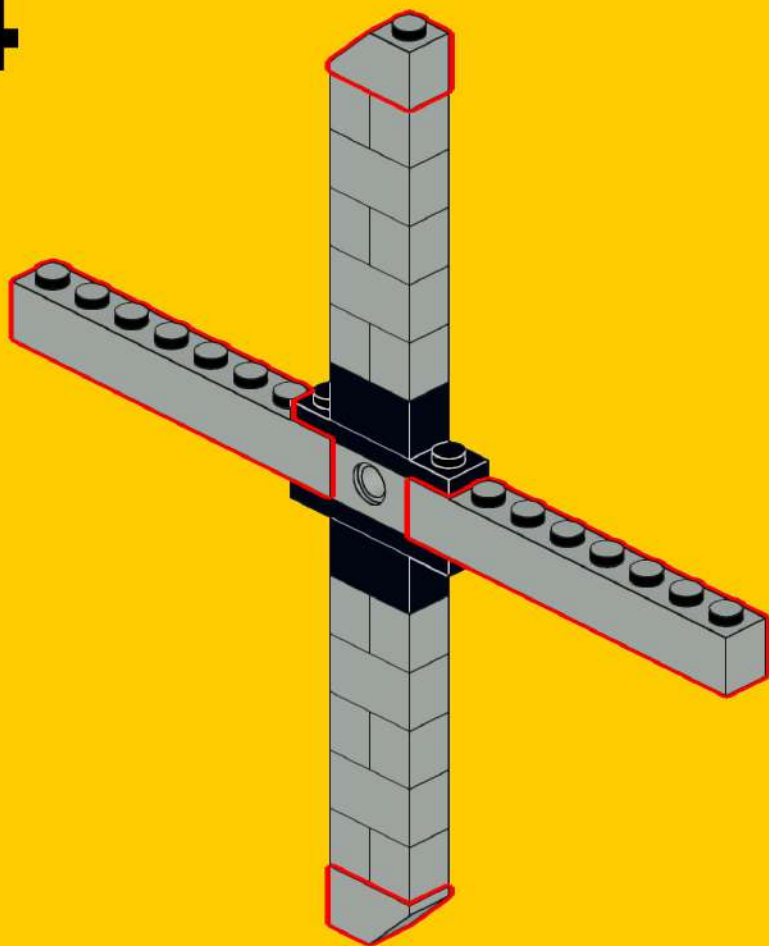

25

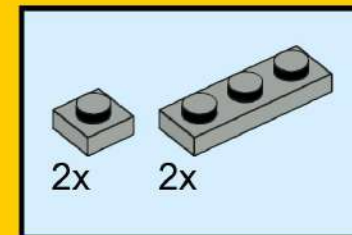
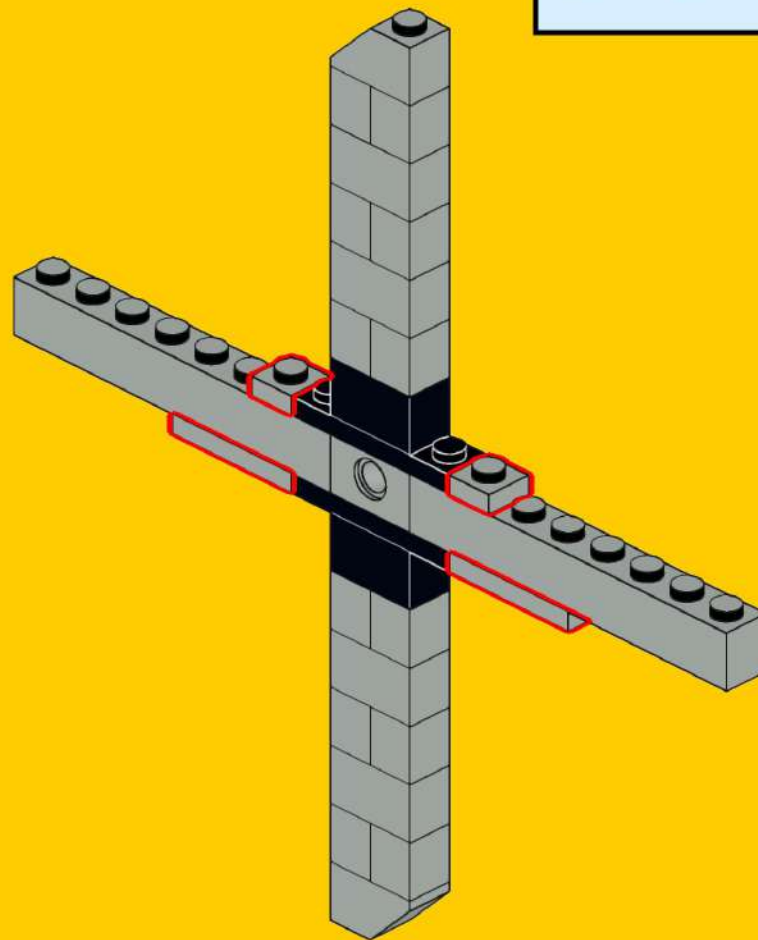

26

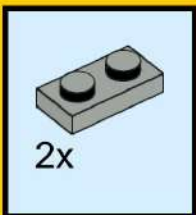
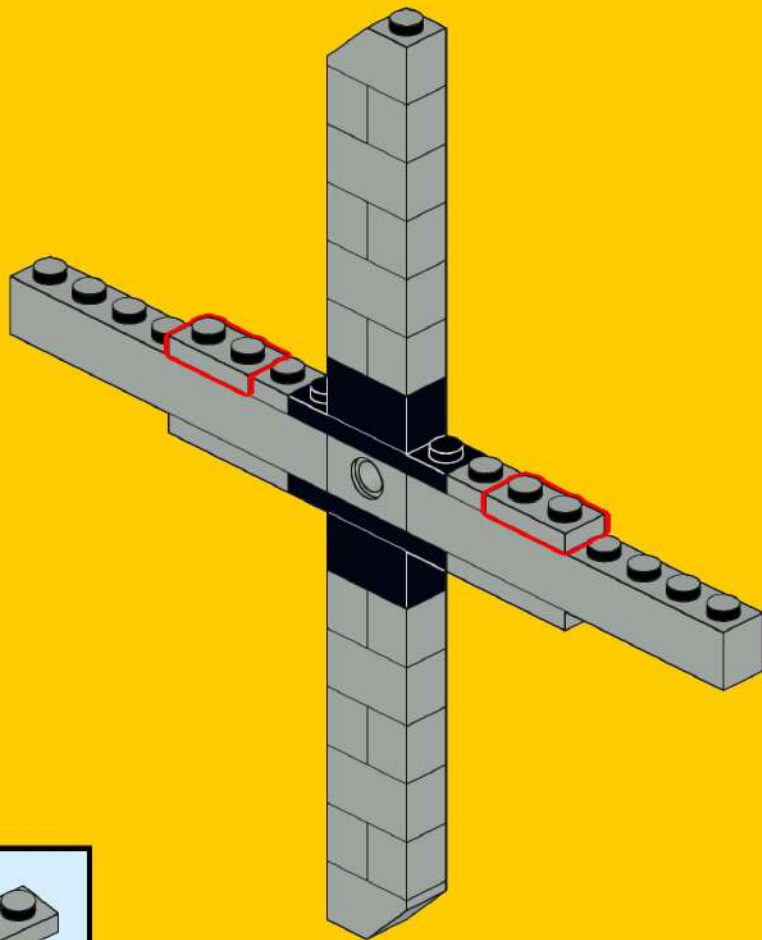

27

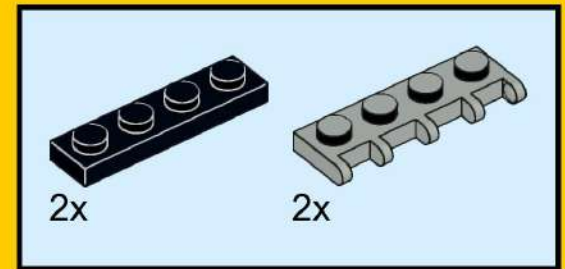
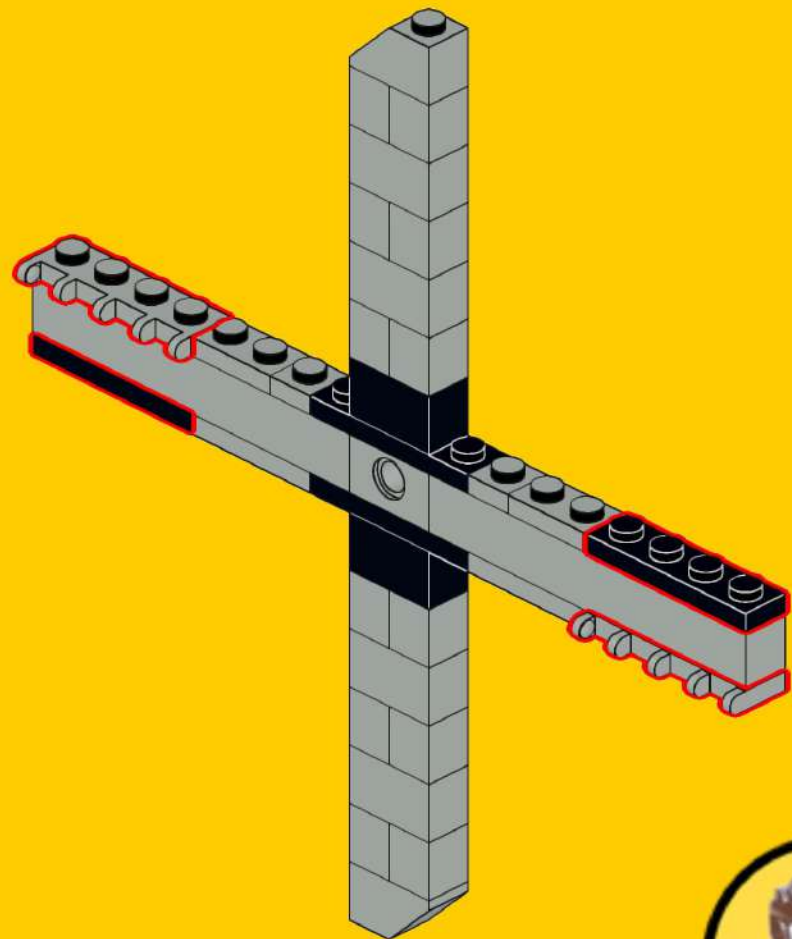

28



29

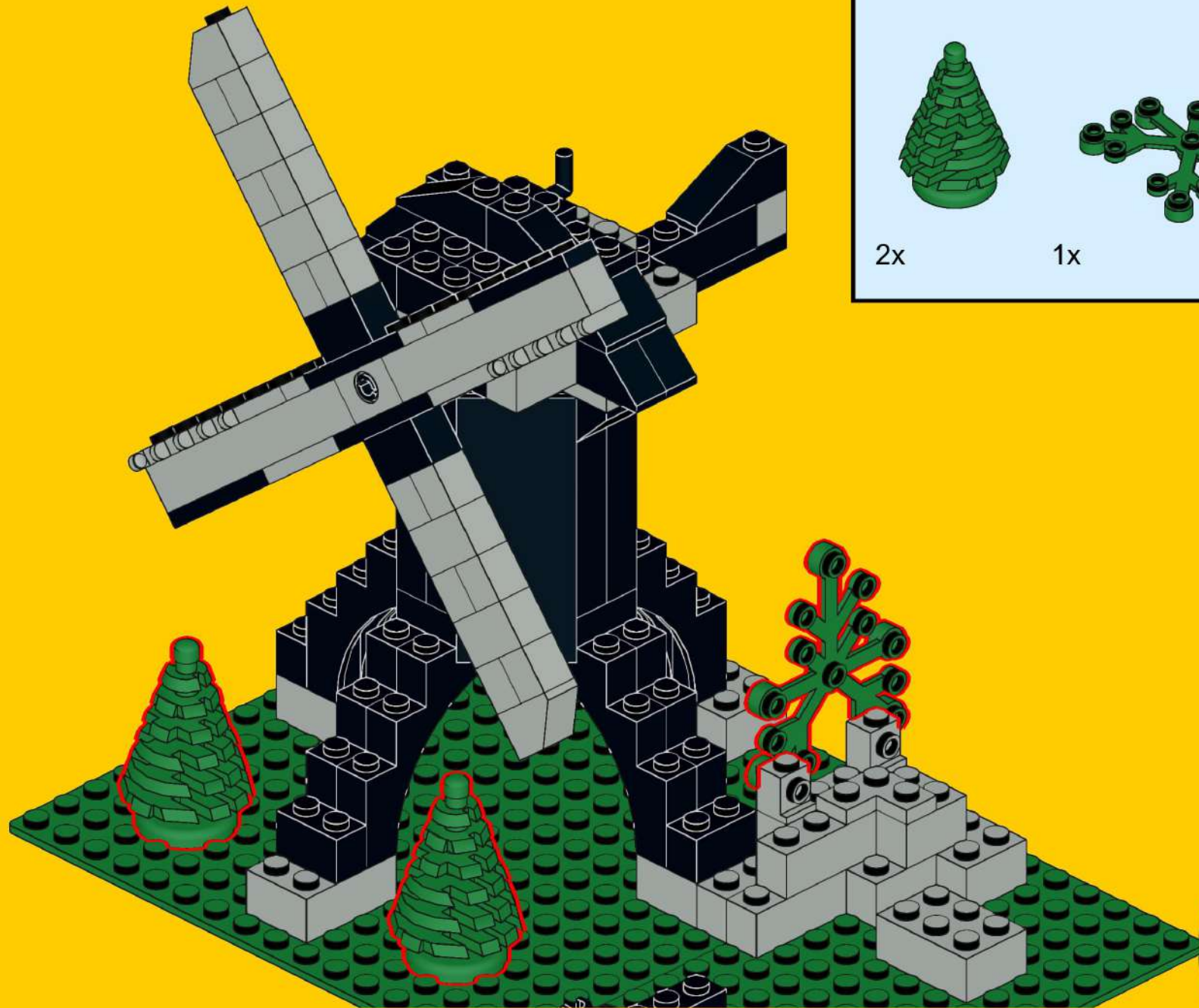

30

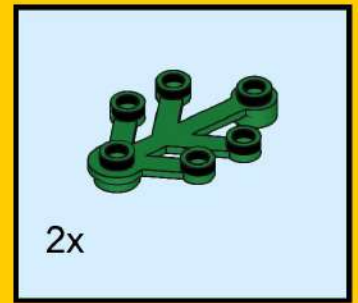

31



32



33



34



35



36



37

