

6683-1 Back of the box build 3

Burger stand

Instructions by se1977



1

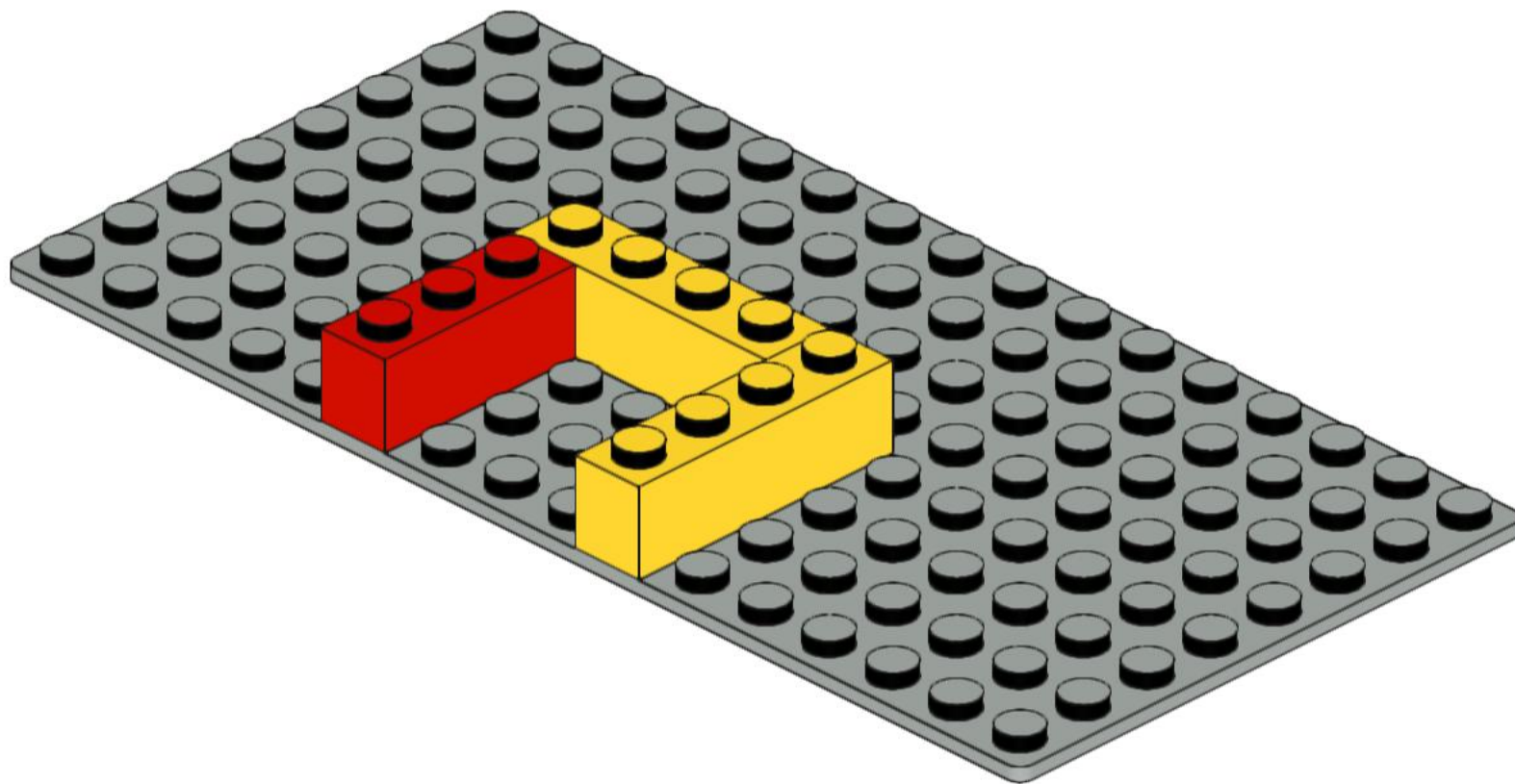

2

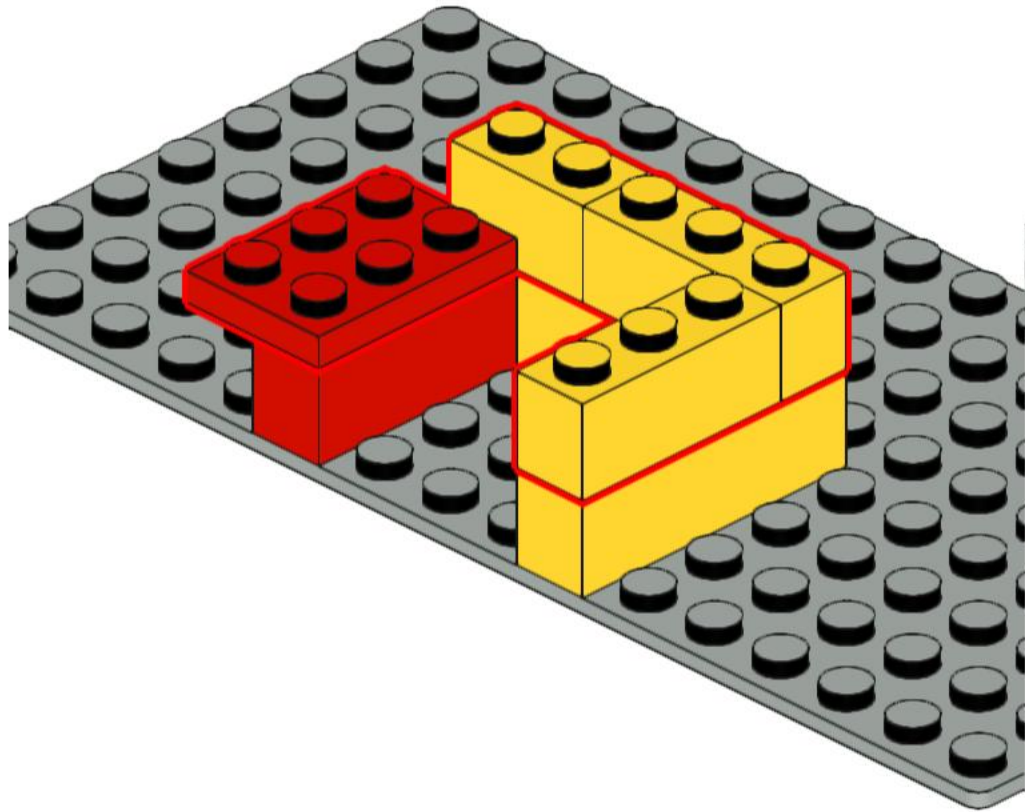
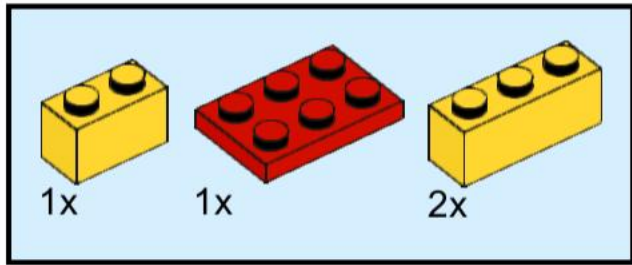

3

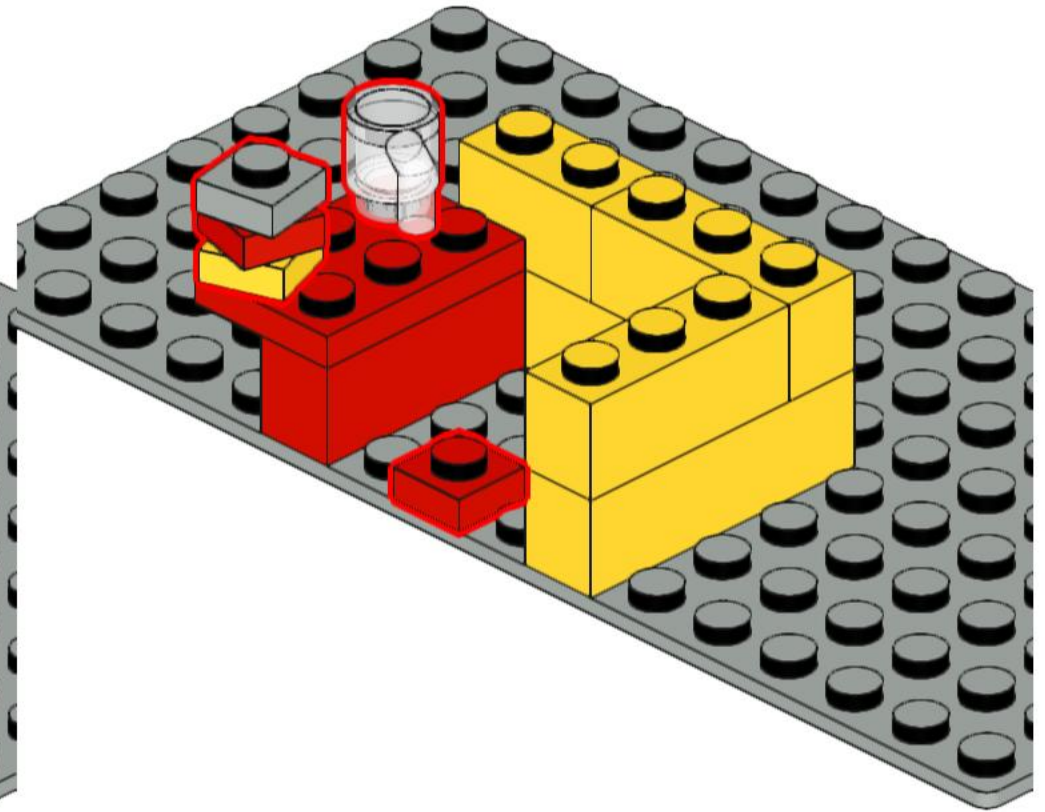
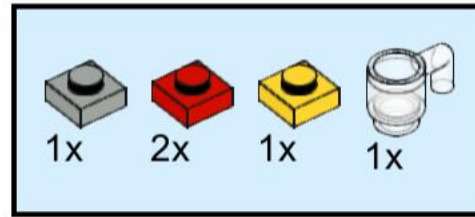

4

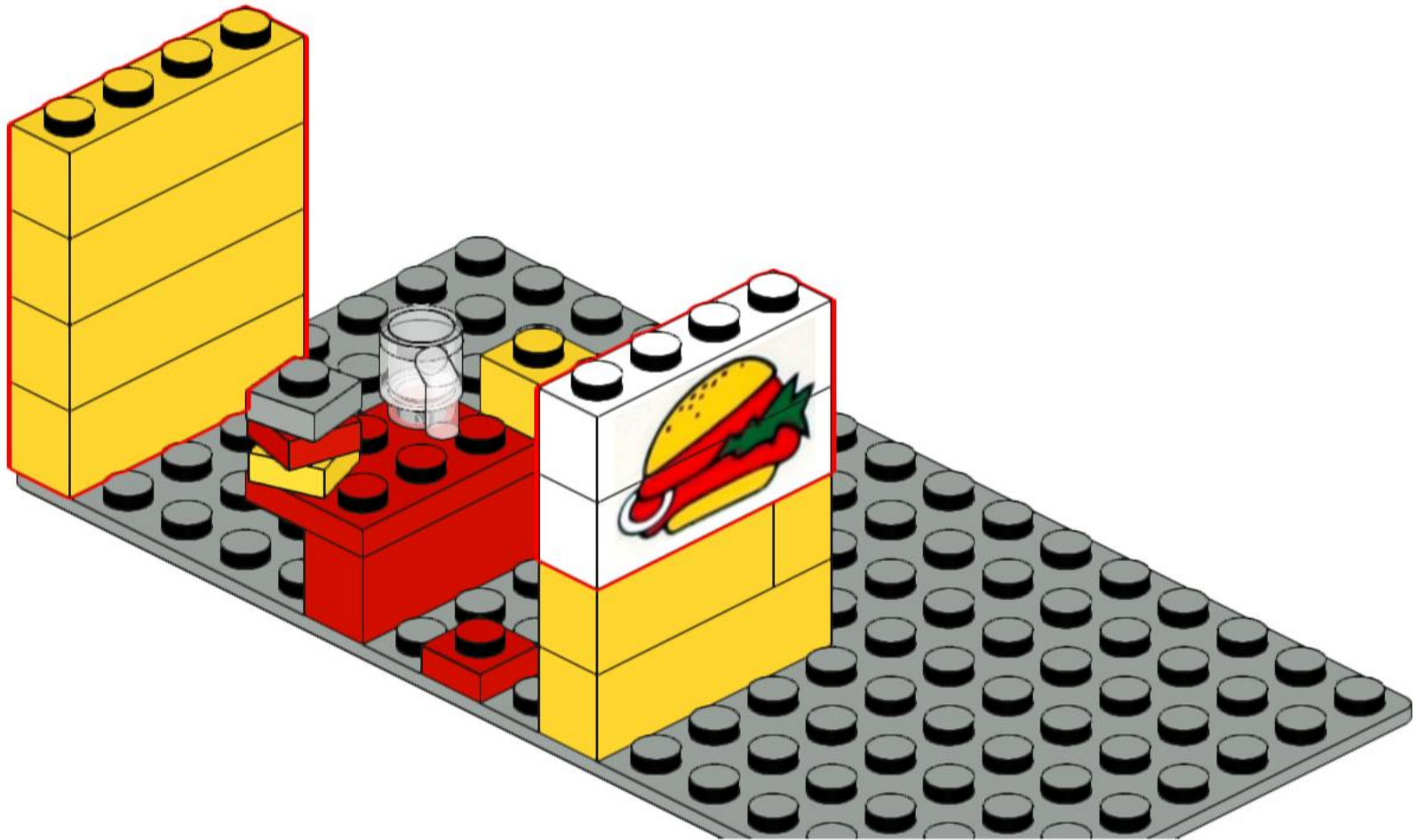
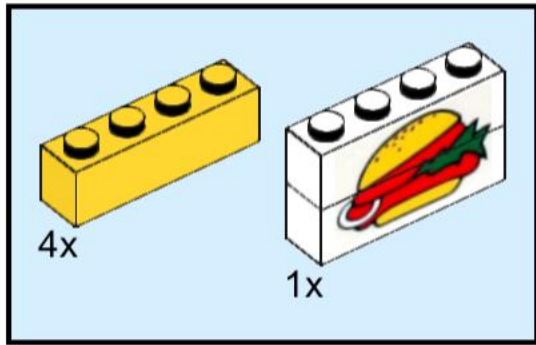

5

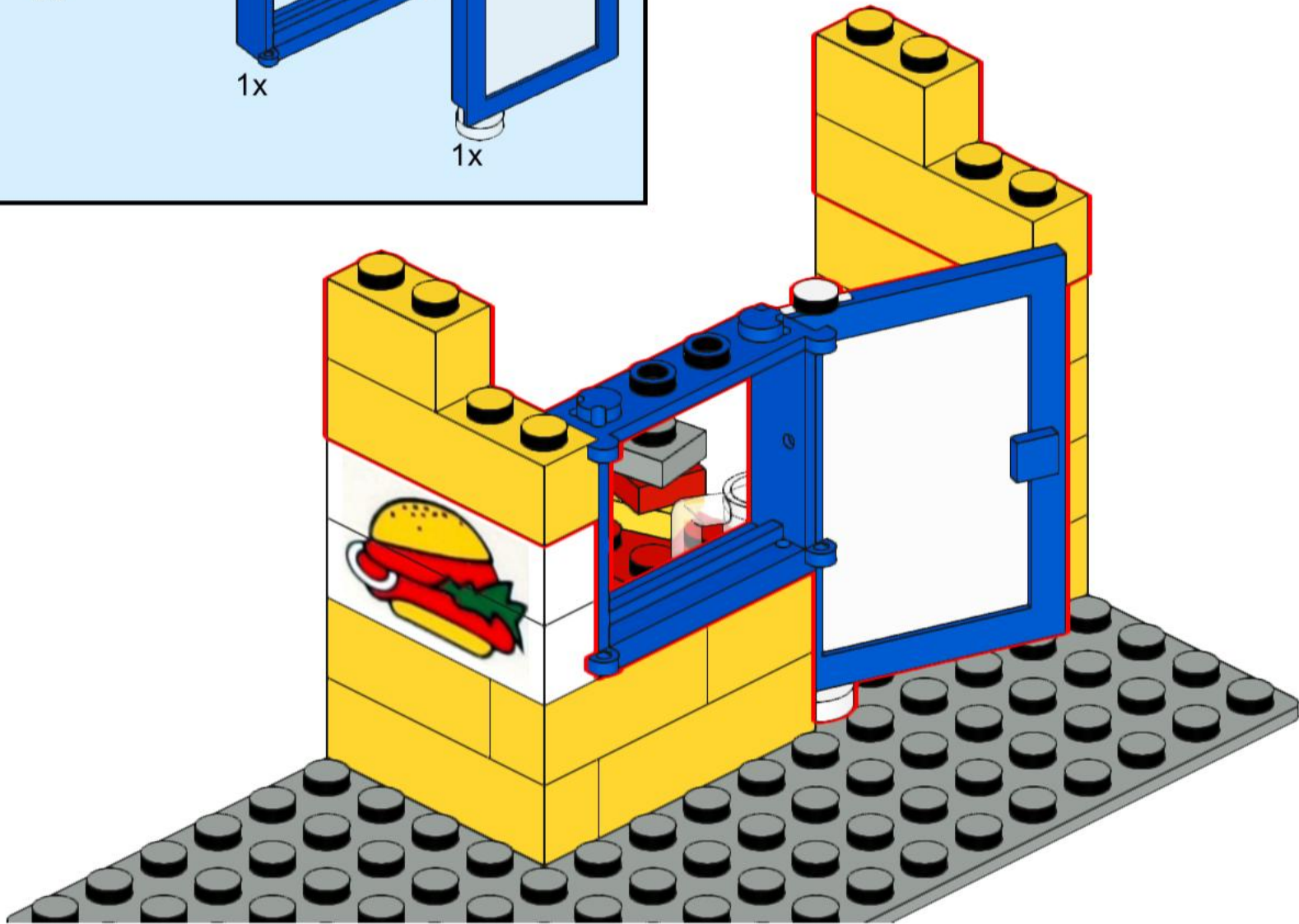
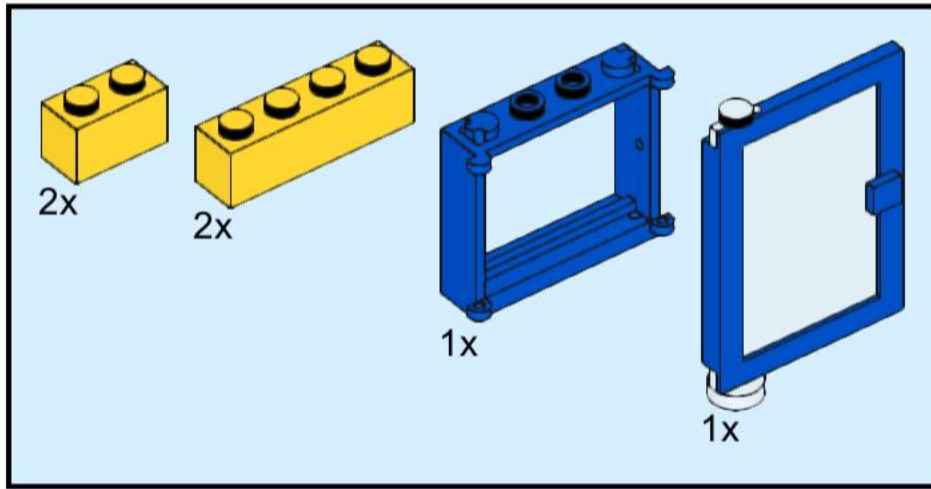

6

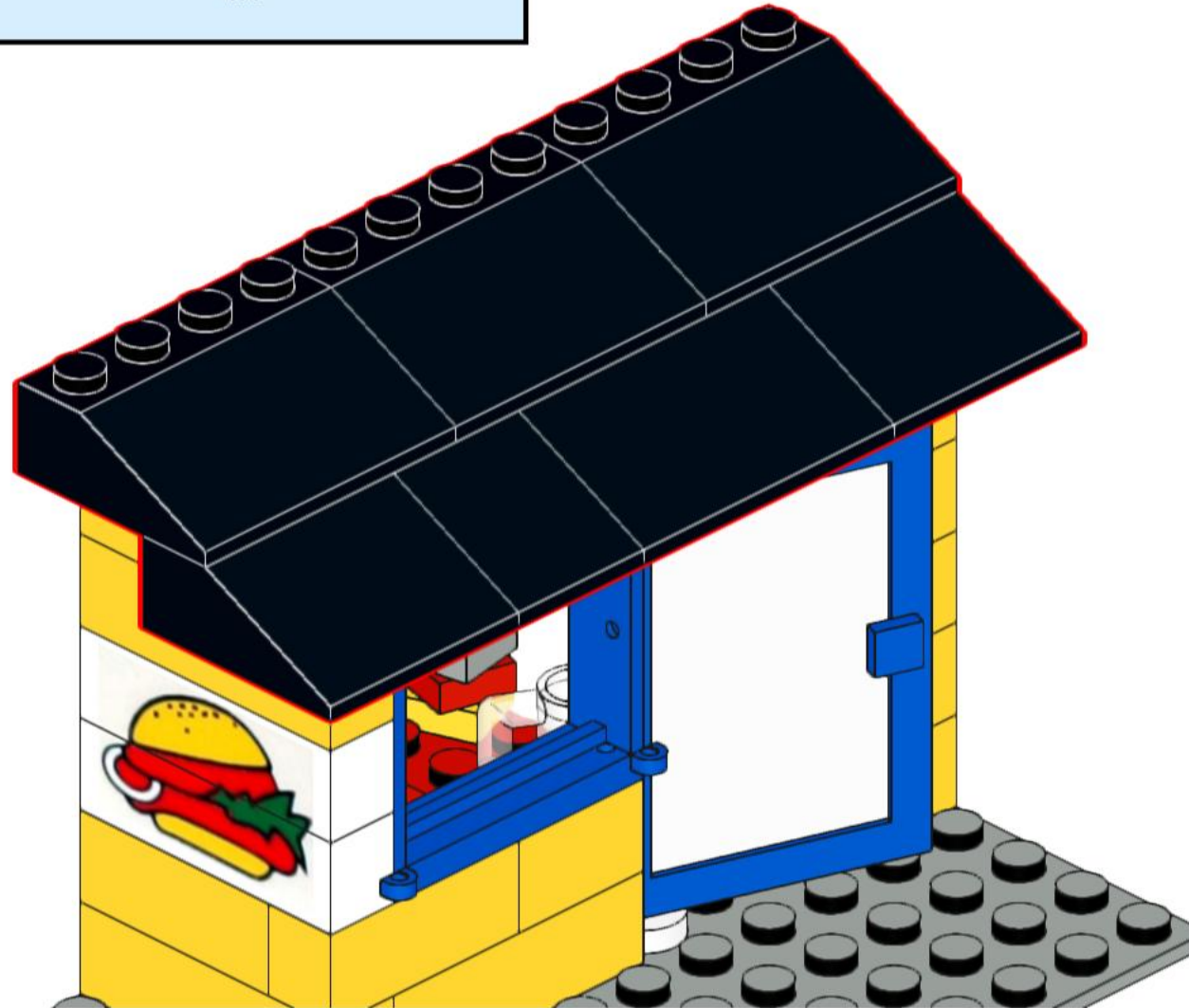
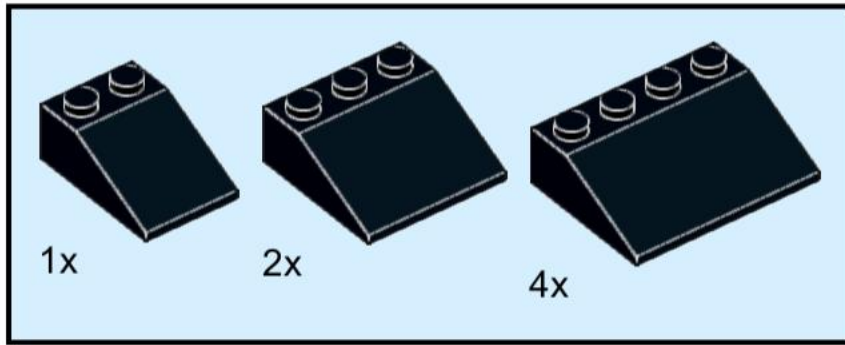

7

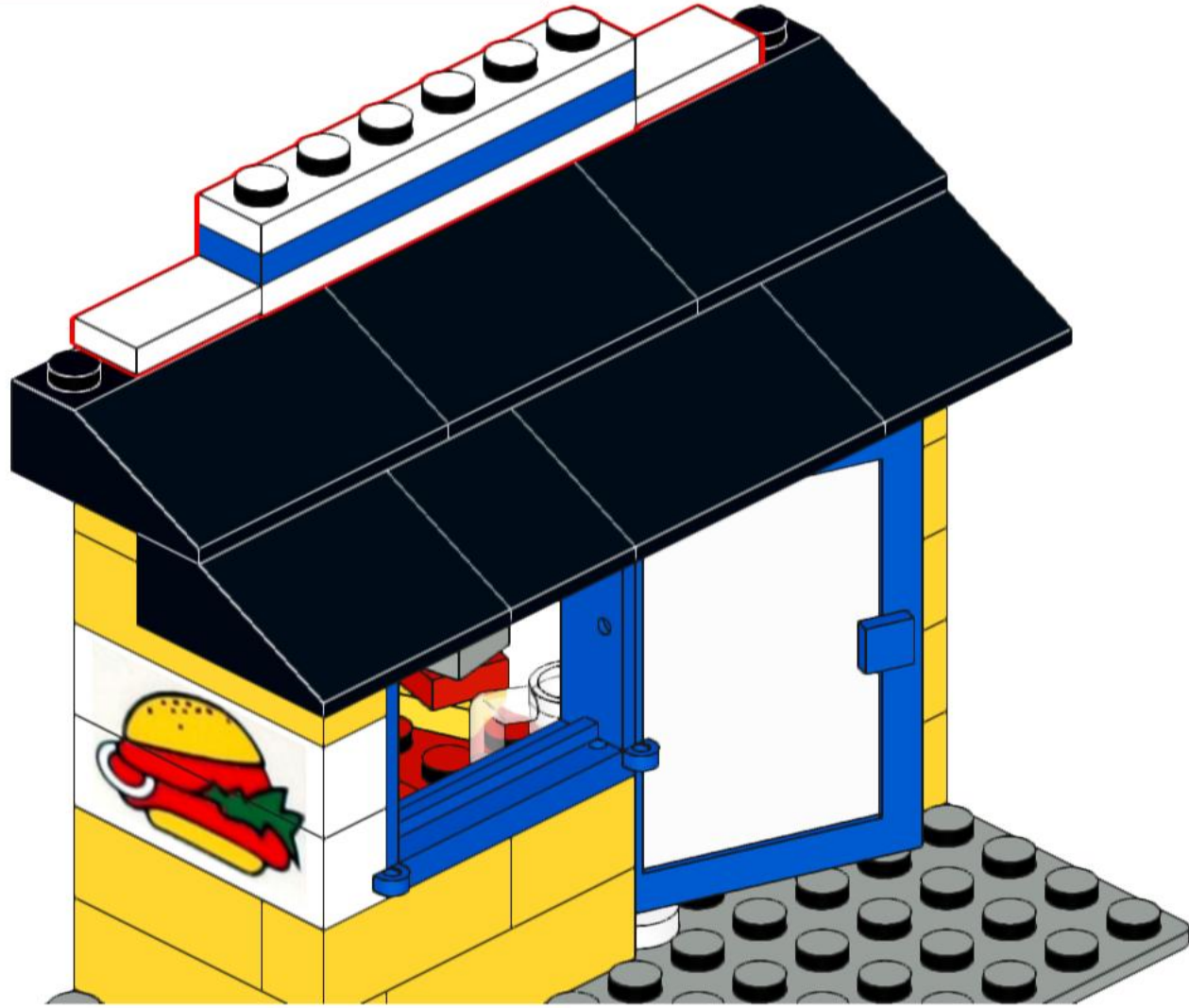
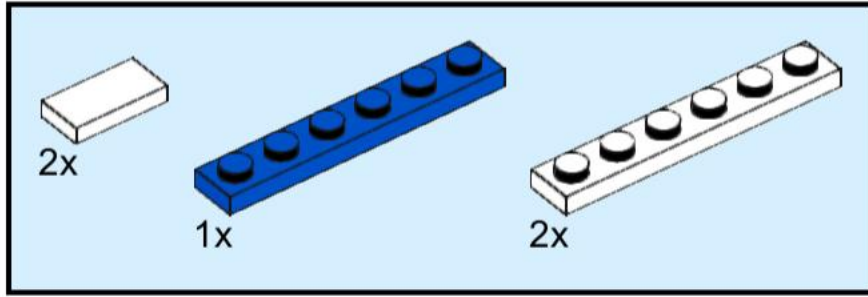

8

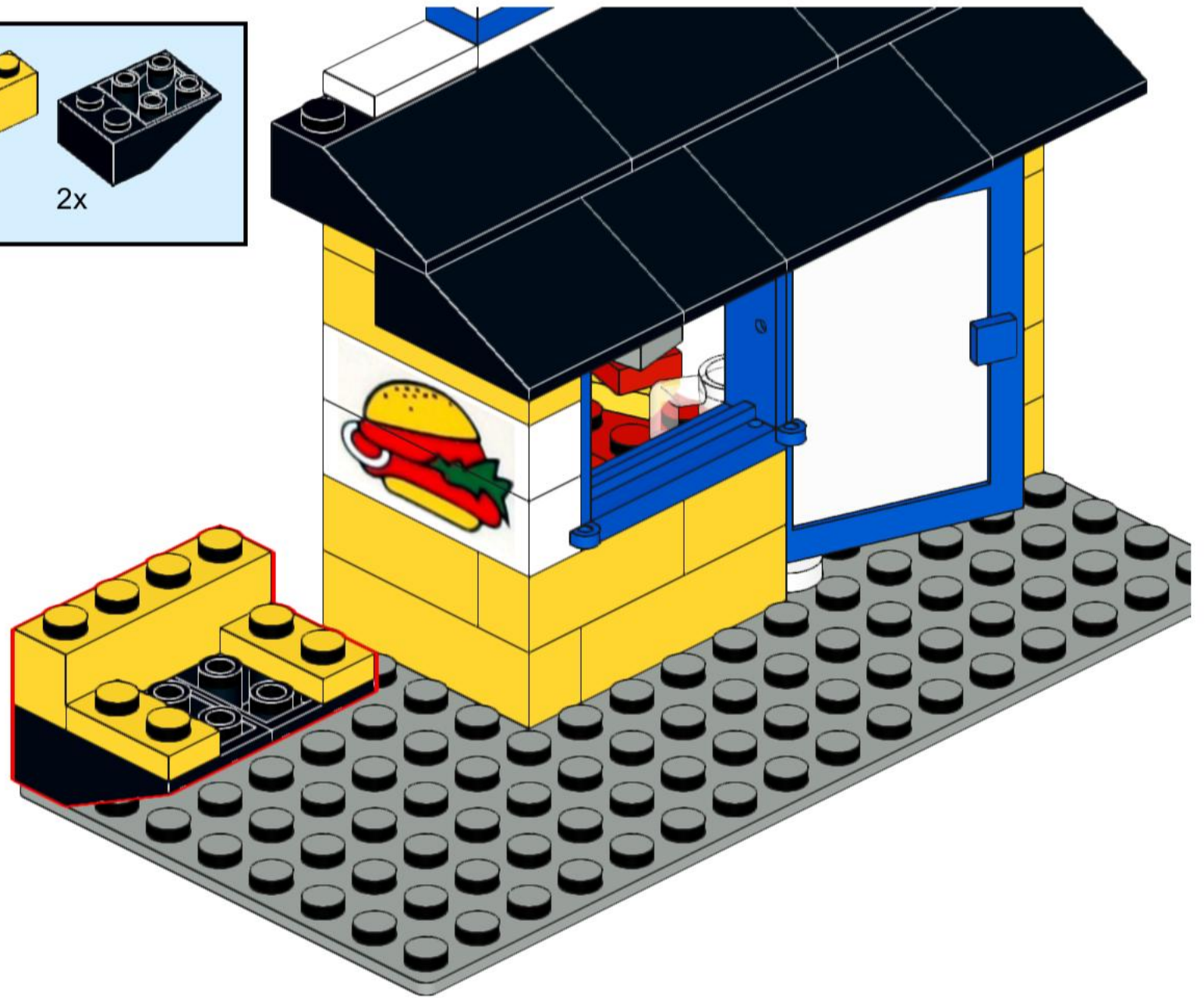
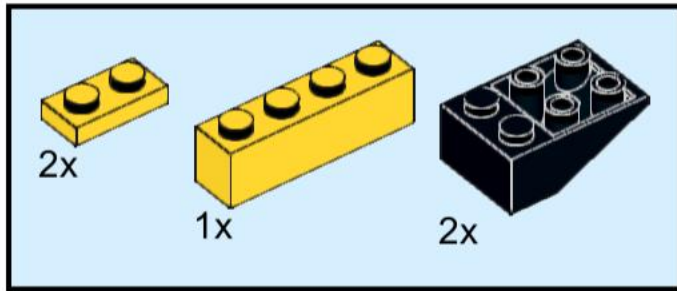

9

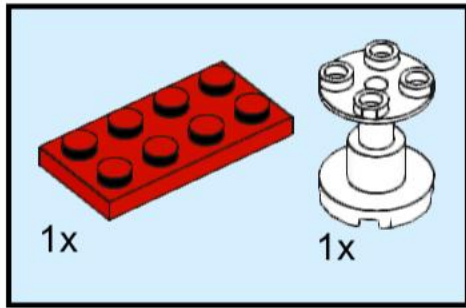

10

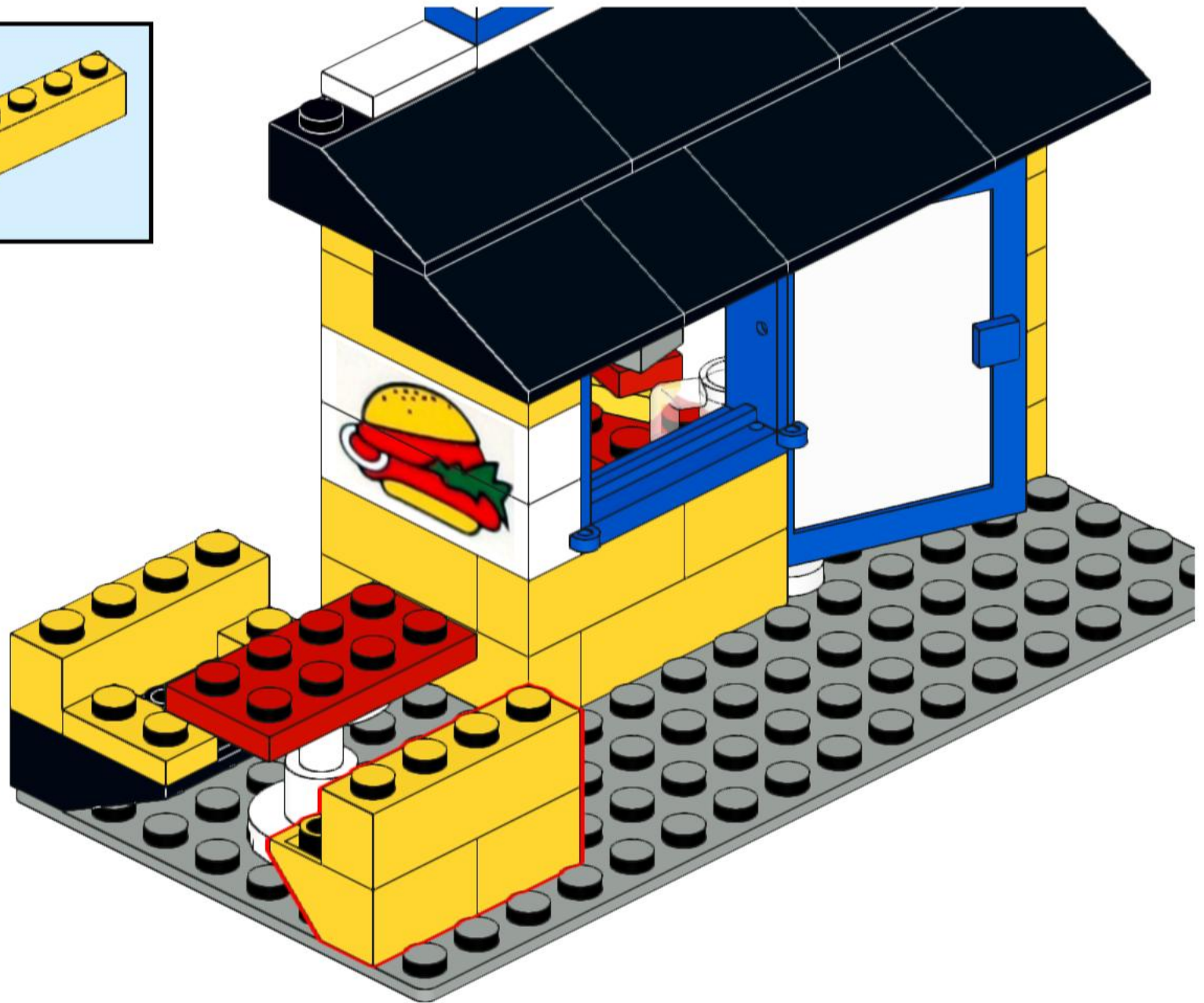
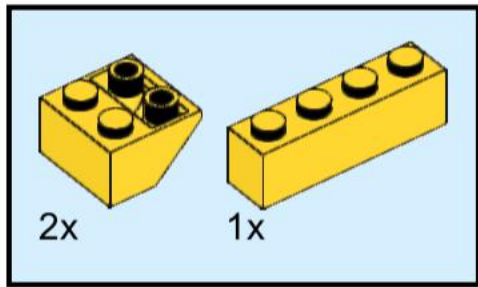

11

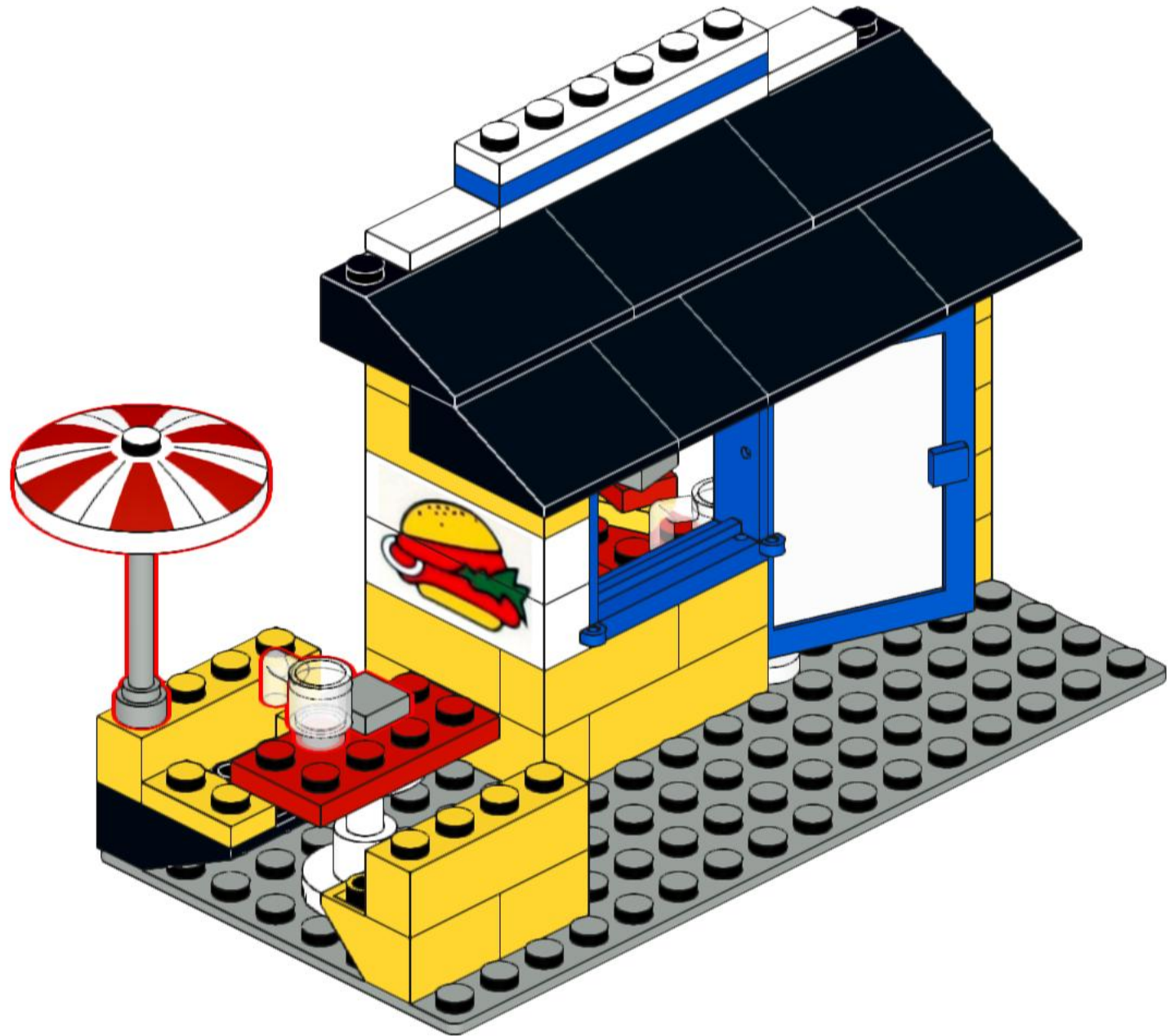
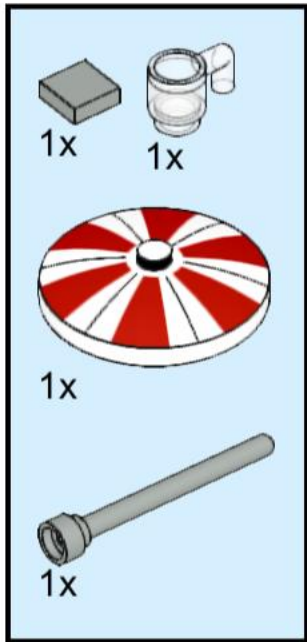

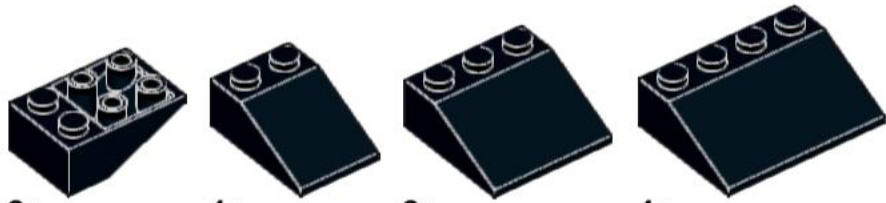

2x
3747a
Black

1x
3298
Black

2x
4161
Black

4x
3297
Black

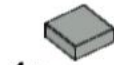

1x
3070
Light Gray



1x
3024
Light Gray

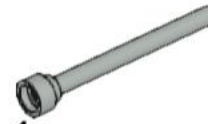

1x
3957
Light Gray

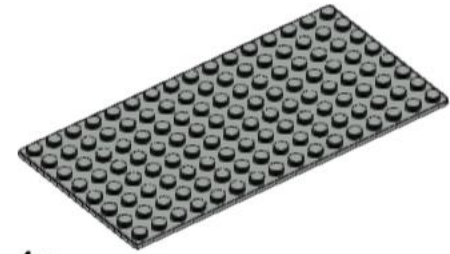

1x
3865
Light Gray

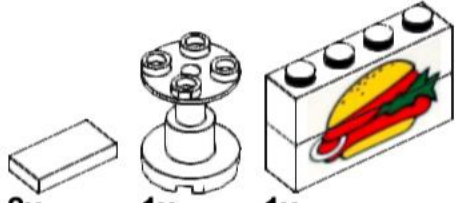

2x
3069
White

1x
3940a
White

1x



1x
3960pb002
White

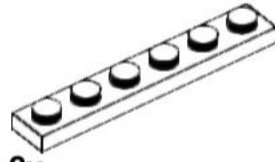

2x
3666
White

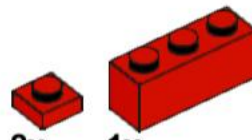

2x
3024
Red

1x
3622
Red

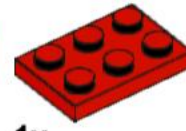

1x
3021
Red

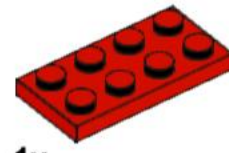

1x
3020
Red



1x
3024
Yellow

2x
3023
Yellow



3x
3004
Yellow



2x
3660
Yellow

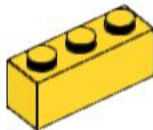

2x
3622
Yellow

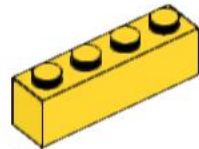

10x
3010
Yellow

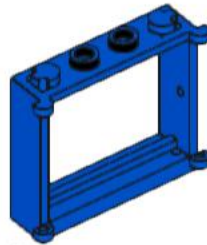

1x
3853
Blue

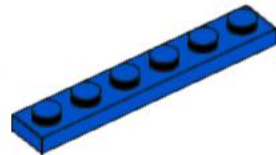

1x
3666
Blue

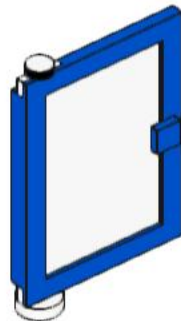

1x
73436c01
Blue



2x
3899
Trans-Clear