

2x
983
Black

1x
4150
Black

4x
4590
Black

2x
30034
Black



1x
x182px1
Light Gray

3x
3023
Black

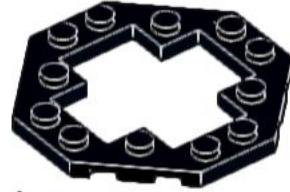

1x
4151
Black

1x
6222
Light Gray

3x
3794a
Black

1x
970c07pb01
Black

1x
4345
Black

1x
30062
Black

3x
3938
Light Gray

2x
2419
Light Gray

4x
3937
Black

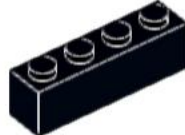

1x
973pb0077
Light Gray

3x
3034
Light Gray

2x
2540
Black

4x
3021
Black

3x
3010
Black

3x
3035
Black

2x
3622
Light Gray

1x
4349
Black

4x
3940b
Black

1x
30035
Black

1x
x141
Black

2x
73590c02a
Black

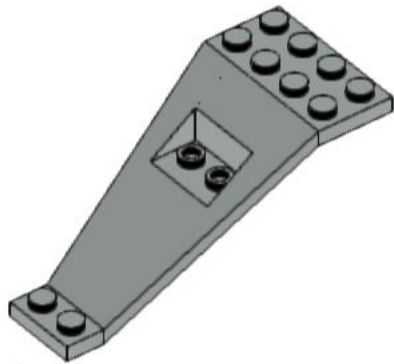

4x
30119
Light Gray

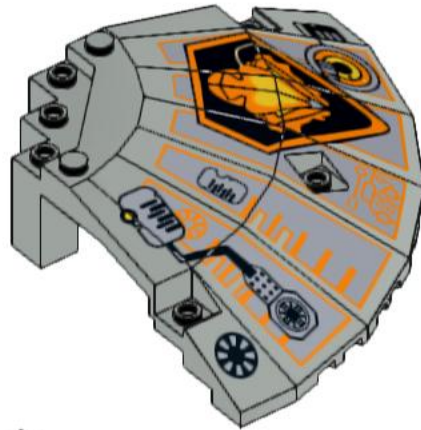

1x
30117pb05
Light Gray

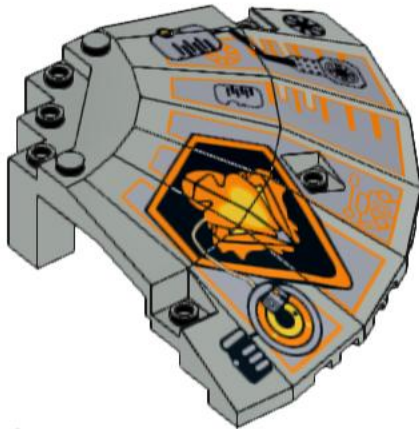

1x
30117pb01
Light Gray



4x
4070
Red



2x
3023
Red

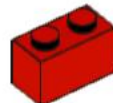

4x
3004
Red



1x
3022
Red



1x
4079
Red

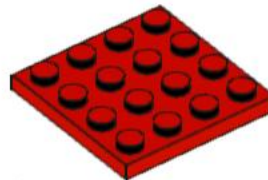

2x
3031
Red

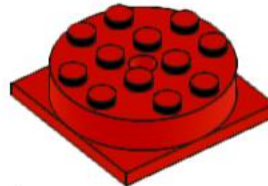

1x
3403c01
Red



1x
981
Blue



1x
982
Blue



4x
4073
Trans-Neon Green



1x
4589
Trans-Neon Green



1x
3626pb0248
Trans-Neon Green



1x
4346
Trans-Neon Green

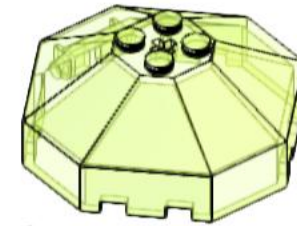

1x
2418b
Trans-Neon Green

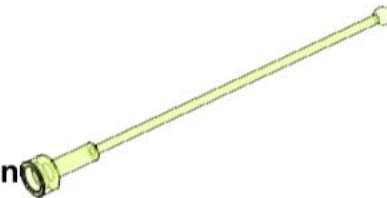

4x
2569
Trans-Neon Green

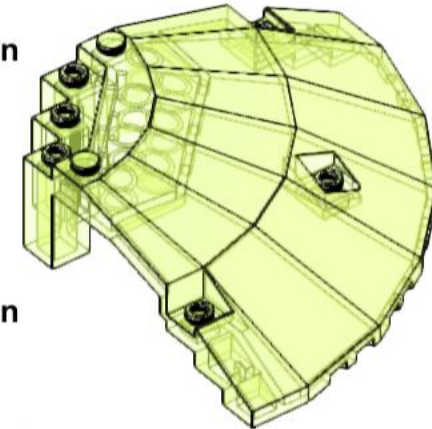

2x
30117
Trans-Neon Green

1

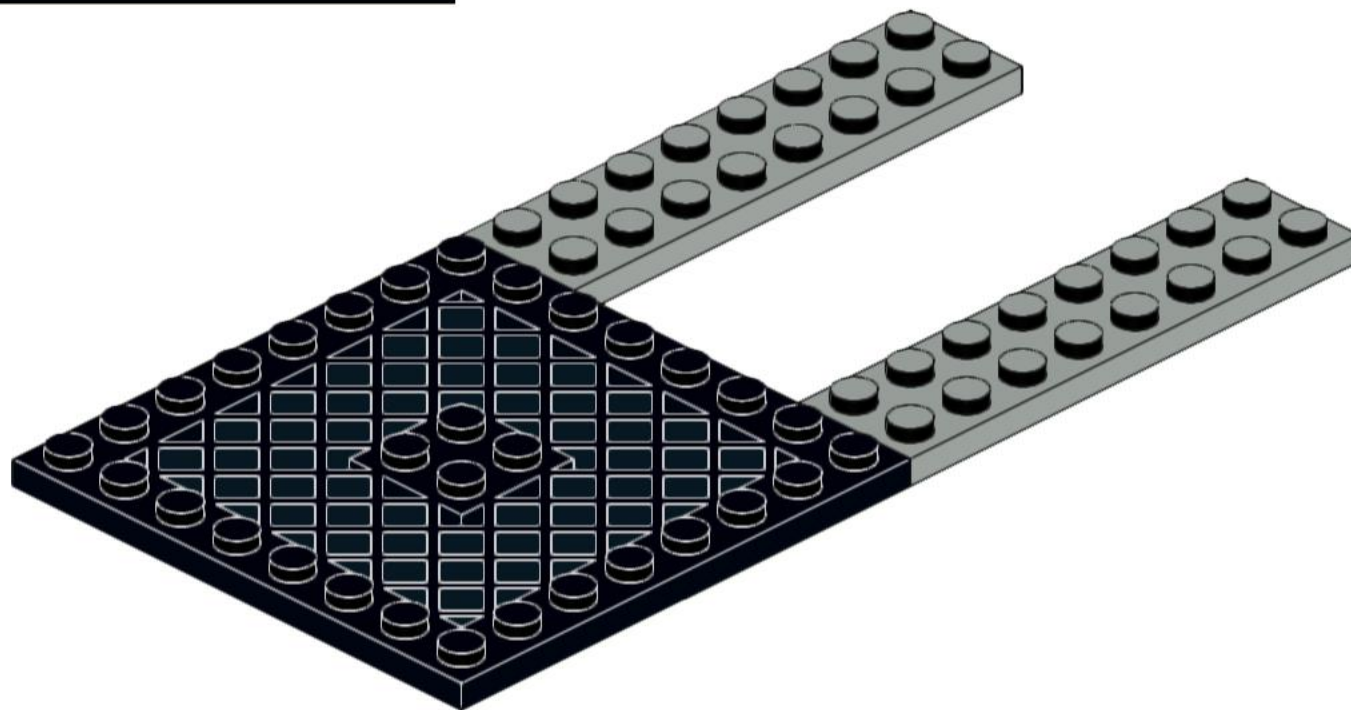
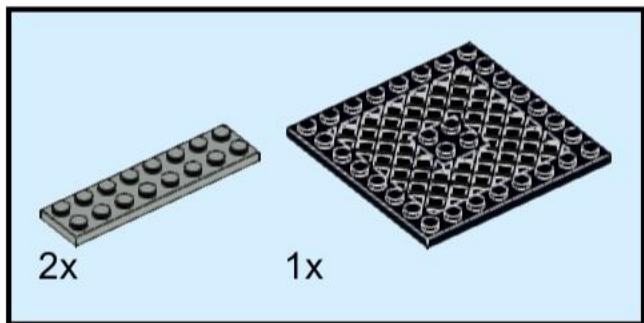

2

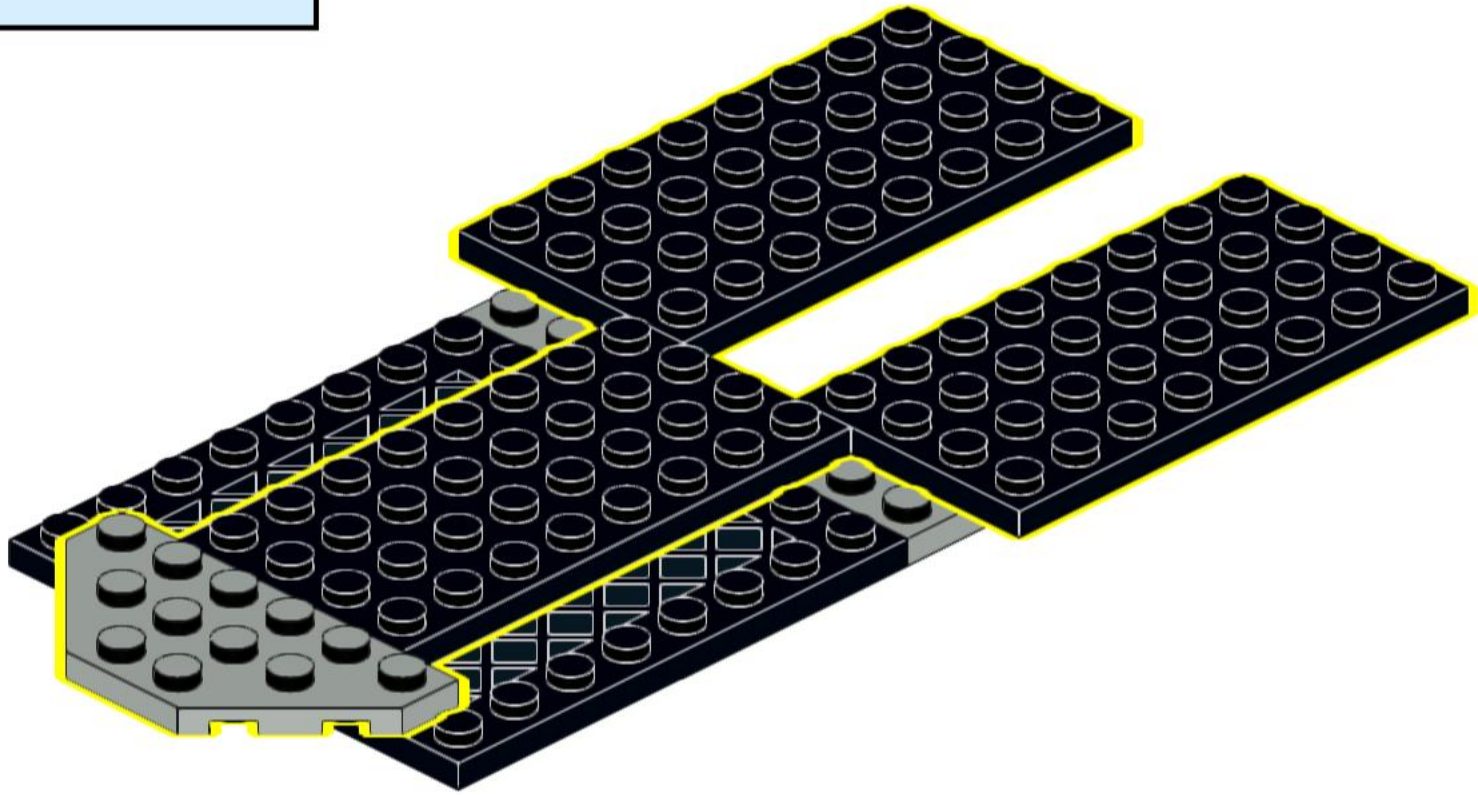
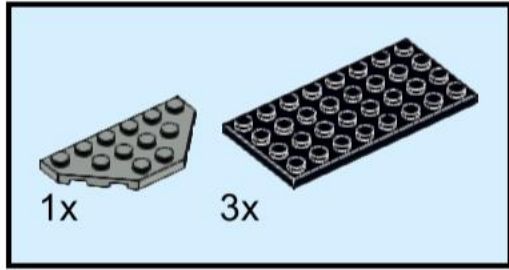

3

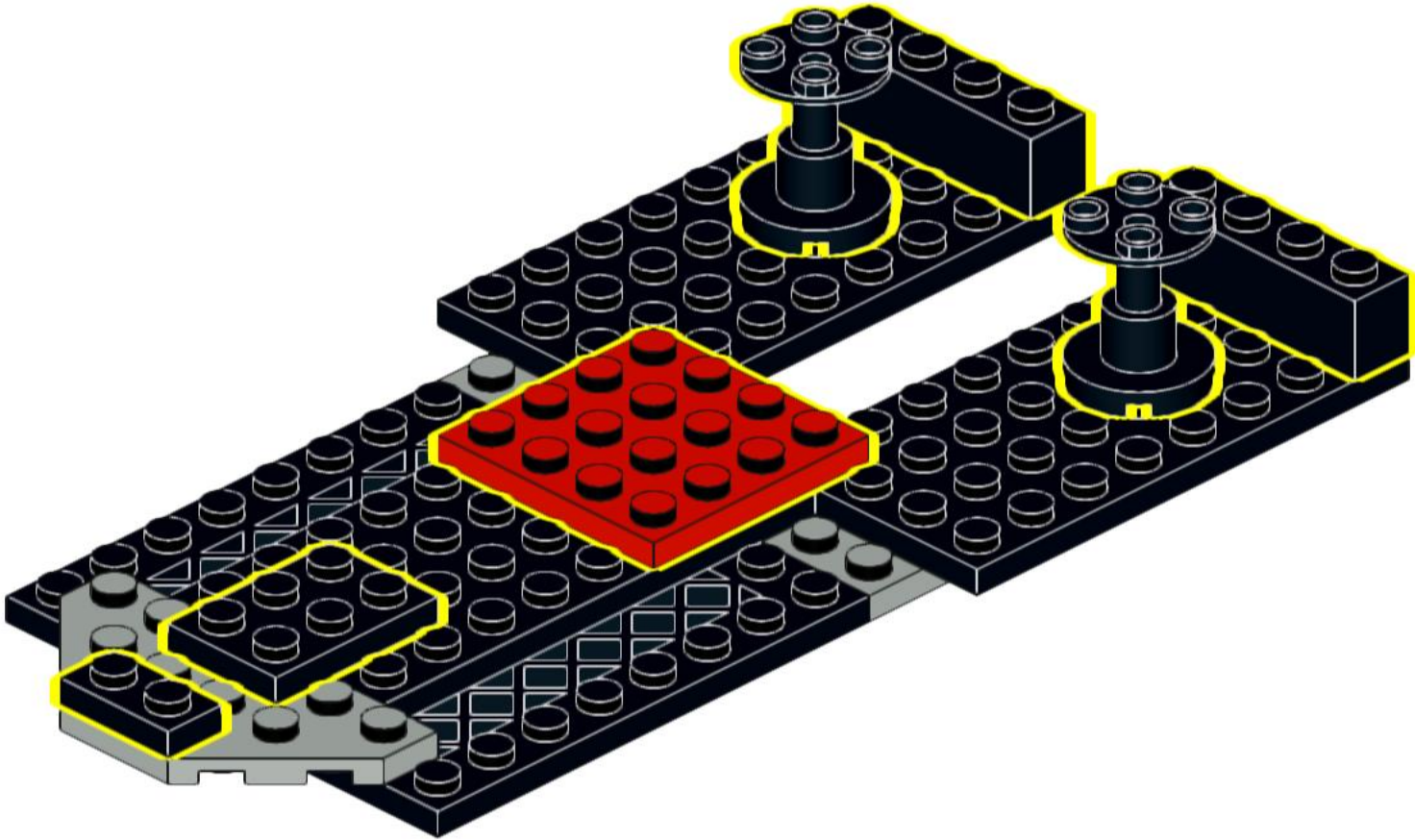
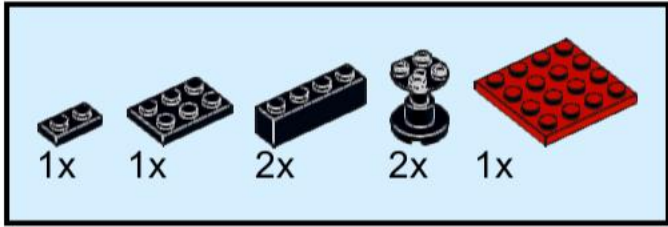

4

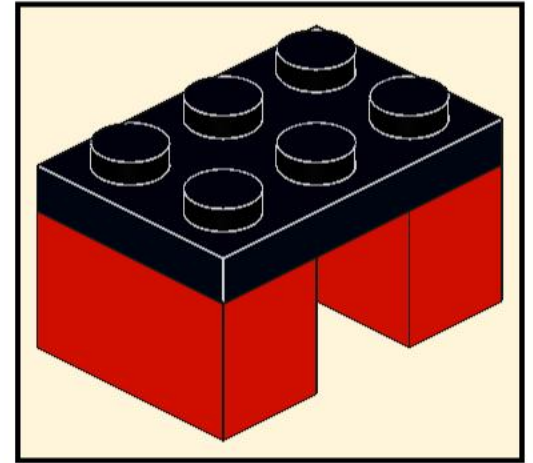
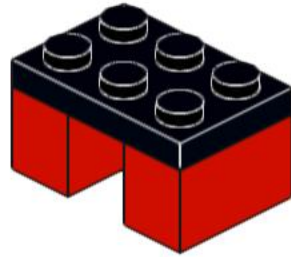
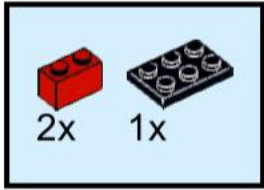

2x

5

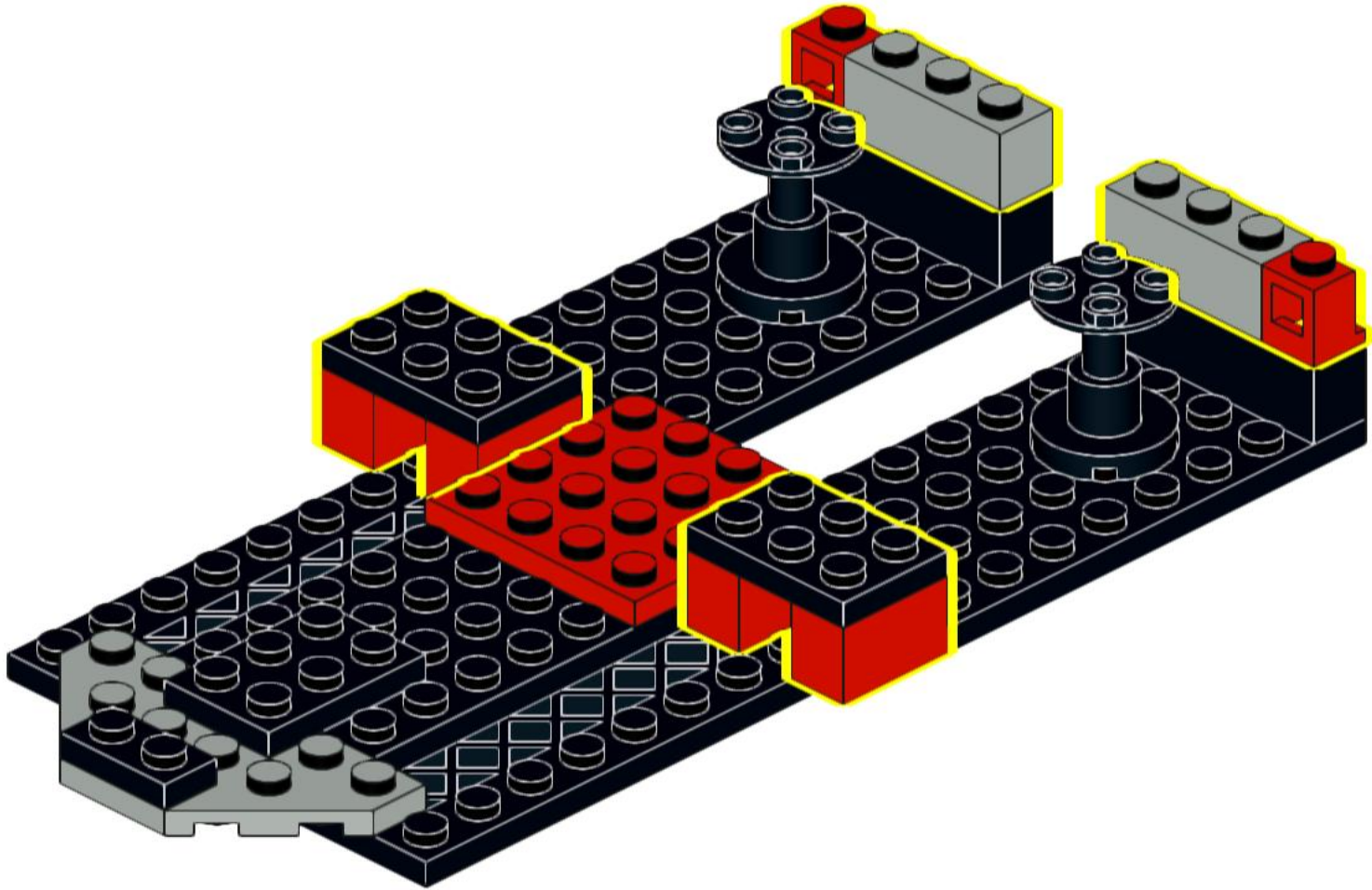
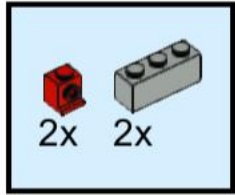

6

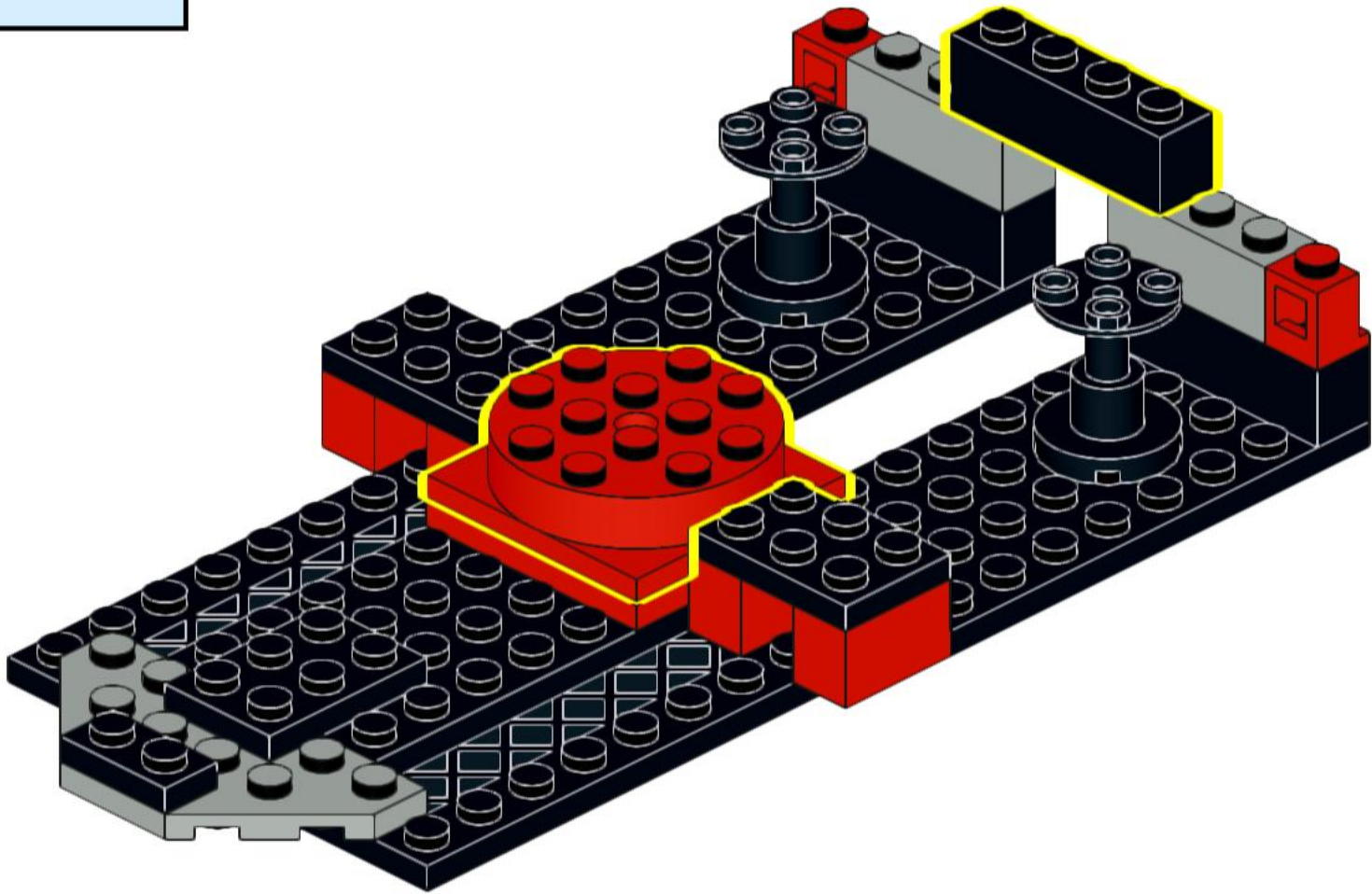
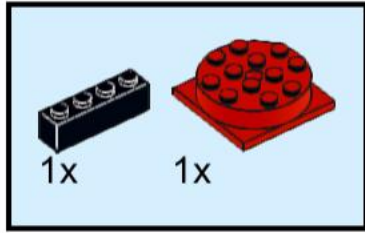

7

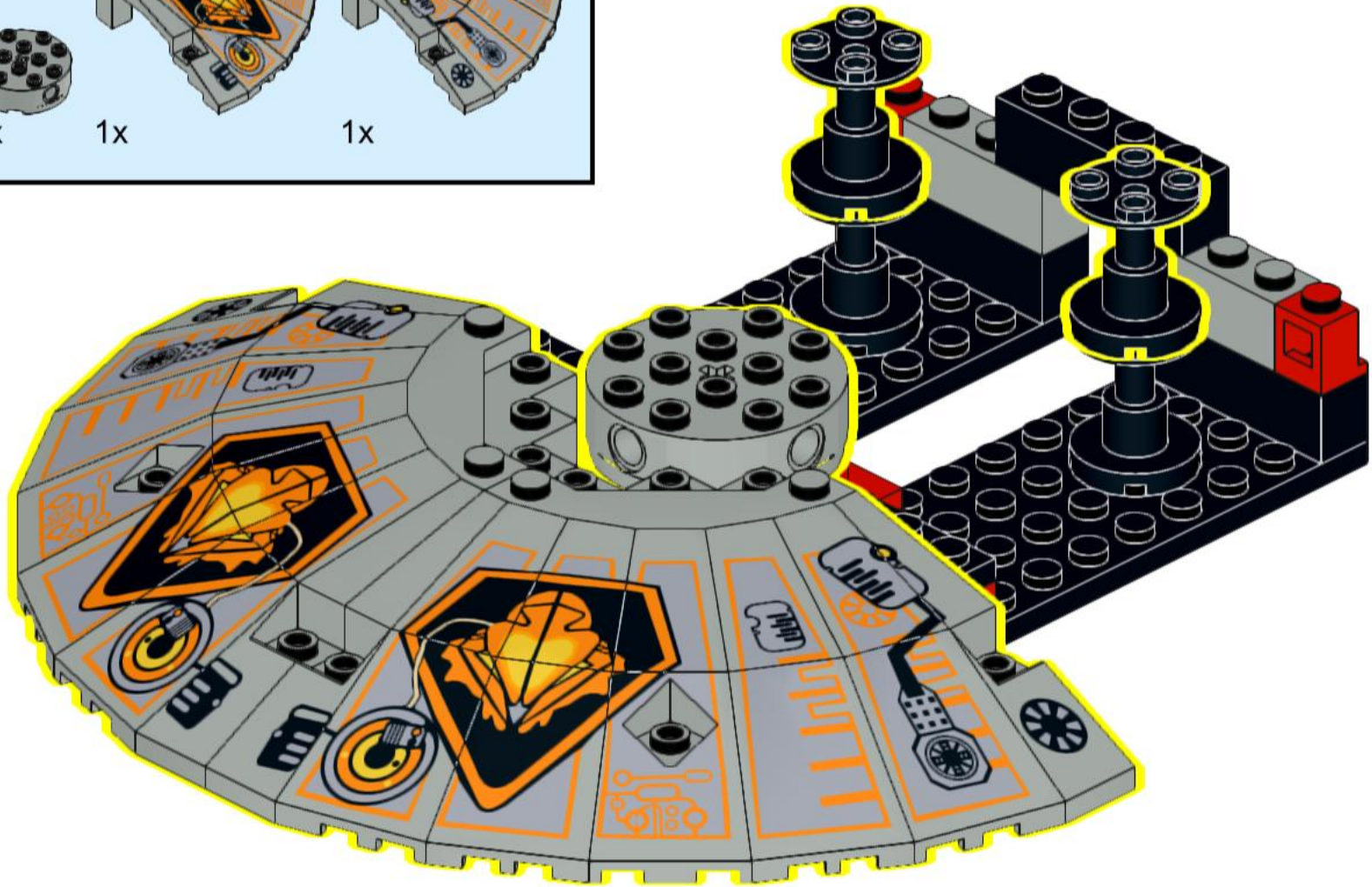
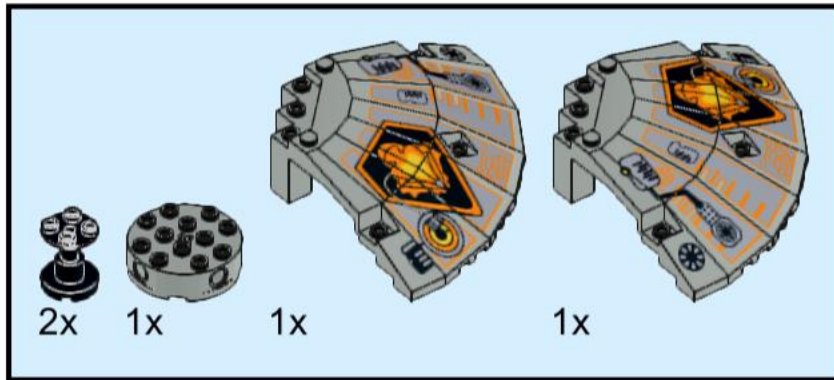

8

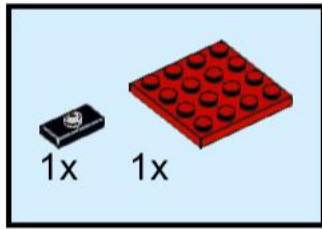

9

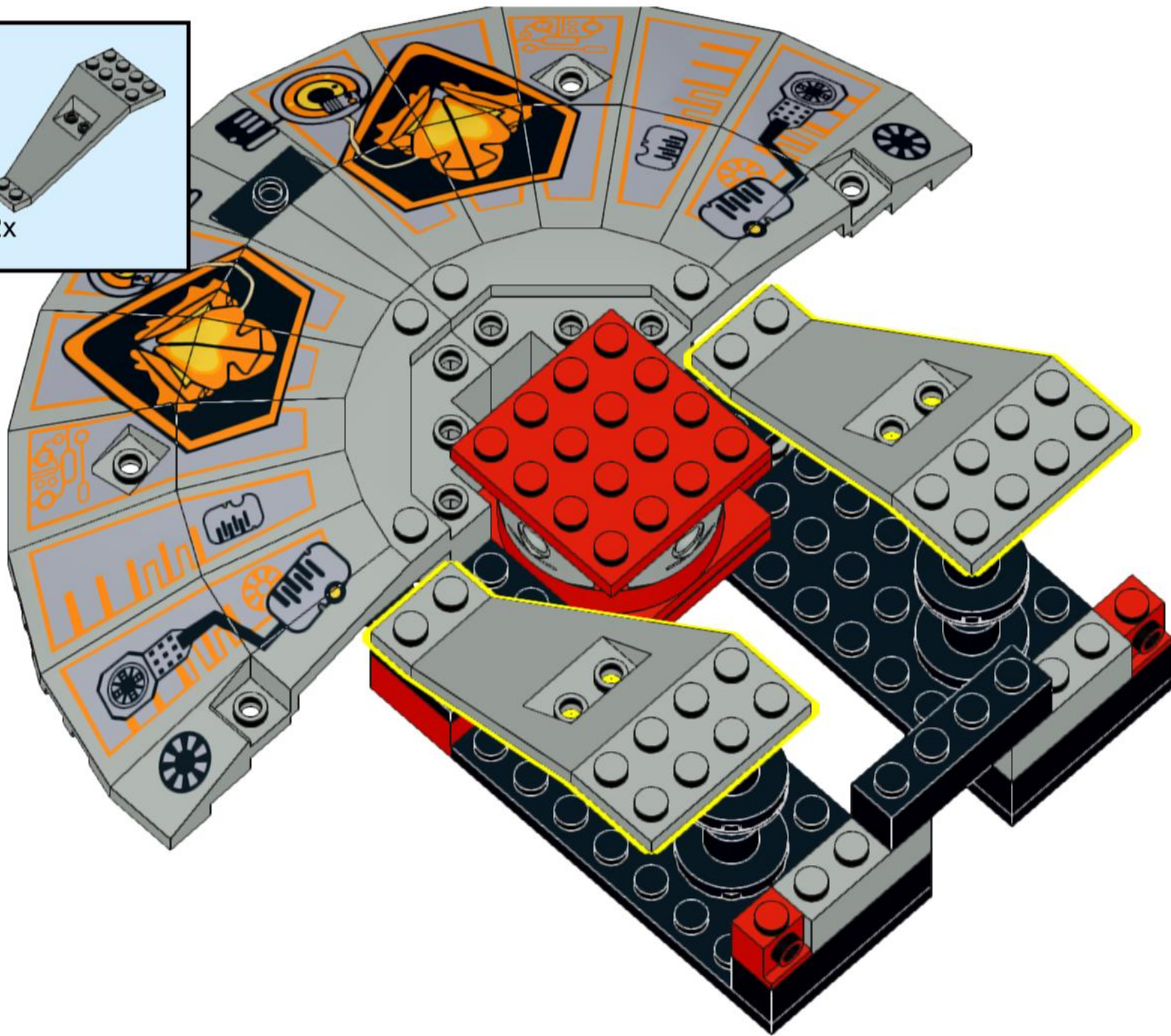
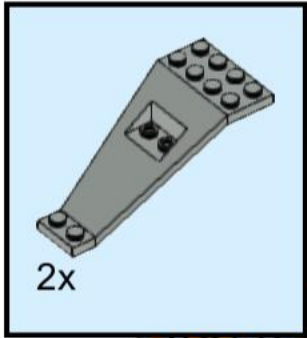

10

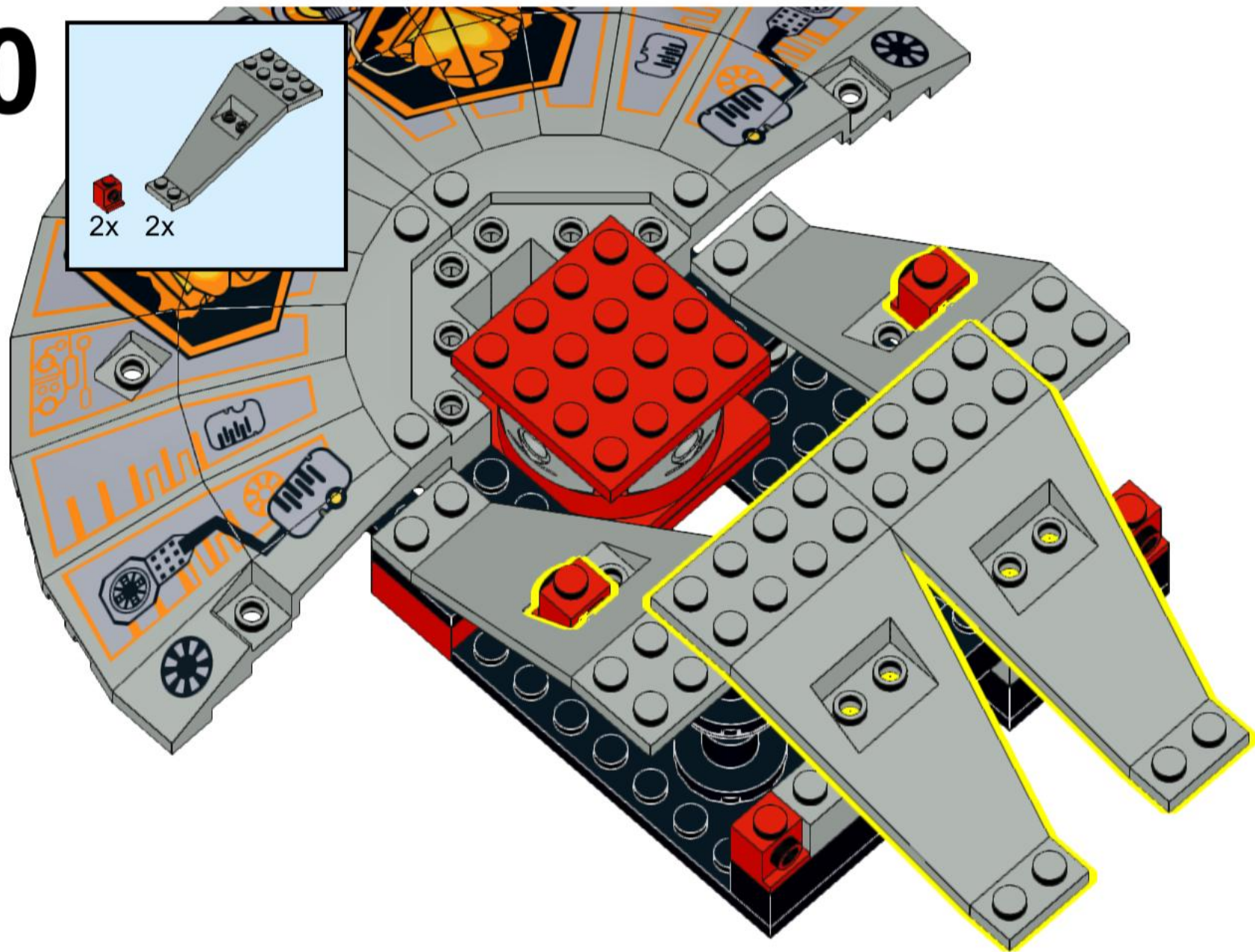

11

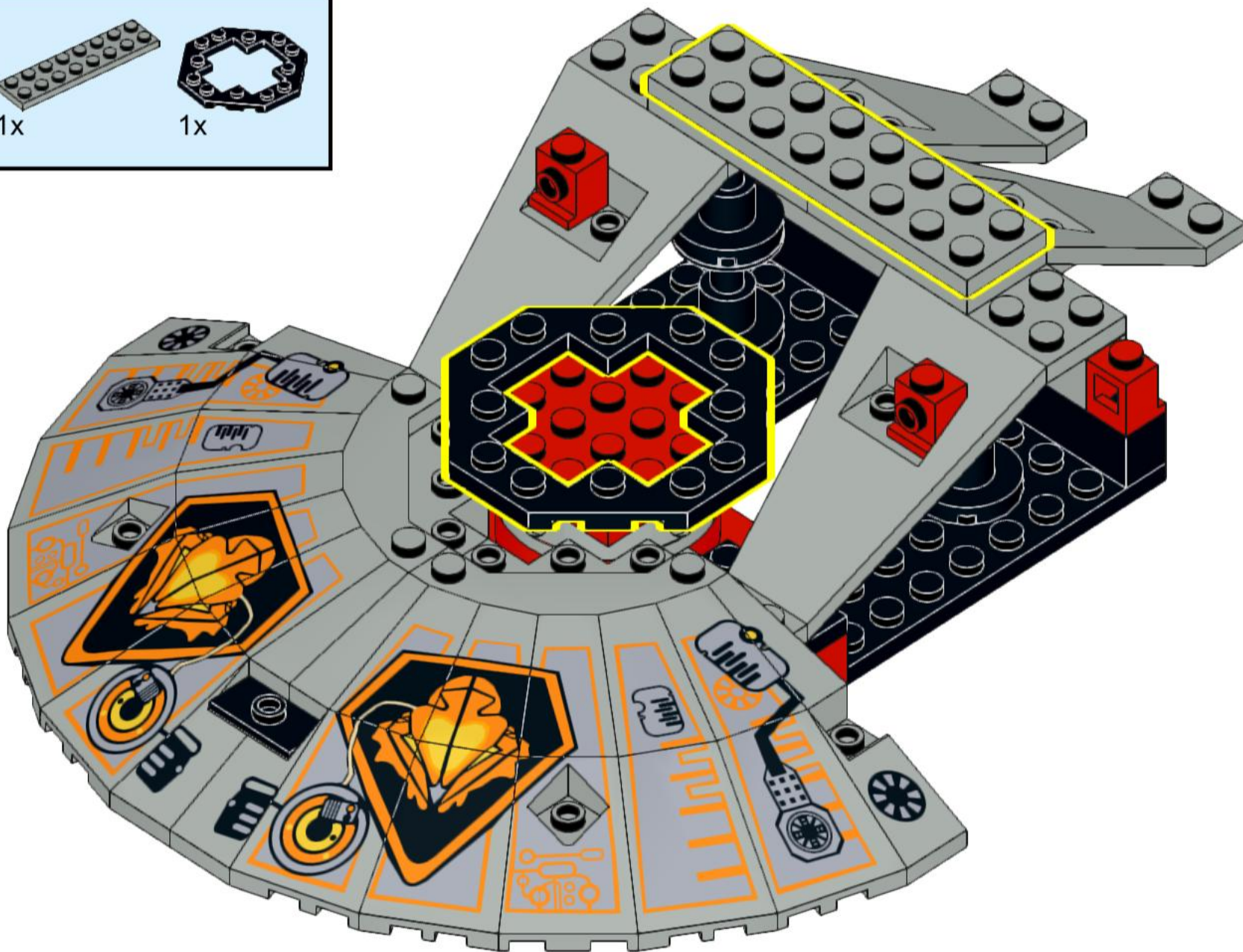
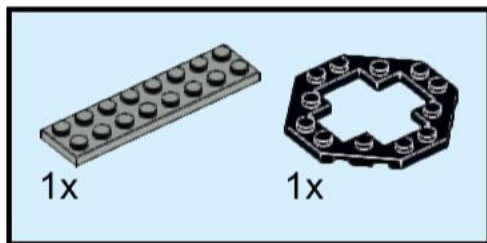

12

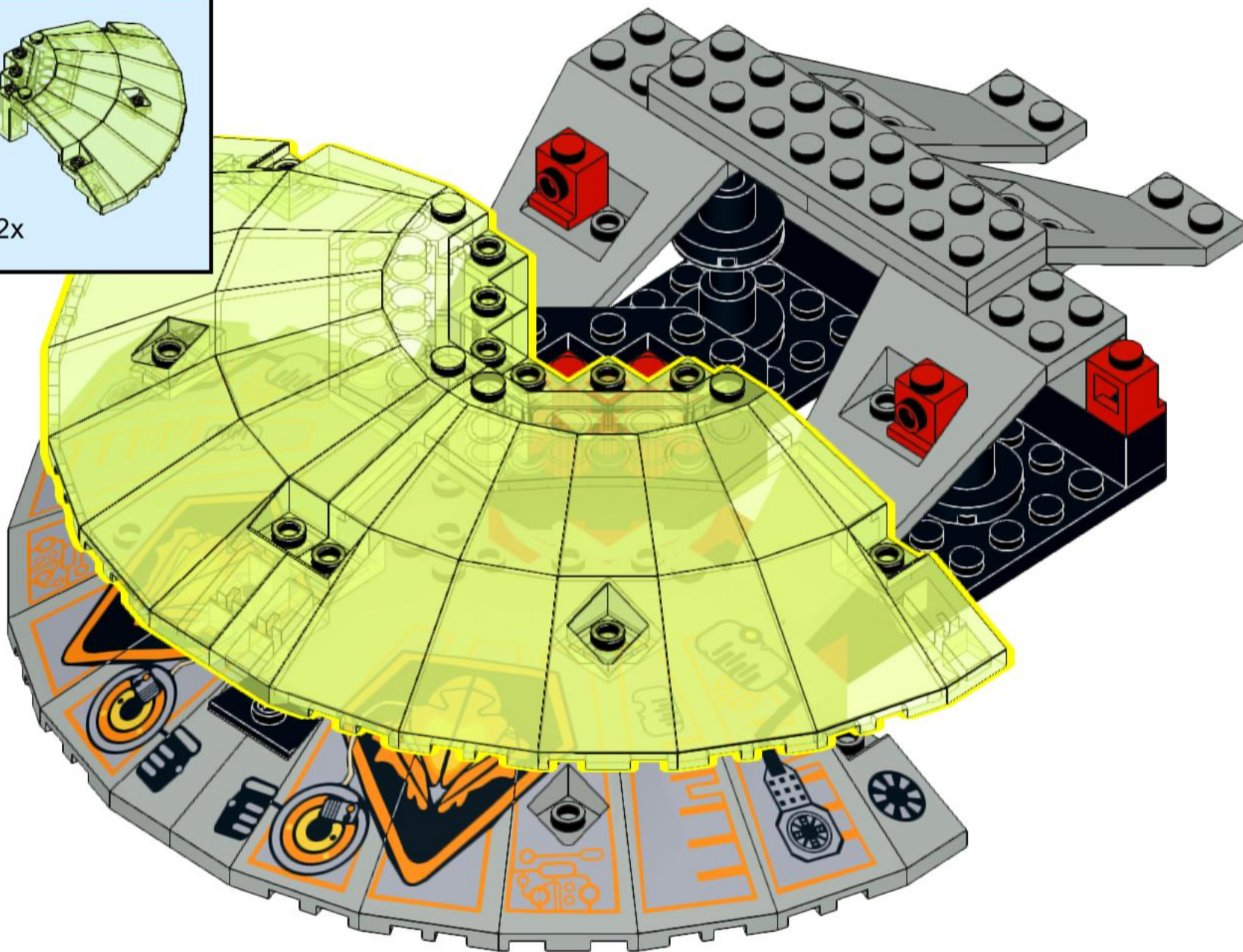
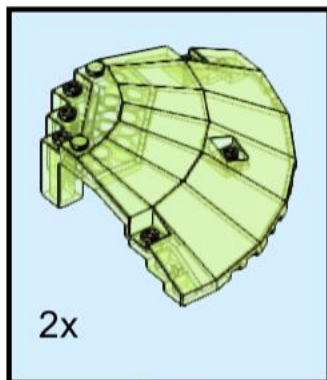

13

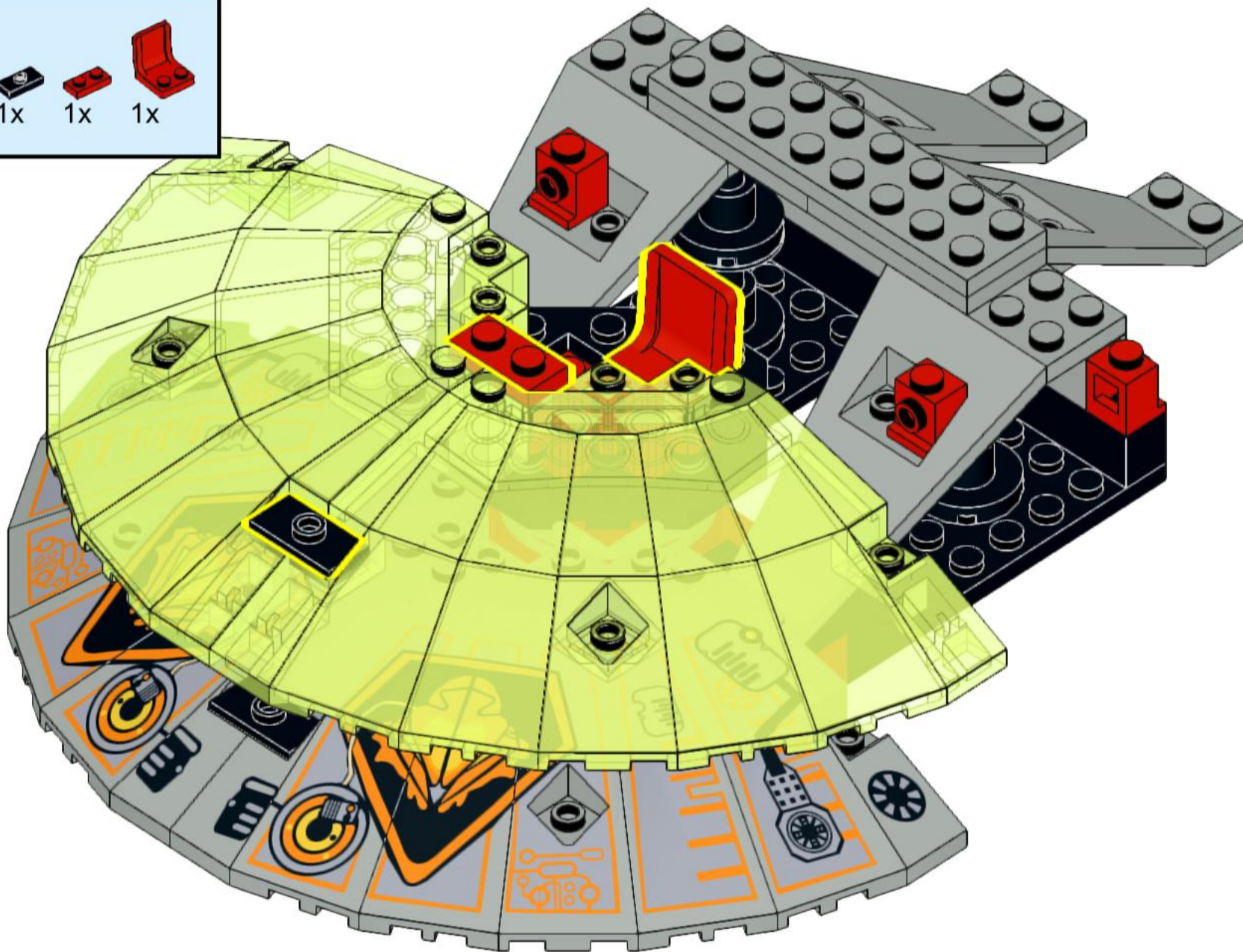
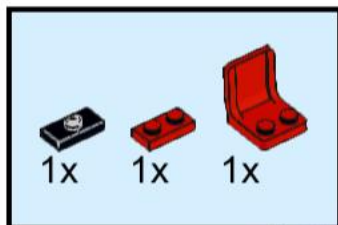

14

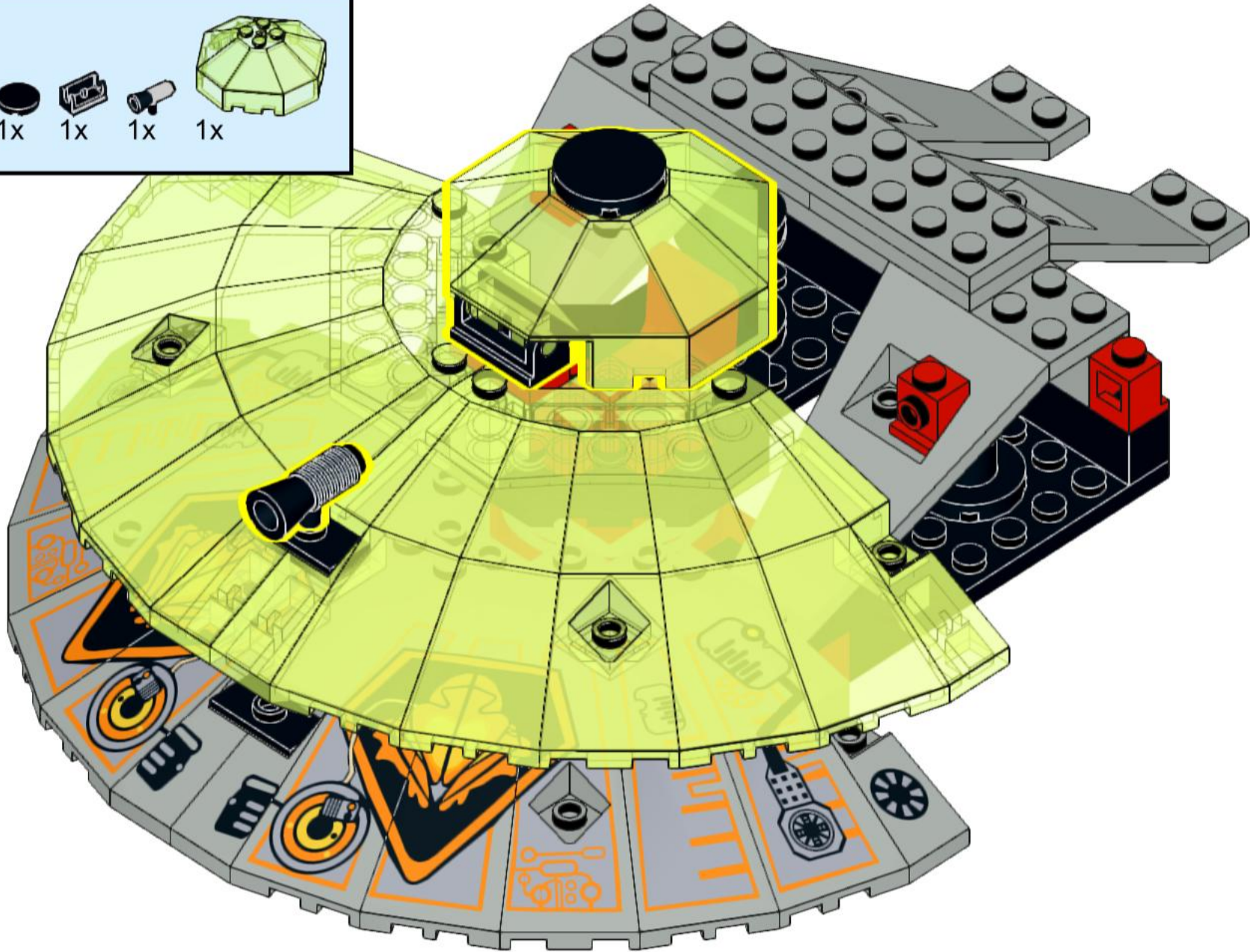
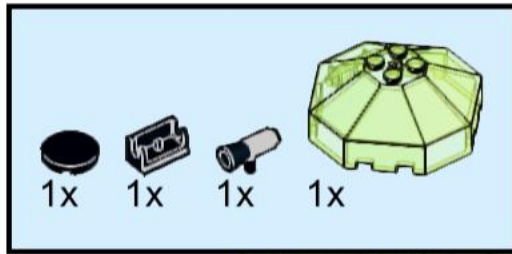

15

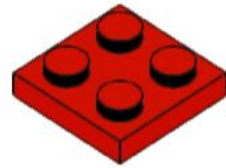
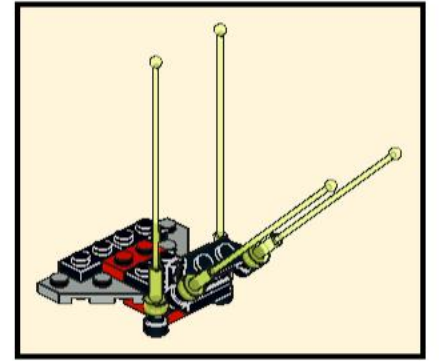
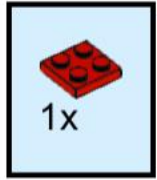

16

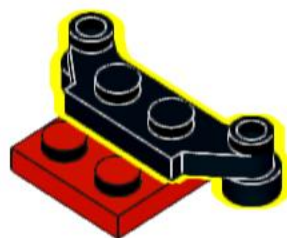

17

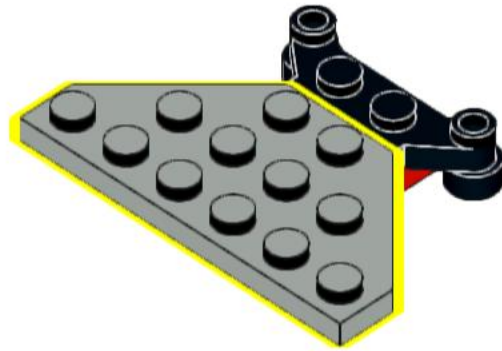
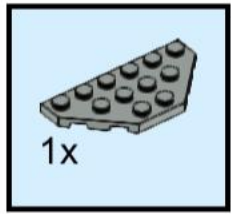

18

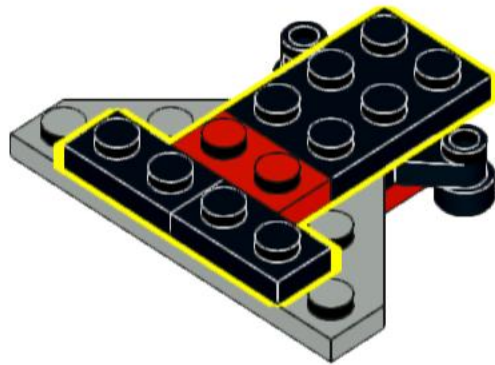
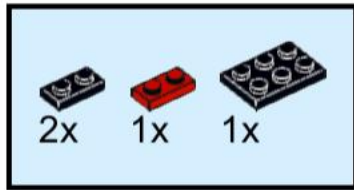

19

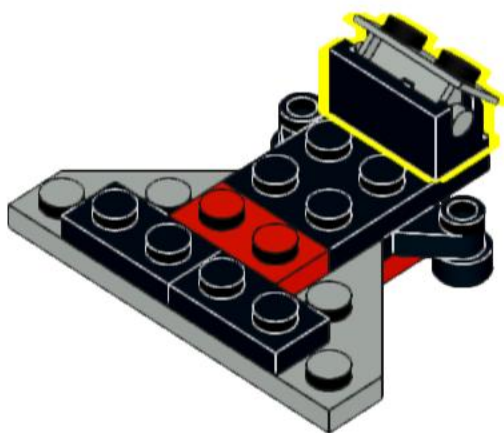
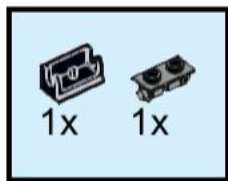

20

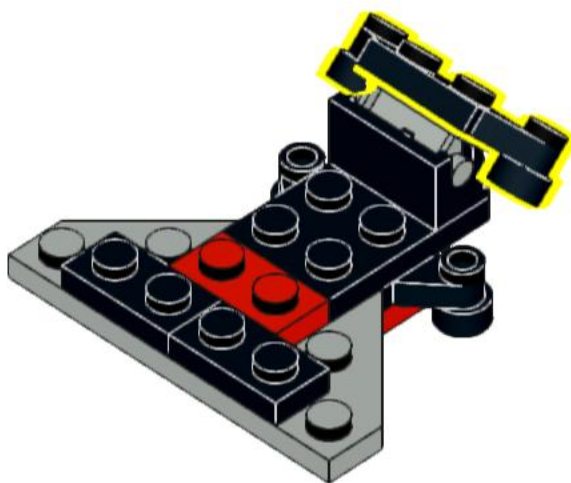

21

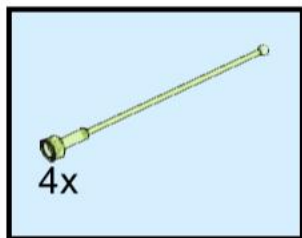

22

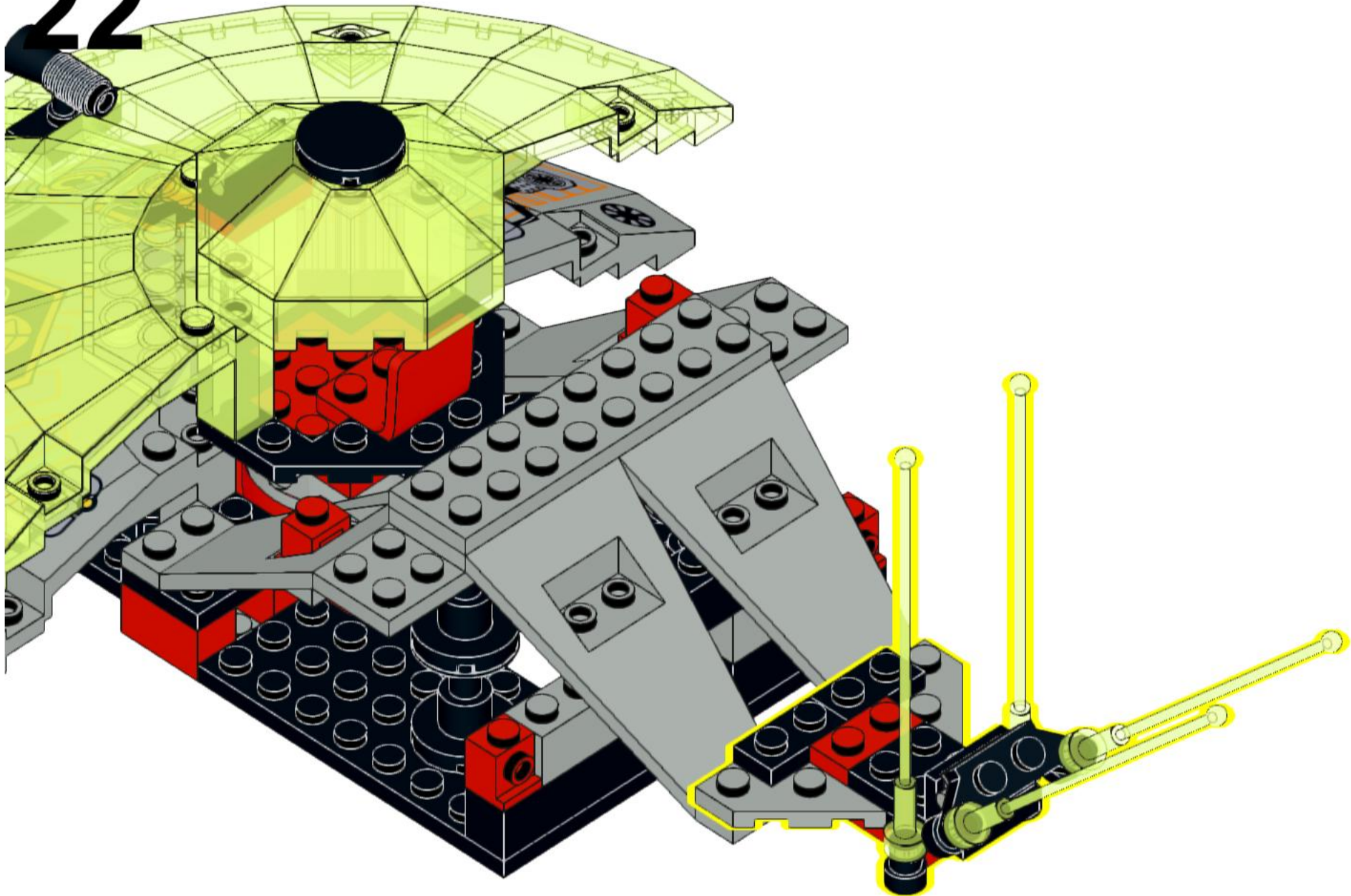

23

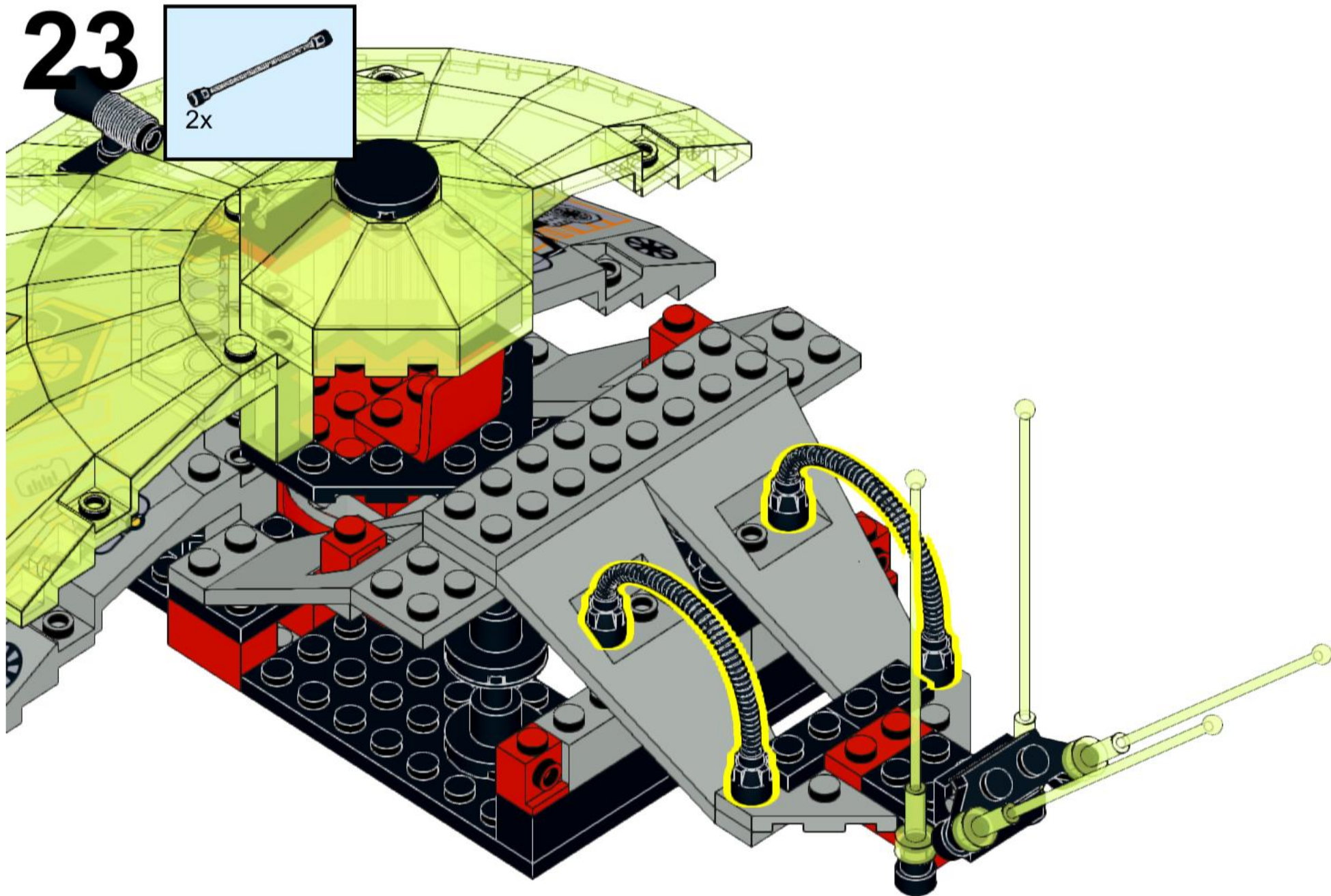

24

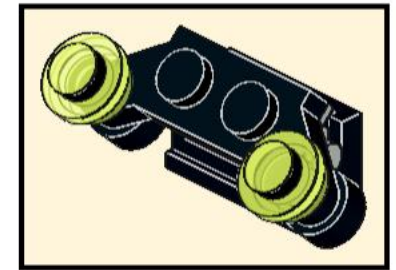
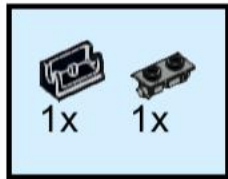

2x

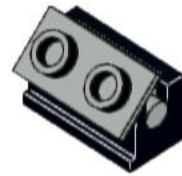

25



27

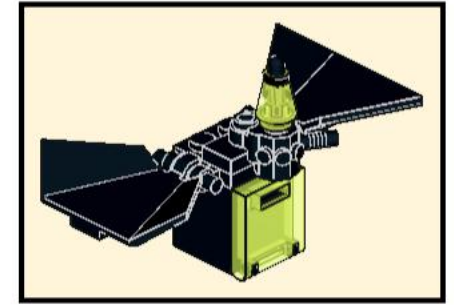
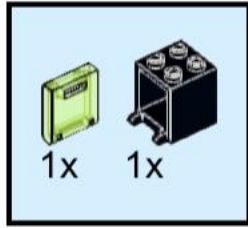

28

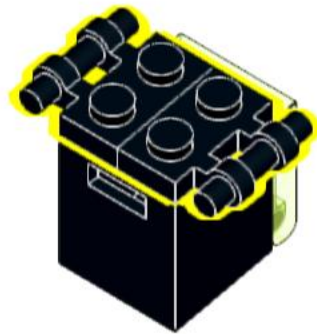

29

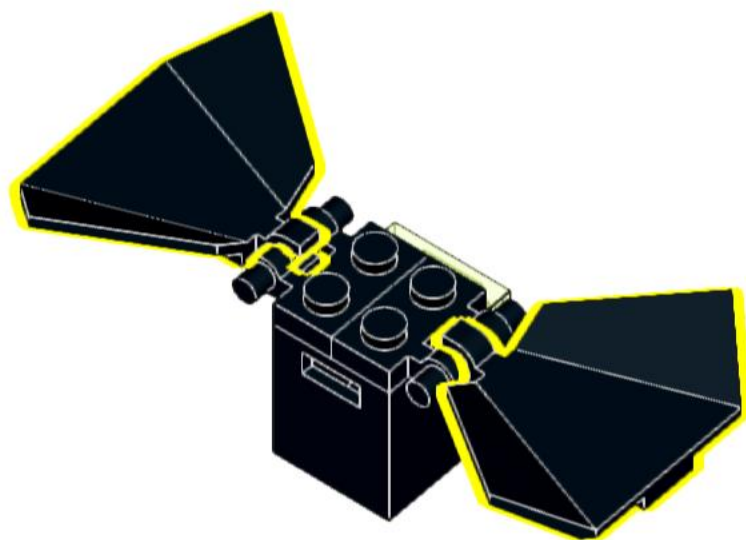
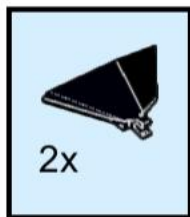

30

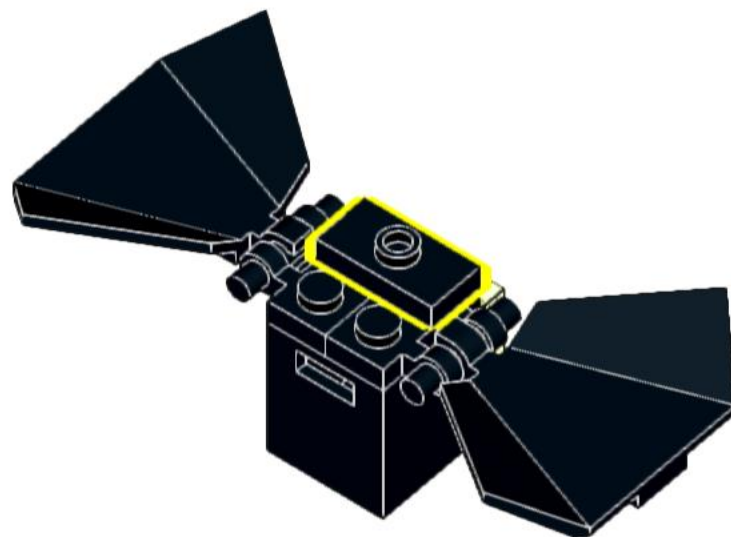



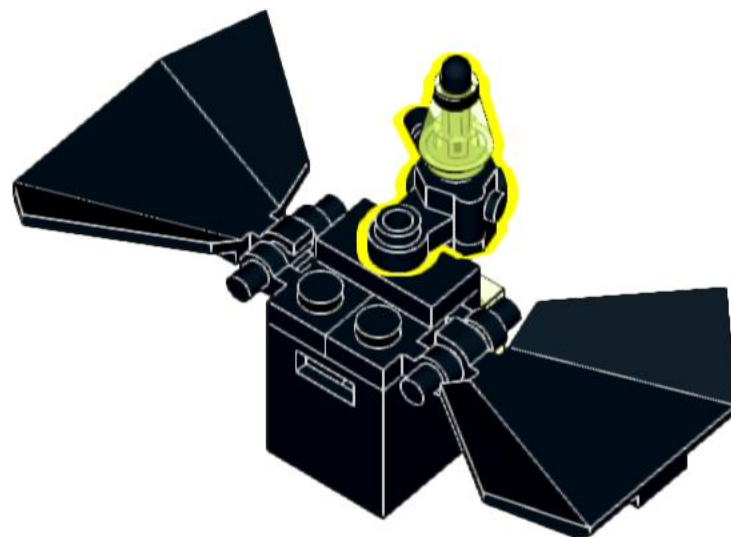
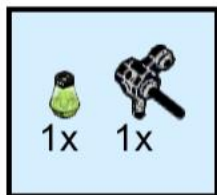



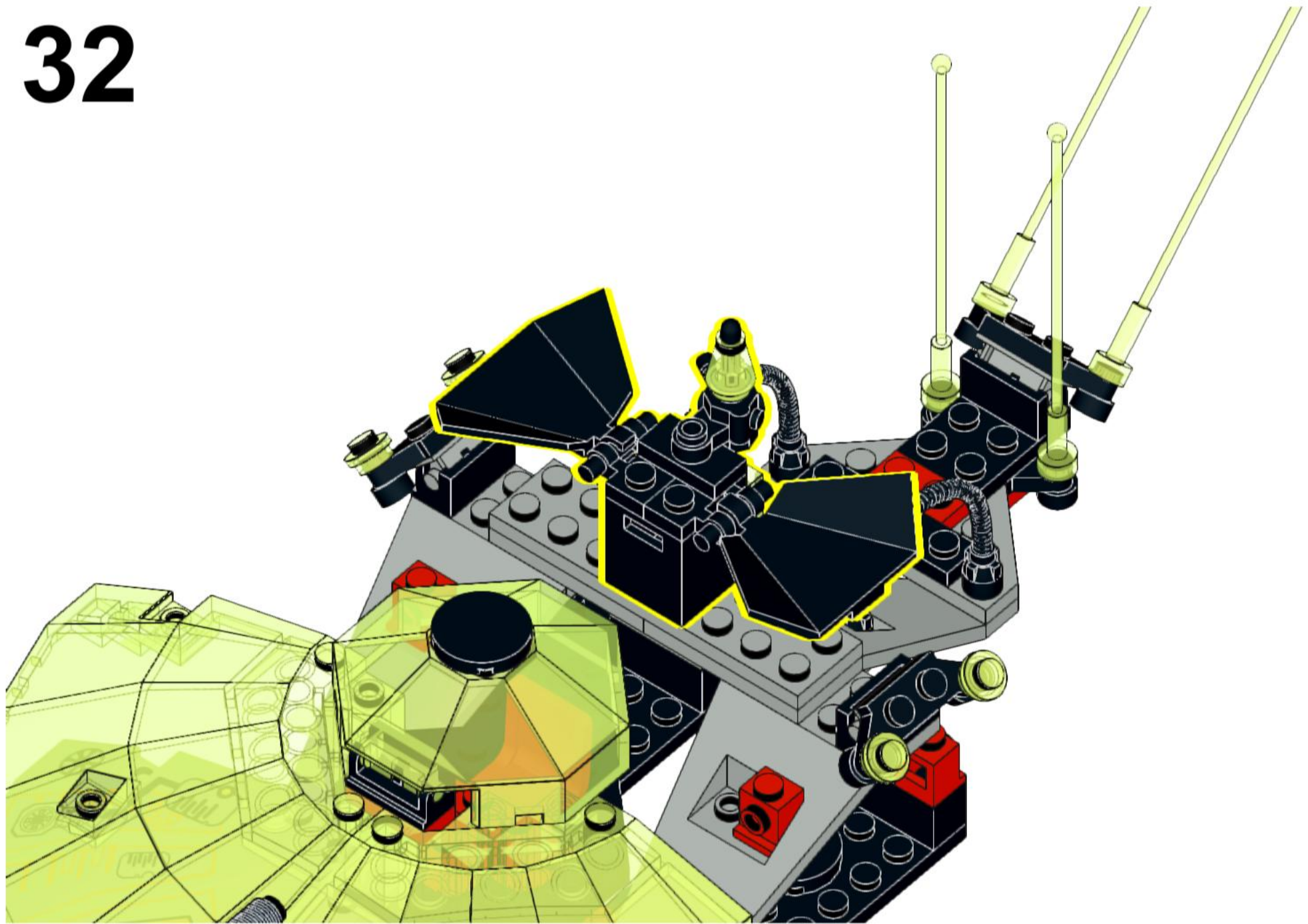

31



32



33

							
2x	1x	1x	1x	1x	1x	1x	1x

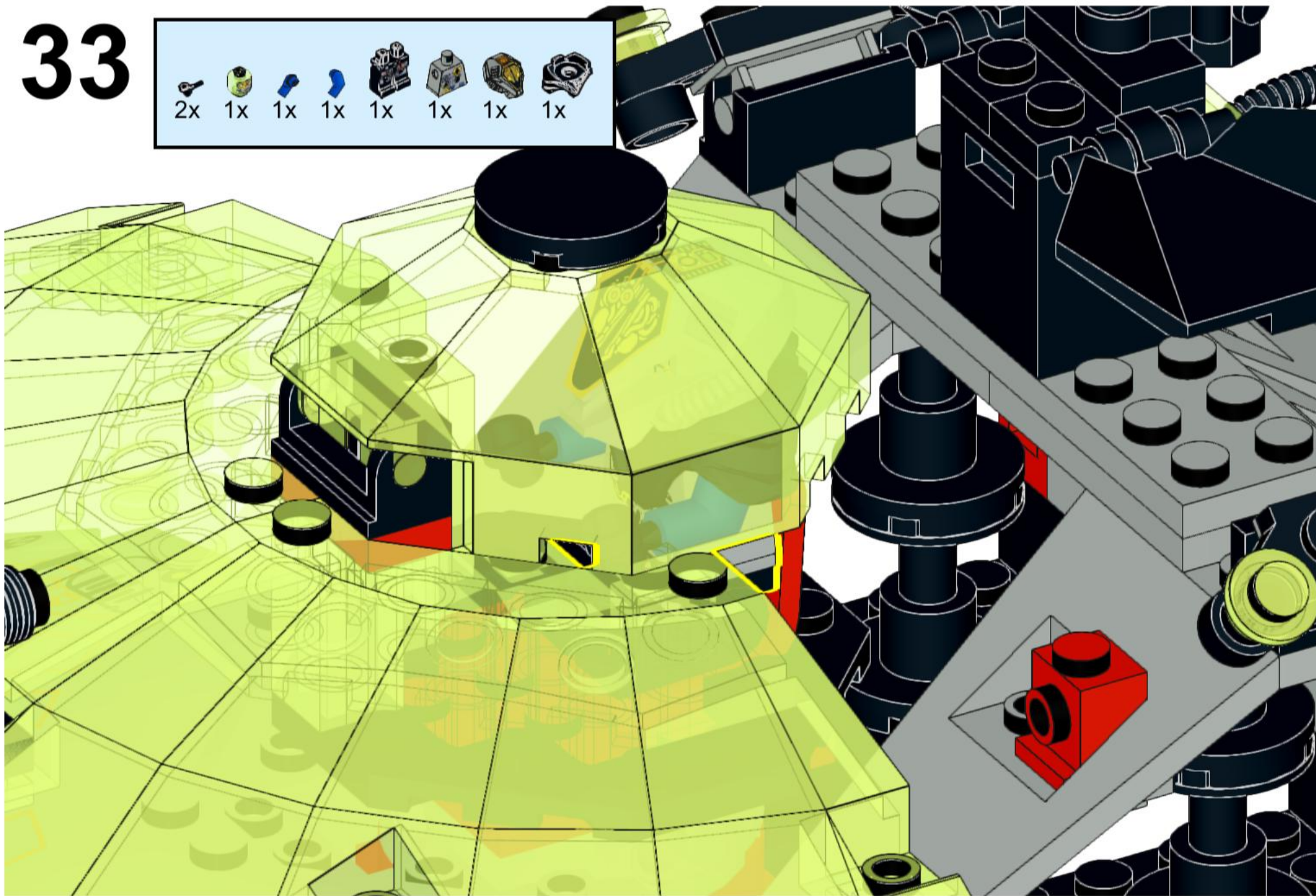

34

